



**FCC CFR47 PART 15 SUBPART E
INDUSTRY CANADA RSS-210 ISSUE 7**

CERTIFICATION TEST REPORT

FOR

**EA544D_3 ETHERNET ADAPTER CARD FOR 2.4 / 5 GHz AP APPLICATIONS_NON
DFS**

MODEL NUMBER: 65-VN663-P3

FCC ID: J9C-EA544D3

IC: 2723A-EA544D3

REPORT NUMBER: 09U12689-3, Revision B

ISSUE DATE: OCTOBER 12, 2009

Prepared for
**QUALCOMM, INC.
3165 KIFER ROAD
SANTA CLARA, CA 95051, U.S.A.**

Prepared by
**COMPLIANCE CERTIFICATION SERVICES
47173 BENICIA STREET
FREMONT, CA 94538, U.S.A.
TEL: (510) 771-1000
FAX: (510) 661-0888**



NVLAP LAB CODE 200065-0

Revision History

Rev.	Issue Date	Revisions	Revised By
--	07/21/09	Initial Issue	F. Ibrahim
A	10/02/09	Revised PK power, AV power, PPSD, BE, Harmonics and Conducted Spurious for HT40 modes in all bands in this report	A. Zaffar
B	10/12/09	Removed all DFS bands data and setup photos from the report.	F. Ibrahim

TABLE OF CONTENTS

1. ATTESTATION OF TEST RESULTS	5
2. TEST METHODOLOGY	6
3. FACILITIES AND ACCREDITATION	6
4. CALIBRATION AND UNCERTAINTY	6
4.1. MEASURING INSTRUMENT CALIBRATION	6
4.2. SAMPLE CALCULATION	6
4.3. MEASUREMENT UNCERTAINTY	6
5. EQUIPMENT UNDER TEST	7
5.1. DESCRIPTION OF EUT	7
5.2. MAXIMUM OUTPUT POWER	7
5.3. DESCRIPTION OF AVAILABLE ANTENNAS	7
5.4. SOFTWARE AND FIRMWARE	8
5.5. WORST-CASE CONFIGURATION AND MODE	8
5.6. DESCRIPTION OF TEST SETUP	9
6. TEST AND MEASUREMENT EQUIPMENT	11
7. ANTENNA PORT TEST RESULTS	12
7.1. 5.2 GHz BAND CHANNEL TESTS FOR 802.11a MODE	12
7.1.1. 26 dB and 99% BANDWIDTH	12
7.1.2. OUTPUT POWER	15
7.1.3. AVERAGE POWER	19
7.1.4. PEAK POWER SPECTRAL DENSITY	20
7.1.5. PEAK EXCURSION	23
7.1.6. CONDUCTED SPURIOUS EMISSIONS	26
7.2. 5.2 GHz BAND CHANNEL TESTS FOR 802.11n HT20 MODE	29
7.2.1. 99% & 26 dB BANDWIDTH	29
7.2.2. OUTPUT POWER	32
7.2.3. AVERAGE POWER	39
7.2.4. PEAK POWER SPECTRAL DENSITY	40
7.2.5. PEAK EXCURSION	43
7.2.6. CONDUCTED SPURIOUS EMISSIONS	46
7.3. 5.2 GHz BAND CHANNEL TESTS FOR 802.11n HT40 MODE	49
7.3.1. 99% & 26 dB BANDWIDTH	49
7.3.2. OUTPUT POWER	51
7.3.3. AVERAGE POWER	56
7.3.4. PEAK POWER SPECTRAL DENSITY	57
7.3.5. PEAK EXCURSION	59
7.3.6. CONDUCTED SPURIOUS EMISSIONS	61
7.4. RECEIVER CONDUCTED SPURIOUS EMISSIONS	63

8. RADIATED TEST RESULTS 65

8.1. *LIMITS AND PROCEDURE* 65

8.2. *TRANSMITTER ABOVE 1 GHz* 66

8.2.1. 802.11a MODE IN 5.2 GHz BAND 66

8.2.2. 802.11n HT20 MODE IN 5.2 GHz BAND 68

8.2.3. 802.11n HT40 MODE IN 5.2 GHz BAND 72

8.3. *WORST-CASE BELOW 1 GHz*..... 76

9. AC POWER LINE CONDUCTED EMISSIONS 78

10. MAXIMUM PERMISSIBLE EXPOSURE 82

11. SETUP PHOTOS 86

1. ATTESTATION OF TEST RESULTS

COMPANY NAME: QUALCOMM, INC.
3165 KIFER RD
SANTA CLARA, CA 95051
U.S.A.

EUT DESCRIPTION: EA544D_3 ETHERNET ADAPTER CARD FOR 2.4 / 5 GHz AP APPLICATIONS_NON DFS

MODEL: 65-VN663-P3

SERIAL NUMBER: 7813 FOR ANTENNA PORT, 7908 FOR RADIATED EMISSIONS

DATE TESTED: JUNE 24 – JULY 18, 2009

APPLICABLE STANDARDS	
STANDARD	TEST RESULTS
CFR 47 Part 15 Subpart E	Pass
INDUSTRY CANADA RSS-210 Issue 7 Annex 9	Pass
INDUSTRY CANADA RSS-GEN Issue 2	Pass

Compliance Certification Services, Inc. (CCS) tested the above equipment in accordance with the requirements set forth in the above standards. All indications of Pass/Fail in this report are opinions expressed by CCS based on interpretations and/or observations of test results. Measurement Uncertainties were not taken into account and are published for informational purposes only. The test results show that the equipment tested is capable of demonstrating compliance with the requirements as documented in this report.

Note: The results documented in this report apply only to the tested sample, under the conditions and modes of operation as described herein. This document may not be altered or revised in any way unless done so by CCS and all revisions are duly noted in the revisions section. Any alteration of this document not carried out by CCS will constitute fraud and shall nullify the document. This report must not be used by the client to claim product certification, approval, or endorsement by NVLAP, NIST, any agency of the Federal Government, or any agency of any government.

Approved & Released For CCS By:

Tested By:



FRANK IBRAHIM
EMC SUPERVISOR
COMPLIANCE CERTIFICATION SERVICES

VIEN TRAN
EMC ENGINEER
COMPLIANCE CERTIFICATION SERVICES

2. TEST METHODOLOGY

The tests documented in this report were performed in accordance with ANSI C63.4-2003, FCC CFR 47 Part 2, FCC CFR 47 Part 15, RSS-GEN Issue 2, and RSS-210 Issue 7.

3. FACILITIES AND ACCREDITATION

The test sites and measurement facilities used to collect data are located at 47173 Benicia Street, Fremont, California, USA.

CCS is accredited by NVLAP, Laboratory Code 200065-0. The full scope of accreditation can be viewed at <http://www.ccsemc.com>.

4. CALIBRATION AND UNCERTAINTY

4.1. MEASURING INSTRUMENT CALIBRATION

The measuring equipment utilized to perform the tests documented in this report has been calibrated in accordance with the manufacturer's recommendations, and is traceable to recognized national standards.

4.2. SAMPLE CALCULATION

Where relevant, the following sample calculation is provided:

$$\begin{aligned} \text{Field Strength (dBuV/m)} &= \text{Measured Voltage (dBuV)} + \text{Antenna Factor (dB/m)} + \\ &\text{Cable Loss (dB)} - \text{Preamp Gain (dB)} \\ 36.5 \text{ dBuV} + 18.7 \text{ dB/m} + 0.6 \text{ dB} - 26.9 \text{ dB} &= 28.9 \text{ dBuV/m} \end{aligned}$$

4.3. MEASUREMENT UNCERTAINTY

Where relevant, the following measurement uncertainty levels have been estimated for tests performed on the apparatus:

PARAMETER	UNCERTAINTY
Conducted Disturbance, 0.15 to 30 MHz	3.52 dB
Radiated Disturbance, 30 to 1000 MHz	4.94 dB

Uncertainty figures are valid to a confidence level of 95%.

5. EQUIPMENT UNDER TEST

5.1. DESCRIPTION OF EUT

The EUT is an 802.11a/b/g/n WLAN transceiver module for 2.4 / 5 GHz AP Applications that do not include DFS bands. It is equipped with four identical transmitter / receiver chains and an Ethernet port.

The radio module is manufactured by Qualcomm, Inc.

5.2. MAXIMUM OUTPUT POWER

Frequency Range (MHz)	Mode	Output Power (dBm)	Output Power (mW)
5.2 GHz BAND			
5180 - 5240	802.11a	12.10	16.22
5180 - 5240	802.11n HT20	13.67	23.28
5190 - 5230	802.11n HT40	16.88	48.75

The transmitter has a maximum peak conducted output power as follows:

5.3. DESCRIPTION OF AVAILABLE ANTENNAS

The radio utilizes a dual band omni monopole (4 identical) antenna, each with a maximum gain of 3 dBi in the 5 GHz bands.

For the 802.11a legacy mode only two chains are transmitting, therefore the effective legacy antenna gain is:

Antenna Gain (dBi)	10 Log (# Tx Chains) (dB)	Effective Legacy Gain (dBi)
3	3.01	6.01

5.4. SOFTWARE AND FIRMWARE

The EUT driver software installed during testing was Keyspan, rev. 3.7.0.2.

The test utility software used during testing was PTT Gui, rev. 5.1.

5.5. WORST-CASE CONFIGURATION AND MODE

The EUT was tested as an external module connected to a host Laptop PC via a test fixture.

Worst-Case data rates were utilized from preliminary testing of the Chipset, worst-case data rates used during the testing are as follows:

802.11a Mode (20 MHz BW operation): 6 Mbps, OFDM.

802.11n MIMO HT20 Mode: MCS31, 260 Mbps, 4 Spatial Streams.

802.11n MIMO HT40 Mode: MCS31, 540 Mbps, 4 Spatial Streams.

Worst-case mode and channel used for 30-1000 MHz radiated and power line conducted emissions was the mode and channel with the highest output power, that was determined to be 11n HT40, high channel.

For 26 dB BW measurement preliminary testing showed that there is no significant difference among different chains, so the measurement was performed using Chain 0.

For conducted spurious measurement preliminary testing showed that combiner is worst-case compared to individual chains; therefore, final measurement was performed using combiner for all channels and modes.

For PPSD measurement preliminary testing showed that combiner is worst-case compared to individual chains; therefore, final measurement was performed using combiner for all channels and modes.

For Radiated Band Edge measurements preliminary testing showed that the worst case was vertical polarization, so final measurements were performed with vertical polarization.

5.6. DESCRIPTION OF TEST SETUP

SUPPORT EQUIPMENT

PERIPHERAL SUPPORT EQUIPMENT LIST				
Description	Manufacturer	Model	Serial Number	FCC ID
Laptop	IBM	T43 ThinkPad	L3-F9978 05/06	DoC
AC Adapter	IBM	08K8208	11S08K8208Z1Z6	DoC
AC Adapter	Phihong	PSA15R-050P	N/A	N/A
Serial (DB9)/USB	Keyspan	N/A	N/A	N/A
Test Fixture	N/A	N/A	N/A	N/A

I/O CABLES

I/O CABLE LIST						
Cable No.	Port	# of Identical Ports	Connecto Type	Cable Type	Cable Length	Remarks
1	AC	2	US 115V	Shielded	1m	For laptop & EUT
2	DC	2	DC	Un-shielded	2m	For laptop & EUT
3	USB	1	USB	Shielded	.8m	From laptop to USB Converter
4	Ethernet	1	RJ45	Un-shielded	1 m	From laptop to EUT
5	Cable	1	Ribbon	Un-shielded	.4 m	Test Fixture to EUT

TEST SETUP

The EUT is installed in a host laptop computer via test fixture during the tests. Test software exercised the radio card.

SETUP DIAGRAM FOR TESTS

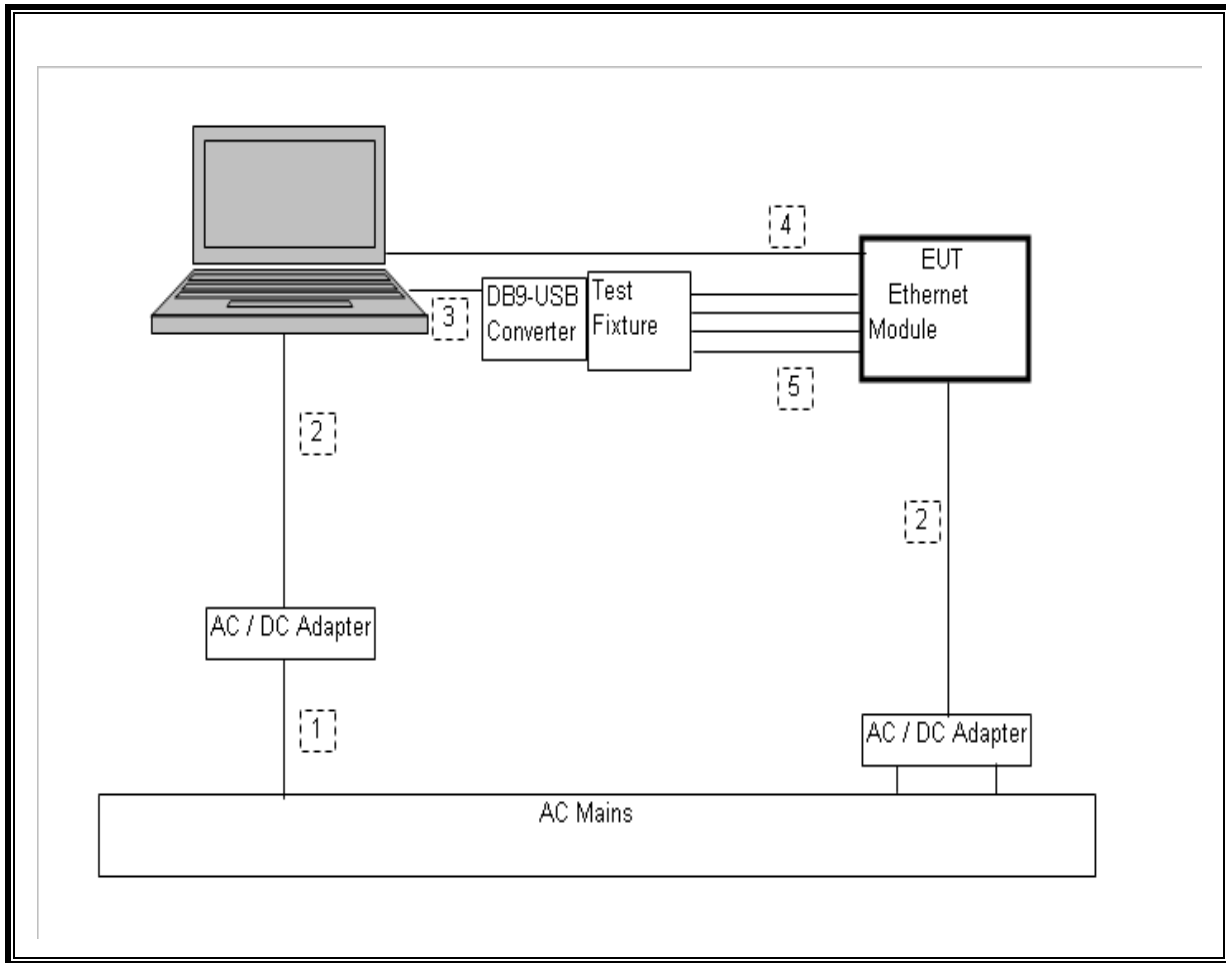

6. TEST AND MEASUREMENT EQUIPMENT

The following test and measurement equipment was utilized for the tests documented in this report:

TEST EQUIPMENT LIST					
Description	Manufacturer	Model	Asset	Cal Date	Cal Due
Spectrum Analyzer, 44 GHz	Agilent / HP	E4446A	C01069	01/05/09	01/05/10
Antenna, Bilog, 2 GHz	Sunol Sciences	JB1	C01011	01/14/09	01/14/10
Antenna, Horn, 18 GHz	EMCO	3115	C00945	04/22/09	04/22/10
Antenna, Horn, 26.5 GHz	ARA	MVH-1826/B	C00589	09/29/08	11/28/09
Antenna, Horn, 40 GHz	ARA	MVH-2640B	C00981	05/21/09	05/21/10
Preamplifier, 40 GHz	Miteq	NSP4000-SP2	C00990	10/11/08	10/11/09
Preamplifier, 1300 MHz	Agilent / HP	8447D	C00885	03/31/09	03/31/10
Preamplifier, 1-26GHz	Agilent / HP	8449B	C01052	08/05/08	08/05/09
Peak Power Meter	Boonton	4541	C01186	01/19/09	01/19/10
Peak Power Sensor	Boonton	4541	C01189	01/15/09	01/15/10
LISN, 30 MHz	FCC	LISN-50/250-25-2	N02625	10/29/08	10/29/09
EMI Test Receiver, 30 MHz	R & S	ESHS 20	N02396	02/06/08	08/06/09

7. ANTENNA PORT TEST RESULTS

7.1. 5.2 GHz BAND CHANNEL TESTS FOR 802.11a MODE

7.1.1. 26 dB and 99% BANDWIDTH

LIMITS

None; for reporting purposes only.

TEST PROCEDURE

The transmitter outputs are connected to the spectrum analyzer via a combiner. The RBW is set to 1% to 3% of the measured bandwidth. The VBW is set to 3 times the RBW. The sweep time is coupled. The spectrum analyzer internal bandwidth function is utilized.

RESULTS

Channel	Frequency (MHz)	26 dB Bandwidth (MHz)	99% Bandwidth (MHz)
Low	5180	19.1120	16.4340
Middle	5200	18.3460	16.3915
High	5240	18.6980	16.4054

26 dB and 99% BANDWIDTH

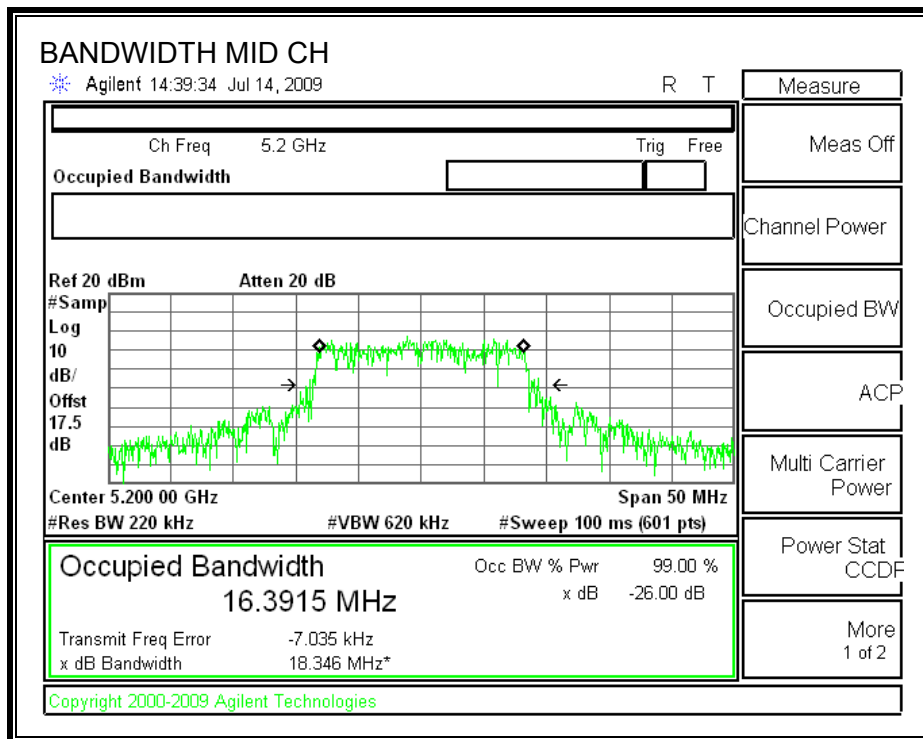
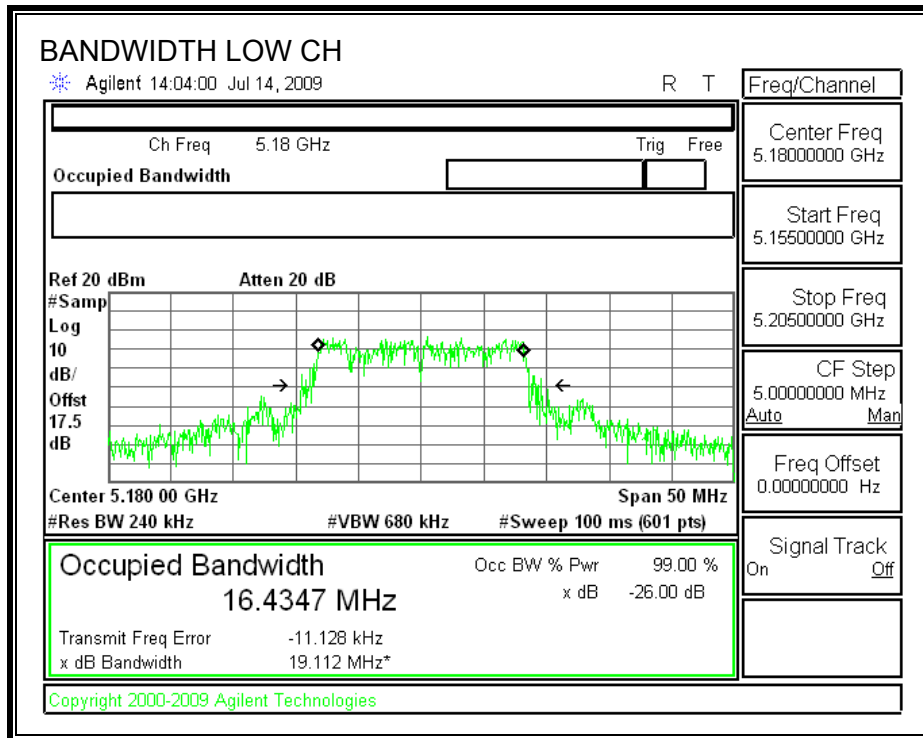

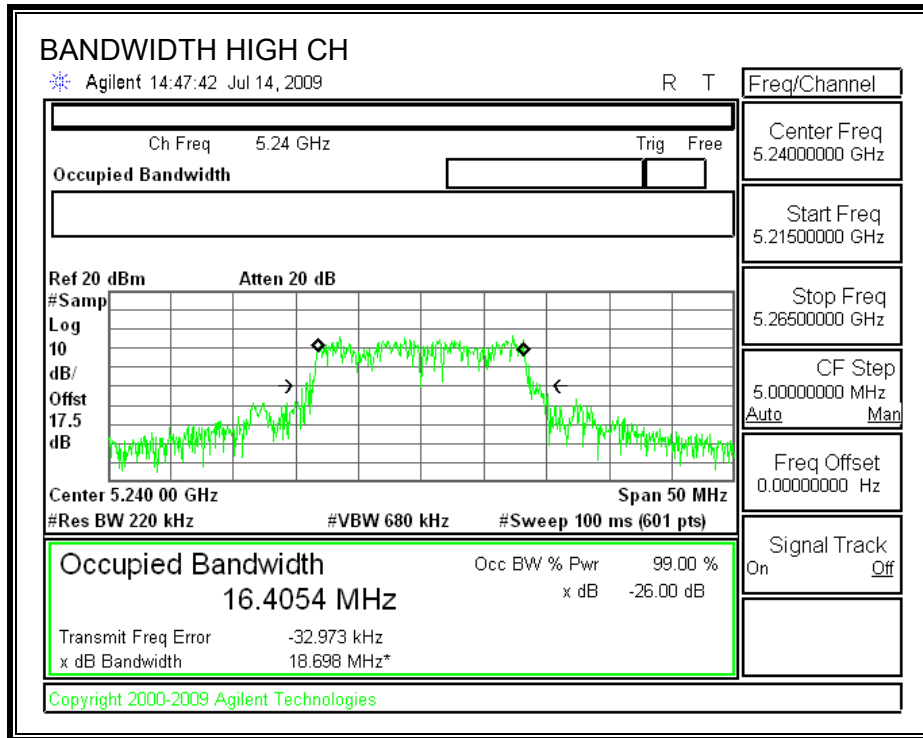

7.1.2. OUTPUT POWER

LIMITS

FCC §15.407 (a) (1)
 IC RSS-210 A9.2 (1)

Antenna gain of Chain 1 = antenna gain of Chain 2.

Antenna Gain (dBi)	10 Log (# Tx Chains) (dB)	Effective Legacy Gain (dBi)
3	3.01	6.01

For the 5.15-5.25 GHz band, the maximum conducted output power over the frequency band of operation shall not exceed the lesser of 50 mW or 4 dBm + 10 log B, where B is the 26-dB emission bandwidth in MHz. If transmitting antennas of directional gain greater than 6 dBi are used, both the peak transmit power and the peak power spectral density shall be reduced by the amount in dB that the directional gain of the antenna exceeds 6 dBi.

TEST PROCEDURE

The test is performed in accordance with FCC Public Notice: APPENDIX A Guidelines for Assessing Unlicensed National Information Infrastructure (U-NII) Devices – Part 15, Subpart E, August 2002.

The transmitter output operates continuously therefore Method # 1 is used.

RESULTS

Limit

Channel	Frequency (MHz)	Fixed Limit (dBm)	B (MHz)	4 + 10 Log B Limit (dBm)	Effective Antenna Gain (dBi)	Limit (dBm)
Low	5180	17	19.1120	16.81	6.01	16.80
Mid	5200	17	18.3460	16.64	6.01	16.63
High	5240	17	18.6980	16.72	6.01	16.71

Individual Chain Results

Channel	Frequency (MHz)	Chain 0 Power (dBm)	Chain 1 Power (dBm)	Total Power (dBm)	Limit (dBm)	Margin (dB)
Low	5180	9.18	8.99	12.10	16.80	-4.71
Mid	5200	9.11	8.99	12.06	16.63	-4.56
High	5240	9.15	8.96	12.07	16.71	-4.64

OUTPUT POWER, LOW CHANNEL

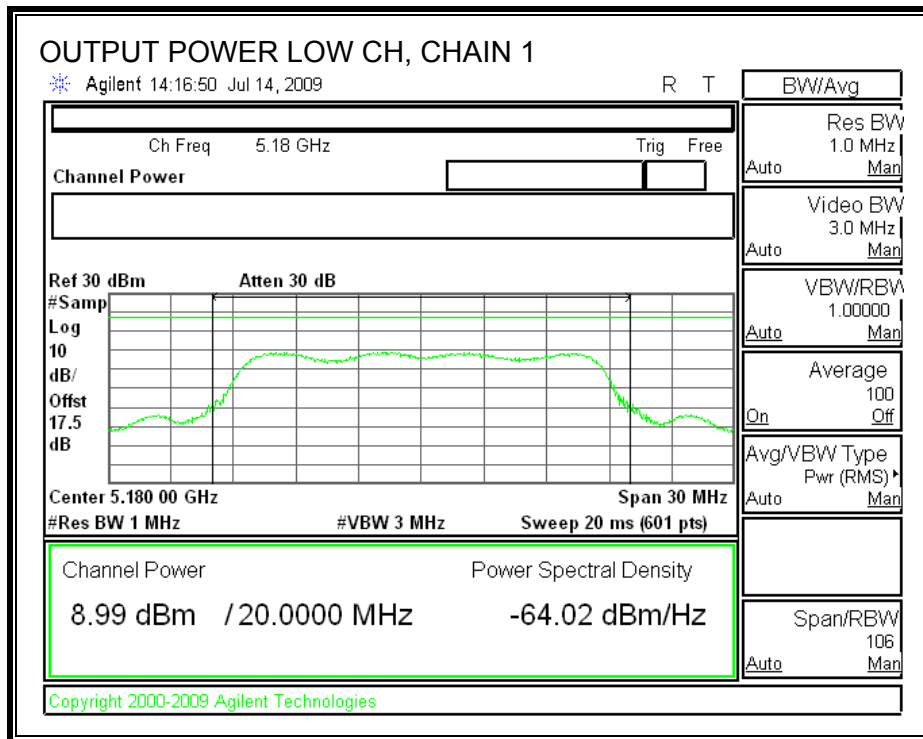
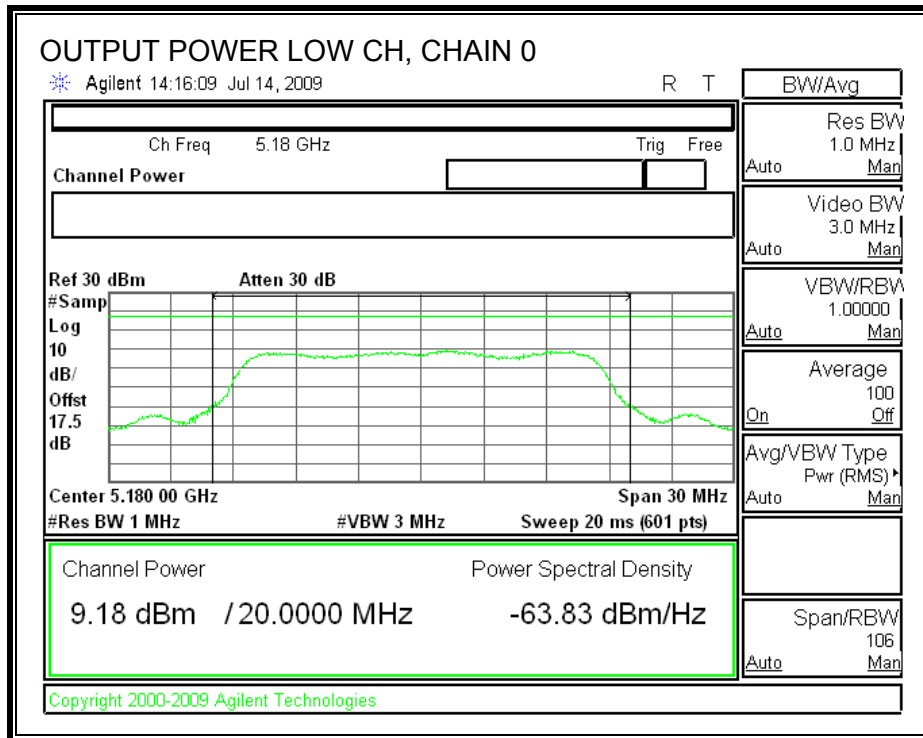

OUTPUT POWER, MID CHANNEL

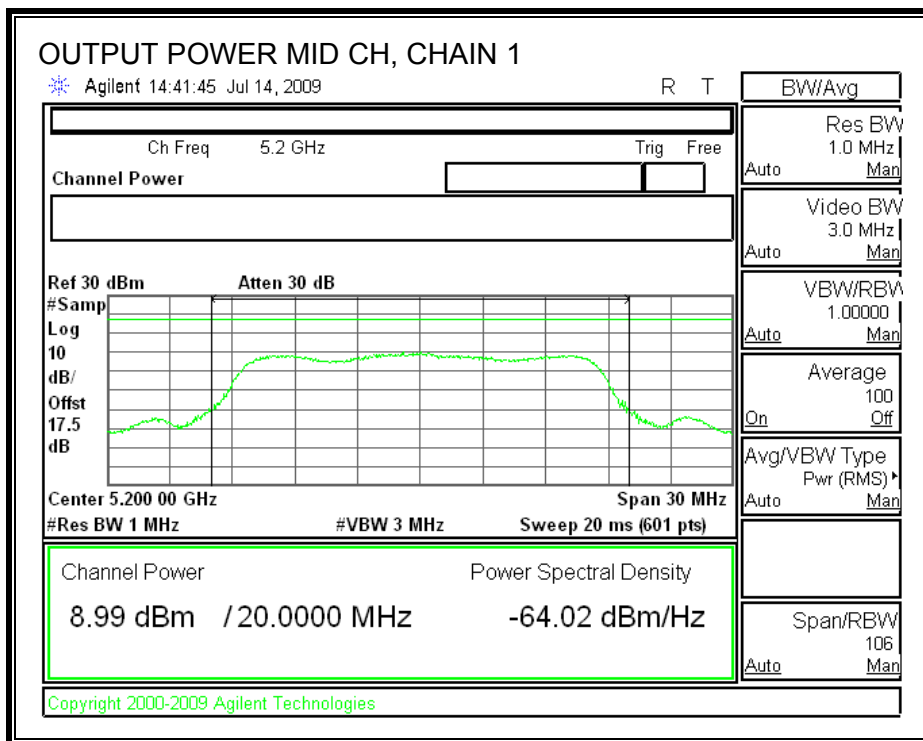
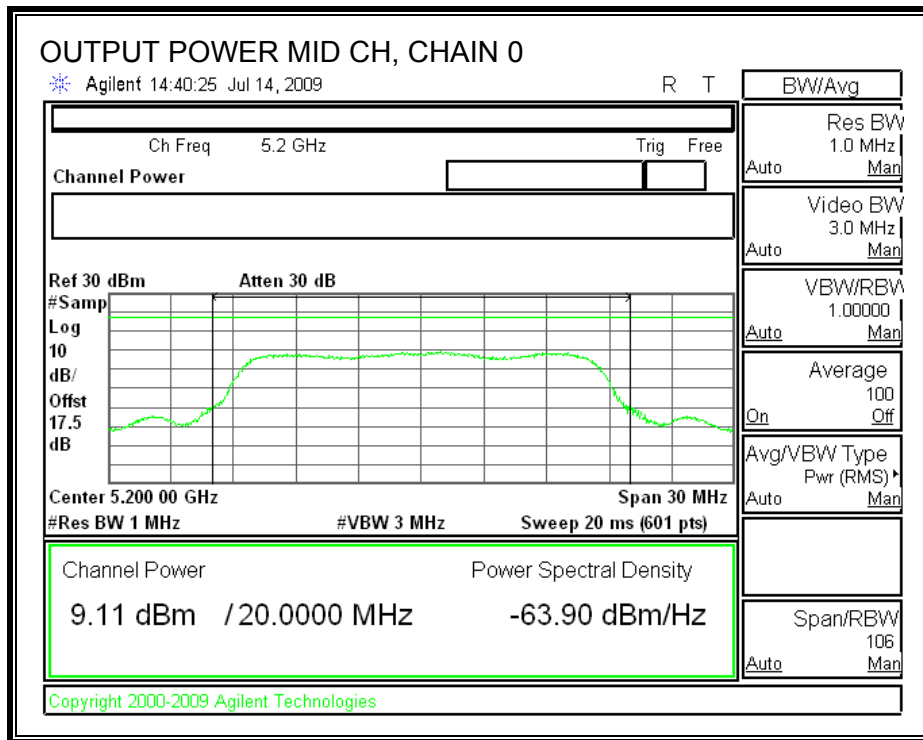

OUTPUT POWER, HIGH CHANNEL

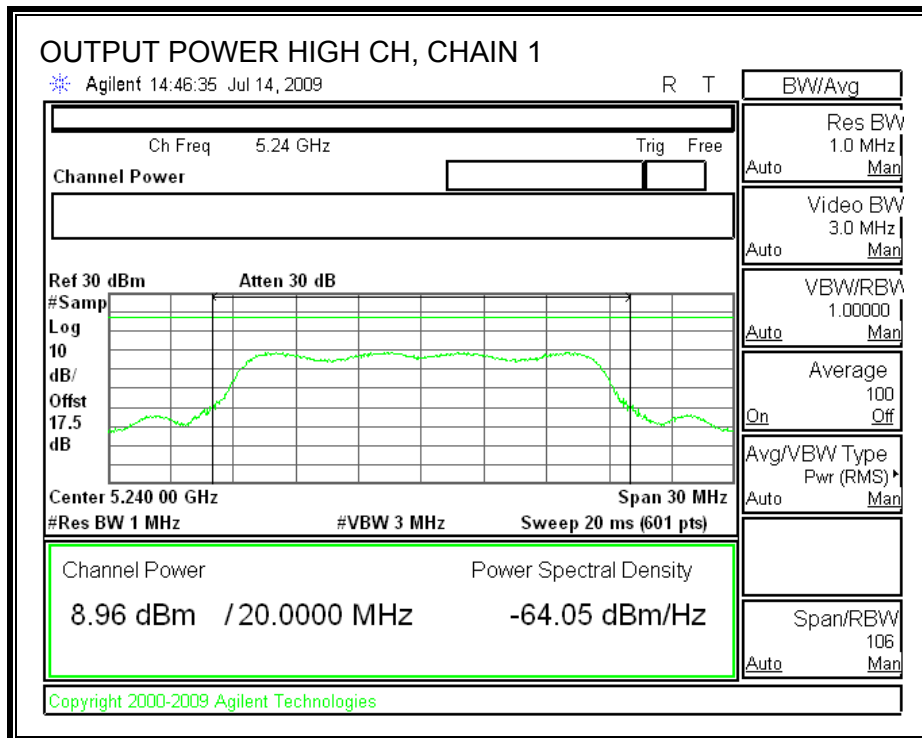
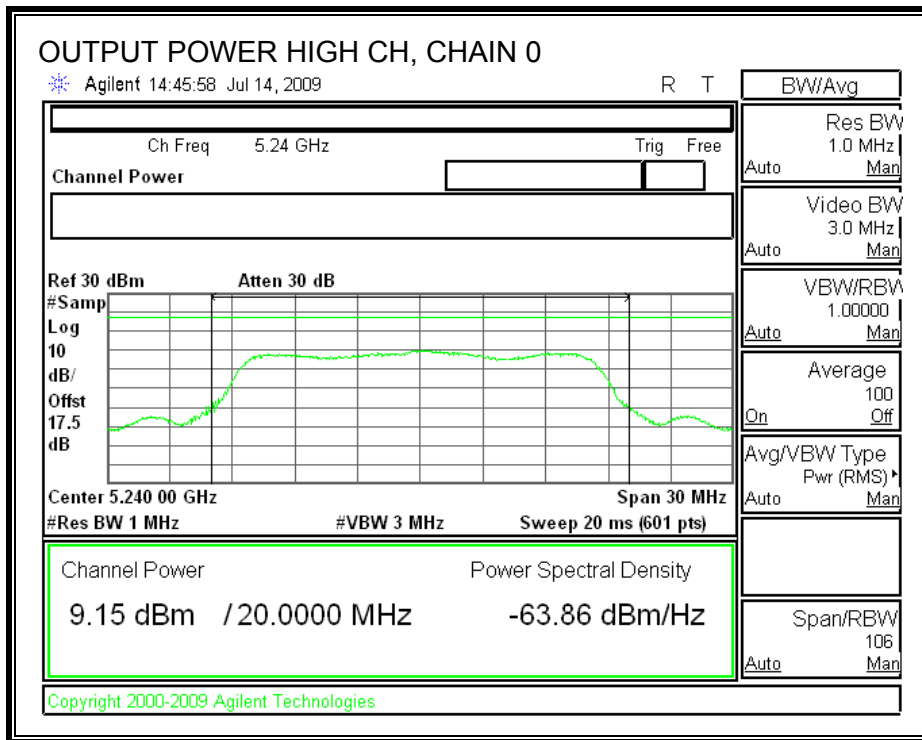

7.1.3. AVERAGE POWER

LIMITS

None; for reporting purposes only.

TEST PROCEDURE

The transmitter output is connected to a power meter.

RESULTS

The cable assembly insertion loss of 11.3 dB (including 10 dB pad and 1.3 dB cable) was entered as an offset in the power meter to allow for direct reading of power.

Channel	Frequency (MHz)	Chain 0 Power (dBm)	Chain 1 Power (dBm)	Total Power (dBm)
Low	5180	9.15	8.89	12.03
Middle	5200	9.10	8.98	12.05
High	5240	9.09	8.93	12.02

7.1.4. PEAK POWER SPECTRAL DENSITY

LIMITS

FCC §15.407 (a) (1)

IC RSS-210 A9.2 (1)

Use this table if antenna gain for Chain 1 = antenna gain for Chain 2

Antenna Gain (dBi)	10 Log (# Tx Chains) (dB)	Effective Legacy Gain (dBi)
3	3.01	6.01

For the 5.15-5.25 GHz band, the peak power spectral density shall not exceed 4 dBm in any 1 MHz band. If transmitting antennas of directional gain greater than 6 dBi are used, both the peak transmit power and the peak power spectral density shall be reduced by the amount in dB that the directional gain of the antenna exceeds 6 dBi.

The maximum effective antenna gain is less than or equal to 6.01 dBi, therefore the limit is 3.99 dBm.

TEST PROCEDURE

The test is performed in accordance with FCC Public Notice: APPENDIX A Guidelines for Assessing Unlicensed National Information Infrastructure (U-NII) Devices – Part 15, Subpart E, August 2002. PPSD method #2 was used.

RESULTS

Channel	Frequency (MHz)	PPSD With Combiner (dBm)	Limit (dBm)	Margin (dB)
Low	5180	3.81	3.99	-0.18
Middle	5200	3.92	3.99	-0.07
High	5240	3.86	3.99	-0.13

POWER SPECTRAL DENSITY WITH COMBINER

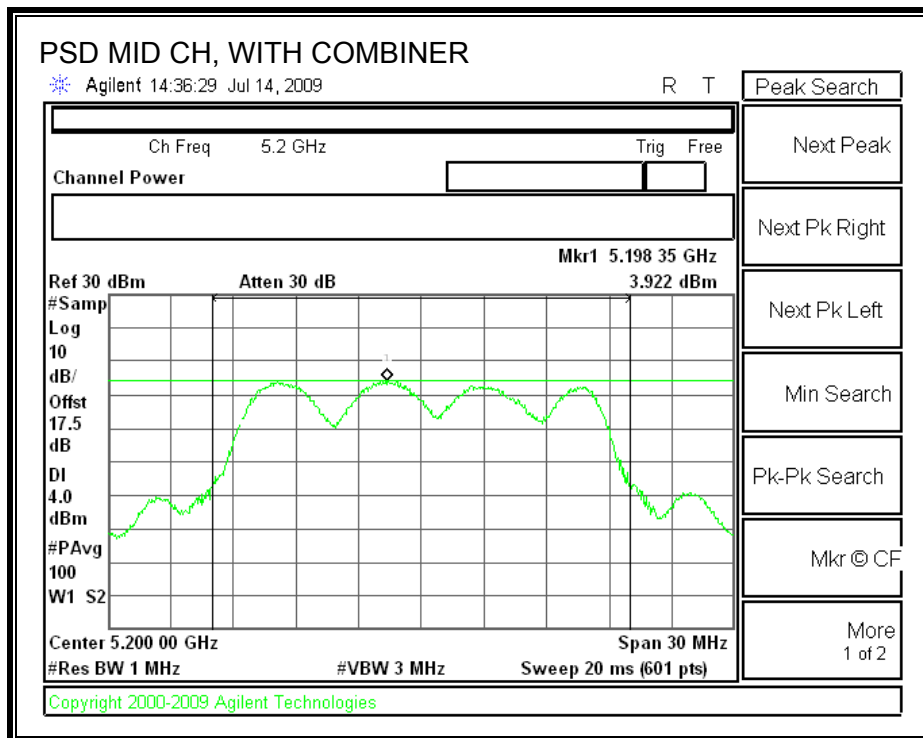
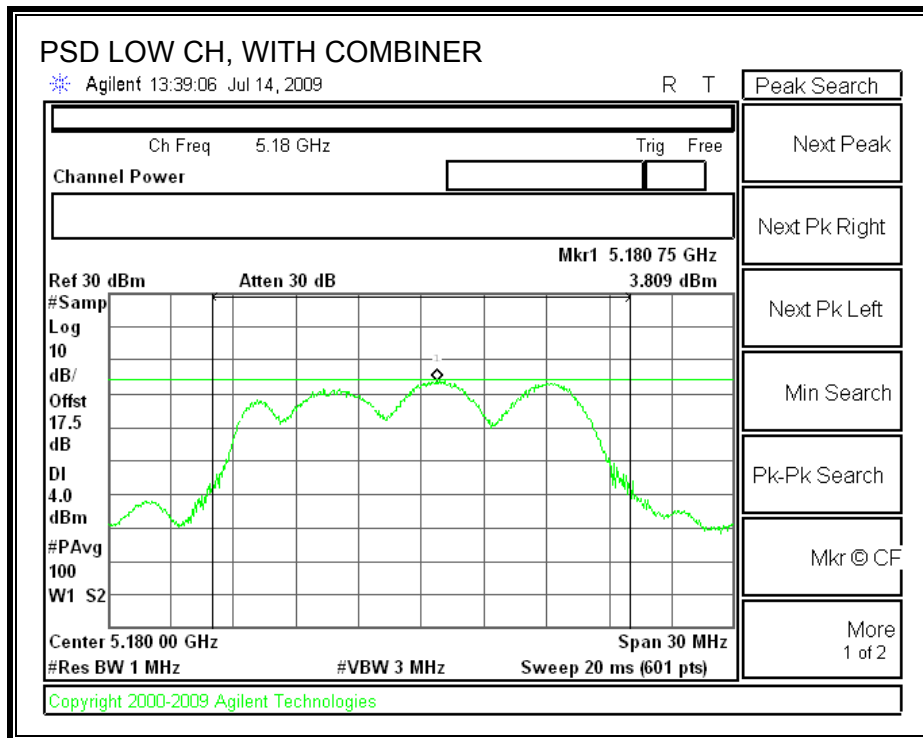

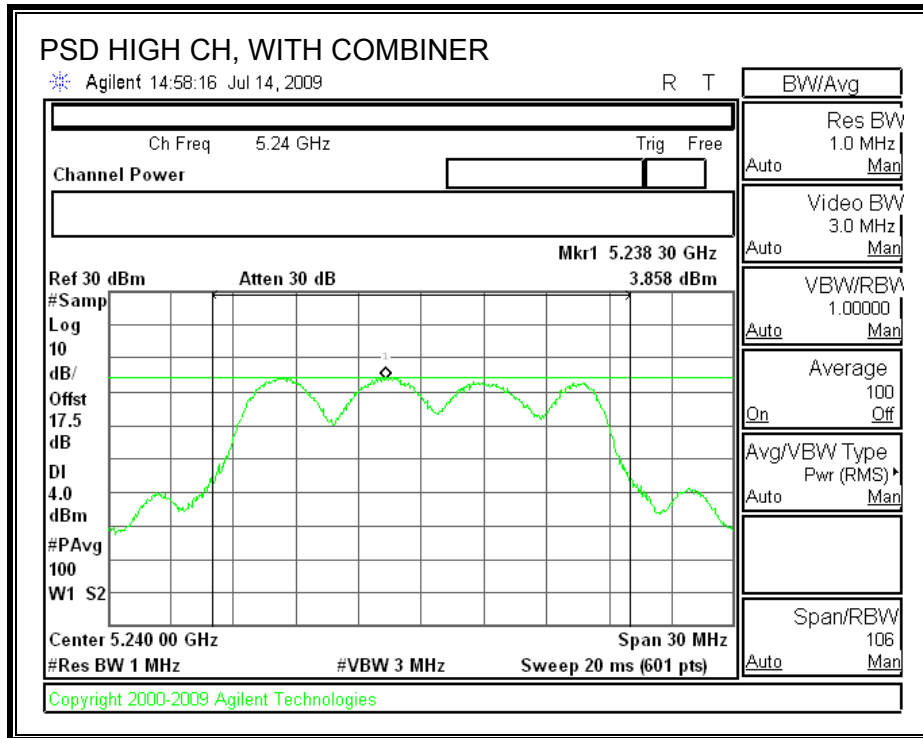

7.1.5. PEAK EXCURSION

LIMITS

FCC §15.407 (a) (6)

The ratio of the peak excursion of the modulation envelope (measured using a peak hold function) to the peak transmit power (measured as specified above) shall not exceed 13 dB across any 1 MHz bandwidth or the emission bandwidth whichever is less.

TEST PROCEDURE

The transmitter outputs are connected to the spectrum analyzer via a combiner.

The test is performed in accordance with FCC Public Notice: APPENDIX A Guidelines for Assessing Unlicensed National Information Infrastructure (U-NII) Devices – Part 15, Subpart E, August 2002.

Since Method # 1 was used for peak power measurements, Method # 1 settings are used for the second PPSD trace.

RESULTS

Channel	Frequency (MHz)	Peak Excursion (dB)	Limit (dB)	Margin (dB)
Low	5180	10.28	13	-2.72
Middle	5200	11.57	13	-1.43
High	5240	10.22	13	-2.78

PEAK EXCURSION

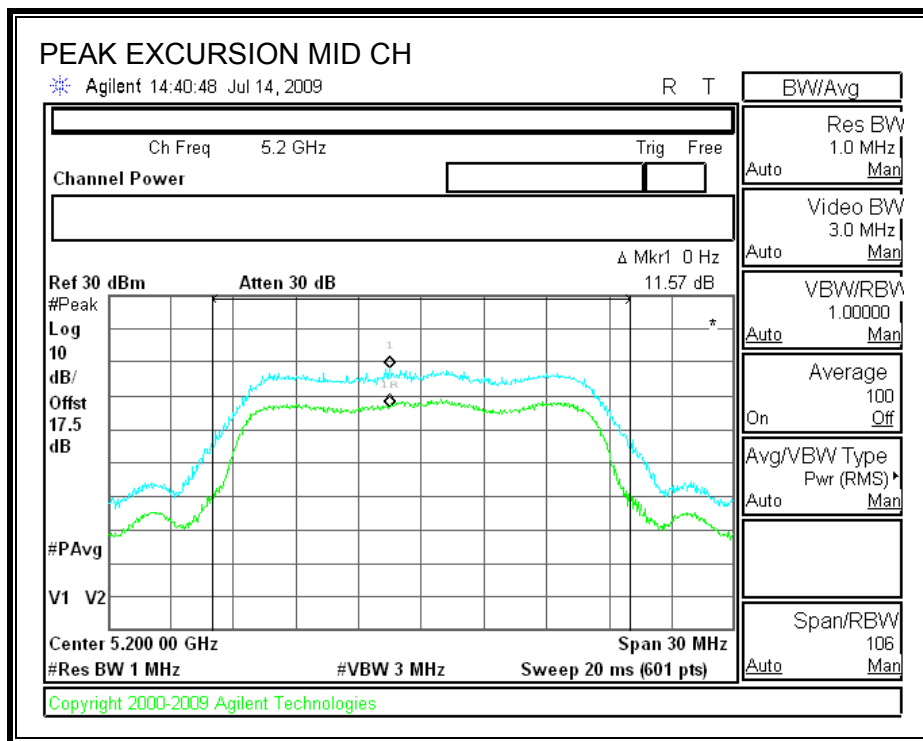
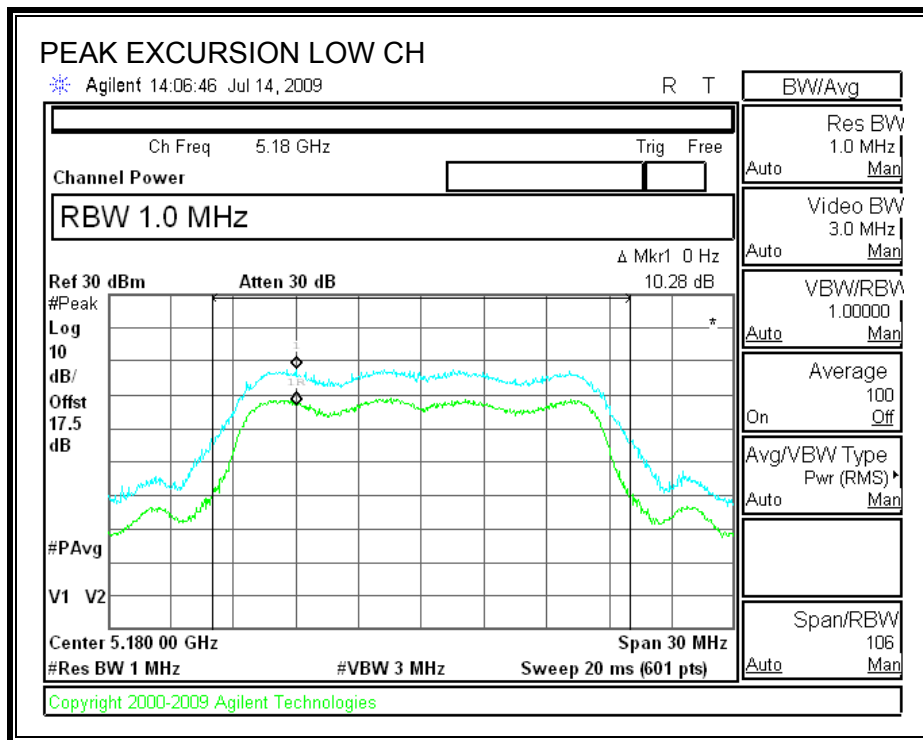

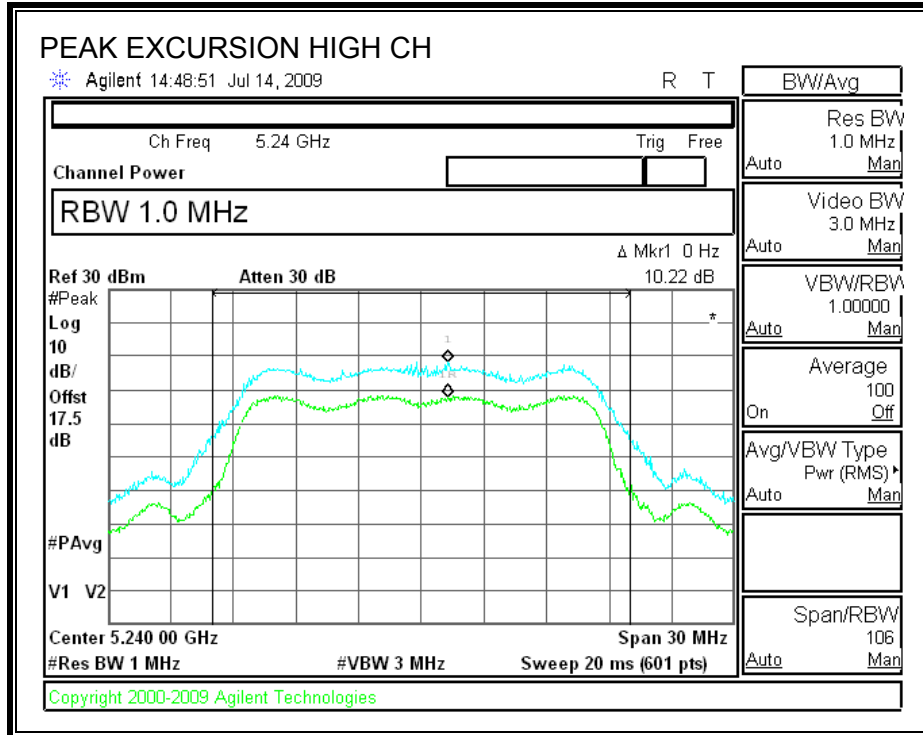

7.1.6. CONDUCTED SPURIOUS EMISSIONS

LIMITS

FCC §15.407 (b) (1)

IC RSS-210 A9.3 (1)

For transmitters operating in the 5.15-5.25 GHz band: all emissions outside of the 5.15-5.35 GHz band shall not exceed an EIRP of -27 dBm / MHz.

TEST PROCEDURE

Conducted RF measurements of the transmitter output are made to confirm that the EUT antenna port conducted emissions meet the specified limit and to identify any spurious signals that require further investigation or measurements on the radiated emissions site.

The transmitter output is connected to the spectrum analyzer. The resolution bandwidth is set to 1 MHz. The video bandwidth is set to 1 MHz. Peak detection measurements are compared to EIRP limit, adjusted for the maximum antenna gain.

Measurements are made over the 30 MHz to 40 GHz range with the transmitter set to the lowest, middle, and highest channels.

SPURIOUS EMISSIONS WITH COMBINER

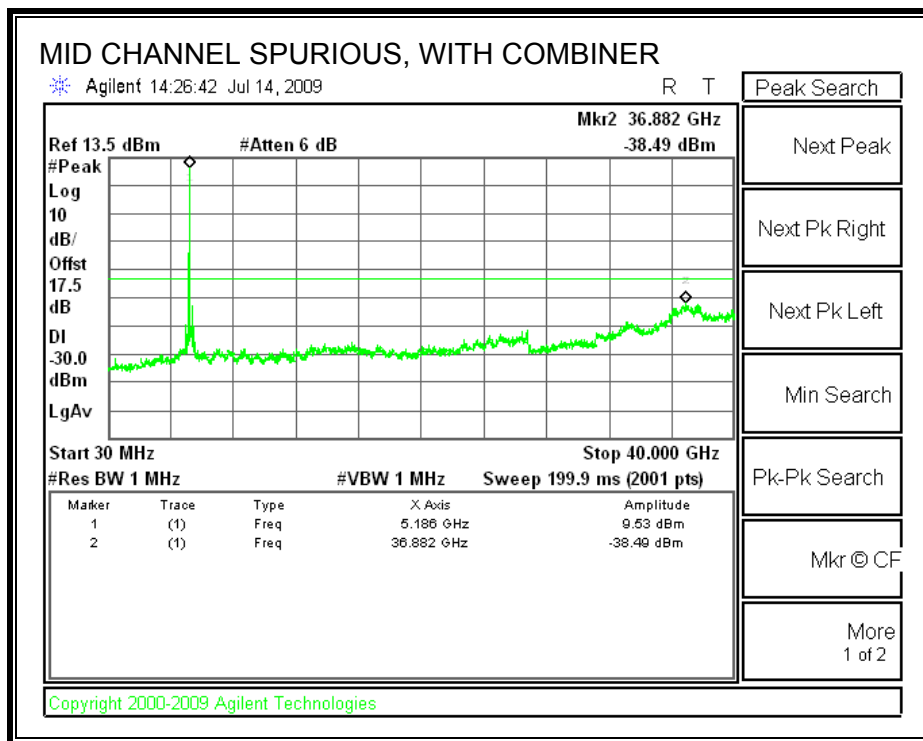
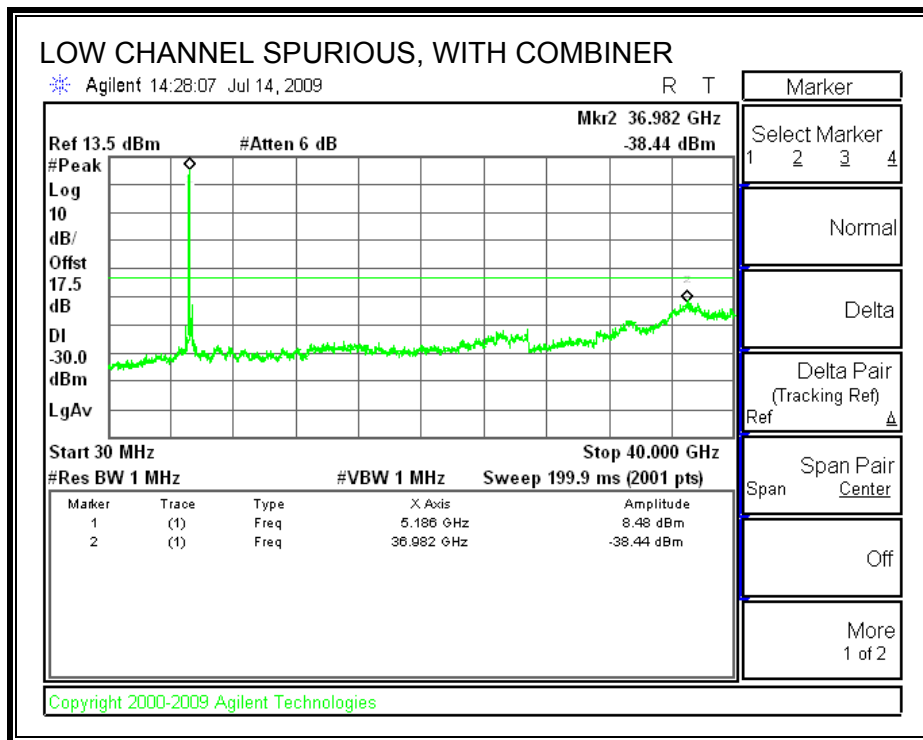

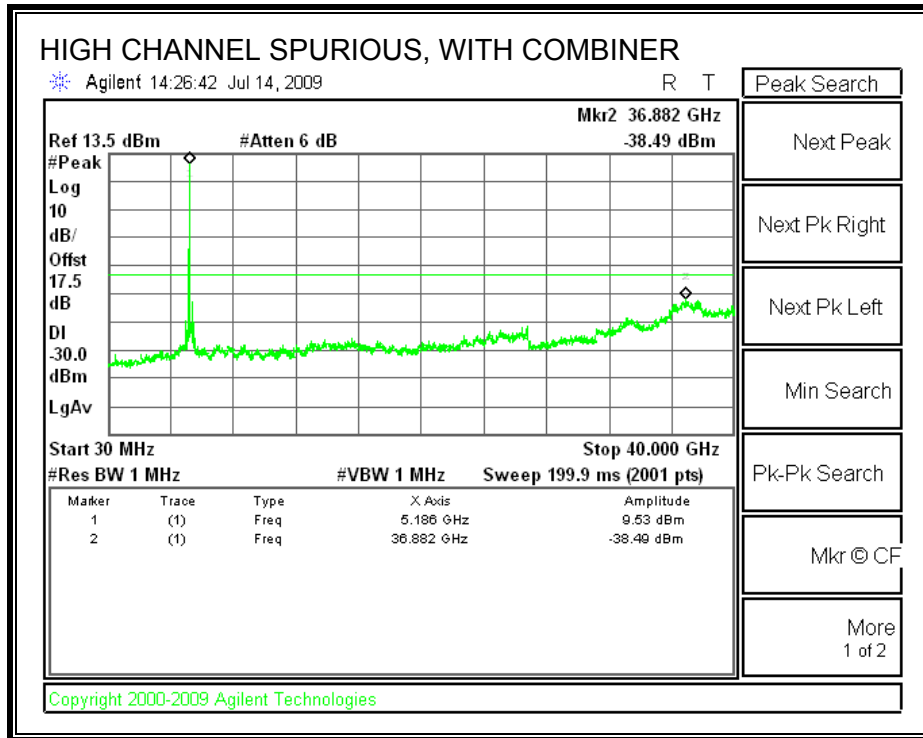

7.2. 5.2 GHz BAND CHANNEL TESTS FOR 802.11n HT20 MODE

7.2.1. 99% & 26 dB BANDWIDTH

LIMITS

None; for reporting purposes only.

TEST PROCEDURE

The transmitter output is connected to the spectrum analyzer. The RBW is set to 1% to 3% of the bandwidth. The VBW is set to 3 times the RBW. The sweep time is coupled. The spectrum analyzer internal bandwidth measurement function is utilized.

RESULTS

Channel	Frequency (MHz)	99% OBW (MHz)	26 dB BW (MHz)
Low	5180	17.1329	18.432
Middle	5200	17.0773	18.707
High	5240	17.3831	19.172

99% & 26 dB BANDWIDTH

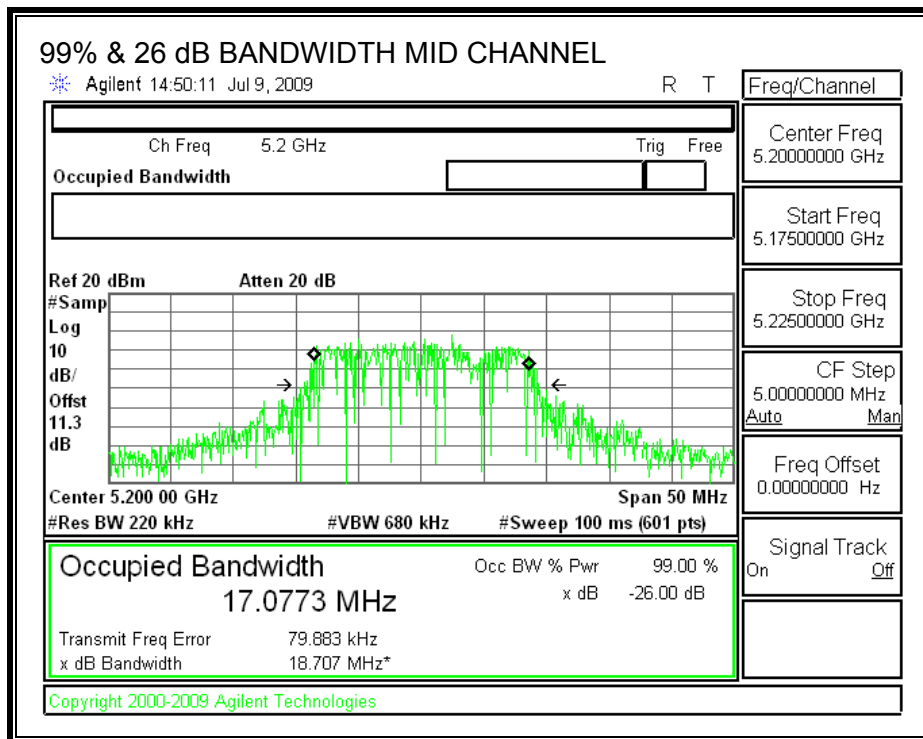
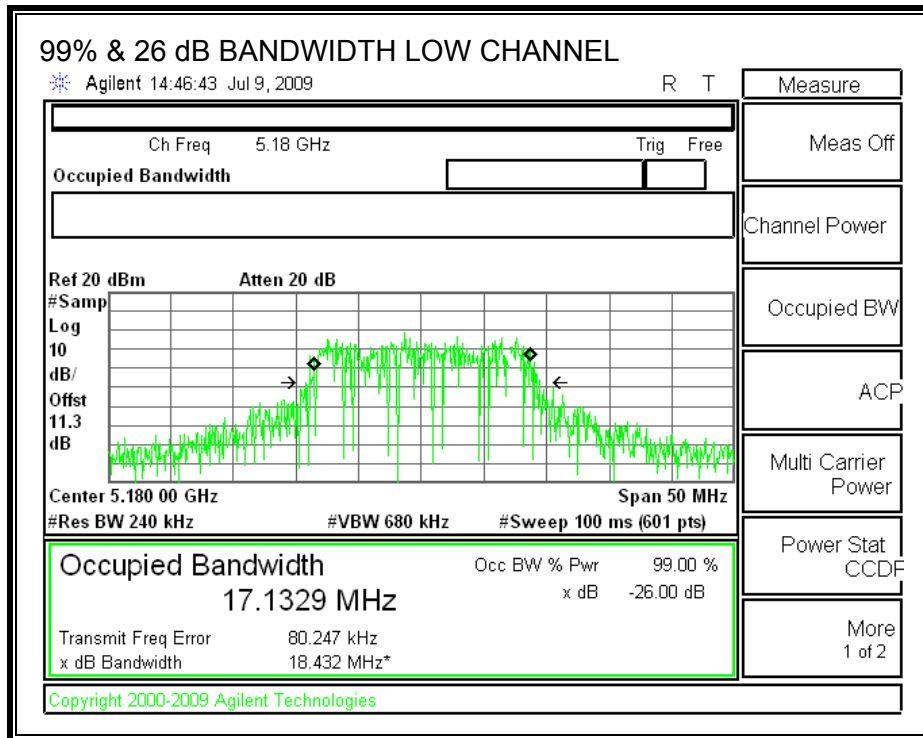

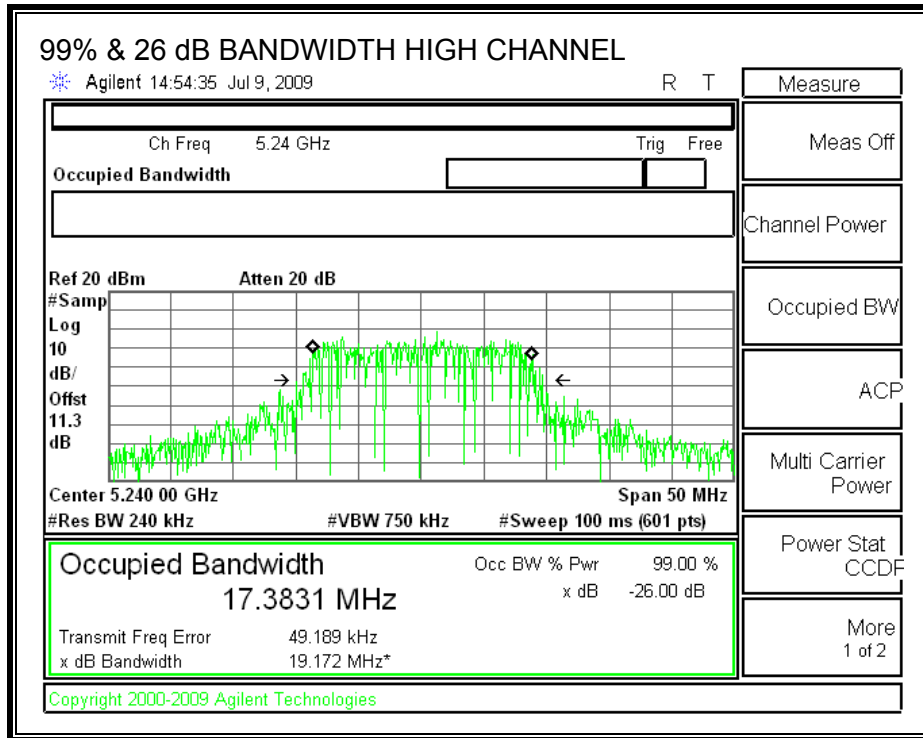

7.2.2. OUTPUT POWER

LIMITS

FCC §15.407 (a) (2)
 IC RSS-210 A9.2 (2)

For the 5.15-5.25 GHz band, the maximum conducted output power over the frequency band of operation shall not exceed the lesser of 50 mW or 4 dBm + 10 log B, where B is the 26-dB emission bandwidth in MHz. If transmitting antennas of directional gain greater than 6 dBi are used, both the peak transmit power and the peak power spectral density shall be reduced by the amount in dB that the directional gain of the antenna exceeds 6 dBi.

TEST PROCEDURE

The test is performed in accordance with FCC Public Notice: APPENDIX A Guidelines for Assessing Unlicensed National Information Infrastructure (U-NII) Devices – Part 15, Subpart E, August 2002.

The transmitter output operates continuously therefore Method # 1 is used.

RESULTS

Limit

Channel	Freq (MHz)	Fixed Limit (dBm)	B (MHz)	4 + 10 Log B Limit (dBm)	Antenna Gain (dBi)	Limit (dBm)
Low	5180	17	18.432	16.66	3	16.66
Mid	5200	17	18.707	16.72	3	16.72
High	5240	17	19.172	16.83	3	16.83

Individual Chain Results

Channel	Freq (MHz)	Chain 0 Power (dBm)	Chain 1 Power (dBm)	Chain 2 Power (dBm)	Chain 3 Power (dBm)	Total Power (dBm)	Limit (dBm)	Margin (dB)
Low	5180	7.13	7.29	7.33	7.33	13.29	16.66	-3.36
Mid	5200	7.19	7.58	7.47	7.65	13.50	16.72	-3.22
High	5240	7.22	7.86	7.85	7.65	13.67	16.83	-3.15

OUTPUT POWER, LOW CHANNEL

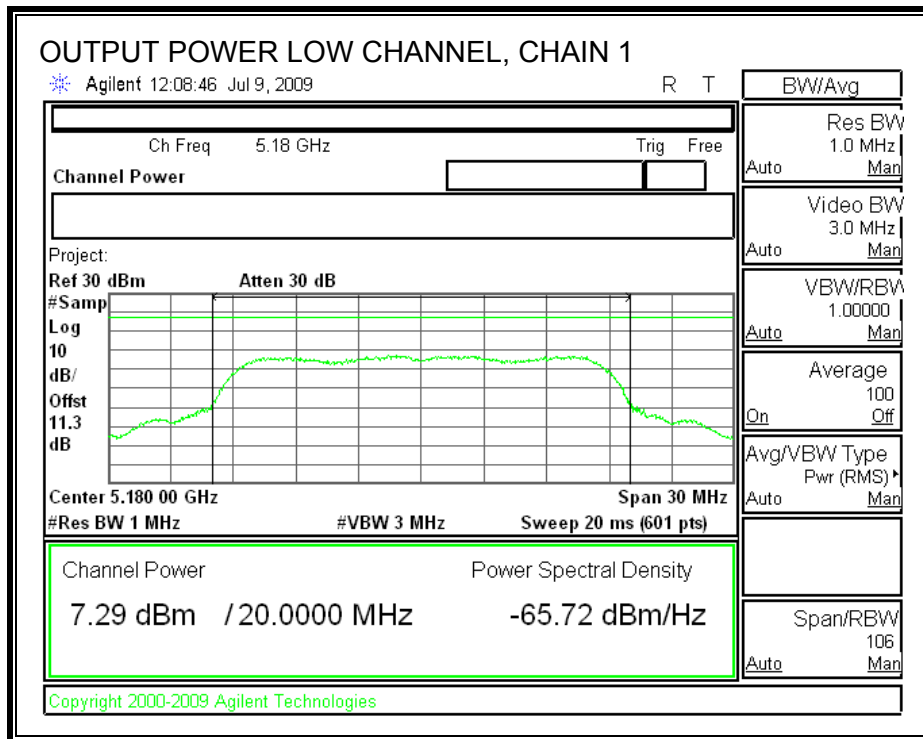
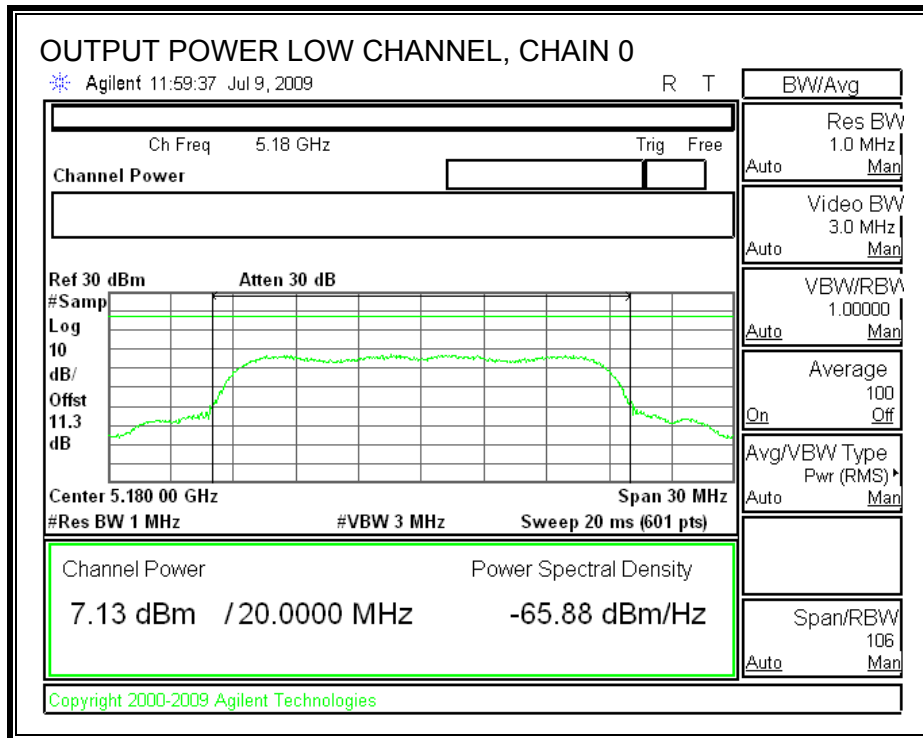

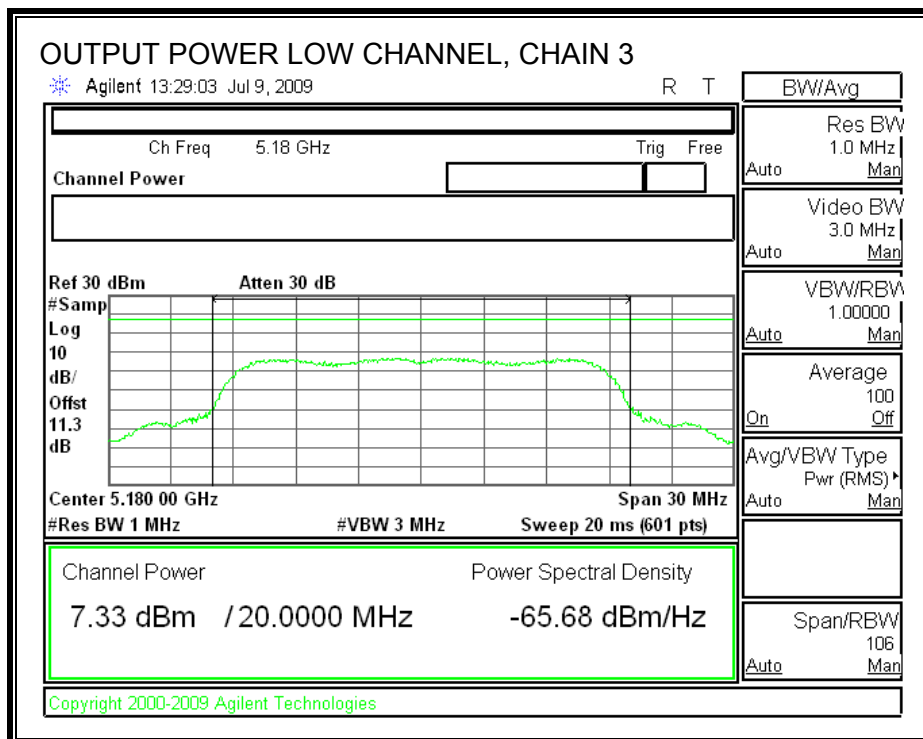
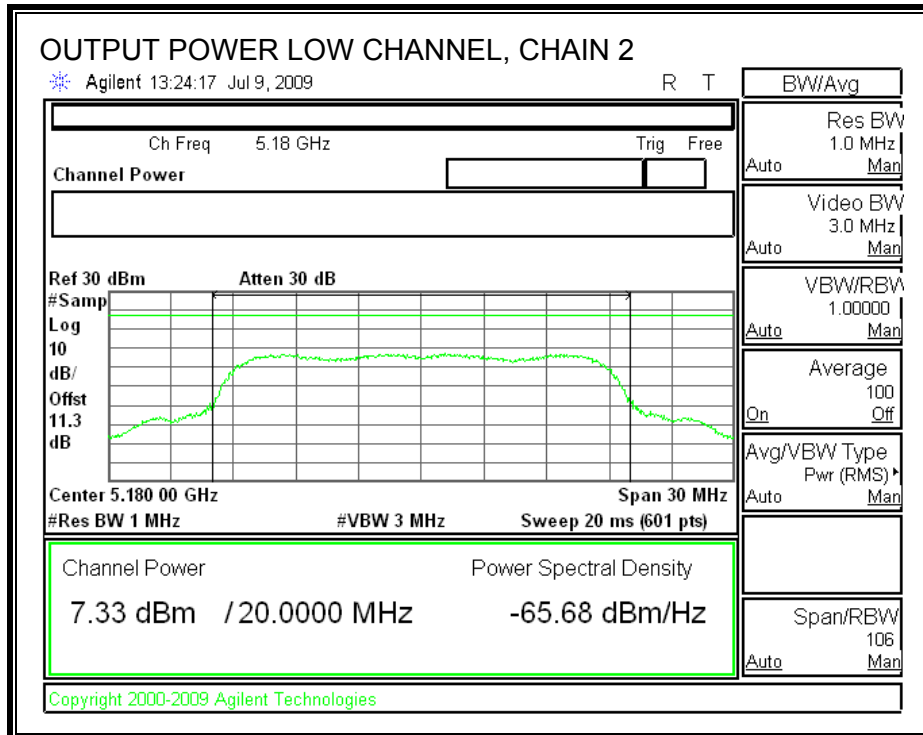

OUTPUT POWER, MID CHANNEL

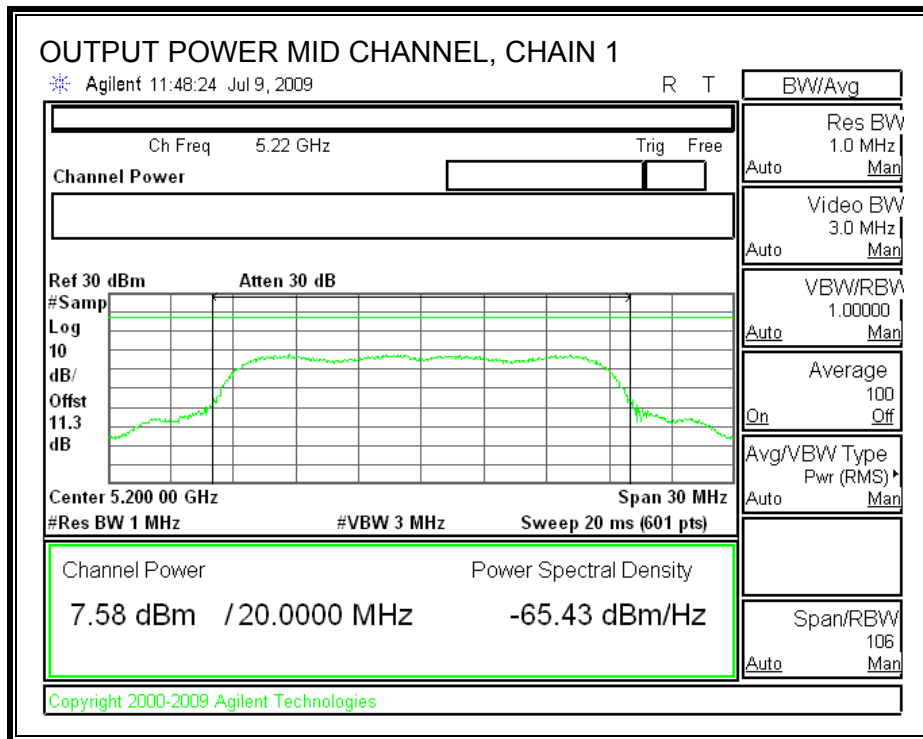
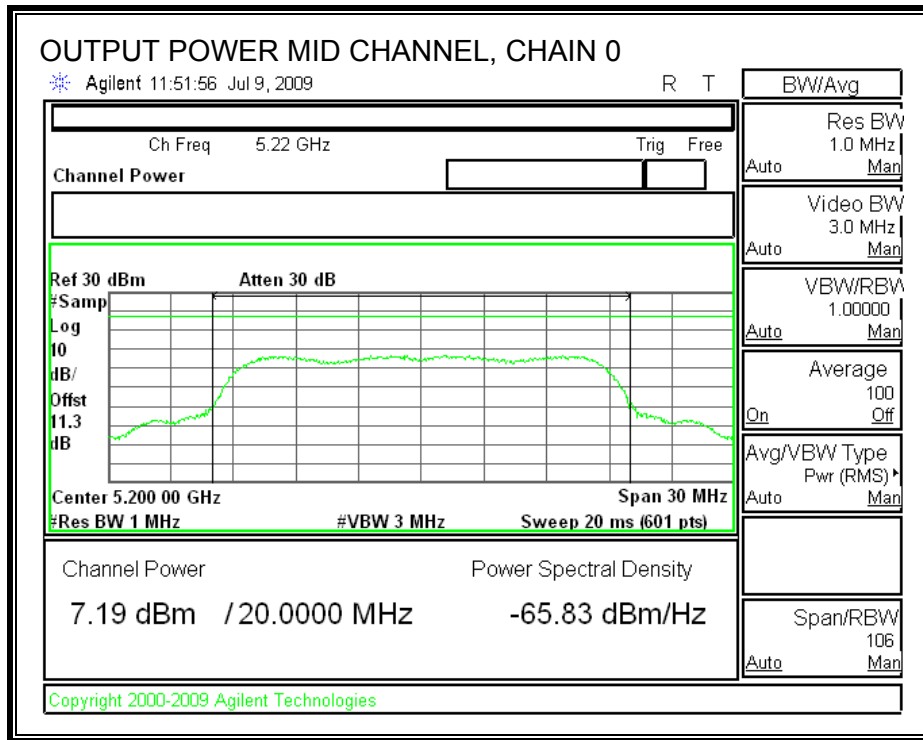

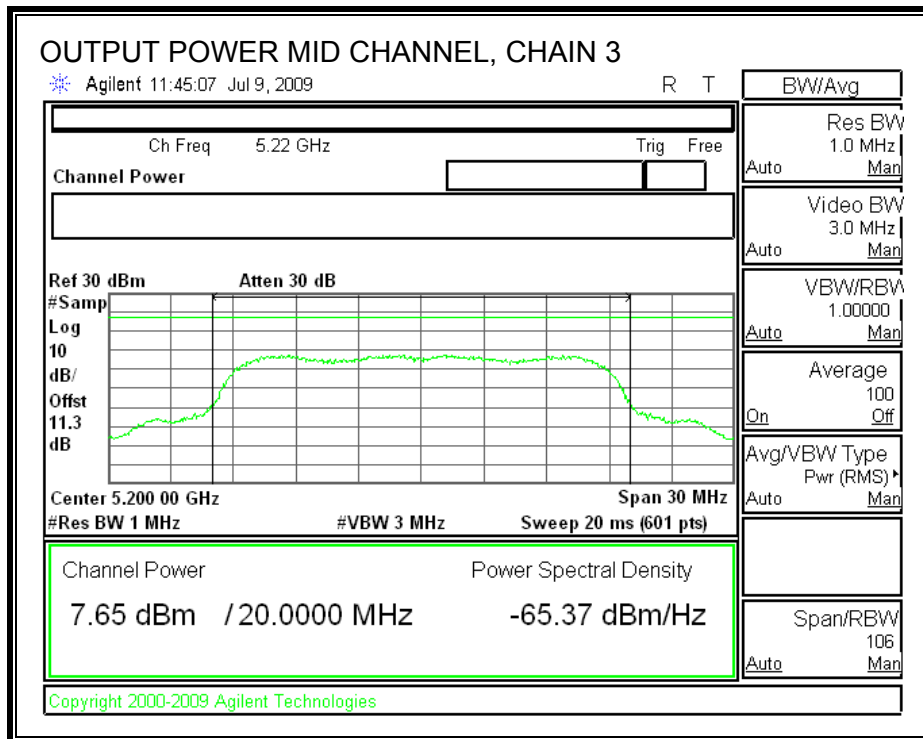
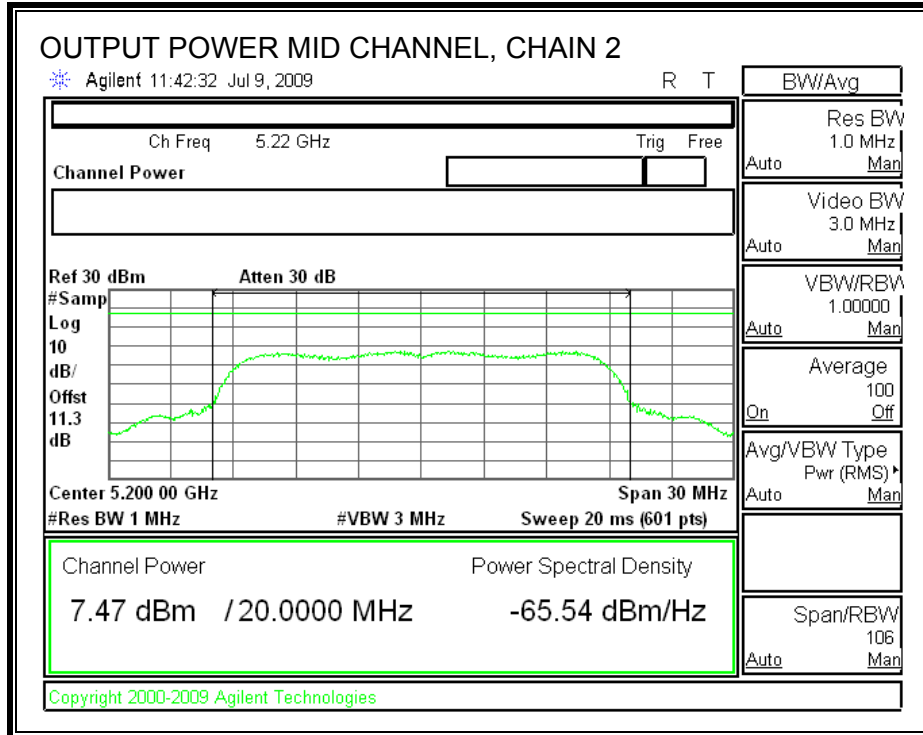

OUTPUT POWER, HIGH CHANNEL

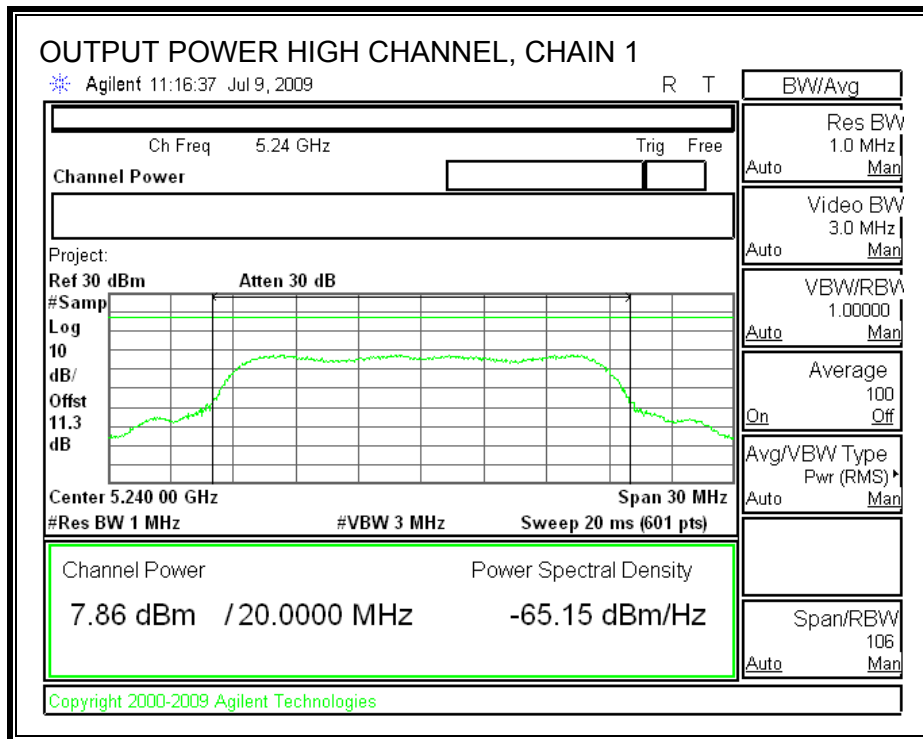
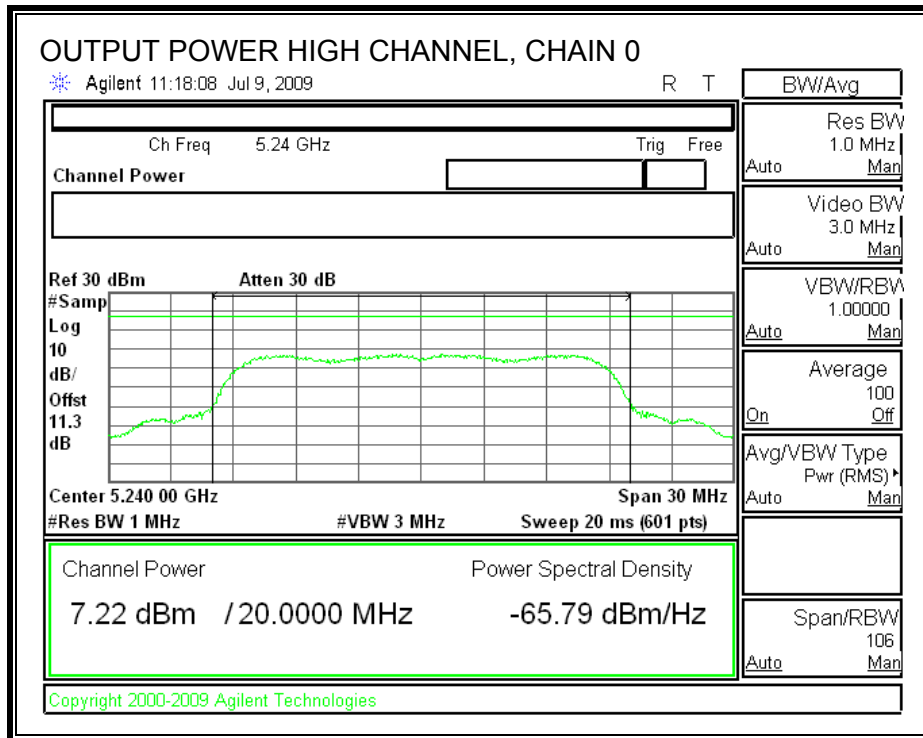

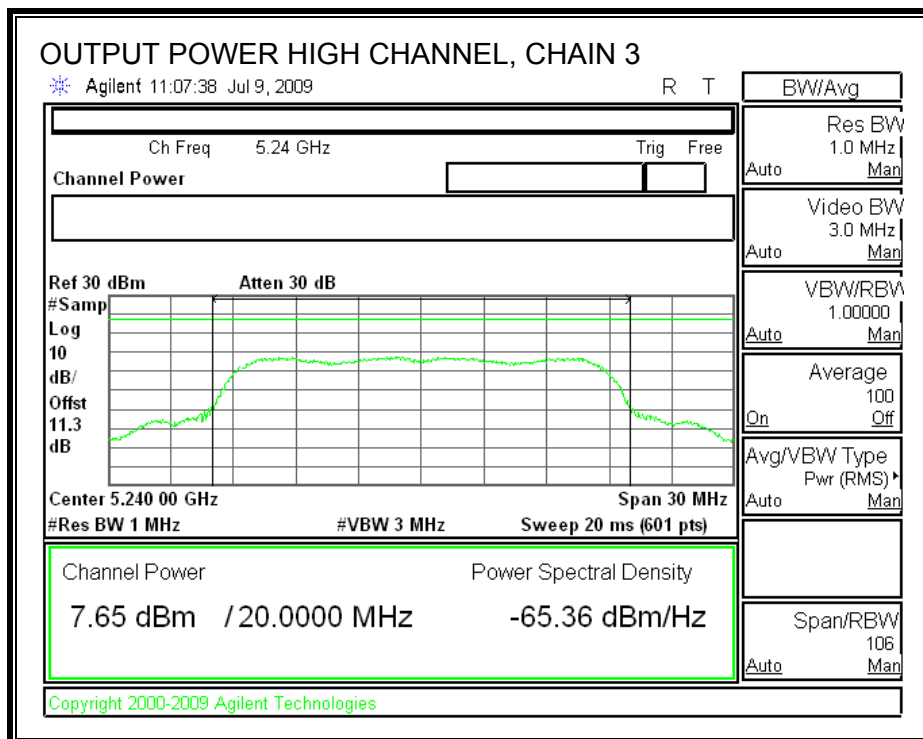
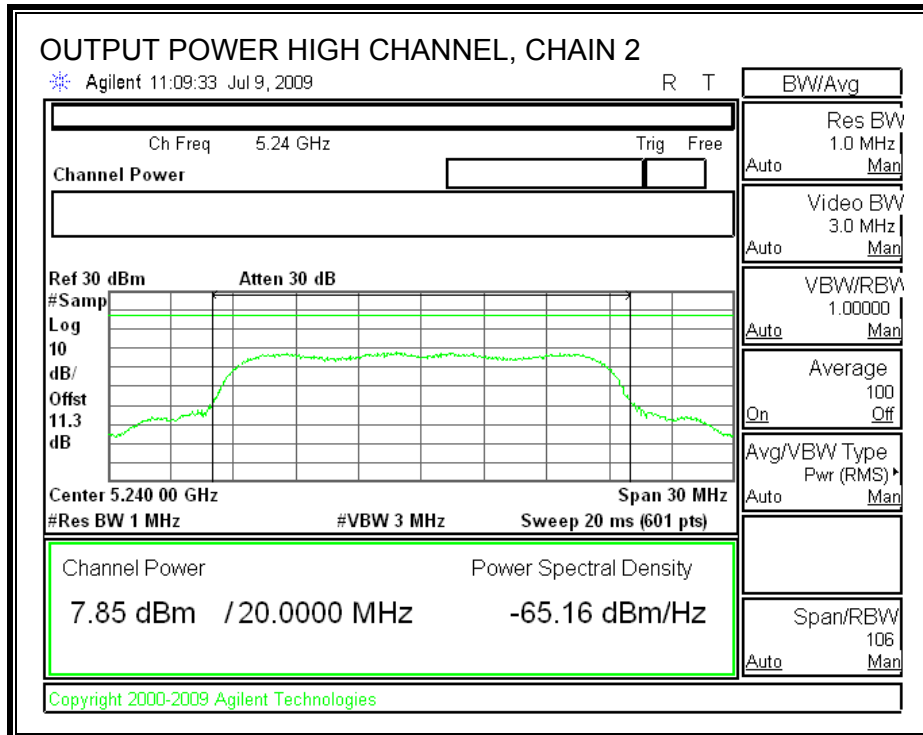

7.2.3. AVERAGE POWER

LIMITS

None; for reporting purposes only.

TEST PROCEDURE

The transmitter output is connected to a power meter.

The cable assembly insertion loss of 11.3 dB (including 10 dB pad and 1.3 dB cable) was entered as an offset in the power meter to allow for direct reading of power.

RESULTS

Channel	Frequency (MHz)	Chain 0 Power (dBm)	Chain 1 Power (dBm)	Chain 2 Power (dBm)	Chain 3 Power (dBm)
Low	5180	7.41	7.51	7.69	7.89
Middle	5200	7.11	8.23	8.01	8.05
High	5240	7.82	7.85	8.04	8.11

7.2.4. PEAK POWER SPECTRAL DENSITY

LIMITS

FCC §15.407 (a) (2)

IC RSS-210 A9.2 (2)

For the 5.15-5.25 GHz band, the peak power spectral density shall not exceed 4 dBm in any 1 MHz band. If transmitting antennas of directional gain greater than 6 dBi are used, both the peak transmit power and the peak power spectral density shall be reduced by the amount in dB that the directional gain of the antenna exceeds 6 dBi.

The maximum antenna gain is less than 6 dBi, therefore the limit is 4 dBm.

TEST PROCEDURE

The test is performed in accordance with FCC Public Notice: APPENDIX A Guidelines for Assessing Unlicensed National Information Infrastructure (U-NII) Devices – Part 15, Subpart E, August 2002. PPSD method #2 was used.

Preliminary tests on individual chains, and on all chains with a combiner, were performed. The worst-case configuration was with a combiner, therefore final test were performed with all chains feeding a combiner.

RESULTS

Channel	Frequency (MHz)	PSD with Combiner (dBm)	Limit (dBm)	Margin (dB)
Low	5180	3.43	4	-0.58
Middle	5200	3.85	4	-0.15
High	5240	3.65	4	-0.35

POWER SPECTRAL DENSITY

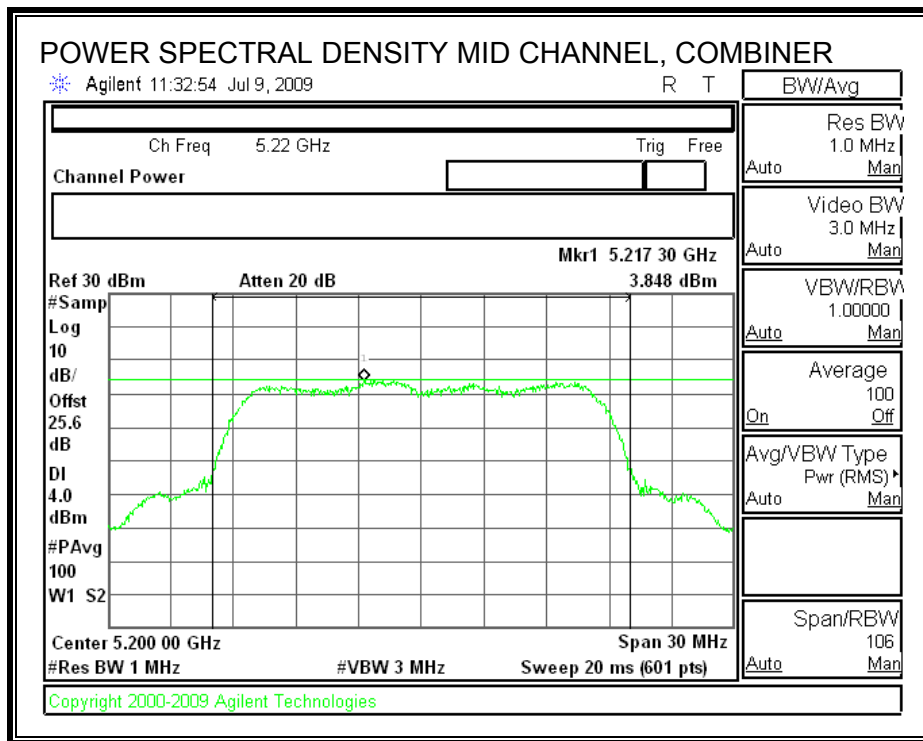
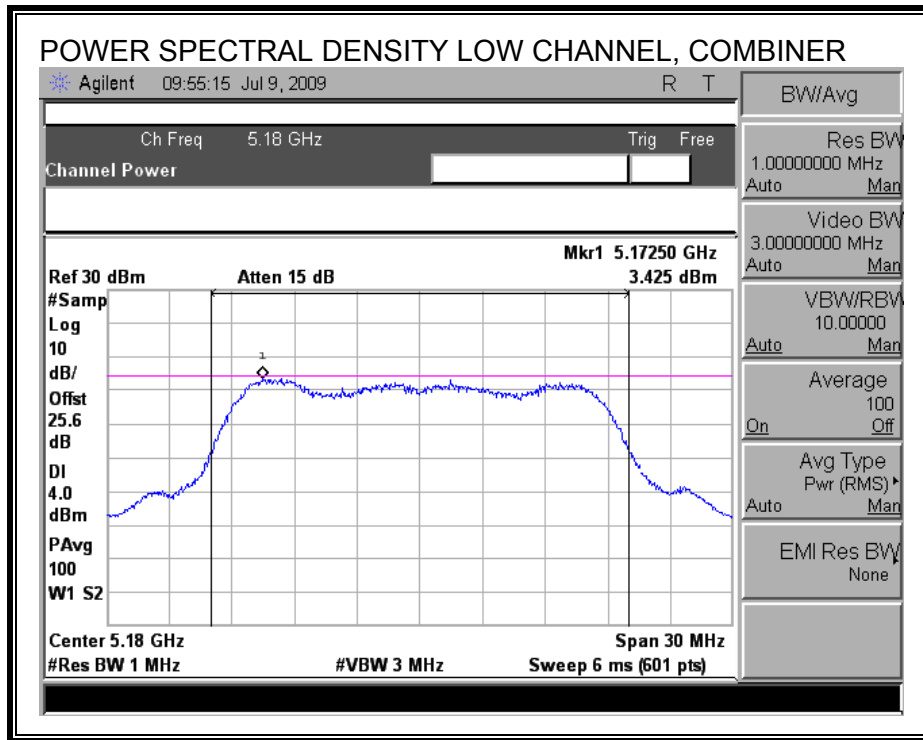

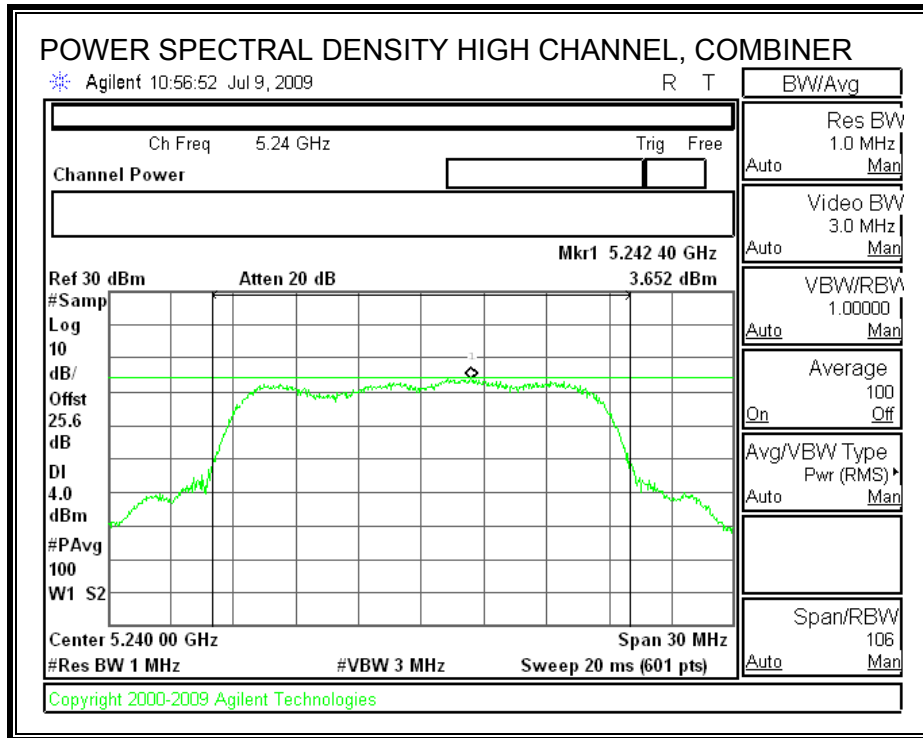

7.2.5. PEAK EXCURSION

LIMITS

FCC §15.407 (a) (6)

The ratio of the peak excursion of the modulation envelope (measured using a peak hold function) to the peak transmit power (measured as specified above) shall not exceed 13 dB across any 1 MHz bandwidth or the emission bandwidth whichever is less.

TEST PROCEDURE

The transmitter outputs are connected to the spectrum analyzer via a combiner.

The test is performed in accordance with FCC Public Notice: APPENDIX A Guidelines for Assessing Unlicensed National Information Infrastructure (U-NII) Devices – Part 15, Subpart E, August 2002.

Since Method # 1 was used for peak power measurements, Method # 1 settings are used for the second PPSD trace.

RESULTS

Channel	Frequency (MHz)	Peak Excursion (dB)	Limit (dB)	Margin (dB)
Low	5180	9.15	13	-3.85
Middle	5200	10.29	13	-2.71
High	5240	11.12	13	-1.88

PEAK EXCURSION

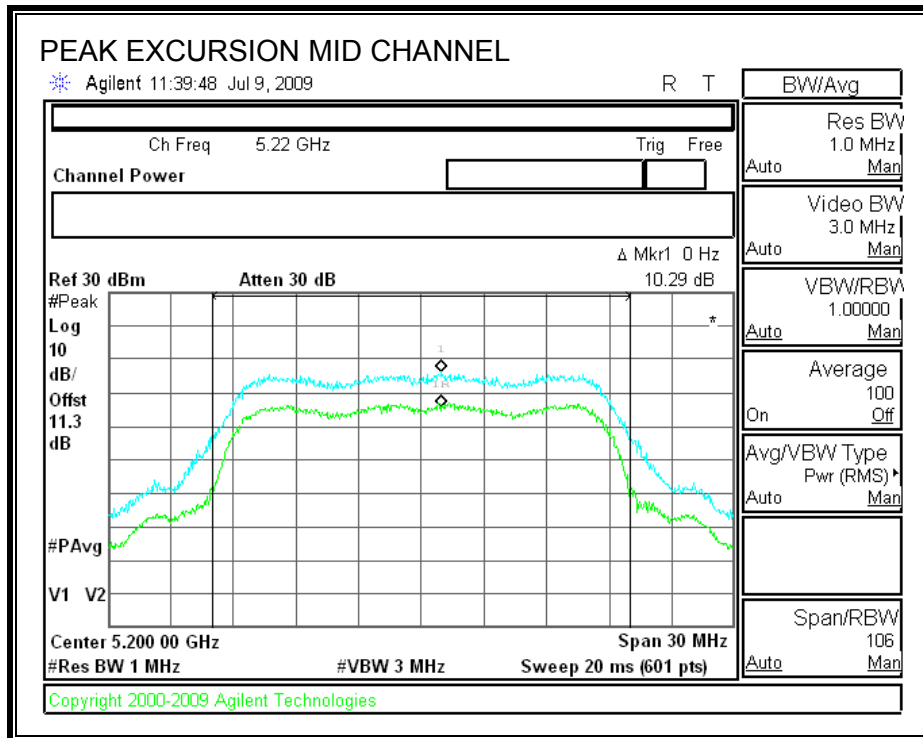
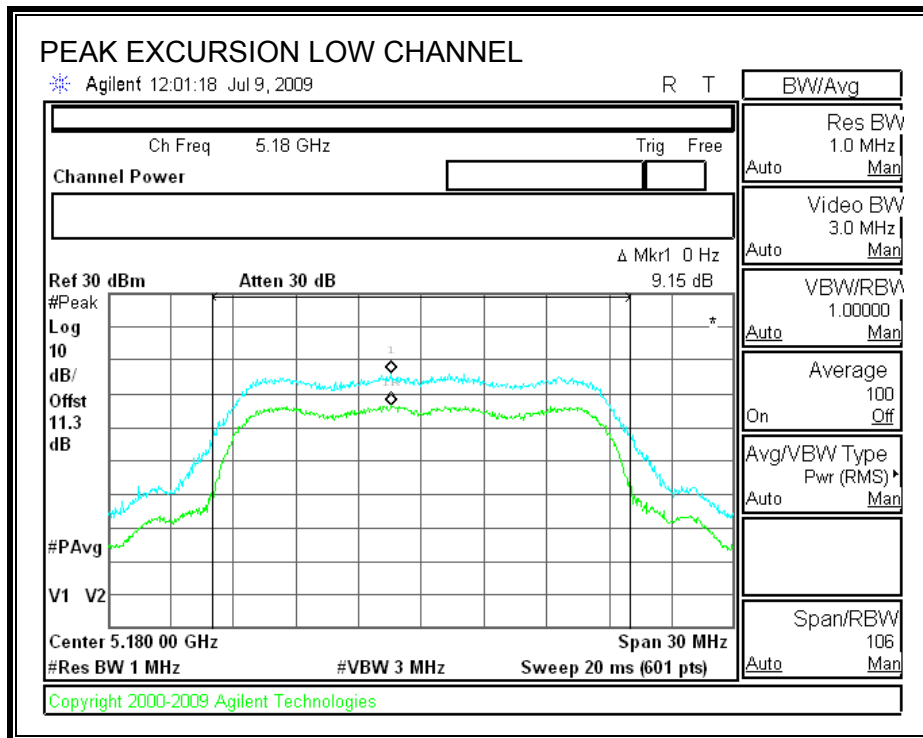

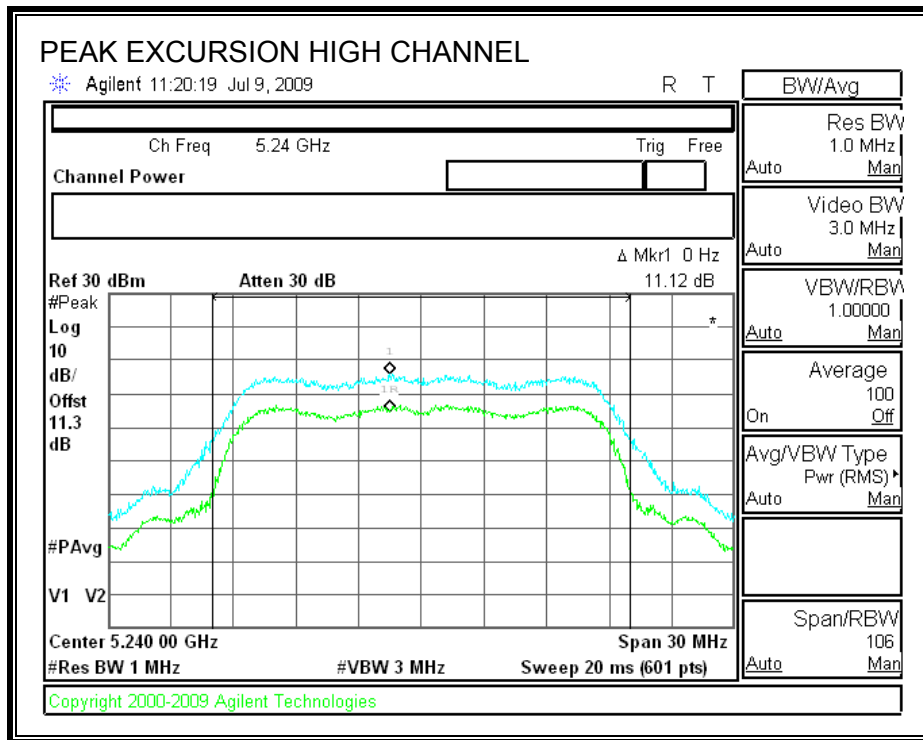

7.2.6. CONDUCTED SPURIOUS EMISSIONS

LIMITS

FCC §15.407 (b) (3)

IC RSS-210 A9.3 (3)

For transmitters operating in the 5.15-5.25 GHz band: all emissions outside of the 5.15-5.35 GHz band shall not exceed an EIRP of -27 dBm / MHz.

TEST PROCEDURE

Conducted RF measurements of the transmitter output are made to confirm that the EUT antenna port conducted emissions meet the specified limit and to identify any spurious signals that require further investigation or measurements on the radiated emissions site.

The transmitter output is connected to the spectrum analyzer. The resolution bandwidth is set to 1 MHz. The video bandwidth is set to 1 MHz. Peak detection measurements are compared to EIRP limit, adjusted for the maximum antenna gain.

Measurements are made over the 30 MHz to 40 GHz range with the transmitter set to the lowest, middle, and highest channels.

Preliminary tests on individual chains, and on all chains with a combiner, were performed. The worst-case configuration was with a combiner, therefore final test were performed with all chains feeding a combiner.

LOW CHANNEL SPURIOUS EMISSIONS

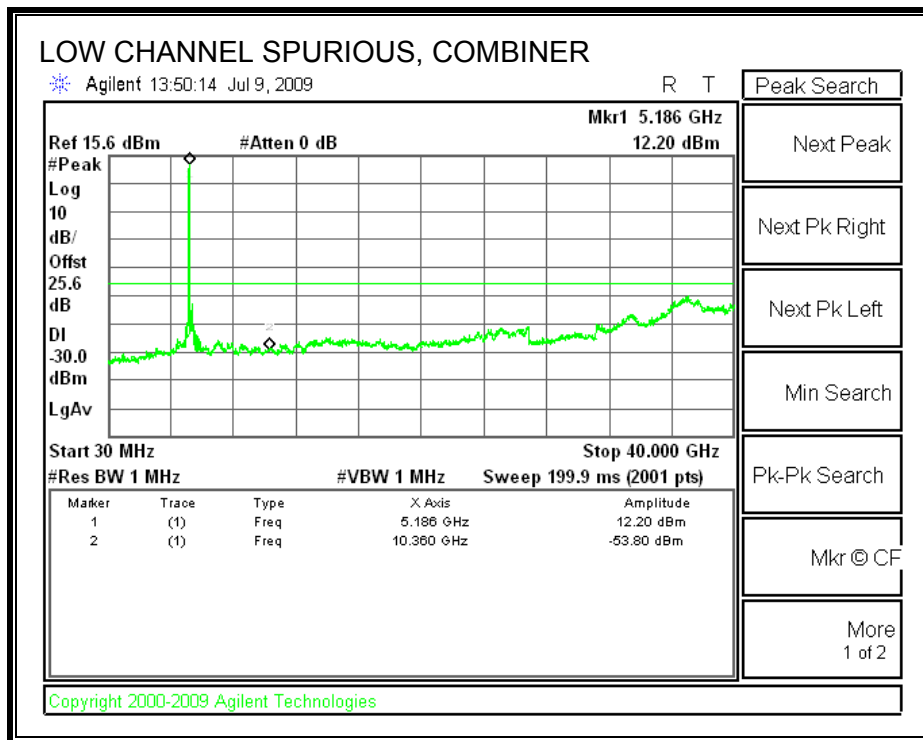

MID CHANNEL SPURIOUS EMISSIONS

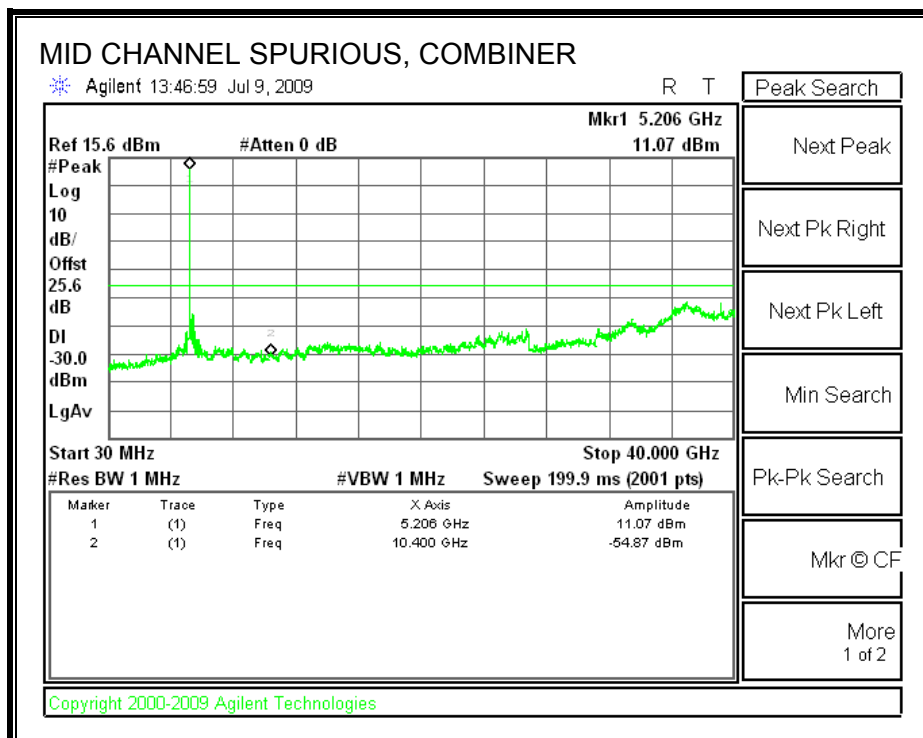

HIGH CHANNEL SPURIOUS EMISSIONS

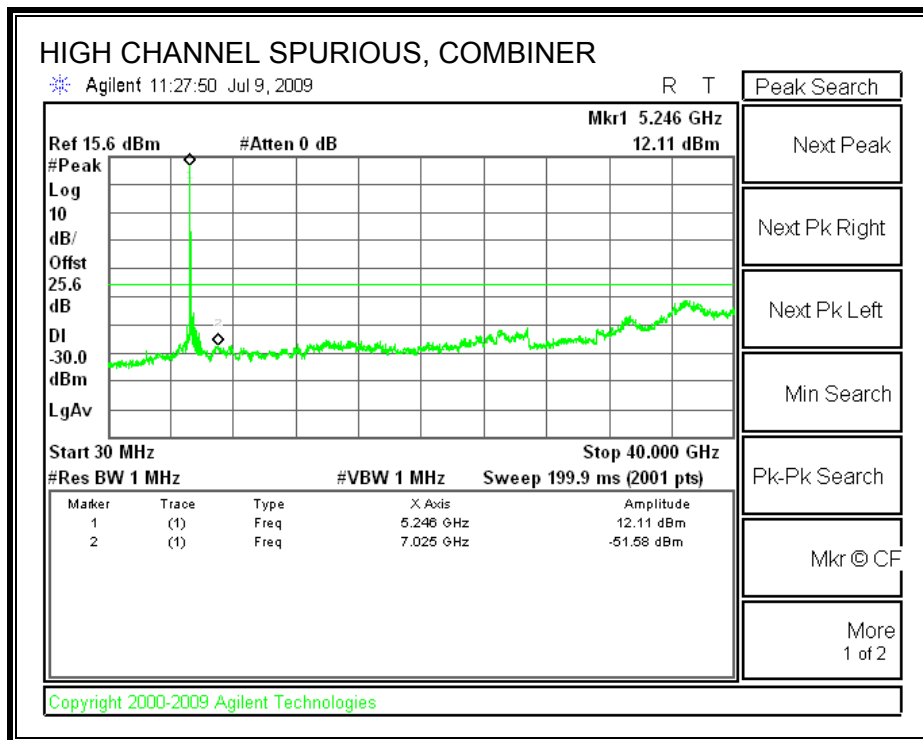

7.3. 5.2 GHz BAND CHANNEL TESTS FOR 802.11n HT40 MODE

7.3.1. 99% & 26 dB BANDWIDTH

LIMITS

None; for reporting purposes only.

TEST PROCEDURE

The transmitter output is connected to the spectrum analyzer. The RBW is set to 1% to 3% of the bandwidth. The VBW is set to 3 times the RBW. The sweep time is coupled. The spectrum analyzer internal bandwidth measurement function is utilized.

RESULTS

Channel	Frequency (MHz)	99% OBW (MHz)	26 dB BW (MHz)
Low	5190	35.7089	37.585
High	5230	35.8965	38.251

99% & 26 dB BANDWIDTH

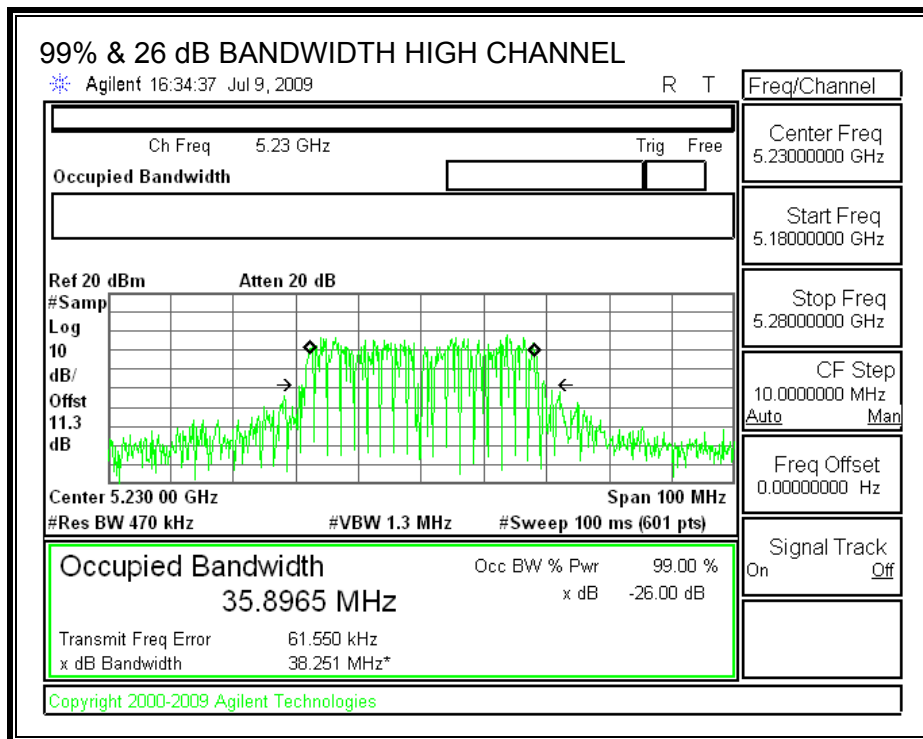
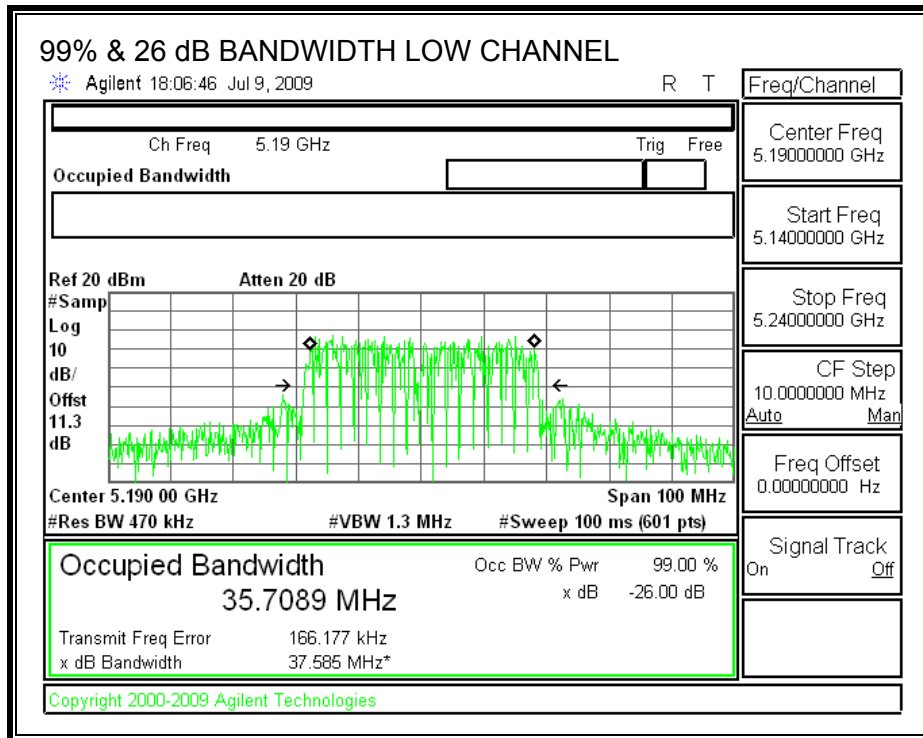

7.3.2. OUTPUT POWER

LIMITS

FCC §15.407 (a) (2)

IC RSS-210 A9.2 (2)

For the 5.15-5.25 GHz band, the maximum conducted output power over the frequency band of operation shall not exceed the lesser of 50 mW or 4 dBm + 10 log B, where B is the 26-dB emission bandwidth in MHz. If transmitting antennas of directional gain greater than 6 dBi are used, both the peak transmit power and the peak power spectral density shall be reduced by the amount in dB that the directional gain of the antenna exceeds 6 dBi.

TEST PROCEDURE

The test is performed in accordance with FCC Public Notice: APPENDIX A Guidelines for Assessing Unlicensed National Information Infrastructure (U-NII) Devices – Part 15, Subpart E, August 2002.

The transmitter output operates continuously therefore Method # 1 is used.

RESULTS

Limit

Channel	Freq (MHz)	Fixed Limit (dBm)	B (MHz)	4 + 10 Log B Limit (dBm)	Antenna Gain (dBi)	Limit (dBm)
Low	5190	17	37.585	19.75	3	17.00
High	5230	17	38.251	19.83	3	17.00

Individual Chain Results

Channel	Freq (MHz)	Chain 0 Power (dBm)	Chain 1 Power (dBm)	Chain 2 Power (dBm)	Chain 3 Power (dBm)	Total Power (dBm)	Limit (dBm)	Margin (dB)
Low	5190	10.67	11.14	10.86	10.75	16.88	17.00	-0.12
High	5230	10.47	10.82	10.71	10.84	16.73	17.00	-0.27

OUTPUT POWER, LOW CHANNEL

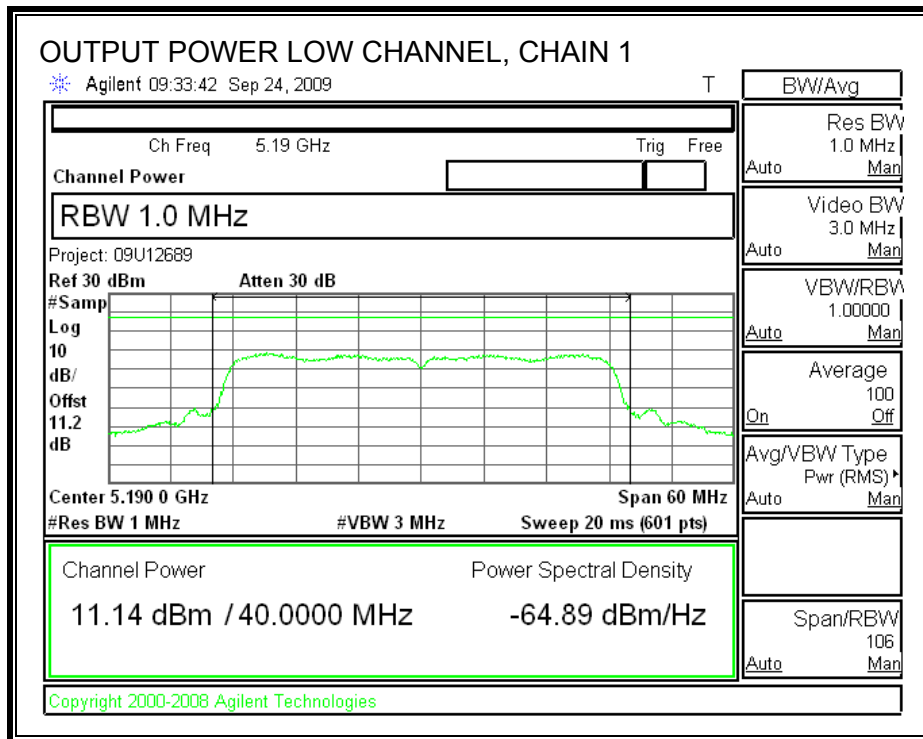
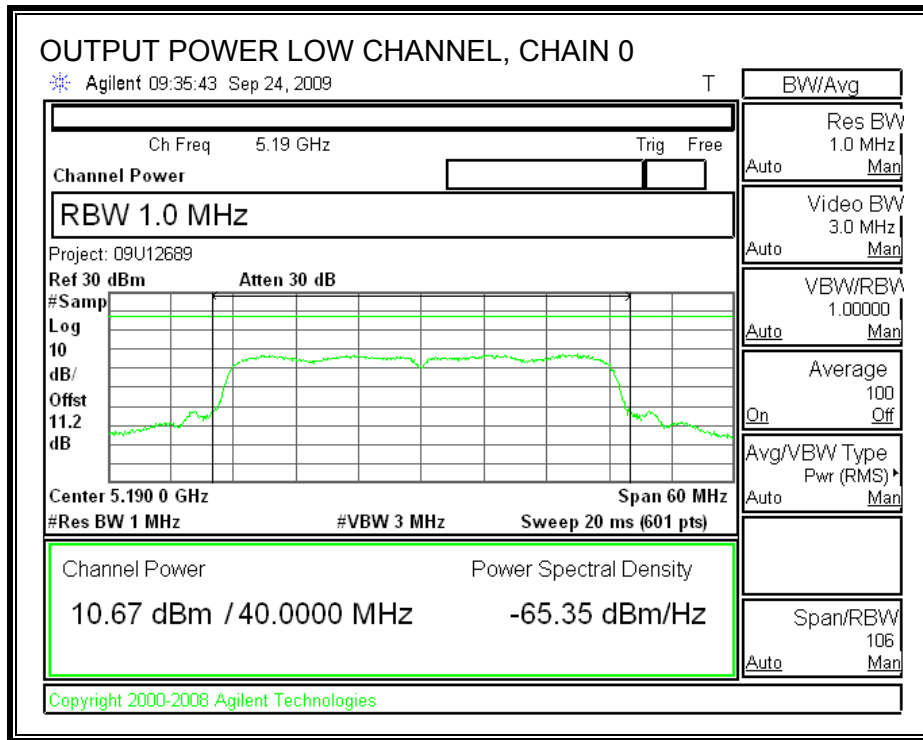

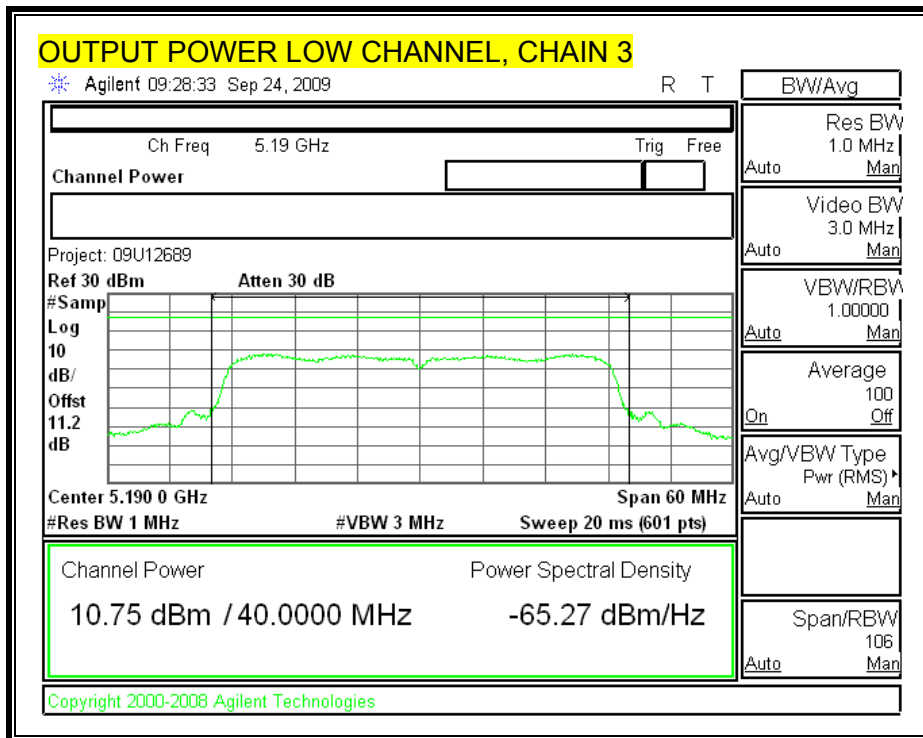
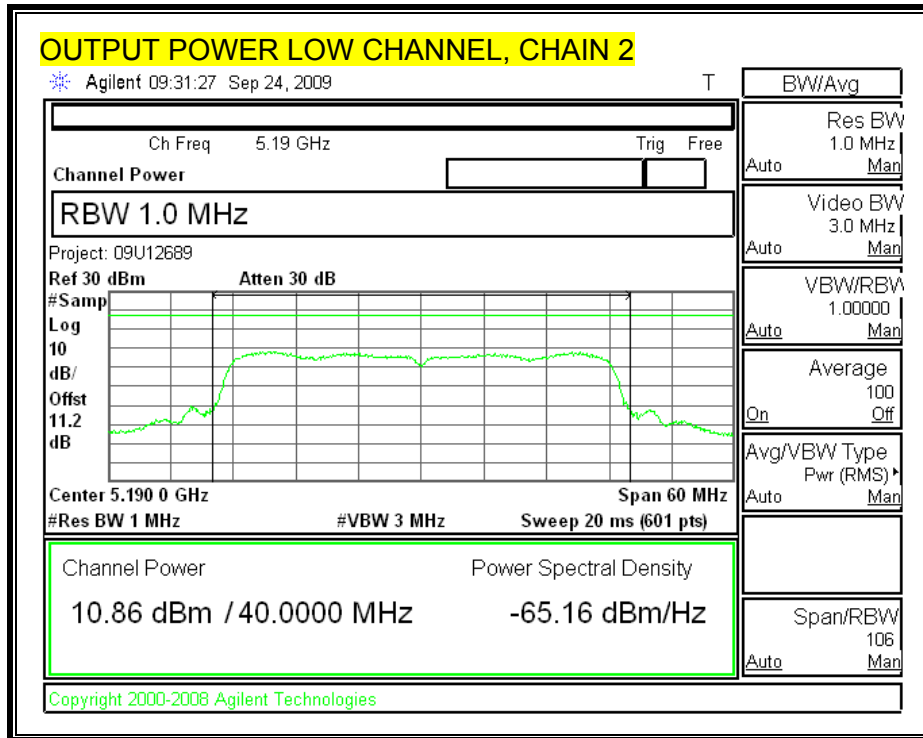

OUTPUT POWER, HIGH CHANNEL

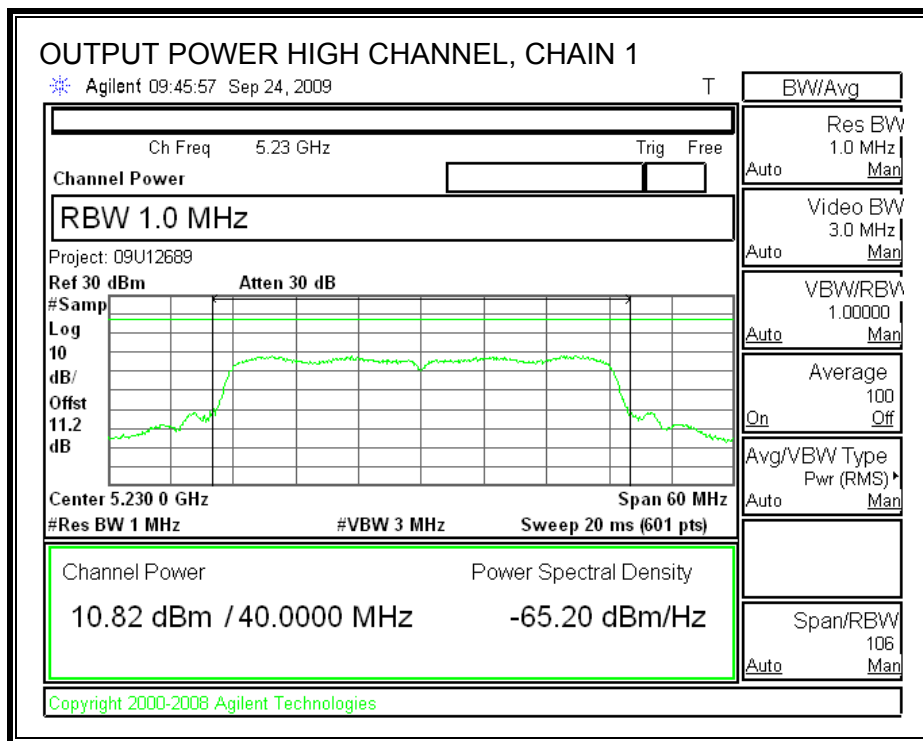
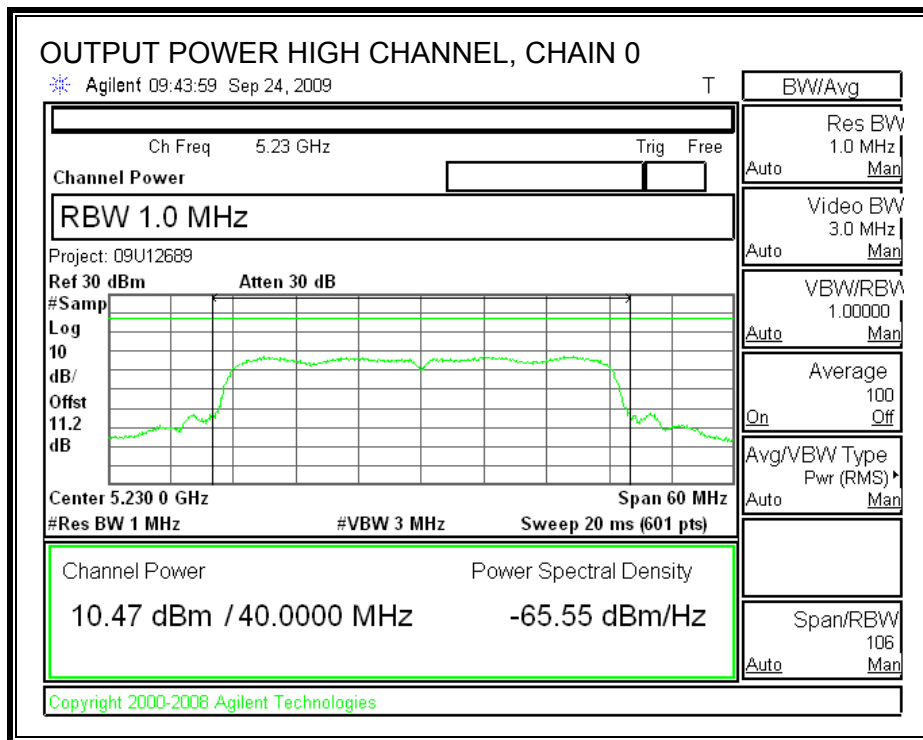

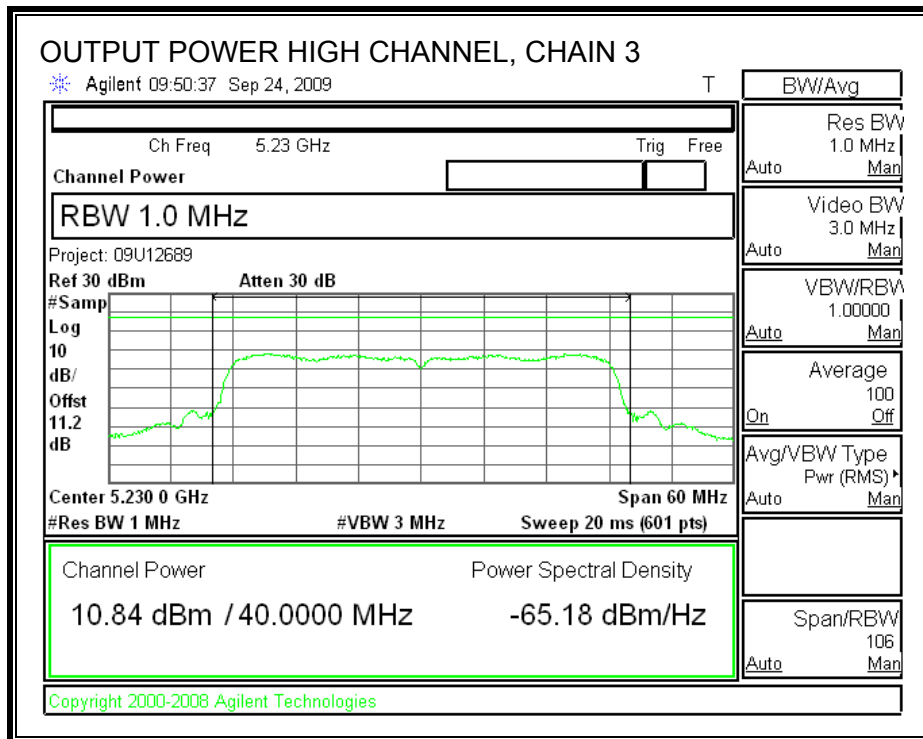
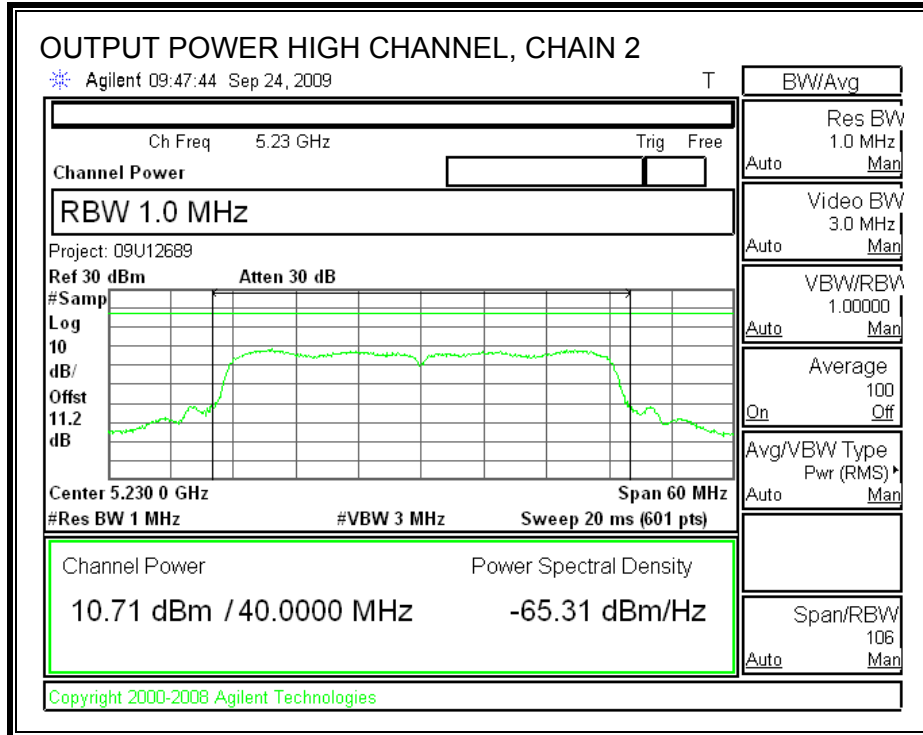

7.3.3. AVERAGE POWER

LIMITS

None; for reporting purposes only.

TEST PROCEDURE

The transmitter output is connected to a power meter.

The cable assembly insertion loss of 11.3 dB (including 10 dB pad and 1.3 dB cable) was entered as an offset in the power meter to allow for direct reading of power.

RESULTS

Channel	Frequency (MHz)	Chain 0 Power (dBm)	Chain 1 Power (dBm)	Chain 2 Power (dBm)	Chain 3 Power (dBm)
Low	5190	10.48	11.32	11.08	11.40
High	5230	10.98	11.25	11.31	11.40

7.3.4. PEAK POWER SPECTRAL DENSITY

LIMITS

FCC §15.407 (a) (2)

IC RSS-210 A9.2 (2)

For the 5.15-5.25 GHz band, the peak power spectral density shall not exceed 4 dBm in any 1 MHz band. If transmitting antennas of directional gain greater than 6 dBi are used, both the peak transmit power and the peak power spectral density shall be reduced by the amount in dB that the directional gain of the antenna exceeds 6 dBi.

The maximum antenna gain is less than 6 dBi, therefore the limit is 4 dBm.

TEST PROCEDURE

The test is performed in accordance with FCC Public Notice: APPENDIX A Guidelines for Assessing Unlicensed National Information Infrastructure (U-NII) Devices – Part 15, Subpart E, August 2002. PPSD method #2 was used.

Preliminary tests on individual chains, and on all chains with a combiner, were performed. The worst-case configuration was with a combiner, therefore final test were performed with all chains feeding a combiner.

RESULTS

Channel	Frequency (MHz)	PSD with Combiner (dBm)	Limit (dBm)	Margin (dB)
Low	5190	3.56	4	-0.44
High	5230	3.59	4	-0.41

POWER SPECTRAL DENSITY

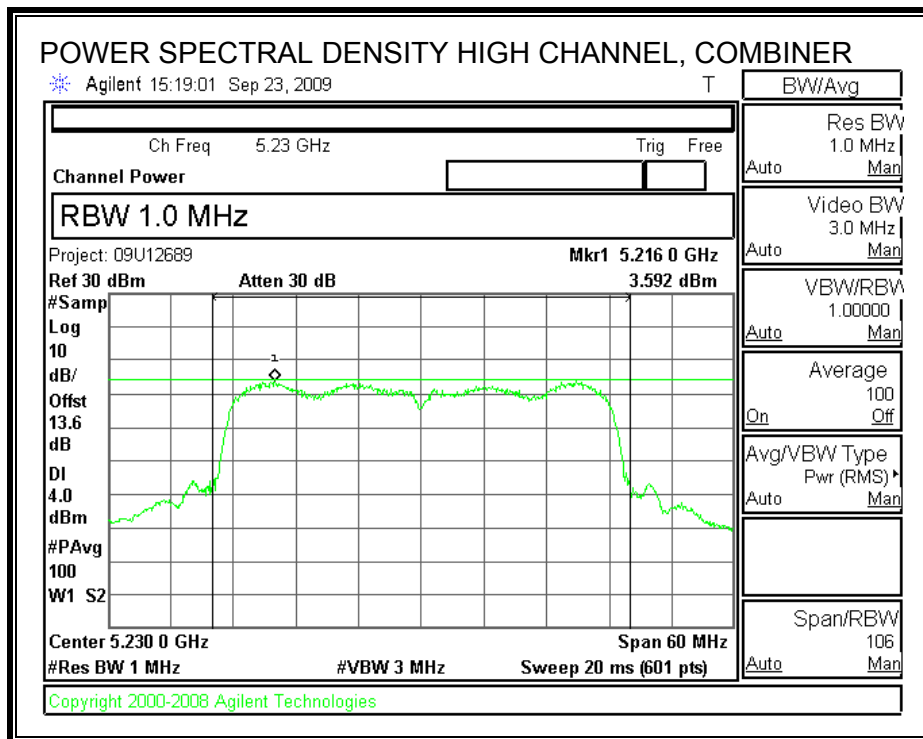
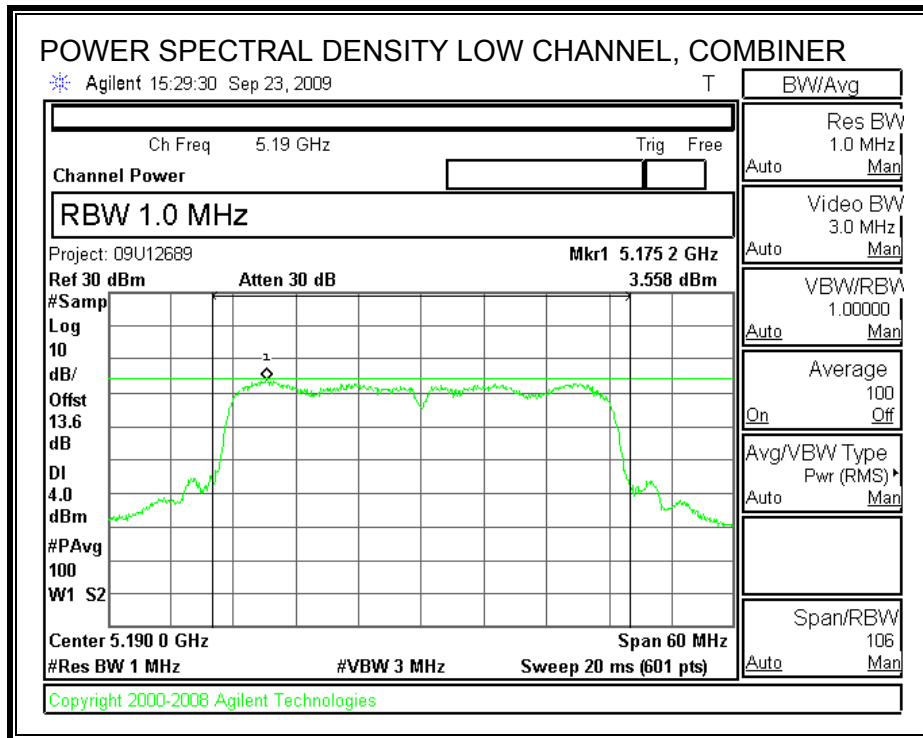

7.3.5. PEAK EXCURSION

LIMITS

FCC §15.407 (a) (6)

The ratio of the peak excursion of the modulation envelope (measured using a peak hold function) to the peak transmit power (measured as specified above) shall not exceed 13 dB across any 1 MHz bandwidth or the emission bandwidth whichever is less.

TEST PROCEDURE

The transmitter outputs are connected to the spectrum analyzer via a combiner.

The test is performed in accordance with FCC Public Notice: APPENDIX A Guidelines for Assessing Unlicensed National Information Infrastructure (U-NII) Devices – Part 15, Subpart E, August 2002.

Since Method # 1 was used for peak power measurements, Method # 1 settings are used for the second PPSD trace.

RESULTS

Channel	Frequency (MHz)	Peak Excursion (dB)	Limit (dB)	Margin (dB)
Low	5190	10.24	13	-2.76
High	5230	10.17	13	-2.83

PEAK EXCURSION

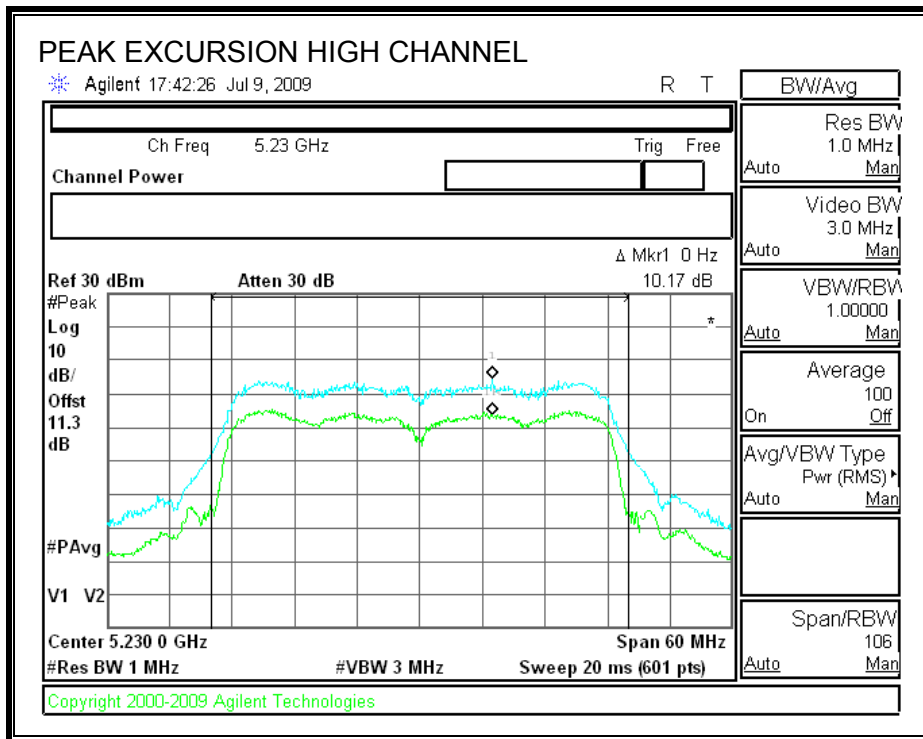
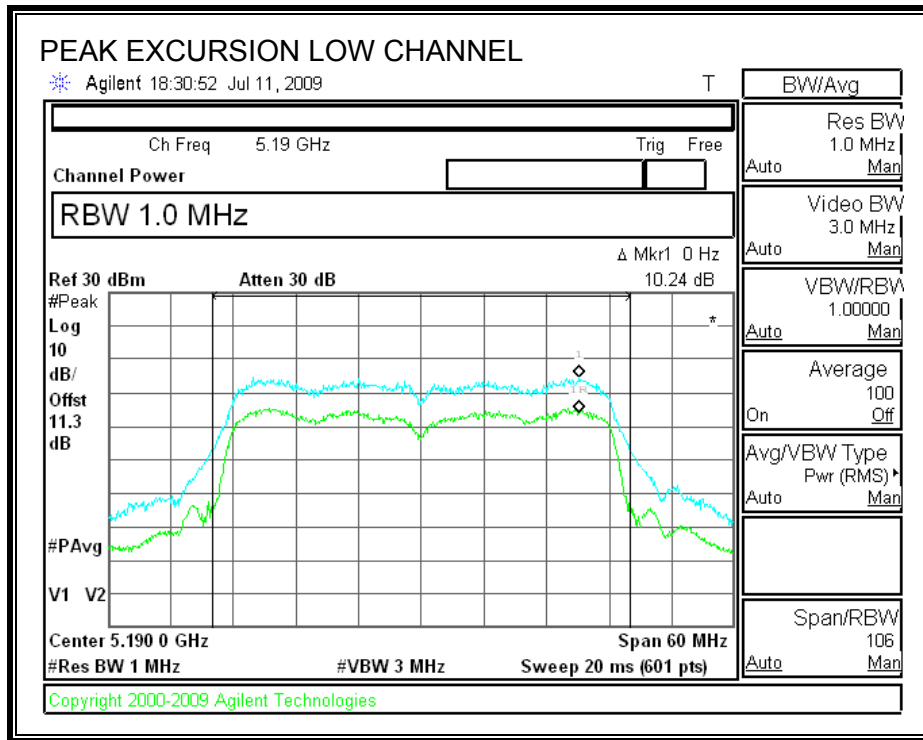

7.3.6. CONDUCTED SPURIOUS EMISSIONS

LIMITS

FCC §15.407 (b) (3)

IC RSS-210 A9.3 (3)

For transmitters operating in the 5.15-5.25 GHz band: all emissions outside of the 5.15-5.35 GHz band shall not exceed an EIRP of -27 dBm / MHz.

TEST PROCEDURE

Conducted RF measurements of the transmitter output are made to confirm that the EUT antenna port conducted emissions meet the specified limit and to identify any spurious signals that require further investigation or measurements on the radiated emissions site.

The transmitter output is connected to the spectrum analyzer. The resolution bandwidth is set to 1 MHz. The video bandwidth is set to 1 MHz. Peak detection measurements are compared to EIRP limit, adjusted for the maximum antenna gain.

Measurements are made over the 30 MHz to 40 GHz range with the transmitter set to the lowest, middle, and highest channels.

Preliminary tests on individual chains, and on all chains with a combiner, were performed. The worst-case configuration was with a combiner, therefore final test were performed with all chains feeding a combiner.

LOW CHANNEL SPURIOUS EMISSIONS

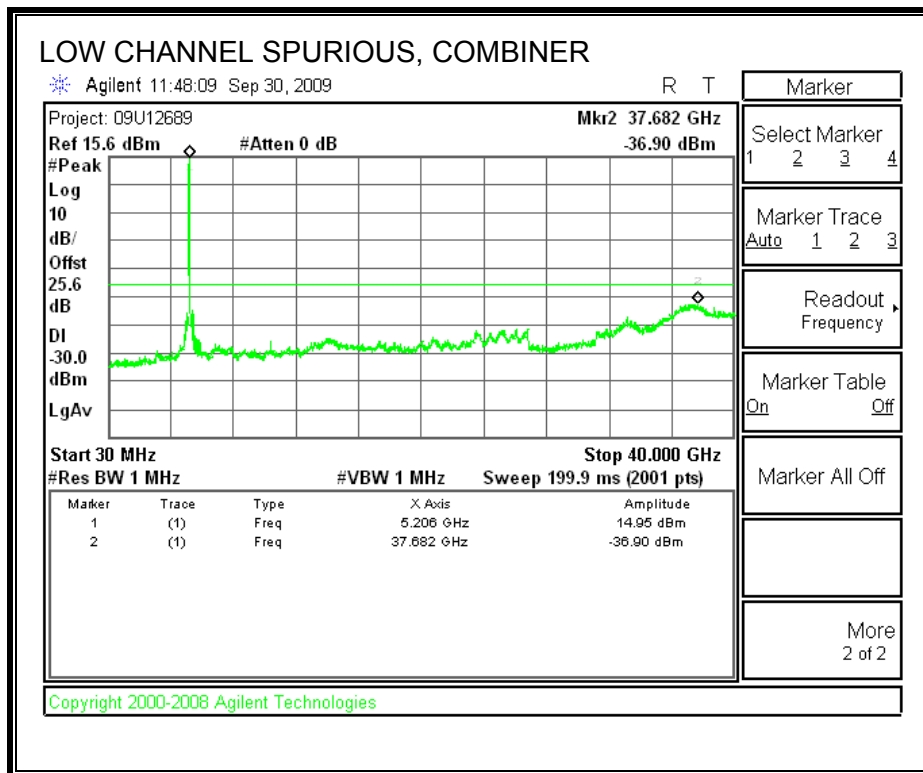

HIGH CHANNEL SPURIOUS EMISSIONS

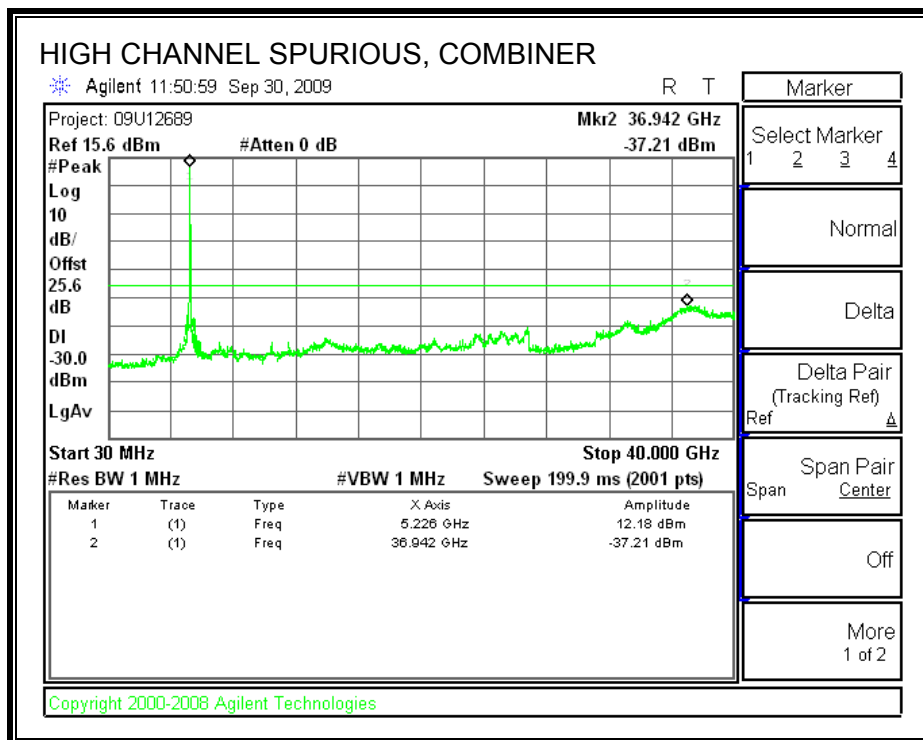

7.4. RECEIVER CONDUCTED SPURIOUS EMISSIONS

LIMITS

IC RSS-GEN 7.2.3.1

Antenna Conducted Measurement: Receiver spurious emissions at any discrete frequency shall not exceed 2 nanowatts (-57 dBm) in the band 30-1000 MHz, or 5 nanowatts (-53 dBm) above 1 GHz.

TEST PROCEDURE

IC RSS-GEN 4.10, Conducted Method

The receiver antenna port is connected to a spectrum analyzer.

The spectrum from 30 MHz to 18 GHz is investigated with the receiver set to the middle channel of each 5 GHz band.

Preliminary tests on individual chains, and on all chains with a combiner, were performed. The worst-case configuration was with a combiner, therefore final test were performed with all chains feeding a combiner.

RECEIVER SPURIOUS EMISSIONS IN THE 5.2 GHz BAND

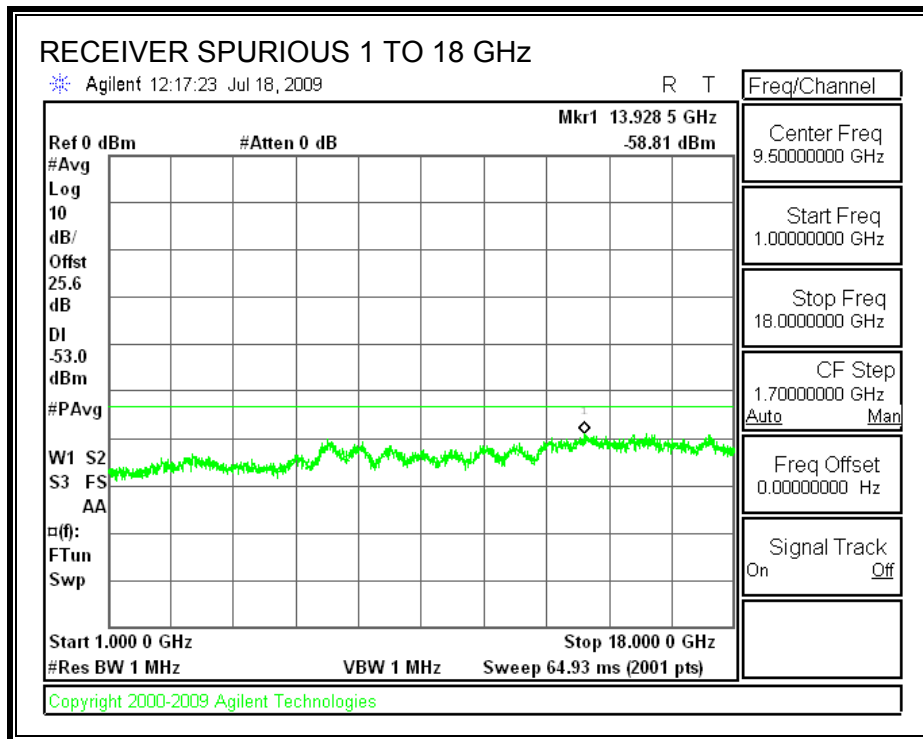
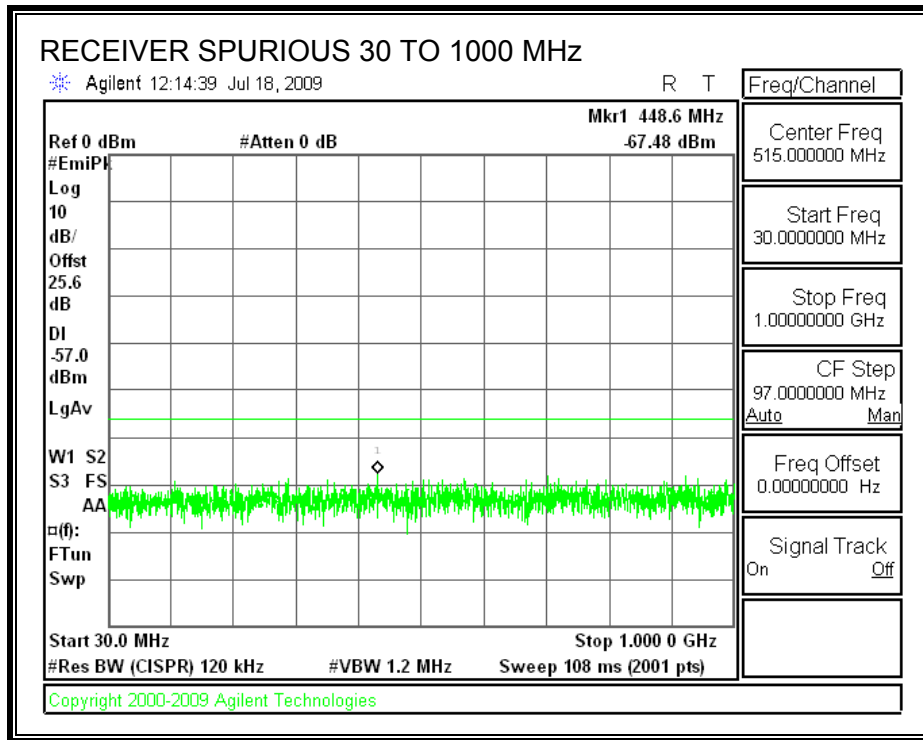

8. RADIATED TEST RESULTS

8.1. LIMITS AND PROCEDURE

LIMITS

FCC §15.205 and §15.209

IC RSS-210 Clause 2.6 (Transmitter)

IC RSS-GEN Clause 6 (Receiver)

Frequency Range (MHz)	Field Strength Limit (uV/m) at 3 m	Field Strength Limit (dBuV/m) at 3 m
30 - 88	100	40
88 - 216	150	43.5
216 - 960	200	46
Above 960	500	54

TEST PROCEDURE

The EUT is placed on a non-conducting table 80 cm above the ground plane. The antenna to EUT distance is 3 meters. The EUT is configured in accordance with ANSI C63.4. The EUT is set to transmit in a continuous mode.

For measurements below 1 GHz the resolution bandwidth is set to 100 kHz for peak detection measurements or 120 kHz for quasi-peak detection measurements. Peak detection is used unless otherwise noted as quasi-peak.

For measurements above 1 GHz the resolution bandwidth is set to 1 MHz, then the video bandwidth is set to 1 MHz for peak measurements and 10 Hz for average measurements.

The spectrum from 30 MHz to 40 GHz is investigated with the transmitter set to the lowest, middle, and highest channels in each applicable band.

The frequency range of interest is monitored at a fixed antenna height and EUT azimuth. The EUT is rotated through 360 degrees to maximize emissions received. The antenna is scanned from 1 to 4 meters above the ground plane to further maximize the emission. Measurements are made with the antenna polarized in both the vertical and the horizontal positions.

8.2. TRANSMITTER ABOVE 1 GHz

8.2.1. 802.11a MODE IN 5.2 GHz BAND

RESTRICTED BANDEDGE (LOW CHANNEL, VERTICAL)

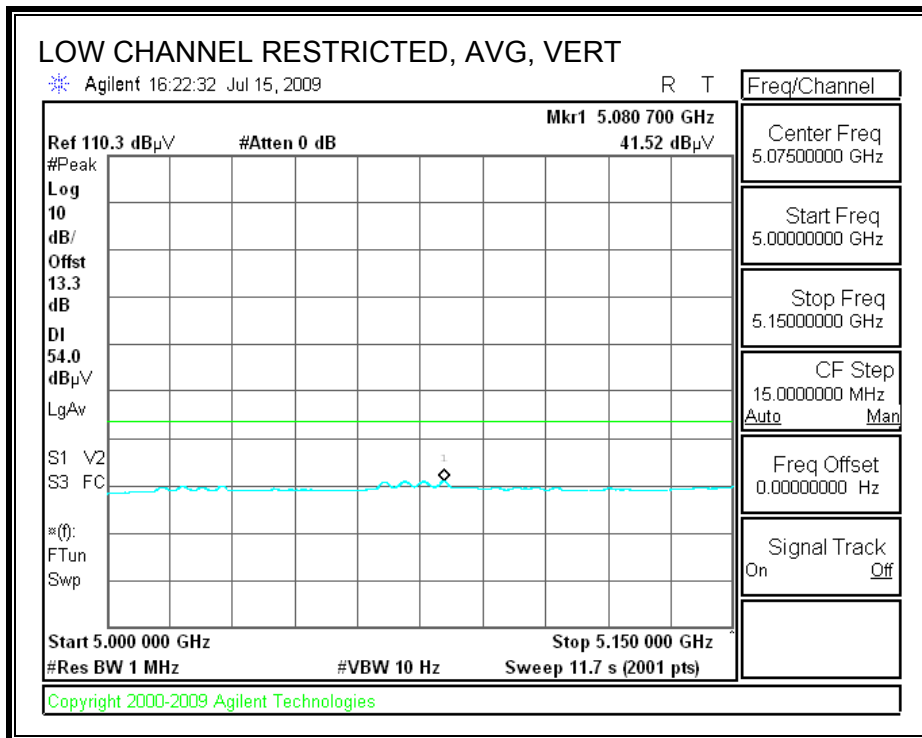
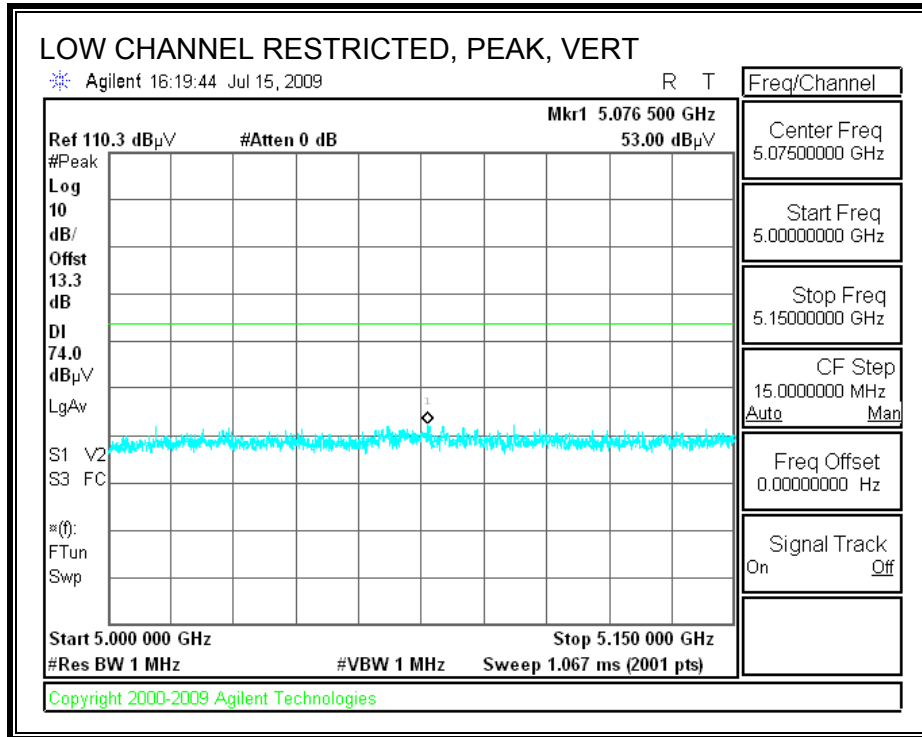

HARMONICS AND SPURIOUS EMISSIONS

High Frequency Measurement															
Compliance Certification Services, Fremont 5m Chamber															
Test Engr:		Thanh Nguyen													
Date:		07/15/09													
Project #:		09U12652													
Company:		QualComm													
EUT Description:		Ethernet card													
EUT M/N:		65-VN663-P2													
Test Target:		FCC 15.247/15.407													
Mode Oper:		Transmit													
f	Measurement Frequency			Amp	Preamp Gain			Average Field Strength Limit							
Dist	Distance to Antenna			D Corr	Distance Correct to 3 meters			Peak Field Strength Limit							
Read	Analyzer Reading			Avg	Average Field Strength @ 3 m			Margin vs. Average Limit							
AF	Antenna Factor			Peak	Calculated Peak Field Strength			Margin vs. Peak Limit							
CL	Cable Loss			HPF	High Pass Filter										
f GHz	Dist (m)	Read dBuV	AF dB/m	CL dB	Amp dB	D Corr dB	Filtr dB	Corr. dBuV/m	Limit dBuV/m	Margin dB	Ant. Pol. V/H	Det P/A/QP	Ant.High cm	Table Angle Degree	Notes
Low ch 5180															
15.540	3.0	35.8	38.7	11.3	-34.8	0.0	0.7	51.7	74.0	-22.3	V	P	147.8	304.8	
15.540	3.0	23.7	38.7	11.3	-34.8	0.0	0.7	39.6	54.0	-14.4	V	A	147.8	304.8	
15.540	3.0	34.6	38.7	11.3	-34.8	0.0	0.7	50.7	74.0	-24.7	H	P	156.5	346.0	
15.540	3.0	21.3	38.7	11.3	-34.8	0.0	0.7	37.2	54.0	-16.3	H	A	156.5	346.0	
Mid ch 5200															
15.600	3.0	37.1	38.5	11.4	-34.8	0.0	0.7	52.9	74.0	-21.1	V	P	147.8	296.5	
15.600	3.0	24.4	38.5	11.4	-34.8	0.0	0.7	40.2	54.0	-13.8	V	A	147.8	296.5	
15.600	3.0	37.1	38.5	11.4	-34.8	0.0	0.7	52.9	74.0	-21.1	H	P	150.5	300.0	
15.600	3.0	23.4	38.5	11.4	-34.8	0.0	0.7	39.4	54.0	-14.6	H	A	150.5	300.0	
High ch 5240															
15.720	3.0	36.6	38.2	11.4	-34.7	0.0	0.7	52.2	74.0	-21.8	V	P	166.9	200.0	
15.720	3.0	25.5	38.2	11.4	-34.7	0.0	0.7	41.2	54.0	-12.8	V	A	166.9	200.0	
15.720	3.0	36.4	38.2	11.4	-34.7	0.0	0.7	52.1	74.0	-21.9	H	P	140.6	310.0	
15.720	3.0	24.2	38.2	11.4	-34.7	0.0	0.7	39.8	54.0	-14.2	H	A	140.6	310.0	
Rev. 4.1.2.7															
Note: No other emissions were detected above the system noise floor.															

8.2.2. 802.11n HT20 MODE IN 5.2 GHz BAND

RESTRICTED BANEDGE (LOW CHANNEL, HORIZONTAL)

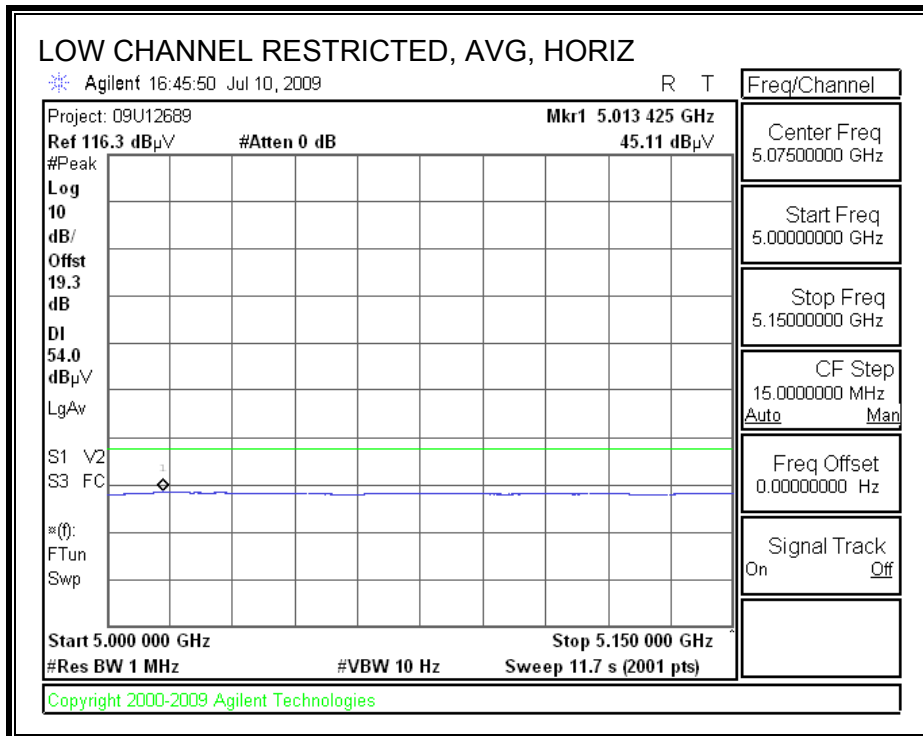
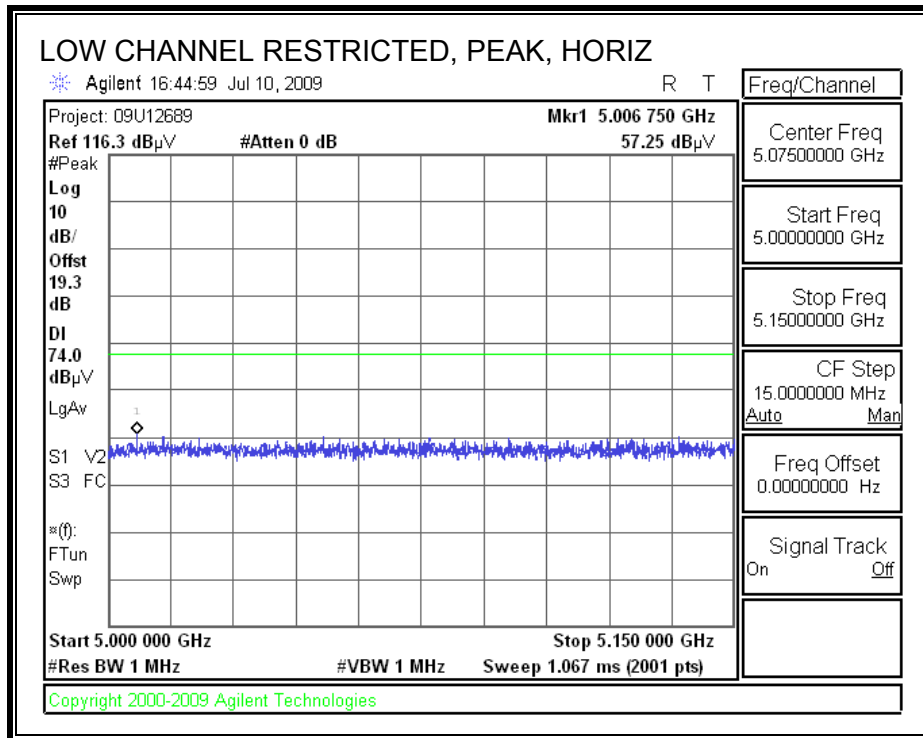

RESTRICTED BANDEDGE (LOW CHANNEL, VERTICAL)

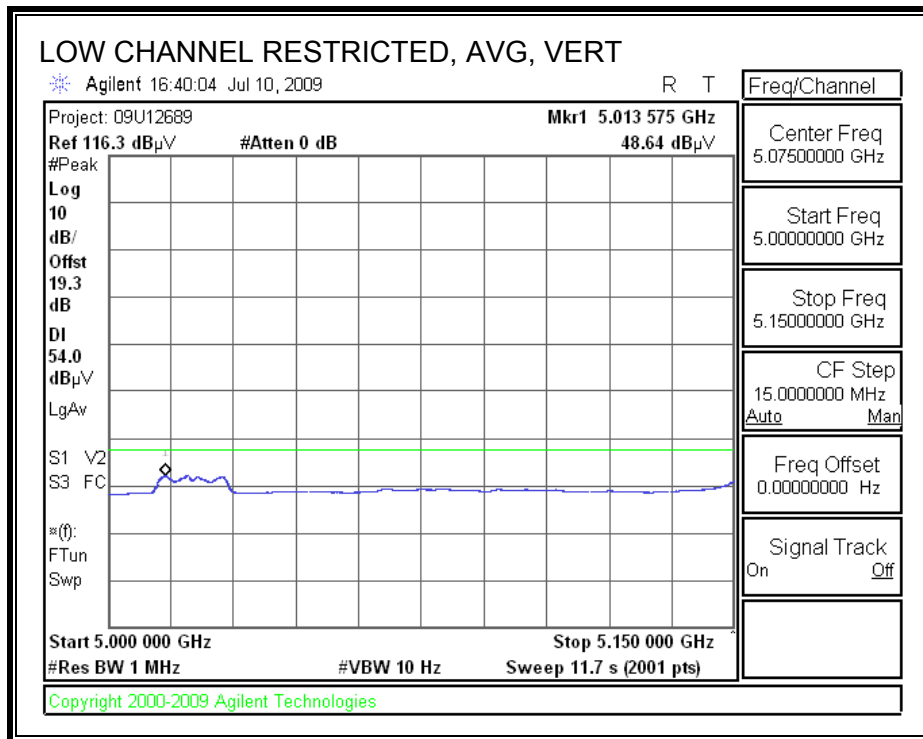
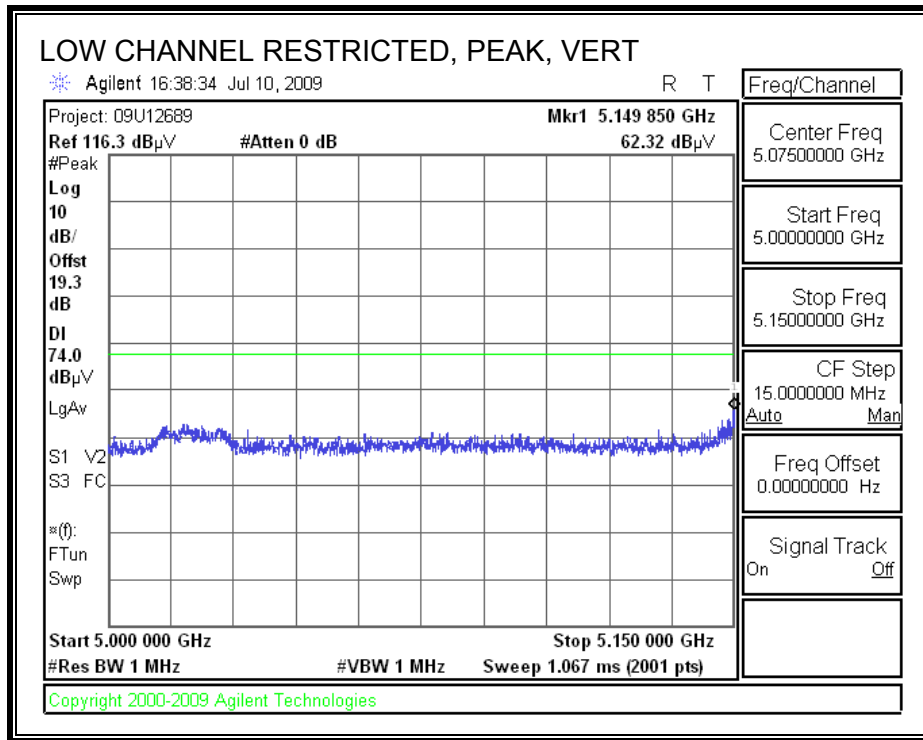

AUTHORIZED BANDEDGE (HIGH CHANNEL, VERTICAL)

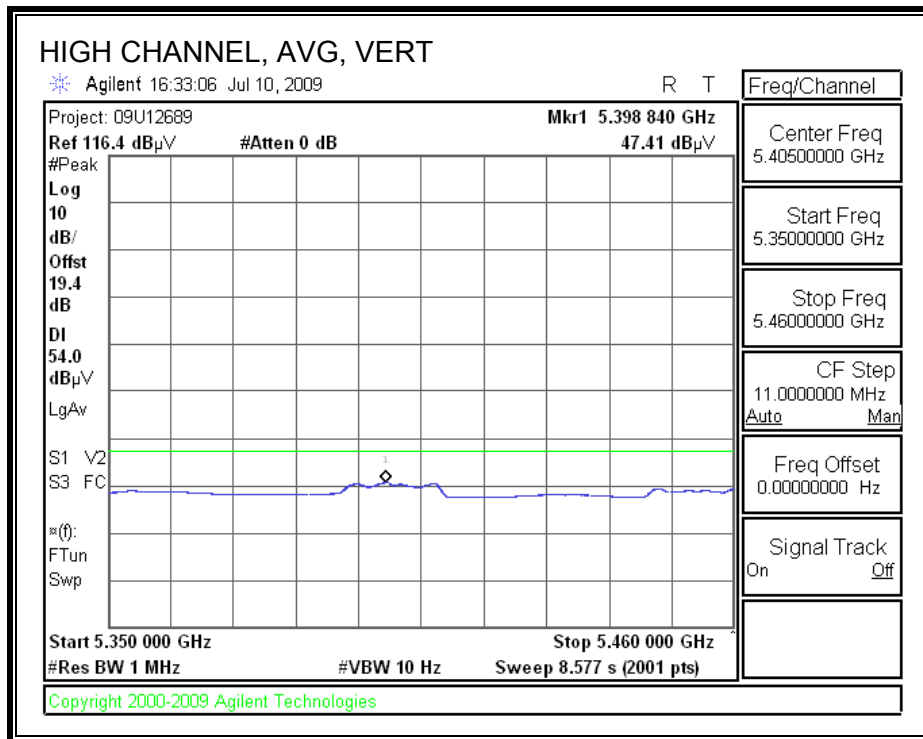
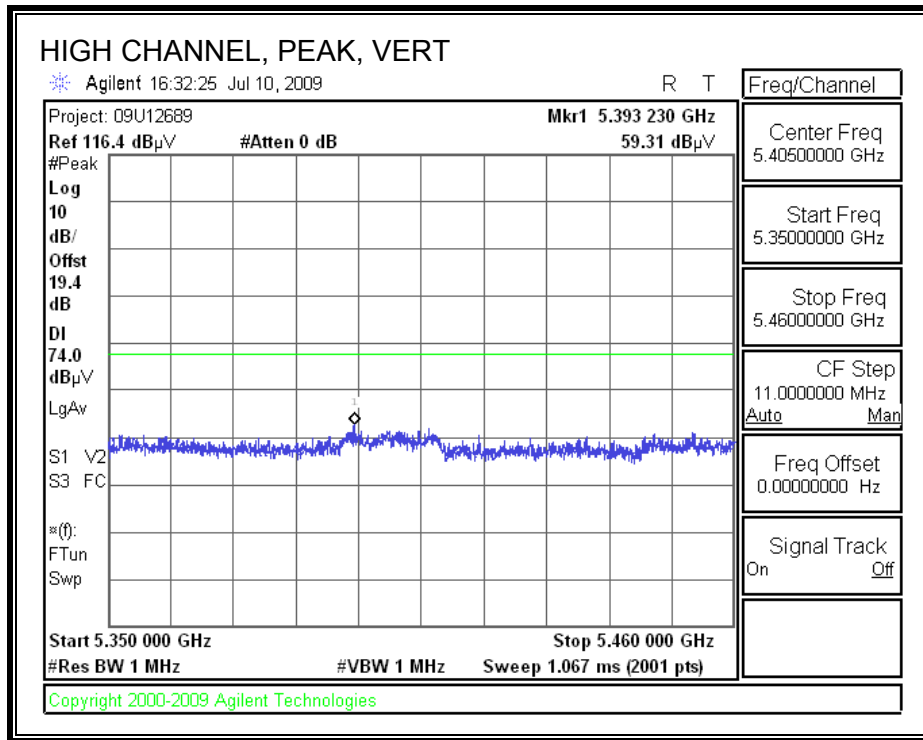

HARMONICS AND SPURIOUS EMISSIONS

High Frequency Measurement

Compliance Certification Services, Fremont 5m Chamber

Company: Qualcomm
 Project #: 09U12689
 Date: 07/13/09
 Test Engineer: Doug Anderson
 Configuration: EUT w/Support Notebook
 Mode: Tx / HT20

Test Equipment:

Horn 1-18GHz	Pre-amplifier 1-26GHz	Pre-amplifier 26-40GHz	Horn > 18GHz	Limit
T73; S/N: 6717 @3m	T144 Miteq 3008A00931			FCC 15.205

Hi Frequency Cables

3' cable 22807700	12' cable 22807600	20' cable 22807500	HPF	Reject Filter	Peak Measurements RBW=VBW=1MHz
3' cable 22807700	12' cable 22807600	20' cable 22807500	HPF_7.6GHz		Average Measurements RBW=1MHz ; VBW=10Hz

f GHz	Dist (m)	Read Pk dBuV	Read Avg. dBuV	AF dB/m	CL dB	Amp dB	D Corr dB	Filtr dB	Peak dBuV/m	Avg dBuV/m	Pk Lim dBuV/m	Avg Lim dBuV/m	Pk Mar dB	Avg Mar dB	Notes (V/H)
Low Ch.: 5180 (Power = 14 dBm)															
15.540	3.0	43.5	29.7	38.7	11.3	-34.8	0.0	0.7	59.4	45.7	74	54	-14.6	-8.3	V(Noise Floor)
15.540	3.0	43.4	29.7	38.7	11.3	-34.8	0.0	0.7	59.3	45.6	74	54	-14.7	-8.4	H(Noise Floor)
Mid. Ch.: 5200 (Power = 14 dBm)															
15.600	3.0	43.1	29.4	38.5	11.4	-34.8	0.0	0.7	58.9	45.2	74	54	-15.1	-8.8	V(Noise Floor)
15.600	3.0	43.1	31.9	38.5	11.4	-34.8	0.0	0.7	58.9	47.8	74	54	-15.1	-6.2	H(Noise Floor)
High Ch.: 5240 (Power = 14 dBm)															
15.720	3.0	42.3	31.4	38.2	11.4	-34.7	0.0	0.7	58.0	47.0	74	54	-16.0	-7.0	V(Noise Floor)
15.720	3.0	43.0	29.0	38.2	11.4	-34.7	0.0	0.7	58.6	44.6	74	54	-15.4	-9.4	H(Noise Floor)

Rev. 11.10.08

f	Measurement Frequency	Amp	Preamp Gain	Avg Lim	Average Field Strength Limit
Dist	Distance to Antenna	D Corr	Distance Correct to 3 meters	Pk Lim	Peak Field Strength Limit
Read	Analyzer Reading	Avg	Average Field Strength @ 3 m	Avg Mar	Margin vs. Average Limit
AF	Antenna Factor	Peak	Calculated Peak Field Strength	Pk Mar	Margin vs. Peak Limit
CL	Cable Loss	HPF	High Pass Filter		

8.2.3. 802.11n HT40 MODE IN 5.2 GHz BAND

RESTRICTED BANDEDGE (LOW CHANNEL, HORIZONTAL)

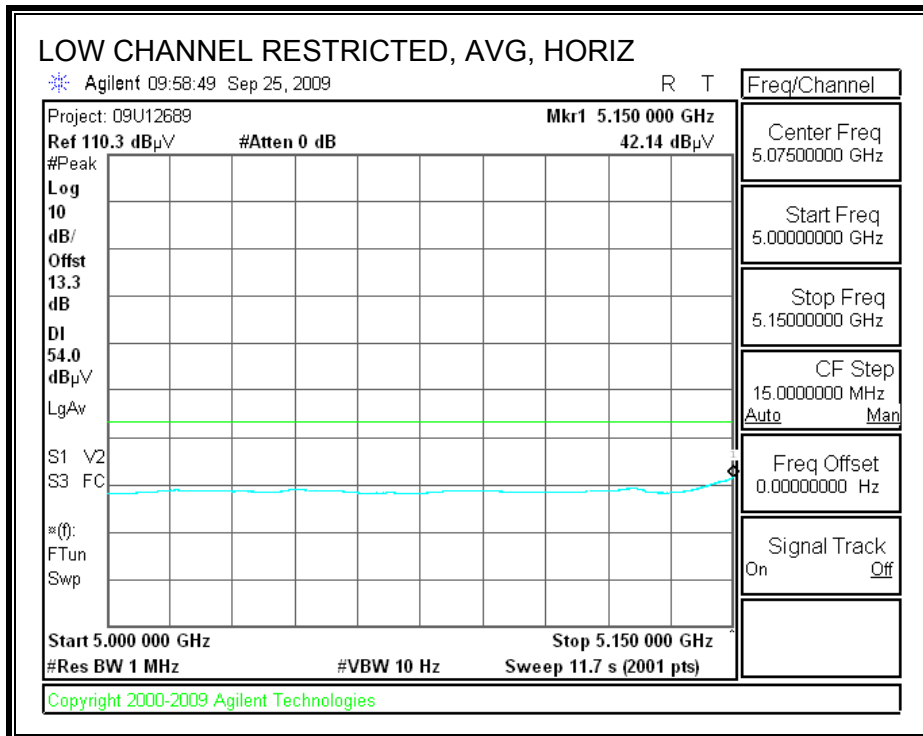
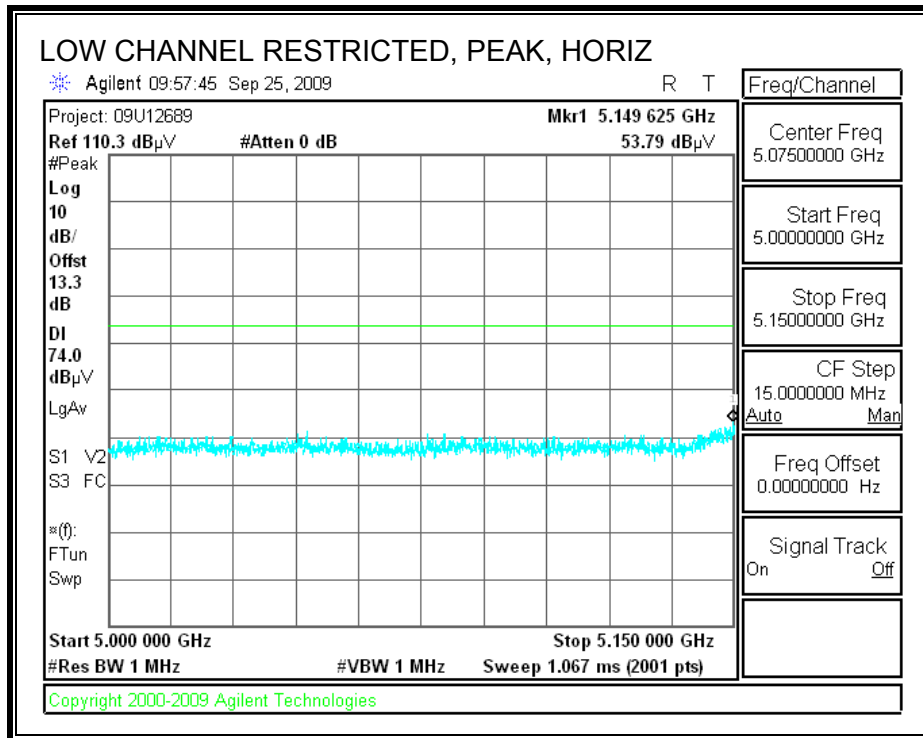

RESTRICTED BANDEGE (LOW CHANNEL, VERTICAL)

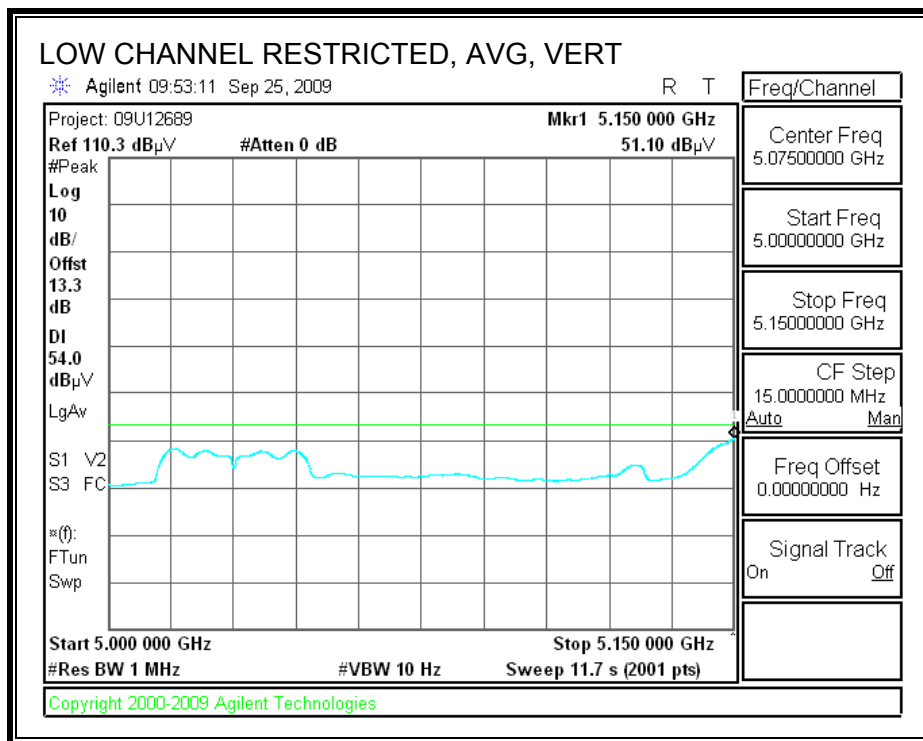
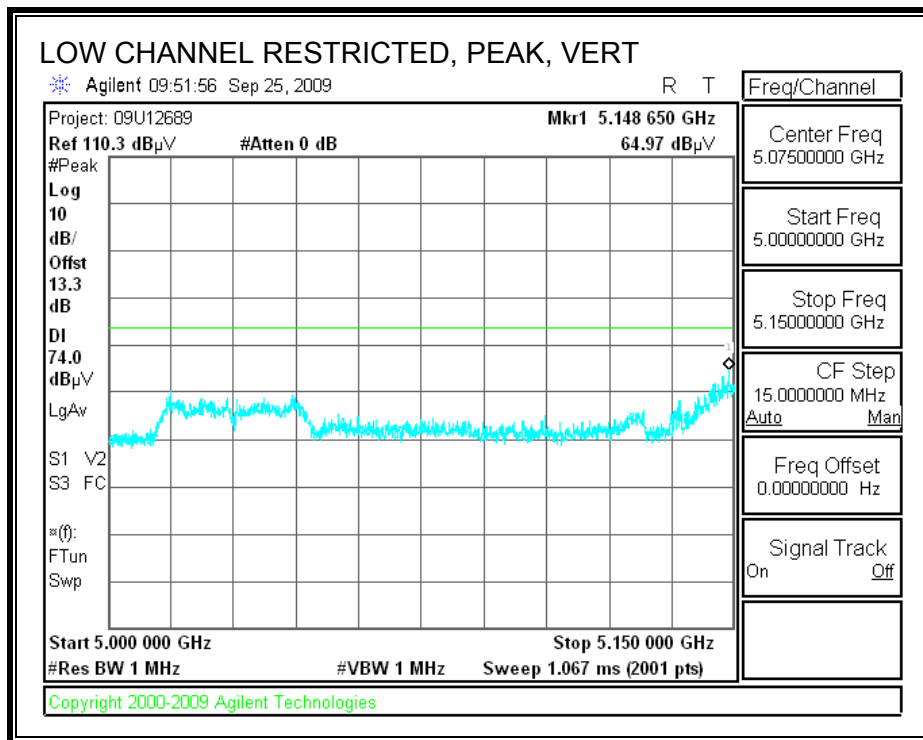

AUTHORIZED BANDEDGE (HIGH CHANNEL, VERTICAL)

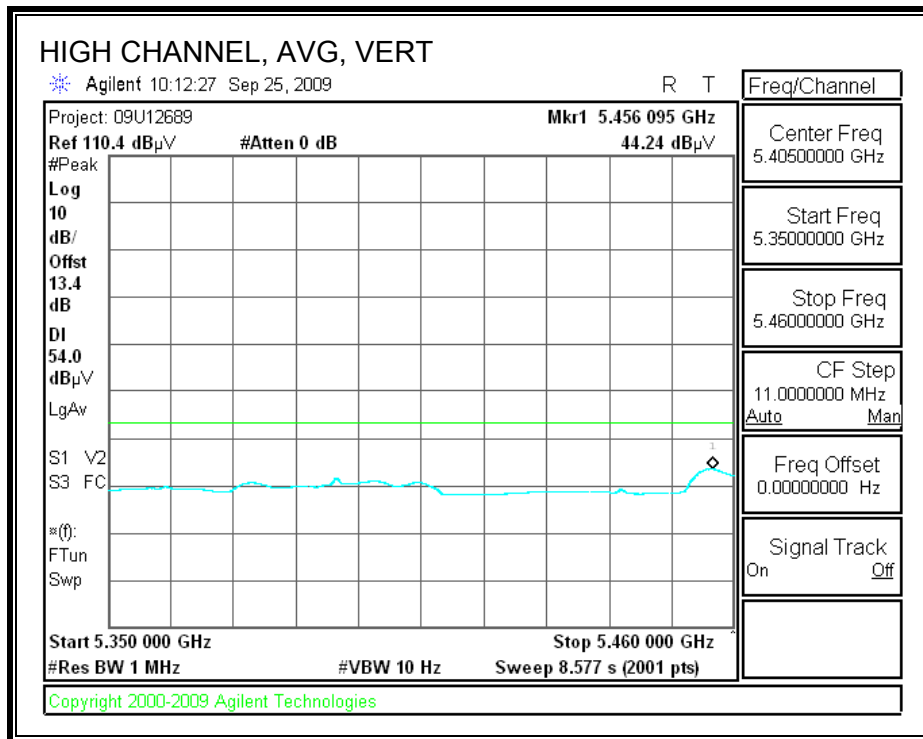
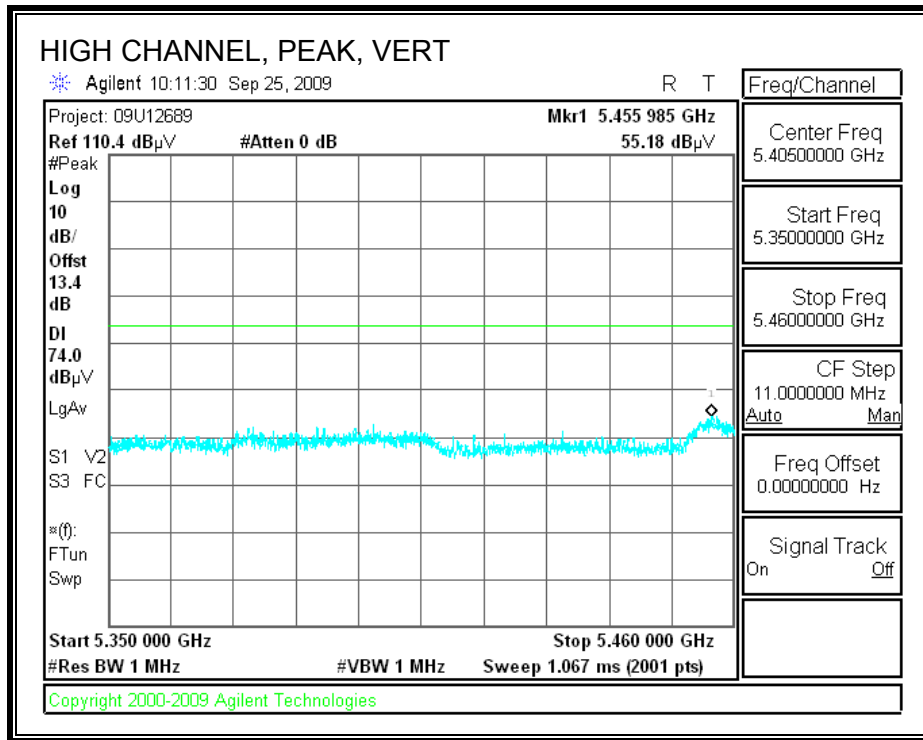

HARMONICS AND SPURIOUS EMISSIONS

High Frequency Measurement															
Compliance Certification Services, Fremont 5m Chamber															
Test Engr:		William Zhuang													
Date:		09/25/09													
Project #:		09U12689													
Company:		Qualcomm													
Configuration:		EUT w/Support Notebook													
Mode Oper:		Tx HT40													
f	Dist	Read	AF	CL	Amp	D Corr	Filtr	Corr.	Limit	Margin	Ant. Pol	Det.	Ant.High	Table Angle	Notes
GHz	(m)	dBuV	dB/m	dB	dB	dB	dB	dBuV/m	dBuV/m	dB	V/H	P/A/QP	cm	Degree	
5190MHz, Power Setting=12 dBm															
15.570	3.0	35.5	38.6	11.4	-34.8	0.0	0.7	51.3	74.0	-22.7	V	P	170.4	360.0	
15.570	3.0	23.1	38.6	11.4	-34.8	0.0	0.7	39.0	54.0	-15.0	V	A	170.4	360.0	
15.570	3.0	35.0	38.6	11.4	-34.8	0.0	0.7	50.9	74.0	-23.1	H	P	122.4	156.9	
15.570	3.0	23.0	38.6	11.4	-34.8	0.0	0.7	38.9	54.0	-15.1	H	A	122.4	156.9	
5230MHz, Power Setting=12 dBm															
15.690	3.0	35.2	38.3	11.4	-34.7	0.0	0.7	50.9	74.0	-23.1	V	P	121.6	357.2	
15.690	3.0	22.8	38.3	11.4	-34.7	0.0	0.7	38.5	54.0	-15.5	V	A	121.6	357.2	
15.690	3.0	36.2	38.3	11.4	-34.7	0.0	0.7	51.9	74.0	-22.1	H	P	100.0	87.3	
15.690	3.0	22.8	38.3	11.4	-34.7	0.0	0.7	38.5	54.0	-15.5	H	A	100.0	87.3	

Rev. 4.1.2.7

Note: No other emissions were detected above the system noise floor.

8.3. WORST-CASE BELOW 1 GHz

SPURIOUS EMISSIONS 30 TO 1000 MHz (WORST-CASE CONFIGURATION)

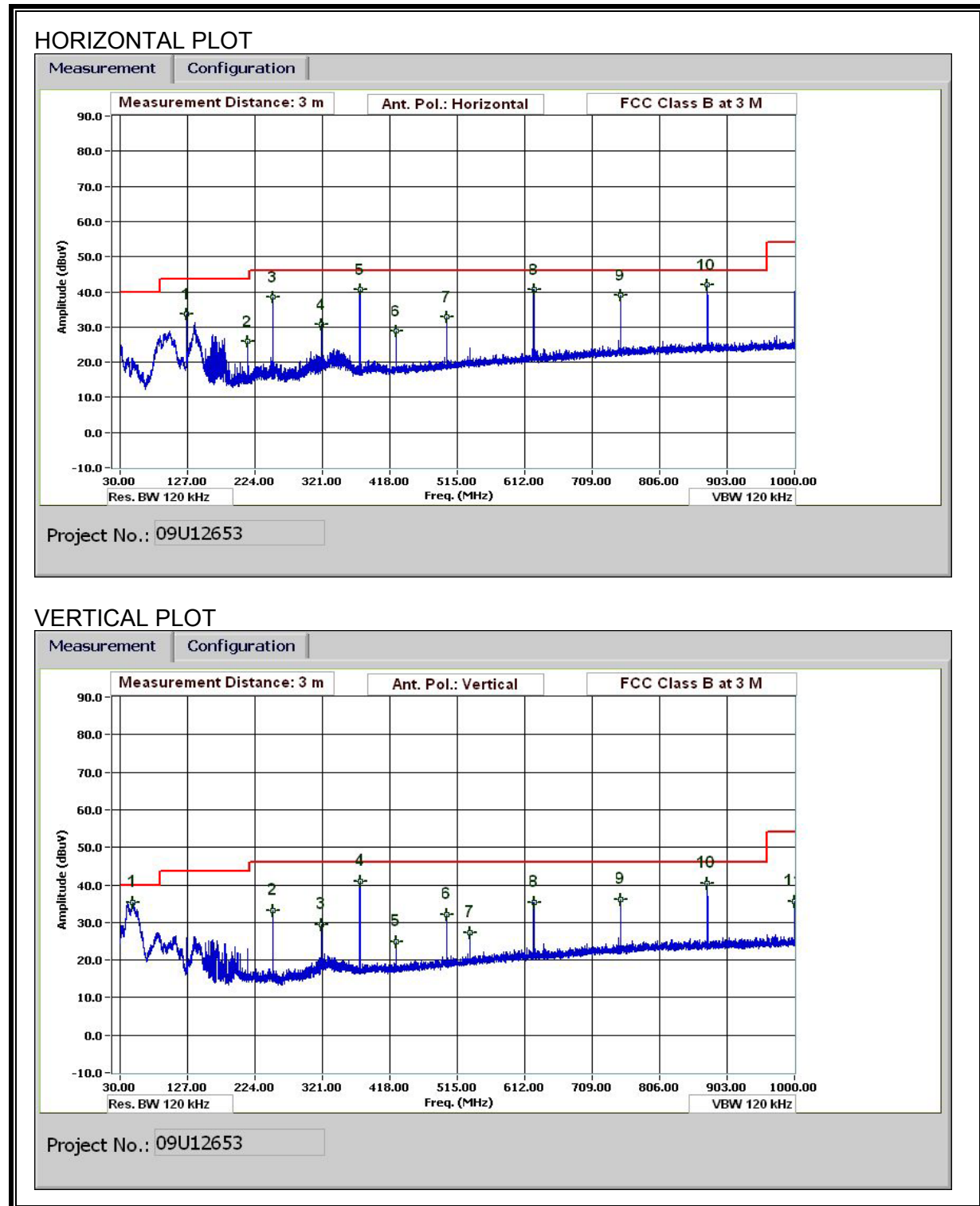

EMISSIONS DATA

30-1000MHz Frequency Measurement
 Compliance Certification Services, Fremont 5m Chamber

Test Engr: Vien Tran
 Date: 06/26/09
 Project #: 09U12653
 Company: Qualcomm
 EUT Description: 802.11n 4x4 WLAN Ethernet Adapter
 EUT M/N: Non-DFS:65-VN663-P1
 Test Target: FCC Class B
 Mode Oper: Tx HT20 MCS31, 5805MHz

f Measurement Frequency Amp Preamp Gain Margin Margin vs. Limit
 Dist Distance to Antenna D Corr Distance Correct to 3 meters
 Read Analyzer Reading Filter Filter Insert Loss
 AF Antenna Factor Corr. Calculated Field Strength
 CL Cable Loss Limit Field Strength Limit

f MHz	Dist (m)	Read dBuV	AF dB/m	CL dB	Amp dB	D Corr dB	Filter dB	Corr. dBuV/m	Limit dBuV/m	Margin dB	Ant. Pol. V/H	Det. P/A/QP	Notes
5805MHz Horizontal													
125.044	3.0	47.3	13.7	1.1	28.3	0.0	0.0	33.7	43.5	-9.8	H	EP	
213.368	3.0	40.9	11.9	1.3	28.2	0.0	0.0	25.9	43.5	-17.6	H	EP	
249.969	3.0	53.5	11.8	1.4	28.2	0.0	0.0	38.5	46.0	-7.5	H	EP	
319.932	3.0	43.6	13.7	1.6	28.1	0.0	0.0	30.8	46.0	-15.2	H	EP	
375.014	3.0	52.5	14.5	1.7	28.1	0.0	0.0	40.7	46.0	-5.3	H	EP	
426.616	3.0	39.5	15.4	1.9	28.0	0.0	0.0	28.8	46.0	-17.2	H	EP	
499.939	3.0	41.9	16.7	2.0	27.8	0.0	0.0	32.9	46.0	-13.1	H	EP	
624.985	3.0	47.2	18.7	2.3	27.4	0.0	0.0	40.7	46.0	-5.3	H	EP	
749.910	3.0	43.5	20.3	2.5	27.3	0.0	0.0	39.0	46.0	-7.0	H	EP	
874.955	3.0	45.4	21.6	2.8	27.7	0.0	0.0	42.1	46.0	-3.9	H	EP	
5805MHz Vertical													
48.001	3.0	53.6	9.3	0.6	28.4	0.0	0.0	35.2	40.0	-4.8	V	EP	
249.969	3.0	48.3	11.8	1.4	28.2	0.0	0.0	33.2	46.0	-12.8	V	EP	
320.052	3.0	42.2	13.7	1.6	28.1	0.0	0.0	29.4	46.0	-16.6	V	EP	
375.014	3.0	52.8	14.5	1.7	28.1	0.0	0.0	41.0	46.0	-5.0	V	EP	
426.736	3.0	35.5	15.4	1.9	28.0	0.0	0.0	24.8	46.0	-21.2	V	EP	
499.939	3.0	41.2	16.7	2.0	27.8	0.0	0.0	32.1	46.0	-13.9	V	EP	
533.301	3.0	35.7	17.3	2.1	27.7	0.0	0.0	27.3	46.0	-18.7	V	EP	
624.985	3.0	41.8	18.7	2.3	27.4	0.0	0.0	35.4	46.0	-10.6	V	EP	
749.910	3.0	40.6	20.3	2.5	27.3	0.0	0.0	36.1	46.0	-9.9	V	EP	
874.955	3.0	43.7	21.6	2.8	27.7	0.0	0.0	40.4	46.0	-5.6	V	EP	
999.880	3.0	37.9	22.5	3.0	27.9	0.0	0.0	35.4	54.0	-18.6	V	EP	

Rev. 1.27.09

Note: No other emissions were detected above the system noise floor.

9. AC POWER LINE CONDUCTED EMISSIONS

LIMITS

FCC §15.207 (a)

RSS-Gen 7.2.2

Frequency of Emission (MHz)	Conducted Limit (dBuV)	
	Quasi-peak	Average
0.15-0.5	66 to 56*	56 to 46*
0.5-5	56	46
5-30	60	50

*Decreases with the logarithm of the frequency.

TEST PROCEDURE

The EUT is placed on a non-conducting table 40 cm from the vertical ground plane and 80 cm above the horizontal ground plane. The EUT is configured in accordance with ANSI C63.4.

The receiver is set to a resolution bandwidth of 9 kHz. Peak detection is used unless otherwise noted as quasi-peak or average.

Line conducted data is recorded for both NEUTRAL and HOT lines.

RESULTS

6 WORST EMISSIONS

CONDUCTED EMISSIONS DATA (115VAC 60Hz)									
Freq. (MHz)	Reading			Class (dB)	Limit QP	FCC B AV	Margin		Remark L1 / L2
	PK (dBuV)	QP (dBuV)	AV (dBuV)				QP (dB)	AV (dB)	
0.19	51.41	--	33.87	0.00	63.86	53.86	-12.45	-19.99	L1
2.95	44.80	--	27.60	0.00	56.00	46.00	-11.20	-18.40	L1
19.12	41.71	--	30.40	0.00	60.00	50.00	-18.29	-19.60	L1
0.19	51.34	--	33.94	0.00	63.86	53.86	-12.52	-19.92	L2
2.95	44.13	--	27.56	0.00	56.00	46.00	-11.87	-18.44	L2
19.12	40.89	--	29.56	0.00	60.00	50.00	-19.11	-20.44	L2
6 Worst Data									

LINE 1 RESULTS



Compliance Certification Services
47173 Benicia Street
Fremont, CA 94538
Tel: (510) 771-1000
Fax: (510) 661-0888

Data#: 7 File#: Qualcomm_09U12653_LC.EMI
Date: 06-26-2009 Time: 11:52:34

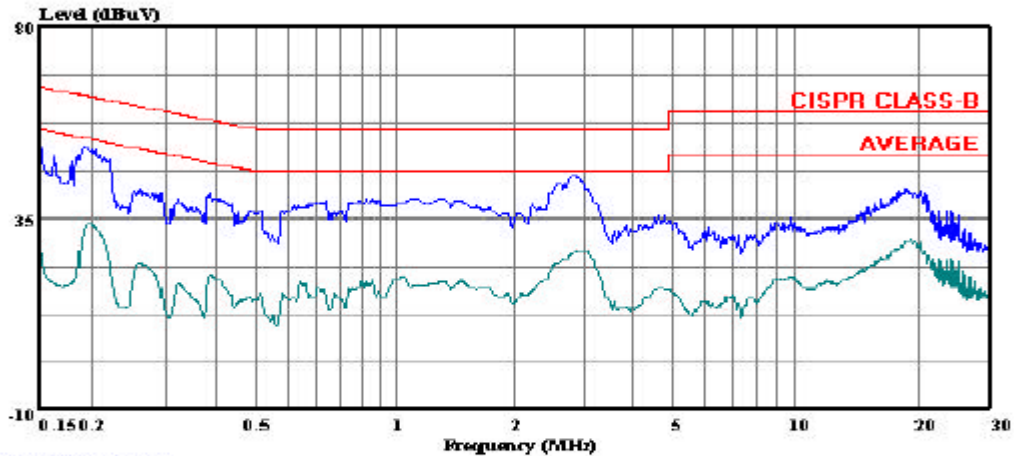

(Line Conduction)

Trace: 5

Ref Trace:

Condition: CISPR CLASS-B
Test Operator: : Vien Tran
Project #: : 09U12653
Company: : Qualcomm
EUT Description: : 802.11n 4x4 WLAN Module
: Ethernet Adapter
Mode: : Tx worst case 5GHz Band
Target: : FCC Class B
Voltage: : 115VAC, 60HZ
: L1: Peak (Blue) , Average (Green)

LINE 2 RESULTS



Compliance Certification Services
47173 Benicia Street
Fremont, CA 94538
Tel: (510) 771-1000
Fax: (510) 661-0888

Data#: 14 File#: Qualcomm_09U12653_LC.EMI
Date: 06-26-2009 Time: 12:02:29

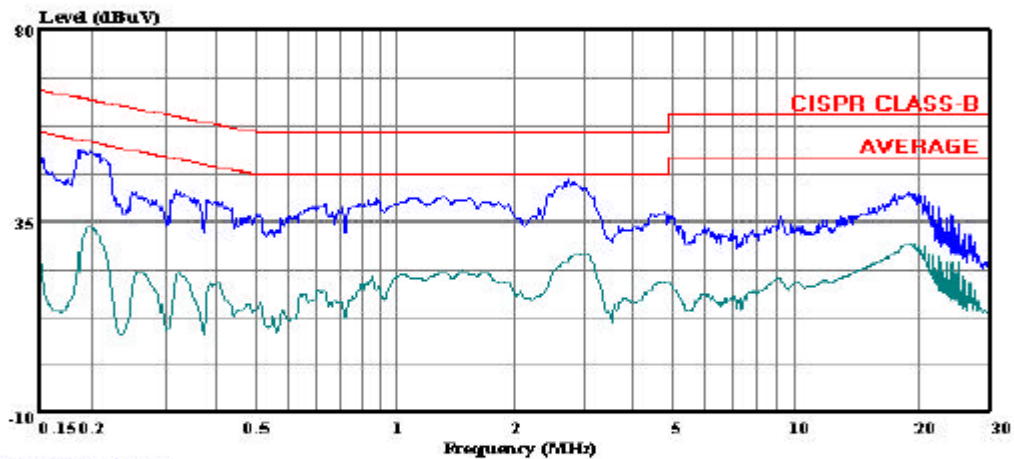

(Line Conduction)

Trace: 12

Ref Trace:

Condition: CISPR CLASS-B
Test Operator: : Vien Tran
Project #: : 09U12653
Company: : Qualcomm
EUT Description: : 802.11n 4x4 WLAN Module
: Ethernet Adapter
Mode: : TX worst case 5GHZ Band
Target: : FCC Class B
Voltage: : 115VAC, 60Hz
: L2: Peak (Blue) , Average (Green)

10. MAXIMUM PERMISSIBLE EXPOSURE

FCC RULES

§1.1310 The criteria listed in Table 1 shall be used to evaluate the environmental impact of human exposure to radio-frequency (RF) radiation as specified in §1.1307(b), except in the case of portable devices which shall be evaluated according to the provisions of §2.1093 of this chapter.

TABLE 1—LIMITS FOR MAXIMUM PERMISSIBLE EXPOSURE (MPE)

Frequency range (MHz)	Electric field strength (V/m)	Magnetic field strength (A/m)	Power density (mW/cm ²)	Averaging time (minutes)
(A) Limits for Occupational/Controlled Exposures				
0.3–3.0	614	1.63	*(100)	6
3.0–30	1842/f	4.89/f	*(900/f ²)	6
30–300	61.4	0.163	1.0	6
300–1500	f/300	6
1500–100,000	5	6
(B) Limits for General Population/Uncontrolled Exposure				
0.3–1.34	614	1.63	*(100)	30
1.34–30	824/f	2.19/f	*(180/f ²)	30

TABLE 1—LIMITS FOR MAXIMUM PERMISSIBLE EXPOSURE (MPE)—Continued

Frequency range (MHz)	Electric field strength (V/m)	Magnetic field strength (A/m)	Power density (mW/cm ²)	Averaging time (minutes)
30–300	27.5	0.073	0.2	30
300–1500	f/1500	30
1500–100,000	1.0	30

f = frequency in MHz

* = Plane-wave equivalent power density

NOTE 1 TO TABLE 1: Occupational/controlled limits apply in situations in which persons are exposed as a consequence of their employment provided those persons are fully aware of the potential for exposure and can exercise control over their exposure. Limits for occupational/controlled exposure also apply in situations when an individual is transient through a location where occupational/controlled limits apply provided he or she is made aware of the potential for exposure.

NOTE 2 TO TABLE 1: General population/uncontrolled exposures apply in situations in which the general public may be exposed, or in which persons that are exposed as a consequence of their employment may not be fully aware of the potential for exposure or can not exercise control over their exposure.

IC RULES

IC Safety Code 6, Section 2.2.1 (a) A person other than an RF and microwave exposed worker shall not be exposed to electromagnetic radiation in a frequency band listed in Column 1 of Table 5, if the field strength exceeds the value given in Column 2 or 3 of Table 5, when averaged spatially and over time, or if the power density exceeds the value given in Column 4 of Table 5, when averaged spatially and over time.

**Table 5
 Exposure Limits for Persons Not Classed As RF and Microwave Exposed Workers (Including the General Public)**

1 Frequency (MHz)	2 Electric Field Strength; rms (V/m)	3 Magnetic Field Strength; rms (A/m)	4 Power Density (W/m ²)	5 Averaging Time (min)
0.003–1	280	2.19		6
1–10	280/ <i>f</i>	2.19/ <i>f</i>		6
10–30	28	2.19/ <i>f</i>		6
30–300	28	0.073	2*	6
300–1 500	1.585 <i>f</i> ^{0.5}	0.0042 <i>f</i> ^{0.5}	<i>f</i> /150	6
1 500–15 000	61.4	0.163	10	6
15 000–150 000	61.4	0.163	10	616 000 / <i>f</i> ^{1.2}
150 000–300 000	0.158 <i>f</i> ^{0.5}	4.21 x 10 ⁻⁴ <i>f</i> ^{0.5}	6.67 x 10 ⁻⁵ <i>f</i>	616 000 / <i>f</i> ^{1.2}

* Power density limit is applicable at frequencies greater than 100 MHz.

- Notes:**
1. Frequency, *f*, is in MHz.
 2. A power density of 10 W/m² is equivalent to 1 mW/cm².
 3. A magnetic field strength of 1 A/m corresponds to 1.257 microtesla (μT) or 12.57 milligauss (mG).

EQUATIONS

Power density is given by:

$$S = \text{EIRP} / (4 * \text{Pi} * \text{D}^2)$$

where

S = Power density in W/m²

EIRP = Equivalent Isotropic Radiated Power in W

D = Separation distance in m

Power density in units of W/m² is converted to units of mW/cm² by dividing by 10.

Distance is given by:

$$D = \text{SQRT} (\text{EIRP} / (4 * \text{Pi} * S))$$

where

D = Separation distance in m

EIRP = Equivalent Isotropic Radiated Power in W

S = Power density in W/m²

In the table(s) below, Power and Gain are entered in units of dBm and dBi respectively and conversions to linear forms are used for the calculations.

LIMITS

From FCC §1.1310 Table 1 (B), the maximum value of S = 1.0 mW/cm²

From IC Safety Code 6, Section 2.2 Table 5 Column 4, S = 10 W/m²

RESULTS

(MPE distance equals 20 cm)

Band	Mode	Separation Distance (m)	Output Power (dBm)	Antenna Gain (dBi)	IC Power Density (W/m ²)	FCC Power Density (mW/cm ²)
5.2 GHz	11a (2 Chains)	0.20	12.10	6.01	0.13	0.013
5.2 GHz	11n HT20 (4 Chains)	0.20	13.67	3.0	0.09	0.009
5.2 GHz	11n HT40 (4 Chains)	0.20	16.88	3.0	0.19	0.019