

About Consumables



5.1	Available Consumables.....	72
5.2	EP Cartridge	74
5.3	Fuser Unit	77
5.4	Transfer Roll Cartridge	81
5.5	Feed Roll.....	85

5.1 Available Consumables

The following consumables are available for this printer. To order these, contact our Printer Support Desk.

••• EP cartridge

The EP cartridge includes the toner and the photosensitive drum. If the toner in the EP cartridge is insufficient, the printout will become light and blurred. If it is time for replacement, replace with a new EP cartridge.

The following types of EP cartridge are available:

- 6 Kpv: can print approximately 6,000 pages
- 10 Kpv: can print approximately 10,000 pages
- 15 Kpv: can print approximately 15,000 pages

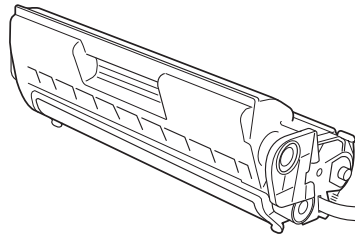

Note

The possible number of pages that can be printed is based on A4 size paper with a print ratio of 5% and the default density setting using one EP cartridge. The number of pages that can be actually printed varies according to the conditions of use.

Important

Use of EP cartridges not recommended by our company may impair print quality or printer performance. Use only EP cartridges recommended by our company on this printer.

Refer to

"5.2 EP Cartridge" for details on how to replace the EP cartridge.

Note: □

The user is cautioned that changes or modifications not expressly approved by the party responsible for compliance could void the user's authority to operate the equipment.

Regular replacement parts

Regular replacement parts packaged together include the fuser unit, the transfer roll cartridge, and the feed roll. About 100,000 pages for a fuser unit and about 200,000 pages for a transfer roll cartridge and a feed roll can be printed. When these parts have reached this limit, replace them with new ones.

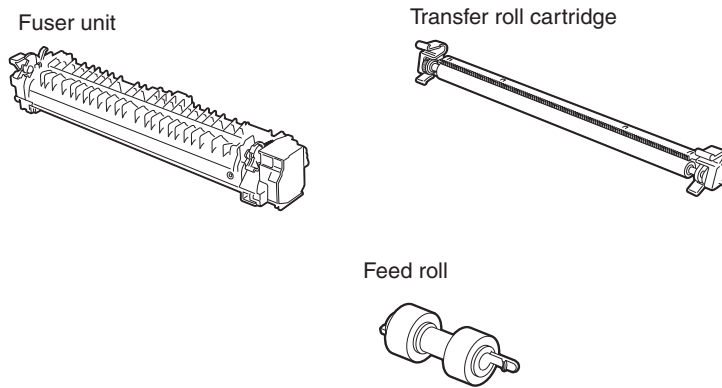

Note

The possible number of pages that can be printed is based on A4 size paper with a print ratio of 5% and the default density setting. The number of pages that can be actually printed varies according to the conditions of use.

Refer to

- "5.3 Fuser Unit" for details on how to replace the fuser unit.
- "5.4 Transfer Roll Cartridge" for details on how to replace the transfer roll cartridge.
- "5.5 Feed Roll" for details on how to replace the feed roll.

5.2 EP Cartridge

This section explains about the EP cartridge.

5.2.1 Cautions on Handling the EP Cartridge

When handling the EP cartridge, take note of the following points:

⚠ WARNING

Never throw an EP cartridge into an open flame. It can cause an explosion and you can get burnt.

- Do not subject it to direct sunlight or strong light.
- When installing the EP cartridge, select a location not subject to strong light and try to finish the installation within 5 minutes.
- Do not touch the surface of the photosensitive drum. Do not let the EP cartridge stand or place it upside down. The drum might get damaged.
- A drum shutter protects the photosensitive drum from light. Do not open the drum shutter.
- Although the toner is not harmful to the body, wash it off immediately if your hands or clothes are stained with it.
- It is recommended to use up the EP cartridge within 1 year after opening it.

5.2.2 Replacing the EP Cartridge

Procedure

- 1** Switch off the power of the printer.

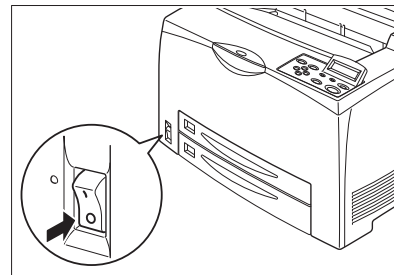

- 2** Remove any paper in the center output tray.

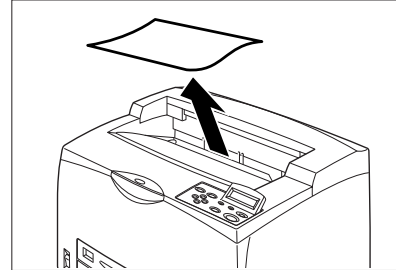

- 3** Open the top cover.

Important

Do not touch any parts inside the printer.

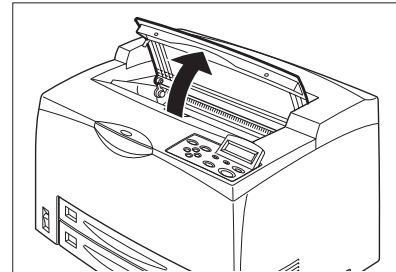

- 4** Hold the EP cartridge by the grip and pull it out slowly.

Note

To prevent the toner from dirtying the floor, lay a piece of paper on the floor first before putting the EP cartridge down.

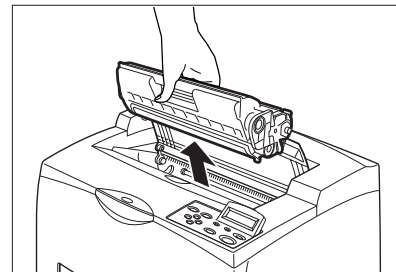

- 5** Take the new EP cartridge out of the box and shake it 7 to 8 times in the manner as shown in the diagram.

Important

- *If the toner is not evenly spread out, the print quality may drop. Also, if you did not shake the EP cartridge well, there may be operating noise or the interior of the EP cartridge may be damaged during operation.*
- *Do not touch the surface of the photosensitive drum.*

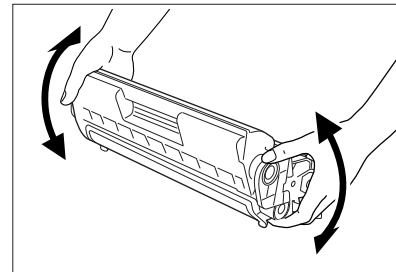

5.2 EP Cartridge

- 6** Place the EP cartridge on a flat surface and pull out the seal horizontally.

Important

- When pulling out the seal, pull it out horizontally. The tape might break if it is pulled out diagonally.
- After the seal has been pulled out, do not shake or dump the EP cartridge.

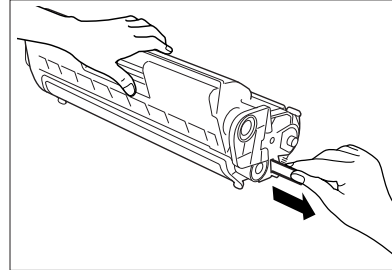

- 7** Hold the EP cartridge by the grip and insert it into the slot inside the printer.

Important

- Do not touch any parts inside the printer.
- Ensure that the EP cartridge is firmly set.

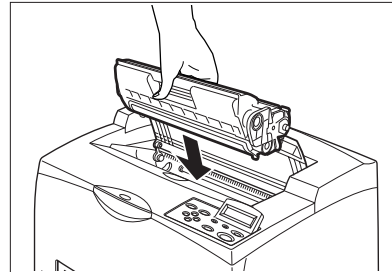

- 8** Close the top cover securely.

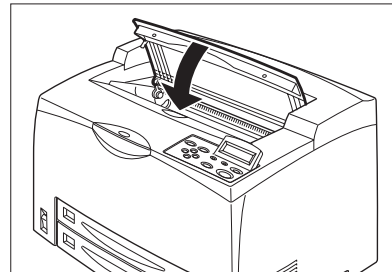

5.3 Fuser Unit

This section explains about the fuser unit.

5.3.1 Caution on Handling the Fuser Unit

The fuser unit is included as one of the regular replacement parts. Before replacing the fuser unit, open the box of the regular replacement parts and get the new fuser unit ready.

When handling the fuser unit, take note of the following points:

⚠ CAUTION

- **Never touch a labeled area found on or near the heat roller. You can get burnt. If a sheet of paper is wrapped around the heat roller, do not try to remove it by yourself to avoid injuries or burns. Switch off the machine immediately, and contact our Printer Support Desk.**
- **Be sure to switch off and unplug the machine before accessing the interior of the machine for cleaning, maintenance, or fault clearance. Access to a live machine's interior can cause electric shock.**

- Do not replace the fuser unit immediately after using the printer. You may get burnt.

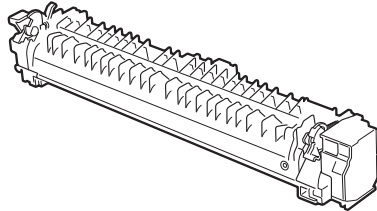

5.3 Fuser Unit

5.3.2 Replacing the Fuser Unit

Procedure

- 1 Switch off the power of the printer and leave it for 30 minutes until the fuser unit cools down.

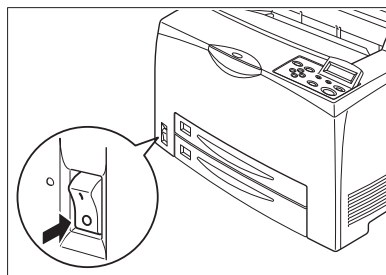

- 2 Remove any paper in the center output tray.

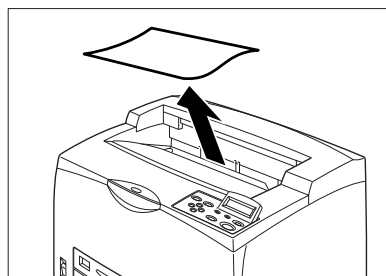

- 3 Lift the second lever from the top left corner of the back of the printer.

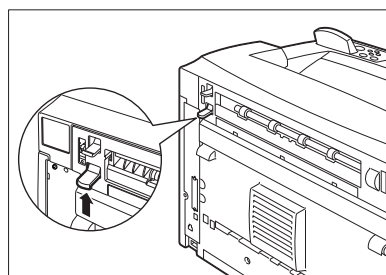

5.3 Fuser Unit

4 Open the rear cover.

Important

Do not touch any parts inside the printer.

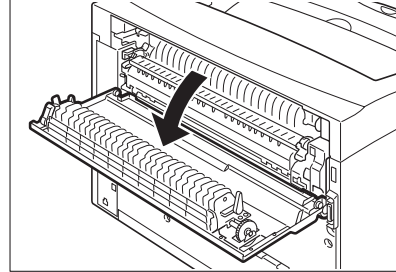

5 Lift the lever at both ends of the fuser unit to unlock it.

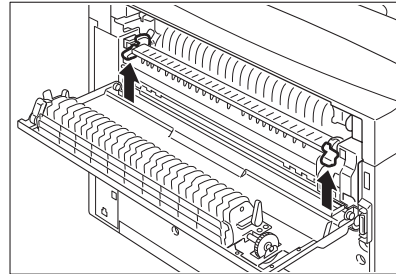

6 Pull down the 2 levers at the bottom of the fuser unit.

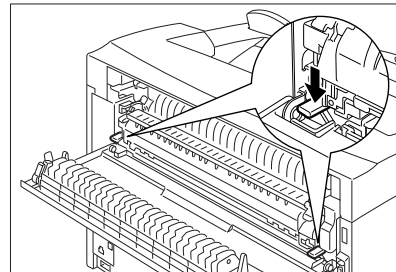

7 Remove the fuser unit slowly.

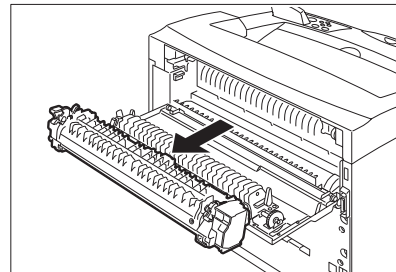

5.3 Fuser Unit

8 Set the new fuser unit slowly.

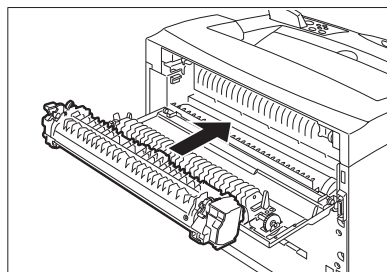

9 Lift up the 2 levers at the bottom of the fuser unit and push down the levers at both ends of the fuser unit to lock it.

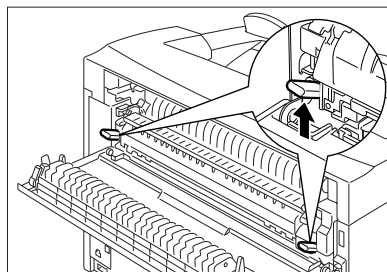

10 Close the rear cover.

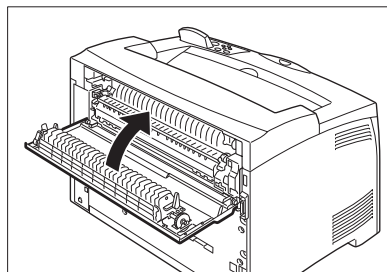

5.4 Transfer Roll Cartridge

This section explains about the transfer roll cartridge.

5.4.1 Caution on Handling the Transfer Roll Cartridge

The transfer roll cartridge is included as one of the regular replacement parts. Before replacing the transfer roll cartridge, open the box of the regular replacement parts and get the new transfer roll cartridge ready. When handling the transfer roll cartridge, take note of the following points:

⚠ WARNING

Never throw an transfer roll cartridge into an open flame. It can cause an explosion and you can get burnt.

- Do not remove and reinsert the transfer roll cartridge in use.
- When the message to replace the transfer roll cartridge appears, replace the transfer roll cartridge immediately. Otherwise, the printer will be forcibly stopped.

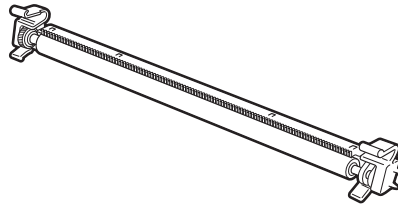

5.4 Transfer Roll Cartridge

5.4.2 Replacing the Transfer Roll Cartridge

Procedure

- 1 Switch off the power of the printer.

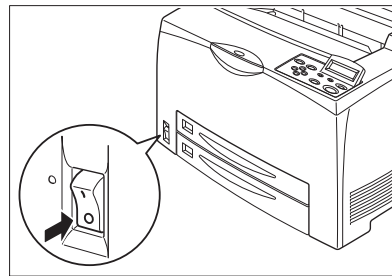

- 2 Remove any paper in the center output tray.

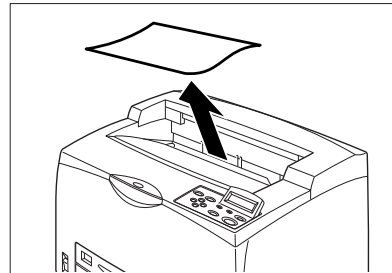

- 3 Open the top cover.

Important

Do not touch any parts inside the printer.

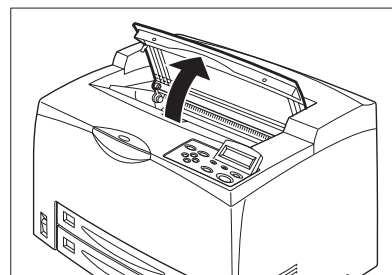

5.4 Transfer Roll Cartridge

- 4** Hold the EP cartridge by the grip to pull it out slowly.

Note

To prevent the toner from dirtying the floor, lay a piece of paper on the floor before putting the EP cartridge down.

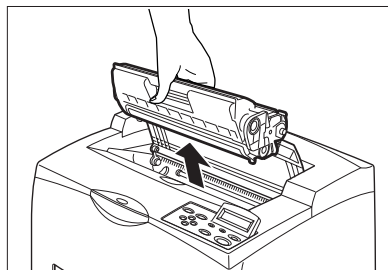

- 5** Squeeze the levers on both ends of the transfer roll cartridge and pull it out slowly towards you.

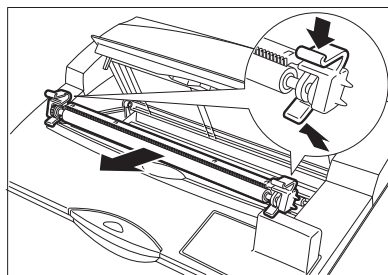
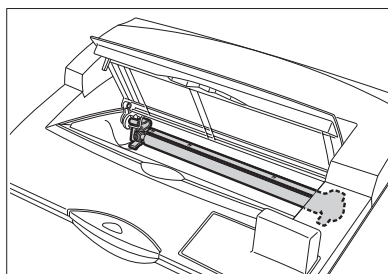

- 6** Pick up the new transfer roll cartridge by the levers at both ends and slowly slot it in.

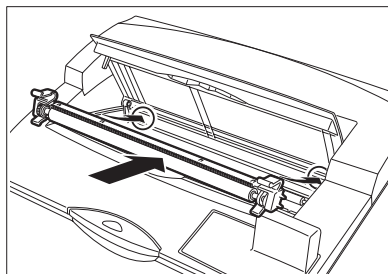

5.4 Transfer Roll Cartridge

7 Hold the EP cartridge by the grip and insert it into the slot inside the printer.

Important

- Do not touch any parts inside the printer.
- Ensure that the EP cartridge is firmly set.

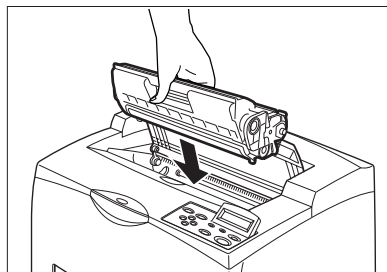

8 Close the top cover securely.

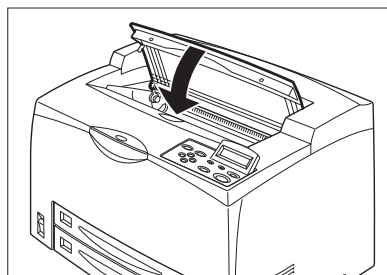

5.5 Feed Roll

This section explains about the feed roll.

5.5.1 Caution on Handling the Feed Roll

The feed roll is included as one of the regular replacement parts. Before replacing the feed roll, open the box of the regular replacement parts and get the new feed roll ready.

When handling the feed roll, take note of the following points:

⚠ CAUTION

Be sure to switch off and unplug the machine before accessing the interior of the machine for cleaning, maintenance, or fault clearance. Access to a live machine's interior can cause electric shock.

There are feed rolls inside the interior of the printer (2 in 2 locations, 4 in total), tray module (1 location), paper tray (1 location), single-sheet bypass tray (1 location) and multiple-sheet bypass tray (1 location).

5.5 Feed Roll

Feed roll

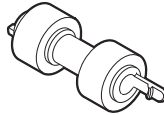

Inside the printer (2 locations)

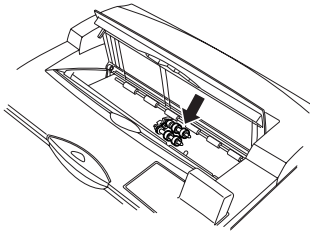

Tray module (1 location)

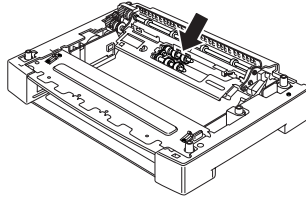

Paper tray (1 location)

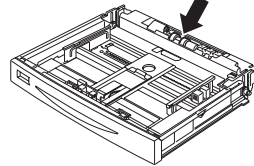

Single-sheet bypass tray (1 location)

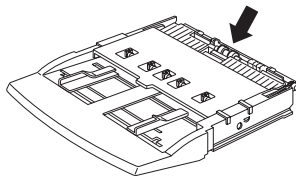

Multiple-sheet bypass tray (1 location)

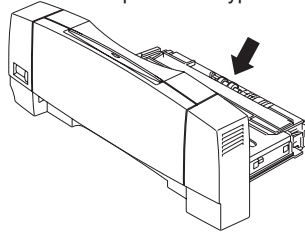

5.5.2 Replacing the Feed Roll

Note

The following procedure explains how to replace the feed roll of the paper tray. Follow the procedure here for replacing the feed roll of the tray module as well.

●●● Feed roll at the paper tray

Procedure

- 1** Pull the paper tray out of the printer.

Note

The feed roll on tray modules can be replaced without pulling out the paper tray.

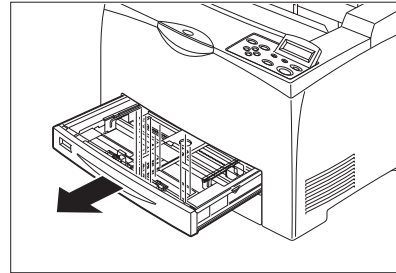

- 2** While pushing down the shaft of the feed roll as shown in the diagram (1), widen the tab of the feed roll to loosen it (2) and then slowly remove the feed roll from the shaft on the paper tray (3).

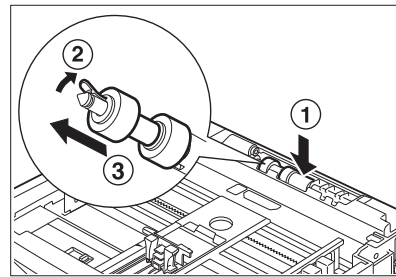

- 3** Hold the tab on the new feed roll as shown in the diagram and slowly push it into the shaft on the paper tray.

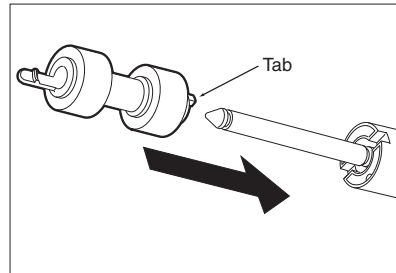

5.5 Feed Roll

By aligning the small tabs on the feed roll with the slots of the shaft, push the feed roll completely in so that the tab fits into the slot.

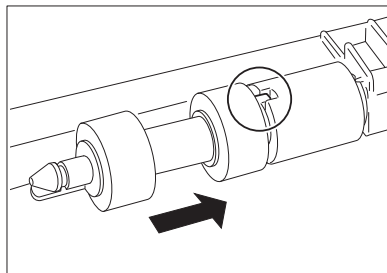

- 4** Push the paper tray completely into the printer.

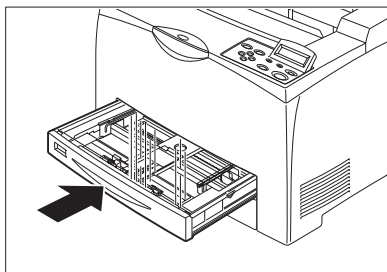

●●● Feed roll inside the printer

Procedure

- 1** Remove any paper in the center output tray.

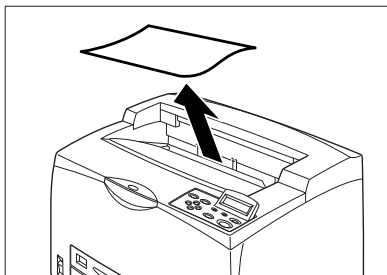

5.5 Feed Roll

- 2** Open the top cover.

Important

Do not touch any parts inside the printer.

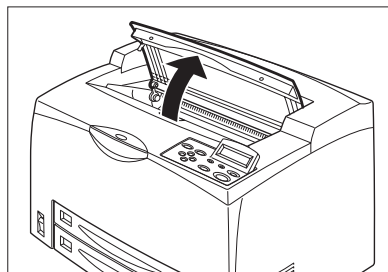

- 3** Hold the EP cartridge by the grip and pull it out slowly.

Note

To prevent the toner from dirtying the floor, lay a piece of paper on the floor first before putting the EP cartridge down.

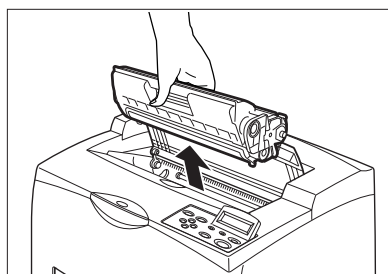

- 4** While pushing down the shaft of the feed roll as shown in the diagram, widen the tab on the feed roll to loosen it (1) and then slowly remove the feed roll from the shaft of the paper tray (2).

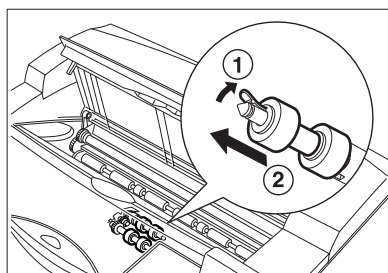

- 5** Hold the tab on the new feed roll as shown in the diagram and slowly push it into the shaft on the paper tray.

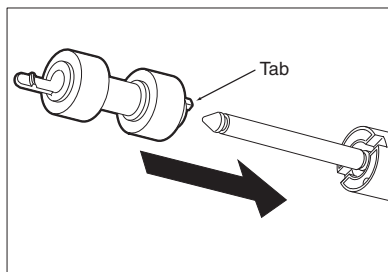

5.5 Feed Roll

By aligning the small tabs on the feed roll with the slots of the shaft, push the feed roll completely in so that the tab fits into the slot.

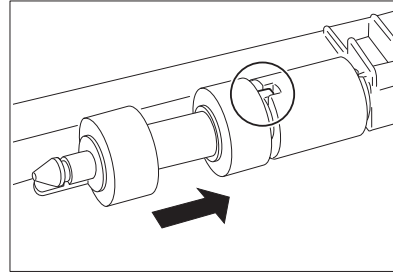

6 Hold the EP cartridge by the grip and insert it into the slot inside the printer.

Important

- Do not touch any parts inside the printer.
- Ensure that the EP cartridge is firmly set.

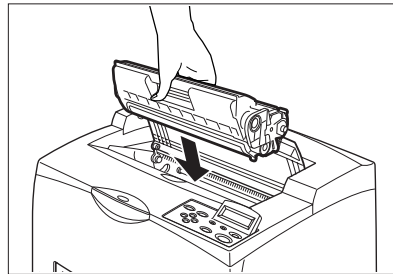

7 Close the top cover securely.

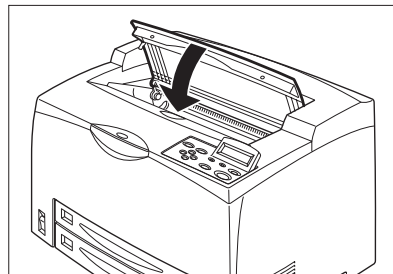

1.4 Installation Procedure

1.4.3 Installing the EP Cartridge

When installing the EP cartridge, take note of the following points:

⚠ WARNING

Never throw an EP cartridge into an open flame. It can cause an explosion and you can get burnt.

- Do not subject it to direct sunlight or strong light.
- When installing the EP cartridge, select a location not subject to strong light and try to finish the installation within 5 minutes.
- Do not touch the surface of the photosensitive drum. Do not stand or place the EP cartridge upside down. The drum might get damaged.
- A drum shutter protects the photosensitive drum from light. Do not open the drum shutter.
- Although the toner is not harmful to the body, wash it off immediately if your hands or clothes are stained with it.
- It is recommended to use up the EP cartridge within 1 year after opening it.

Procedure

Refer to

"5.2.2 Replacing the EP Cartridge" for details when replacing the EP cartridge.

- 1** Open the top cover.

Important

Do not touch any parts inside the printer.

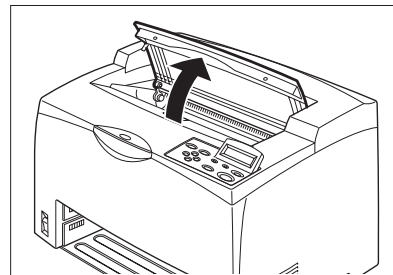

1.4 Installation Procedure

- 2** Take the EP cartridge out of the box and shake it 7 to 8 times as shown in the diagram.

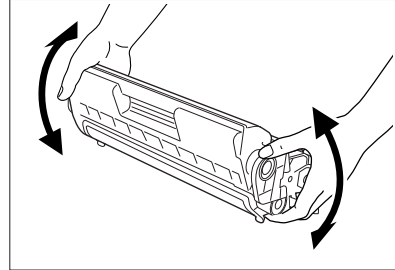

- 3** Place the EP cartridge on a flat surface and pull the seal out horizontally.

Important

- When pulling out the seal, pull it out horizontally. The tape might break if it is pulled out diagonally.
- After the seal has been pulled out, do not shake or bump the EP cartridge.

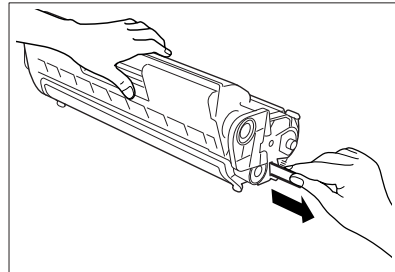

- 4** Hold the EP cartridge by the grip and insert it into the slot inside the printer.

Important

- Do not touch any parts inside the printer.
- Ensure that the EP cartridge is firmly set.

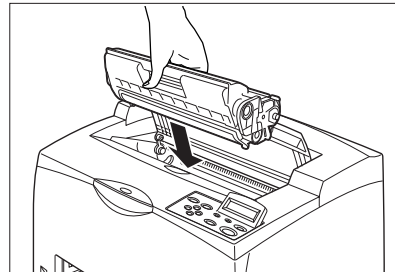

- 5** Close the top cover securely.

