

TEST REPORT

BNetzA-CAB-02/21-102

Test report no.: 1-4576_22-05-08

Testing laboratory

cetecom advanced GmbH

Untertuerkheimer Strasse 6 – 10
66117 Saarbruecken / Germany
Phone: + 49 681 5 98 - 0
Fax: + 49 681 5 98 - 9075
Internet: <https://www.cetecomadvanced.com>
e-mail: mail@cetecomadvanced.com

Accredited Testing Laboratory:

The testing laboratory (area of testing) is accredited according to DIN EN ISO/IEC 17025 (2018-03) by the Deutsche Akkreditierungsstelle GmbH (DAkKS).

The accreditation is valid for the scope of testing procedures as stated in the accreditation certificate with the registration number: D-PL-12047-01-00.

ISED Testing Laboratory Recognized Listing Number: DE0001
FCC designation number: DE0002

Applicant

Marquardt GmbH

Schloss-Str. 16
78604 Rietheim-Weilheim / GERMANY
Phone: +49 7424 99-0
Contact: Gerd Siegel
e-mail: Gerd.Siegel@marquardt.de

Manufacturer

Marquardt GmbH

Schloss-Str. 16
78604 Rietheim-Weilheim / GERMANY

Test standard/s

FCC - Title 47 CFR Part 15 FCC - Title 47 of the Code of Federal Regulations; Chapter I; Part 15 - Radio frequency devices

For further applied test standards please refer to section 3 of this test report.

Test Item

Kind of test item:	Vehicle Key
Model name:	MS7
FCC ID:	IYZMS7
Frequency:	3100 MHz to 10600 MHz
Technology tested:	UWB
Antenna:	Integrated antenna
Power supply:	2.5 V to 3.2 V DC by Battery
Temperature range:	-20°C to +65°C

This test report is electronically signed and valid without handwritten signature. For verification of the electronic signatures, the public keys can be requested at the testing laboratory.

Test report authorized:

Frank Heussner
Lab Manager
Radio Labs

Test performed:

Stephan Thiel
Testing Manager
Radio Labs

1 Table of contents

1	Table of contents	2
2	General information	3
2.1	Notes and disclaimer	3
2.2	Application details	3
2.3	Test laboratories sub-contracted	3
3	Test standard/s, references and accreditations	4
4	Reporting statements of conformity – decision rule	5
5	Test environment	6
6	Test item	6
6.1	General description	6
6.2	Additional information	7
7	Description of the test setup	7
7.1	Shielded semi anechoic chamber	8
7.2	Shielded fully anechoic chamber	10
7.3	Radiated measurements > 18 GHz	12
8	Sequence of testing	13
8.1	Sequence of testing radiated spurious 9 kHz to 30 MHz	13
8.2	Sequence of testing radiated spurious 30 MHz to 1 GHz	14
8.3	Sequence of testing radiated spurious 1 GHz to 18 GHz	15
8.4	Sequence of testing radiated spurious above 18 GHz	16
8.5	Sequence of testing efficient use of spectrum	17
9	Measurement uncertainty	18
10	Summary of measurement results	19
11	Additional comments	19
12	Measurement results	21
12.1	10 dB - Bandwidth	21
12.2	TX Radiated Emissions	25
12.2.1	Radiated emissions channel 5	29
12.2.2	Radiated emissions channel 6	39
12.2.3	Radiated emissions channel 8	49
12.2.4	Radiated emissions channel 9	59
12.3	Efficient use of spectrum acc. to §15.519(a)(1)	69
12.4	Antenna requirements	72
12.5	Conducted emissions < 30MHz	73
13	Glossary	75
14	Document history	76

2 General information

2.1 Notes and disclaimer

The test results of this test report relate exclusively to the test item specified in this test report. cetecom advanced GmbH does not assume responsibility for any conclusions and generalizations drawn from the test results with regard to other specimens or samples of the type of the equipment represented by the test item.

The test report may only be reproduced or published in full. Reproduction or publication of extracts from the report requires the prior written approval of cetecom advanced GmbH.

The testing service provided by cetecom advanced GmbH has been rendered under the current "General Terms and Conditions for cetecom advanced GmbH".

cetecom advanced GmbH will not be liable for any loss or damage resulting from false, inaccurate, inappropriate or incomplete product information provided by the customer.

Under no circumstances does the cetecom advanced GmbH test report include any endorsement or warranty regarding the functionality, quality or performance of any other product or service provided.

Under no circumstances does the cetecom advanced GmbH test report include or imply any product or service warranties from cetecom advanced GmbH, including, without limitation, any implied warranties of merchantability, fitness for purpose, or non-infringement, all of which are expressly disclaimed by cetecom advanced GmbH.

All rights and remedies regarding vendor's products and services for which cetecom advanced GmbH has prepared this test report shall be provided by the party offering such products or services and not by cetecom advanced GmbH.

In no case this test report can be considered as a Letter of Approval.

This test report is electronically signed and valid without handwritten signature. For verification of the electronic signatures, the public keys can be requested at the testing laboratory.

2.2 Application details

Date of receipt of order:	2022-12-14
Date of receipt of test item:	2023-06-19
Start of test:*	2023-06-19
End of test:*	2024-02-05
Person(s) present during the test:	Jan McGowan (2023-06-19)

*Date of each measurement, if not shown in the plot, can be requested. Dates are stored in the measurement software.

2.3 Test laboratories sub-contracted

None

3 Test standard/s, references and accreditations

Test standard	Date	Description
FCC - Title 47 CFR Part 15		FCC - Title 47 of the Code of Federal Regulations; Chapter I; Part 15 - Radio frequency devices

Guidance	Version	Description
ANSI C63.4-2014	-/-	American National Standard for Methods of Measurement of Radio-Noise Emissions from Low-Voltage Electrical and Electronic Equipment in the Range of 9 kHz to 40 GHz
ANSI C63.10-2013	-/-	American National Standard of Procedures for Compliance Testing of Unlicensed Wireless Devices
UWB KDB	v02r01	393764 D01 UWB FAQ v02r01: ULTRA-WIDEBAND (UWB) DEVICES FREQUENTLY ASKED QUESTIONS

4 Reporting statements of conformity – decision rule

Only the measured values related to their corresponding limits will be used to decide whether the equipment under test meets the requirements of the test standards listed in chapter 3.

The measurement uncertainty is mentioned in this test report, see chapter 9, but is not taken into account - neither to the limits nor to the measurement results. Measurement results with a smaller margin to the corresponding limits than the measurement uncertainty have a potential risk of more than 5% that the decision might be wrong.

measured value, measurement uncertainty, verdict

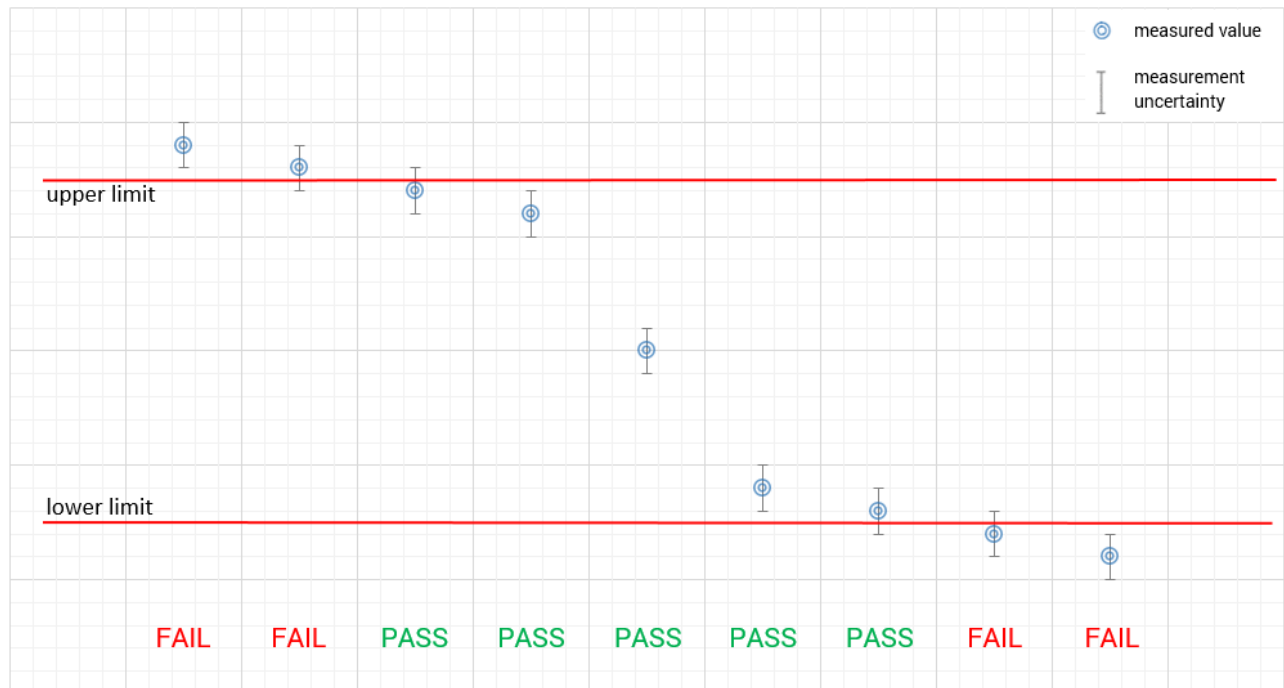

5 Test environment

Temperature	:	T_{nom} +22 °C during room temperature tests T_{max} -/- no high temperature tests T_{min} -/- no low temperature tests
Relative humidity content	:	49 %
Barometric pressure	:	Not relevant for this kind of testing
Power supply	:	V_{nom} 3.0 V DC by Battery V_{max} -/- V V_{min} -/- V

6 Test item

6.1 General description

Kind of test item	:	Vehicle Key
Model name	:	MS7
S/N serial number	:	EUT1: "DUT-C", "Kalibriermuster", no S/N EUT2: "DUT-SER-T1", "Kalibriermuster", no S/N EUT3: no S/N (Part of complete communication system)
Power setting	:	UWB channel 5: Power setting 12 UWB channel 6: Power setting 24 UWB channel 8: Power setting 10 UWB channel 9: Power setting 12
Hardware status	:	23/22.00
Software status	:	23/21.00
Frequency band	:	3100 MHz to 10600 MHz
Type of radio transmission	:	Pulse
Use of frequency spectrum	:	
Type of modulation	:	BPSK / BPM
Number of channels	:	4 (UWB channel 5, 6, 8 & 9)
Antenna	:	Integrated antenna
Power supply	:	2.5 V to 3.2 V DC by Battery
Temperature range	:	-20°C to +65°C

6.2 Additional information

The content of the following annexes is defined in the QA. It may be that not all of the listed annexes are necessary for this report, thus some values in between may be missing.

Test setup and EUT photos are included in test report:

- 1-4576/22-05-01_AnnexA
- 1-4576/22-05-01_AnnexB
- 1-4576/22-05-01_AnnexD
- Note: The referenced photos show EUT delivered by the customer in this project, not necessarily the exact one used for the specific tests. EUT identification shown in the photos may differ.

7 Description of the test setup

Typically, the calibrations of the test apparatus are commissioned to and performed by an accredited calibration laboratory. The calibration intervals are determined in accordance with the DIN EN ISO/IEC 17025. In addition to the external calibrations, the laboratory executes comparison measurements with other calibrated test systems or effective verifications. Weekly chamber inspections and range calibrations are performed. Where possible, RF generating and signaling equipment as well as measuring receivers and analyzers are connected to an external high-precision 10 MHz reference (GPS-based or rubidium frequency standard).

In order to simplify the identification of the equipment used at some special tests, some items of test equipment and ancillaries can be provided with an identifier or number in the equipment list below (Lab/Item).

Agenda: Kind of Calibration

k	calibration / calibrated	EK	limited calibration
ne	not required (k, ev, izw, zw not required)	zw	cyclical maintenance (external cyclical maintenance)
ev	periodic self verification	izw	internal cyclical maintenance
Ve	long-term stability recognized	g	blocked for accredited testing
vlk!!	Attention: extended calibration interval		
NK!	Attention: not calibrated	*)	next calibration ordered / currently in progress

7.1 Shielded semi anechoic chamber

The radiated measurements are performed in vertical and horizontal plane in the frequency range from 30 MHz to 1 GHz in semi-anechoic chambers. The EUT is positioned on a non-conductive support with a height of 0.80 m above a conductive ground plane that covers the whole chamber. The receiving antennas are conform to specifications ANSI C63. These antennas can be moved over the height range between 1.0 m and 4.0 m in order to search for maximum field strength emitted from EUT. The measurement distances between EUT and receiving antennas are indicated in the test setups for the various frequency ranges. For each measurement, the EUT is rotated in all three axes until the maximum field strength is received. The wanted and unwanted emissions are received by spectrum analyzers where the detector modes and resolution bandwidths over various frequency ranges are set according to requirement ANSI C63.

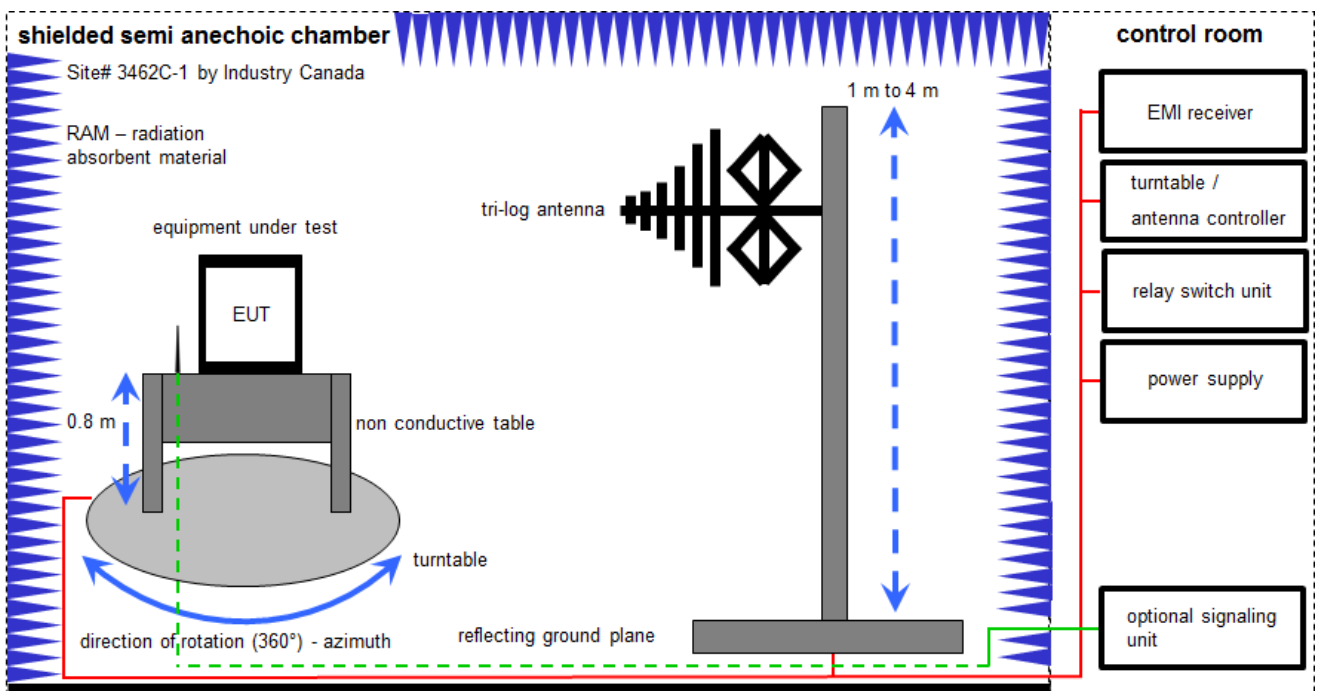

Measurement distance: tri-log antenna 10 meter

$$FS = UR + CL + AF$$

(FS-field strength; UR-voltage at the receiver; CL-loss of the cable; AF-antenna factor)

Example calculation:

$$FS \text{ [dB}\mu\text{V/m]} = 12.35 \text{ [dB}\mu\text{V/m]} + 1.90 \text{ [dB]} + 16.80 \text{ [dB/m]} = 31.05 \text{ [dB}\mu\text{V/m]} \text{ (35.69 } \mu\text{V/m)}$$

Equipment table:

No.	Lab / Item	Equipment	Type	Manufacturer	Serial No.	INV. No.	Kind of Calibration	Last Calibration	Next Calibration
1	45	Switch-Unit	3488A	HP	2719A14505	300000368	ev	-/-	-/-
2	50	DC power supply, 60Vdc, 50A, 1200 W	6032A	HP	2920A04466	300000580	ne	-/-	-/-
3	93	Semi anechoic chamber	3000023	MWB AG		300000551	ne	-/-	-/-
4	n. a.	TRILOG Broadband Test-Antenna 30 MHz - 3 GHz	VULB9163	Schwarzbeck Mess - Elektronik	216	300003288	vKI!	31.08.2023	31.08.2025
5	n. a.	Antenna Tower	Model 2175	ETS-Lindgren	64762	300003745	izw	-/-	-/-
6	n. a.	Positioning Controller	Model 2090	ETS-Lindgren	64672	300003746	izw	-/-	-/-
7	n. a.	Turntable	2089-4.0	EMCO		300004394	ne	-/-	-/-
8	n. a.	EMI Test Receiver	ESR3	Rohde & Schwarz	102587	300005771	k	06.12.2023	31.12.2024

7.2 Shielded fully anechoic chamber

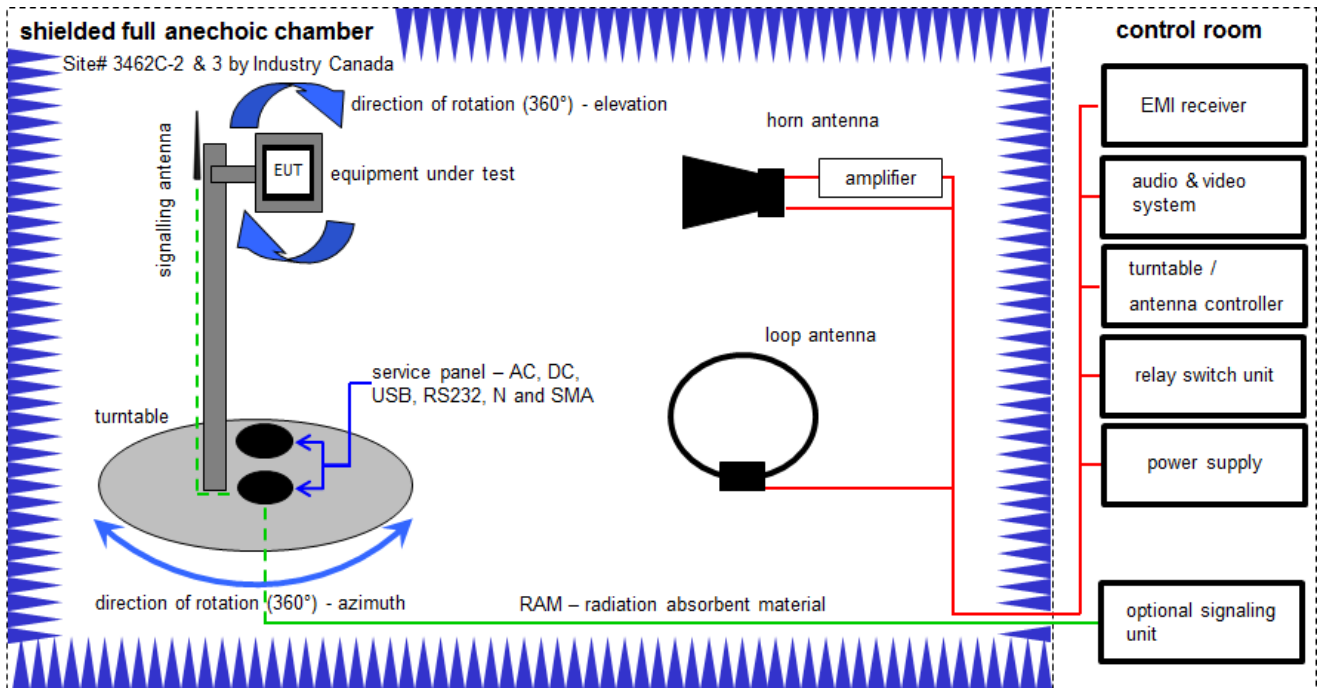

Measurement distance: horn antenna 3 meter / 1 meter; loop antenna 3 meter

$$FS = UR + CA + AF$$

(FS-field strength; UR-voltage at the receiver; CA-loss of the signal path; AF-antenna factor)

Example calculation:

$$FS [dB\mu V/m] = 40.0 [dB\mu V/m] + (-35.8) [dB] + 32.9 [dB/m] = 37.1 [dB\mu V/m] (71.61 \mu V/m)$$

$$OP = AV + D - G + CA$$

(OP-radiated output power; AV-analyzer value; D-free field attenuation of measurement distance; G-antenna gain+amplifier gain; CA-loss signal path)

Example calculation:

$$OP [dBm] = -65.0 [dBm] + 50 [dB] - 20 [dBi] + 5 [dB] = -30 [dBm] (1 \mu W)$$

Equipment table: Halle C

No.	Lab / Item	Equipment	Type	Manufacturer	Serial No.	INV. No.	Kind of Calibration	Last Calibration	Next Calibration
1	n. a.	4U RF Switch Platform	L4491A	Agilent Technologies	MY50000037	300004509	ne	-/-	-/-
2	90	Active Loop Antenna 9 kHz to 30 MHz	6502	EMCO/2	8905-2342	300000256	vIKI!	19.07.2023	31.07.2025
3	n. a.	Anechoic chamber	FAC 3/5m	MWB / TDK	87400/02	300000996	ev	-/-	-/-
4	n. a.	EMI Test Receiver 20Hz- 26,5GHz	ESU26	R&S	100037	300003555	k	11.12.2023	31.12.2024
5	n. a.	NEXIO EMV-Software	BAT EMC V2022.0.32.0	Nexio		300004682	ne	-/-	-/-

Equipment table (OTA):

No.	Lab / Item	Equipment	Type	Manufacturer	Serial No.	INV. No.	Kind of Calibration	Last Calibration	Next Calibration
1	n. a.	Power supply GPIB dc power supply, 0-50 Vdc, 0-2 A	6633A	HP	2851A01222	300001530	vIKI!	15.12.2022	31.12.2025
2	n. a.	Double-Ridged Waveguide Horn Antenna 1-18.0GHz	3115	EMCO	9709-5290	300000212	ne	-/-	-/-
3	n. a.	CTIA-Chamber	CTIA-Chamber AMS 8500	ETS-Lindgren Finland		300003327	ne	-/-	-/-
4	n. a.	CTIA-Chamber - Positioning Equipment	CTIA-Chamber - Positioning Equipment	EMCO/2		300003328	ne	-/-	-/-
5	n. a.	RF Amplifier	AMF-7D-01001800-22-10P	NARDA-MITEQ Inc	2089864	300005633	ev	-/-	-/-
6	n. a.	Lowpass Filter (Chebyshev)	WLKX14-4700-4900-21000-30SS	Wainwright Instruments GmbH	1	300005655	ev	-/-	-/-
7	n. a.	High Pass Filter (Chebyshev)	WHNX6-8374-10600-26500-40CC	Wainwright Instruments GmbH	1	300005656	ev	-/-	-/-
8	n. a.	Signal analyzer	FSW26	Rohde&Schwarz	101371	300005697	k	07.12.2023	31.12.2024
9	n. a.	Software	EMC32-MEB	Rohde & Schwarz		300005477	ne	-/-	-/-
10	A039	Std. Gain Horn Antenna 11.90-18.00 GHz	1824-20	Flann	263	300002471	ne	-/-	-/-
11	n. a.	Std. Gain Horn Antenna	1840-20	Flann	268	300001200	k	26.07.2022	31.07.2024

7.3 Radiated measurements > 18 GHz

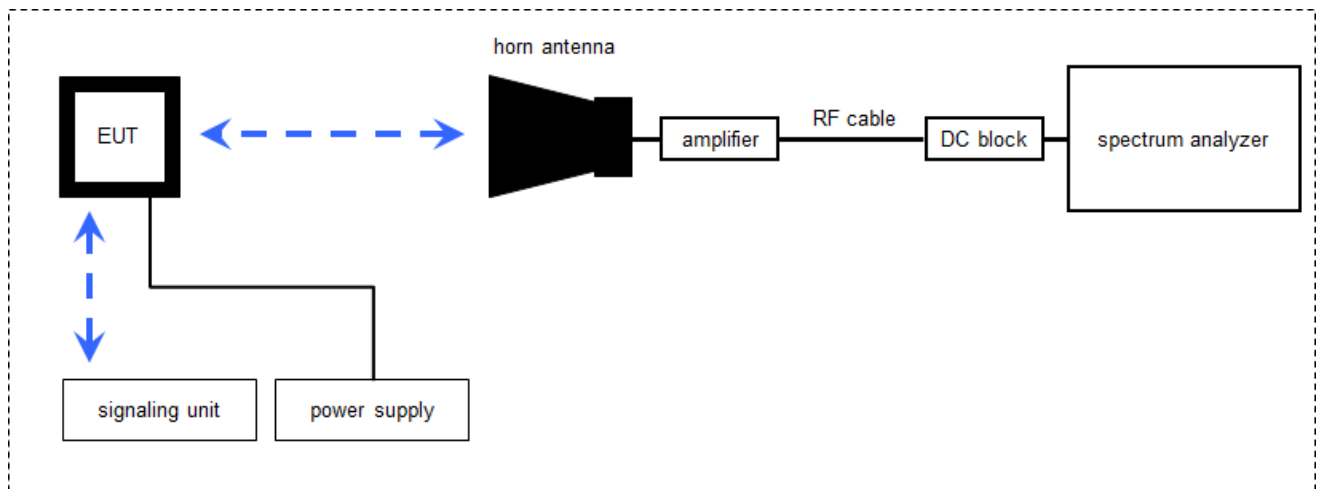

Measurement distance: horn antenna e.g. 75 cm

$$FS = UR + CA + AF$$

(FS-field strength; UR-voltage at the receiver; CA-loss signal path & distance correction; AF-antenna factor)

Example calculation:

$$FS [dB\mu V/m] = 40.0 [dB\mu V/m] + (-60.1) [dB] + 36.74 [dB/m] = 16.64 [dB\mu V/m] (6.79 \mu V/m)$$

$$OP = AV + D - G + CA$$

(OP-radiated output power; AV-analyzer value; D-free field attenuation of measurement distance; G-antenna gain+amplifier gain; CA-loss signal path)

Example calculation:

$$OP [dBm] = -59.0 [dBm] + 44.0 [dB] - 20.0 [dBi] + 5.0 [dB] = -30 [dBm] (1 \mu W)$$

Equipment table:

No.	Lab / Item	Equipment	Type	Manufacturer	Serial No.	INV. No.	Kind of Calibration	Last Calibration	Next Calibration
1	n. a.	Broadband LNA 18-50 GHz	CBL18503070PN	CERNEX	25240	300004948	ev	09.03.2022	08.03.2024
2	n. a.	Power Supply	E3632A	Agilent Technologies	MY40001320	400000396	vIKI!	14.12.2021	31.12.2024
3	n. a.	Signal- and Spectrum Analyzer 2 Hz - 50 GHz	FSW50	Rohde&Schwarz	101332	300005935	k	24.01.2024	23.01.2025
4	n. a.	Signal- and Spectrum Analyzer 2 Hz - 50 GHz	FSW50	Rohde&Schwarz	101560	300006179	k	17.01.2024	31.01.2025
5	A027	Std. Gain Horn Antenna 18.0-26.5 GHz	638	Narda	01096	300000486	vIKI!	24.01.2024	23.01.2026
6	A031	Std. Gain Horn Antenna 26.5-40.0 GHz	V637	Narda	82-16	300000510	vIKI!	24.01.2024	23.01.2026

8 Sequence of testing

8.1 Sequence of testing radiated spurious 9 kHz to 30 MHz

Setup

- The equipment is set up to simulate normal operation mode as described in the user manual or defined by the manufacturer.
- If the EUT is a tabletop system, it is placed on a table with 0.8 m height.
- If the EUT is a floor standing device, it is placed directly on the turn table.
- Auxiliary equipment and cables are positioned to simulate normal operation conditions as described in ANSI C 63.4.
- The AC power port of the EUT (if available) is connected to a power outlet below the turntable.
- Measurement distance is 3 m (see ANSI C 63.4) – see test details.
- EUT is set into operation.

Premeasurement*

- The turntable rotates from 0° to 315° using 45° steps.
- The antenna height is 1 m.
- At each turntable position the analyzer sweeps with positive-peak detector to find the maximum of all emissions.

Final measurement

- Identified emissions during the pre-measurement are maximized by the software by rotating the turntable from 0° to 360°.
- Loop antenna is rotated about its vertical axis for maximum response at each azimuth about the EUT. (For certain applications, the loop antenna plane may also need to be positioned horizontally at the specified distance from the EUT)
- The final measurement is done in the position (turntable and elevation) causing the highest emissions with quasi-peak (as described in ANSI C 63.4).
- Final levels, frequency, measuring time, bandwidth, turntable position, correction factor, margin to the limit and limit will be recorded. A plot with the graph of the premeasurement and the limit is stored.

*Note: The sequence will be repeated three times with different EUT orientations.

8.2 Sequence of testing radiated spurious 30 MHz to 1 GHz

Setup

- The equipment is set up to simulate normal operation mode as described in the user manual or defined by the manufacturer.
- If the EUT is a tabletop system, a table with 0.8 m height is used, which is placed on the ground plane.
- If the EUT is a floor standing device, it is placed on the ground plane with insulation between both.
- Auxiliary equipment and cables are positioned to simulate normal operation conditions as described in ANSI C 63.4.
- The AC power port of the EUT (if available) is connected to a power outlet below the turntable.
- Measurement distance is 10 m or 3 m (see ANSI C 63.4) – see test details.
- EUT is set into operation.

Premeasurement

- The turntable rotates from 0° to 315° using 45° steps.
- The antenna is polarized vertical and horizontal.
- The antenna height changes from 1 m to 3 m.
- At each turntable position, antenna polarization and height the analyzer sweeps three times in peak to find the maximum of all emissions.

Final measurement

- The final measurement is performed for at least six highest peaks according to the requirements of the ANSI C63.4.
- Based on antenna and turntable positions at which the peak values are measured the software maximize the peaks by changing turntable position $\pm 45^\circ$ and antenna height between 1 and 4 m.
- The final measurement is done with quasi-peak detector (as described in ANSI C 63.4).
- Final levels, frequency, measuring time, bandwidth, antenna height, antenna polarization, turntable angle, correction factor, margin to the limit and limit are recorded. A plot with the graph of the premeasurement with marked maximum final results and the limit is stored.

8.3 Sequence of testing radiated spurious 1 GHz to 18 GHz

Setup

- The equipment is set up to simulate normal operation mode as described in the user manual or defined by the manufacturer.
- If the EUT is a tabletop system, a 2-axis positioner with 1.5 m height is used.
- If the EUT is a floor standing device, it is placed directly on the turn table.
- Auxiliary equipment and cables are positioned to simulate normal operation conditions as described in ANSI C 63.4.
- The AC power port of the EUT (if available) is connected to a power outlet below the turntable.
- Measurement distance is 3 m (see ANSI C 63.4) – see test details.
- EUT is set into operation.

Premeasurement

- The turntable rotates from 0° to 315° using 45° steps.
- The antenna is polarized vertical and horizontal.
- The antenna height is 1.5 m.
- At each turntable position and antenna polarization the analyzer sweeps with positive peak detector to find the maximum of all emissions.

Final measurement

- The final measurement is performed for at least six highest peaks according to the requirements of the ANSI C63.4.
- Based on antenna and turntable positions at which the peak values are measured the software maximizes the peaks by rotating the turntable from 0° to 360°. This measurement is repeated for different EUT-table positions (0° to 150° in 30°-steps) and for both antenna polarizations.
- The final measurement is done in the position (turntable, EUT-table and antenna polarization) causing the highest emissions with Peak and RMS detector (as described in ANSI C 63.4).
- Final levels, frequency, measuring time, bandwidth, turntable position, EUT-table position, antenna polarization, correction factor, margin to the limit and limit are recorded. A plot with the graph of the premeasurement with marked maximum final results and the limit is stored.

8.4 Sequence of testing radiated spurious above 18 GHz

Setup

- The equipment is set up to simulate normal operation mode as described in the user manual or defined by the manufacturer.
- Auxiliary equipment and cables are positioned to simulate normal operation conditions as described in ANSI C 63.4.
- The AC power port of the EUT (if available) is connected to a power outlet.
- The measurement distance is as appropriate (e.g. 0.5 m).
- The EUT is set into operation.

Premeasurement

- The test antenna is handheld and moved carefully over the EUT to cover the EUT's whole sphere and different polarizations of the antenna.

Final measurement

- The final measurement is performed at the position and antenna orientation causing the highest emissions with Peak and RMS detector (as described in ANSI C 63.4).
- Final levels, frequency, measuring time, bandwidth, correction factor, margin to the limit and limit are recorded. A plot with the graph of the premeasurement and the limit is stored.

8.5 Sequence of testing efficient use of spectrum

Setup

- The equipment is set up to simulate normal operation mode as described in the user manual or defined by the manufacturer.
- The EUT positioned at a distance of approx. 0.5m to the horn antenna used for the measurement.
- The associated receiver is positioned between the EUT the horn antenna to assure that the received signal level of the associated receiver at the spectrum analyzer is higher than the level of the EUT.

Measurement:

- Switch on EUT and associated receiver and wait until the connection is established.
- Start Analyzer sweep in Zerospan with a sweep time of 15 s.
- Switch of the associated receiver.
- When switching of the associated receiver, a drop in the received signal level at the spectrum analyzer can be observed. → position marker 1
- Position marker two at the point where the transmission of the EUT stops.
- Measure time difference between marker 1 and marker 2.

9 Measurement uncertainty

Test case	Uncertainty
Equivalent isotropically radiated power (e.i.r.p.)	Conducted value ± 1 dB Radiated value ± 3 dB
Permitted range of operating frequencies	± 100 kHz
Conducted unwanted emissions in the spurious domain (up to 18 GHz)	± 1 dB
Radiated unwanted emissions in the spurious domain (up to 18 GHz)	± 3 dB
Conducted unwanted emissions in the spurious domain (18 to 40 GHz)	± 4 dB
Radiated unwanted emissions in the spurious domain (18 to 40 GHz)	± 4 dB
Conducted unwanted emissions in the spurious domain (40 to 50 GHz)	± 4.5 dB
Radiated unwanted emissions in the spurious domain (40 to 50 GHz)	± 4.5 dB
Conducted unwanted emissions in the spurious domain (above 50 GHz)	± 5 dB
Radiated unwanted emissions in the spurious domain (above 50 GHz)	± 5 dB
DC and low frequency voltages	± 3 %
Temperature	± 1 °C
Humidity	± 3 %

10 Summary of measurement results

<input checked="" type="checkbox"/>	No deviations from the technical specifications were ascertained
<input type="checkbox"/>	There were deviations from the technical specifications ascertained
<input type="checkbox"/>	This test report is only a partial test report. The content and verdict of the performed test cases are listed below.

TC Identifier	Description	Verdict	Date	Remark
RF-Testing	CFR47 §15.207, §15.209, §15.503, §15.519, §15.521	see table	2024-03-26	-/-

Test specification clause	Test case	Temperature conditions	Power source	Pass	Fail	NA	NP	Remark
§15.503 §15.519(b)	10 dB Bandwidth	Nominal	Nominal	<input checked="" type="checkbox"/>	<input type="checkbox"/>	<input type="checkbox"/>	<input type="checkbox"/>	complies
§15.209 §15.519 §15.521	TX Radiated Emissions	Nominal	Nominal	<input checked="" type="checkbox"/>	<input type="checkbox"/>	<input type="checkbox"/>	<input type="checkbox"/>	complies
§15.519(a)(1)	Efficient use of spectrum	Nominal	Nominal	<input checked="" type="checkbox"/>	<input type="checkbox"/>	<input type="checkbox"/>	<input type="checkbox"/>	complies
§15.519(a)(2) §15.521 (b) §§15.203 & 15.204	Antenna requirement	-/-	-/-	<input checked="" type="checkbox"/>	<input type="checkbox"/>	<input type="checkbox"/>	<input type="checkbox"/>	complies
§15.521(j) §15.207	Conducted emissions < 30 MHz	Nominal	Nominal	<input type="checkbox"/>	<input type="checkbox"/>	<input checked="" type="checkbox"/>	<input type="checkbox"/>	-/-

Note: NA = Not Applicable; NP = Not Performed

11 Additional comments

Reference documents: None

Special test descriptions: None

Configuration descriptions: None

- Test mode:
- No test mode available.
 - Special test mode/software is used.

Test device (EUT):

- EUT 1:
 - Option 1: UWB emissions are turned on and the below described test mode is used.
 - Options can be selected by different buttons or different duration of pressing the buttons.
 - DUT is powered by battery.
- EUT 2: UWB emissions are turned on and the below described test mode is used. DUT is powered by external power supply. This DUT is used for long-lasting measurements.
- EUT 3: DUT in normal operation mode. DUT is part of complete communication system and is used for Efficient use of spectrum test

Associated UWB equipment (AE):

- AE 1: Complete communication system used for Efficient use of spectrum test. The system is preconfigured by the manufacturer. No further configurations required.

Description of test modes as declared by customer:

- UWB test mode (Test mode 1):
 - EUT 1: Cycle time 3 ms
 - EUT 2: Cycle time 2 ms
 - Remaining transmission parameters as in case of normal operation mode
 - Parameters (e.g. payload) selected so that the maximum average and peak output power is obtained
- Normal mode:
 - UWB emissions are turned on and the normal mode (intended use) is used.

12 Measurement results

12.1 10 dB - Bandwidth

Description:

Measurement of the -10 dB bandwidth of the wanted signal.

§15.503(a)

UWB bandwidth. For the purpose of this subpart, the UWB bandwidth is the frequency band bounded by the points that are 10 dB below the highest radiated emission, as based on the complete transmission system including the antenna. The upper boundary is designated f_H and the lower boundary is designated f_L . The frequency at which the highest radiated emission occurs is designated f_M .

§15.503(b)

Center frequency. The center frequency, f_C , equals $(f_H + f_L)/2$.

§15.503(c)

Fractional bandwidth. The fractional bandwidth equals $2(f_H - f_L) / (f_H + f_L)$.

Limits and provisions:

§15.503(d)

Ultra-wideband (UWB) transmitter. An intentional radiator that, at any point in time, has a fractional bandwidth equal to or greater than 0.20 or has a UWB bandwidth equal to or greater than 500 MHz, regardless of the fractional bandwidth.

§15.519(b)

The UWB bandwidth of a device operating under the provisions of this section must be contained between 3100 MHz and 10,600 MHz.

Lower -10 dB point > 3.1 GHz Upper -10 dB point < 10.6 GHz

-10 dB bandwidth \geq 500 MHz or -10 dB fractional bandwidth > 0.2
--

Measurement:

Measurement parameter	
Detector:	Pos-Peak
Resolution bandwidth:	1 MHz
Video bandwidth:	3 MHz
Trace-Mode:	Max Hold

Note: ANSI C63.10-2013 §10.1.

Results:

EUT	UWB channel	Lower -10 dB point [GHz]	Higher -10 dB point [GHz]	UWB bandwidth [MHz]	Plot
1	5	6.208	6.758	550	Plot 1
1	6	6.704	7.293	589	Plot 2
1	8	7.205	7.792	586	Plot 3
1	9	7.681	8.293	612	Plot 4

Verdict: Compliant

Plot 1: 10 dB bandwidth, UWB test mode channel 5

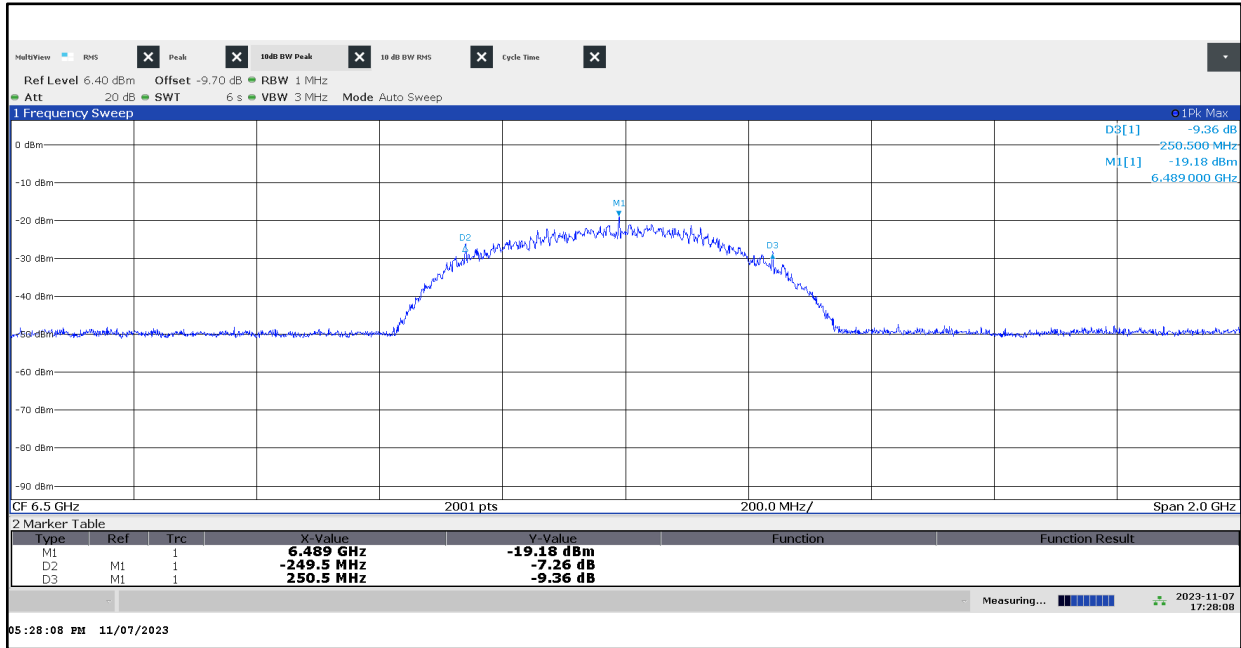

Plot 2: 10 dB bandwidth, UWB test mode channel 6

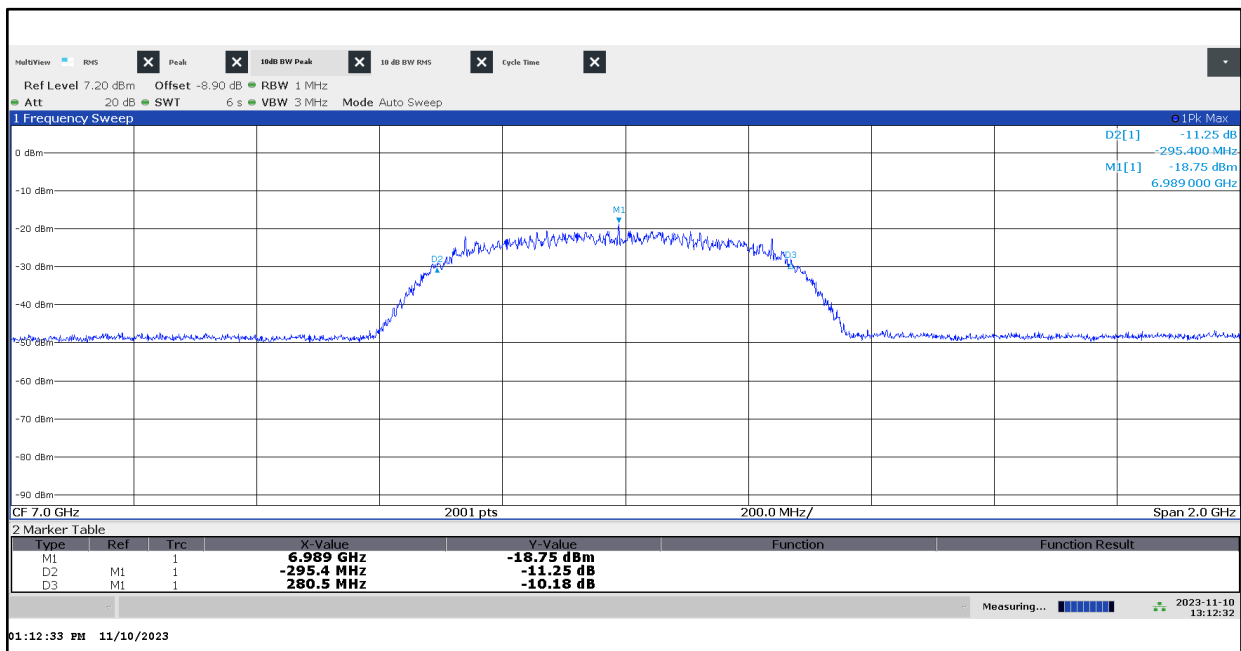

Plot 3: 10 dB bandwidth, UWB test mode channel 8

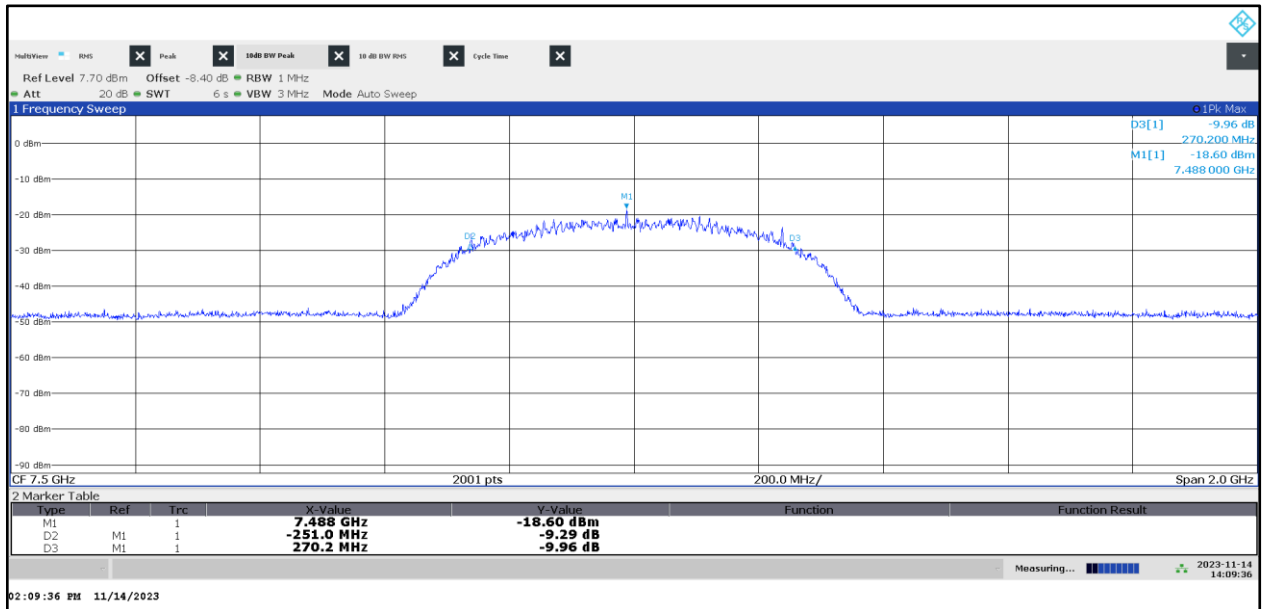

Plot 4: 10 dB bandwidth, UWB test mode channel 9

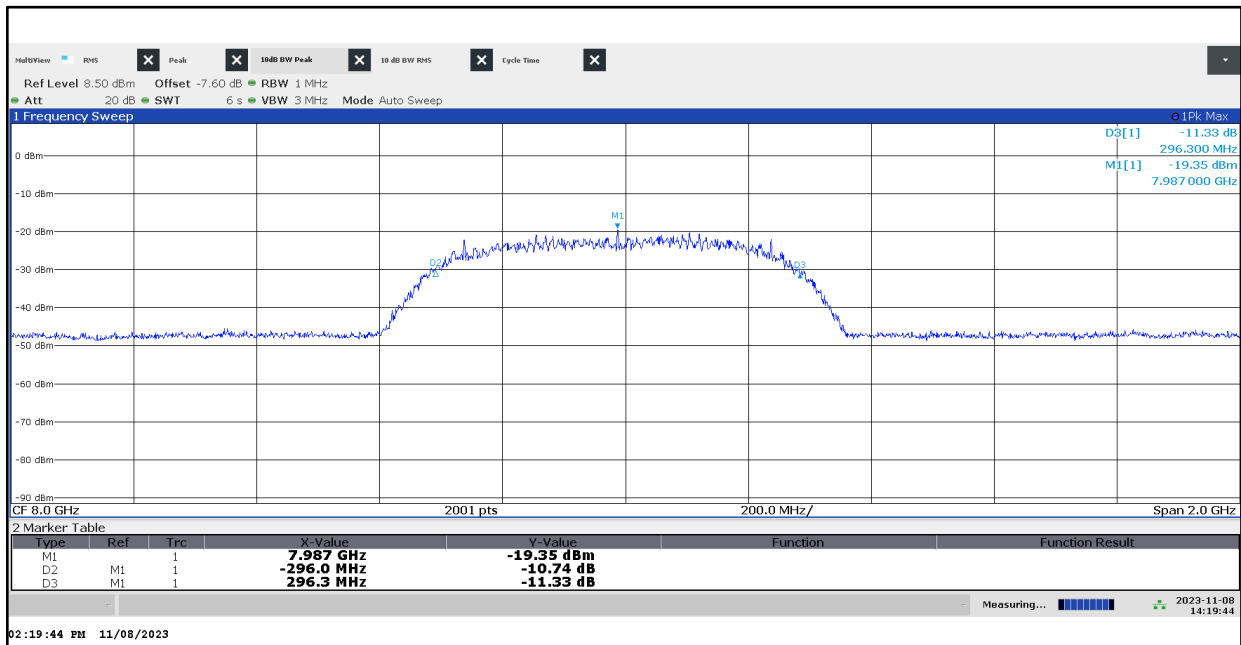

12.2 TX Radiated Emissions

Description:

Measurement of the radiated emissions in transmit mode.

Limits and provisions:

Radiated emissions at or below 960 MHz (§15.209):

Frequency (MHz)	Field strength ($\mu\text{V}/\text{m}$)	Measurement distance (m)
0.009 – 0.490	2400/F(kHz)	300
0.490 – 1.705	24000/F(kHz)	30
1.705 – 30	30 (29.5 dB $\mu\text{V}/\text{m}$)	30
30 – 88	100 (40 dB $\mu\text{V}/\text{m}$)	3
88 – 216	150 (43.5 dB $\mu\text{V}/\text{m}$)	3
216 – 960	200 (46 dB $\mu\text{V}/\text{m}$)	3
> 960	500 (54 dB $\mu\text{V}/\text{m}$)	3

§15.519 (c)

The radiated emissions at or below 960 MHz from a device operating under the provisions of this section shall not exceed the emission levels in §15.209.

The radiated emissions above 960 MHz from a device operating under the provisions of this section shall not exceed the following average limits based on measurements using a resolution bandwidth of 1 MHz:

Frequency in MHz	EIRP in dBm
960 to 1610	-75.3
1610 to 1990	-63.3
1990 to 3100	-61.3
3100 to 10600	-41.3
Above 10600	-61.3

§15.519 (d)

In addition to the radiated emission limits specified in the table in paragraph of §15.519 (c), UWB transmitters operating under the provisions of this section shall not exceed the following average limits when measured using a resolution bandwidth of no less than 1 kHz:

Frequency in MHz	EIRP in dBm
1164 to 1240	-85.3
1559 to 1610	-85.3

§15.519 (e)

There is a limit on the peak level of the emissions contained within a 50 MHz bandwidth centered on the frequency at which the highest radiated emission occurs, f_m . That limit is 0 dBm EIRP. It is acceptable to employ a different resolution bandwidth, and a correspondingly different peak emission limit, following the procedures described in §15.521.

§15.521 (c)

Emissions from digital circuitry used to enable the operation of the UWB transmitter shall comply with the limits in §15.209, rather than the limits specified in this subpart, provided it can be clearly demonstrated that those emissions from the UWB device are due solely to emissions from digital circuitry contained within the transmitter and that the emissions are not intended to be radiated from the transmitter's antenna. Emissions from associated digital devices, as defined in §15.3(k), e.g., emissions from digital circuitry used to control additional functions or capabilities other than the UWB transmission, are subject to the limits contained in Subpart B of this part.

§15.521 (d)

Within the tables in §§15.509, 15.511, 15.513, 15.515, 15.517, and 15.519, the tighter emission limit applies at the band edges. Radiated emission levels at and below 960 MHz are based on measurements employing a CISPR quasi-peak detector. Radiated emission levels above 960 MHz are based on RMS average measurements over a 1 MHz resolution bandwidth. The RMS average measurement is based on the use of a spectrum analyzer with a resolution bandwidth of 1 MHz, an RMS detector, and a 1 millisecond or less averaging time. Unless otherwise stated, if pulse gating is employed where the transmitter is quiescent for intervals that are long compared to the nominal pulse repetition interval, measurements shall be made with the pulse train gated on. Alternative measurement procedures may be considered by the Commission.

§15.521 (e)

The frequency at which the highest radiated emission occurs, f_M , must be contained within the UWB bandwidth.

§15.521 (g)

When a peak measurement is required, it is acceptable to use a resolution bandwidth other than the 50 MHz specified in this subpart. This resolution bandwidth shall not be lower than 1 MHz or greater than 50 MHz, and the measurement shall be centered on the frequency at which the highest radiated emission occurs, f_M . If a resolution bandwidth other than 50 MHz is employed, the peak EIRP limit shall be $20 \log(\text{RBW}/50)$ dBm where RBW is the resolution bandwidth in megahertz that is employed. This may be converted to a peak field strength level at 3 meters using $E(\text{dBuV/m}) = P(\text{dBm EIRP}) + 95.2$. If RBW is greater than 3 MHz, the application for certification filed with the Commission must contain a detailed description of the test procedure, calibration of the test setup, and the instrumentation employed in the testing.

§15.521 (h)

The highest frequency employed in §15.33 to determine the frequency range over which radiated measurements are made shall be based on the center frequency, f_C , unless a higher frequency is generated within the UWB device. For measuring emission levels, the spectrum shall be investigated from the lowest frequency generated in the UWB transmitter, without going below 9 kHz, up to the frequency range shown in §15.33(a) or up to $f_C + 3/(\text{pulse width in seconds})$, whichever is higher. There is no requirement to measure emissions beyond 40 GHz provided f_C is less than 10 GHz; beyond 100 GHz if f_C is at or above 10 GHz and below 30 GHz; or beyond 200 GHz if f_C is at or above 30 GHz.

Measurement:**§15.209:**

Measurement parameter	
Detector:	Peak/QPeak
Sweep time:	1 s
Resolution bandwidth:	120kHz
Video bandwidth:	≥ RBW
Trace-Mode:	Max Hold

§15.519(c):

Measurement parameter	
Detector:	RMS
Sweep time:	1 ms/pt
Resolution bandwidth:	1 MHz
Video bandwidth:	3 MHz
Trace-Mode:	Max Hold

Note: Evaluating rms-average power spectral density ANSI C63.10-2013 §10.3.7

§15.519(d):

Measurement parameter	
Detector:	RMS
Sweep time:	1 ms/pt
Resolution bandwidth:	30 kHz / 1 kHz
Video bandwidth:	300 kHz / 3 kHz
Trace-Mode:	Max Hold

Note: Spectral line measurement ANSI C63.10-2013 §10.3.10

§15.519(e):

Measurement parameter	
Detector:	Pos-Peak
Resolution bandwidth:	50 MHz
Video bandwidth:	80 MHz
Span:	Zero span
Trace-Mode:	Max Hold

Results:Measurements of the fundamental emission:

EUT	UWB channel	Frequency [GHz]	Max e.i.r.p. [dBm/MHz]	Applicable limit [dBm/MHz]	Margin [dB]	Plot
			average value			
1	5	6.554	-41.81	-41.30	0.51	Plot 5
1	6	7.066	-41.61	-41.30	0.31	Plot 18
1	8	7.552	-41.47	-41.30	0.17	Plot 31
1	9	8.051	-41.79	-41.30	0.49	Plot 44

EUT	UWB channel	Frequency [GHz]	Max e.i.r.p. [dBm/50 MHz]	Applicable limit [dBm/50 MHz]	Margin [dB]	Plot
			peak value			
1	5	6.554	-5.58	0	5.58	Plot 6
1	6	7.066	-5.72	0	5.72	Plot 19
1	8	7.552	-5.70	0	5.70	Plot 32
1	9	8.051	-5.50	0	5.50	Plot 45

Emissions outside the band:

Frequency f [MHz]	Detector	Measured level [dB μ V/m]	Limit [dB μ V/m]	Margin [dB]
Please refer to the following plots for more information on the level of spurious emissions				
-/-	-/-	-/-	-/-	-/-
-/-	-/-	-/-	-/-	-/-
-/-	-/-	-/-	-/-	-/-

Frequency f [MHz]	Detector	Measured level [dBm]	Limit [dBm]	Margin [dB]
Please refer to the following plots for more information on the level of spurious emissions				
-/-	-/-	-/-	-/-	-/-
-/-	-/-	-/-	-/-	-/-
-/-	-/-	-/-	-/-	-/-

Verdict: Compliant

12.2.1 Radiated emissions channel 5

Plot 5: Fundamental emission (UWB test mode): RMS

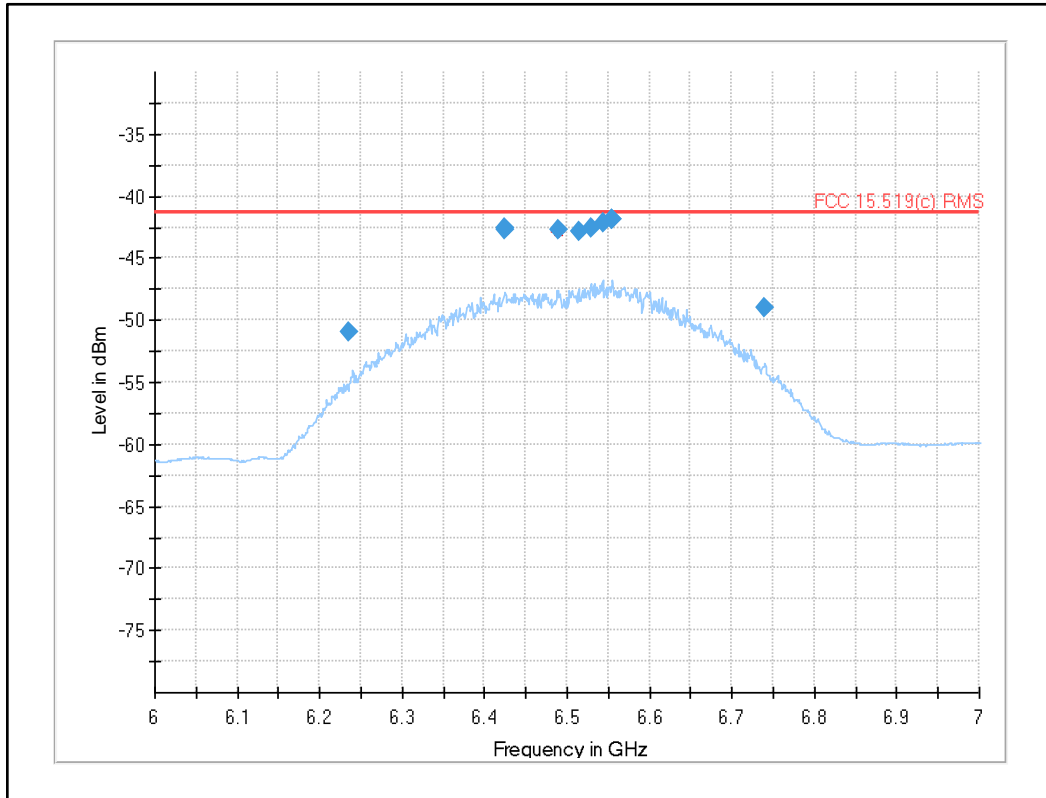

Frequency (MHz)	RMS (dBm)	Limit (dBm)	Margin (dB)	Bandwidth (kHz)	Pol	Azimuth (deg)	Elevation (deg)	Corr. (dB)
6234.513000	-51.01	-41.30	9.71	1000.000	H	339.0	82.0	-117.2
6425.138600	-42.63	-41.30	1.33	1000.000	H	342.0	89.0	-116.8
6425.153600	-42.65	-41.30	1.35	1000.000	H	342.0	87.0	-116.8
6489.604800	-42.78	-41.30	1.48	1000.000	H	341.0	88.0	-117.1
6514.272400	-42.80	-41.30	1.50	1000.000	H	341.0	87.0	-117.1
6529.329400	-42.57	-41.30	1.27	1000.000	H	337.0	89.0	-117.2
6543.193000	-42.08	-41.30	0.78	1000.000	H	340.0	89.0	-117.2
6554.044800	-41.81	-41.30	0.51	1000.000	H	339.0	91.0	-116.7
6554.061600	-41.93	-41.30	0.63	1000.000	H	339.0	92.0	-116.7
6739.279400	-49.04	-41.30	7.74	1000.000	H	330.0	99.0	-116.3

Plot 6: Fundamental emission (UWB test mode): Max Peak

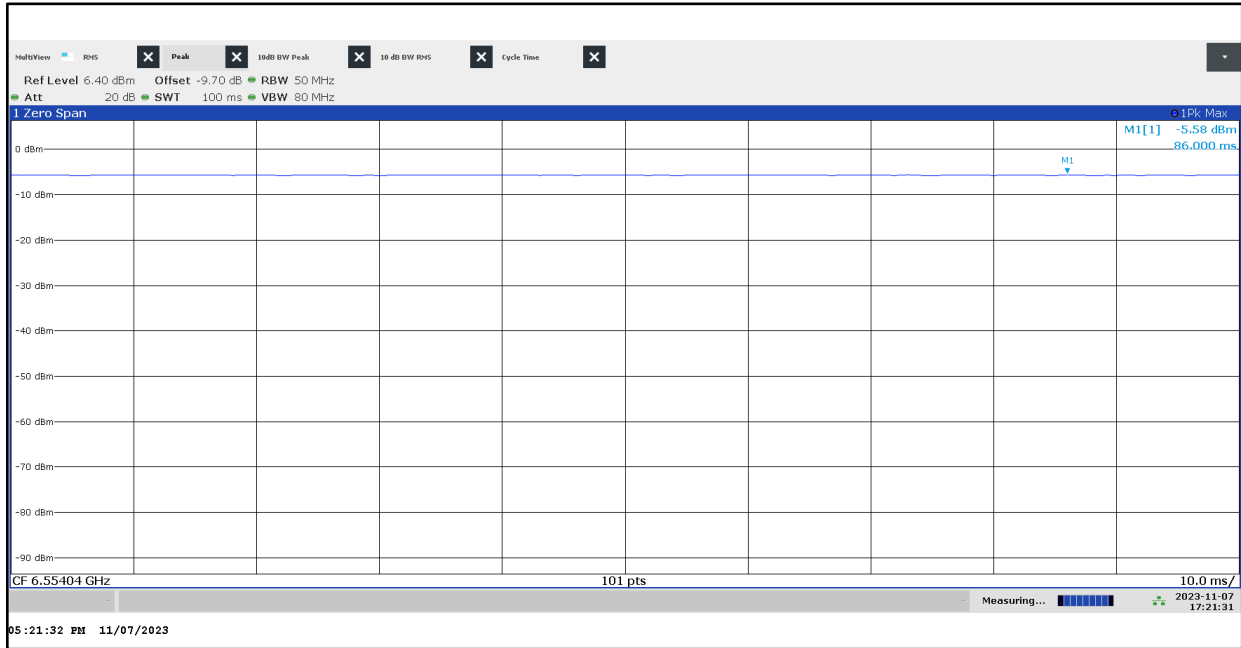

Plot 7: 9 kHz to 30 MHz, UWB test mode

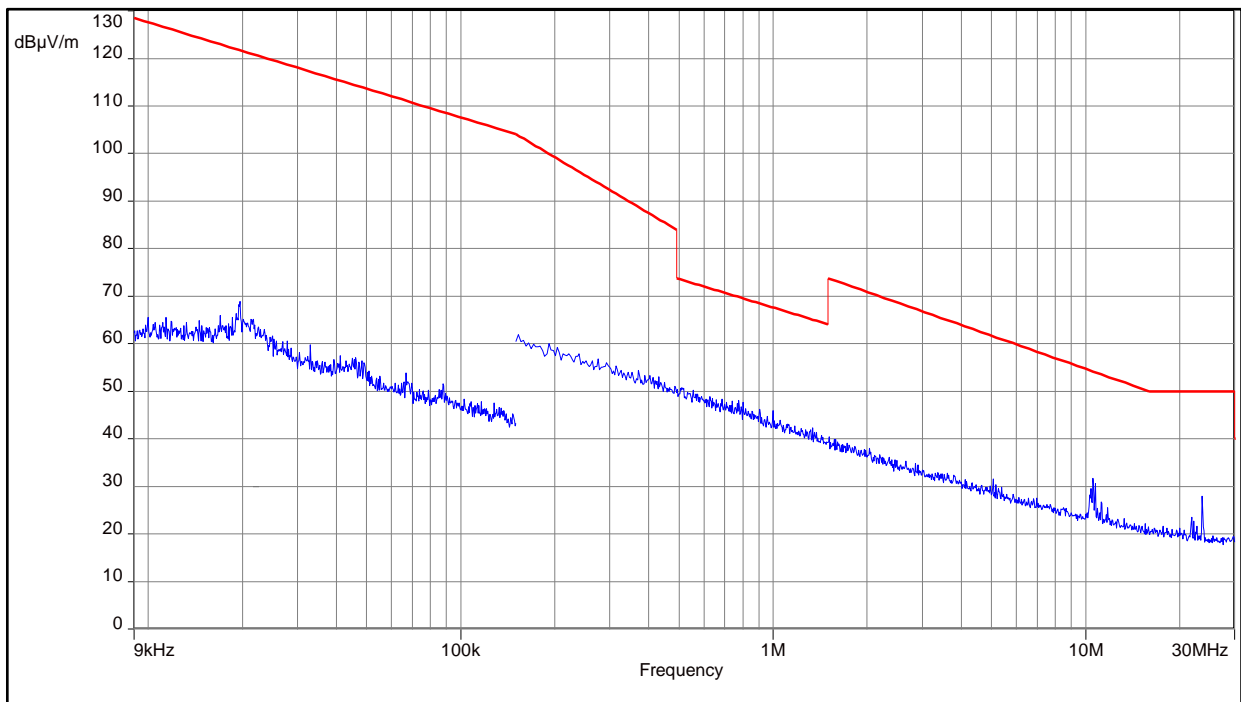

Plot 8: 30 MHz to 1 GHz, UWB test mode

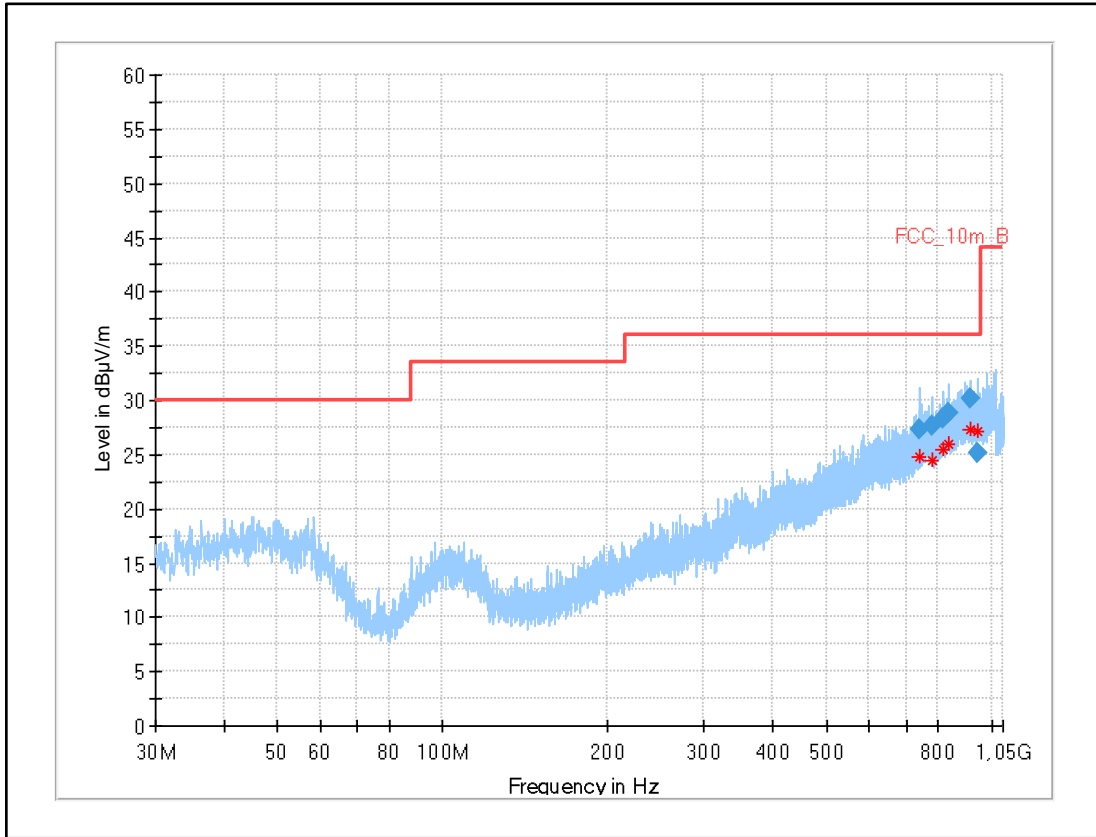

Frequency (MHz)	QuasiPeak (dBµV/m)	Limit (dBµV/m)	Margin (dB)	Meas. Time (ms)	Bandwidth (kHz)	Height (cm)	Pol	Azimuth (deg)	Corr. (dB/m)
740.859	27.35	36.0	8.7	1000	120.0	195.0	H	65	24
780.135	27.58	36.0	8.4	1000	120.0	135.0	H	242	24
815.696	28.31	36.0	7.7	1000	120.0	195.0	V	52	24
835.100	28.82	36.0	7.2	1000	120.0	195.0	H	232	24
913.356	30.19	36.0	5.8	1000	120.0	189.0	V	64	26
943.568	25.16	36.0	10.8	1000	120.0	195.0	H	232	25

Plot 9: 960 MHz to 4.8 GHz (Limit acc. to §15.519 (c)), UWB test mode

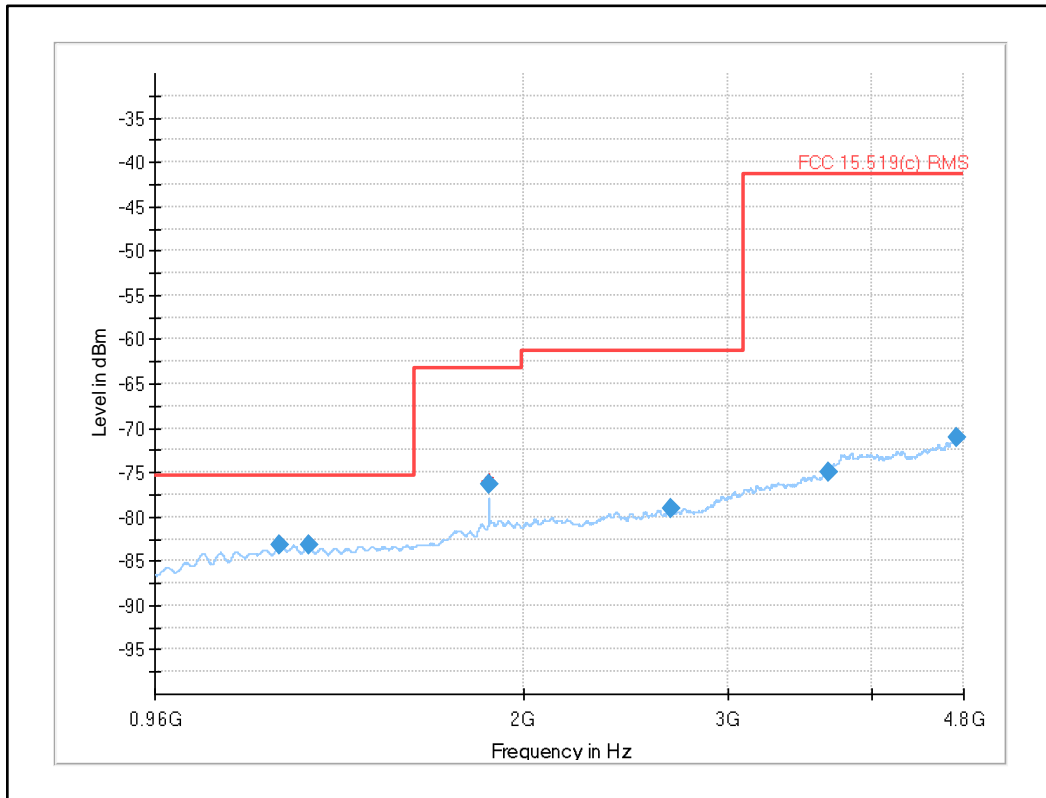

Frequency (MHz)	RMS (dBm)	Limit (dBm)	Margin (dB)	Bandwidth (kHz)	Pol	Azimuth (deg)	Elevation (deg)	Corr. (dB)
1230.016200	-83.17	-75.30	7.87	1000.000	H	47.0	179.0	-137.7
1305.115800	-83.24	-75.30	7.94	1000.000	H	90.0	85.0	-137.8
1866.634200	-76.31	-63.30	13.01	1000.000	H	173.0	60.0	-135.5
2682.700800	-79.14	-61.30	17.84	1000.000	H	38.0	113.0	-132.9
3670.786200	-75.03	-41.30	33.73	1000.000	V	267.0	119.0	-130.0
4733.894400	-71.07	-41.30	29.77	1000.000	H	51.0	30.0	-126.2

Plot 10: 3 GHz to 10 GHz, UWB test mode

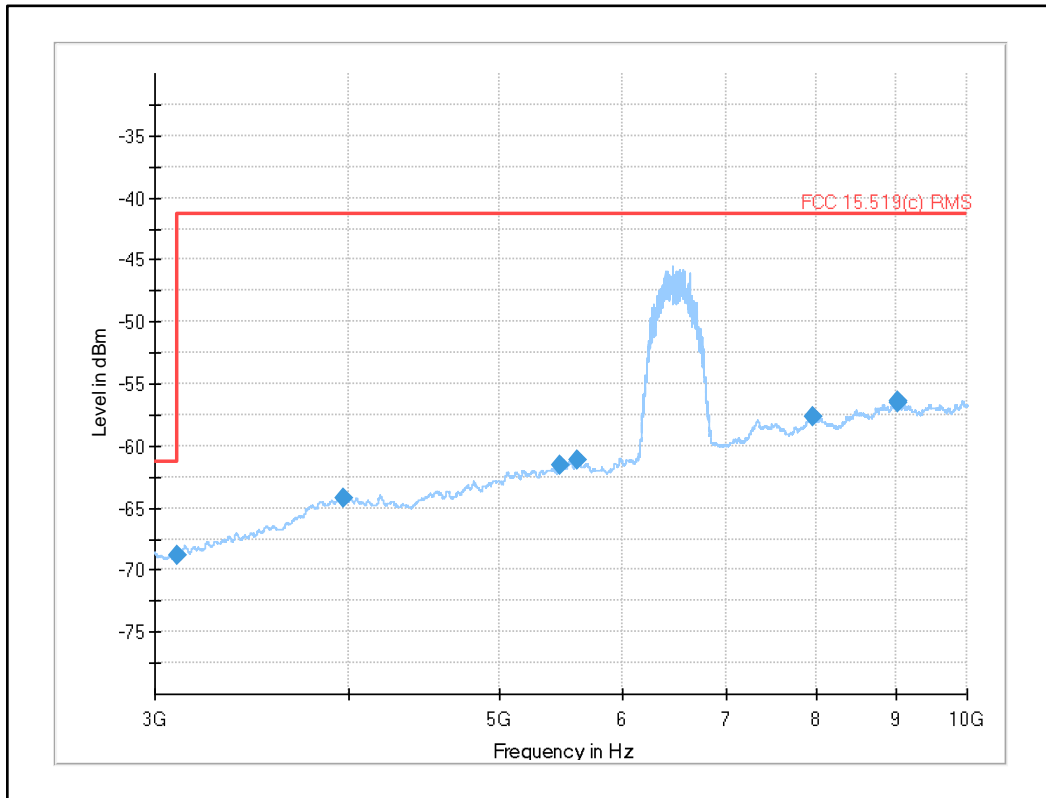

Frequency (MHz)	RMS (dBm)	Limit (dBm)	Margin (dB)	Bandwidth (kHz)	Pol	Azimuth (deg)	Elevation (deg)	Corr. (dB)
3098.769459	-68.81	-61.30	7.51	1000.000	V	-10.0	154.0	-122.7
3970.227298	-64.24	-41.30	22.94	1000.000	V	214.0	0.0	-119.6
5467.670676	-61.54	-41.30	20.24	1000.000	H	247.0	45.0	-117.3
5611.395541	-61.09	-41.30	19.79	1000.000	H	278.0	144.0	-116.8
7963.285270	-57.60	-41.30	16.30	1000.000	H	152.0	82.0	-114.6
9020.705270	-56.52	-41.30	15.22	1000.000	H	105.0	30.0	-111.9
9022.213784	-56.40	-41.30	15.10	1000.000	H	94.0	28.0	-111.8

Plot 11: 10 GHz to 18 GHz, UWB test mode

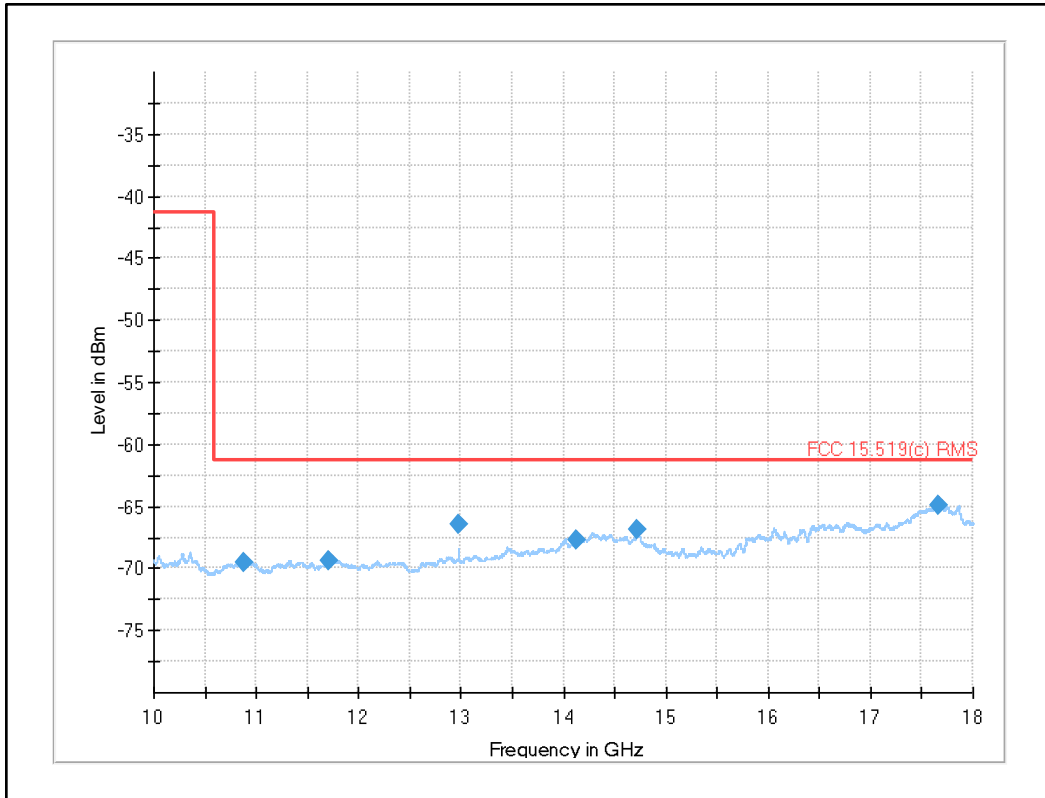

Frequency (MHz)	RMS (dBm)	Limit (dBm)	Margin (dB)	Bandwidth (kHz)	Pol	Azimuth (deg)	Elevation (deg)	Corr. (dB)
10886.395000	-69.49	-61.30	8.19	1000.000	H	235.0	161.0	-126.2
11701.536000	-69.39	-61.30	8.09	1000.000	V	245.0	41.0	-126.1
12979.130000	-66.40	-61.30	5.10	1000.000	H	324.0	48.0	-125.5
14135.166000	-67.68	-61.30	6.38	1000.000	V	147.0	15.0	-121.6
14721.751000	-66.93	-61.30	5.63	1000.000	V	270.0	15.0	-121.2
17656.184000	-64.87	-61.30	3.57	1000.000	V	35.0	15.0	-116.4

Plot 12: 18 GHz to 26.5 GHz, UWB test mode

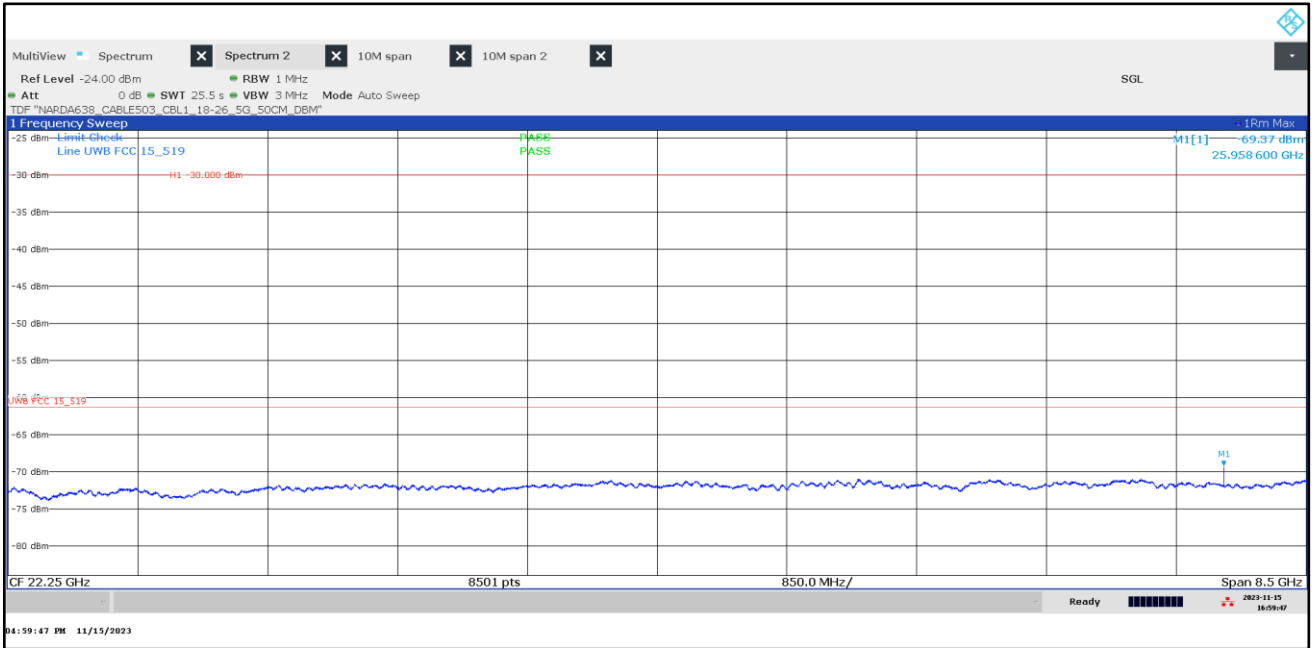

Plot 13: 26 GHz with 10 MHz span, UWB test mode

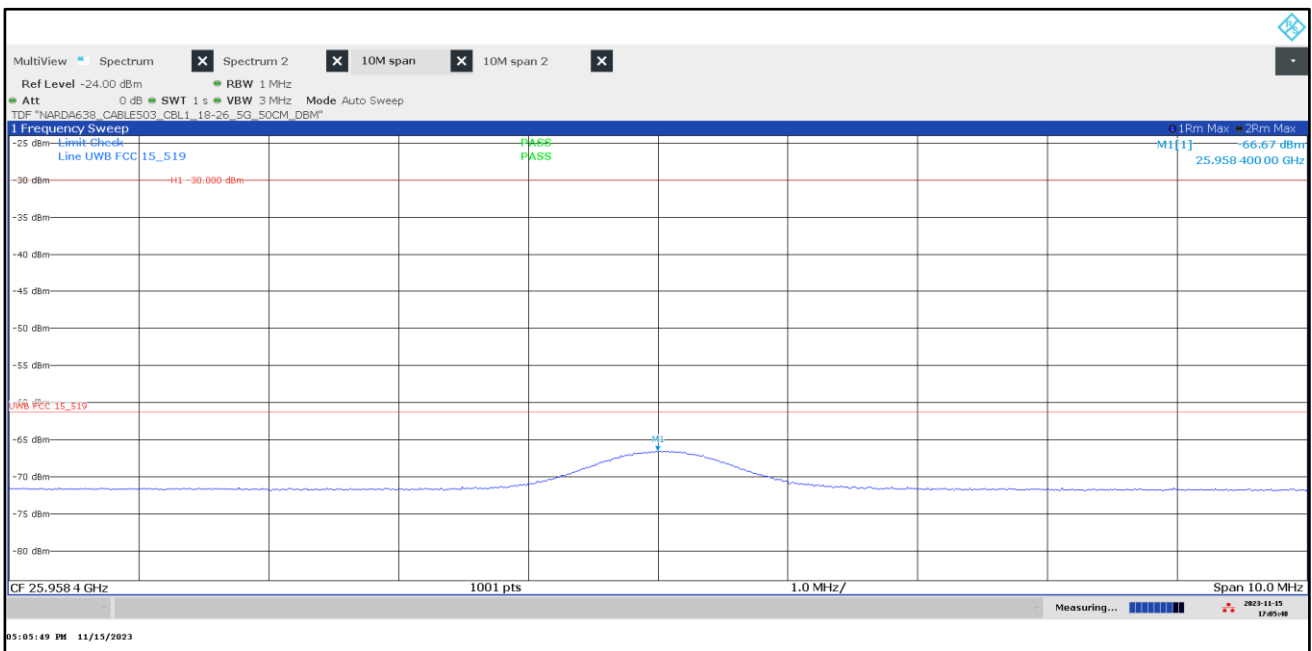

Plot 14: 26 GHz with zero span, UWB test mode

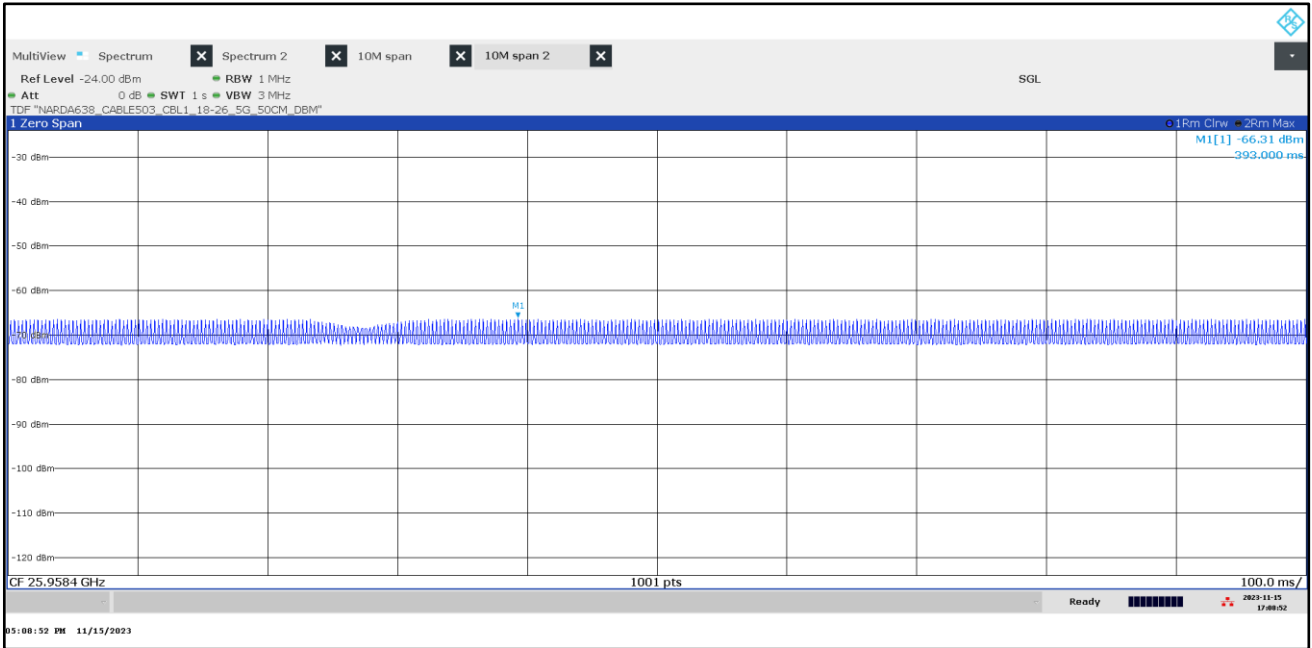

Plot 15: 26.5 GHz to 40.0 GHz, UWB test mode

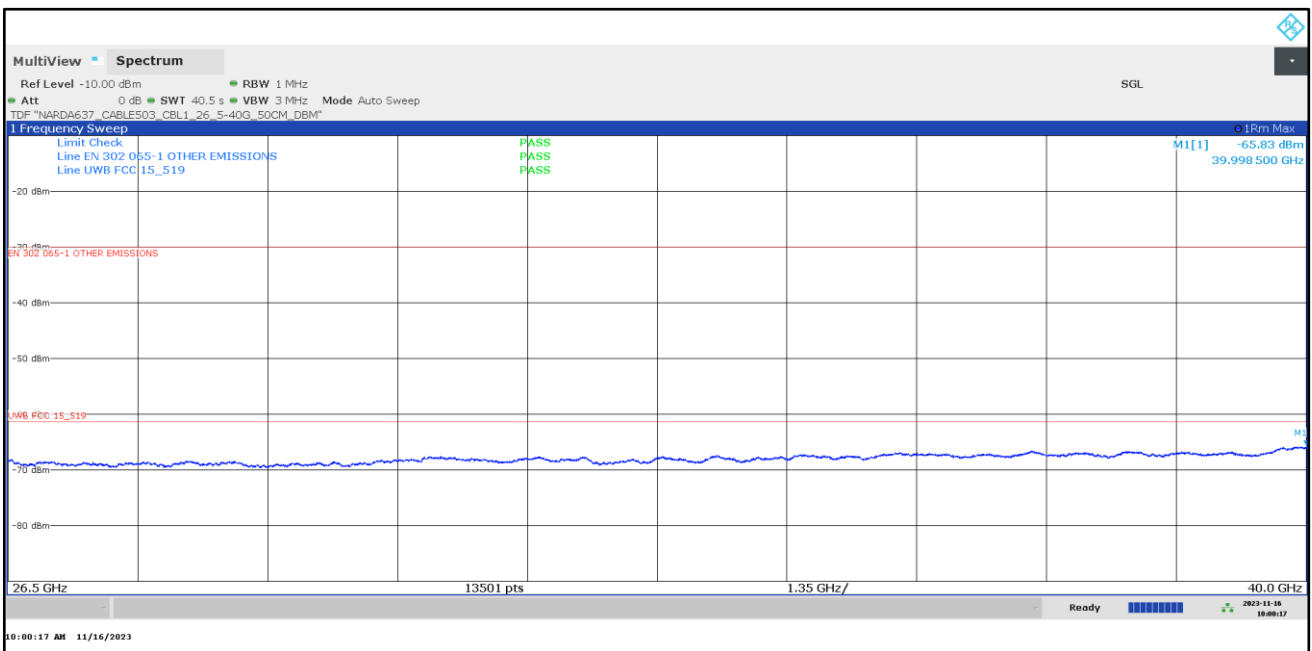

Plot 16: 1164 MHz to 1240 MHz (§15.519 (d)), UWB test mode

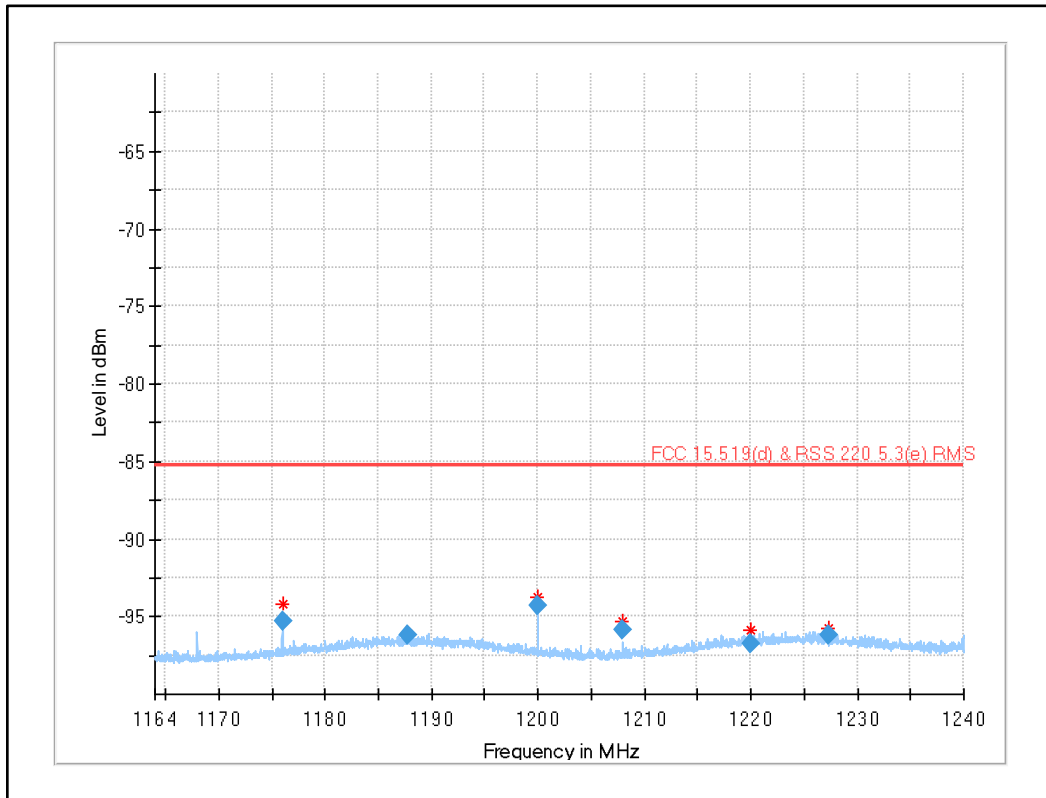

Frequency (MHz)	RMS (dBm)	Limit (dBm)	Margin (dB)	Bandwidth (kHz)	Pol	Azimuth (deg)	Elevation (deg)	Corr. (dB)
1175.977576	-95.30	-85.30	10.00	30.000	V	192.0	71.0	-139.9
1187.762114	-96.19	-85.30	10.89	30.000	H	48.0	105.0	-138.0
1200.000291	-94.30	-85.30	9.00	30.000	V	119.0	11.0	-139.5
1207.975329	-95.92	-85.30	10.62	30.000	V	185.0	75.0	-139.9
1219.917833	-96.71	-85.30	11.41	30.000	V	144.0	90.0	-138.1
1227.234792	-96.16	-85.30	10.86	30.000	H	132.0	105.0	-138.0

Plot 17: 1559 MHz to 1610 MHz (§15.519 (d)), UWB test mode

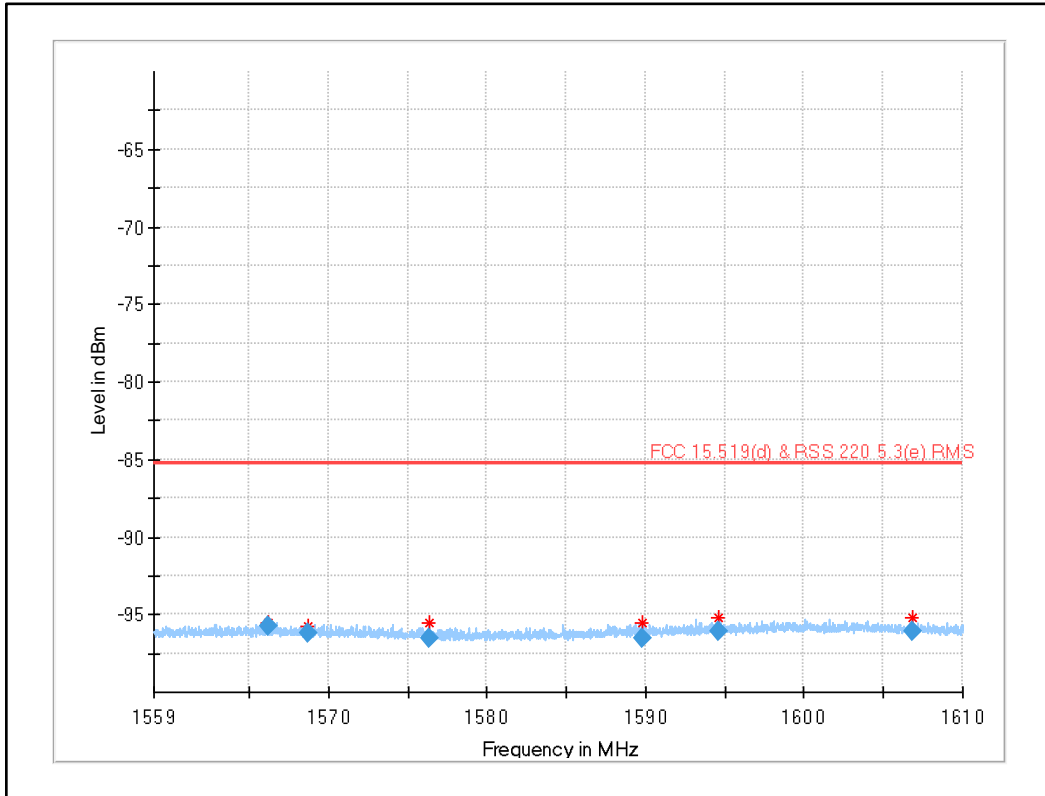

Frequency (MHz)	RMS (dBm)	Limit (dBm)	Margin (dB)	Bandwidth (kHz)	Pol	Azimuth (deg)	Elevation (deg)	Corr. (dB)
1566.179115	-95.77	-85.30	10.47	30.000	H	78.0	173.0	-138.2
1568.766112	-96.25	-85.30	10.95	30.000	V	334.0	152.0	-138.4
1576.348091	-96.55	-85.30	11.25	30.000	V	266.0	172.0	-138.9
1589.828141	-96.59	-85.30	11.29	30.000	V	350.0	152.0	-138.5
1594.642727	-96.06	-85.30	10.76	30.000	H	63.0	22.0	-137.9
1606.811706	-96.08	-85.30	10.78	30.000	H	65.0	115.0	-138.1

12.2.2 Radiated emissions channel 6

Plot 18: Fundamental emission (UWB test mode): RMS

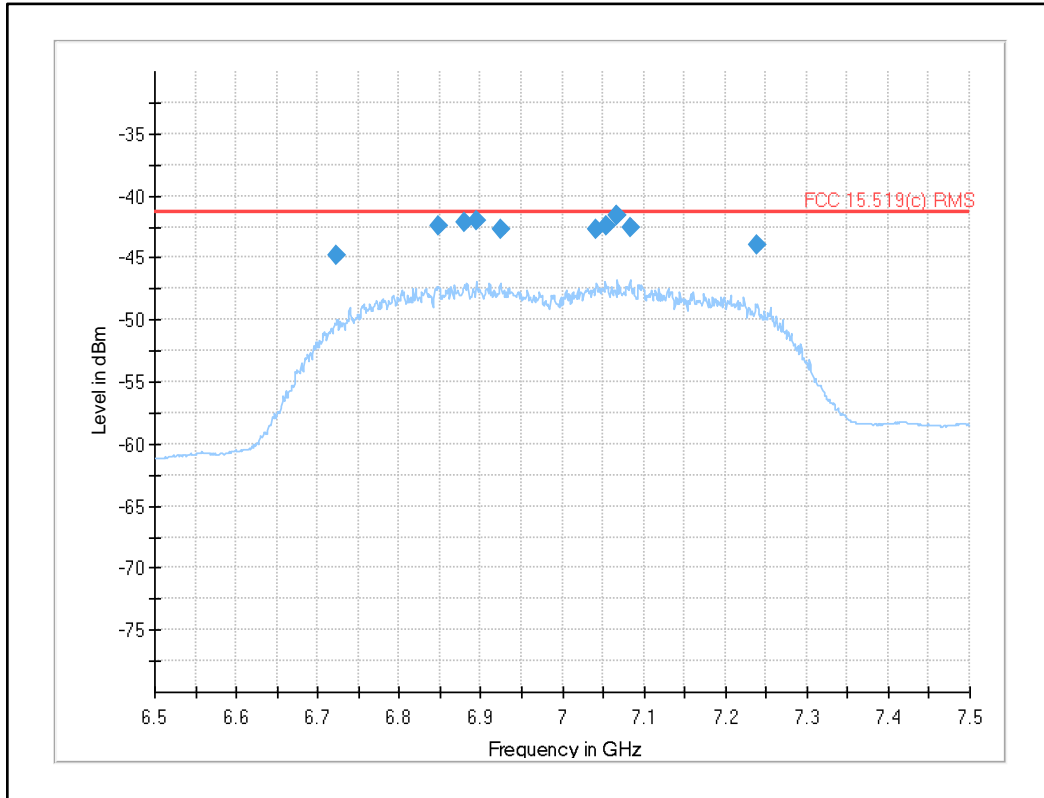

Frequency (MHz)	RMS (dBm)	Limit (dBm)	Margin (dB)	Bandwidth (kHz)	Pol	Azimuth (deg)	Elevation (deg)	Corr. (dB)
6722.721400	-44.79	-41.30	3.49	1000.000	H	315.0	97.0	-116.3
6847.572400	-42.43	-41.30	1.13	1000.000	H	302.0	92.0	-116.3
6880.357000	-42.18	-41.30	0.88	1000.000	H	301.0	92.0	-116.3
6894.220800	-41.98	-41.30	0.68	1000.000	H	301.0	96.0	-116.5
6924.380400	-42.69	-41.30	1.39	1000.000	H	170.0	173.0	-116.6
7042.282600	-42.72	-41.30	1.42	1000.000	H	169.0	177.0	-116.3
7053.285000	-42.45	-41.30	1.15	1000.000	H	169.0	180.0	-116.2
7066.952600	-41.64	-41.30	0.34	1000.000	H	173.0	0.0	-115.9
7066.969400	-41.61	-41.30	0.31	1000.000	H	173.0	0.0	-115.9
7083.383400	-42.51	-41.30	1.21	1000.000	H	168.0	186.0	-116.0
7238.403000	-43.99	-41.30	2.69	1000.000	H	327.0	184.0	-115.7

Plot 19: Fundamental emission (UWB test mode): Max Peak

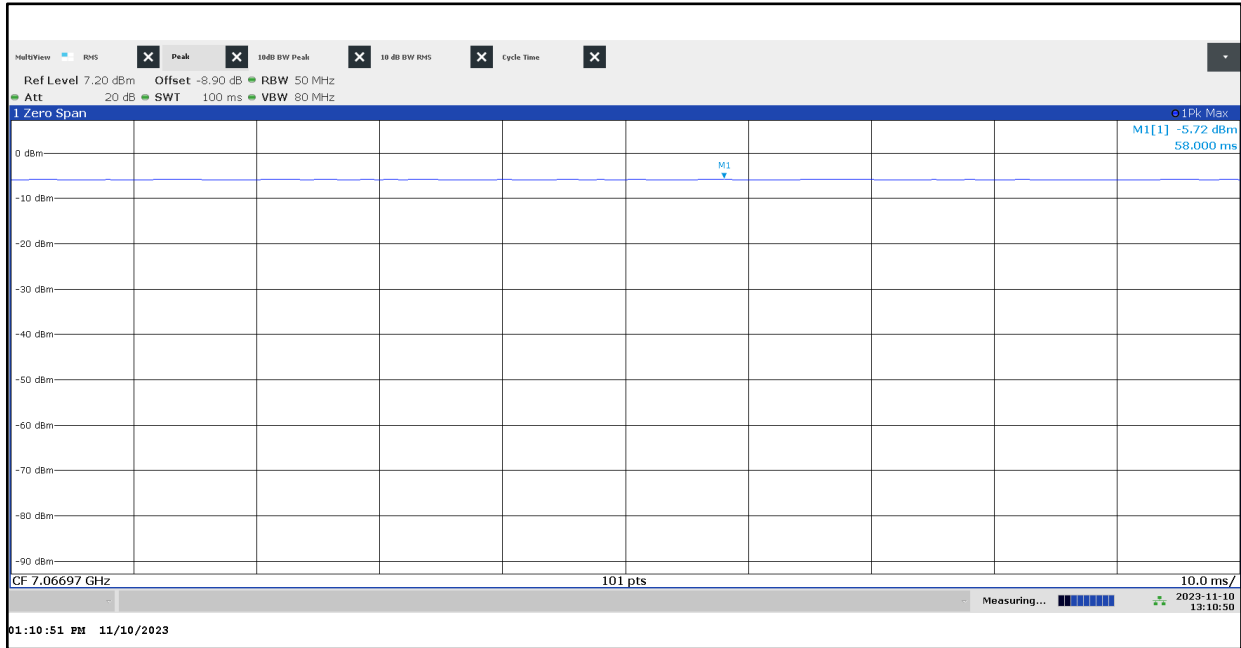

Plot 20: 9 kHz to 30 MHz, UWB test mode

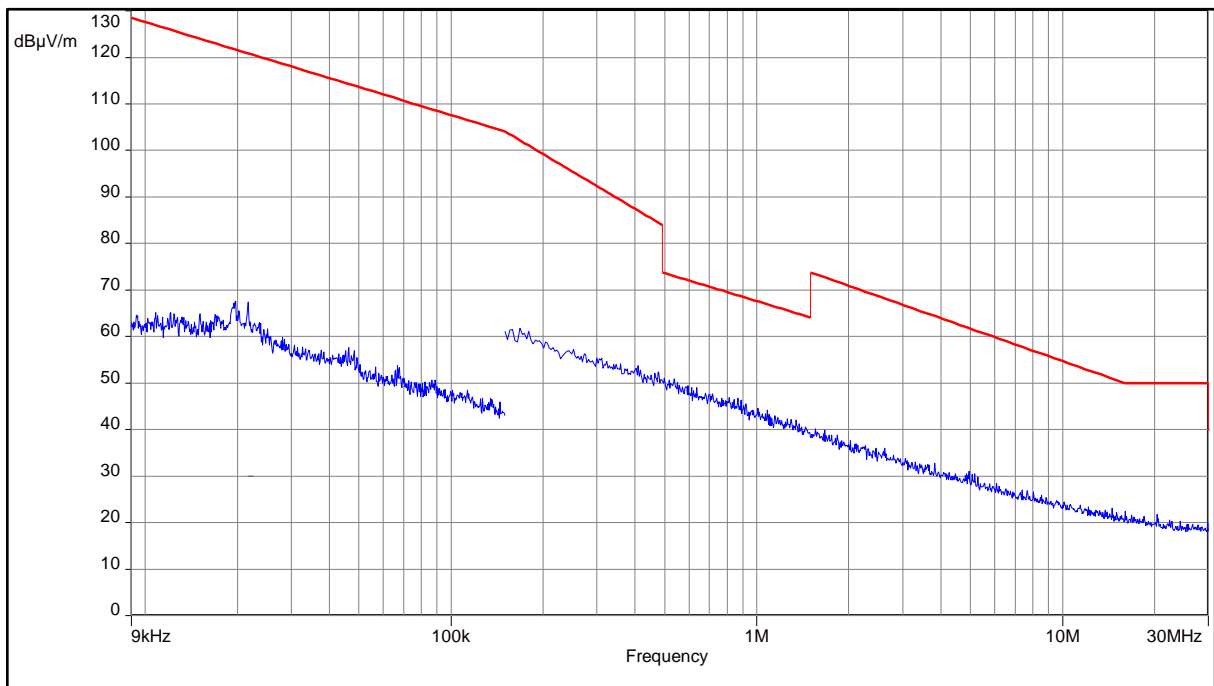

Plot 21: 30 MHz to 1 GHz, UWB test mode

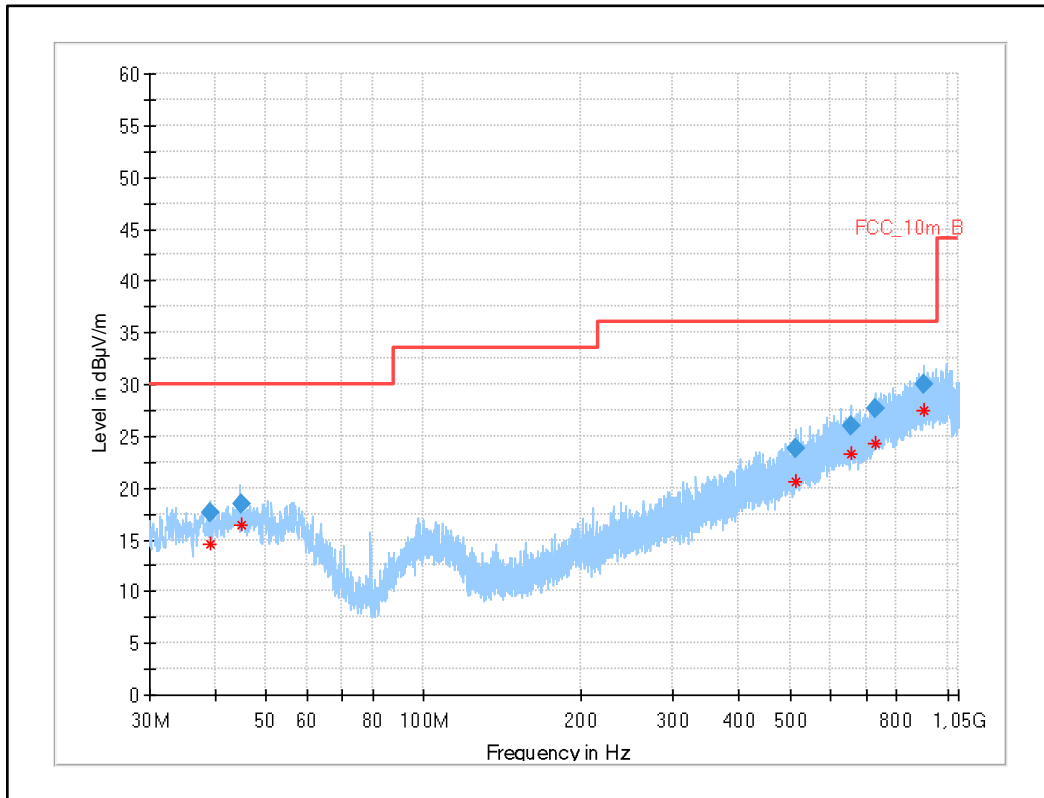

Frequency (MHz)	QuasiPeak (dBµV/m)	Limit (dBµV/m)	Margin (dB)	Meas. Time (ms)	Bandwidth (kHz)	Height (cm)	Pol	Azimuth (deg)	Corr. (dB/m)
39.131	17.64	30.0	12.4	1000	120.0	135.0	V	232	15
45.050	18.44	30.0	11.6	1000	120.0	105.0	V	158	16
511.975	23.79	36.0	12.2	1000	120.0	121.0	V	174	20
654.559	25.92	36.0	10.1	1000	120.0	126.0	V	142	22
726.544	27.58	36.0	8.4	1000	120.0	195.0	H	142	23
899.349	30.06	36.0	5.9	1000	120.0	195.0	H	84	25

Plot 22: 960 MHz to 4.8 GHz (Limit acc. to §15.519 (c)), UWB test mode

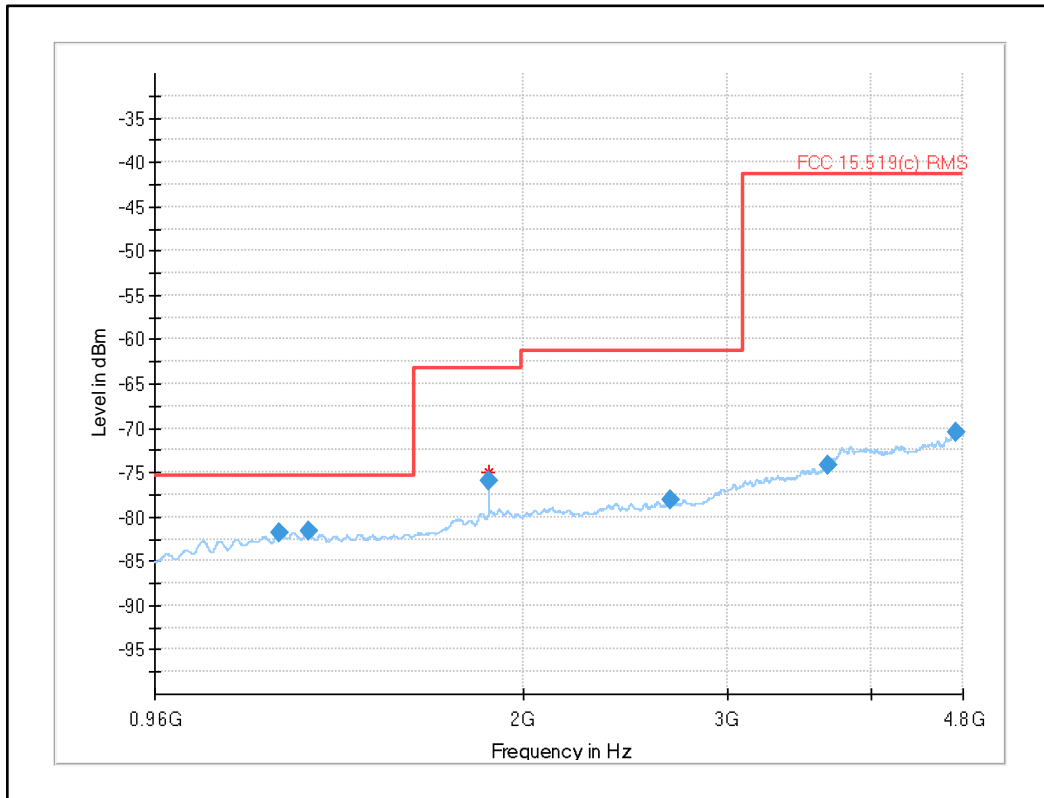

Frequency (MHz)	RMS (dBm)	Limit (dBm)	Margin (dB)	Bandwidth (kHz)	Pol	Azimuth (deg)	Elevation (deg)	Corr. (dB)
1231.815600	-81.72	-75.30	6.42	1000.000	H	9.0	177.0	-137.7
1302.813000	-81.67	-75.30	6.37	1000.000	H	55.0	68.0	-137.7
1866.632400	-75.87	-63.30	12.57	1000.000	H	181.0	62.0	-135.5
2680.069800	-78.07	-61.30	16.77	1000.000	H	325.0	30.0	-132.9
3670.929600	-74.18	-41.30	32.88	1000.000	V	203.0	11.0	-130.0
4740.619800	-70.53	-41.30	29.23	1000.000	H	58.0	90.0	-126.3

Plot 23: 3 GHz to 10 GHz, UWB test mode

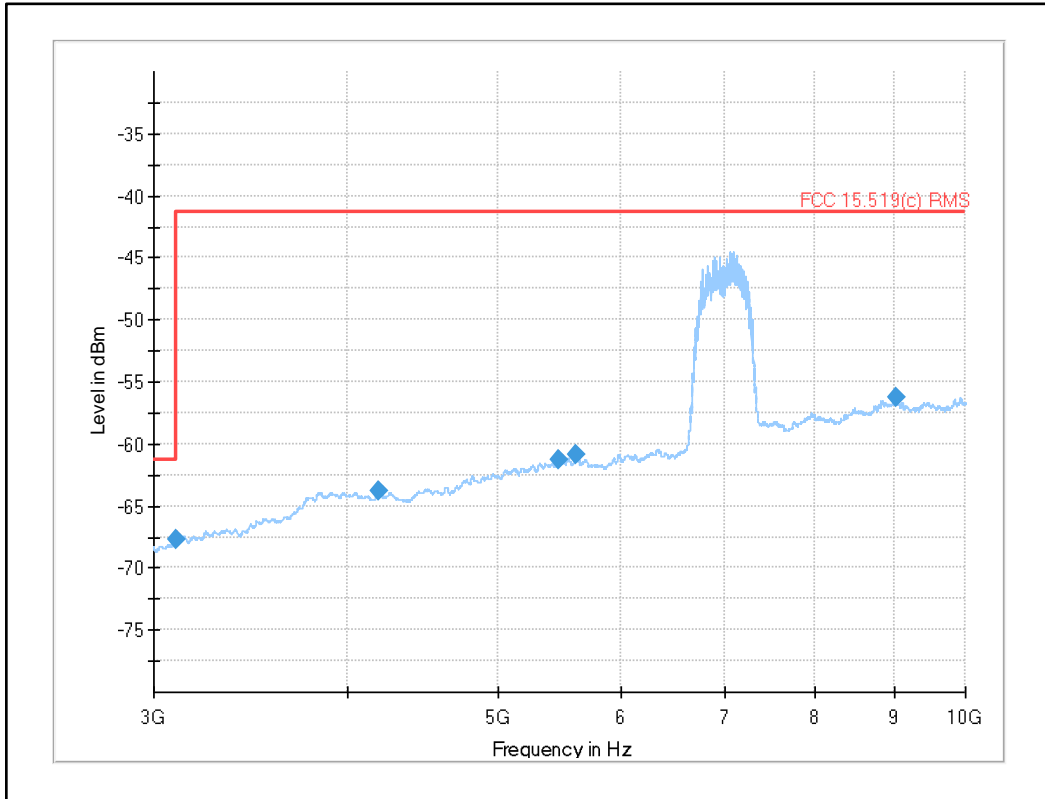

Frequency (MHz)	RMS (dBm)	Limit (dBm)	Margin (dB)	Bandwidth (kHz)	Pol	Azimuth (deg)	Elevation (deg)	Corr. (dB)
3098.425270	-67.69	-61.30	6.39	1000.000	H	70.0	100.0	-122.3
4191.077027	-63.75	-41.30	22.45	1000.000	H	113.0	149.0	-119.3
5470.859054	-61.26	-41.30	19.96	1000.000	H	344.0	15.0	-117.5
5617.672162	-60.93	-41.30	19.63	1000.000	H	130.0	36.0	-117.1
9021.609730	-56.28	-41.30	14.98	1000.000	H	179.0	73.0	-111.8

Plot 24: 10 GHz to 18 GHz, UWB test mode

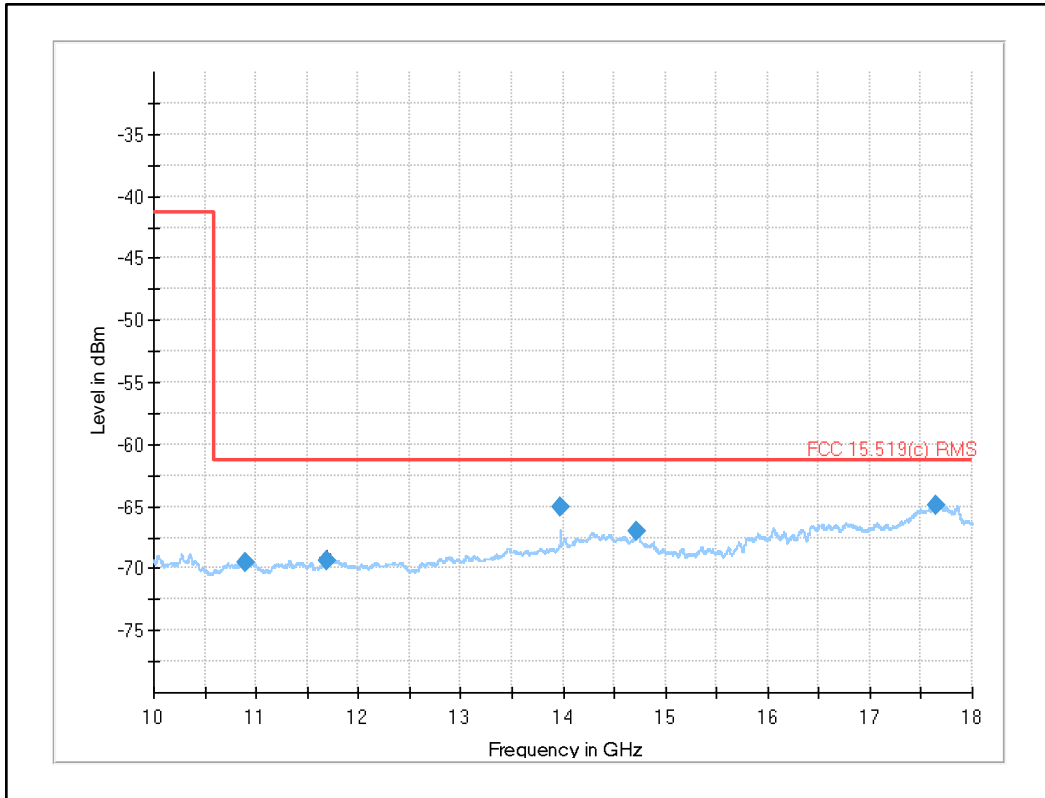

Frequency (MHz)	RMS (dBm)	Limit (dBm)	Margin (dB)	Bandwidth (kHz)	Pol	Azimuth (deg)	Elevation (deg)	Corr. (dB)
10888.963000	-69.57	-61.30	8.27	1000.000	H	320.0	120.0	-126.3
11698.325000	-69.33	-61.30	8.03	1000.000	V	252.0	98.0	-126.0
13977.606000	-65.06	-61.30	3.76	1000.000	H	306.0	38.0	-122.1
14721.475000	-67.04	-61.30	5.74	1000.000	V	25.0	15.0	-121.2
17648.521000	-64.90	-61.30	3.60	1000.000	V	0.0	14.0	-116.4

Plot 25: 18 GHz to 26.5 GHz, UWB test mode

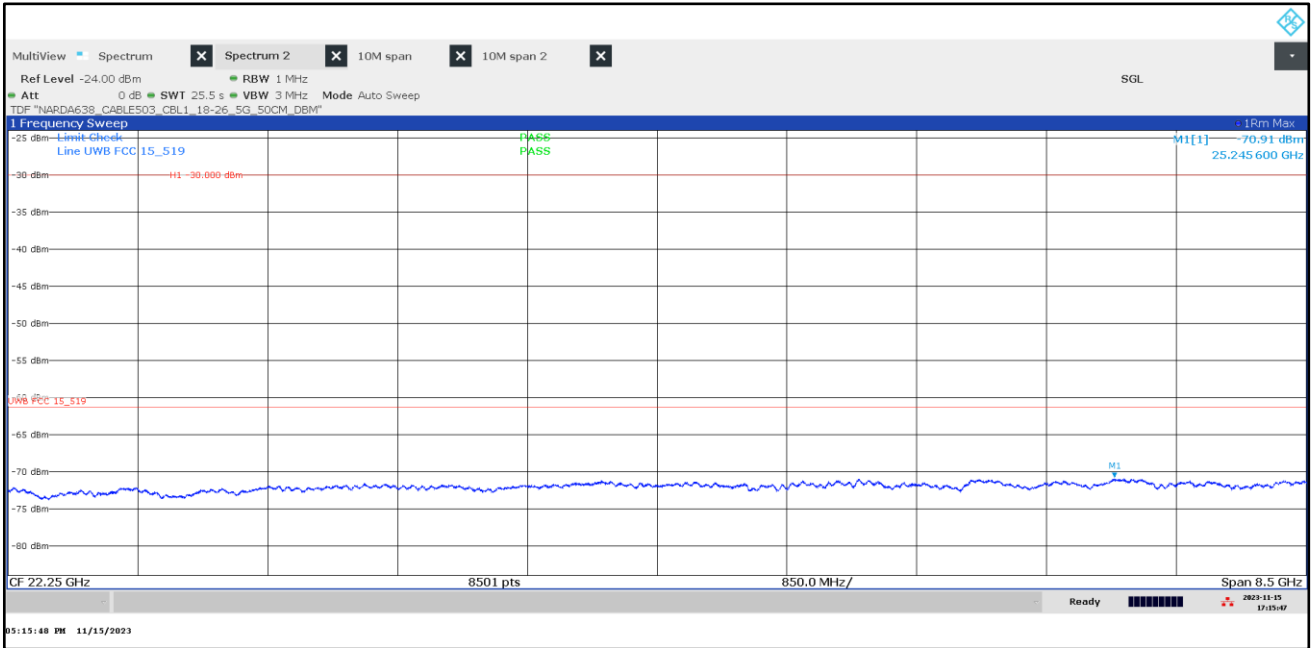

Plot 26: 26.5 GHz to 40.0 GHz, UWB test mode

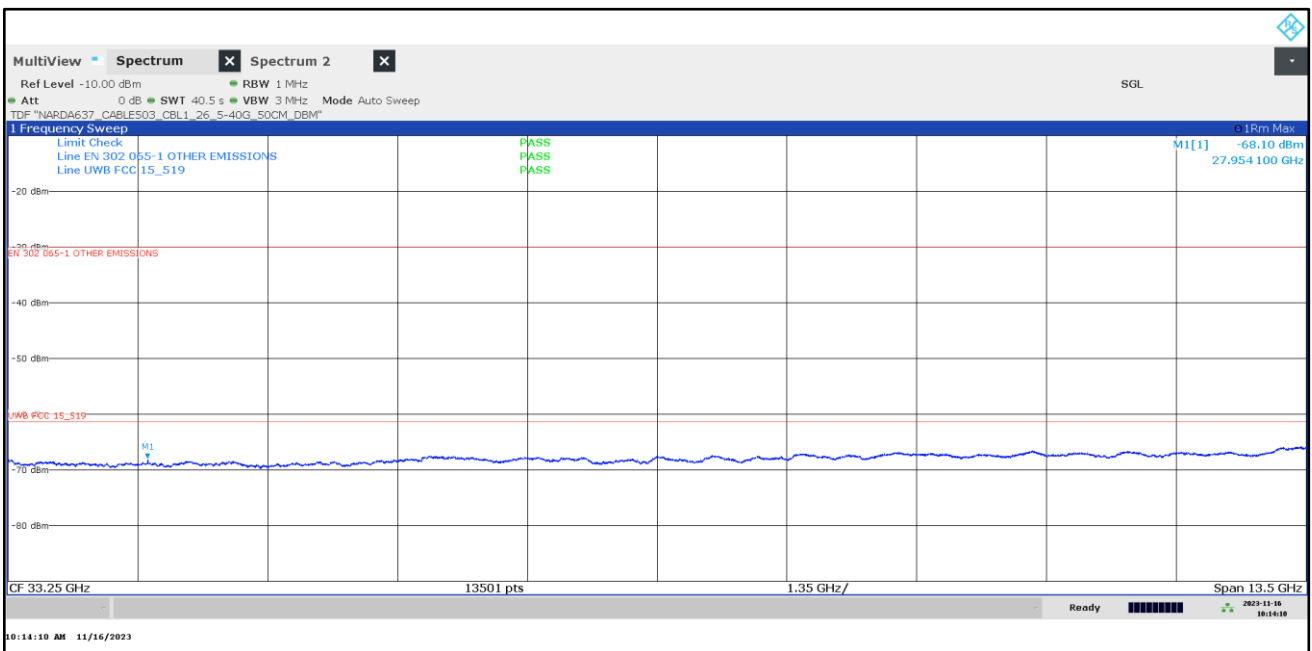

Plot 27: 27.9 GHz with 10 MHz span, UWB test mode

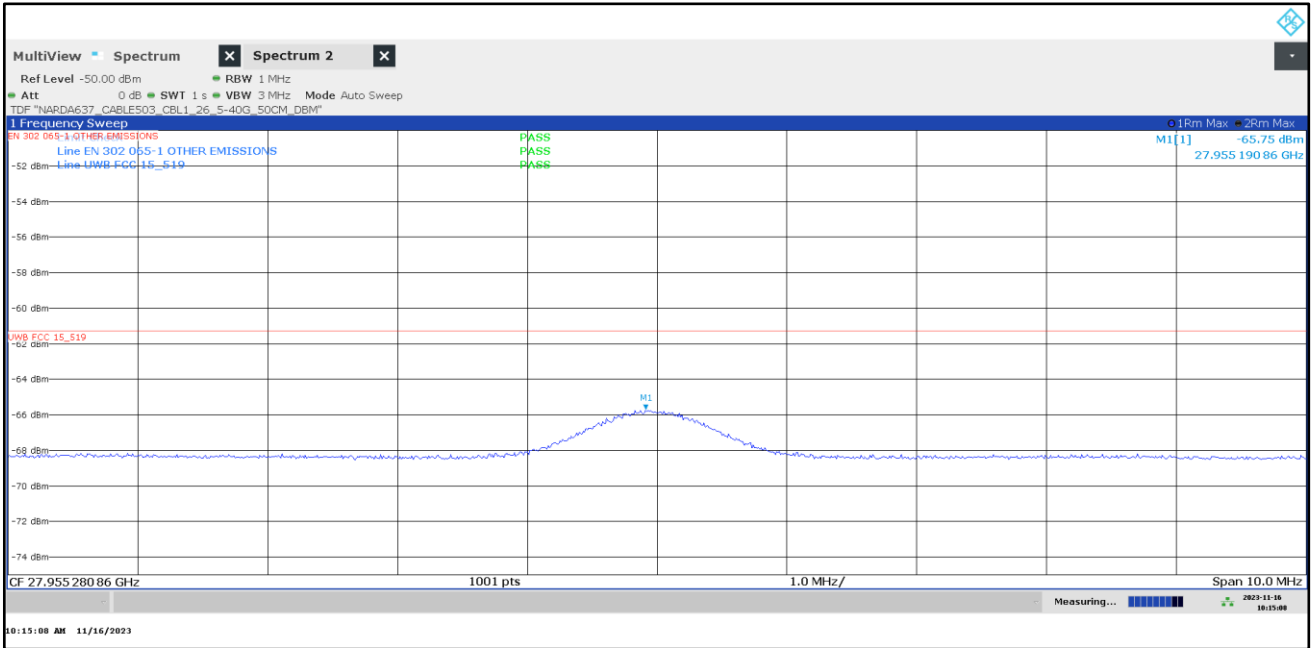

Plot 28: 27.9 GHz with zero span, UWB test mode

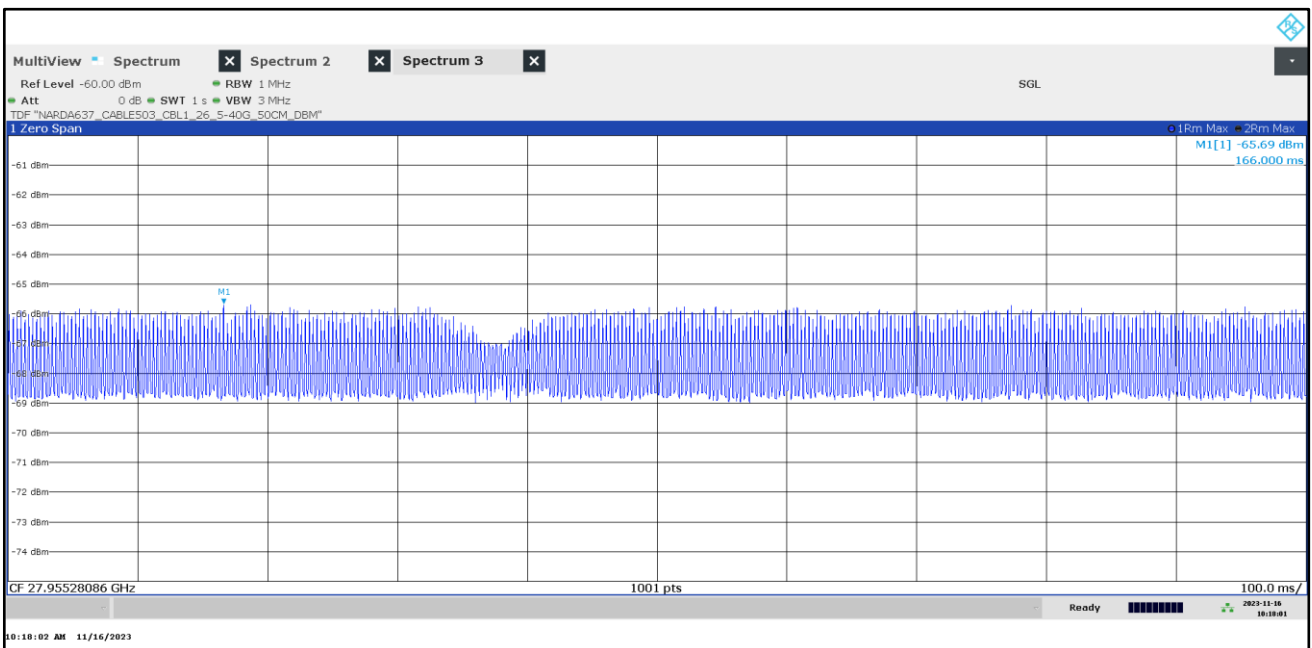

Plot 29: 1164 MHz to 1240 MHz (§15.519 (d)), UWB test mode

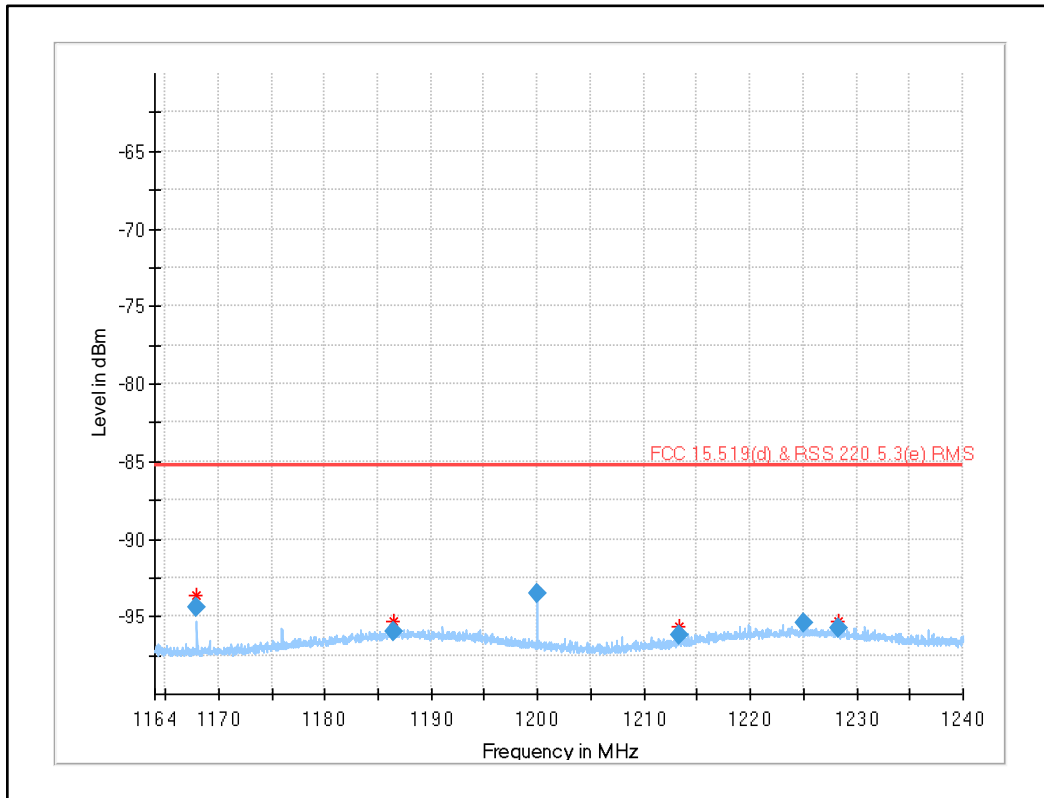

Frequency (MHz)	RMS (dBm)	Limit (dBm)	Margin (dB)	Bandwidth (kHz)	Pol	Azimuth (deg)	Elevation (deg)	Corr. (dB)
1167.982598	-94.41	-85.30	9.11	30.000	V	192.0	65.0	-140.5
1186.403418	-95.93	-85.30	10.63	30.000	H	146.0	73.0	-138.1
1200.000491	-93.55	-85.30	8.25	30.000	V	116.0	15.0	-139.5
1213.257317	-96.22	-85.30	10.92	30.000	H	162.0	149.0	-138.9
1224.948162	-95.44	-85.30	10.14	30.000	H	303.0	90.0	-137.8
1228.294827	-95.79	-85.30	10.49	30.000	H	271.0	180.0	-138.1

Plot 30: 1559 MHz to 1610 MHz (§15.519 (d)), UWB test mode

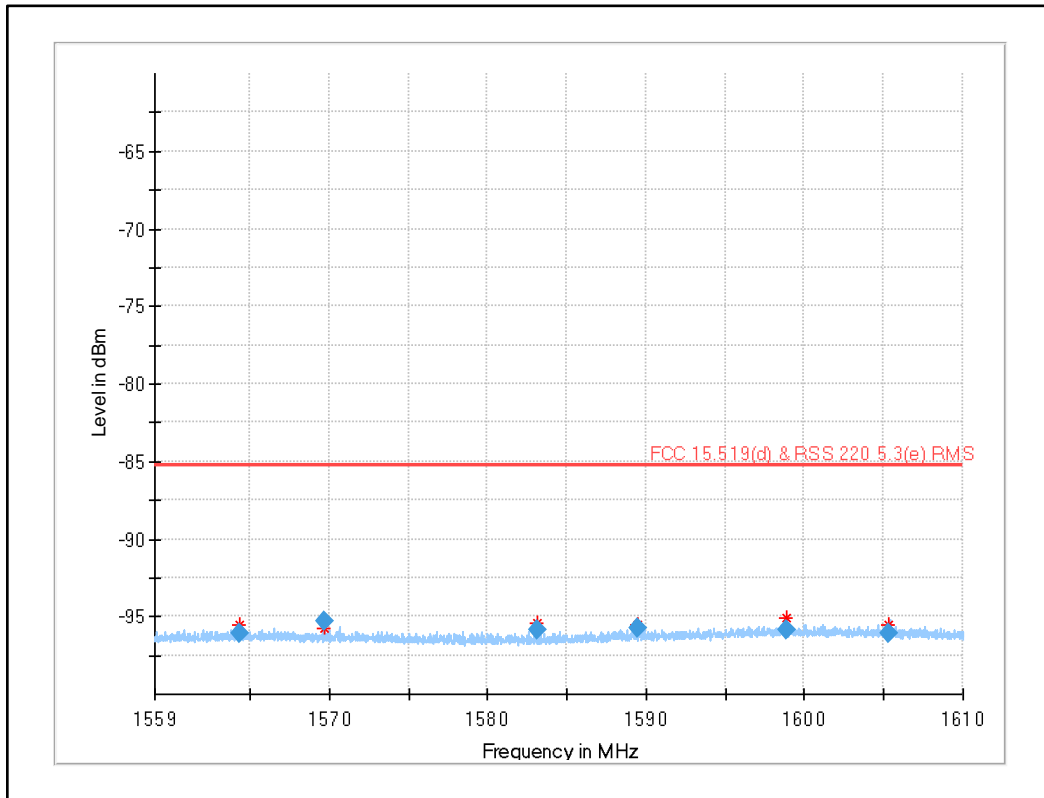

Frequency (MHz)	RMS (dBm)	Limit (dBm)	Margin (dB)	Bandwidth (kHz)	Pol	Azimuth (deg)	Elevation (deg)	Corr. (dB)
1564.390488	-96.11	-85.30	10.81	30.000	V	96.0	2.0	-138.3
1569.742788	-95.28	-85.30	9.98	30.000	H	8.0	161.0	-138.3
1583.178421	-95.83	-85.30	10.53	30.000	H	129.0	135.0	-138.7
1589.482250	-95.76	-85.30	10.46	30.000	H	130.0	122.0	-138.3
1598.838085	-95.83	-85.30	10.53	30.000	H	217.0	49.0	-137.8
1605.356300	-96.13	-85.30	10.83	30.000	H	351.0	149.0	-138.0

12.2.3 Radiated emissions channel 8

Plot 31: Fundamental emission (UWB test mode): RMS

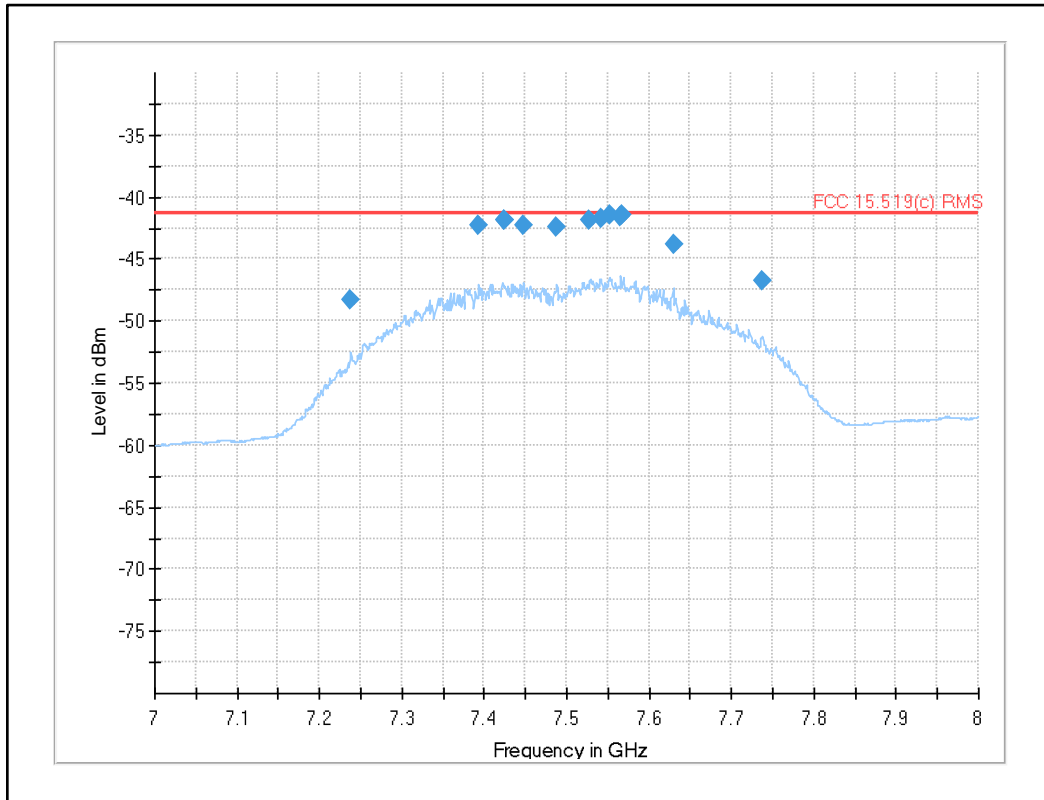

Frequency (MHz)	RMS (dBm)	Limit (dBm)	Margin (dB)	Bandwidth (kHz)	Pol	Azimuth (deg)	Elevation (deg)	Corr. (dB)
7238.433400	-48.36	-41.30	7.06	1000.000	H	10.0	9.0	-115.7
7393.410400	-42.25	-41.30	0.95	1000.000	V	335.0	136.0	-115.2
7423.495200	-41.93	-41.30	0.63	1000.000	V	336.0	133.0	-115.4
7423.498800	-41.94	-41.30	0.64	1000.000	V	338.0	133.0	-115.4
7448.204600	-42.24	-41.30	0.94	1000.000	V	335.0	135.0	-115.5
7487.948400	-42.40	-41.30	1.10	1000.000	V	335.0	132.0	-115.5
7527.776600	-41.92	-41.30	0.62	1000.000	V	335.0	134.0	-114.9
7541.498800	-41.68	-41.30	0.38	1000.000	V	335.0	134.0	-114.7
7552.447600	-41.47	-41.30	0.17	1000.000	V	333.0	135.0	-115.1
7566.155400	-41.55	-41.30	0.25	1000.000	V	333.0	133.0	-115.4
7566.189600	-41.50	-41.30	0.20	1000.000	V	334.0	133.0	-115.4
7629.209800	-43.77	-41.30	2.47	1000.000	H	340.0	60.0	-115.7
7737.606400	-46.73	-41.30	5.43	1000.000	V	340.0	136.0	-115.5

Plot 32: Fundamental emission (UWB test mode): Max Peak

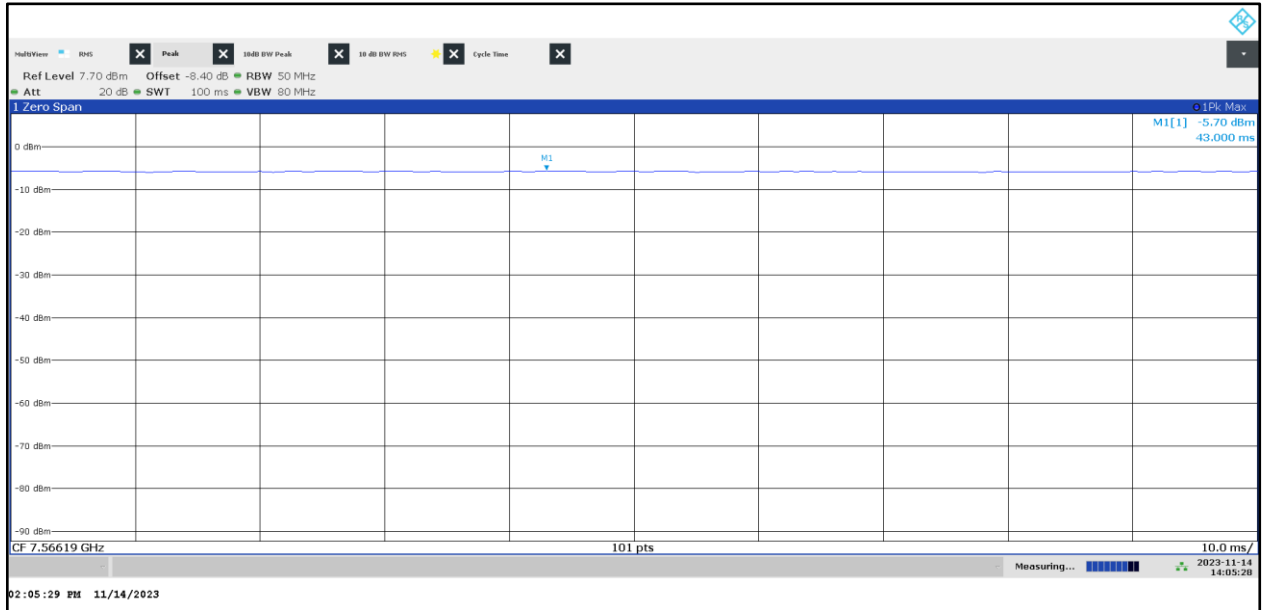

Plot 33: 9 kHz to 30 MHz, UWB test mode

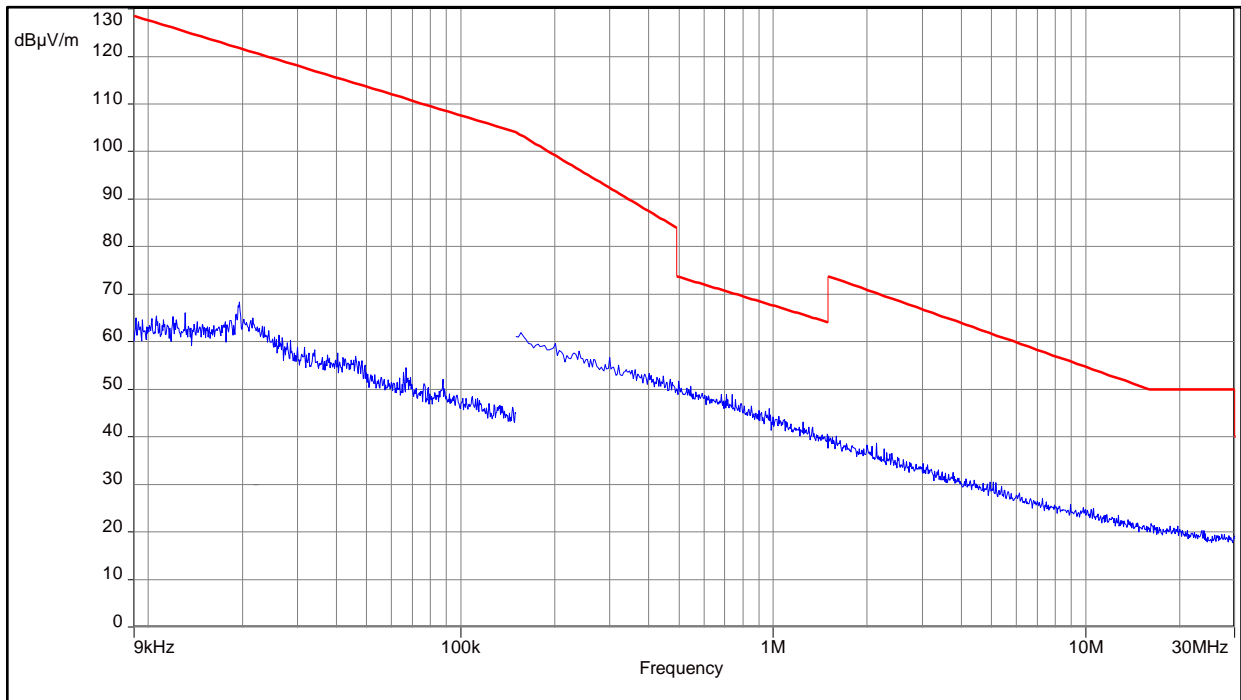

Plot 34: 30 MHz to 1 GHz, UWB test mode

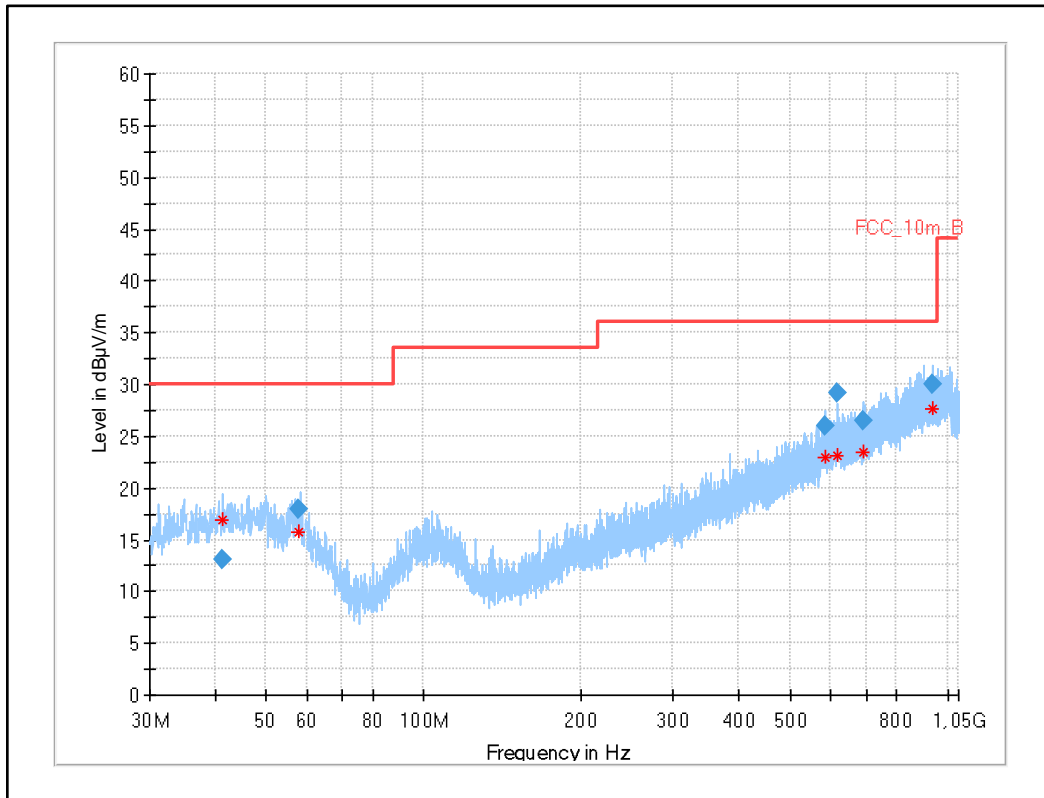

Frequency (MHz)	QuasiPeak (dBµV/m)	Limit (dBµV/m)	Margin (dB)	Meas. Time (ms)	Bandwidth (kHz)	Height (cm)	Pol	Azimuth (deg)	Corr. (dB/m)
41.149	13.01	30.0	17.0	1000	120.0	150.0	H	217	15
57.618	17.94	30.0	12.1	1000	120.0	153.0	V	52	15
582.687	25.95	36.0	10.1	1000	120.0	129.0	H	105	21
615.578	29.14	36.0	6.9	1000	120.0	123.0	H	52	22
688.778	26.45	36.0	9.6	1000	120.0	110.0	V	52	22
936.406	30.05	36.0	6.0	1000	120.0	153.0	H	232	26

Plot 35: 960 MHz to 4.8 GHz (Limit acc. to §15.519 (c)), UWB test mode

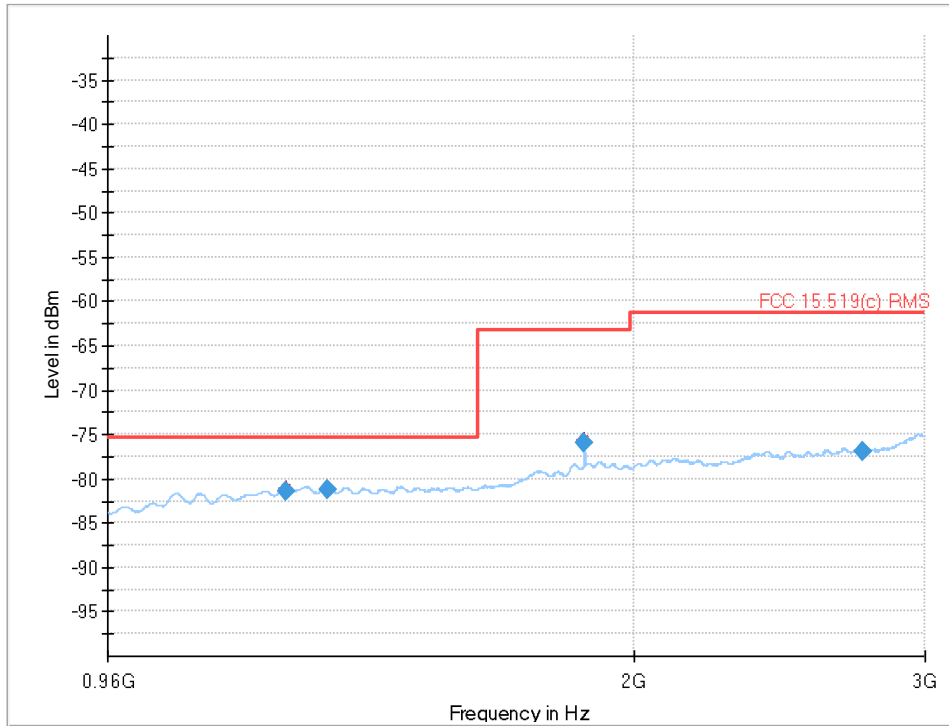

Frequency (MHz)	RMS (dBm)	Limit (dBm)	Margin (dB)	Bandwidth (kHz)	Pol	Azimuth (deg)	Elevation (deg)	Corr. (dB)
1231.269600	-81.33	-75.30	6.03	1000.000	V	255.0	18.0	-137.8
1303.238400	-81.25	-75.30	5.95	1000.000	V	212.0	10.0	-137.9
1866.685800	-75.93	-63.30	12.63	1000.000	H	183.0	157.0	-135.5
2750.860800	-76.91	-61.30	15.61	1000.000	V	206.0	30.0	-132.8

Plot 36: 3 GHz to 10 GHz, UWB test mode

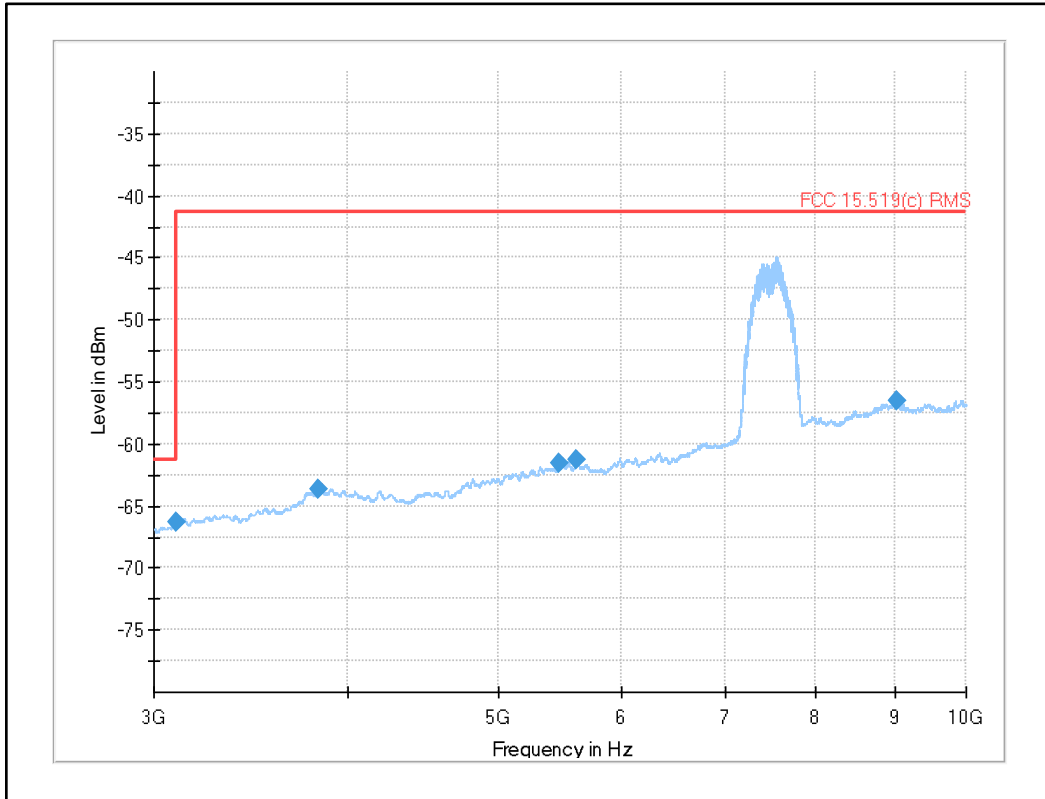

Frequency (MHz)	RMS (dBm)	Limit (dBm)	Margin (dB)	Bandwidth (kHz)	Pol	Azimuth (deg)	Elevation (deg)	Corr. (dB)
3098.852800	-66.31	-61.30	5.01	1000.000	H	217.0	155.0	-122.3
3830.129400	-63.64	-41.30	22.34	1000.000	H	168.0	125.0	-119.4
5472.747100	-61.56	-41.30	20.26	1000.000	H	69.0	3.0	-117.6
5617.042100	-61.23	-41.30	19.93	1000.000	H	25.0	147.0	-117.1
9020.616200	-56.54	-41.30	15.24	1000.000	H	15.0	75.0	-111.9

Plot 37: 10 GHz to 18 GHz, UWB test mode

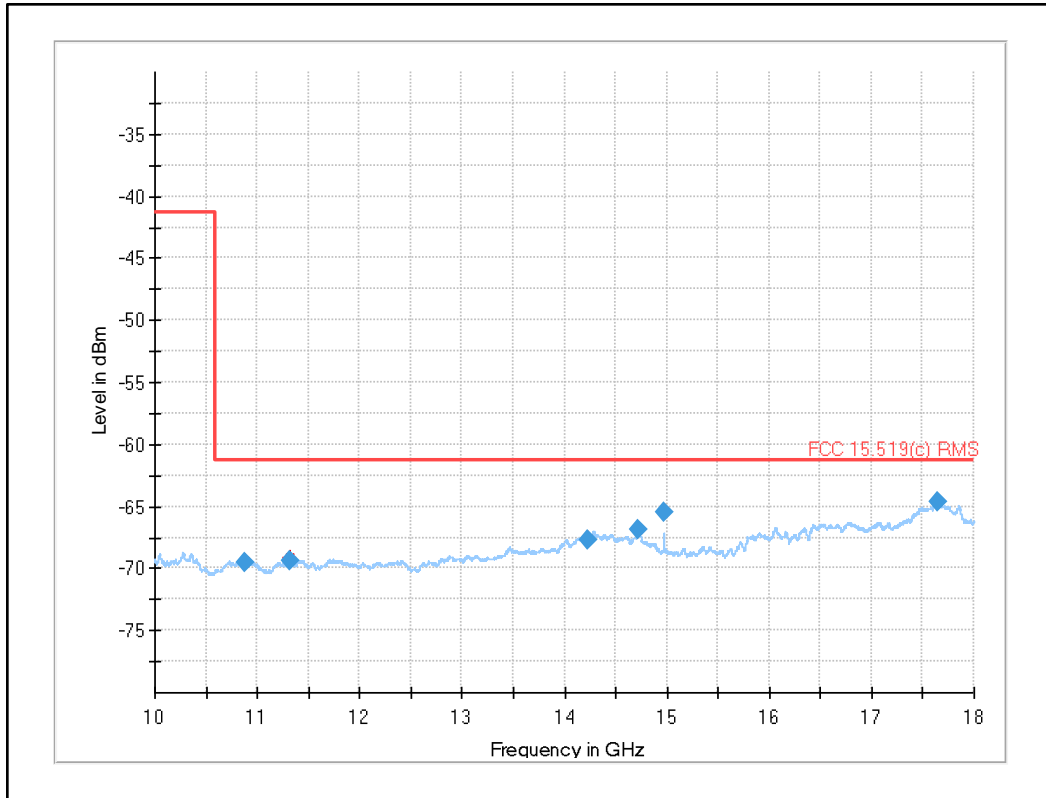

Frequency (MHz)	RMS (dBm)	Limit (dBm)	Margin (dB)	Bandwidth (kHz)	Pol	Azimuth (deg)	Elevation (deg)	Corr. (dB)
10876.870000	-69.50	-61.30	8.20	1000.000	H	315.0	15.0	-126.0
11320.470000	-69.33	-61.30	8.03	1000.000	V	85.0	91.0	-125.7
14220.117000	-67.71	-61.30	6.41	1000.000	V	312.0	116.0	-121.9
14722.044000	-66.94	-61.30	5.64	1000.000	V	25.0	6.0	-121.2
14975.981000	-65.45	-61.30	4.15	1000.000	H	304.0	16.0	-122.7
17643.286000	-64.66	-61.30	3.36	1000.000	V	71.0	6.0	-116.4

Plot 38: 18 GHz to 26.5 GHz, UWB test mode

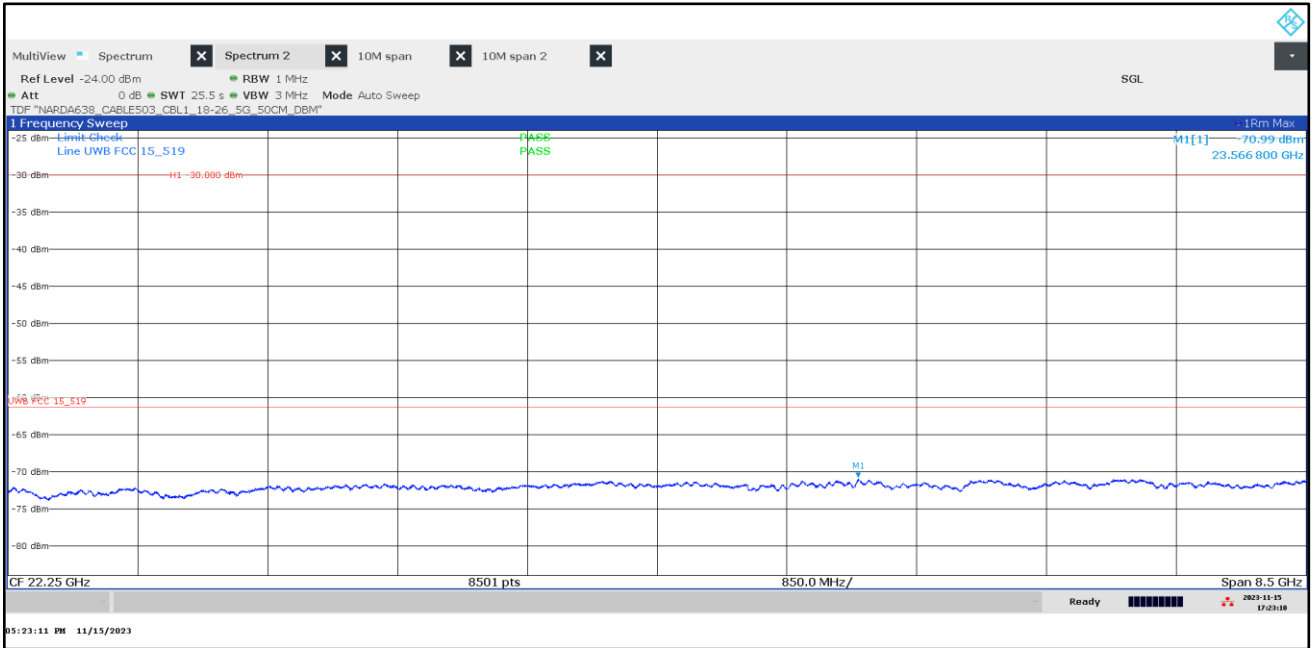

Plot 39: 26.5 GHz to 40.0 GHz, UWB test mode

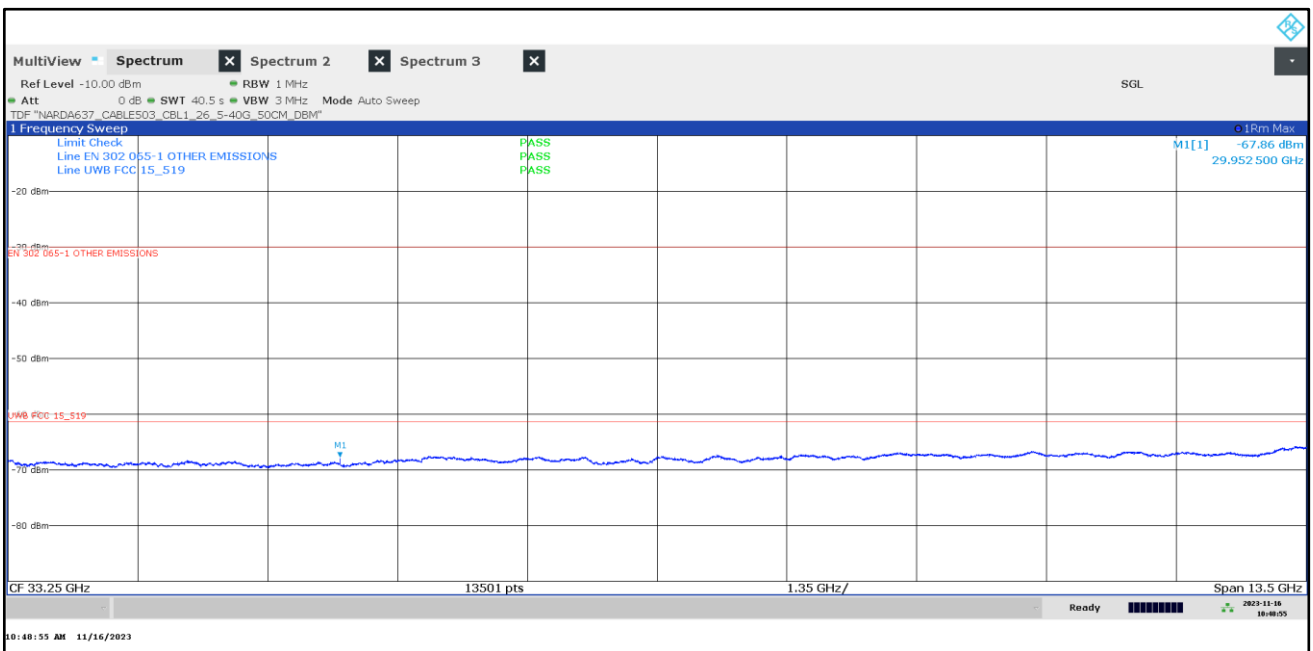

Plot 40: 29.9 GHz with 10 MHz span, UWB test mode

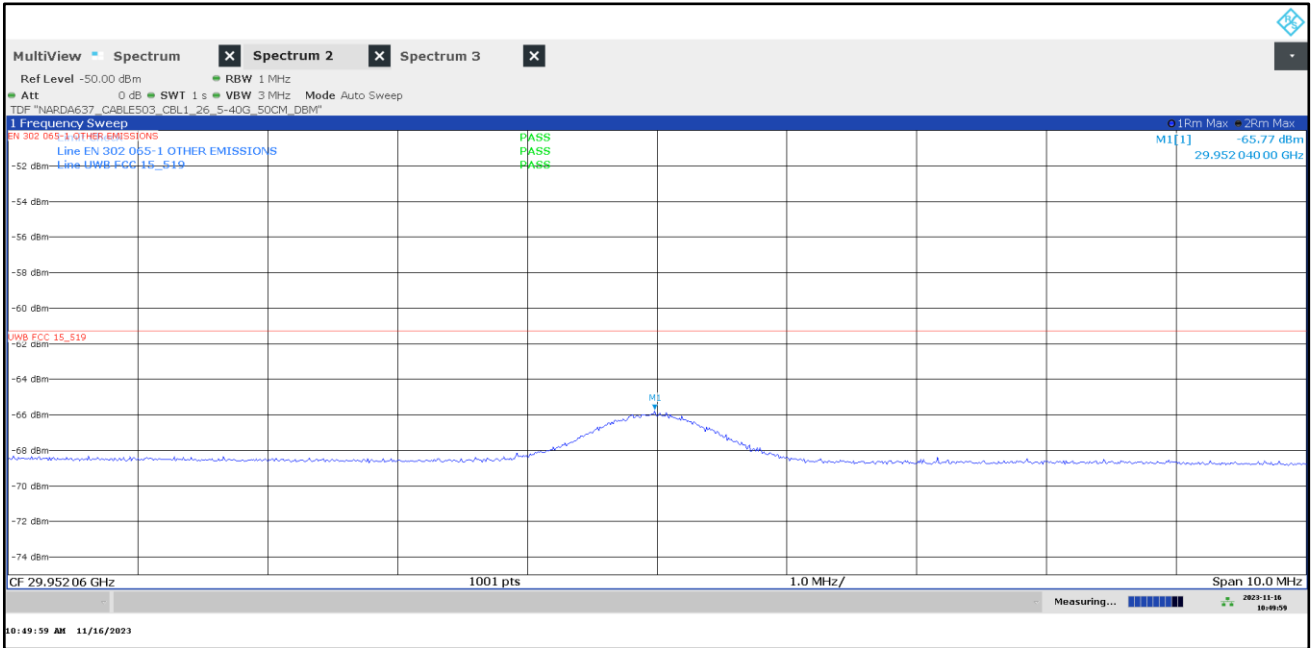

Plot 41: 29.9 GHz with zero span, UWB test mode

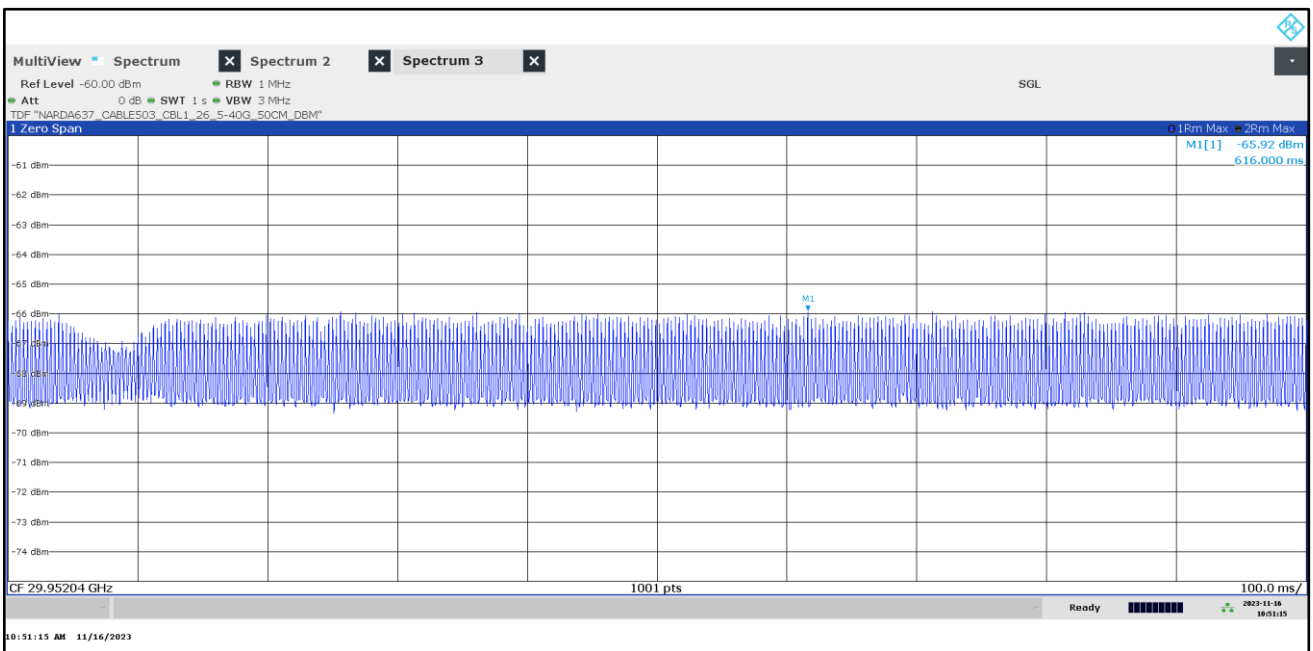

Plot 42: 1164 MHz to 1240 MHz (§15.519 (d)), UWB test mode

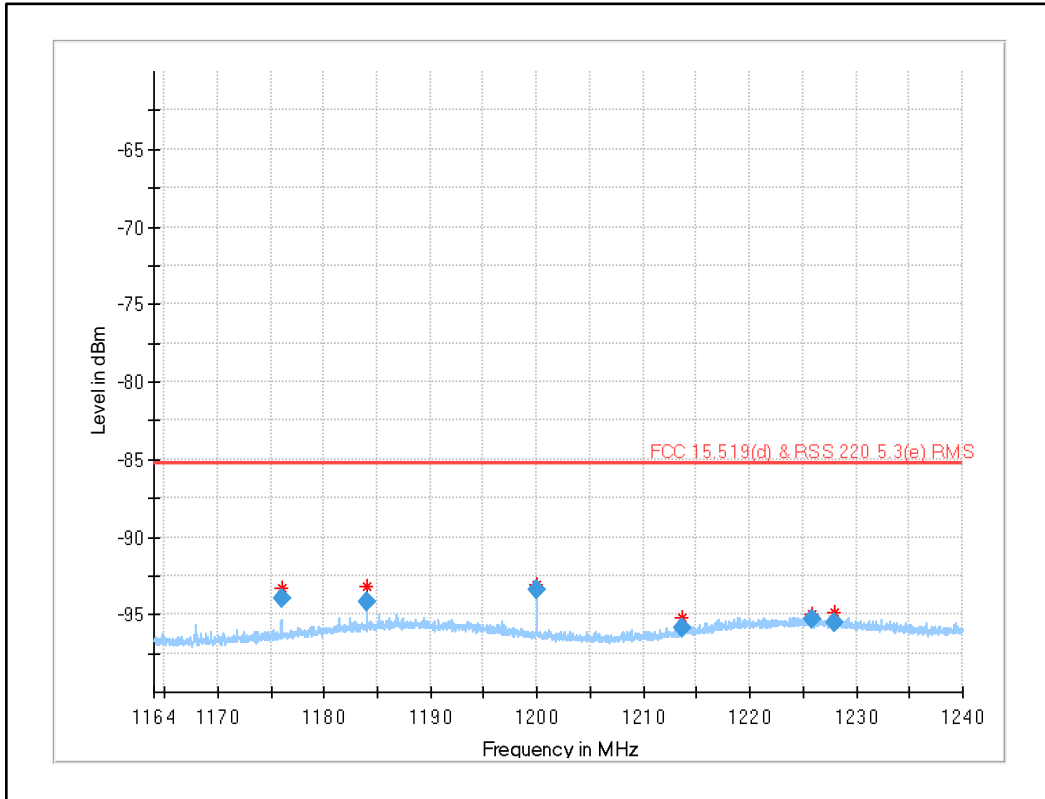

Frequency (MHz)	RMS (dBm)	Limit (dBm)	Margin (dB)	Bandwidth (kHz)	Pol	Azimuth (deg)	Elevation (deg)	Corr. (dB)
1175.987079	-93.99	-85.30	8.69	30.000	V	179.0	188.0	-139.9
1183.976714	-94.14	-85.30	8.84	30.000	V	185.0	193.0	-138.6
1199.999603	-93.45	-85.30	8.15	30.000	V	162.0	10.0	-139.5
1213.570674	-95.82	-85.30	10.52	30.000	H	95.0	55.0	-138.9
1225.817553	-95.32	-85.30	10.02	30.000	H	249.0	5.0	-137.9
1227.891868	-95.57	-85.30	10.27	30.000	H	25.0	35.0	-138.1

Plot 43: 1559 MHz to 1610 MHz (§15.519 (d)), UWB test mode

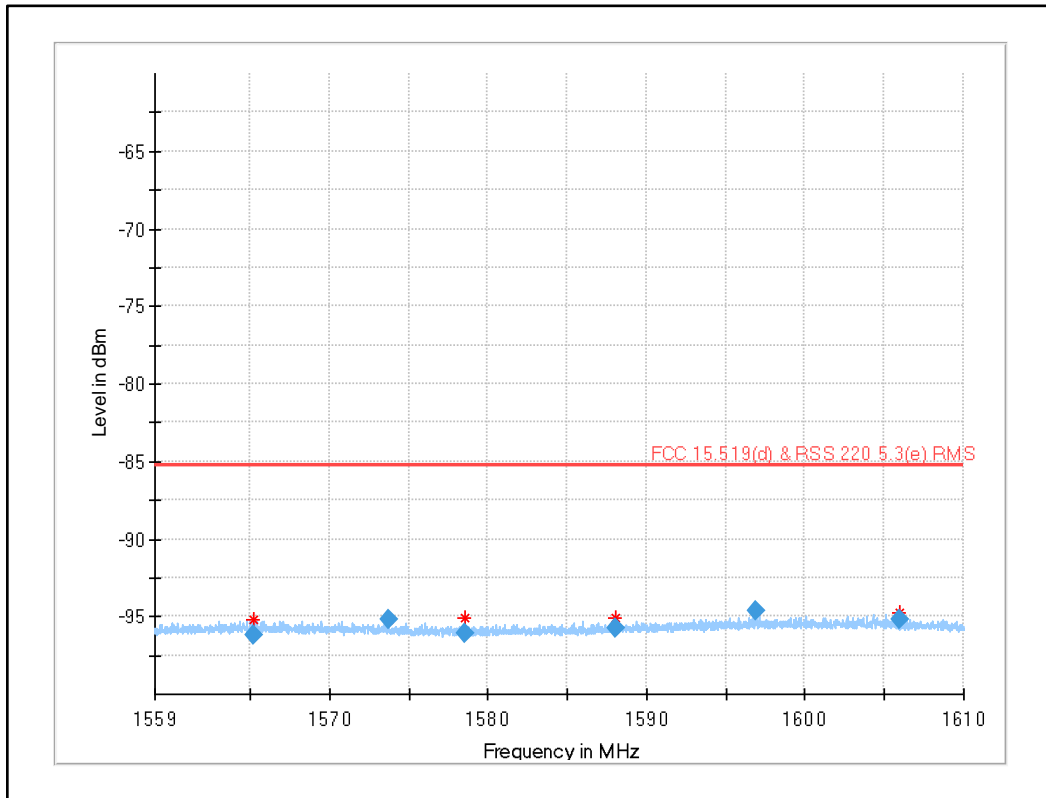

Frequency (MHz)	RMS (dBm)	Limit (dBm)	Margin (dB)	Bandwidth (kHz)	Pol	Azimuth (deg)	Elevation (deg)	Corr. (dB)
1565.213538	-96.19	-85.30	10.89	30.000	H	64.0	171.0	-138.2
1573.728624	-95.15	-85.30	9.85	30.000	H	245.0	173.0	-138.5
1578.558235	-96.11	-85.30	10.81	30.000	H	245.0	65.0	-138.7
1588.053588	-95.70	-85.30	10.40	30.000	H	236.0	135.0	-138.4
1596.896406	-94.69	-85.30	9.39	30.000	H	295.0	15.0	-137.9
1605.942782	-95.15	-85.30	9.85	30.000	H	208.0	25.0	-138.1

12.2.4 Radiated emissions channel 9

Plot 44: Fundamental emission (UWB test mode): RMS

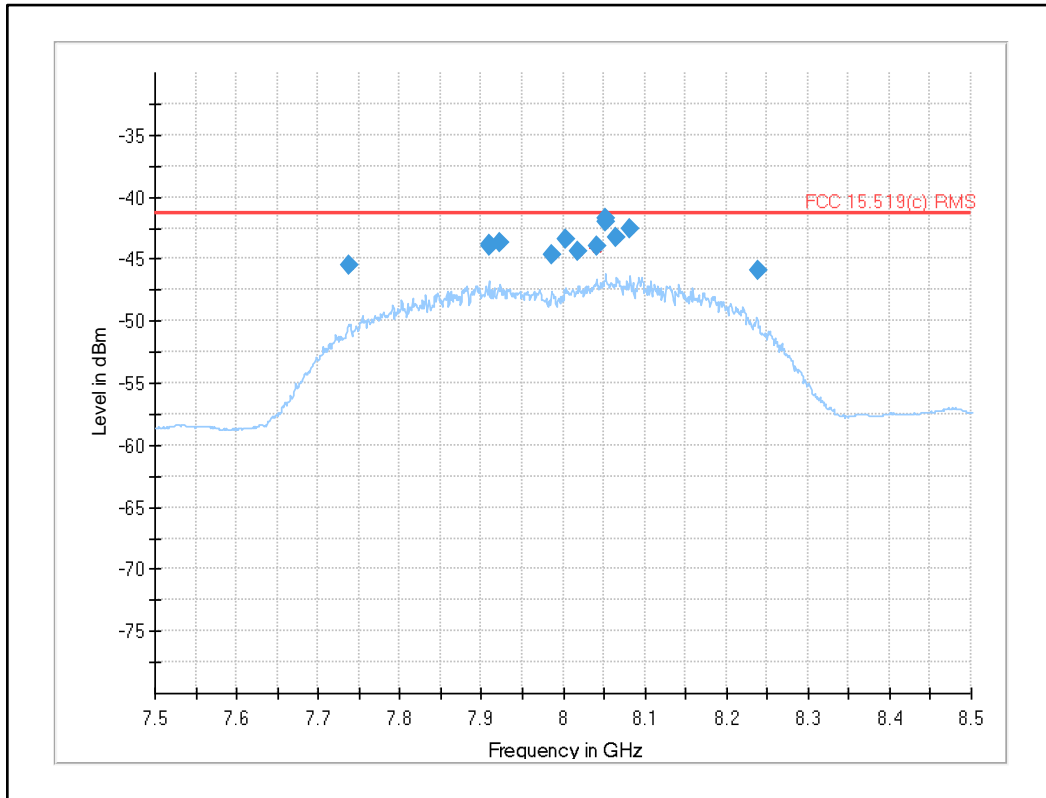

Frequency (MHz)	RMS (dBm)	Limit (dBm)	Margin (dB)	Bandwidth (kHz)	Pol	Azimuth (deg)	Elevation (deg)	Corr. (dB)
7737.630600	-45.49	-41.30	4.19	1000.000	H	19.0	164.0	-115.4
7909.035400	-43.79	-41.30	2.49	1000.000	V	345.0	150.0	-114.7
7909.110400	-43.94	-41.30	2.64	1000.000	V	345.0	150.0	-114.7
7922.740800	-43.72	-41.30	2.42	1000.000	V	345.0	147.0	-114.6
7986.030000	-44.65	-41.30	3.35	1000.000	V	345.0	149.0	-114.7
8003.734800	-43.44	-41.30	2.14	1000.000	H	348.0	45.0	-114.4
8018.679000	-44.38	-41.30	3.08	1000.000	H	342.0	30.0	-114.7
8040.706000	-44.03	-41.30	2.73	1000.000	H	340.0	30.0	-114.4
8051.643600	-42.01	-41.30	0.71	1000.000	V	355.0	152.0	-114.6
8051.683800	-41.79	-41.30	0.49	1000.000	V	355.0	152.0	-114.6
8065.324600	-43.27	-41.30	1.97	1000.000	V	345.0	150.0	-114.8
8081.748000	-42.60	-41.30	1.30	1000.000	H	349.0	45.0	-114.7
8239.560800	-45.95	-41.30	4.65	1000.000	H	-6.0	30.0	-114.8

Plot 45: Fundamental emission (UWB test mode): Max Peak

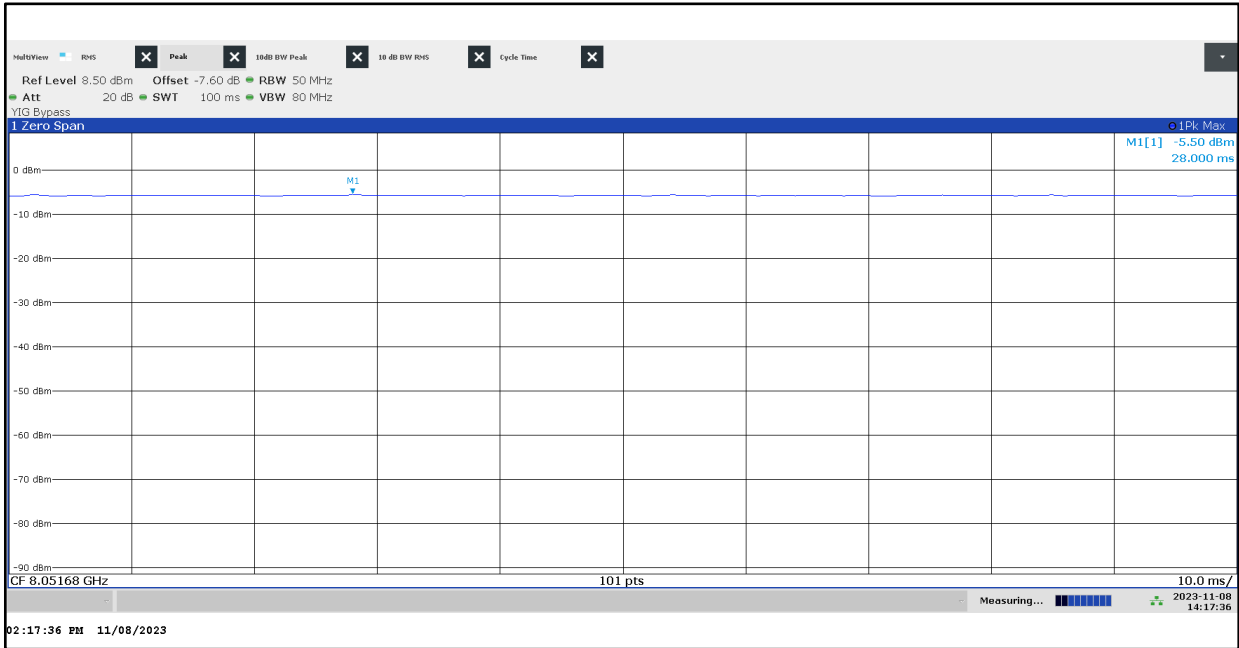

Plot 46: 9 kHz to 30 MHz, UWB test mode

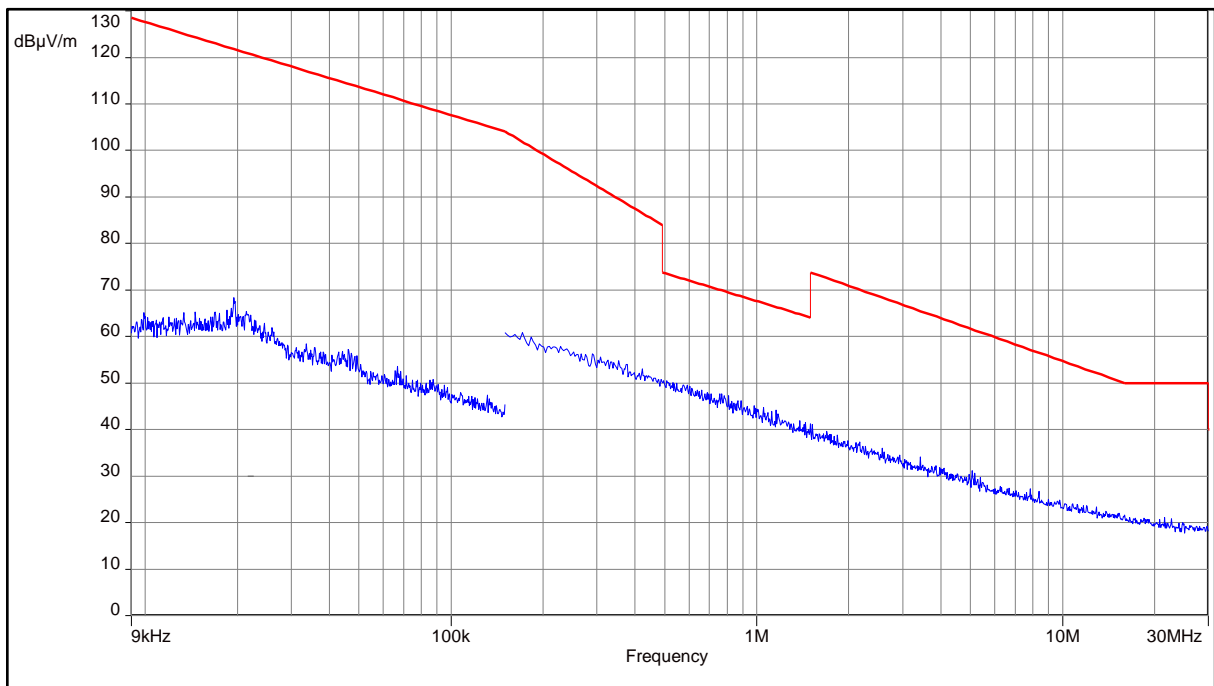

Plot 47: 30 MHz to 1 GHz, UWB test mode

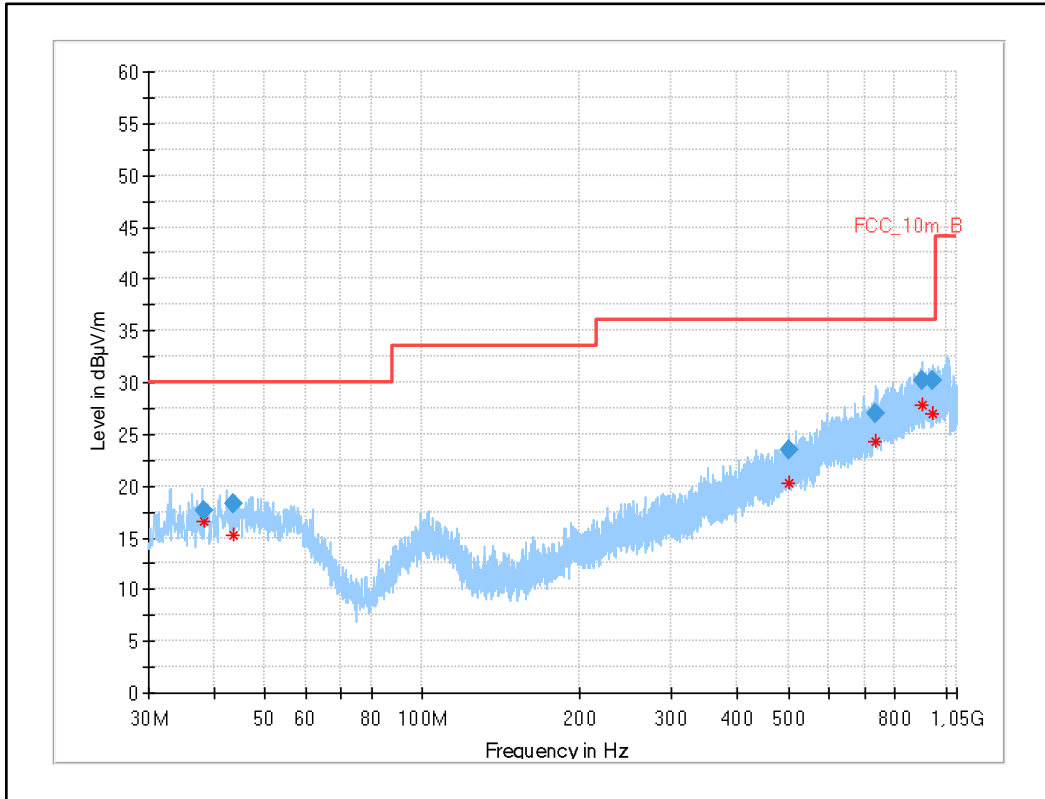

Frequency (MHz)	QuasiPeak (dBµV/m)	Limit (dBµV/m)	Margin (dB)	Meas. Time (ms)	Bandwidth (kHz)	Height (cm)	Pol	Azimuth (deg)	Corr. (dB/m)
38.140	17.56	30.0	12.4	1000	120.0	169.0	V	232	15
43.710	18.33	30.0	11.7	1000	120.0	127.0	H	233	16
502.714	23.52	36.0	12.5	1000	120.0	195.0	V	-31	20
733.004	26.96	36.0	9.0	1000	120.0	195.0	V	-37	23
903.536	30.18	36.0	5.8	1000	120.0	195.0	V	22	26
942.084	30.23	36.0	5.8	1000	120.0	195.0	H	52	26

Plot 48: 960 MHz to 4.8 GHz (Limit acc. to §15.519 (c)), UWB test mode

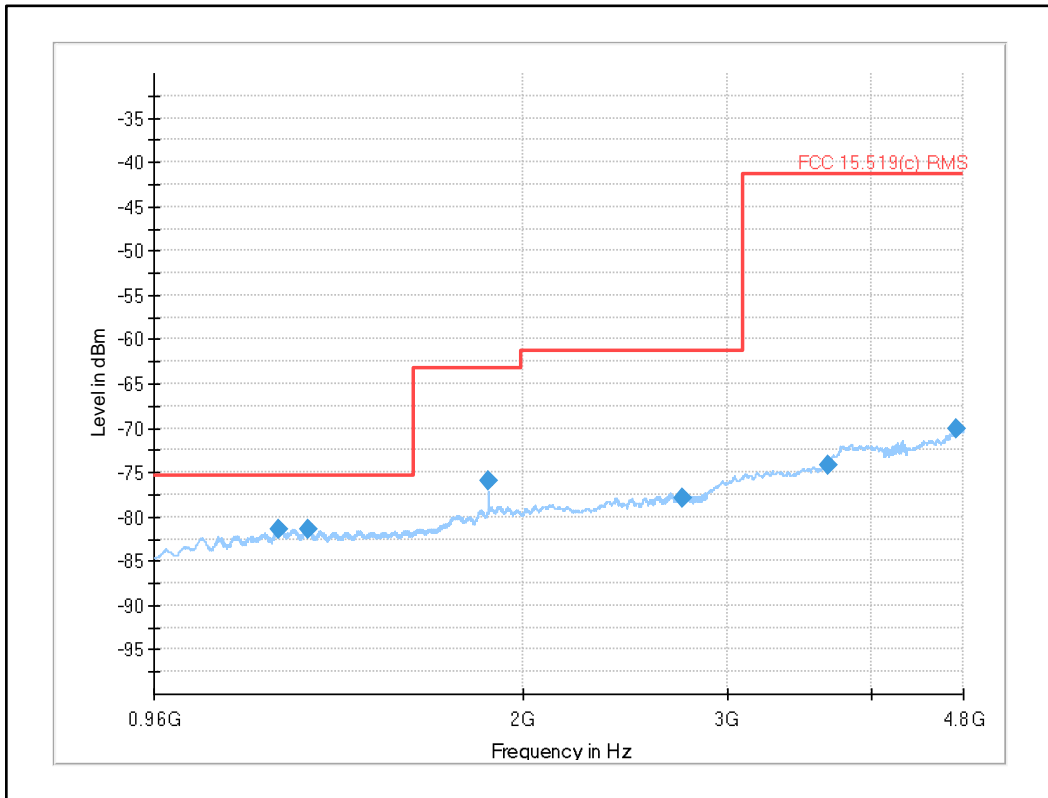

Frequency (MHz)	RMS (dBm)	Limit (dBm)	Margin (dB)	Bandwidth (kHz)	Pol	Azimuth (deg)	Elevation (deg)	Corr. (dB)
1229.073600	-81.48	-75.30	6.18	1000.000	H	116.0	58.0	-137.7
1303.284000	-81.43	-75.30	6.13	1000.000	H	163.0	35.0	-137.7
1866.639000	-75.98	-63.30	12.68	1000.000	H	343.0	20.0	-135.5
2750.434800	-77.92	-61.30	16.62	1000.000	H	259.0	160.0	-132.8
3668.769000	-74.13	-41.30	32.83	1000.000	H	90.0	60.0	-130.1
4737.615000	-70.12	-41.30	28.82	1000.000	H	184.0	46.0	-126.2

Plot 49: 4.8 GHz to 10 GHz, UWB test mode

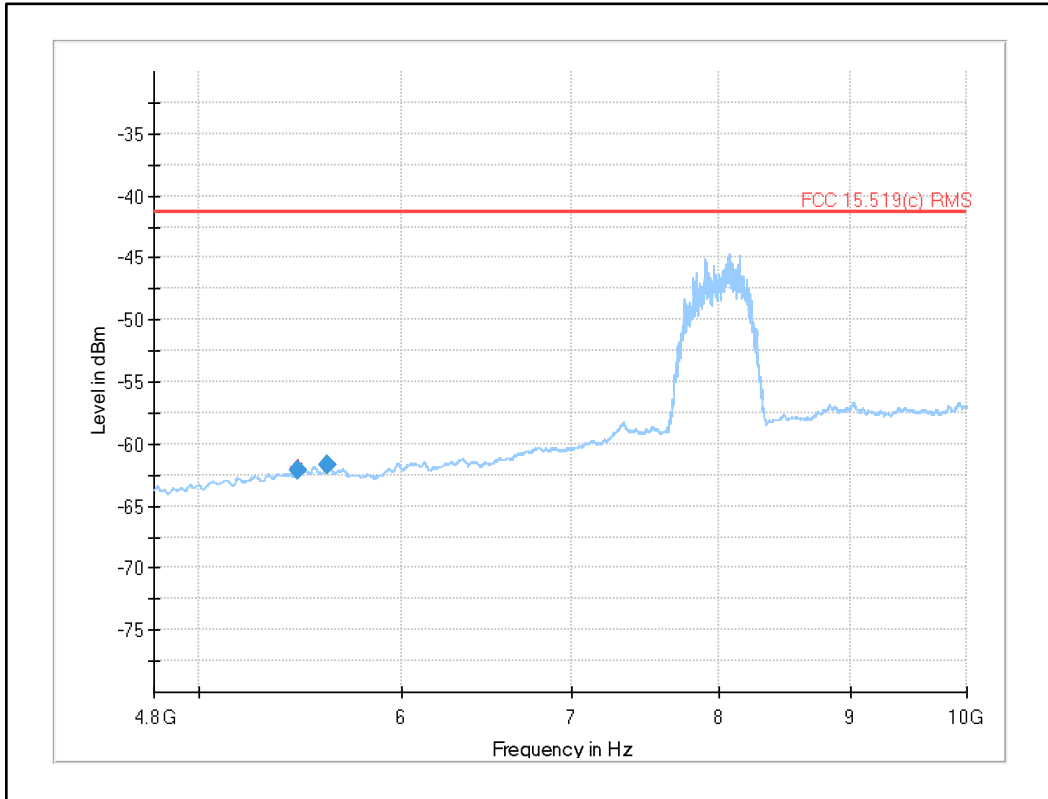

Frequency (MHz)	RMS (dBm)	Limit (dBm)	Margin (dB)	Bandwidth (kHz)	Pol	Azimuth (deg)	Elevation (deg)	Corr. (dB)
5468.712973	-62.10	-41.30	20.80	1000.000	H	215.0	195.0	-117.3
5611.921487	-61.67	-41.30	20.37	1000.000	H	349.0	120.0	-116.8

Plot 50: 10 GHz to 18 GHz, UWB test mode

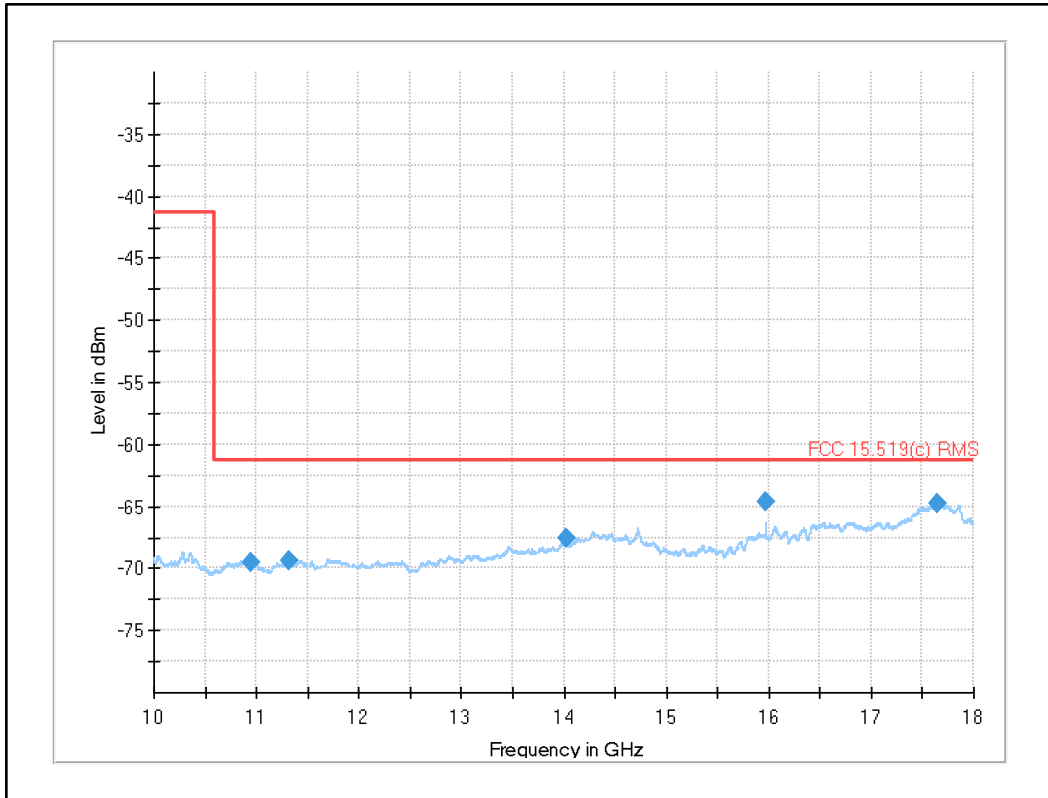

Frequency (MHz)	RMS (dBm)	Limit (dBm)	Margin (dB)	Bandwidth (kHz)	Pol	Azimuth (deg)	Elevation (deg)	Corr. (dB)
10953.069000	-69.58	-61.30	8.28	1000.000	V	126.0	0.0	-126.2
11319.468000	-69.45	-61.30	8.15	1000.000	V	87.0	15.0	-125.7
14020.317000	-67.57	-61.30	6.27	1000.000	V	65.0	15.0	-122.0
15974.509000	-64.70	-61.30	3.40	1000.000	H	19.0	63.0	-121.6
17648.784000	-64.83	-61.30	3.53	1000.000	V	27.0	15.0	-116.4

Plot 51: 18 GHz to 26.5 GHz, UWB test mode

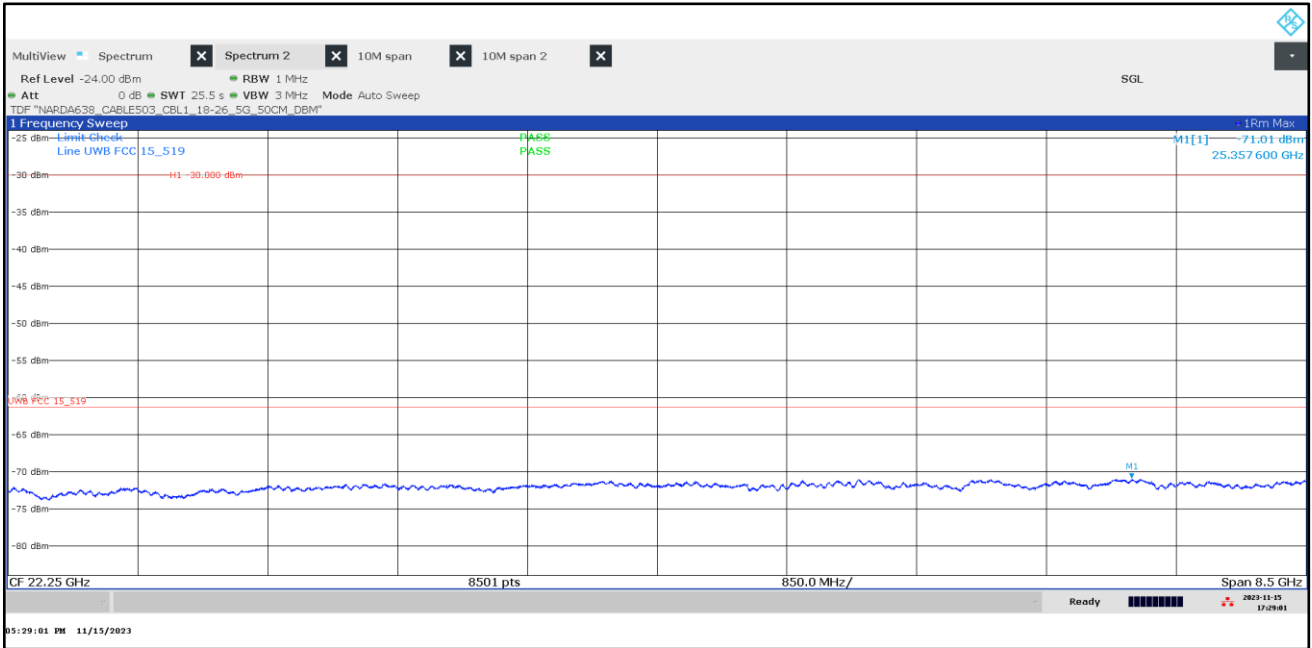

Plot 52: 26.5 GHz to 40.0 GHz, UWB test mode

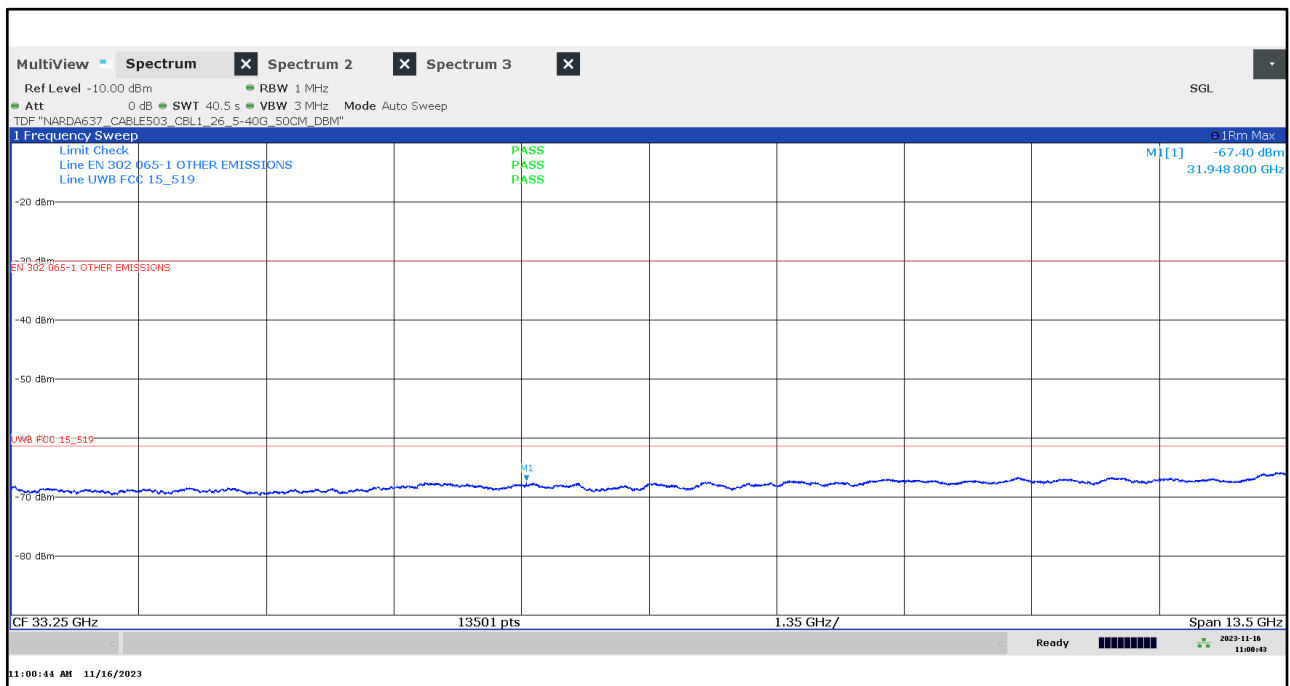

Plot 53: 31.9 GHz, with 10 MHz span, UWB test mode

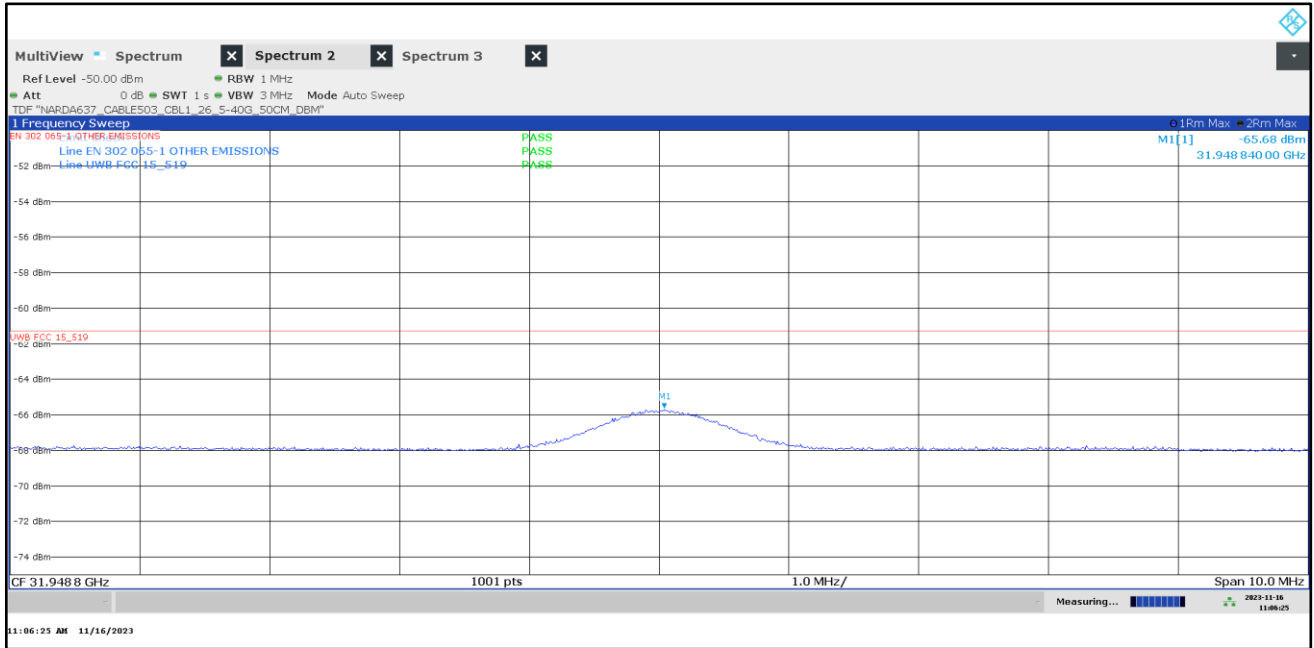

Plot 54: 31.9 GHz, with zero span, UWB test mode

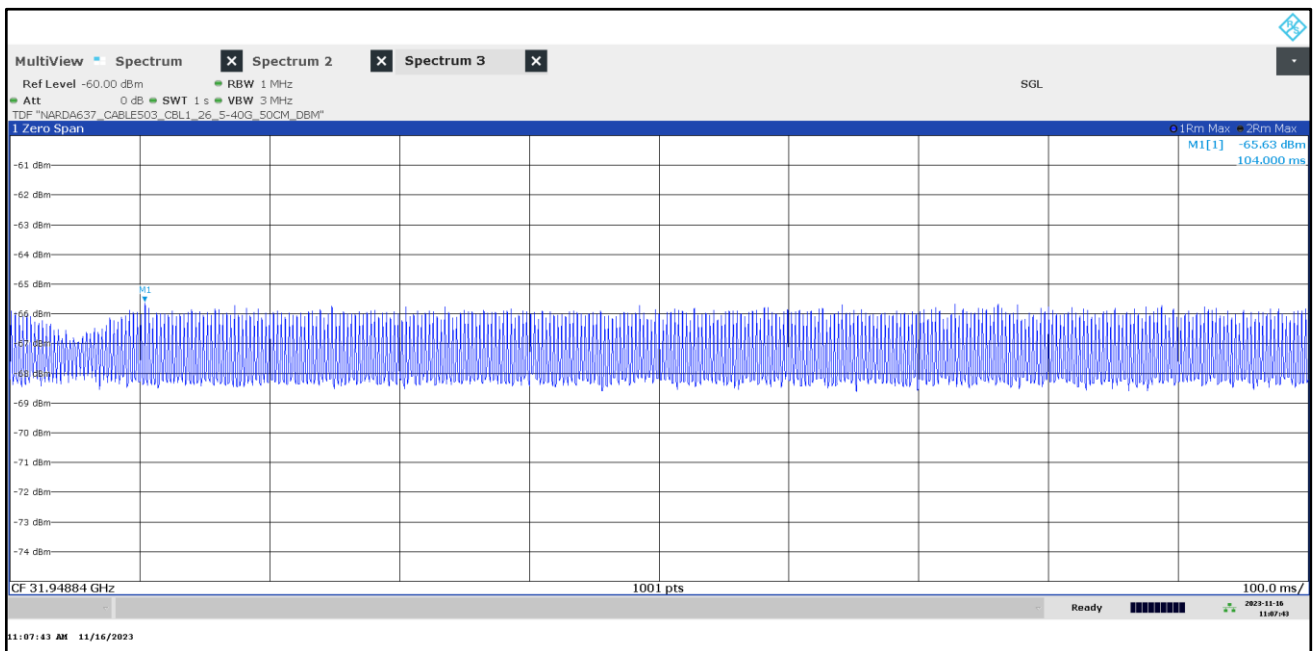

Plot 55: 1164 MHz to 1240 MHz (§15.519 (d), UWB test mode

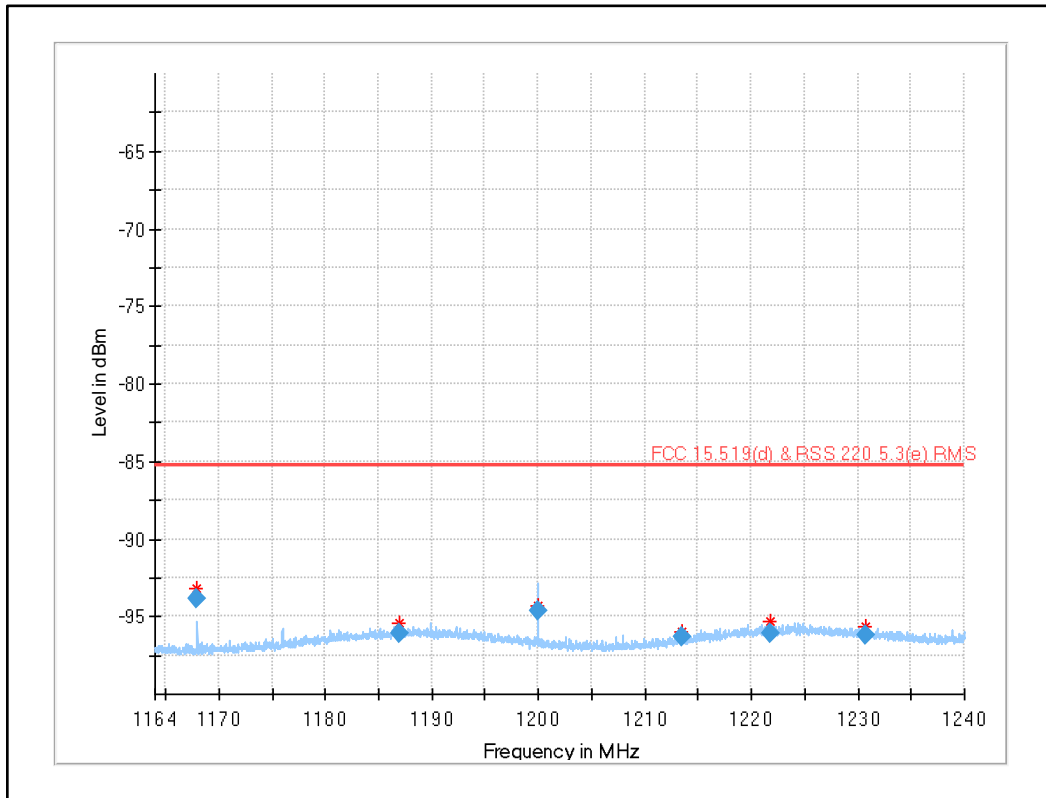

Frequency (MHz)	RMS (dBm)	Limit (dBm)	Margin (dB)	Bandwidth (kHz)	Pol	Azimuth (deg)	Elevation (deg)	Corr. (dB)
1167.979989	-93.82	-85.30	8.52	30.000	V	185.0	142.0	-140.5
1187.023488	-96.13	-85.30	10.83	30.000	H	167.0	61.0	-138.0
1200.001841	-94.69	-85.30	9.39	30.000	V	146.0	6.0	-139.5
1213.466915	-96.33	-85.30	11.03	30.000	H	88.0	45.0	-138.9
1221.836153	-96.10	-85.30	10.80	30.000	V	226.0	180.0	-138.0
1230.770391	-96.25	-85.30	10.95	30.000	V	292.0	12.0	-138.6

Plot 56: 1559 MHz to 1610 MHz (§15.519 (d), UWB test mode

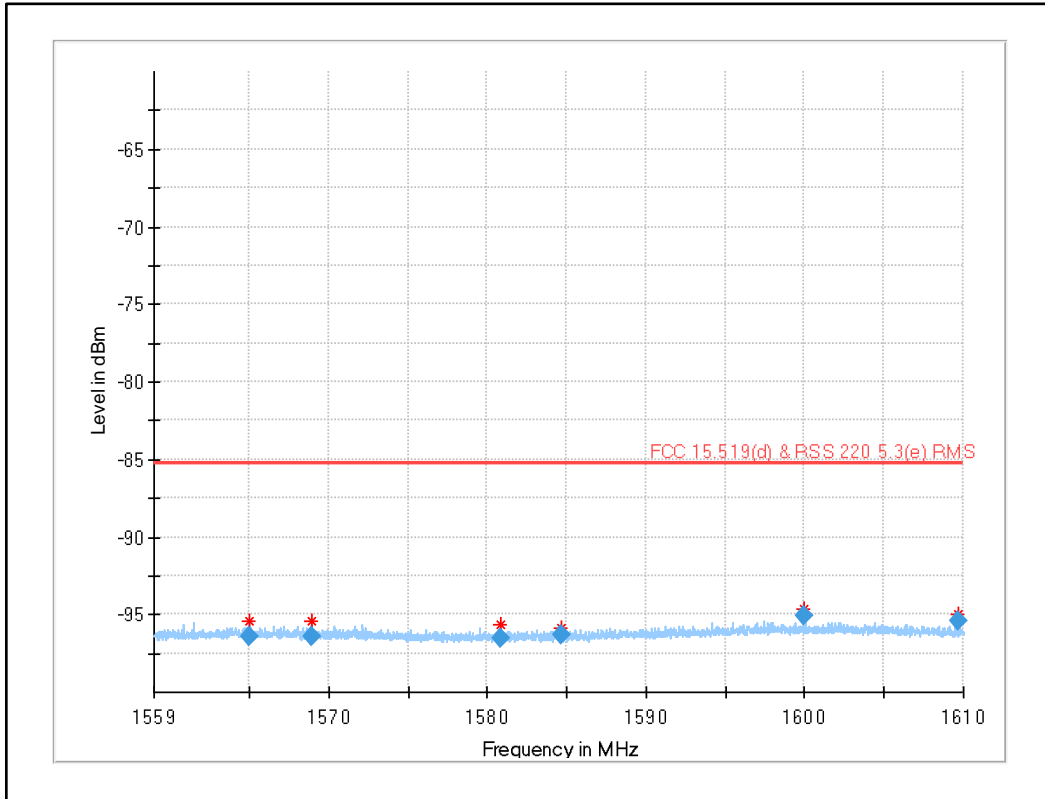

Frequency (MHz)	RMS (dBm)	Limit (dBm)	Margin (dB)	Bandwidth (kHz)	Pol	Azimuth (deg)	Elevation (deg)	Corr. (dB)
1564.985865	-96.38	-85.30	11.08	30.000	V	270.0	142.0	-138.3
1568.887541	-96.37	-85.30	11.07	30.000	H	306.0	45.0	-138.3
1580.841588	-96.49	-85.30	11.19	30.000	H	128.0	1.0	-138.8
1584.668724	-96.32	-85.30	11.02	30.000	V	272.0	63.0	-138.8
1599.997691	-95.07	-85.30	9.77	30.000	V	133.0	54.0	-138.1
1609.623888	-95.41	-85.30	10.11	30.000	H	258.0	192.0	-138.3

12.3 Efficient use of spectrum acc. to §15.519(a)(1)

Description:

§15.519(a)(1)

A UWB device operating under the provisions of this section shall transmit only when it is sending information to an associated receiver. The UWB intentional radiator shall cease transmission within 10 seconds unless it receives an acknowledgement from the associated receiver that its transmission is being received. An acknowledgment of reception must continue to be received by the UWB intentional radiator at least every 10 seconds or the UWB device must cease transmitting.

KDB 393764 D01 UWB FAQ v02r01 Answer 4

An acknowledgement of reception must continue to be received by the UWB device at least once every 10 seconds, or else the device shall cease transmission of any information other than periodic signals for use in the establishment or re-establishment of a communications link with an associated receiver.

Limits and provisions:

§15.519(a)(1) & KDB 393764

EUT shall cease transmission of information within 10 seconds unless it receives an acknowledgement from the associated receiver.

However, periodic signals used for the establishment or re-establishment of a communication link with an associated receiver may be transmitted.

Measurement:

Measurement parameter	
Detector:	Pos-Peak
Resolution bandwidth:	1 MHz
Video bandwidth:	3 MHz
Span	Zero

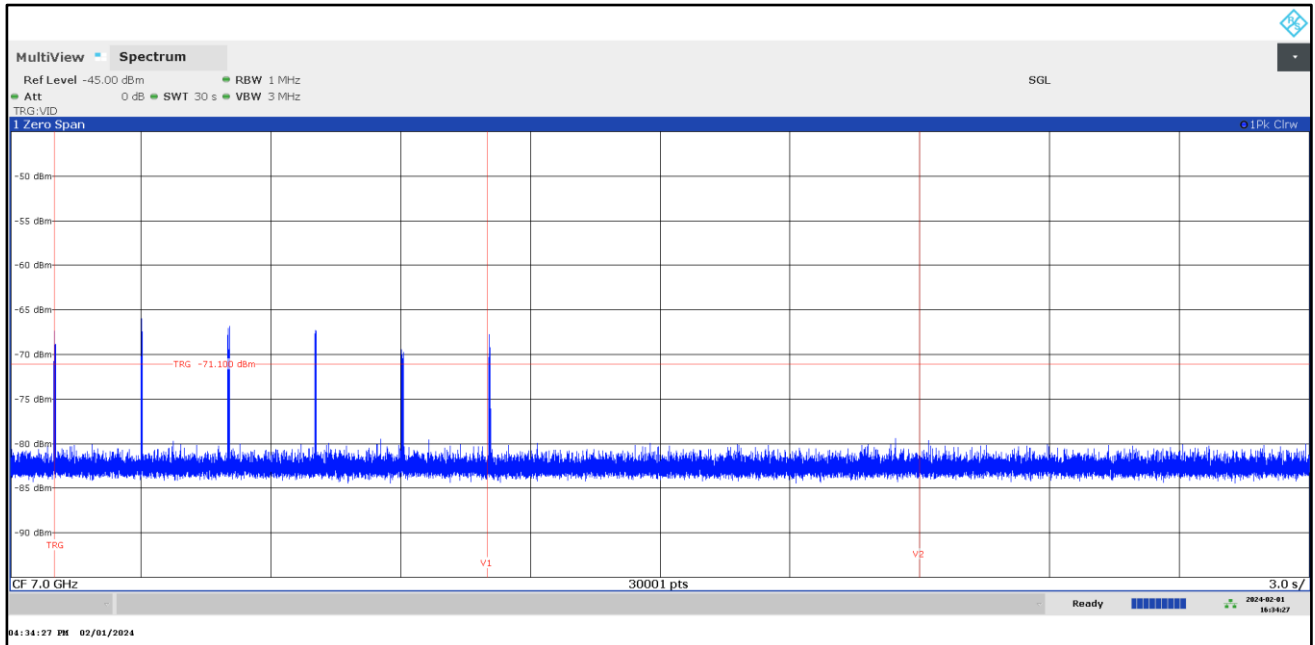
Results:**Plot 57: Emissions of the EUT, only at the beginning with associated receiver (Normal mode)**

Vertical line V1 indicates the time when the associated receiver is switched off.

Vertical line V2 indicates 10 s after the associated receiver is switched off.

→ Immediately after the associated receiver is switched off, the EUT ceases transmission of information and only sends periodic signals used for the establishment or re-establishment of a communication link.

Note:

As declared by the customer, the switch-off behavior verified above is a general feature of the software and does not depend on the selected UWB channel.

According to this declaration, the tests above are representative for all channels. Hence, ceasing the transmission of information in case no acknowledgement from the associated receiver is received also applies for channel CH 5, CH 8 and CH 9.

Plot 58: Emission of EUT (for comparison), normal mode

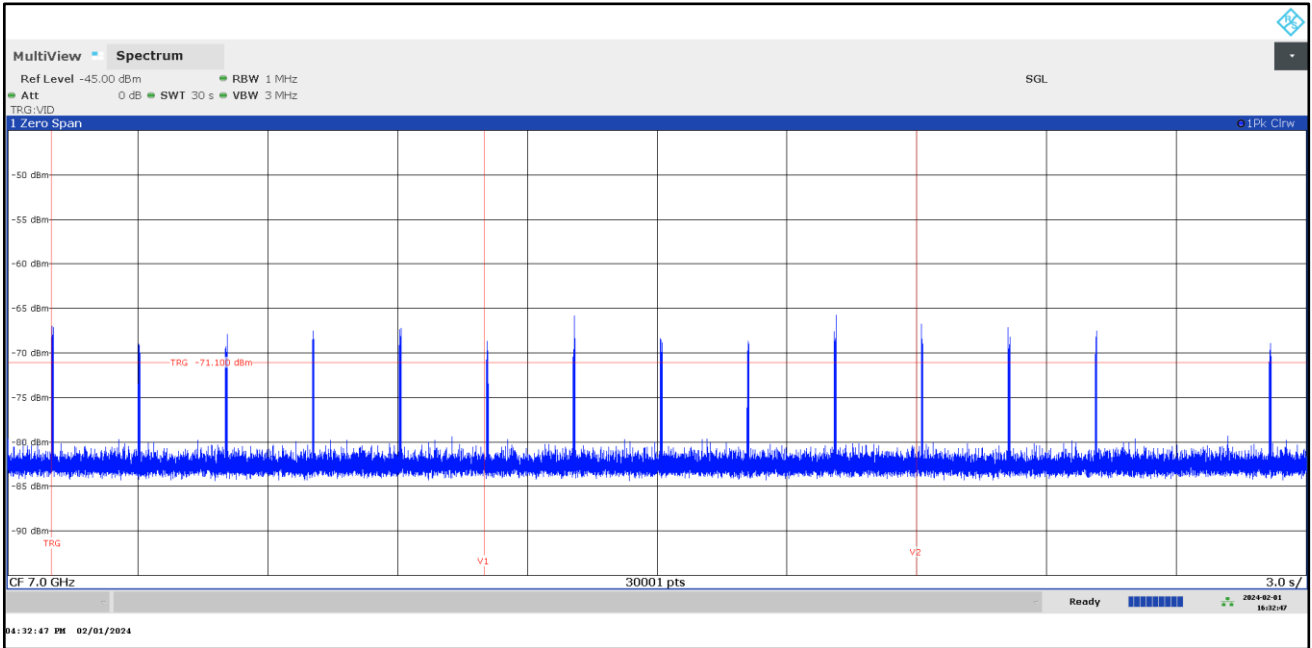

→ Signals are used for the establishment or re-establishment of a communication link.

Verdict: Compliant

12.4 Antenna requirements

Description:

§15.519(a)(2)

The use of antennas mounted on outdoor structures, e.g., antennas mounted on the outside of a building or on a telephone pole, or any fixed outdoors infrastructure is prohibited. Antennas may be mounted only on the hand held UWB device.

§15.521(b)

Manufacturers and users are reminded of the provisions of §§15.203 and 15.204.

Results:

Integrated antenna.

Verdict: Compliant

12.5 Conducted emissions < 30MHz

Description:

Measurement of the conducted spurious emissions in transmit mode below 30 MHz. Both power lines, phase and neutral line, are measured. Found peaks are re-measured with average and quasi peak detection to show compliance to the limits.

Limits and provisions:

FCC		IC	
CFR Part 15.207(a)		RSS-Gen 8.8	
Conducted Spurious Emissions < 30 MHz			
Frequency (MHz)	Quasi-Peak (dB μ V)	Average (dB μ V)	
0.15 – 0.5	66 to 56*	56 to 46*	
0.5 – 5	56	46	
5 – 30.0	60	50	

*Decreases with the logarithm of the frequency

Measurement:

Parameter	
Detector:	Peak - Quasi Peak / Average
Sweep time:	Auto
Video bandwidth:	F < 150 kHz: 200 Hz F > 150 kHz: 9 kHz
Resolution bandwidth:	F < 150 kHz: 1 kHz F > 150 kHz: 100 kHz
Span:	9 kHz to 30 MHz
Trace-Mode:	Max Hold

§15.521(j)

Responsible parties are reminded of the other standards and requirements cross referenced in §15.505, such as a limit on emissions conducted onto the AC power lines.

§15.207(c)

Measurements to demonstrate compliance with the conducted limits are not required for devices which only employ battery power for operation and which do not operate from the AC power lines or contain provisions for operation while connected to the AC power lines. Devices that include, or make provisions for, the use of battery chargers which permit operating while charging, AC adapters or battery eliminators or that connect to the AC power lines indirectly, obtaining their power through another device which is connected to the AC power lines, shall be tested to demonstrate compliance with the conducted limits.

Results:

The device only employs battery power for operation (as declared by manufacturer).

Verdict: Not applicable

13 Glossary

EUT	Equipment under test
DUT	Device under test
UUT	Unit under test
GUE	GNSS User Equipment
ETSI	European Telecommunications Standards Institute
EN	European Standard
FCC	Federal Communications Commission
FCC ID	Company Identifier at FCC
IC	Industry Canada
PMN	Product marketing name
HMN	Host marketing name
HVIN	Hardware version identification number
FVIN	Firmware version identification number
EMC	Electromagnetic Compatibility
HW	Hardware
SW	Software
Inv. No.	Inventory number
S/N or SN	Serial number
C	Compliant
NC	Not compliant
NA	Not applicable
NP	Not performed
PP	Positive peak
QP	Quasi peak
AVG	Average
OC	Operating channel
OCW	Operating channel bandwidth
OBW	Occupied bandwidth
OOB	Out of band
DFS	Dynamic frequency selection
CAC	Channel availability check
OP	Occupancy period
NOP	Non occupancy period
DC	Duty cycle
PER	Packet error rate
CW	Clean wave
MC	Modulated carrier
WLAN	Wireless local area network
RLAN	Radio local area network
DSSS	Dynamic sequence spread spectrum
OFDM	Orthogonal frequency division multiplexing
FHSS	Frequency hopping spread spectrum
GNSS	Global Navigation Satellite System
C/N₀	Carrier to noise-density ratio, expressed in dB-Hz

14 Document history

Version	Applied changes	Date of release
-/-	Initial release	2024-03-26

END OF TEST REPORT