



TEST REPORT

Test report no.: 1-9695/19-01-09



BNetzA-CAB-02/21-102

Testing laboratory

CTC advanced GmbH

Untertuerkheimer Strasse 6 – 10
66117 Saarbruecken / Germany

Phone: + 49 681 5 98 - 0

Fax: + 49 681 5 98 - 9075

Internet: <http://www.ctcadvanced.com>

e-mail: mail@ctcadvanced.com

Accredited Testing Laboratory:

The testing laboratory (area of testing) is accredited according to DIN EN ISO/IEC 17025 (2005) by the Deutsche Akkreditierungsstelle GmbH (DAkkS)

The accreditation is valid for the scope of testing procedures as stated in the accreditation certificate with the registration number: D-PL-12076-01-03

Applicant

Marquardt GmbH

Schloss-Str. 16
78604 Rietheim-Weilheim / GERMANY

Phone:

Contact: Gerd Siegel

e-mail: Gerd.Siegel@marquardt.de

Phone: +49 (0) 74 24 - 99 0

Manufacturer

Marquardt GmbH

Schloss-Str. 16
78604 Rietheim-Weilheim / GERMANY

Test standard/s

47 CFR Part 15

Title 47 of the Code of Federal Regulations; Chapter I; Part 15 - Radio frequency devices

For further applied test standards please refer to section 3 of this test report.

Test Item

Kind of test item: Passive Entry Car Key

Model name: MS5

FCC ID: IYZMS5

Frequency: 6.520 GHz – 7.560 GHz

Technology tested: UWB

Antenna: Integrated antenna

Power supply: 2.5 V to 3.2 V DC by battery

Temperature range: -20°C to +65°C

This test report is electronically signed and valid without handwritten signature. For verification of the electronic signatures, the public keys can be requested at the testing laboratory.

Test report authorized:

Thomas Vogler
Lab Manager
Radio Communications & EMC

Test performed:

Sebastian Janoschka
Testing Manager
Radio Communications & EMC

1 Table of contents

1	Table of contents	2
2	General information	3
2.1	Notes and disclaimer	3
2.2	Application details	3
2.3	Test laboratories sub-contracted	3
3	Test standard/s and references	4
4	Test environment	5
5	Test item	5
5.1	General description	5
5.2	Test modes	6
5.3	Additional information	6
6	Description of the test setup	6
6.1	Shielded semi anechoic chamber	7
6.2	Shielded fully anechoic chamber	8
6.3	Radiated measurements > 18 GHz	10
6.4	Efficient use of spectrum	11
7	Sequence of testing	12
7.1	Sequence of testing radiated spurious 9 kHz to 30 MHz	12
7.2	Sequence of testing radiated spurious 30 MHz to 1 GHz	13
7.3	Sequence of testing radiated spurious 1 GHz to 18 GHz	14
7.4	Sequence of testing radiated spurious above 18 GHz	15
7.5	Sequence of testing Efficient use of spectrum	16
8	Measurement uncertainty	17
9	Summary of measurement results	18
10	Measurement results	19
10.1	10 dB - Bandwidth	19
10.2	TX Radiated Emissions	22
10.3	§15.519(a)(1) Efficient use of spectrum acc. to	50
10.4	Antenna requirements	51
Annex A	Glossary	52
Annex B	Document history	53
Annex C	Accreditation Certificate	53

2 General information

2.1 Notes and disclaimer

The test results of this test report relate exclusively to the test item specified in this test report. CTC advanced GmbH does not assume responsibility for any conclusions and generalizations drawn from the test results with regard to other specimens or samples of the type of the equipment represented by the test item.

The test report may only be reproduced or published in full. Reproduction or publication of extracts from the report requires the prior written approval of CTC advanced GmbH.

The testing service provided by CTC advanced GmbH has been rendered under the current "General Terms and Conditions for CTC advanced GmbH".

CTC advanced GmbH will not be liable for any loss or damage resulting from false, inaccurate, inappropriate or incomplete product information provided by the customer.

Under no circumstances does the CTC advanced GmbH test report include any endorsement or warranty regarding the functionality, quality or performance of any other product or service provided.

Under no circumstances does the CTC advanced GmbH test report include or imply any product or service warranties from CTC advanced GmbH, including, without limitation, any implied warranties of merchantability, fitness for purpose, or non-infringement, all of which are expressly disclaimed by CTC advanced GmbH.

All rights and remedies regarding vendor's products and services for which CTC advanced GmbH has prepared this test report shall be provided by the party offering such products or services and not by CTC advanced GmbH. In no case this test report can be considered as a Letter of Approval.

This test report is electronically signed and valid without handwritten signature. For verification of the electronic signatures, the public keys can be requested at the testing laboratory.

2.2 Application details

Date of receipt of order:	2020-10-02
Date of receipt of test item:	2020-02-10
Start of test:	2020-02-10
End of test:	2020-02-28
Person(s) present during the test:	Mr. Oliver Thieme

2.3 Test laboratories sub-contracted

None

3 Test standard/s and references

Test standard	Date	Description
47 CFR Part 15		Title 47 of the Code of Federal Regulations; Chapter I; Part 15 - Radio frequency devices

Guidance	Version	Description
ANSI C63.4-2014	-/-	American national standard for methods of measurement of radio-noise emissions from low-voltage electrical and electronic equipment in the range of 9 kHz to 40 GHz
ANSI C63.10-2013	-/-	American national standard of procedures for compliance testing of unlicensed wireless devices

4 Test environment

Temperature	:	T_{nom} T_{max} T_{min}	+25 °C during room temperature tests -/- °C during high temperature tests -/- °C during low temperature tests
Relative humidity content	:		47 %
Barometric pressure	:		1018 hpa
Power supply	:	V_{nom} V_{max} V_{min}	3.0 V DC by external power supply or battery 3.2 V 2.5 V

5 Test item

5.1 General description

Kind of test item	:	Passive Entry Car Key
Type identification	:	MS5
S/N serial number	:	Engineering sample
Hardware status	:	-/-
Software status	:	-/-
HVIN	:	MS5
PMN	:	MS5
Frequency band	:	6.520 GHz – 7.560 GHz
Type of radio transmission	:	Pulsed
Use of frequency spectrum	:	
Type of modulation	:	BFSK
Number of channels	:	3
Antenna	:	Integrated antenna
Power supply	:	2.5 V to 3.2 V DC by battery
Temperature range	:	-20°C to +65°C (for RF and UWB part)

5.2 Test modes

A special SW is used for continuous transmission or reception controlled by button press.

During transmitter tests, the EUT is set for continuous transmission (350 µs on, 650 µs off)

Channel	center frequency
A	6520 MHz
B	7040 MHz
C	7560 MHz

5.3 Additional information

The content of the following annexes is defined in the QA. It may be that not all of the listed annexes are necessary for this report, thus some values in between may be missing.

Test setup and EUT photos are included in test report:	1-9695/19-01-01_AnnexA
	1-9695/19-01-01_AnnexB
	1-9695/19-01-01_AnnexD

6 Description of the test setup

Typically, the calibrations of the test apparatus are commissioned to and performed by an accredited calibration laboratory. The calibration intervals are determined in accordance with the DIN EN ISO/IEC 17025. In addition to the external calibrations, the laboratory executes comparison measurements with other calibrated test systems or effective verifications. Weekly chamber inspections and range calibrations are performed. Where possible, RF generating and signaling equipment as well as measuring receivers and analyzers are connected to an external high-precision 10 MHz reference (GPS-based or rubidium frequency standard).

In order to simplify the identification of the equipment used at some special tests, some items of test equipment and ancillaries can be provided with an identifier or number in the equipment list below (Lab/Item).

Agenda: Kind of Calibration

k	calibration / calibrated	EK	limited calibration
ne	not required (k, ev, izw, zw not required)	zw	cyclical maintenance (external cyclical maintenance)
ev	periodic self verification	izw	internal cyclical maintenance
Ve	long-term stability recognized	g	blocked for accredited testing
vkl!	Attention: extended calibration interval		
NK!	Attention: not calibrated	*)	next calibration ordered / currently in progress

6.1 Shielded semi anechoic chamber

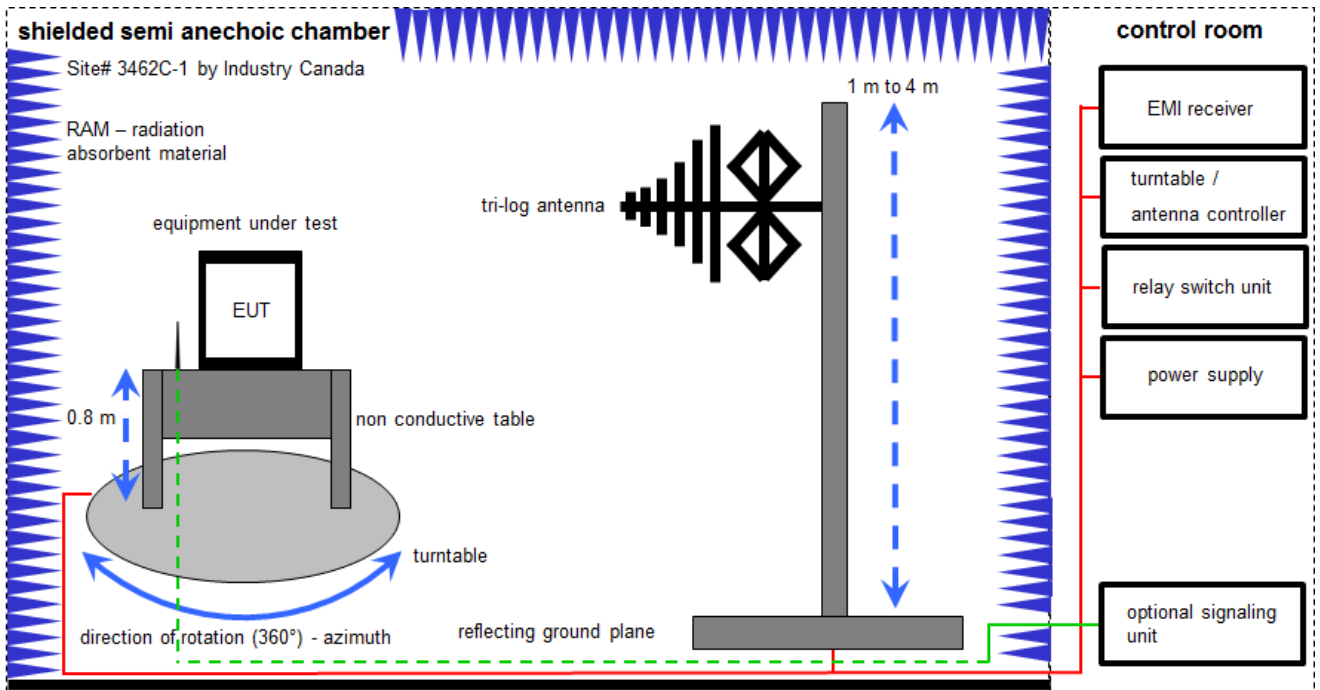

Measurement distance: tri-log antenna 10 meter

FS = UR + CL + AF

(FS-field strength; UR-voltage at the receiver; CL-loss of the cable; AF-antenna factor)

Example calculation:

FS [dBµV/m] = 12.35 [dBµV/m] + 1.90 [dB] + 16.80 [dB/m] = 31.05 [dBµV/m] (35.69 µV/m)

Equipment table:

No.	Lab / Item	Equipment	Type	Manufacturer	Serial No.	INV. No.	Kind of Calibration	Last Calibration	Next Calibration
1	45	Switch-Unit	3488A	HP	2719A14505	300000368	ev	-/-	-/-
2	50	DC power supply, 60Vdc, 50A, 1200 W	6032A	HP	2920A04466	300000580	ne	-/-	-/-
3	93	Meßkabine 1	HF-Absorberhalle	MWB AG 300023		300000551	ne	-/-	-/-
4	n. a.	EMI Test Receiver	ESCI 3	R&S	100083	300003312	k	10.12.2019	09.12.2020
6	n. a.	Antenna Tower	Model 2175	ETS-Lindgren	64762	300003745	izw	-/-	-/-
7	n. a.	Positioning Controller	Model 2090	ETS-Lindgren	64672	300003746	izw	-/-	-/-
8	n. a.	Turntable Interface-Box	Model 105637	ETS-Lindgren	44583	300003747	izw	-/-	-/-
9	n. a.	TRILOG Broadband Test-Antenna 30 MHz - 3 GHz	VULB9163	Schwarzbeck Mess - Elektronik	371	300003854	vKI!	14.01.2020	13.01.2023
10	n. a.	Spectrum-Analyzer	FSU26	R&S	200809	300003874	k	16.12.2019	15.12.2020

6.2 Shielded fully anechoic chamber

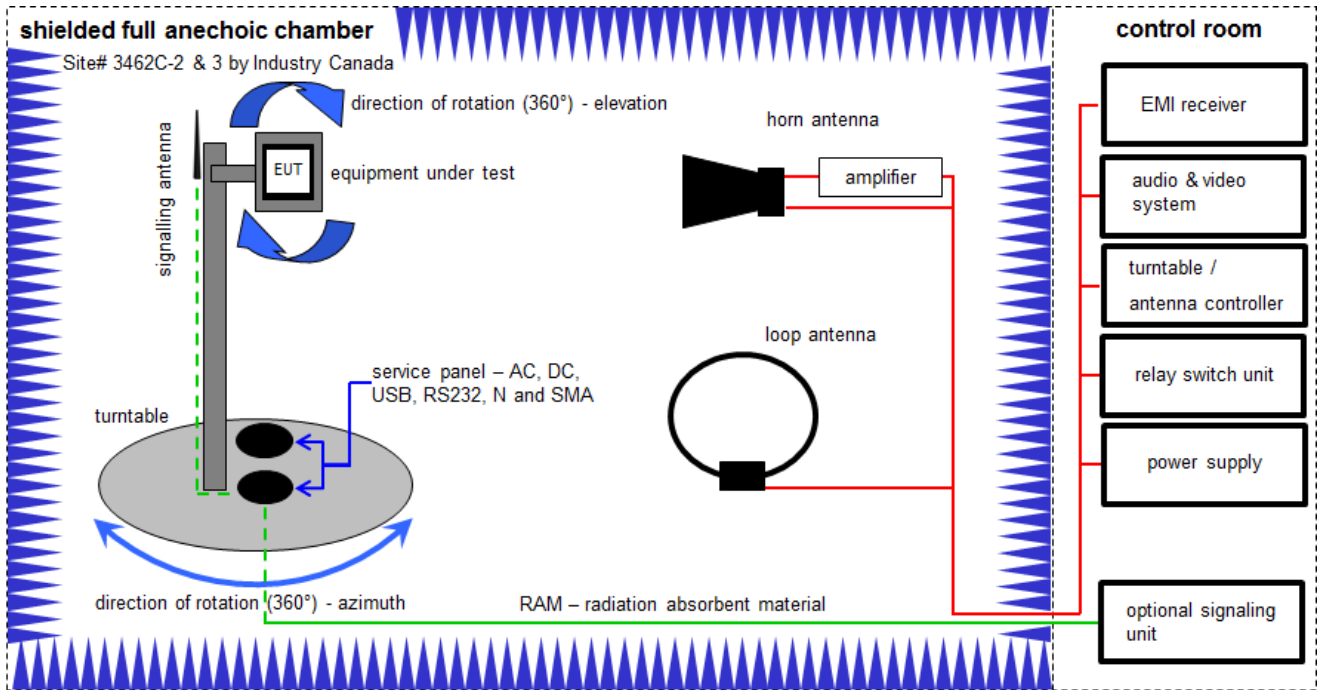

Measurement distance: horn antenna 3 meter; loop antenna 3 meter / 1 meter

$$FS = UR + CA + AF$$

(FS-field strength; UR-voltage at the receiver; CA-loss of the signal path; AF-antenna factor)

Example calculation:

$$FS \text{ [dB}\mu\text{V/m]} = 40.0 \text{ [dB}\mu\text{V/m]} + (-35.8) \text{ [dB]} + 32.9 \text{ [dB/m]} = 37.1 \text{ [dB}\mu\text{V/m]} \text{ (71.61 } \mu\text{V/m)}$$

$$OP = AV + D - G + CA$$

(OP-radiated output power; AV-analyzer value; D-free field attenuation of measurement distance; G-antenna gain+amplifier gain; CA-loss signal path)

Example calculation:

$$OP \text{ [dBm]} = -39.0 \text{ [dBm]} + 57.0 \text{ [dB]} - 12.0 \text{ [dBi]} + (-36.0) \text{ [dB]} = -30 \text{ [dBm]} \text{ (1 } \mu\text{W)}$$

Equipment table (Chamber C):

No.	Lab / Item	Equipment	Type	Manufacturer	Serial No.	INV. No.	Kind of Calibration	Last Calibration	Next Calibration
1	A,B,C	DC power supply, 60Vdc, 50A, 1200 W	6032A	HP	2818A03450	300001040	vKI!	12.12.2017	11.12.2020
2	A	Active Loop Antenna 9 kHz to 30 MHz	6502	EMCO	2210	300001015	vKI!	13.06.2019	12.06.2021
3	A,B,C	Anechoic chamber	FAC 3/5m	MWB / TDK	87400/02	300000996	ev	-/-	-/-
4	B	Double-Ridged Waveguide Horn Antenna 1-18.0GHz	3115	EMCO	9107-3697	300001605	vKI!	27.12.2019	26.02.2021
5	A,B,C	Switch / Control Unit	3488A	HP	*	300000199	ne	-/-	-/-
6	A,B,C	Variable isolating transformer	MPL IEC625 Bus Variable isolating transformer	Erfi	91350	300001155	ne	-/-	-/-
7	A,B,C	EMI Test Receiver 20Hz- 26,5GHz	ESU26	R&S	100037	300003555	k	11.12.2019	10.12.2020
8	B	Highpass Filter	WHKX7.0/18G-8SS	Wainwright	19	300003790	ne	-/-	-/-
9	B	Broadband Amplifier 0.5-18 GHz	CBLU5184540	CERNEX	22049	300004481	ev	-/-	-/-
10	B	Broadband Amplifier 5-13 GHz	CBLU5135235	CERNEX	22010	300004491	ev	-/-	-/-
11	A,B,C	4U RF Switch Platform	L4491A	Agilent Technologies	MY50000037	300004509	ne	-/-	-/-
12	A,B,C	NEXIO EMV-Software	BAT EMC V3.16.0.49	EMCO		300004682	ne	-/-	-/-
13	A,B,C	PC	ExOne	F+W		300004703	ne	-/-	-/-
14	B	RF-Amplifier	AMF-6F06001800-30-10P-R	NARDA-MITEQ Inc	2011572	300005241	ev	-/-	-/-
15	C	TRILOG Broadband Test-Antenna 30 MHz - 3 GHz	VULB9163	Schwarzbeck Mess - Elektronik	01029	300005379	vKI!	07.04.2017	06.04.2020

Equipment table (OTA):

No.	Lab / Item	Equipment	Type	Manufacturer	Serial No.	INV. No.	Kind of Calibration	Last Calibration	Next Calibration
1	A,B,C	Power supply GPIB dc power supply, 0-50 Vdc, 0-2 A	6633A	HP	2851A01222	300001530	vKI!	10.12.2019	09.12.2022
2	A,B,C	CTIA-Chamber	CTIA-Chamber AMS 8500	ETS-Lindgren Finland		300003327	ne	-/-	-/-
3	A,B,C	CTIA-Chamber - Positioning Equipment	CTIA-Chamber - Positioning Equipment	EMCO/2		300003328	ne	-/-	-/-
4	A,B,C	Signal- and Spectrum Analyzer	FSW26	R&S	101455	300005697	k	12.12.2019	11.12.2021
5	A,B,C	PC	Precision M4800	DELL	19414201934	300004957	-/-		
6	A,B,C	EMC Software Chamber A	EMC32-MEB	R&S	n.a.	300005477	-/-		
7	A,B,C	RF Amplifier	AMF-7D-01001800-22-10P	MITEQ	n.a.	n.a.	ev		
8	A	Std. Gain Horn Antenna 11.90-18.00 GHz	1824-20	Flann	263	300002471	ev	-/-	-/-
9	B	Double-Ridged Waveguide Horn Antenna 1-18.0GHz	3115	EMCO	9709-5290	300000212	ev	-/-	-/-
10	C	Breitband Doppelsteg-Hornantenne 0.5-6 GHz, 300 W	BBHA 9120 E	Schwarzbeck	212	300003214	vKI!	22.06.2018	21.06.2021

6.3 Radiated measurements > 18 GHz

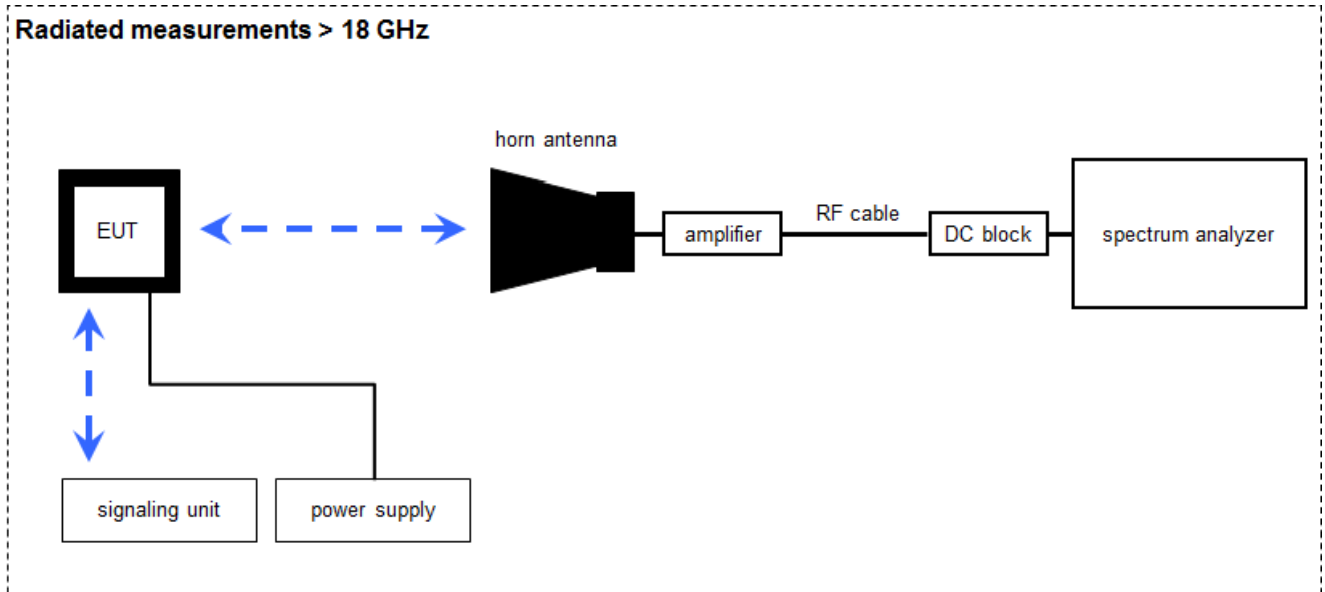

Measurement distance: horn antenna 50 cm

$$FS = UR + CA + AF$$

(FS-field strength; UR-voltage at the receiver; CA-loss signal path & distance correction; AF-antenna factor)

Example calculation:

$$FS [dB\mu V/m] = 40.0 [dB\mu V/m] + (-60.1) [dB] + 36.74 [dB/m] = 16.64 [dB\mu V/m] (6.79 \mu V/m)$$

$$OP = AV + D - G + CA$$

(OP-radiated output power; AV-analyzer value; D-free field attenuation of measurement distance; G-antenna gain+amplifier gain; CA-loss signal path)

Example calculation:

$$OP [dBm] = -59.0 [dBm] + 44.0 [dB] - 20.0 [dBi] + 5.0 [dB] = -30 [dBm] (1 \mu W)$$

Equipment table:

No.	Lab / Item	Equipment	Type	Manufacturer	Serial No.	INV. No CTC	Kind of Calibration	Last Calibration	Next Calibration
1	A	Std. Gain Horn Antenna 26.5-40.0 GHz	V637	Narda	7911	300001751	ev	-/-	-/-
2	A	Std. Gain Horn Antenna 18.0-26.5 GHz	638	Narda		300000487	ev	-/-	-/-
3	A	Spectrum Analyzer 20 Hz - 50 GHz	FSU50	R&S	200012	300003443	k	19.02.2019	18.02.2021
4	A	Broadband LNA 18-50 GHz	CBL18503070PN	CERNEX	25240	300004948	ev	-/-	-/-
6	A	Power Supply	LA30/5GA	Zentro	2046	300000711	NK!	-/-	-/-

6.4 Efficient use of spectrum



Equipment table:

No.	Lab / Item	Equipment	Type	Manufacturer	Serial No.	INV. No.	Kind of Calibration	Last Calibration	Next Calibration
1	A	Spectrum Analyzer 20 Hz - 50 GHz	FSU50	R&S	200012	300003443	ev	19.02.2019	18.02.2021
2	A	Double-Ridged Waveguide Horn Antenna 1-18.0GHz	3115	EMCO	9107-3697	300001605	vIKI!	27.02.2019	26.02.2021
3	A	Power Supply	LA30/5GA	Zentro	2046	300000711	NK!	-/-	-/-

7 Sequence of testing

7.1 Sequence of testing radiated spurious 9 kHz to 30 MHz

Setup

- The equipment is set up to simulate normal operation mode as described in the user manual or defined by the manufacturer.
- If the EUT is a tabletop system, it is placed on a table with 0.8 m height.
- If the EUT is a floor standing device, it is placed directly on the turn table.
- Auxiliary equipment and cables are positioned to simulate normal operation conditions as described in ANSI C 63.4.
- The AC power port of the EUT (if available) is connected to a power outlet below the turntable.
- Measurement distance is 3 m (see ANSI C 63.4) – see test details.
- EUT is set into operation.

Premeasurement*

- The turntable rotates from 0° to 315° using 45° steps.
- The antenna height is 1 m.
- At each turntable position the analyzer sweeps with positive-peak detector to find the maximum of all emissions.

Final measurement

- Identified emissions during the pre-measurement are maximized by the software by rotating the turntable from 0° to 360°.
- Loop antenna is rotated about its vertical axis for maximum response at each azimuth about the EUT. (For certain applications, the loop antenna plane may also need to be positioned horizontally at the specified distance from the EUT)
- The final measurement is done in the position (turntable and elevation) causing the highest emissions with quasi-peak (as described in ANSI C 63.4).
- Final levels, frequency, measuring time, bandwidth, turntable position, correction factor, margin to the limit and limit will be recorded. A plot with the graph of the premeasurement and the limit is stored.

*)Note: The sequence will be repeated three times with different EUT orientations.

7.2 Sequence of testing radiated spurious 30 MHz to 1 GHz

Setup

- The equipment is set up to simulate normal operation mode as described in the user manual or defined by the manufacturer.
- If the EUT is a tabletop system, a table with 0.8 m height is used, which is placed on the ground plane.
- If the EUT is a floor standing device, it is placed on the ground plane with insulation between both.
- Auxiliary equipment and cables are positioned to simulate normal operation conditions as described in ANSI C 63.4.
- The AC power port of the EUT (if available) is connected to a power outlet below the turntable.
- Measurement distance is 10 m or 3 m (see ANSI C 63.4) – see test details.
- EUT is set into operation.

Premeasurement

- The turntable rotates from 0° to 315° using 45° steps.
- The antenna is polarized vertical and horizontal.
- The antenna height changes from 1 m to 3 m.
- At each turntable position, antenna polarization and height the analyzer sweeps three times in peak to find the maximum of all emissions.

Final measurement

- The final measurement is performed for at least six highest peaks according to the requirements of the ANSI C63.4.
- Based on antenna and turntable positions at which the peak values are measured the software maximize the peaks by changing turntable position $\pm 45^\circ$ and antenna height between 1 and 4 m.
- The final measurement is done with quasi-peak detector (as described in ANSI C 63.4).
- Final levels, frequency, measuring time, bandwidth, antenna height, antenna polarization, turntable angle, correction factor, margin to the limit and limit are recorded. A plot with the graph of the premeasurement with marked maximum final results and the limit is stored.

7.3 Sequence of testing radiated spurious 1 GHz to 18 GHz

Setup

- The equipment is set up to simulate normal operation mode as described in the user manual or defined by the manufacturer.
- If the EUT is a tabletop system, a 2-axis positioner with 1.5 m height is used.
- If the EUT is a floor standing device, it is placed directly on the turn table.
- Auxiliary equipment and cables are positioned to simulate normal operation conditions as described in ANSI C 63.4.
- The AC power port of the EUT (if available) is connected to a power outlet below the turntable.
- Measurement distance is 3 m (see ANSI C 63.4) – see test details.
- EUT is set into operation.

Premeasurement

- The turntable rotates from 0° to 315° using 45° steps.
- The antenna is polarized vertical and horizontal.
- The antenna height is 1.5 m.
- At each turntable position and antenna polarization the analyzer sweeps with positive peak detector to find the maximum of all emissions.

Final measurement

- The final measurement is performed for at least six highest peaks according to the requirements of the ANSI C63.4.
- Based on antenna and turntable positions at which the peak values are measured the software maximizes the peaks by rotating the turntable from 0° to 360°. This measurement is repeated for different EUT-table positions (0° to 150° in 30°-steps) and for both antenna polarizations.
- The final measurement is done in the position (turntable, EUT-table and antenna polarization) causing the highest emissions with Peak and RMS detector (as described in ANSI C 63.4).
- Final levels, frequency, measuring time, bandwidth, turntable position, EUT-table position, antenna polarization, correction factor, margin to the limit and limit are recorded. A plot with the graph of the premeasurement with marked maximum final results and the limit is stored.

7.4 Sequence of testing radiated spurious above 18 GHz

Setup

- The equipment is set up to simulate normal operation mode as described in the user manual or defined by the manufacturer.
- Auxiliary equipment and cables are positioned to simulate normal operation conditions as described in ANSI C 63.4.
- The AC power port of the EUT (if available) is connected to a power outlet.
- The measurement distance is as appropriate (e.g. 0.5 m).
- The EUT is set into operation.

Premeasurement

- The test antenna is handheld and moved carefully over the EUT to cover the EUT's whole sphere and different polarizations of the antenna.

Final measurement

- The final measurement is performed at the position and antenna orientation causing the highest emissions with Peak and RMS detector (as described in ANSI C 63.4).
- Final levels, frequency, measuring time, bandwidth, correction factor, margin to the limit and limit are recorded. A plot with the graph of the premeasurement and the limit is stored.

7.5 Sequence of testing Efficient use of spectrum

Setup

- The equipment is set up to simulate normal operation mode as described in the user manual or defined by the manufacturer.
- The EUT positioned at a distance of approx. 0.5m to the horn antenna used for the measurement.
- The associated receiver is positioned between the EUT the horn antenna to assure that the received signal level of the associated receiver at the spectrum analyzer is higher than the level of the EUT.

Measurement:

- Switch on EUT and associated receiver and wait until the connection is established.
- Start Analyzer sweep in Zerospan with a sweep time of 15 s.
- Switch of the associated receiver.
- When switching of the associated receiver, a drop in the received signal level at the spectrum analyzer can be observed. → position marker 1
- Position marker two at the point where the transmission of the EUT stops.
- Measure time difference between marker 1 and marker 2.

8 Measurement uncertainty

Test case	Uncertainty
Equivalent isotropically radiated power (e.i.r.p.)	Conducted value ± 1 dB Radiated value ± 3 dB
Permitted range of operating frequencies	± 100 kHz
Conducted unwanted emissions in the spurious domain (up to 40 GHz)	± 1 dB
Radiated unwanted emissions in the spurious domain (up to 40 GHz)	± 3 dB
Conducted unwanted emissions in the spurious domain (40 to 50 GHz)	± 4 dB
Radiated unwanted emissions in the spurious domain (40 to 50 GHz)	± 4 dB
Conducted unwanted emissions in the spurious domain (50 to 300 GHz)	± 5 dB
Radiated unwanted emissions in the spurious domain (50 to 300 GHz)	± 5 dB
DC and low frequency voltages	± 3 %
Temperature	± 1 °C
Humidity	± 3 %

9 Summary of measurement results

TC Identifier	Description	Verdict	Date	Remark
RF-Testing	CFR47 §15.209, §15.519, §15.521	see table	2020-03-25	-/-

<input checked="" type="checkbox"/>	No deviations from the technical specifications were ascertained
<input type="checkbox"/>	There were deviations from the technical specifications ascertained
<input type="checkbox"/>	This test report is only a partial test report. The content and verdict of the performed test cases are listed below.

Test specification clause	Test case	Temperature conditions	Power source	Pass	Fail	NA	NP	Remark
§15.503	10 dB Bandwidth	Nominal	Nominal	<input checked="" type="checkbox"/>	<input type="checkbox"/>	<input type="checkbox"/>	<input type="checkbox"/>	complies
§15.519 §15.209 (c)(d)(e)	TX Radiated Emissions	Nominal	Nominal	<input checked="" type="checkbox"/>	<input type="checkbox"/>	<input type="checkbox"/>	<input type="checkbox"/>	complies
§15.519 (a) (1)	Efficient use of spectrum	Nominal	Nominal	<input checked="" type="checkbox"/>	<input type="checkbox"/>	<input type="checkbox"/>	<input type="checkbox"/>	complies
§15.521 (b) §§15.203 & 15.204	Antenna requirement	-/-	-/-	<input checked="" type="checkbox"/>	<input type="checkbox"/>	<input type="checkbox"/>	<input type="checkbox"/>	complies

Note: NA = Not Applicable; NP = Not Performed

10 Measurement results

10.1 10 dB - Bandwidth

Description:

(a) *UWB bandwidth*. For the purpose of this subpart, the UWB bandwidth is the frequency band bounded by the points that are 10 dB below the highest radiated emission, as based on the complete transmission system including the antenna. The upper boundary is designated f_H and the lower boundary is designated f_L . The frequency at which the highest radiated emission occurs is designated f_M .

Measurement:

Measurement parameter	
Detector:	RMS
Video bandwidth:	1 MHz
Resolution bandwidth:	3 MHz
Trace-Mode:	Max Hold

Test Setup: 6.2

Limits:

>500 MHz

Results:

Channel	Lower -10 dB point [MHz]	Higher -10 dB point [MHz]	UWB bandwidth [MHz]	Plot
A	6226.015	6842.715	616.72	1
B	6747.861	7348.561	600.66	2
C	7246.286	7904.886	658.69	3

Verdict: Compliant

Plot 1:

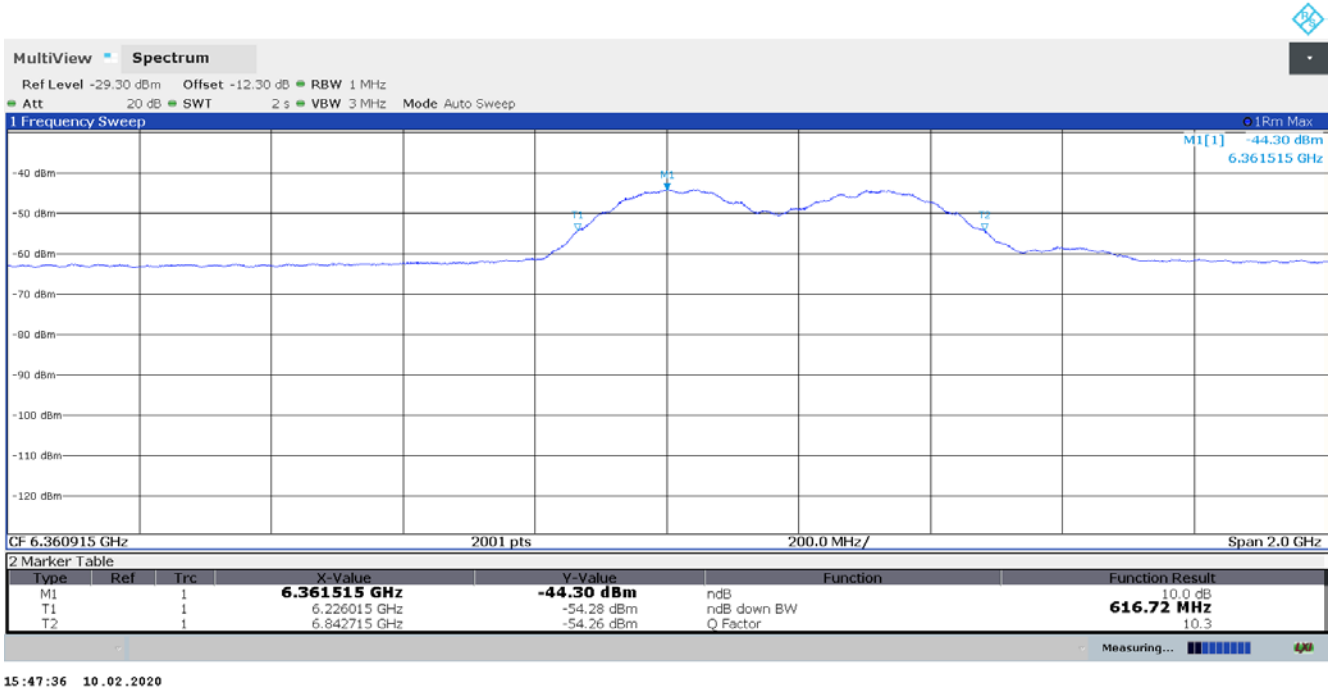

Plot 2:

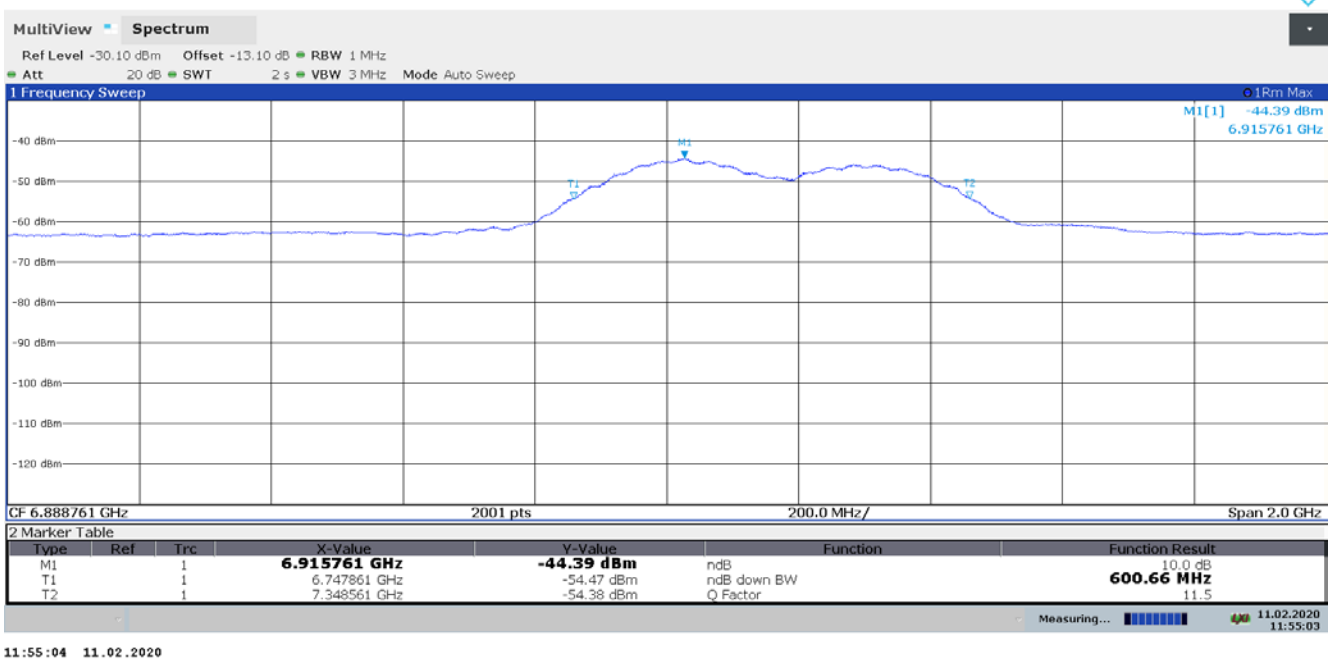

Plot 3:

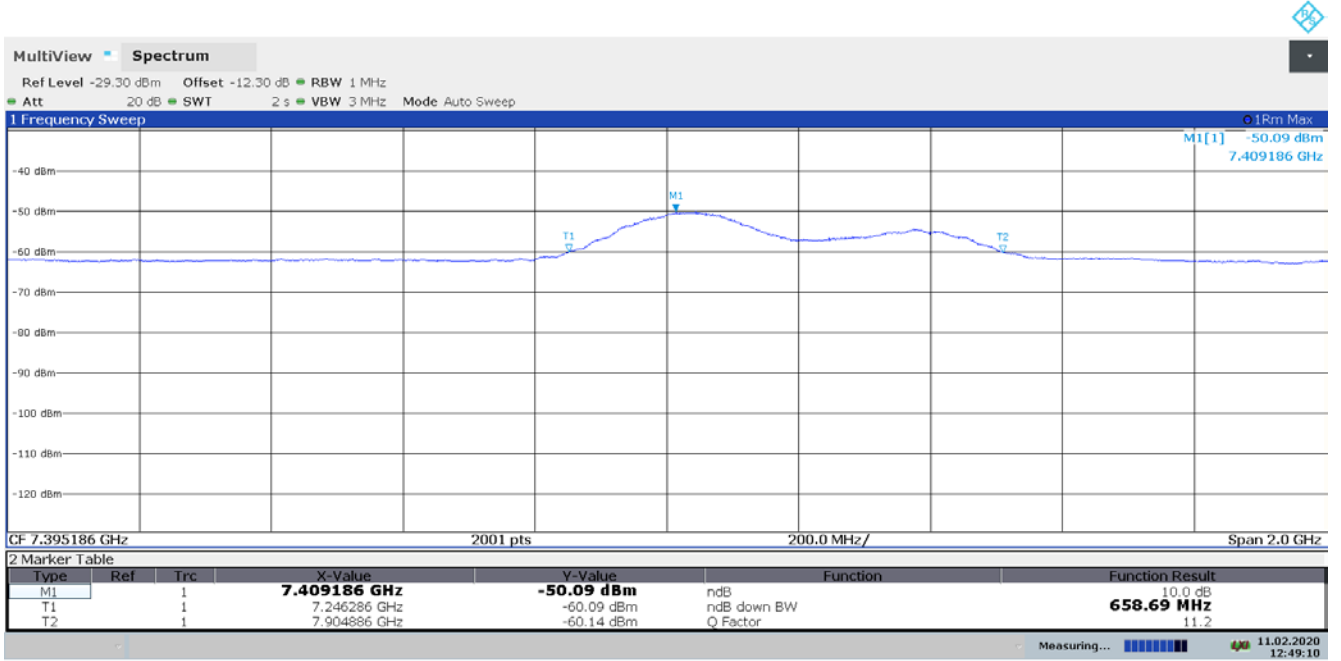

12:49:10 11.02.2020

10.2 TX Radiated Emissions

Description:

Measurement of the radiated spurious emissions in transmit mode.

Measurement:

§15.209:

Average Measurement parameter	
Detector:	Peak/QPeak
Sweep time:	1 s
Number of points	8001
Resolution bandwidth:	120kHz
Video bandwidth:	≥ RBW
Trace-Mode:	Max Hold

§15.519 (c):

Average Measurement parameter	
Detector:	RMS
Sweep time:	1 ms/pt
Resolution bandwidth:	1 MHz
Video bandwidth:	3 MHz
Trace-Mode:	Max Hold

§15.519 (d):

Average Measurement parameter	
Detector:	RMS
Sweep time:	1 ms/pt
Resolution bandwidth:	1 kHz
Video bandwidth:	3 kHz
Trace-Mode:	Max Hold

§15.519 (e):

Peak Measurement parameter	
Detector:	Max Peak
Resolution bandwidth:	50 MHz
Video bandwidth:	80 MHz
Span:	Zero span
Trace-Mode:	Max Hold

UWB-emission-Limits:**§15.519 (c):**

The radiated emissions above 960 MHz from a device operating under the provisions of this section shall not exceed the following RMS average limits based on measurements using a 1 MHz resolution bandwidth:

Frequency in MHz	EIRP in dBm
960 to 1610	-75.3
1610 to 1990	-63.3
1990 to 3100	-61.3
3100 to 10600	-41.3
Above 10600	-61.3

§15.519 (d):

In addition to the radiated emission limits specified in the table in paragraph (d)(1) of this section, transmitters operating under the provisions of this section shall not exceed the following RMS average limits when measured using a resolution bandwidth of no less than 1 kHz:

Frequency in MHz	EIRP in dBm
1164 to 1240	-85.3
1559 to 1610	-85.3

(e) There is a limit on the peak level of the emissions contained within a 50 MHz bandwidth centered on the frequency at which the highest radiated emission occurs, f_m . That limit is 0 dBm EIRP. It is acceptable to employ a different resolution bandwidth, and a correspondingly different peak emission limit, following the procedures described in §15.521.

§15.521 (c)

Emissions from digital circuitry used to enable the operation of the UWB transmitter shall comply with the limits in §15.209, rather than the limits specified in this subpart, provided it can be clearly demonstrated that those emissions from the UWB device are due solely to emissions from digital circuitry contained within the transmitter and that the emissions are not intended to be radiated from the transmitter's antenna. Emissions from associated digital devices, as defined in §15.3(k), e.g., emissions from digital circuitry used to control additional functions or capabilities other than the UWB transmission, are subject to the limits contained in Subpart B of this part.

§15.521(e)

The frequency at which the highest radiated emission occurs, f_m , must be contained within the UWB bandwidth.

§15.521(g)

When a peak measurement is required, it is acceptable to use a resolution bandwidth other than the 50 MHz specified in this subpart. This resolution bandwidth shall not be lower than 1 MHz or greater than 50 MHz, and the measurement shall be centered on the frequency at which the highest radiated emission occurs, f_m . If a resolution bandwidth other than 50 MHz is employed, the peak EIRP limit shall be 20 log (RBW/50) dBm where RBW is the resolution bandwidth in megahertz that is employed. This may be converted to a peak field strength level at 3 meters using $E(\text{dBuV/m}) = P(\text{dBm EIRP}) + 95.2$. If RBW is greater than 3 MHz, the application for certification filed with the Commission must contain a detailed description of the test procedure, calibration of the test setup, and the instrumentation employed in the testing.

§15.521(h):

The highest frequency employed in §15.33 to determine the frequency range over which radiated measurements are made shall be based on the center frequency, f_c , unless a higher frequency is generated within the UWB device. For measuring emission levels, the spectrum shall be investigated from the lowest frequency generated in the UWB transmitter, without going below 9 kHz, up to the frequency range shown in §15.33(a) or up to $f_c + 3/(\text{pulse width in seconds})$, whichever is higher. There is no requirement to measure emissions beyond 40 GHz provided f_c is less than 10 GHz; beyond 100 GHz if f_c is at or above 10 GHz and below 30 GHz; or beyond 200 GHz if f_c is at or above 30 GHz.

§15.521 (d)

Within the tables in §§15.509, 15.511, 15.513, 15.515, 15.517, and 15.519, the tighter emission limit applies at the band edges. Radiated emission levels at and below 960 MHz are based on measurements employing a CISPR quasi-peak detector. Radiated emission levels above 960 MHz are based on RMS average measurements over a 1 MHz resolution bandwidth. The RMS average measurement is based on the use of a spectrum analyzer with a resolution bandwidth of 1 MHz, an RMS detector, and a 1 millisecond or less averaging time. Unless otherwise stated, if pulse gating is employed where the transmitter is quiescent for intervals that are long compared to the nominal pulse repetition interval, measurements shall be made with the pulse train gated on. Alternative measurement procedures may be considered by the Commission.

Emission limits below 960 MHz (§15.209):

Frequency (MHz)	Field strength ($\mu\text{V}/\text{m}$)	Measurement distance (m)
0.009 – 0.490	2400/F(kHz)	300
0.490 – 1.705	24000/F(kHz)	30
1.705 – 30	30 (29.5 dB $\mu\text{V}/\text{m}$)	30
30 – 88	100 (40 dB $\mu\text{V}/\text{m}$)	3
88 – 216	150 (43.5 dB $\mu\text{V}/\text{m}$)	3
216 – 960	200 (46 dB $\mu\text{V}/\text{m}$)	3
> 960	500 (54 dB $\mu\text{V}/\text{m}$)	3

Result:**Measurements of the fundamental emission:**

Channel	Frequency /MHz	Max RMS power in dBm/MHz	Max Peak power in dBm/50 MHz	Plot
A	6360.915	-44.30	-2.91	1, 4
B	6888.761	-41.89	-3.30	2, 5
C	7395.186	-45.98	-4.07	3, 6

Verdict FCC §15: complies

Plot 4: Channel A, Peak fundamental emission

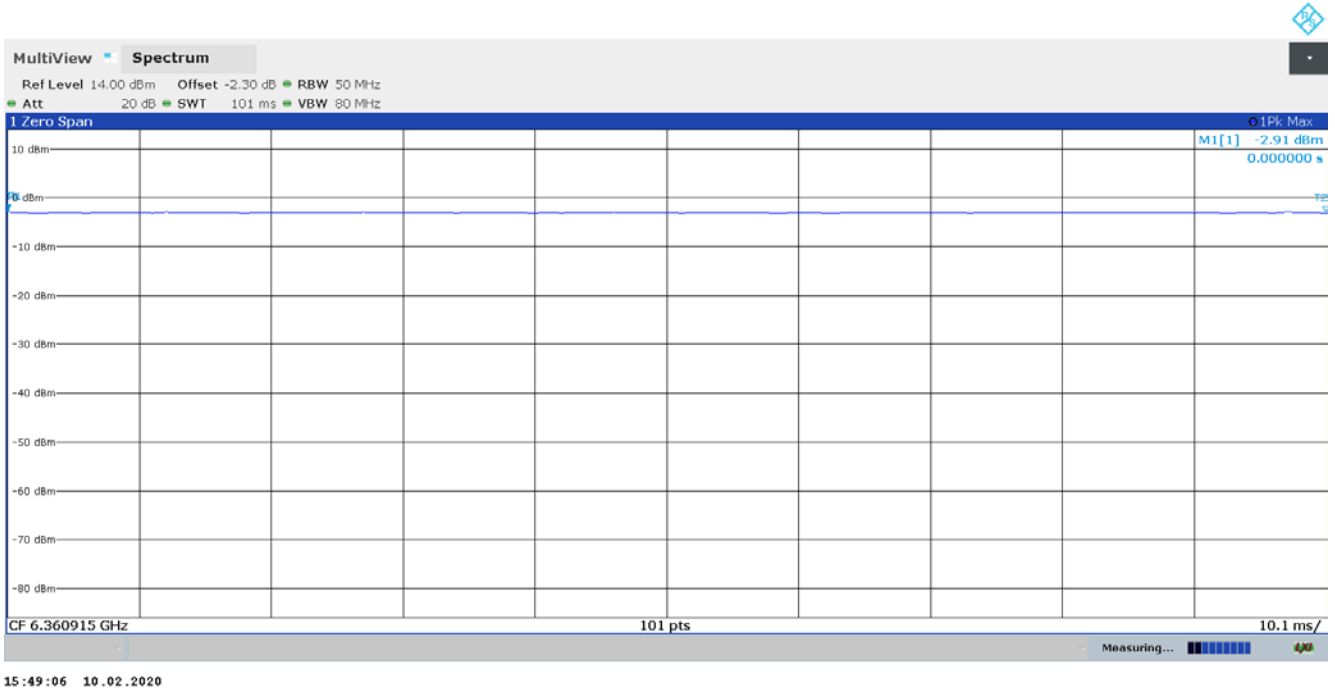

Plot 5: Channel B, Peak fundamental emission

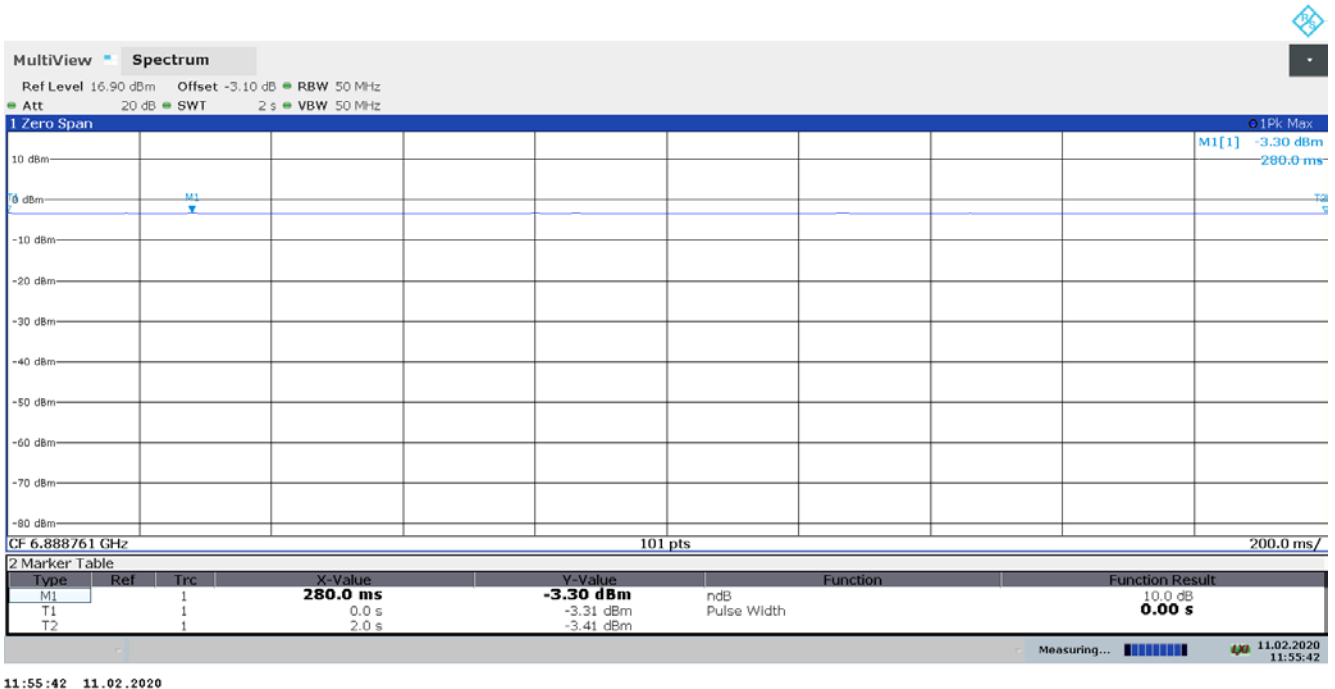

Plot 6: Channel C, Peak fundamental emission

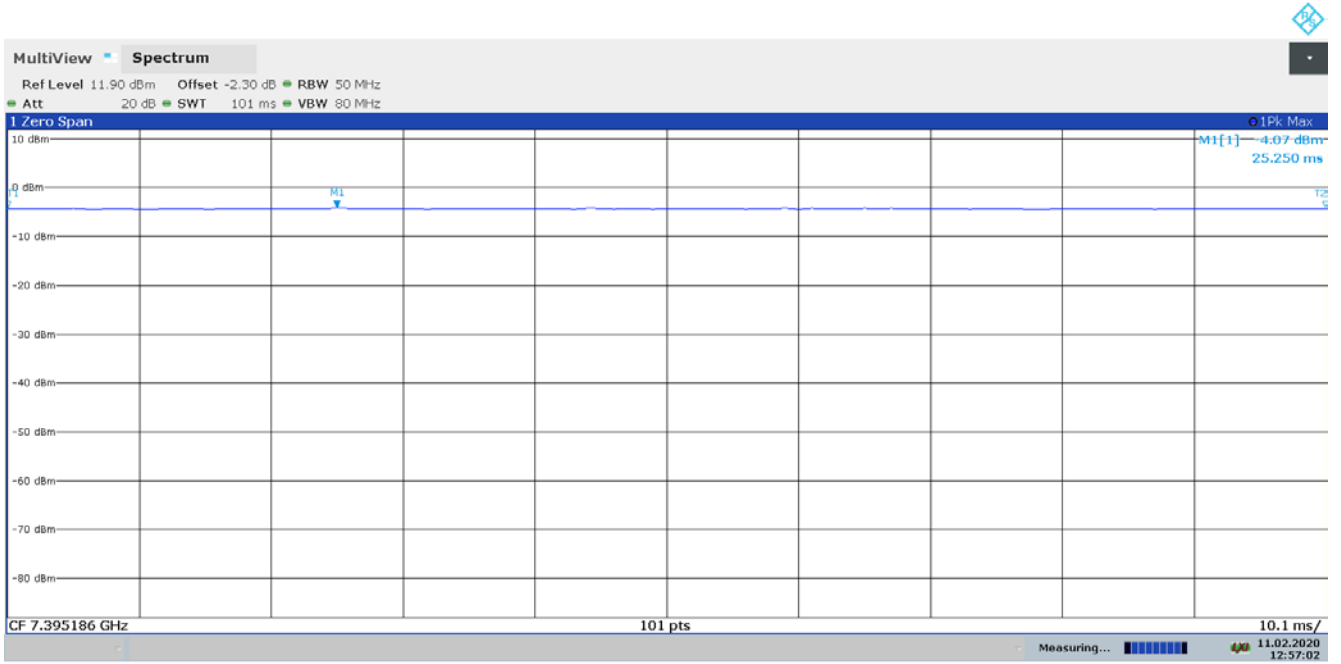

12:57:02 11.02.2020

Plot 7: Channel A, 9 kHz to 30 MHz

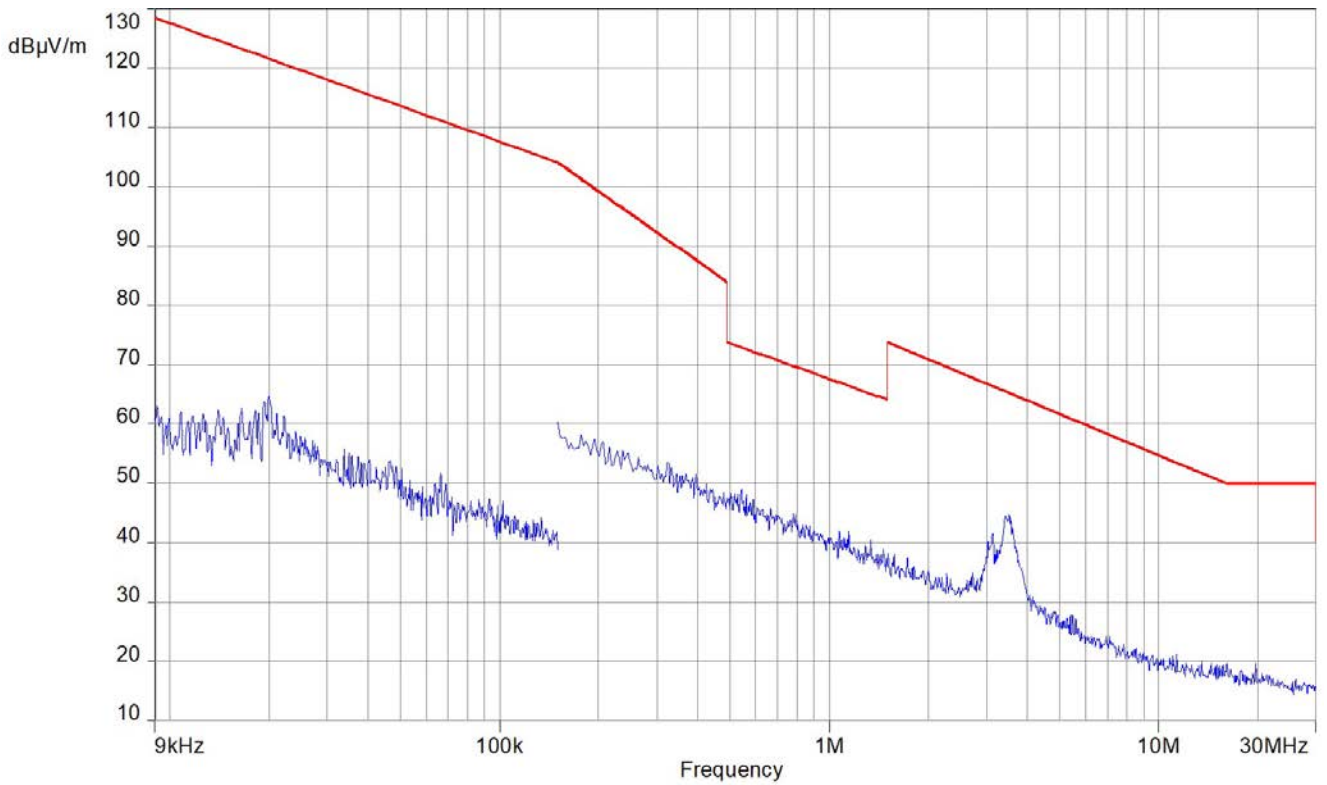

Plot 8: Channel B, 9 kHz to 30 MHz

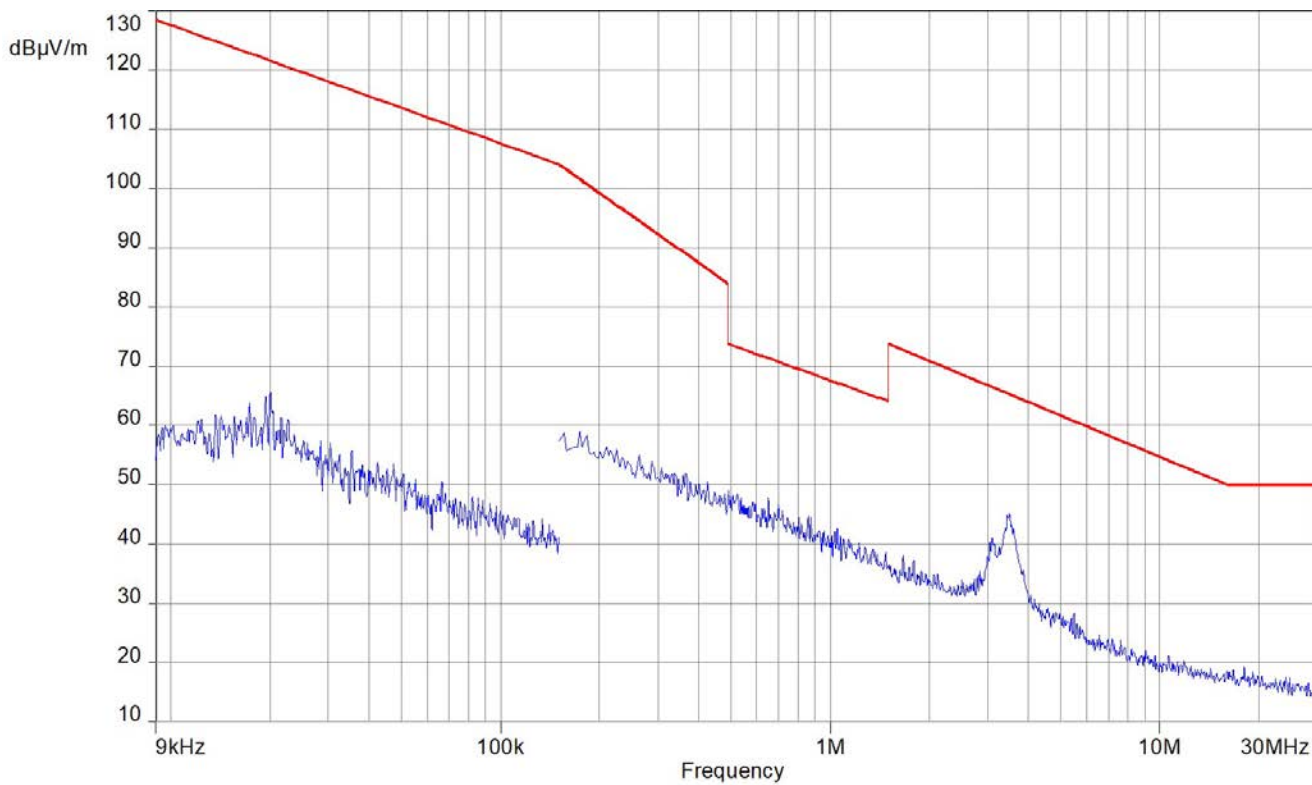

Plot 9: Channel C, 9 kHz to 30 MHz

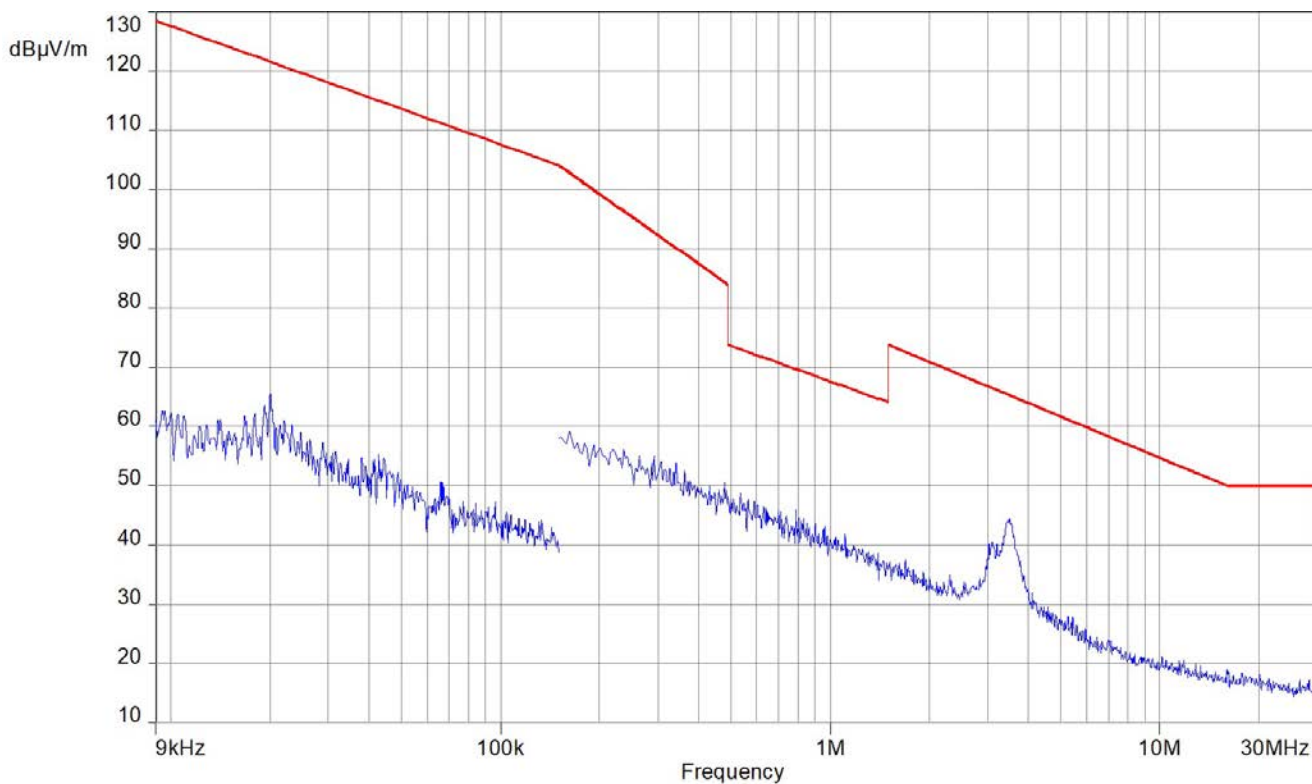

Plot 10: Channel A, 30 MHz to 1 GHz

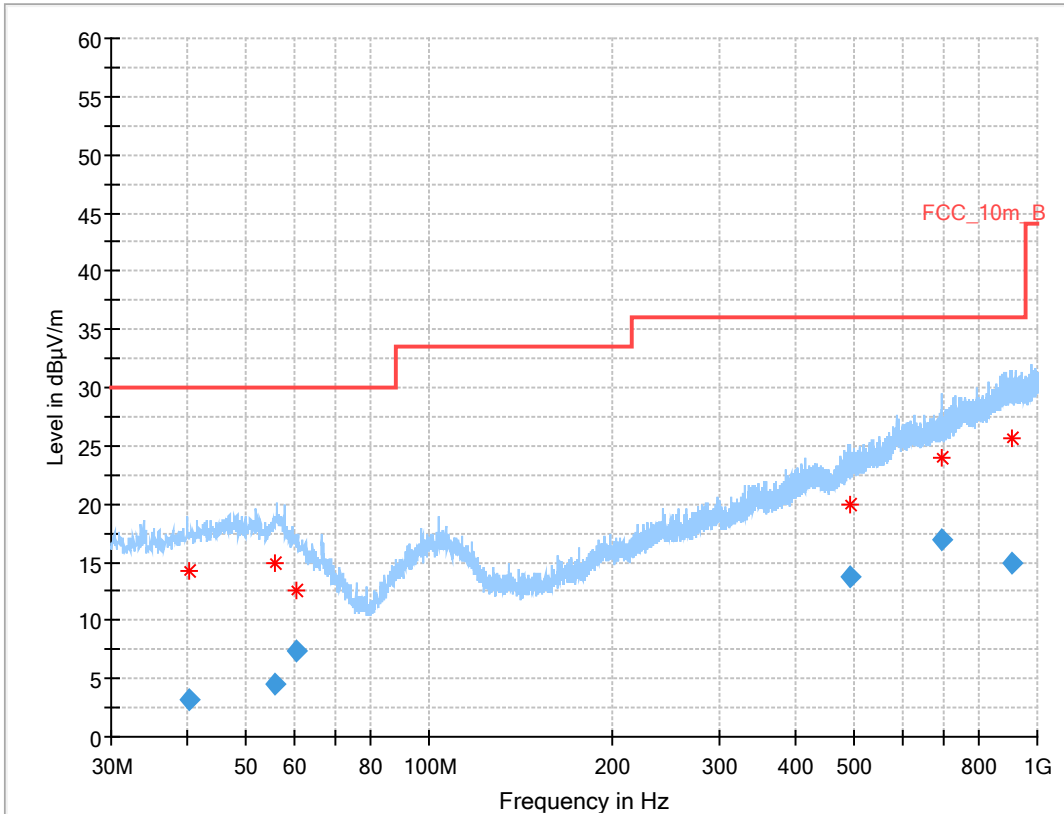

Final Result

Frequency (MHz)	QuasiPeak (dBµV/m)	Limit (dBµV/m)	Margin (dB)	Meas. Time (ms)	Bandwidth (kHz)	Height (cm)	Pol	Azimuth (deg)	Corr. (dB/m)
40.238	3.21	30.0	26.8	1000	120	160.0	H	29	13
55.891	4.60	30.0	25.4	1000	120	160.0	H	121	15
60.621	7.43	30.0	22.6	1000	120	160.0	V	244	13
492.563	13.73	36.0	22.3	1000	120	160.0	V	49	18
694.773	16.93	36.0	19.1	1000	120	154.0	H	55	21
905.310	14.93	36.0	21.1	1000	120	116.0	H	279	24

Plot 11: Channel B, 30 MHz to 1 GHz

Full Spectrum

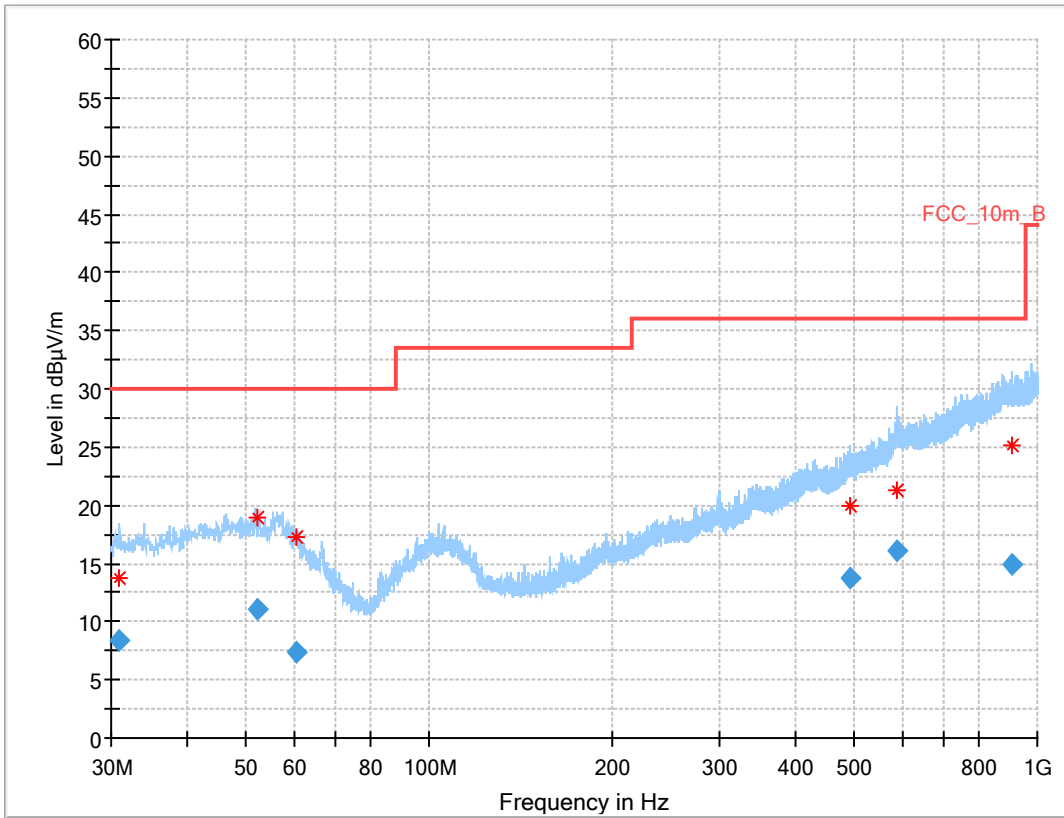

Final Result

Frequency (MHz)	QuasiPeak (dBµV/m)	Limit (dBµV/m)	Margin (dB)	Meas. Time (ms)	Bandwidth (kHz)	Height (cm)	Pol	Azimuth (deg)	Corr. (dB/m)
30.935	8.30	30.0	21.7	1000	120	109.0	V	29	12
52.030	11.06	30.0	18.9	1000	120	102.0	V	23	14
60.586	7.38	30.0	22.6	1000	120	106.0	H	312	13
493.802	13.81	36.0	22.2	1000	120	160.0	V	248	18
587.501	16.17	36.0	19.8	1000	120	160.0	H	291	20
911.306	14.98	36.0	21.0	1000	120	160.0	V	237	24

Plot 12: Channel C, 30 MHz to 1 GHz

Full Spectrum

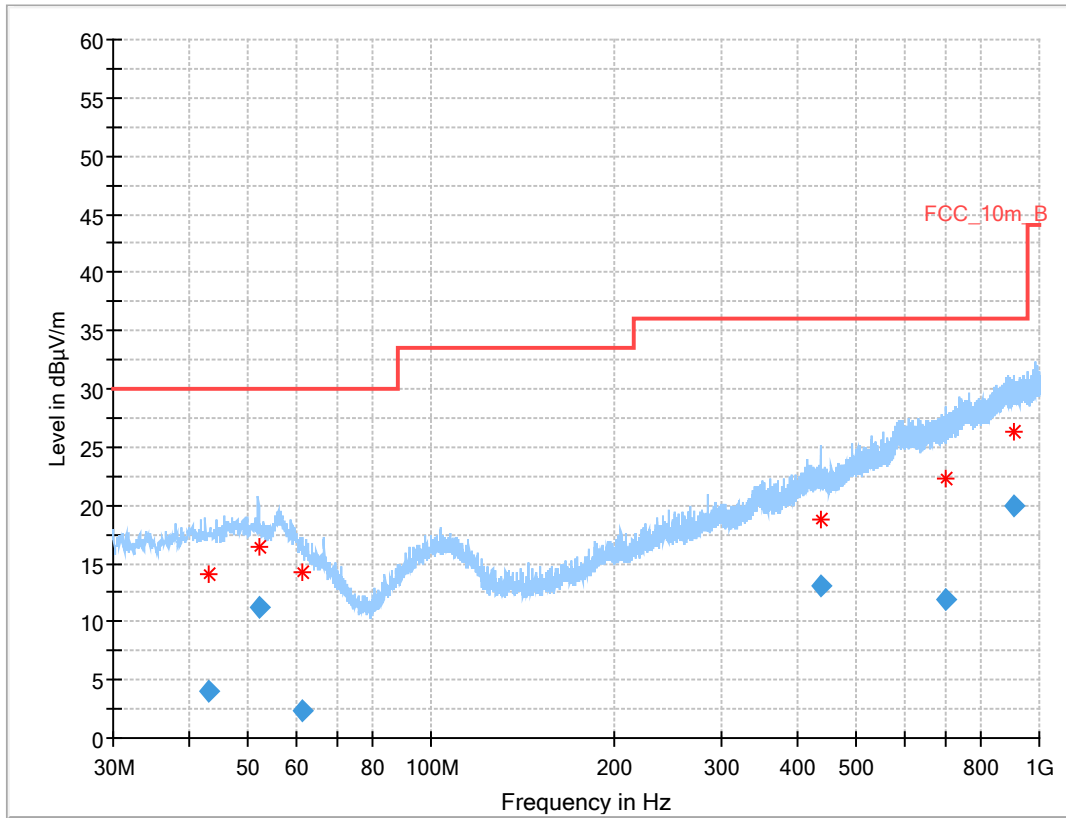

Final Result

Frequency (MHz)	QuasiPeak (dBµV/m)	Limit (dBµV/m)	Margin (dB)	Meas. Time (ms)	Bandwidth (kHz)	Height (cm)	Pol	Azimuth (deg)	Corr. (dB/m)
43.011	3.97	30.0	26.0	1000	120	155.0	H	125	14
52.015	11.21	30.0	18.8	1000	120	112.0	V	0	14
61.426	2.32	30.0	27.7	1000	120	160.0	H	326	12
435.924	13.01	36.0	23.0	1000	120	160.0	V	78	17
701.729	11.97	36.0	24.0	1000	120	160.0	H	355	21
905.971	20.00	36.0	16.0	1000	120	160.0	V	159	24

Plot 13: Channel A, 960 MHz to 4.75 GHz

Full Spectrum

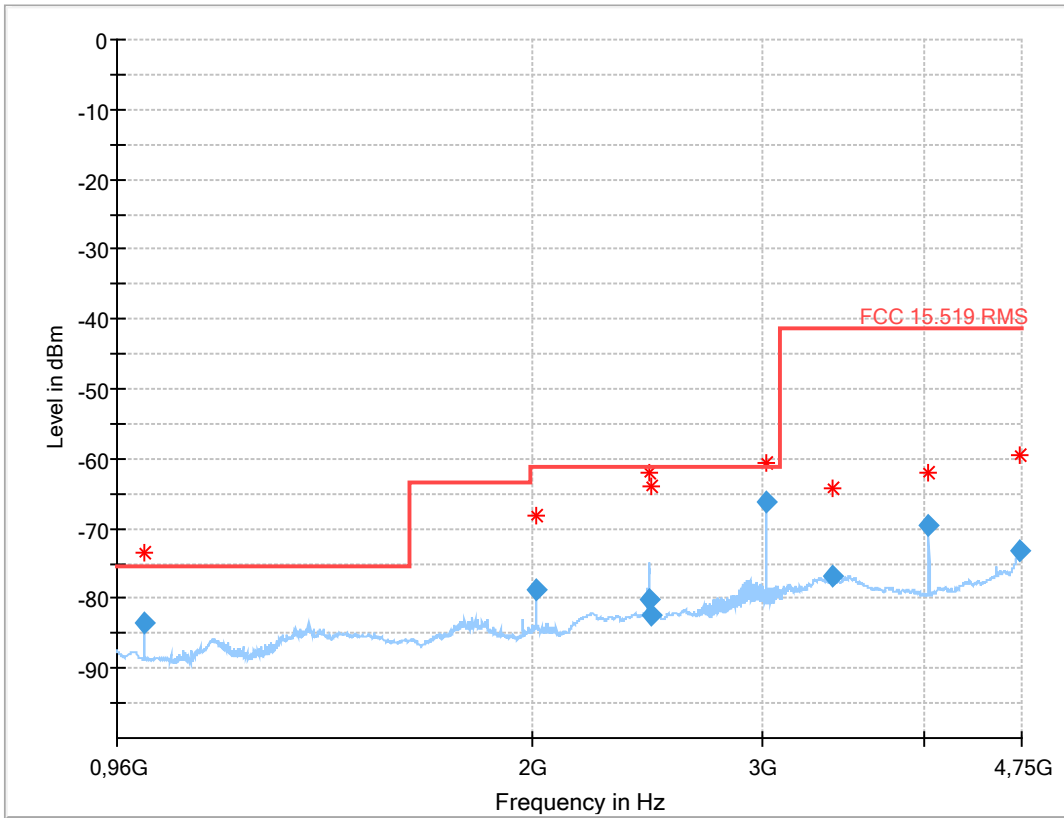

Final_Result

Frequency (MHz)	RMS (dBm)	Limit (dBm)	Margin (dB)	Bandwidth (kHz)	Pol	Azimuth (deg)	Elevation (deg)	Corr. (dB)
1007.990000	-83.41	-75.30	8.11	1000.000	V	17.0	16.0	-145.0
2016.040000	-78.88	-61.30	17.58	1000.000	V	140.0	25.0	-140.7
2458.858000	-80.23	-61.30	18.93	1000.000	H	165.0	106.0	-138.4
2465.188000	-82.36	-61.30	21.06	1000.000	H	154.0	133.0	-138.4
3024.050000	-66.15	-61.30	4.85	1000.000	H	172.0	93.0	-136.5
3402.150000	-76.88	-41.30	35.58	1000.000	V	147.0	67.0	-133.5
4031.996000	-69.67	-41.30	28.37	1000.000	H	197.0	42.0	-134.8
4738.732000	-73.18	-41.30	31.88	1000.000	V	27.0	43.0	-128.9

Plot 14: Channel B, 960 MHz to 4.75 GHz

Full Spectrum

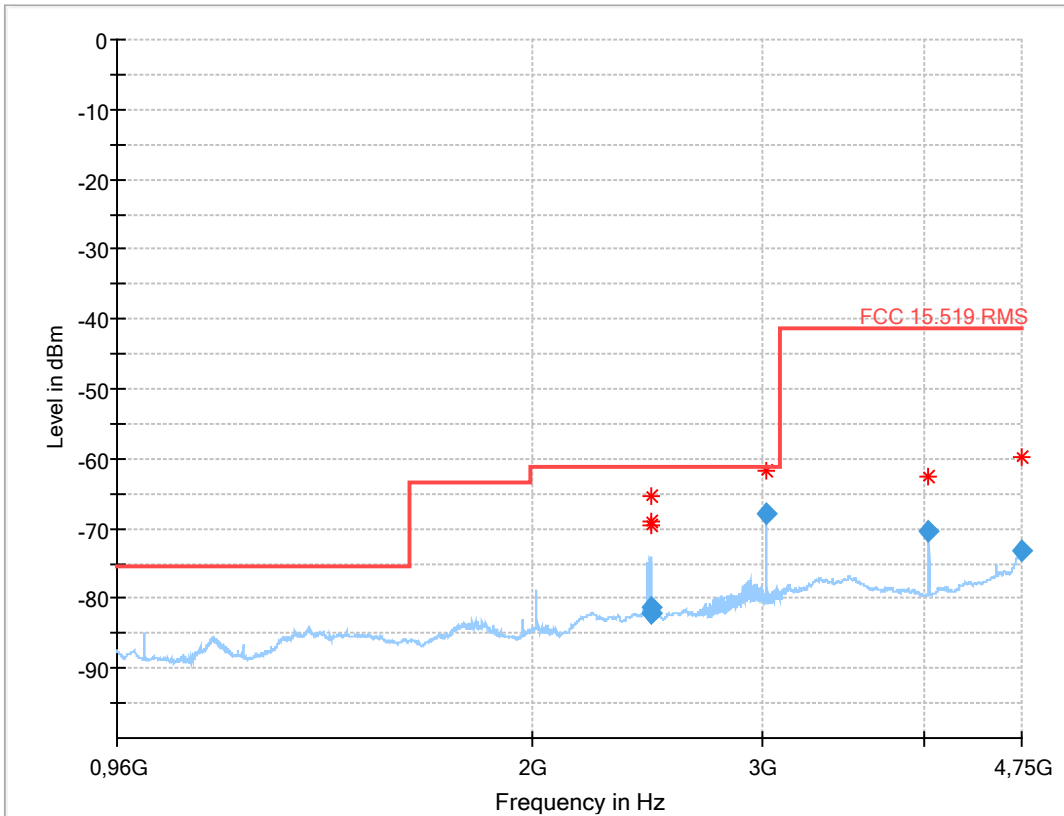

Final_Result

Frequency (MHz)	RMS (dBm)	Limit (dBm)	Margin (dB)	Bandwidth (kHz)	Pol	Azimuth (deg)	Elevation (deg)	Corr. (dB)
2463.910000	-81.29	-61.30	19.99	1000.000	V	26.0	17.0	-138.4
2467.232000	-82.24	-61.30	20.94	1000.000	V	28.0	7.0	-138.3
2467.412000	-82.26	-61.30	20.96	1000.000	V	33.0	17.0	-138.3
3024.020000	-67.90	-61.30	6.60	1000.000	H	177.0	75.0	-136.5
4032.052000	-70.45	-41.30	29.15	1000.000	H	194.0	54.0	-134.8
4742.594000	-73.10	-41.30	31.80	1000.000	H	187.0	17.0	-128.8

Plot 15: Channel C, 960 MHz to 4.75 GHz

Full Spectrum

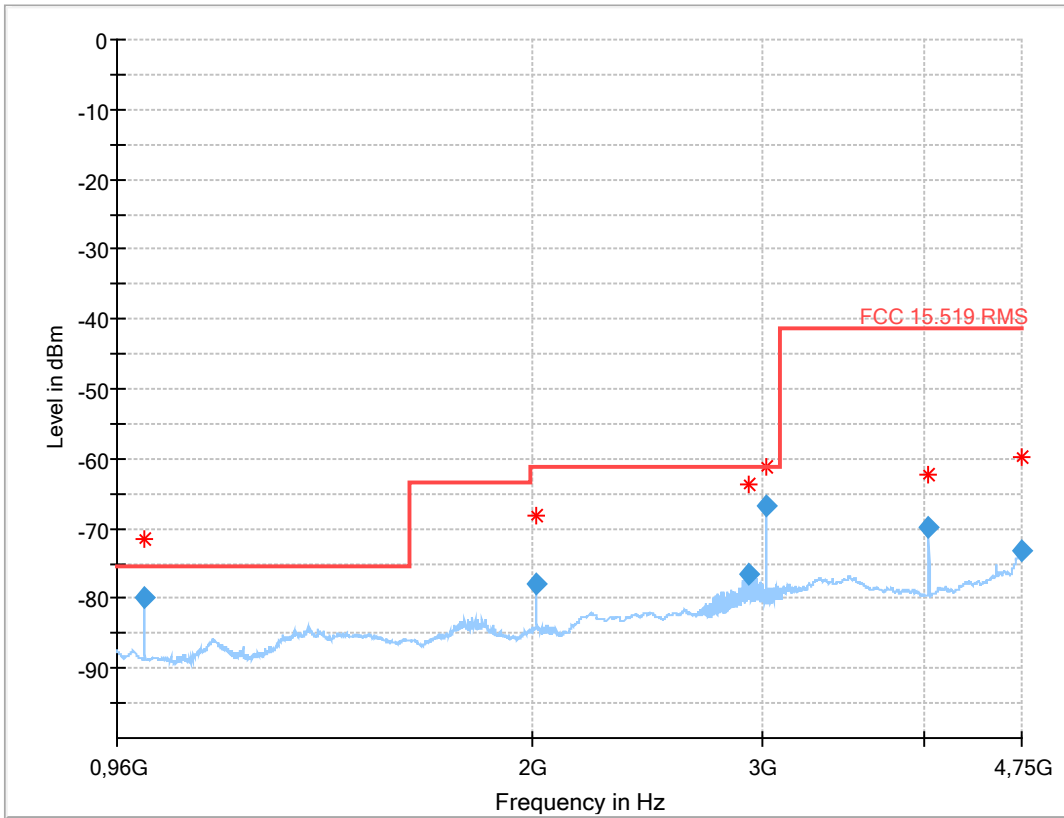

Final_Result

Frequency (MHz)	RMS (dBm)	Limit (dBm)	Margin (dB)	Bandwidth (kHz)	Pol	Azimuth (deg)	Elevation (deg)	Corr. (dB)
1008.012000	-79.81	-75.30	4.51	1000.000	V	22.0	16.0	-145.0
2015.964000	-77.94	-61.30	16.64	1000.000	H	132.0	120.0	-140.7
2929.564000	-76.58	-61.30	15.28	1000.000	V	74.0	2.0	-135.9
3023.946000	-66.63	-61.30	5.33	1000.000	H	175.0	95.0	-136.5
4032.074000	-69.86	-41.30	28.56	1000.000	H	198.0	53.0	-134.8
4742.268000	-73.10	-41.30	31.80	1000.000	V	297.0	151.0	-128.8

Plot 16: Channel A, 4.75 GHz to 10.5 GHz

Full Spectrum

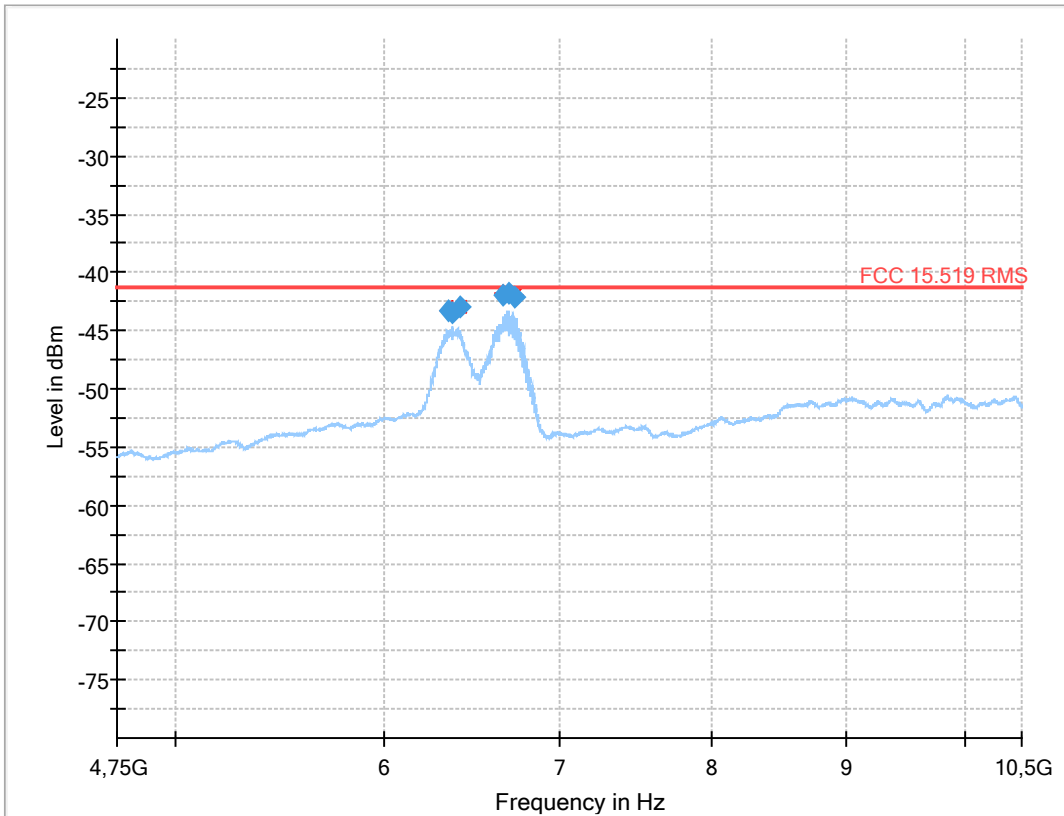

Final_Result

Frequency (MHz)	RMS (dBm)	Limit (dBm)	Margin (dB)	Bandwidth (kHz)	Pol	Azimuth (deg)	Elevation (deg)	Corr. (dB)
6346.866714	-43.33	-41.30	2.03	1000.000	H	69.0	119.0	-109.2
6377.511429	-43.41	-41.30	2.11	1000.000	H	69.0	117.0	-109.5
6412.669857	-42.96	-41.30	1.66	1000.000	H	42.0	120.0	-109.8
6662.730143	-42.02	-41.30	0.72	1000.000	H	49.0	119.0	-109.9
6695.455714	-41.84	-41.30	0.54	1000.000	H	48.0	121.0	-110.0
6726.626143	-42.07	-41.30	0.77	1000.000	H	50.0	122.0	-109.9

Plot 17: Channel B, 4.75 GHz to 10.5 GHz

Full Spectrum

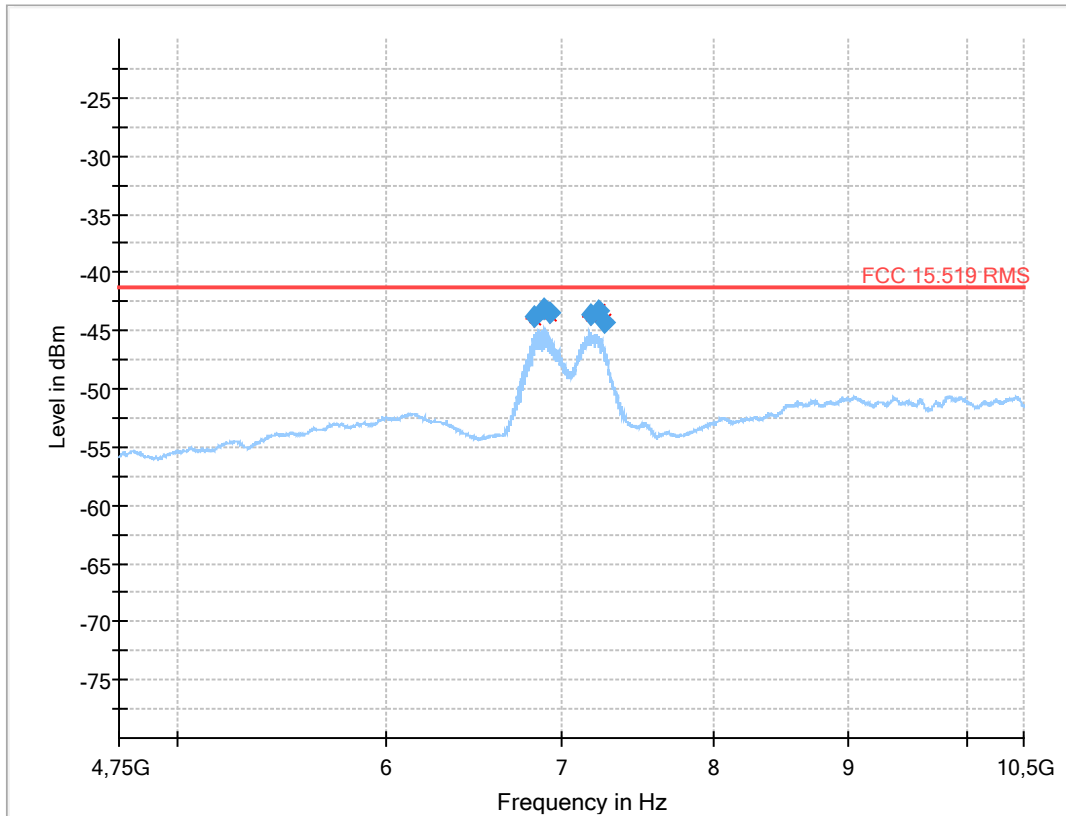

Final_Result

Frequency (MHz)	RMS (dBm)	Limit (dBm)	Margin (dB)	Bandwidth (kHz)	Pol	Azimuth (deg)	Elevation (deg)	Corr. (dB)
6832.516857	-43.82	-41.30	2.52	1000.000	H	50.0	119.0	-110.0
6900.247000	-43.06	-41.30	1.76	1000.000	H	52.0	117.0	-110.1
6932.994714	-43.53	-41.30	2.23	1000.000	H	53.0	118.0	-110.1
7183.383000	-43.66	-41.30	2.36	1000.000	V	39.0	84.0	-109.9
7231.365286	-43.30	-41.30	2.00	1000.000	V	42.0	80.0	-109.5
7267.663572	-44.25	-41.30	2.95	1000.000	V	42.0	77.0	-109.5

Plot 18: Channel C, 4.75 GHz to 10.5 GHz

Full Spectrum

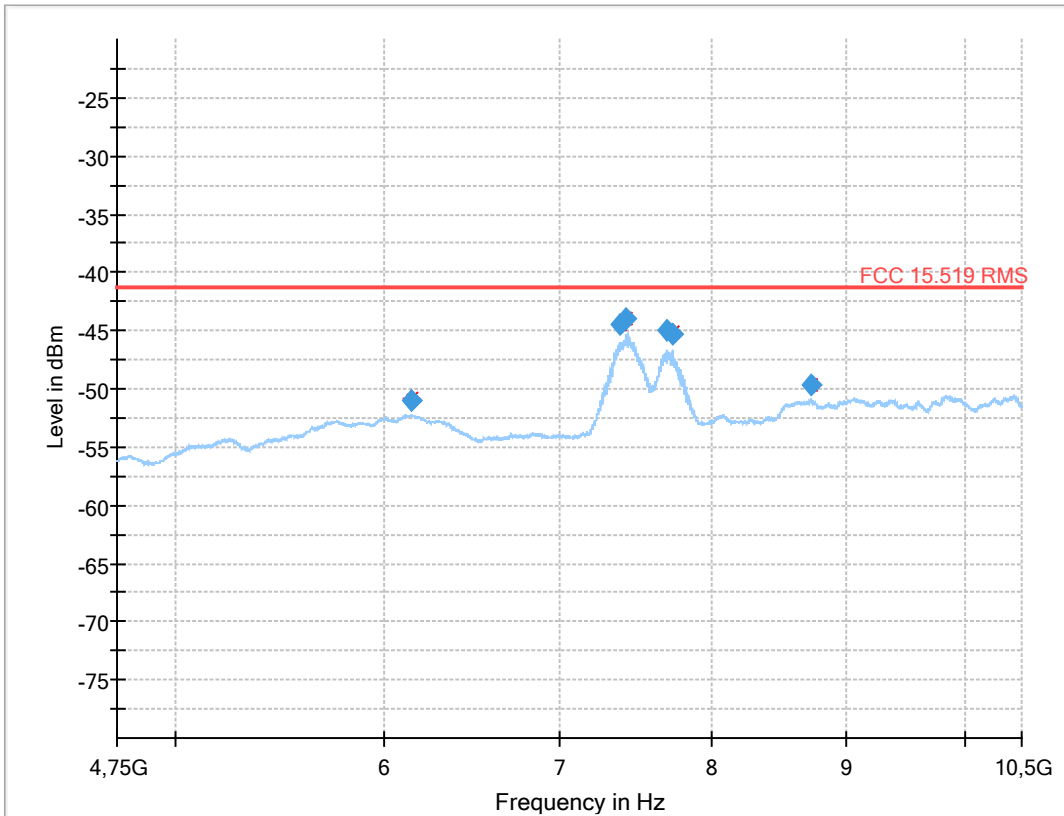

Final_Result

Frequency (MHz)	RMS (dBm)	Limit (dBm)	Margin (dB)	Bandwidth (kHz)	Pol	Azimuth (deg)	Elevation (deg)	Corr. (dB)
6145.652572	-50.98	-41.30	9.68	1000.000	V	153.0	82.0	-108.1
7377.970000	-44.50	-41.30	3.20	1000.000	V	114.0	56.0	-109.4
7427.121143	-43.99	-41.30	2.69	1000.000	V	108.0	61.0	-109.2
7690.746286	-45.03	-41.30	3.73	1000.000	H	169.0	147.0	-109.8
7725.965143	-45.38	-41.30	4.08	1000.000	H	170.0	145.0	-110.0
8727.266572	-49.74	-41.30	8.44	1000.000	H	287.0	45.0	-107.4

Plot 19: Channel A, 10 GHz to 18 GHz

Full Spectrum

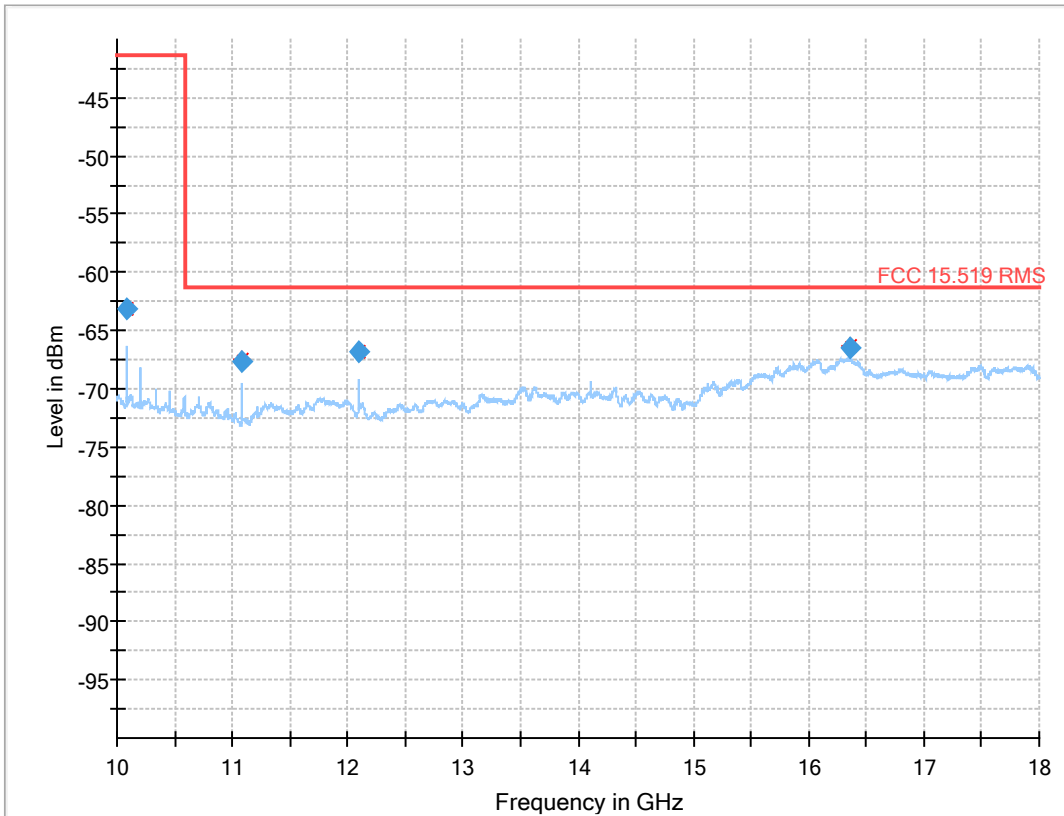

Final_Result

Frequency (MHz)	RMS (dBm)	Limit (dBm)	Margin (dB)	Bandwidth (kHz)	Pol	Azimuth (deg)	Elevation (deg)	Corr. (dB)
10079.962500	-63.20	-41.30	21.90	1000.000	H	222.0	0.0	-127.1
11087.967500	-67.65	-61.30	6.35	1000.000	H	198.0	33.0	-129.0
12095.952500	-66.76	-61.30	5.46	1000.000	H	9.0	105.0	-128.1
16357.947500	-66.45	-61.30	5.15	1000.000	V	206.0	4.0	-124.2

Plot 20: Channel B, 10 GHz to 18 GHz

Full Spectrum

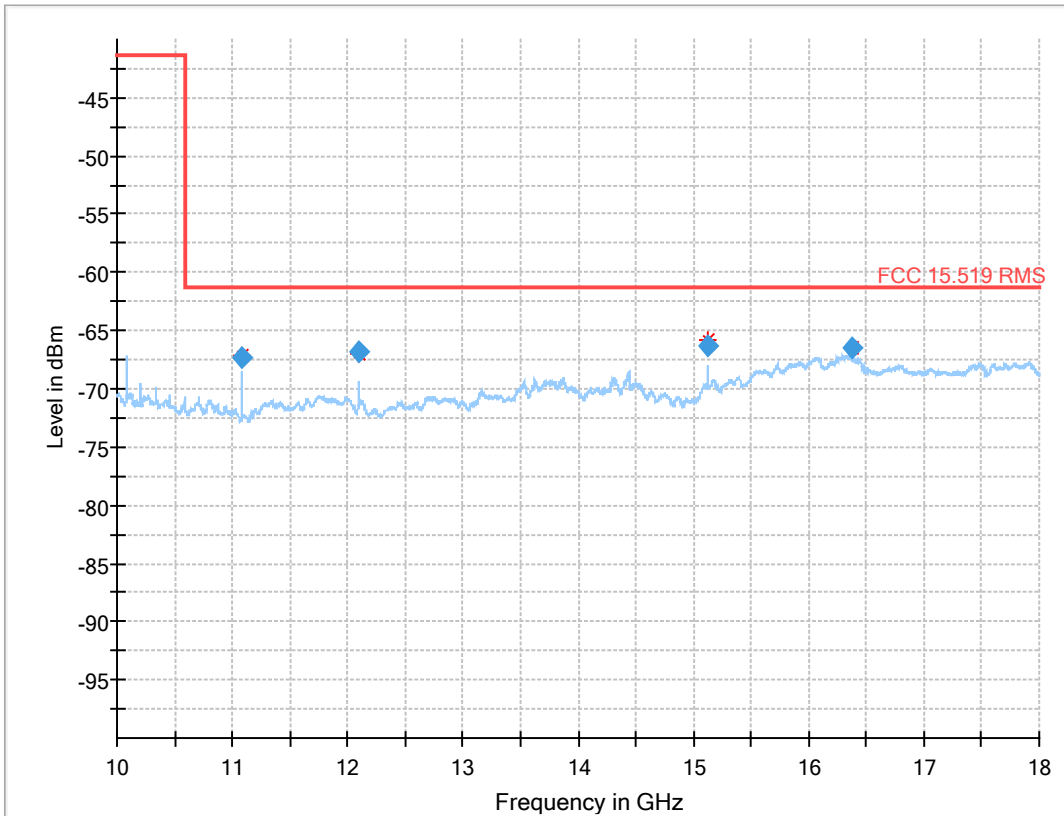

Final_Result

Frequency (MHz)	RMS (dBm)	Limit (dBm)	Margin (dB)	Bandwidth (kHz)	Pol	Azimuth (deg)	Elevation (deg)	Corr. (dB)
11088.523750	-67.29	-61.30	5.99	1000.000	V	36.0	113.0	-129.0
12096.536250	-66.80	-61.30	5.50	1000.000	H	106.0	64.0	-128.1
15120.613750	-66.25	-61.30	4.95	1000.000	H	125.0	139.0	-126.3
16368.455000	-66.49	-61.30	5.19	1000.000	V	2.0	13.0	-124.2

Plot 21: Channel C, 10 GHz to 18 GHz

Full Spectrum

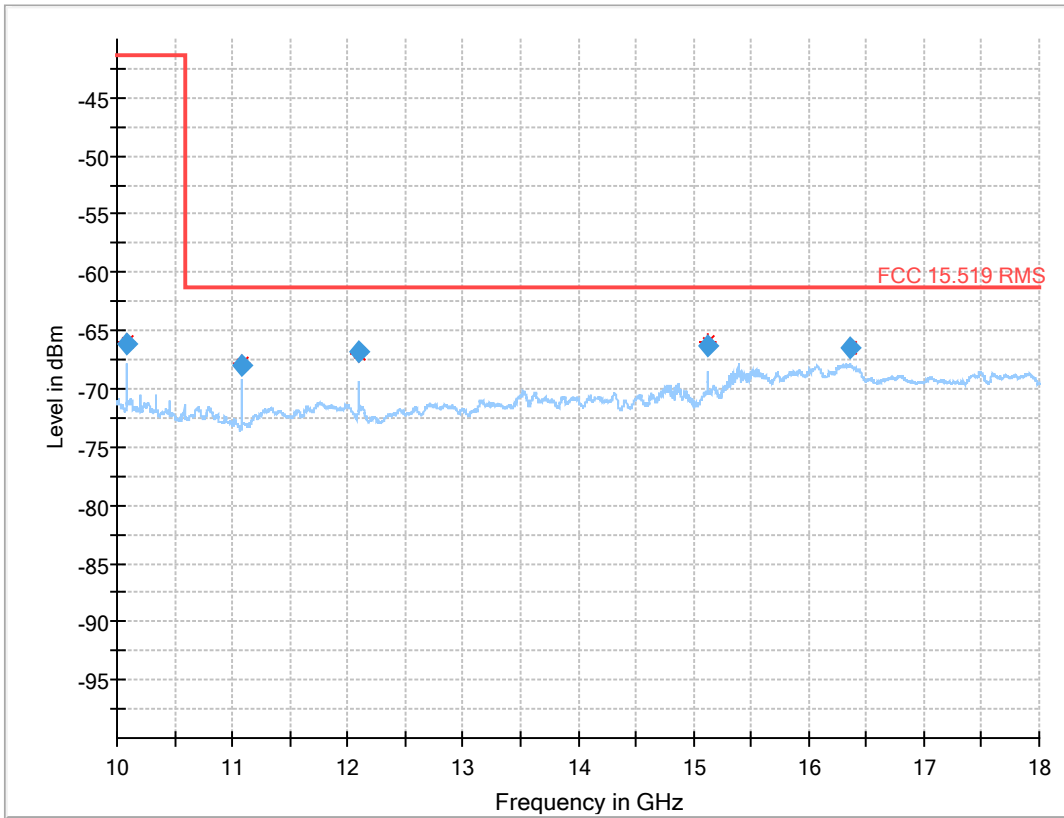

Final_Result

Frequency (MHz)	RMS (dBm)	Limit (dBm)	Margin (dB)	Bandwidth (kHz)	Pol	Azimuth (deg)	Elevation (deg)	Corr. (dB)
10080.357500	-66.07	-41.30	24.77	1000.000	H	225.0	0.0	-127.1
11088.620000	-68.02	-61.30	6.72	1000.000	V	36.0	118.0	-129.0
12096.505000	-66.81	-61.30	5.51	1000.000	H	106.0	64.0	-128.1
15120.716250	-66.28	-61.30	4.98	1000.000	H	122.0	143.0	-126.3
16360.626250	-66.51	-61.30	5.21	1000.000	V	289.0	19.0	-124.2

Plot 22: Max Hold on Channel A, 18 GHz to 26.5 GHz

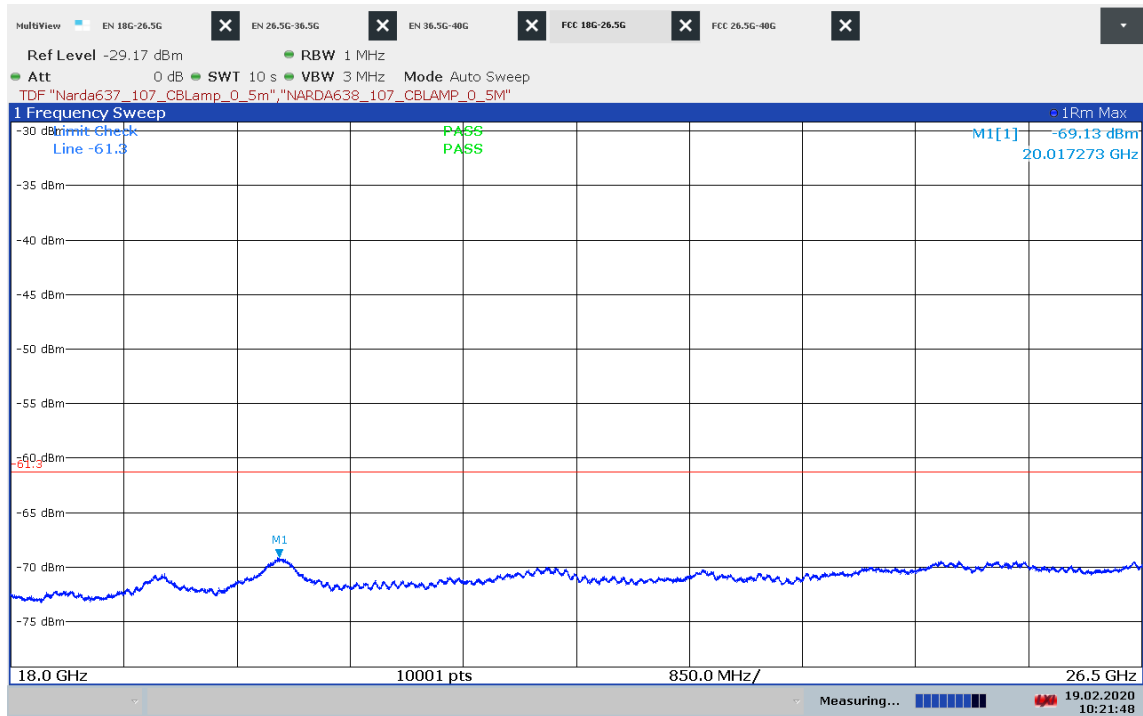

10:21:48 19.02.2020

Plot 23: Max Hold on Channel A, 26.5 GHz to 40.0 GHz

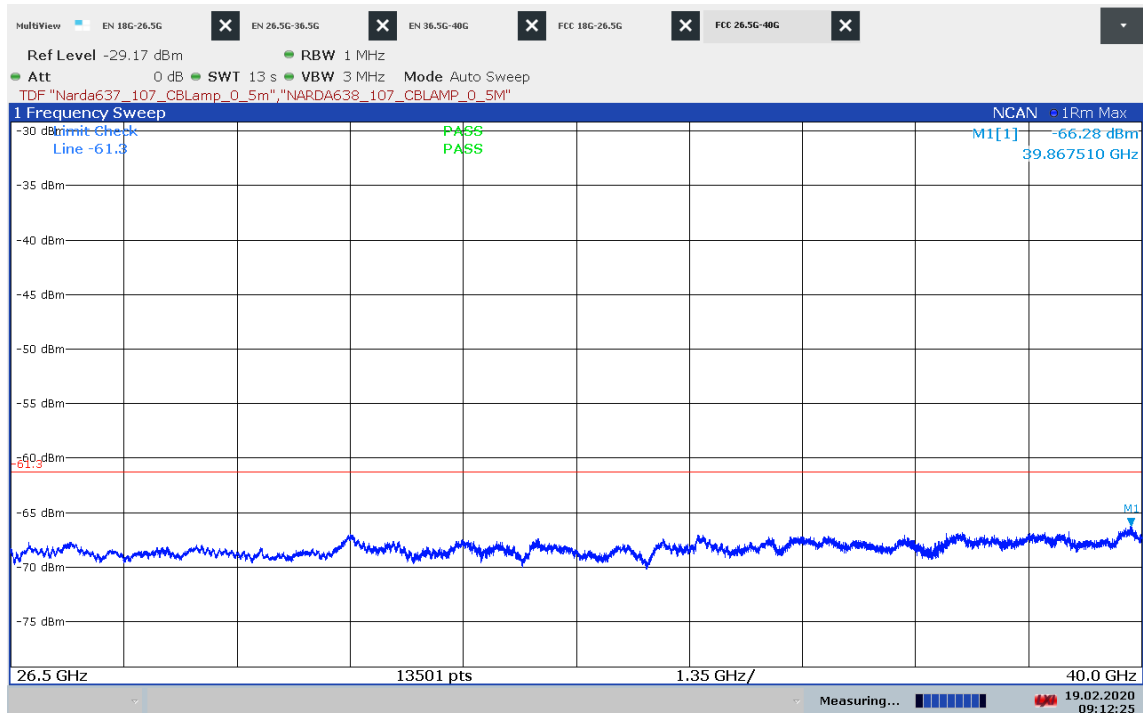

09:12:26 19.02.2020

Plot 24: Max Hold on Channel B, 18 GHz to 26.5 GHz

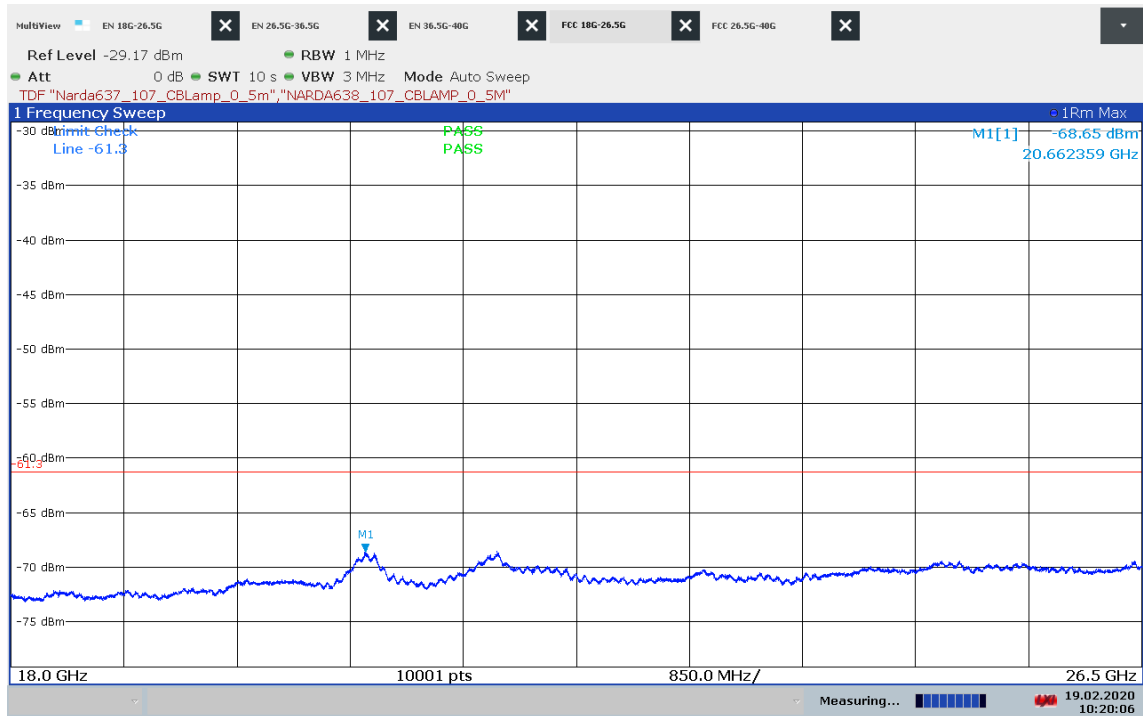

10:20:06 19.02.2020

Plot 25: Max Hold on Channel B, 26.5 GHz to 40.0 GHz

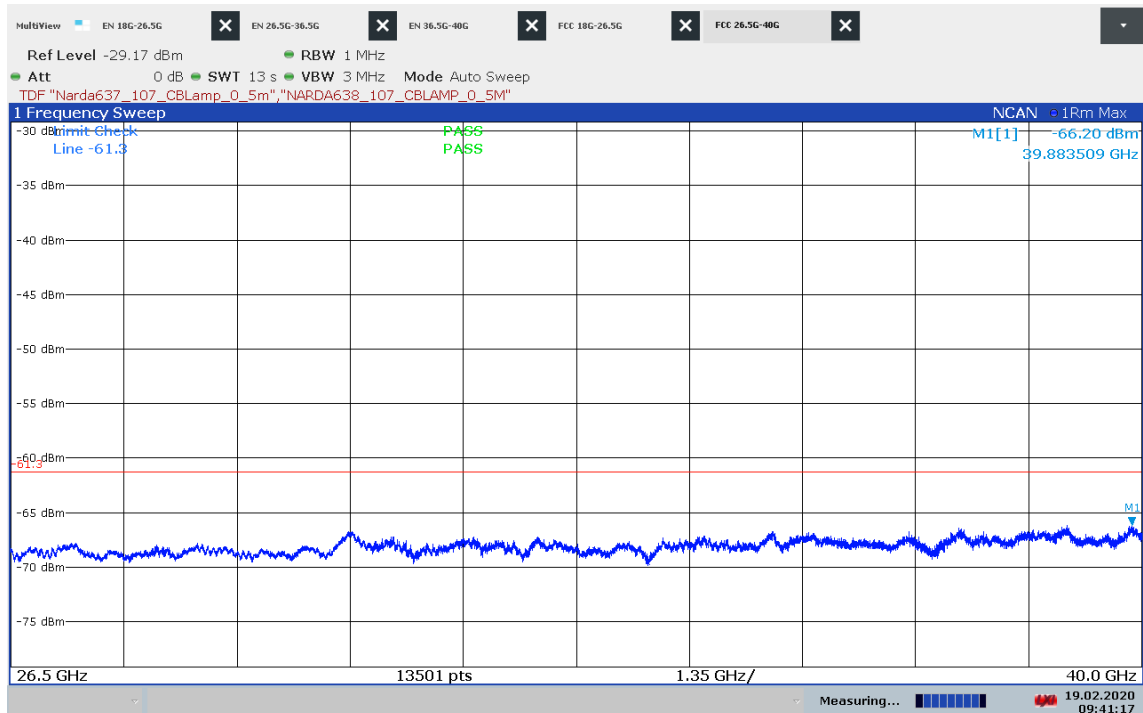

09:41:18 19.02.2020

Plot 26: Max Hold on Channel C, 18 GHz to 26.5 GHz

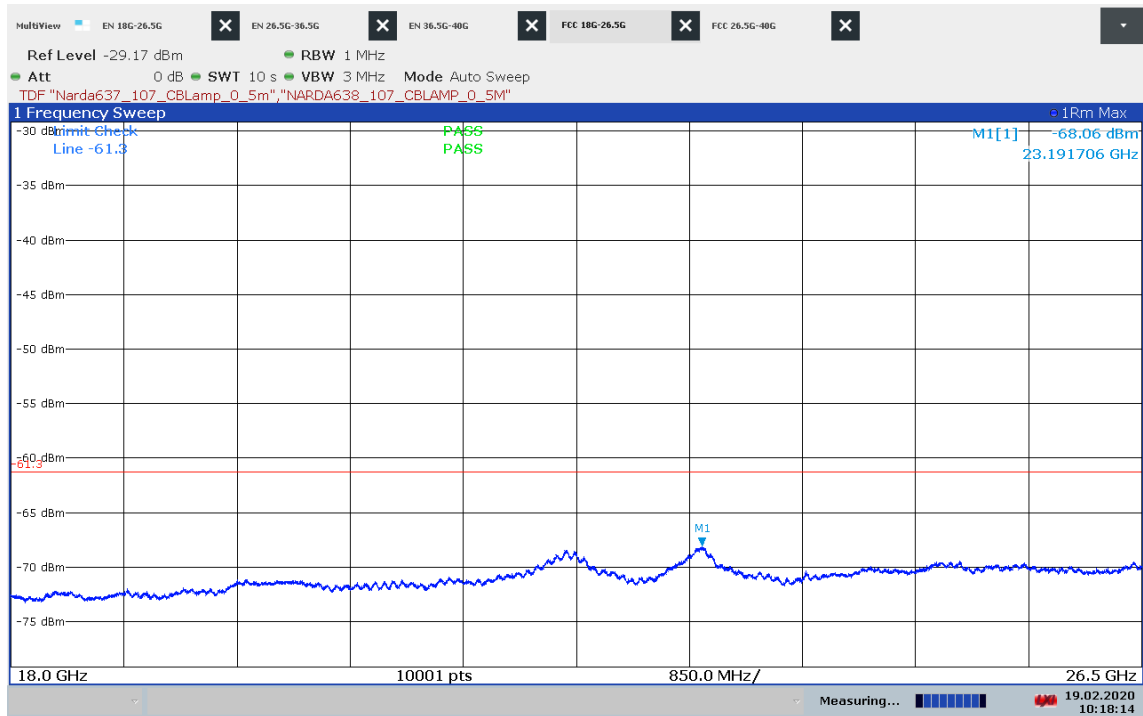

10:18:15 19.02.2020

Plot 27: Max Hold on Channel C, 26.5 GHz to 40.0 GHz

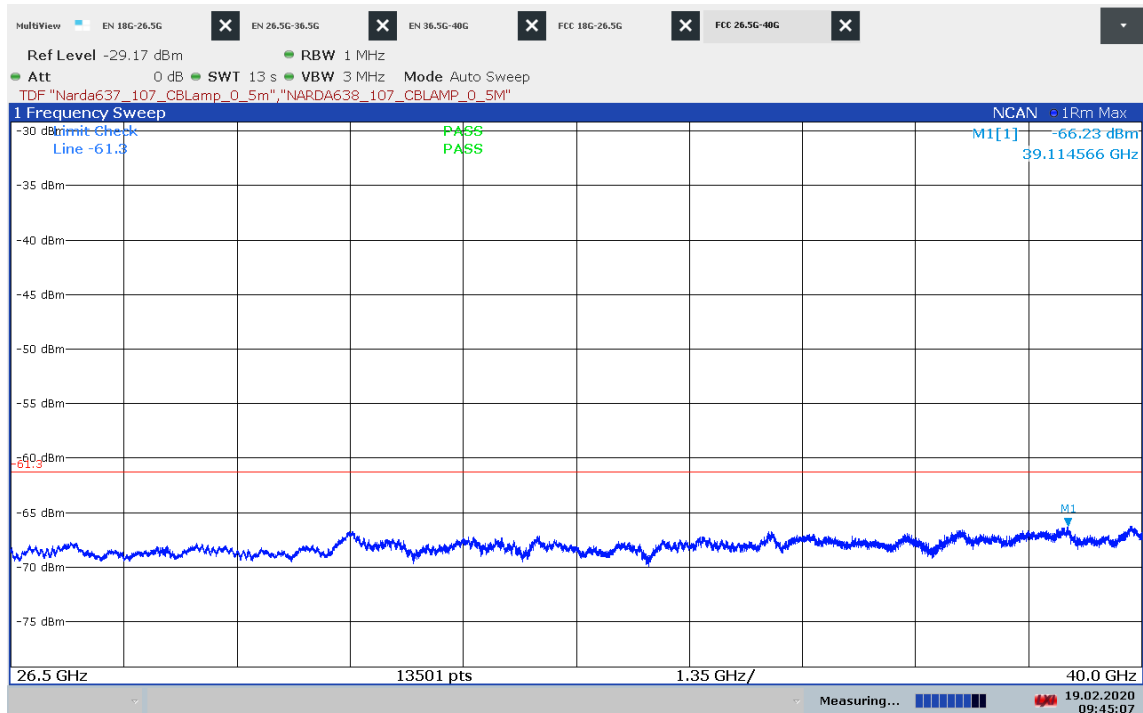

09:45:08 19.02.2020

Plot 28: Channel A, 15.519 (d)

Full Spectrum

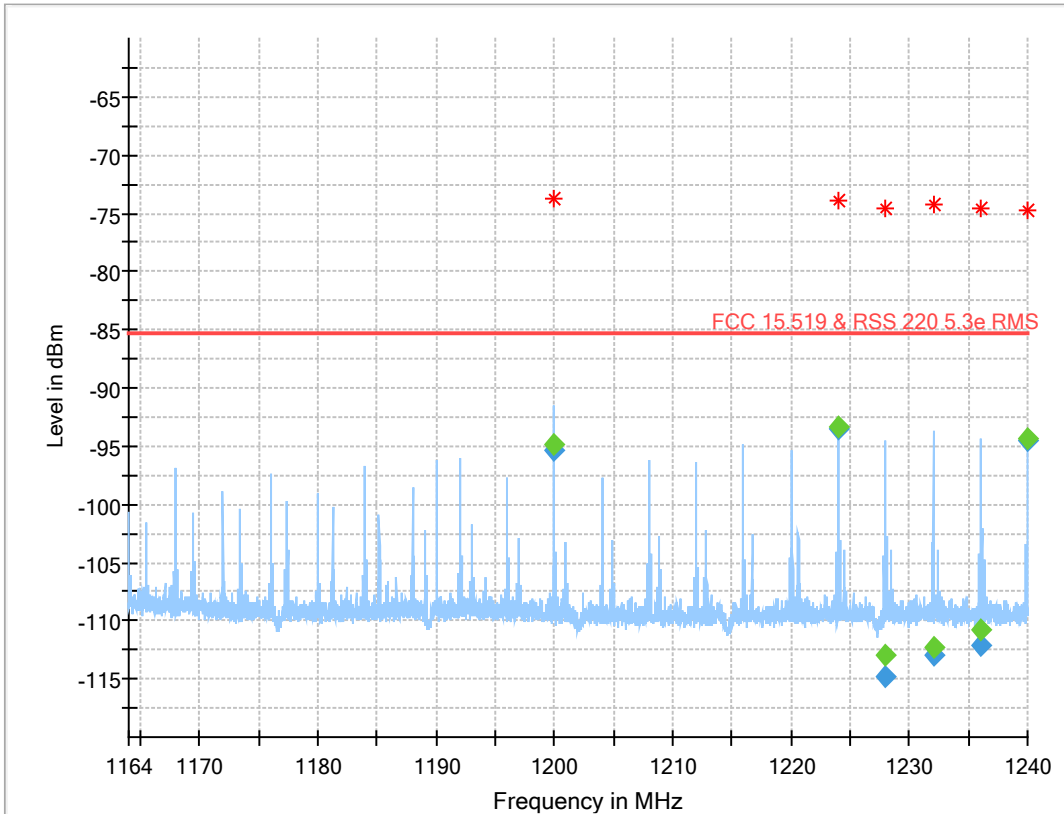

Final Result

Frequency (MHz)	RMS (dBm)	Limit (dBm)	Margin (dB)	Bandwidth (kHz)	Pol	Azimuth (deg)	Elevation (deg)	Corr. (dB)
1199.999977	-95.32	-85.30	10.02	1.000	V	144.0	352.0	-145.1
1223.998227	-93.56	-85.30	8.26	1.000	H	213.0	76.0	-145.2
1228.009667	-114.73	-85.30	29.43	1.000	H	211.0	76.0	-145.3
1232.009283	-113.04	-85.30	27.74	1.000	H	209.0	75.0	-145.3
1236.014397	-112.16	-85.30	26.86	1.000	H	198.0	85.0	-145.3
1239.998023	-94.49	-85.30	9.19	1.000	H	213.0	97.0	-145.1

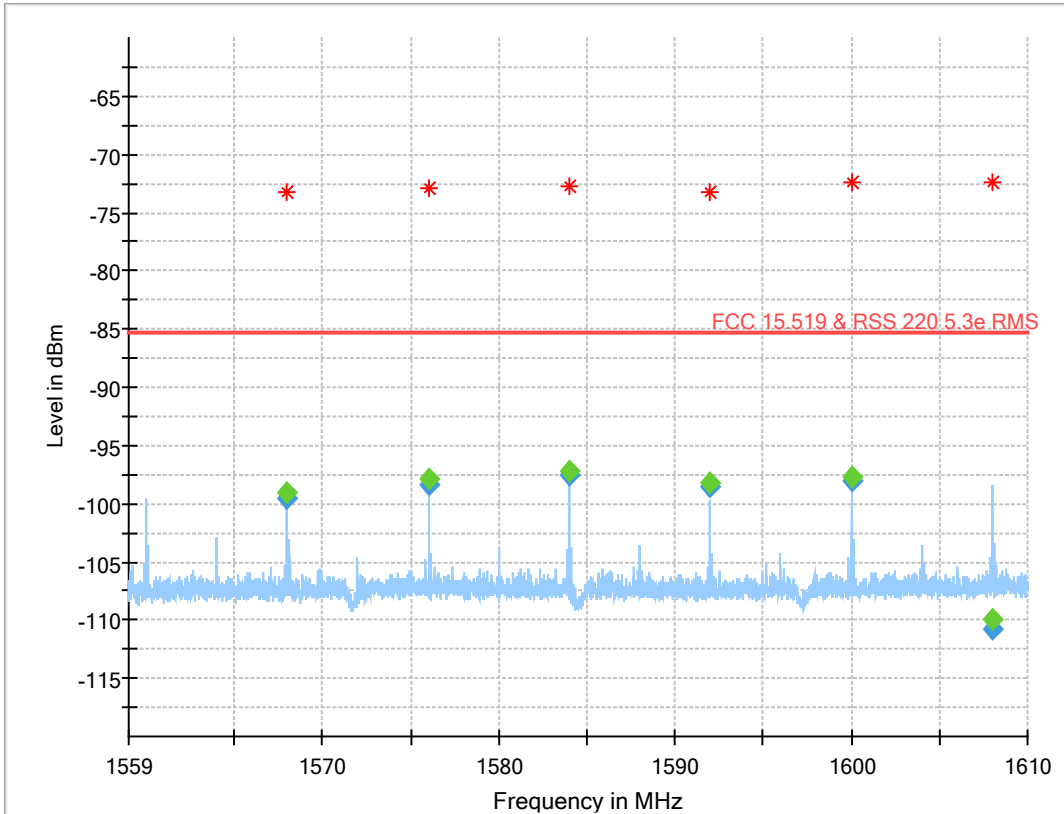

Final Result

Frequency (MHz)	RMS (dBm)	Limit (dBm)	Margin (dB)	Bandwidth (kHz)	Pol	Azimuth (deg)	Elevation (deg)	Corr. (dB)
1567.996657	-99.53	-85.30	14.23	1.000	V	143.0	149.0	-142.8
1575.996500	-98.44	-85.30	13.14	1.000	V	129.0	115.0	-142.8
1583.996693	-97.62	-85.30	12.32	1.000	V	125.0	111.0	-142.7
1591.996657	-98.61	-85.30	13.31	1.000	V	121.0	135.0	-142.7
1599.999960	-98.10	-85.30	12.80	1.000	V	188.0	254.0	-142.9
1607.999783	-110.73	-85.30	25.43	1.000	V	117.0	135.0	-143.1

Plot 29: Channel B, 15.519 (d)

Full Spectrum

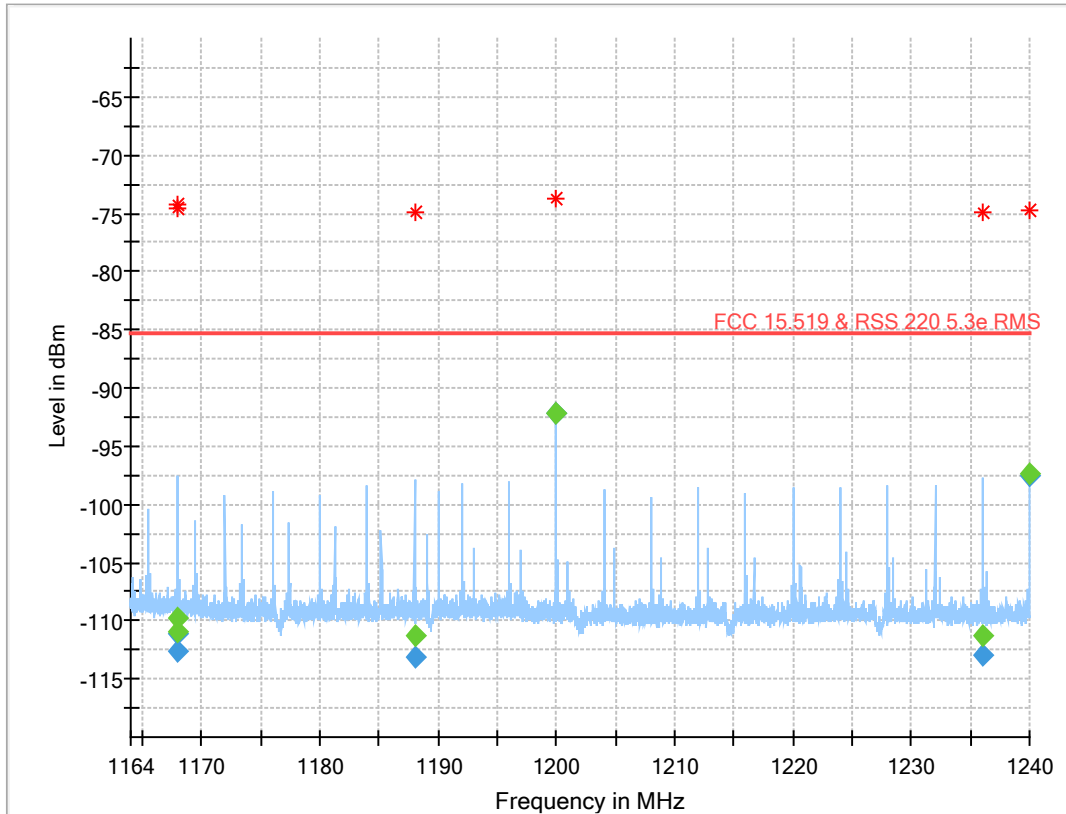

Final Result

Frequency (MHz)	RMS (dBm)	Limit (dBm)	Margin (dB)	Bandwidth (kHz)	Pol	Azimuth (deg)	Elevation (deg)	Corr. (dB)
1167.990778	-111.17	-85.30	25.87	1.000	H	210.0	105.0	-144.8
1167.994793	-112.68	-85.30	27.38	1.000	H	212.0	75.0	-144.8
1187.994447	-113.19	-85.30	27.89	1.000	V	132.0	156.0	-144.8
1199.999999	-92.22	-85.30	6.92	1.000	V	50.0	45.0	-145.1
1236.010413	-113.03	-85.30	27.73	1.000	V	115.0	165.0	-145.3
1239.997807	-97.59	-85.30	12.29	1.000	V	125.0	137.0	-145.1

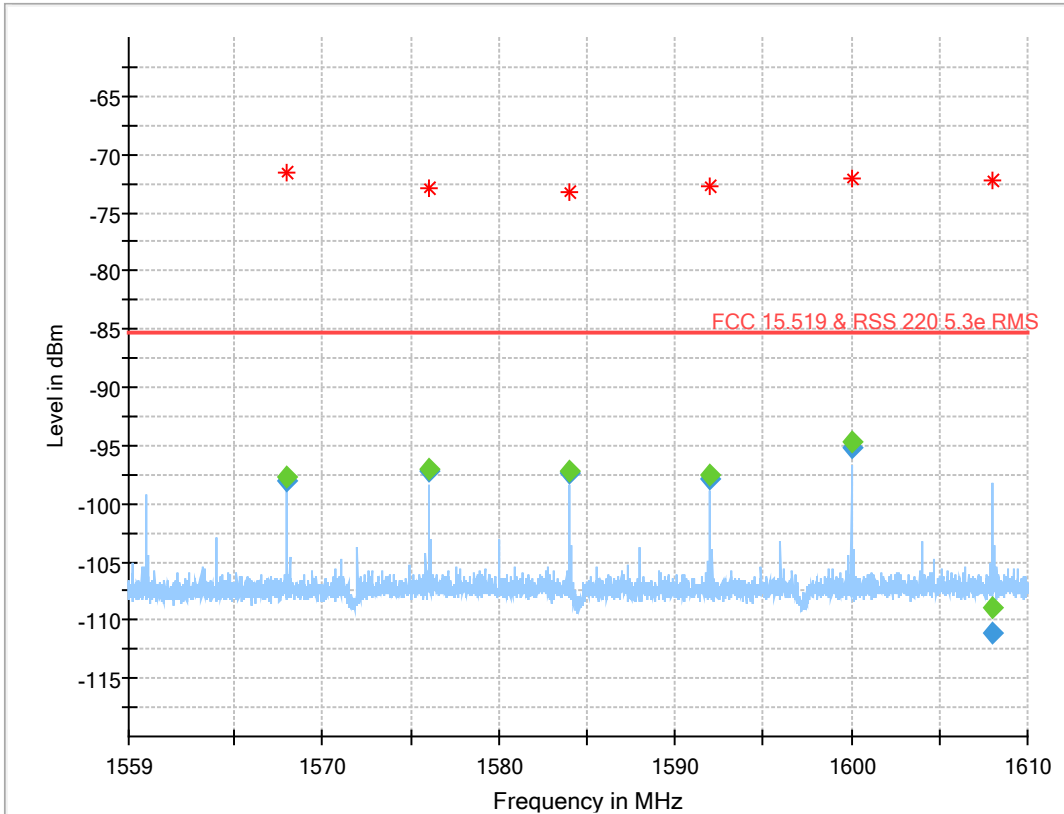

Final Result

Frequency (MHz)	RMS (dBm)	Limit (dBm)	Margin (dB)	Bandwidth (kHz)	Pol	Azimuth (deg)	Elevation (deg)	Corr. (dB)
1567.996578	-98.09	-85.30	12.79	1.000	H	189.0	45.0	-142.8
1575.996500	-97.24	-85.30	11.94	1.000	V	137.0	135.0	-142.8
1583.996423	-97.33	-85.30	12.03	1.000	V	140.0	107.0	-142.7
1591.996582	-97.84	-85.30	12.54	1.000	H	190.0	13.0	-142.7
1599.999982	-95.14	-85.30	9.84	1.000	V	190.0	26.0	-142.9
1608.006383	-111.06	-85.30	25.76	1.000	V	138.0	128.0	-143.1

Plot 30: Channel C, 15.519 (d)

Full Spectrum

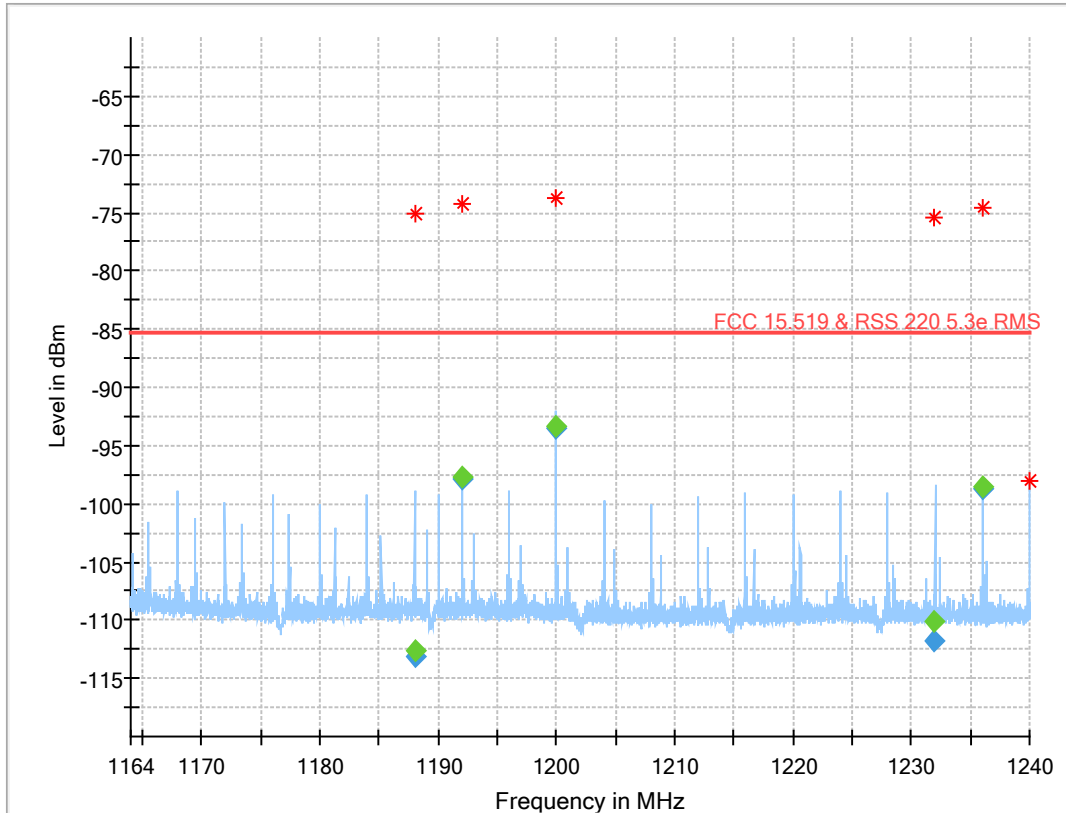

Final Result

Frequency (MHz)	RMS (dBm)	Limit (dBm)	Margin (dB)	Bandwidth (kHz)	Pol	Azimuth (deg)	Elevation (deg)	Corr. (dB)
1187.990270	-113.16	-85.30	27.86	1.000	V	109.0	140.0	-144.8
1191.997215	-97.92	-85.30	12.62	1.000	V	123.0	136.0	-144.9
1199.999987	-93.55	-85.30	8.25	1.000	V	70.0	109.0	-145.1
1232.002771	-111.73	-85.30	26.43	1.000	V	129.0	165.0	-145.3
1235.997135	-98.79	-85.30	13.49	1.000	V	95.0	165.0	-145.3

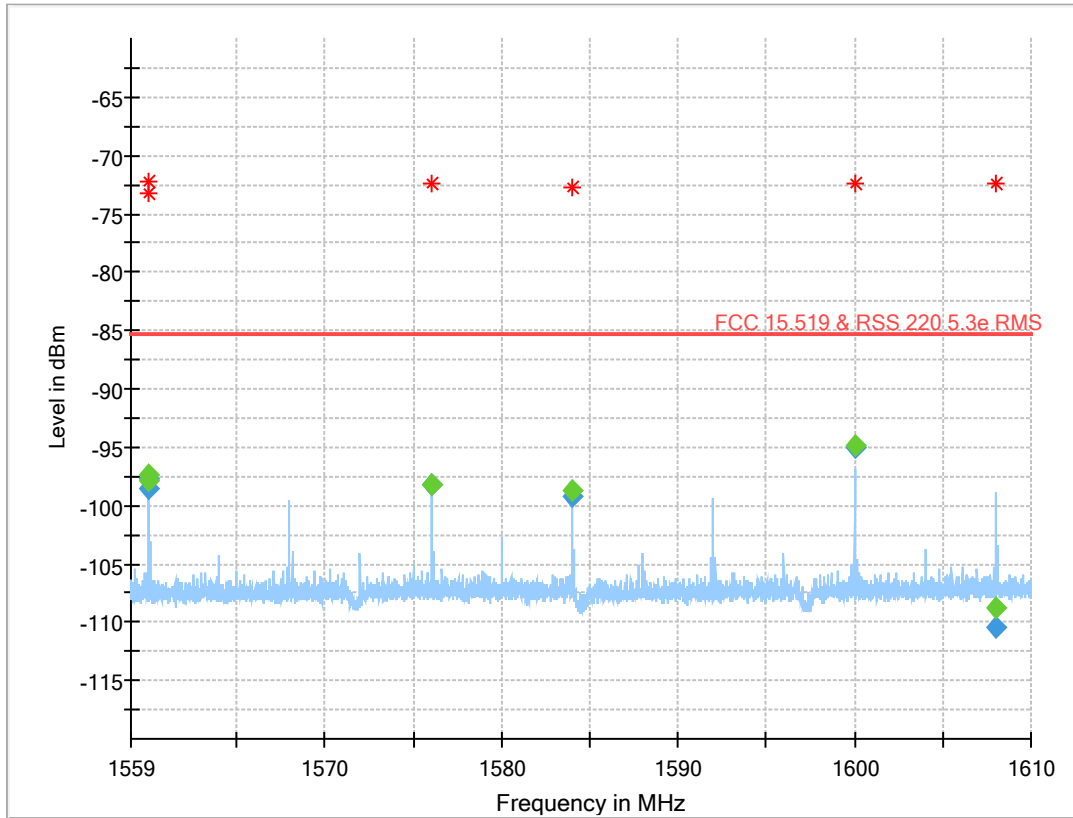

Final Result

Frequency (MHz)	RMS (dBm)	Limit (dBm)	Margin (dB)	Bandwidth (kHz)	Pol	Azimuth (deg)	Elevation (deg)	Corr. (dB)
1559.996050	---	---	---	1.000	V	136.0	114.0	-142.6
1559.996050	-98.51	-85.30	13.21	1.000	V	136.0	114.0	-142.6
1559.996065	---	---	---	1.000	V	130.0	132.0	-142.6
1559.996065	-97.78	-85.30	12.48	1.000	V	130.0	132.0	-142.6
1575.996088	---	---	---	1.000	H	190.0	45.0	-142.8
1575.996088	-98.25	-85.30	12.95	1.000	H	190.0	45.0	-142.8
1583.995953	---	---	---	1.000	V	154.0	140.0	-142.7
1583.995953	-99.14	-85.30	13.84	1.000	V	154.0	140.0	-142.7
1600.000030	---	---	---	1.000	V	190.0	345.0	-142.9
1600.000030	-94.96	-85.30	9.66	1.000	V	190.0	345.0	-142.9
1608.003247	---	---	---	1.000	V	128.0	116.0	-143.1
1608.003247	-110.39	-85.30	25.09	1.000	V	128.0	116.0	-143.1

10.3 §15.519(a)(1) Efficient use of spectrum acc. to

Description:

(1) A UWB device operating under the provisions of this section shall transmit only when it is sending information to an associated receiver. The UWB intentional radiator shall cease transmission within 10 seconds unless it receives an acknowledgement from the associated receiver that its transmission is being received. An acknowledgment of reception must continue to be received by the UWB intentional radiator at least every 10 seconds or the UWB device must cease transmitting.

Measurement:

Measurement parameter	
Detector:	Peak
Video bandwidth:	50 MHz
Resolution bandwidth:	80 MHz
Span	Zero

Limits:

After switching of the associated receiver the EUT shall cease transmission within 10 s.

Results:

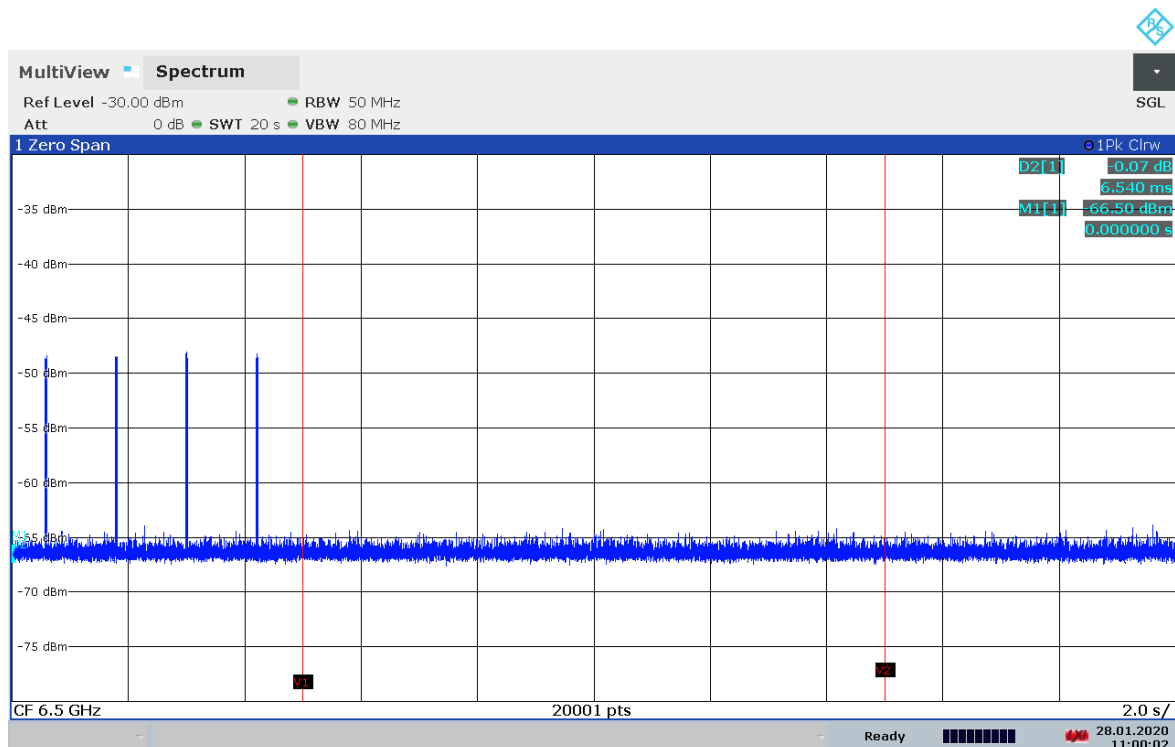

Plot 31: 11:00:03 28.01.2020
 Vertical line V1 indicates the time when the associated receiver is switched off
 Vertical line V2 indicates 10 s after the associated receiver is switched off

Verdict: Compliant

10.4 Antenna requirements

Description:

§15.521(b)

Manufacturers and users are reminded of the provisions of §§15.203 and 15.204.

Integrated patch antenna.

Verdict: Compliant

Annex A Glossary

EUT	Equipment under test
DUT	Device under test
UUT	Unit under test
GUE	GNSS User Equipment
ETSI	European Telecommunications Standards Institute
EN	European Standard
FCC	Federal Communications Commission
FCC ID	Company Identifier at FCC
IC	Industry Canada
PMN	Product marketing name
HMN	Host marketing name
HVIN	Hardware version identification number
FVIN	Firmware version identification number
EMC	Electromagnetic Compatibility
HW	Hardware
SW	Software
Inv. No.	Inventory number
S/N or SN	Serial number
C	Compliant
NC	Not compliant
NA	Not applicable
NP	Not performed
PP	Positive peak
QP	Quasi peak
AVG	Average
OC	Operating channel
OCW	Operating channel bandwidth
OBW	Occupied bandwidth
OOB	Out of band
DFS	Dynamic frequency selection
CAC	Channel availability check
OP	Occupancy period
NOP	Non occupancy period
DC	Duty cycle
PER	Packet error rate
CW	Clean wave
MC	Modulated carrier
WLAN	Wireless local area network
RLAN	Radio local area network
DSSS	Dynamic sequence spread spectrum
OFDM	Orthogonal frequency division multiplexing
FHSS	Frequency hopping spread spectrum
GNSS	Global Navigation Satellite System
C/N₀	Carrier to noise-density ratio, expressed in dB-Hz

Annex B Document history

Version	Applied changes	Date of release
-/-	Initial release	2020-03-25

Annex C Accreditation Certificate

first page

last page



Note: The current certificate annex is published on the website (link see below) of the Accreditation Body DAkkS or may be received by CTC advanced GmbH on request

<https://www.dakks.de/as/ast/d/D-PL-12076-01-03e.pdf>

END OF TEST REPORT