

TEST REPORT

Test Report Reference: R80249_B Edition 1

Equipment under Test: R56 Mini

FCC ID: IYZKEYR5602

IC: 2701A-KEYR5602

Serial Number: None

Applicant: Marquardt GmbH

Manufacturer: Marquardt GmbH

**Test Laboratory
(CAB)
accredited by
DATech in der TGA GmbH
in compliance with DIN EN ISO/IEC 17025
under the
Reg. No. DAT-P-105/99-21,
FCC Test site registration number 90877 and
Industry Canada Test site registration IC3469A-1**

TEST REPORT REFERENCE: R80249_B Edition 1

Contents:	Page
1 IDENTIFICATION	3
1.1 APPLICANT	3
1.2 MANUFACTURER	3
1.3 DATES	3
1.4 TEST LABORATORY	4
1.5 RESERVATION	4
1.6 NORMATIVE REFERENCES	4
1.7 TEST RESULTS	4
2 TECHNICAL DATA OF EQUIPMENT	5
2.1 DEVICE UNDER TEST	5
2.2 PERIPHERY DEVICES	5
2.3 SPECIAL EMC MEASURES	5
3 OPERATIONAL STATES AND PHYSICAL BOUNDARIES	6
4 LIST OF TEST MODULES	6
5 TEST RESULTS	7
5.1 RADIATED EMISSIONS	7
5.1.1 METHOD OF MEASUREMENT (RADIATED EMISSIONS)	7
5.1.2 PRELIMINARY RADIATED EMISSION TEST (9 kHz to 3.2 GHz)	14
5.1.3 FINAL RADIATED EMISSION TEST (30 MHz to 1 GHz)	18
5.1.4 FINAL MEASUREMENT (1 GHz to 3.2 GHz)	20
5.2 BAND-EDGE COMPLIANCE	21
5.2.1 METHOD OF MEASUREMENT (BAND-EDGE COMPLIANCE (RADIATED))	21
5.2.2 TEST RESULT (BAND-EDGE COMPLIANCE (RADIATED))	22
5.3 20 dB BANDWIDTH	24
5.3.1 METHOD OF MEASUREMENT (20 dB BANDWIDTH)	24
5.3.2 TEST RESULTS (20 dB BANDWIDTH)	25
5.4 TRANSMITTER RELEASE TIME	26
5.4.1 METHOD OF MEASUREMENT (TRANSMITTER RRELEASE TIME)	26
5.4.2 TEST RESULTS (TRANSMITTER RELEASE TIME)	27
6 TEST EQUIPMENT AND ANCILLARIES USED FOR TESTS	28
7 LIST OF ANNEXES	30

TEST REPORT REFERENCE: R80249_B Edition 1

1 IDENTIFICATION

1.1 APPLICANT

Name:	Marquardt GmbH
Address:	Schloßstraße 16 78604 Rietheim-Weilheim
Country:	Germany
Name for contact purposes:	Mrs. Sonja KISKANC
Tel:	+49 74 24 99-22 81
Fax:	+49 74 24 99-24 14
e-mail address:	sonja.kiskanc@marquardt.de

1.2 MANUFACTURER

Name:	Marquardt GmbH
Address:	Schloßstraße 16 78604 Rietheim-Weilheim
Country:	Germany
Name for contact purposes:	Mrs. Sonja KISKANC
Tel:	+49 74 24 99-22 81
Fax:	+49 74 24 99-24 14
e-mail address:	sonja.kiskanc@marquardt.de

1.3 DATES

Date of receipt of test sample:	28 January 2008
Start of test:	04 February 2008
End of test:	05 March 2008

TEST REPORT REFERENCE: R80249_B Edition 1

2 TECHNICAL DATA OF EQUIPMENT

2.1 DEVICE UNDER TEST

Type of equipment:	Transmitter for keyless entry system (vehicular environment)
Type designation/ model number	R56 Mini / 03376.0302
FCC ID:	IYZKEYR5602
IC:	2701A-KEYR5602
Serial No.:	None
Lowest internal frequency:	9.84375 MHz
Highest internal frequency:	315 MHz
Antenna type:	Internal only
Supply Voltage:	3 V DC by internal rechargeable battery

The following external I/O cables were used:

Cable	Length	Shielding	Connector
-	-	-	-
-	No cables were connectable to the EUT		-
-			-
-	-	-	-
-	-	-	-

*: Length during the test

2.2 PERIPHERY DEVICES

The following equipment was used as control unit and ancillary equipment:

-None.

2.3 SPECIAL EMC MEASURES

The following EMC measures were necessary to reach the documented results:

None.

TEST REPORT REFERENCE: R80249_B Edition 1

3 OPERATIONAL STATES AND PHYSICAL BOUNDARIES

During all tests the EUT was supplied via the fully charged internal battery.

For the whole frequency range a preliminary measurement in a fully anechoic chamber with a measuring distance of 3 m was carried out to determine the frequencies, which were radiated by the EUT. The final measurements on the detected frequencies were carried out on an outdoor test site without ground plane (for the frequency range 9 kHz to 30 MHz), on an open area test site with ground plane (for the frequency range 30 MHz to 1 GHz) and a fully anechoic chamber (for the frequency range 1 GHz to 3.2 GHz)

During the tests, the EUT was sealed but not labelled.

The physical boundaries of the Equipment Under Test are shown below.

Physical boundary of the EUT

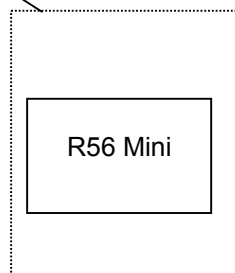

4 LIST OF TEST MODULES

Application	Frequency range [MHz]	FCC 47 CFR Part 15 section [2]	RSS 210, Issue 7 [3] or RSS-Gen, Issue 2 [4]	Status	Refer page
Radiated emissions	0.009 – 3,200	15.231 (b) 15.205 (a) 15.209 (a)	2.6 [3]	Passed	7 et seq.
Occupied bandwidth	315	15.231 (c)	4.6.1 [4]	Passed	24 et seq. and Annex D
Transmitter release time	315	15.231 (a) (1)	A1.1 [3]	Passed	26 et seq.

TEST REPORT REFERENCE: R80249_B Edition 1

5 TEST RESULTS

5.1 RADIATED EMISSIONS

5.1.1 METHOD OF MEASUREMENT (RADIATED EMISSIONS)

The radiated emission measurement is subdivided into five stages.

- A preliminary measurement carried out in a fully anechoic chamber with a fixed antenna height in the frequency range 9 kHz to 1 GHz.
- A final measurement carried out on an outdoor test site without reflecting ground plane and a fixed antenna height in the frequency range 9 kHz to 30 MHz.
- A final measurement carried out on an open area test site with reflecting ground plane and various antenna height in the frequency range 30 MHz to 1 GHz.
- A preliminary measurement carried out in a fully anechoic chamber with a variable antenna distance and height in the frequency range 1 GHz to 110 GHz.
- A final measurement carried out in a fully anechoic chamber with a fixed antenna height in the frequency range 1 GHz to 110 GHz.

All measurements will be carried out with the EUT working on the middle and upper and lower edge of the assigned frequency band. For this reason the hopping function of the EUT has to be disabled.

Preliminary measurement (9 kHz to 30 MHz):

In the first stage a preliminary measurement will be performed in a shielded room with a measuring distance of 3 meters. Tabletop devices will set up on a non-conducting support with a size of 1 m by 1.5 m and a height of 80 cm. Floor-standing devices will be placed directly on the turntable/ground plane. The set up of the Equipment under test will be in accordance to ANSI C63.4-2003 [1].

The frequency range 9 kHz to 30 MHz will be monitored with a spectrum analyser while the system and its cables will be manipulated to find out the configuration with the maximum emission levels if applicable. The EMI Receiver will be set to MAX Hold mode. The EUT and the measuring antenna will be rotated around their vertical axis to found the maximum emissions.

The resolution bandwidth of the spectrum analyser will be set to the following values:

Frequency range	Resolution bandwidth
9 kHz to 150 kHz	200 Hz
150 kHz to 30 MHz	10 kHz

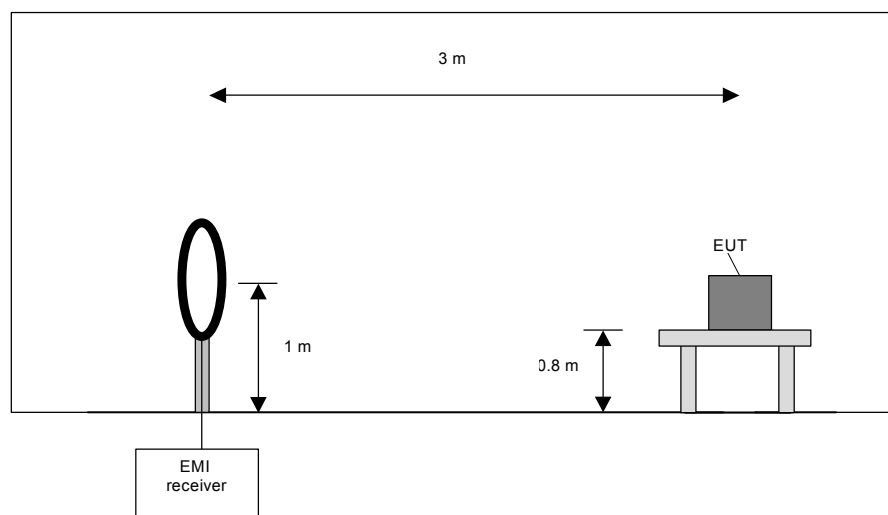

TEST REPORT REFERENCE: R80249_B Edition 1

Preliminary measurement procedure:

Prescans were performed in the frequency range 9 kHz to 150 kHz and 150 kHz to 30 MHz.

The following procedure will be used:

- 1) Monitor the frequency range at horizontal polarisation and a EUT azimuth of 0 °.
- 2) Manipulate the system cables within the range to produce the maximum level of emission.
- 3) Rotate the EUT by 360 ° to maximize the detected signals.
- 4) Make a hardcopy of the spectrum.
- 5) Measure the frequencies of highest detected emission with a lower span and resolution bandwidth to increase the accuracy and note the frequency value.
- 6) Repeat steps 1) to 5) with the other orthogonal axes of the EUT (because of EUT is a module and might be used in a handheld equipment application).
- 7) Rotate the measuring antenna and repeat steps 1) to 5).

Final measurement (9 kHz to 30 MHz):

In the second stage a final measurement will be performed on an open area test site with no conducting ground plane in a measuring distances of 3 m, 10 m and 30 m. In the case where larger measuring distances are required the results will be extrapolated based on the values measured on the closer distances according to Section 15.31 (f) (2) [2]. The final measurement will be performed with a EMI Receiver set to Quasi Peak detector except for the frequency bands 9 kHz to 90 kHz and 110 kHz to 490 kHz where an average detector will be used according Section 15.209 (d) [2].

On the during the preliminary measurement detected frequencies the final measurement will be performed while rotating the EUT and the measuring antenna in the range of 0 ° to 360 ° around their vertical axis until the maximum value is found.

The resolution bandwidth of the EMI Receiver will be set to the following values:

Frequency range	Resolution bandwidth
9 kHz to 150 kHz	200 Hz
150 kHz to 30 MHz	9 kHz

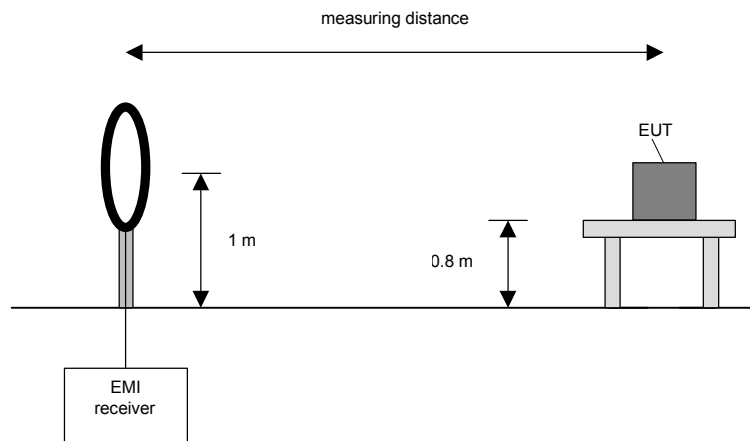

TEST REPORT REFERENCE: R80249_B Edition 1

Final measurement procedure:

The following procedure will be used:

- 1) Monitor the frequency range with the measuring antenna at vertical orientation parallel to the EUT at an azimuth of 0 °.
- 2) Rotate the EUT by 360 ° to maximize the detected signals and note the azimuth and orientation.
- 3) Rotate the measuring antenna to find the maximum and note the value.
- 4) Rotate the measuring antenna and repeat steps 1) to 3) until the maximum value is found.
- 5) Repeat steps 1) to 4) with the other orthogonal axes of the EUT (because of EUT is a module and might be used in a handheld equipment application).

Preliminary measurement (30 MHz to 1 GHz)

In the first stage a preliminary measurement will be performed in a fully anechoic chamber with a measuring distance of 3 meter. Tabletop devices will set up on a non-conducting support with a size of 1 m by 1.5 m and a height of 80 cm. Floor-standing devices will be placed directly on the turntable/ground plane. The set up of the Equipment under test will be in accordance to ANSI C63.4-2003 [1].

The frequency range 30 MHz to 1 GHz will be measured with an EMI Receiver set to MAX Hold mode and a resolution bandwidth of 100 kHz. The measurement will be performed in horizontal and vertical polarisation of the measuring antenna and while rotating the EUT in its vertical axis in the range of 0 ° to 360 °.

The resolution bandwidth of the EMI Receiver will be set to the following values:

Frequency range	Resolution bandwidth
30 MHz to 230 MHz	100 kHz
230 MHz to 1 GHz	100 kHz

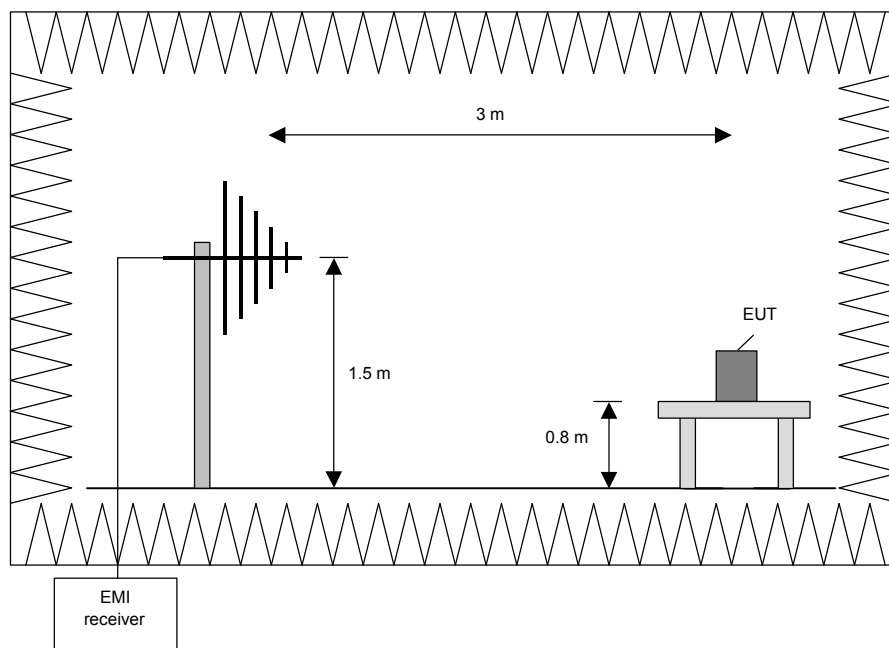

TEST REPORT REFERENCE: R80249_B Edition 1

Procedure preliminary measurement:

Prescans were performed in the frequency range 30 MHz to 230 MHz and 230 MHz to 1 GHz.
The following procedure will be used:

1. Monitor the frequency range at horizontal polarisation and a EUT azimuth of 0 °.
2. Manipulate the system cables within the range to produce the maximum level of emission.
3. Rotate the EUT by 360 ° to maximize the detected signals.
4. Make a hardcopy of the spectrum.
5. Measure the frequency of the detected emissions with a lower span and resolution bandwidth to increase the accuracy and note the frequency value.
6. Repeat 1) to 4) with the other orthogonal axes of the EUT (because of EUT is a module and might be used in a handheld equipment application).
7. Repeat 1) to 5) with the vertical polarisation of the measuring antenna.

Final measurement (30 MHz to 1 GHz)

A final measurement on an open area test site will be performed on selected frequencies found in the preliminary measurement. During this test the EUT will be rotated in the range of 0 ° to 360 °, the measuring antenna will be set to horizontal and vertical polarisation and raised and lowered in the range from 1 m to 4 m to find the maximum level of emissions.

The resolution bandwidth of the EMI Receiver will be set to the following values:

Frequency range	Resolution bandwidth
30 MHz to 1 GHz	120 kHz

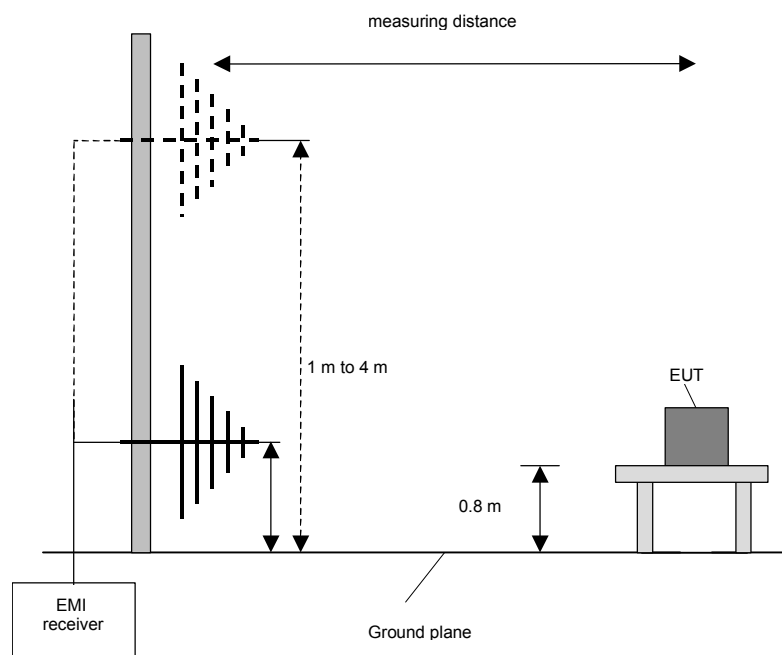

TEST REPORT REFERENCE: R80249_B Edition 1

Procedure final measurement:

The following procedure will be used:

- 1) Measure on the selected frequencies at an antenna height of 1 m and a EUT azimuth of 23 °.
- 2) Move the antenna from 1 m to 4 m and note the maximum value at each frequency.
- 3) Rotate the EUT by 45 ° and repeat 2) until an azimuth of 337 ° is reached.
- 4) Repeat 1) to 3) for the other orthogonal antenna polarization.
- 5) Move the antenna and the turntable to the position where the maximum value is detected.
- 6) Measure while moving the antenna slowly +/- 1 m.
- 7) Set the antenna to the position where the maximum value is found.
- 8) Measure while moving the turntable +/- 45 °.
- 9) Set the turntable to the azimuth where the maximum value is found.
- 10) Measure with Final detector (QP and AV) and note the value.
- 11) Repeat 5) to 10) for each frequency.
- 12) Repeat 1) to 11) for each orthogonal axes of the EUT (because of EUT is a module and might be used in a handheld equipment application).

Preliminary and final measurement (1 GHz to 110 GHz)

This measurement will be performed in a fully anechoic chamber. Tabletop devices will set up on a non-conducting support with a size of 1 m by 1.5 m and a height of 80 cm. Floor-standing devices will be placed directly on the turntable/ground plane. The set up of the Equipment under test will be in accordance to ANSI C63.4-2003 [1].

Preliminary measurement (1 GHz to 110 GHz)

The frequency range will be divided into different sub ranges depending of the frequency range of the used horn antenna. The spectrum analyser set to MAX Hold mode and a resolution bandwidth of 100 kHz. The measurement will be performed in horizontal and vertical polarisation of the measuring antenna, the antenna close to the EUT and while moving the antenna over all sides of the EUT. With the spectrum analyser in CLEAR / WRITE mode the cone of the emission should be found and than the measuring distance will be set to 3 m with the receiving antenna moving in this cone of emission. At this position the final measurement will be carried out.

The resolution bandwidth of the EMI Receiver will be set to the following values:

Frequency range	Resolution bandwidth
1 GHz to 4 GHz	100 kHz
4 GHz to 12 GHz	100 kHz
12 GHz to 18 GHz	100 kHz
18 GHz to 26.5 GHz	100 kHz
26.5 GHz to 40 GHz	100 kHz
40 GHz to 60 GHz	100 kHz
50 GHz to 75 GHz	100 kHz
75 GHz to 110 GHz	100 kHz

TEST REPORT REFERENCE: R80249_B Edition 1

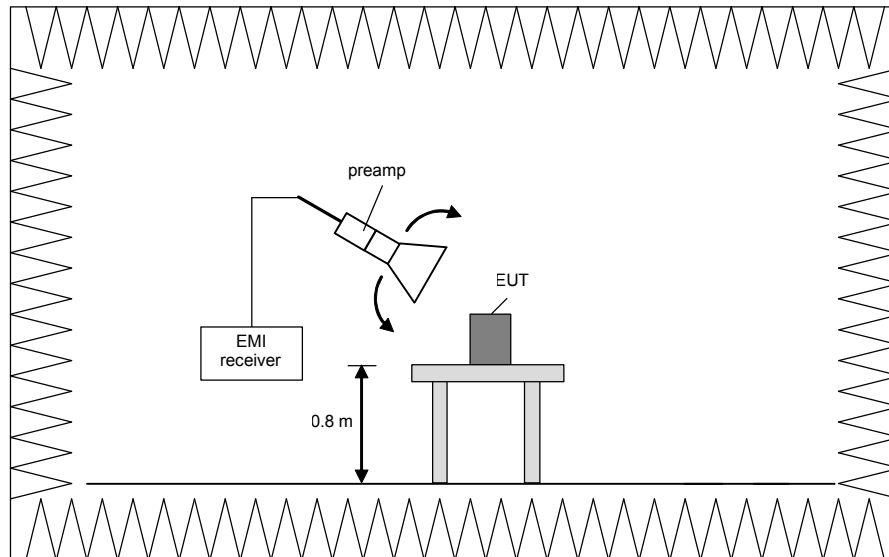

Final measurement (1 GHz to 110 GHz)

The frequency range will be divided into different sub ranges depending of the frequency range of the used horn antenna. The EMI Receiver set to peak and average mode and a resolution bandwidth of 1 MHz. The measurement will be performed in horizontal and vertical polarisation of the measuring antenna and while rotating the EUT in its vertical axis in the range of 0 ° to 360 ° in order to have the antenna inside the cone of radiation.

The resolution bandwidth of the EMI Receiver will be set to the following values:

Frequency range	Resolution bandwidth
1 GHz to 4 GHz	1 MHz
4 GHz to 12 GHz	1 MHz
12 GHz to 18 GHz	1 MHz
18 GHz to 26.5 GHz	1 MHz
26.5 GHz to 40 GHz	1 MHz
40 GHz to 60 GHz	1 MHz
50 GHz to 75 GHz	1 MHz
75 GHz to 110 GHz	1 MHz

TEST REPORT REFERENCE: R80249_B Edition 1

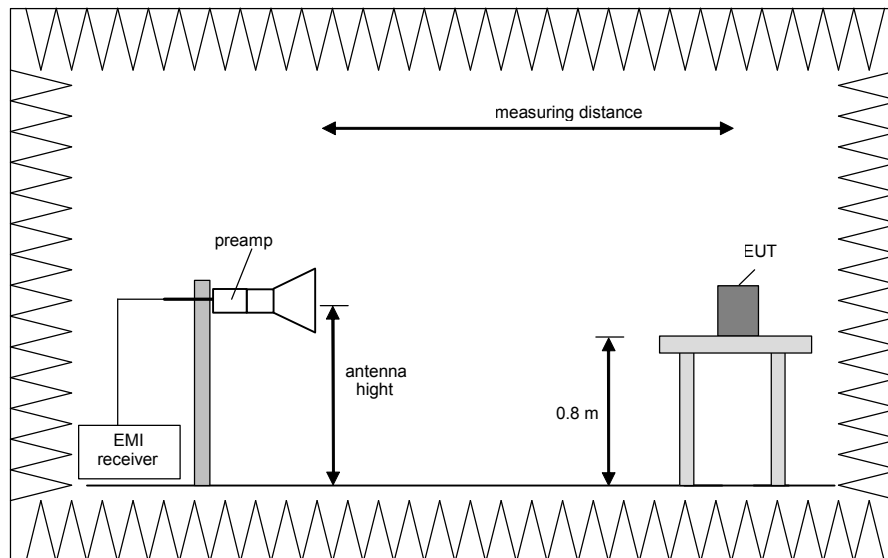

Procedure of measurement:

The measurements were performed in the frequency range 1 GHz to 4 GHz, 4 GHz to 12 GHz, 12 GHz to 18 GHz, 18 GHz to 26.5 GHz, 26.5 GHz to 40 GHz, 40 GHz to 60 GHz, 60 GHz to 75 GHz and 75 GHz to 110 GHz.

The following procedure will be used:

- 1) Monitor the frequency range at horizontal polarisation and move the antenna over all sides of the EUT (if necessary move the EUT to another orthogonal axis).
- 2) Change the antenna polarisation and repeat 1) with vertical polarisation.
- 3) Make a hardcopy of the spectrum.
- 4) Measure the frequency of the detected emissions with a lower span and resolution bandwidth to increase the accuracy and note the frequency value.
- 5) Change the analyser mode to Clear / Write and found the cone of emission.
- 6) Rotate and move the EUT, so that the measuring distance can be enlarged to 3 m and the antenna will be still inside the cone of emission.
- 7) Measure the level of the detected frequency with the correct resolution bandwidth, with the antenna polarisation and azimuth and the peak and average detector, which causes the maximum emission.
- 8) Repeat steps 1) to 7) for the next antenna spot if the EUT is larger than the antenna beamwidth.

Step 1) to 6) are defined as preliminary measurement.

TEST REPORT REFERENCE: R80249_B Edition 1

5.1.2 PRELIMINARY RADIATED EMISSION TEST (9 kHz to 3.2 GHz)

Ambient temperature:	20 °C	Relative humidity:	35 %
----------------------	-------	--------------------	------

- Position of EUT:** The EUT was set-up on a non-conducting table of a height of 0.8 m. The distance between EUT and antenna was 3 m.
- Cable guide:** No cables were connectable to the EUT. For further information of the EUT set-up refer to the pictures in annex A of this test report.
- Test record:** During the test, the EUT transmits continuously with normal modulation. All results are shown in the following. The EUT was tested in three orthogonal directions, the documented results were the worst case emissions.
- Supply voltage:** The EUT was supplied by the fully charged internal battery.

80249_16.wmf: Spurious emissions from 9 kHz to 150 kHz:

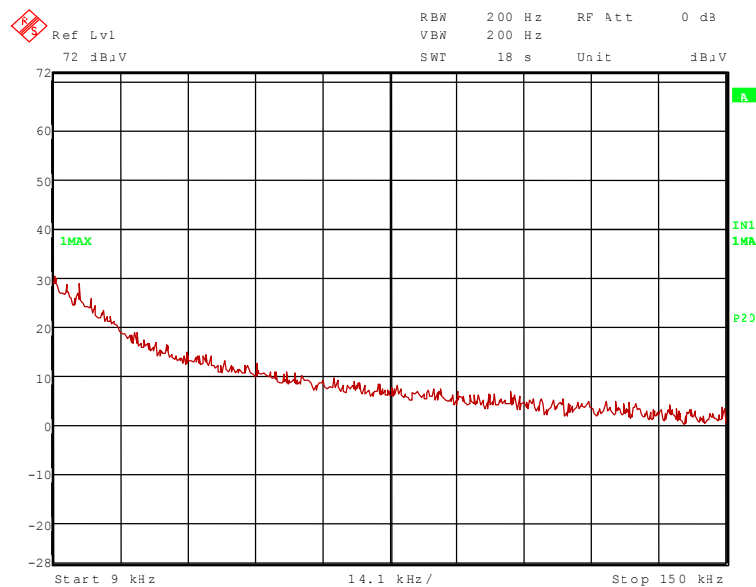

TEST EQUIPMENT USED THE TEST:

29, 31 – 35, 43, 56

TEST REPORT REFERENCE: R80249_B Edition 1

80249_15.wmf: Spurious emissions from 150 kHz to 1 MHz:

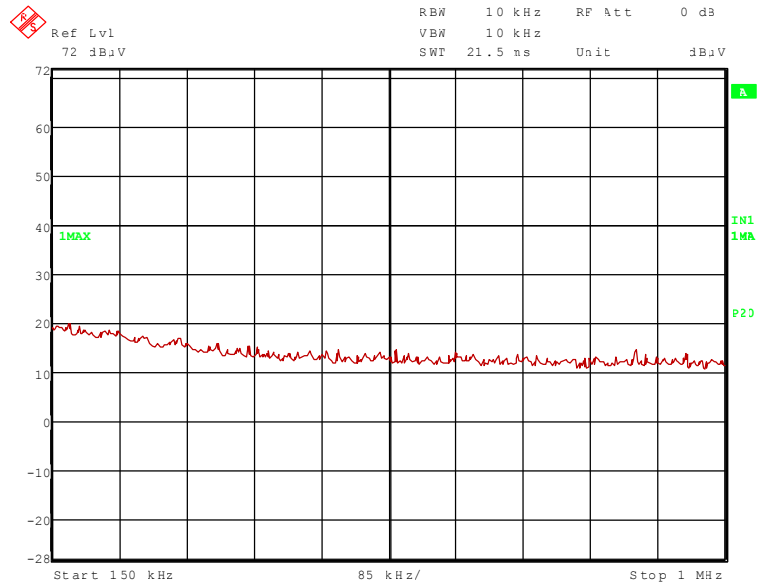

80249_14.wmf: Spurious emissions from 1 MHz to 30 MHz:

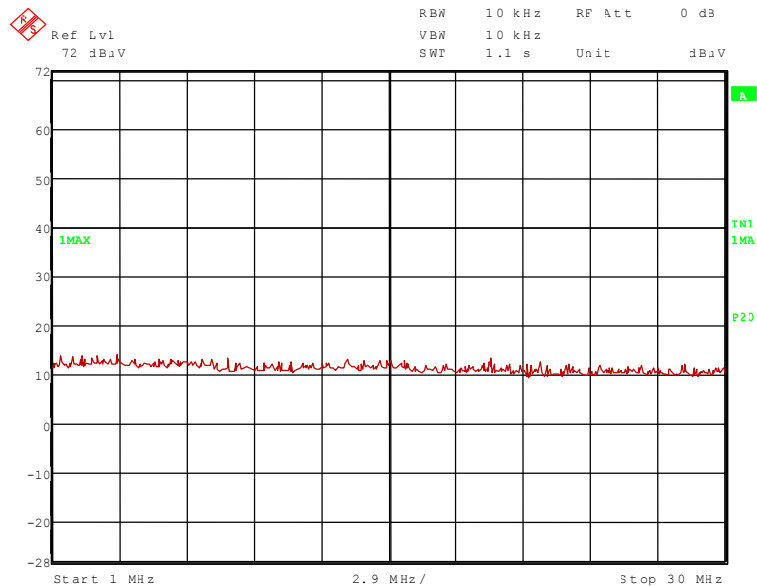

No significant frequencies above the noise floor of the system were found during the preliminary radiated emission test, so no measurements were carried out on the outdoor test site.

TEST REPORT REFERENCE: R80249_B Edition 1

80249_6.wmf: Spurious emissions from 1 GHz to 3.2 GHz:

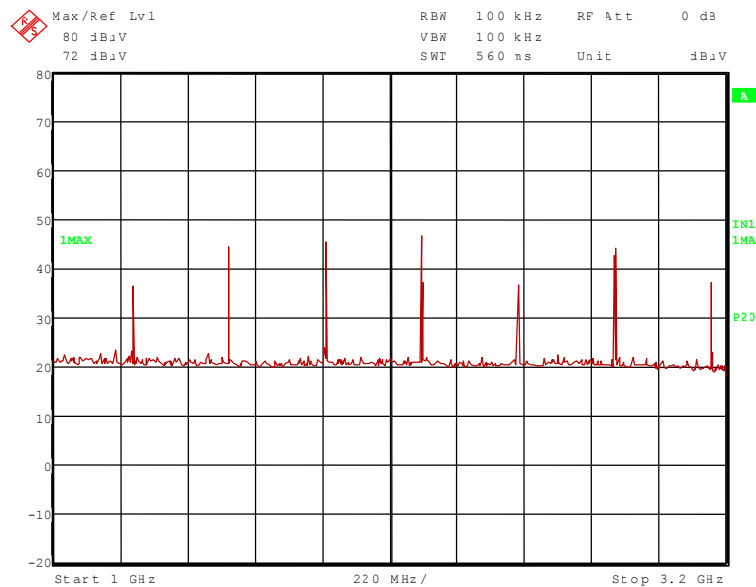

The following frequencies were found inside the restricted bands during the preliminary radiated emission test:

- 1575.170 GHz, 2205.238 GHz and 2835.306 GHz.

The following frequency was found outside the restricted bands during the preliminary radiated emission test:

- 1260.136 GHz, 1890.204 GHz, 2520.272 GHz and 3150.340 GHz.

These frequencies have to be measured in a final measurement. The results were presented in the following.

TEST REPORT REFERENCE: R80249_B Edition 1

5.1.3 FINAL RADIATED EMISSION TEST (30 MHz to 1 GHz)

Ambient temperature:	20 °C	Relative humidity:	42 %
----------------------	-------	--------------------	------

- Position of EUT: The EUT was set-up on a non-conducting table of a height of 0.8 m. The distance between EUT and antenna was 3 m.
- Cable guide: No cables were connectable to the EUT. For further information of the EUT set-up refer to the pictures in annex A of this test report.
- Test record: During the test, the EUT transmits continuously with normal modulation. All results are shown in the following. The EUT was tested in three orthogonal directions, the documented results were the worst case emissions.
- Supply voltage: The EUT was supplied by the fully charged internal battery.
- Test results: The test results were calculated with the following formula:

$$\text{Result [dB}\mu\text{V/m]} = \text{reading [dB}\mu\text{V]} + \text{cable loss [dB]} + \text{antenna factor [dB/m]}$$

The measured points and the limit line in the following diagram refer to the standard measurement of the emitted interference in compliance with the above-mentioned standard. The measured points marked with x are the measured results of the standard final measurement on the open area test site.

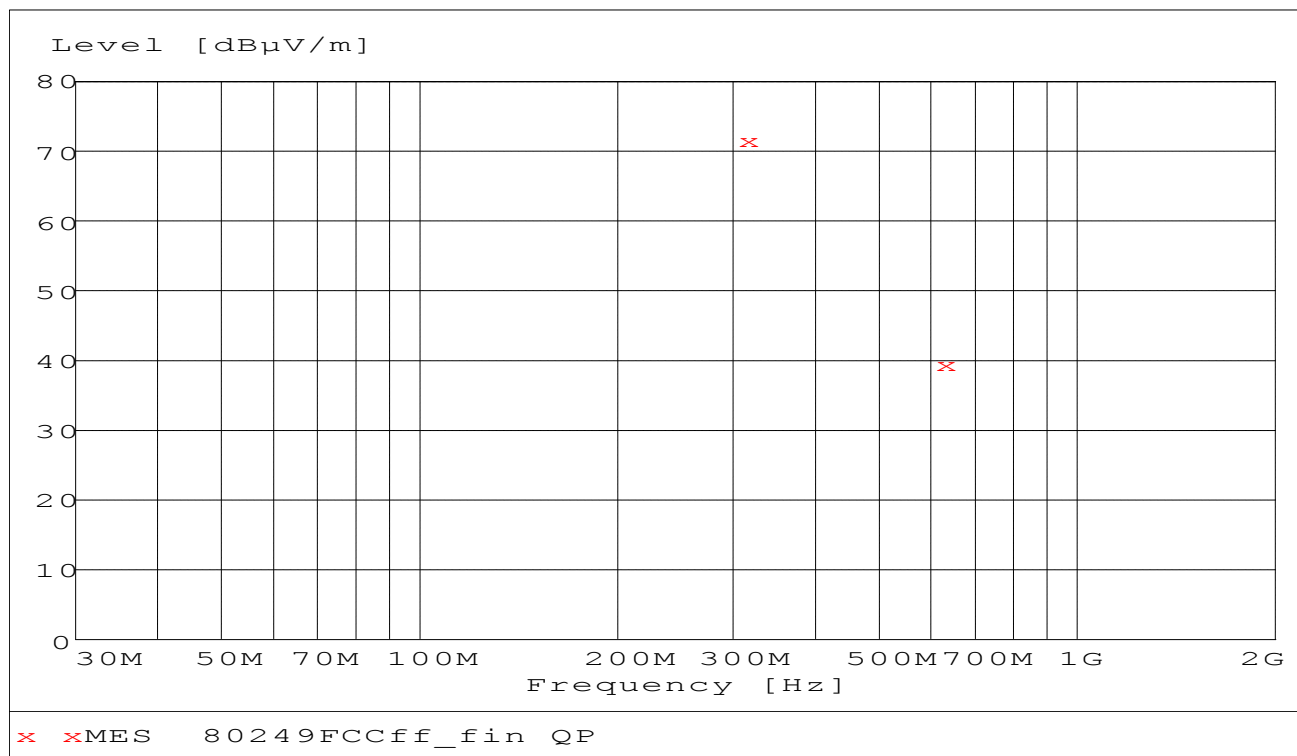

Data record name: 80249FCCff

TEST REPORT REFERENCE: R80249_B Edition 1

The results of the standard final measurement on the open area test site are indicated in the table below. The limits as well as the measured results (levels) refer to the above-mentioned standard while taking account of the specified requirements for a 3 m measuring distance.

The measurement time with the quasi-peak measuring detector is 1 second.

Result measured with the quasipeak detector:

(These values are marked in the above diagram by x)

Spurious emissions outside restricted bands										
Frequency	Result	Limit	Margin	Readings	Antenna factor	Cable loss	Height	Azimuth	Pol.	Pos.
MHz	dB μ V/m	dB μ V/m	dB	dB μ V	dB/m	dB	cm	deg		
315.034	71.7	75.6	3.9	56.7	13.1	1.9	101.0	198.0	Hor.	1
630.068	39.6	55.6	16.0	16.9	19.8	2.9	130.0	69.0	Hor.	1
Spurious emissions in restricted bands										
Frequency	Result	Limit	Margin	Readings	Antenna factor	Cable loss	Height	Azimuth	Pol.	Pos.
MHz	dB μ V/m	dB μ V/m	dB	dB μ V	dB/m	dB	cm	deg		
-	-	-	-	-	-	-	-	-	-	-
Measurement uncertainty				+2.2 dB / -3.6 dB						

The test results were calculated with the following formula:

$$\text{Result [dB}\mu\text{V/m]} = \text{reading [dB}\mu\text{V]} + \text{cable loss [dB]} + \text{antenna factor [dB/m]}$$

Test: Passed

TEST EQUIPMENT USED FOR THE TEST:

14 – 20

TEST REPORT REFERENCE: R80249_B Edition 1

5.1.4 FINAL MEASUREMENT (1 GHz to 3.2 GHz)

Ambient temperature	20 °C	Relative humidity	35 %
---------------------	-------	-------------------	------

- Position of EUT: The EUT was set-up on a non-conducting table of a height of 0.8 m. The distance between EUT and antenna was 3 m.
- Cable guide: No cables were connectable to the EUT. For further information of the EUT set-up refer to the pictures in annex A of this test report.
- Test record: During the test, the EUT transmits continuously with normal modulation. All results are shown in the following. The EUT was tested in three orthogonal directions, the documented results were the worst case emissions.
- Supply voltage: The EUT was supplied by the fully charged internal battery.
- Resolution bandwidth: For all measurements a resolution bandwidth of 1 MHz was used.

Result measured with the average detector:

Frequency GHz	Corr. value dBµV/m	Limit dBµV/m	Margin dB	Readings dBµV	Antenna factor 1/m	Preamp dB	Cable loss dB	Height cm	Pol.	Restr. Band	Pos.
1260.136	35.6	55.6	20.0	34.5	24.9	26.5	2.7	150	Hor.	No	1
1575.170	45.3	54.0	8.7	43.0	25.8	26.5	3.0	150	Hor.	Yes	1
1890.204	48.5	55.6	7.1	44.3	27.3	26.5	3.4	150	Hor.	No	1
2205.238	49.6	54.0	4.4	44.2	28.3	26.5	3.6	150	Hor.	Yes	1
2520.272	37.7	55.6	17.9	31.2	29.1	26.4	3.8	150	Hor.	No	1
2835.306	49.2	54.0	4.8	41.4	30.2	26.4	4.0	150	Hor.	Yes	1
3150.340	43.6	55.6	12.0	34.5	31.2	26.4	4.3	150	Vert.	No	2
Measurement uncertainty						+2.2 dB / -3.6 dB					

Test: Passed

TEST EQUIPMENT USED FOR THE TEST:

29, 31 – 37, 39, 43, 46, 49 – 51, 54

TEST REPORT REFERENCE: R80249_B Edition 1

5.2 BAND-EDGE COMPLIANCE

5.2.1 METHOD OF MEASUREMENT (BAND-EDGE COMPLIANCE (RADIATED))

The same test set-up as used for the final radiated emission measurement shall be used (refer also subclause 5.1.1 of this test report).

The following spectrum analyser settings shall be used:

- Span: Wide enough to capture the peak level of the emission on the channel closest to the band-edge, as well as any modulation products, which fall outside the assigned frequency band.
- Resolution bandwidth: 100 kHz.
- Video bandwidth: \geq the resolution bandwidth.
- Sweep: Auto.
- Detector function: Peak.
- Trace mode: Max hold.

After trace stabilisation the marker shall be set on the signal peak. The first display line has to be set on this value. The second display line has to be set 20 dB below the first line (or the peak marker). The frequency line shall be set on the edge of the assigned frequency band. Set the second marker on the emission at the band-edge, or on the highest modulation product outside of the band, if this level is higher than that at the band-edge. This frequency shall be measured with the EMI receiver as described in subclause 5.1.1 of this test report, but 100 kHz resolution bandwidth shall be used.

The measurement will be performed at the upper end of the assigned frequency band if applicable.

TEST REPORT REFERENCE: R80249_B Edition 1

5.2.2 TEST RESULT (BAND-EDGE COMPLIANCE (RADIATED))

Ambient temperature	20 °C	Relative humidity	35 %
---------------------	-------	-------------------	------

80249_7.wmf: Bandedge compliance (radiated):

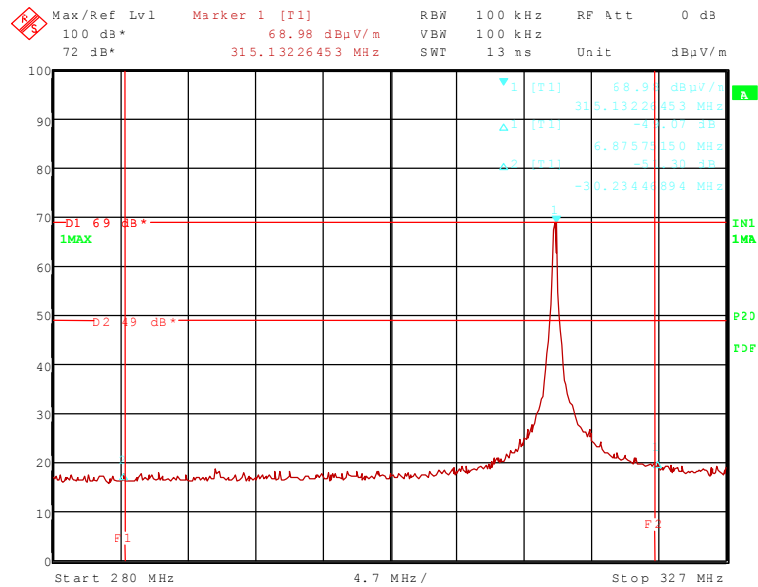

TEST REPORT REFERENCE: R80249_B Edition 1

The plot on the page before shows the radiated band-edge compliance for the upper and lower band-edge. The display line 1 (D1) in these plots represents the highest level within the assigned frequency band. The display line 2 (D2) represents the 20 dB offset to this highest level and shows the compliance with FCC 47 CFR Part 15.231 (b). The frequency lines 1 (F1) and 2 (F2) are showing the edges of the assigned or restricted frequency bands.

Band-edge compliance (lower band edge)										
Result measured with the quasi-peak detector:										
Frequency MHz	Corr. value dB μ V/m	Limit dB μ V/m	Margin dB	Readings dB μ V	Antenna factor 1/m	Preamp dB	Cable loss dB	Height cm	Pol.	Restr. Band
315.034	71.7	75.6	3.9	56.7	13.1	-	1.9	101.0	Hor.	No
284.626	20.4	46.0	25.6	5.7	12.8	-	1.9	101.0	Hor.	Yes
Measurement uncertainty							+2.2 dB / -3.6 dB			

Band-edge compliance (upper band edge)										
Result measured with the quasi-peak detector:										
Frequency MHz	Corr. value dB μ V/m	Limit dB μ V/m	Margin dB	Readings dB μ V	Antenna factor 1/m	Preamp dB	Cable loss dB	Height cm	Pol.	Restr. Band
315.034	71.7	75.6	3.9	56.7	13.1	-	1.9	101.0	Hor.	No
322.631	22.6	46.0	23.4	38.0	13.5	-	1.9	101.0	Hor.	Yes
Measurement uncertainty							+2.2 dB / -3.6 dB			

Test: Passed

TEST EQUIPMENT USED FOR THE TEST:

29, 31 – 34, 60 - 63

TEST REPORT REFERENCE: R80249_B Edition 1

5.3 20 dB BANDWIDTH

5.3.1 METHOD OF MEASUREMENT (20 dB BANDWIDTH)

The calibration of the spectrum analyser has to be checked with the help of a known signal from a signal generator. The EUT has to be connected to the spectrum analyser via a low loss cable. If the EUT is not equipped with an antenna connector, a temporary antenna connector has to be installed or a test fixture has to be used. The EUT has to be switched on, the transmitter shall work with its maximum data rate.

The following spectrum analyser settings shall be used:

- Span: App. 2 to 3 times the 20 dB bandwidth, centred on the actual hopping channel.
- Resolution bandwidth: $\geq 1\%$ of the 20 dB bandwidth.
- Video bandwidth: \geq the resolution bandwidth.
- Sweep: Auto.
- Detector function: peak.
- Trace mode: Max hold.

After trace stabilisation the marker shall be set on the signal peak. The first display line has to be set on this value. The second display line has to be set 20 dB below the first line (or the peak marker). The frequency lines shall be set on the intersection points between the second display line and the measured curve.

The measurement will be performed at the upper, the lower end and the middle of the assigned frequency band.

Test set-up:

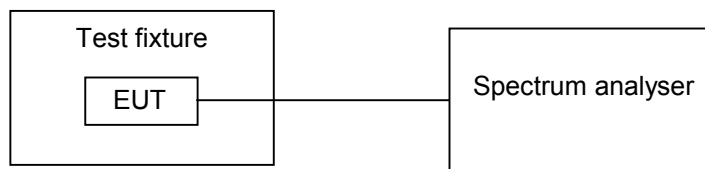

TEST REPORT REFERENCE: R80249_B Edition 1

5.3.2 TEST RESULTS (20 dB BANDWIDTH)

Ambient temperature	20 °C
---------------------	-------

Relative humidity	30 %
-------------------	------

80249_13.wmf: 20 dB Bandwidth:

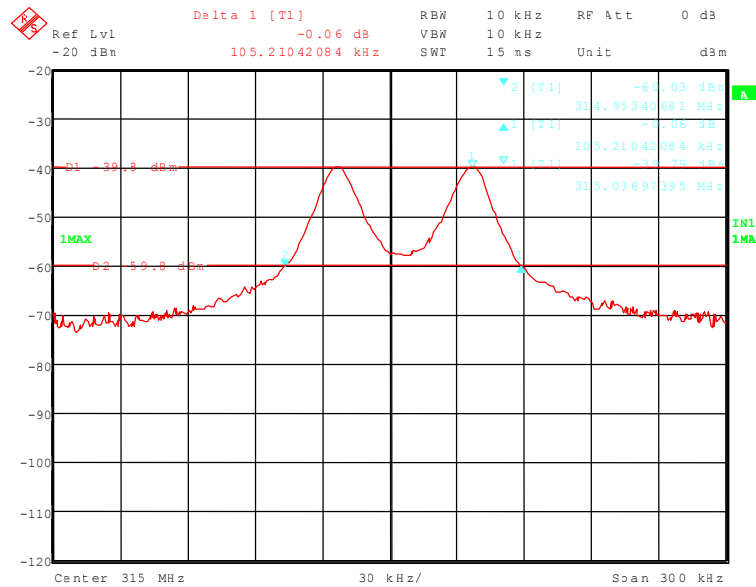

Lower frequency	Upper frequency	20 dB bandwidth	LIMIT (0.25 % of the center frequency)
314.953407 MHz	315.058617 MHz	105.210 kHz	787.585 kHz
Measurement uncertainty		+0.66 dB / -0.72 dB	

Test: Passed

TEST EQUIPMENT USED FOR THE TEST:

31, 58, 59

TEST REPORT REFERENCE: R80249_B Edition 1

5.4 TRANSMITTER RELEASE TIME

5.4.1 METHOD OF MEASUREMENT (TRANSMITTER RRELEASE TIME)

The calibration of the spectrum analyser has to be checked with the help of a known signal from a signal generator. The EUT has to be connected to the spectrum analyser via a low loss cable. If the EUT is not equipped with an antenna connector, a temporary antenna connector has to be installed or a test fixture has to be used. The EUT has to be switched on, the transmitter shall work with its maximum data rate.

The following spectrum analyser settings shall be used:

- Span: = Hz.
- Resolution bandwidth: 1 MHz.
- Video bandwidth: \geq the resolution bandwidth.
- Sweep: Single sweep with 15 secondes.
- Detector function: peak.
- Trace mode: Max hold.

The frequency line shall be set a point, were the transmitter will be released. The sweep shall start, when the transmitter started to operate, The transmitter shall released when the trance crosses the frequency line. One marker shall be set to the point of the frequency line, a delta marker to the time, were the transmitter stopped transmission.

Test set-up:

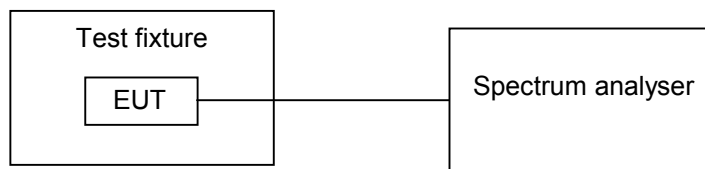

TEST REPORT REFERENCE: R80249_B Edition 1

5.4.2 TEST RESULTS (TRANSMITTER RELEASE TIME)

Ambient temperature	20 °C	Relative humidity	30 %
---------------------	-------	-------------------	------

80249_17.wmf: Transmitter release time:

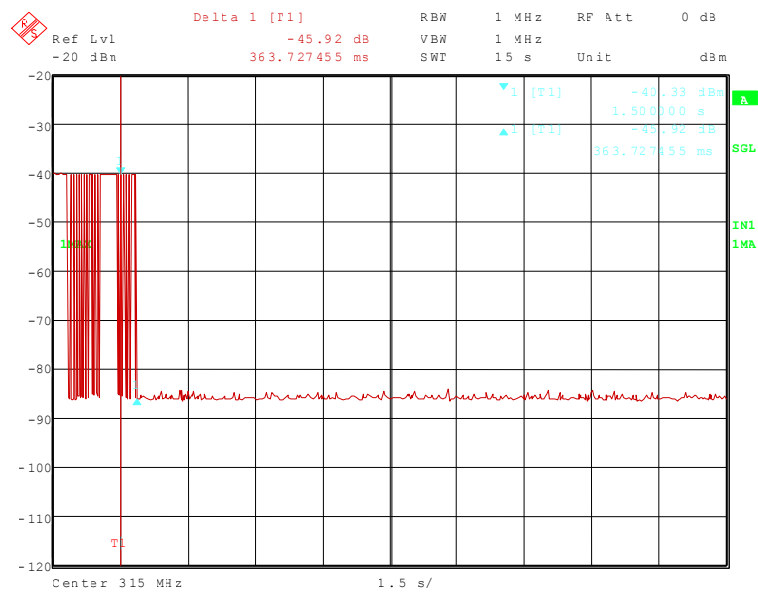

Transmitter release time	LIMIT
353.727 ms	5 s
Measurement uncertainty	<10 ⁻⁷

Test: Passed

TEST EQUIPMENT USED FOR THE TEST:

31, 58, 59

TEST REPORT REFERENCE: R80249_B Edition 1

6 TEST EQUIPMENT AND ANCILLARIES USED FOR TESTS

TEST REPORT REFERENCE: R80249_B Edition 1

No.	Test equipment	Type	Manufacturer	Serial No.	PM. No.	Cal. Date	Cal. due
1	Shielded chamber M4	-	Siemens	B83117S1-X158	480088	Weekly verification (system cal.)	
2	Measuring receiver	ESAI	Rohde & Schwarz	831953/001 833181/018	480025 480026	03/05/2007	02/2008
3	LISN	NSLK8128	Schwarzbeck	8128155	480058	01/09/2008	01/2009
5	AC-filter	B84299-D87-E3	Siemens	930262292	480097	Weekly verification (system cal.)	
6	EMI-Software	ES-K1	Rohde & Schwarz	-	480111	-	-
14	Open area test site	-	Phoenix Test-Lab	-	480085	Weekly verification (system cal.)	
15	Measuring receiver	ESCS30	Rohde & Schwarz	828985/014	480270	02/27/2008	02/2010
16	Controller	HD100	Deisel	100/670	480139	-	-
17	Turntable	DS420HE	Deisel	420/620/80	480087	-	-
18	Antenna support	AS615P	Deisel	615/310	480086	-	-
19	Antenna	CBL6111 A	Chase	1643	480147	08/01/2007	08/2012
20	EMI Software	ES-K1	Rohde & Schwarz	-	480111	-	-
29	Fully anechoic chamber M20	-	Albatross Projects	B83107-E2439-T232	480303	Weekly verification (system cal.)	
31	Measuring receiver	ESI 40	Rohde & Schwarz	100064	480355	02/16/2006	02/2008
32	Controller	HD100	Deisel	100/670	480326	-	-
33	Turntable	DS420HE	Deisel	420/620/80	480315	-	-
34	Antenna support	AS615P	Deisel	615/310	480187	-	-
35	Antenna	CBL6112 B	Chase	2688	480328	10/11/2005	10/2010
43	RF-cable No. 30	RTK 081	Rosenberger	-	410141	Weekly verification (system cal.)	
54	Power supply	TOE 8852	Toellner	51712	480233	11/27/2006	11/2008
56	Loop antenna	HFH2-Z2	Rohde & Schwarz	832609/014	480059	03/15/2006	03/2011
57	EMI test receiver	ESPC	Rohde & Schwarz	843756/006	480150	02/21/2006	02/2008
58	Test fixture	-	Phoenix Test-Lab	-	410160	Weekly verification	
59	RF-cable No. 10	RG223	Phoenix-Test-Lab	-	410102	Weekly verification	
60	Horn Antenna	3115 A	EMCO	9609-4918	480183	08/04/03	08/2008
61	High Pass Filter	WHJS1000C 11/60EF	Wainwright Instruments GmbH	1	480413	12/07/07	12/2008
62	Preamplifier	JS3- 00101200- 23-5A	Miteq	681851	480337	12/07/07	12/2008
63	RF-cable No. 31	RTK 081	Rosenberger	-	410142	Weekly verification	

TEST REPORT REFERENCE: R80249_B Edition 1

7 LIST OF ANNEXES

ANNEX A	PHOTOGRAPHS OF THE TEST SET-UPS:	6 pages
	R56 Mini, test setup fully anechoic chamber (pos.1)	80249_4.jpg
	R56 Mini, test setup fully anechoic chamber (pos.2)	80249_8.jpg
	R56 Mini, test setup fully anechoic chamber	80249_13.jpg
	R56 Mini, test setup fully anechoic chamber	80249_10.jpg
	R56 Mini, test setup fully anechoic chamber	80249_7.jpg
	R56 Mini, test setup open area test site	80249_12.jpg
ANNEX B	EXTERNAL PHOTOGRAPHS OF THE TEST SAMPLE:	6 pages
	R56 Mini, front view	80249_e.jpg
	R56 Mini, rear view	80249_f.jpg
	R56 Mini, left hand view	80249_a.jpg
	R56 Mini, right hand view	80249_b.jpg
	R56 Mini, top view	80249_c.jpg
	R56 Mini, bottom view	80249_d.jpg
ANNEX C	INTERNAL PHOTOGRAPHS OF THE TEST SAMPLE:	4 pages
	R56 Mini, internal view	80249_g.jpg
	R56 Mini, PCB, top view	80249_i.jpg
	R56 Mini, PCB, top view, battery removed	80249_j.jpg
	R56 Mini, PCB, bottom view	80249_h.jpg
ANNEX D	ADDITIONAL MEASUREMENT RESULTS FOR INDUSTRY CANADA:	2 pages