

Test Report

Report Number:

F161755E6

Equipment under Test (EUT):

**Vehicle key
DC12A**

Applicant:

Marquardt GmbH

Manufacturer:

Marquardt GmbH



Deutsche
Akkreditierungsstelle
D-PL-17186-01-01
D-PL-17186-01-02
D-PL-17186-01-03



References

- [1] **ANSI C63.10: 2013** American National Standard of Procedures for Compliance Testing of Unlicensed Wireless Devices
- [2] **FCC 47 CFR Part 15 (January 31, 2017)** Radio Frequency Devices
- [3] **RSS-210 Issue 9 (August 2016)** Low-power Licence-exempt Radiocommunication Devices (All Frequency Bands): Category I Equipment
- [4] **RSS-Gen Issue 4 (November 2014)** General Requirements and Information for the Certification of Radiocommunication Equipment
- [5] **ANSI C63.4:2014** American National Standard for Methods of Measuring of Radio-Noise Emissions from Low-Voltage Electrical and Electronic Equipment in the Range of 9 kHz to 40 GHz.

Test result

The requirements of the tests performed as shown in the overview (clause 4) were fulfilled by the equipment under test.

The complete test results are presented in the following.

Test engineer:	Wolfgang KASALOWSKY		16.03.2017
	Name	Signature	Date
Authorized reviewer:	Bernd STEINER		16.03.2017
	Name	Signature	Date

This test report is only valid in its original form.

Any reproduction of its contents in extracts without written permission of the accredited test laboratory PHOENIX TESTLAB GmbH is prohibited.

The test results herein refer only to the tested sample. PHOENIX TESTLAB GmbH is not responsible for any generalisations or conclusions drawn from these test results concerning further samples. Any modification of the tested samples is prohibited and leads to the invalidity of this test report. Each page necessarily contains the PHOENIX TESTLAB Logo and the TEST REPORT NUMBER.

This test report is valid in hardcopy form as well as in electronic form.

Contents:		Page
1	Identification.....	4
1.1	Applicant.....	4
1.2	Manufacturer.....	4
1.3	Test laboratory.....	4
1.4	EUT (Equipment Under Test).....	5
1.5	Technical data of equipment.....	5
1.6	Dates.....	6
2	Operational states.....	7
3	Additional information.....	7
4	Overview.....	8
5	Results.....	9
5.1	20 dB bandwidth.....	9
5.1.1	Method of measurement.....	9
5.1.2	Test result.....	10
5.2	99 % bandwidth.....	11
5.2.1	Method of measurement.....	11
5.2.2	Test result.....	12
5.3	Transmission time control.....	13
5.3.1	Method of measurement.....	13
5.3.2	Test result.....	14
5.4	Radiated emissions.....	15
5.4.1	General method of measurement.....	15
5.4.2	Test results.....	22
5.4.2.1	Preliminary radiated emission measurement (9 kHz to 4 GHz).....	22
5.4.2.2	Final radiated emission measurement (9 kHz to 30 MHz).....	27
5.4.2.3	Final radiated emission measurement (30 MHz to 1 GHz).....	27
5.4.2.4	Final radiated emission measurement (1 GHz to 4 GHz).....	29
5.5	Radiated emissions (receiver).....	31
5.5.1	Method of measurement.....	31
5.5.2	Test results.....	31
5.5.2.1	Preliminary radiated emission measurement (30 MHz to 2 GHz).....	31
5.5.2.2	Final radiated emission measurement (30 MHz to 2 GHz).....	32
6	Test Equipment used for Tests.....	33
7	Report History.....	34
8	List of Annexes.....	34

1 Identification

1.1 Applicant

Name:	Marquardt GmbH
Address:	Schloßstraße 16 78604 Rietheim - Weilheim
Country:	Germany
Name for contact purposes:	Mr. Gerd SIEGEL
Phone:	+49 7424 99-1589
Fax:	+49 7424 99-2122
eMail Address:	gerd.siegel@marquardt.de
Applicant represented during the test by the following person:	-

1.2 Manufacturer

Name:	Marquardt GmbH
Address:	Schloßstraße 16 78604 Rietheim - Weilheim
Country:	Germany
Name for contact purposes:	Mr. Gerd SIEGEL
Phone:	+49 7424 99-1589
Fax:	+49 7424 99-2122
eMail Address:	gerd.siegel@marquardt.de
Manufacturer represented during the test by the following person:	-

1.3 Test laboratory

The tests were carried out at: **PHOENIX TESTLAB GmbH**
Königswinkel 10
32825 Blomberg
Germany

accredited by Deutsche Akkreditierungsstelle GmbH (DAkKS) in compliance with DIN EN ISO/IEC 17025 under Reg. No. D-PL-17186-01-02, FCC Test Firm Accreditation with the registration number 469623, designation number DE0004 and Industry Canada Test site registration SITE# IC3469A-1

1.4 EUT (Equipment Under Test)

Test object:	Vehicle key
Model / HVIN / PMN:	DC12A
Serial number:	Test mode: #351 Normal mode: #301
PCB identifier:	243.088.011-01
Hardware version:	V3.1[16/47/00]
Software version / FVIN:	V9.0[16/44/00]
FCC ID:	IYZ-DC12A
IC:	2701A-DC12A

1.5 Technical data of equipment

Vehicle key:	DC12A		
Power supply:	Lithium battery CR2025		
Supply voltage:	$U_{nom} = 3.0 V_{DC}$	$U_{min} = 2.55 V_{DC}$	$U_{max} = 3.0 V_{DC}$
Temperature range:	-20 °C to +65 °C		
RF part:			
Duty cycle class:*	Manual triggered device		
Channel spacing: *	450 kHz (three channel operation)		
Operating Frequencies:	314.00 MHz / 314.45 MHz / 314.90 MHz		
Transmitter power:	-16 dBm to -22dBm		
Modulation:	2FSK		
Frequency deviation:	± 10 kHz		
Data rate:	10kBit/s		
Antenna:	integrated PCB-Loop antenna		
LF receiver			
Operating frequency:	21.85 kHz		
Number of channels:	1		
Type of modulation:	BPSK		
Data rate:	5.4 kBit/s		
Antenna type:	3D-Axis-Coil, Rx at all axis		

1.6 Dates

Date of receipt of test sample:	11.11.2016
Start of test:	03.01.2017
End of test:	19.01.2017

2 Operational states

The DC12A is the car key of a driving authorisation system of a car which further comprises of a body controller module, depending on the application. An external antenna module communicates with the car key over RF, and with the body controller unit over a bus system.

The components exchange encrypted data for car access, to start the engine and to locate the key. Object of this test report is the UHF transceiver of the EUT.

The DC12A contains three buttons for car access, to open and to lock the doors and to open the trunk deck.

Optional the car can be accessed without handling the key. In this case RF signals are exchanged bidirectional when touching the door handle.

In case the battery is low car access is possible by means of an integrated mechanic emergency key. The DC12A is then to be put into the ignition lock to communicate by means of the integrated infrared terminal.

Test mode:

In test mode the EUT is transmitting or receiving continuously with a duty cycle of 100%.

	Button 1 Open	Button 2 Close	Button 3 Trunk
Short button press	Lower frequency fu (FSK low with no modulation) transmitting at 314.00 MHz	Lower frequency fu (FSK low with no modulation) transmitting at 314.45 MHz	Lower frequency fu (FSK low with no modulation) transmitting at 314.90 MHz
Long button press	Modulation 10kBd (FSK) transmitting at 314.00 MHz	Modulation 10kBd (FSK) transmitting at 314.45 MHz	Modulation 10kBd (FSK) transmitting at 314.90 MHz
Two times short button press	Continuous receiver operation at 314.00 MHz (keyless go only DC12K)	Continuous receiver operation at 314.45 MHz (keyless go only DC12K)	Continuous receiver operation at 314.90 MHz (keyless go only DC12K)

3 Additional information

The LF receiver is receiving at all times. Therefore the spurious emissions of the LF receiver and the RF receiver were measured together.

4 Overview

Application	Frequency range [MHz]	FCC 47 CFR Part 15 section [2]	RSS 210, Issue 9 [3] or RSS-Gen, Issue 4 [4]	Status	Refer page
Occupied bandwidth	314.00 to 314.90	15.231 (c)	A1.3 [3]	Passed	9 et seq.
Transmission time control	314.00 to 314.90	15.231 (a) (1)	A1.1 (a) [3]	Passed	13 et seq.
Radiated emissions	0.009 – 4000	15.231 (b) 15.205 (a) 15.209 (a)	A1.2 [3] 4.1 [3] 6.13 [4]	Passed	15 et seq.
Radiated emissions (receiver)	30 - 2000	15.109 (a)	7.1 [4]	Passed	31 et seq.

5 Results

5.1 20 dB bandwidth

5.1.1 Method of measurement

The calibration of the spectrum analyser has to be checked with the help of a known signal from a signal generator. The EUT has to be connected to the spectrum analyser via a low loss cable. If the EUT is not equipped with an antenna connector, a temporary antenna connector has to be installed or a test fixture has to be used. The EUT has to be switched on; the transmitter shall work with its maximum data rate.

The following spectrum analyser settings shall be used:

- Span: App. 2 to 3 times the 20 dB bandwidth, centred on the actual channel.
- Resolution bandwidth: Between 1 % to 5 % of the required bandwidth, if no requirements were made, the following minimum values shall be used:
From 9 kHz to 30 MHz: $RBW_{min} = 1 \text{ kHz}$;
from 30 MHz to 1000: MHz $RBW_{min} = 10 \text{ kHz}$;
and from 1000 MHz to 40 GHz: $RBW_{min} = 100 \text{ kHz}$.
- Video bandwidth: \geq the resolution bandwidth.
- Sweep: Auto.
- Detector function: peak.
- Trace mode: Max hold.

After trace stabilisation the marker shall be set on the signal peak. The first display line has to be set on this value. The second display line has to be set 20 dB below the first line (or the peak marker). The frequency lines shall be set on the intersection points between the second display line and the measured curve.

The measurement will be performed at the middle of the assigned frequency band.

Test set-up: Measurement was performed in an anechoic chamber with a EUT in test mode.

5.1.2 Test result

Ambient temperature	22 °C
---------------------	-------

Relative humidity	26 %
-------------------	------

161755 20dB BW 314,45M.wmf: 20 dB Bandwidth @ channel 2 (314.45 MHz):

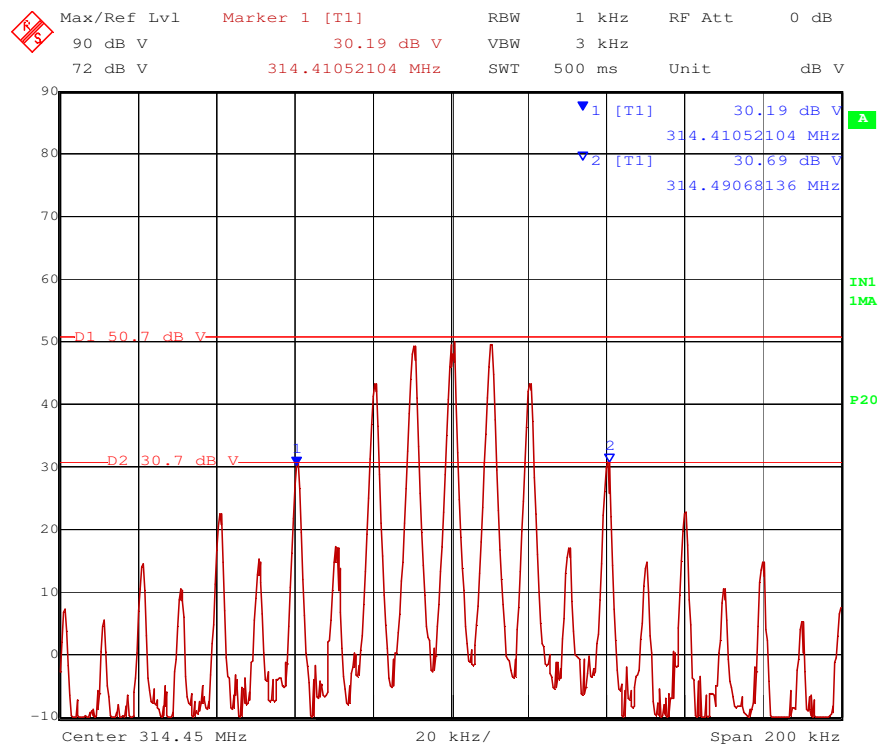

Lower frequency [MHz]	Upper frequency	20 dB bandwidth	LIMIT (0.25 % of the center frequency)
314.410521 MHz	314.490681 MHz	80.160 kHz	786.125 kHz
Measurement uncertainty: <math> < 10^{-7}</math> (frequency), 0.66 dB / -0.72 dB (level)			

Test: Passed

Test equipment (please refer chapter 6 for details)

31, 38

5.2 99 % bandwidth

5.2.1 Method of measurement

- The transmitter shall be operated at its maximum carrier power measured under normal test conditions.
- The span of the analyzer shall be set to capture all products of the modulation process, including the emission skirts.
- The resolution bandwidth (RBW) shall be in the range of 1 % to 5 % of the occupied bandwidth (OBW) and video bandwidth (VBW) shall be approximately 3x RBW.

Note: Video averaging is not permitted.

A peak, or peak hold, may be used in place of the sampling detector as this may produce a wider bandwidth than the actual bandwidth (worst-case measurement). Use of a peak hold may be necessary to determine the occupied bandwidth if the device is not transmitting continuously.

The trace data points are recovered and are directly summed in linear power level terms. The recovered amplitude data points, beginning at the lowest frequency, are placed in a running sum until 0.5 % of the total is reached and that frequency recorded. The process is repeated for the highest frequency data points (starting at the highest frequency, at the right side of the span, and going down in frequency). This frequency is then recorded.

The difference between the two recorded frequencies is the 99 % occupied bandwidth.

Test set-up: Measurement was performed in an anechoic chamber with a EUT in test mode.

5.2.2 Test result

Ambient temperature	22 °C	Relative humidity	26 %
---------------------	-------	-------------------	------

161755_99%BW_314.45M.wmf: 99%-Bandwidth @ channel 2 (314.45MHz):

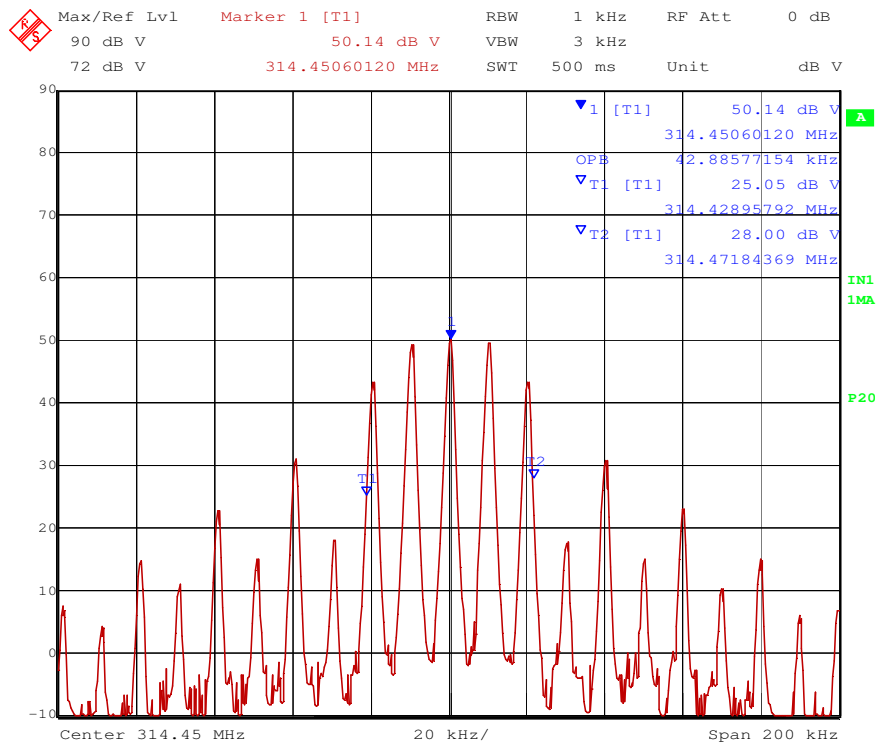

Lower frequency [MHz]	Upper frequency	99 % bandwidth	LIMIT (0.25 % of the center frequency)
314.428958 MHz	314.471844 MHz	42.886 kHz	786.125 kHz
Measurement uncertainty: <math><10^{-7}</math> (frequency), 0.66 dB / -0.72 dB (level)			

Test: Passed

Test equipment (please refer chapter 6 for details)

31, 38

5.3 Transmission time control

5.3.1 Method of measurement

1. The calibration of the spectrum analyser has to be checked with the help of a known signal from a signal generator. The EUT has to be connected to the spectrum analyser via a low loss cable. If the EUT is not equipped with an antenna connector, a temporary antenna connector has to be installed or a test fixture has to be used. The EUT has to be switched on, the transmitter shall work with its maximum data rate.

The following spectrum analyser settings shall be used:

- Span: = 0 Hz.
- Resolution bandwidth: 1 MHz.
- Video bandwidth: \geq the resolution bandwidth.
- Sweep: Single sweep with at least 5 seconds.
- Detector function: peak.
- Trace mode: Max hold.

The frequency line shall be set a point, were the transmitter will be released. The sweep shall start, when the transmitter started to operate, The transmitter shall released when the trace crosses the frequency line. One marker shall be set to the point of the frequency line, a delta marker to the time, were the transmitter stopped transmission.

-

Test set-up:

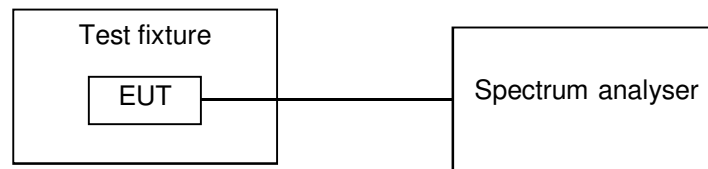

5.3.2 Test result

Ambient temperature	22 °C	Relative humidity	26 %
---------------------	-------	-------------------	------

The EUT starts transmitting as soon as a button is pressed.
 The duration of transmission is independent from the moment when the key is released.
 Therefore the worst case for the transmitter release time is releasing the button immediately after pressing the button.

Measurement was performed with a EUT in normal mode.

161755_pulse1_314.9M.png: Transmitter release time:

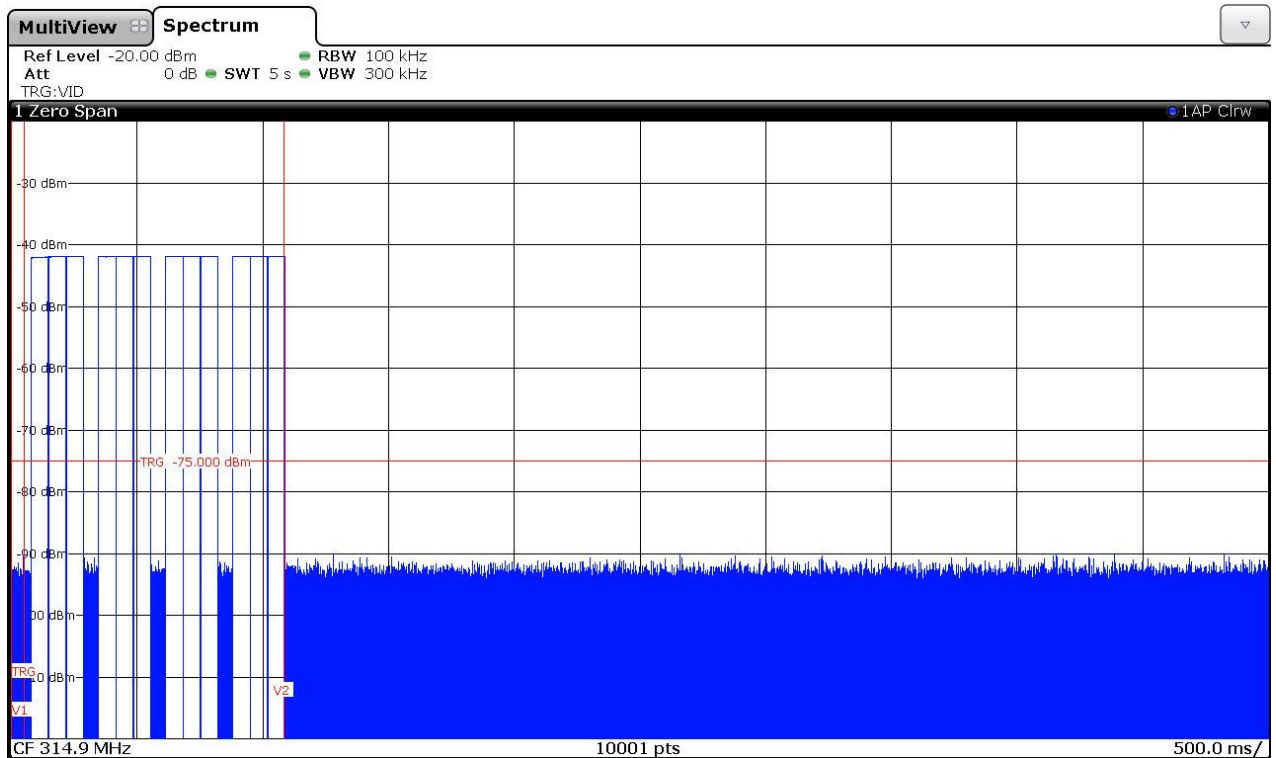

Transmitter release time	LIMIT
1036 ms	5 s
Measurement uncertainty	$<10^{-7}$

Test: Passed

Test equipment (please refer chapter 6 for details)

31, 38

5.4 Radiated emissions

5.4.1 General method of measurement

The radiated emission measurement is subdivided into five stages.

- A preliminary measurement carried out in a fully anechoic chamber with a fixed antenna height in the frequency range 9 kHz to 1 GHz.
- A final measurement carried out on an outdoor test site without reflecting ground plane and a fixed antenna height in the frequency range 9 kHz to 30 MHz.
- A final measurement carried out on an open area test site with reflecting ground plane and various antenna height in the frequency range 30 MHz to 1 GHz.
- A preliminary measurement carried out in a fully anechoic chamber with a variable antenna distance and height in the frequency range 1 GHz to 25 / 40 GHz.
- A final measurement carried out in a fully anechoic chamber with a fixed antenna height in the frequency range 1 GHz to 40 GHz.

Preliminary measurement (9 kHz to 30 MHz):

In the first stage a preliminary measurement will be performed in a shielded room with a measuring distance of 3 meters. Table-top devices will set up on a non-conducting support with a size of 1 m by 1.5 m and a height of 80 cm. Floor-standing devices will be placed directly on the turntable/ground plane. The set-up of the Equipment under test will be in accordance to [1].

The frequency range 9 kHz to 30 MHz will be monitored with a spectrum analyser while the system and its cables will be manipulated to find out the configuration with the maximum emission levels if applicable. The EMI Receiver will be set to MAX Hold mode. The EUT and the measuring antenna will be rotated around their vertical axis to found the maximum emissions.

The resolution bandwidth of the spectrum analyser will be set to the following values:

Frequency range	Resolution bandwidth
9 kHz to 150 kHz	300 Hz
150 kHz to 30 MHz	10 kHz

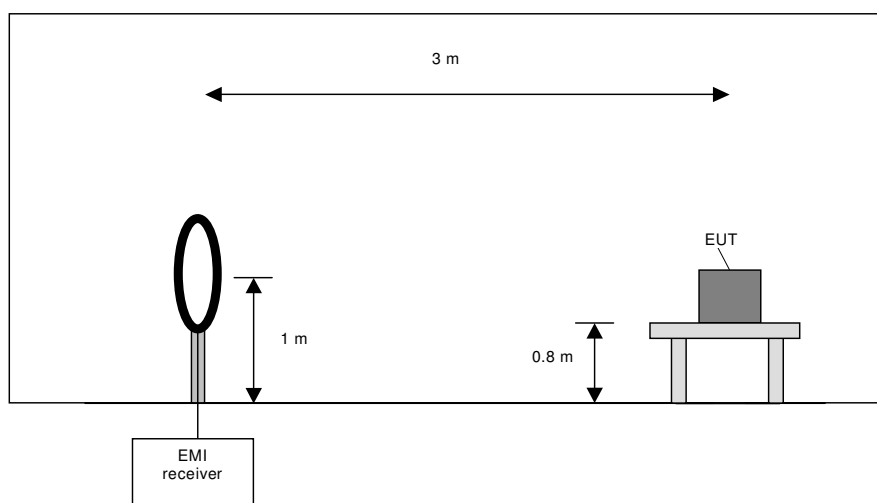

Preliminary measurement procedure:

Prescans were performed in the frequency range 9 kHz to 150 kHz and 150 kHz to 30 MHz.

The following procedure will be used:

- 1) Monitor the frequency range at horizontal polarisation and a EUT azimuth of 0 °.
- 2) Manipulate the system cables within the range to produce the maximum level of emission.
- 3) Rotate the EUT by 360 ° to maximize the detected signals.
- 4) Make a hardcopy of the spectrum.
- 5) Measure the frequencies of highest detected emission with a lower span and resolution bandwidth to increase the accuracy and note the frequency value.
- 6) Repeat steps 1) to 5) with the other orthogonal axes of the EUT (because of EUT is a module and might be used in a handheld equipment application).
- 7) Rotate the measuring antenna and repeat steps 1) to 5).

Final measurement (9 kHz to 30 MHz):

In the second stage a final measurement will be performed on an open area test site with no conducting ground plane in a measuring distances of 3 m, 10 m and 30 m. In the case where larger measuring distances are required the results will be extrapolated based on the values measured on the closer distances according to Section 15.31 (f) (2) [2]. The final measurement will be performed with a EMI Receiver set to Quasi Peak detector except for the frequency bands 9 kHz to 90 kHz and 110 kHz to 490 kHz where an average detector will be used according Section 15.209 (d) [2].

On the frequencies, which were detected during the preliminary measurements, the final measurement will be performed while rotating the EUT and the measuring antenna in the range of 0 ° to 360 ° around their vertical axis until the maximum value is found.

The resolution bandwidth of the EMI Receiver will be set to the following values:

Frequency range	Resolution bandwidth
9 kHz to 150 kHz	200 Hz
150 kHz to 30 MHz	9 kHz

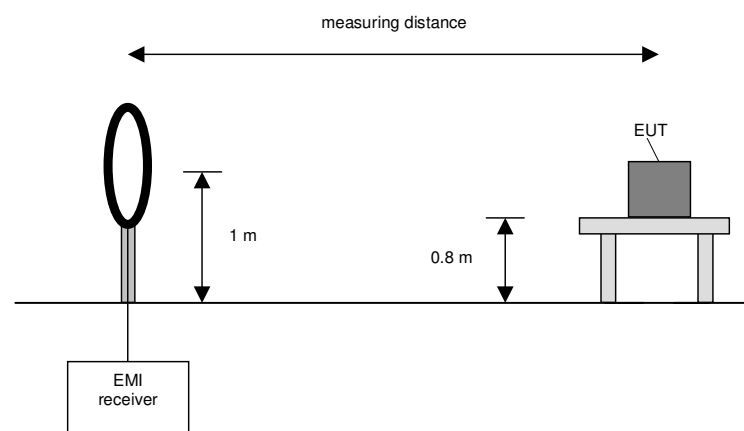

Final measurement procedure:

The following procedure will be used:

- 1) Monitor the frequency range with the measuring antenna at vertical orientation parallel to the EUT at an azimuth of 0 °.
- 2) Rotate the EUT by 360 ° to maximize the detected signals and note the azimuth and orientation.
- 3) Rotate the measuring antenna to find the maximum and note the value.
- 4) Rotate the measuring antenna and repeat steps 1) to 3) until the maximum value is found.
- 5) Repeat steps 1) to 4) with the other orthogonal axes of the EUT (if the EUT is a module and might be used in a handheld equipment application).

Preliminary measurement (30 MHz to 1 GHz)

In the first stage a preliminary measurement will be performed in a fully anechoic chamber with a measuring distance of 3 meter. Table top devices will set up on a non-conducting turn device on the height of 1.5 m. Floor-standing devices will be placed directly on the turntable/ground plane. The set-up of the Equipment under test will be in accordance to [1].

The frequency range 30 MHz to 1 GHz will be measured with an EMI Receiver set to MAX Hold mode and a resolution bandwidth of 100 kHz. The measurement will be performed in horizontal and vertical polarisation of the measuring antenna and while rotating the EUT in its vertical axis in the range of 0 ° to 360 °. This measurement is repeated after raising the EUT in 30 ° steps according 6.6.5.4 in [1].

The resolution bandwidth of the EMI Receiver will be set to the following values:

Frequency range	Resolution bandwidth
30 MHz to 230 MHz	100 kHz
230 MHz to 1 GHz	100 kHz

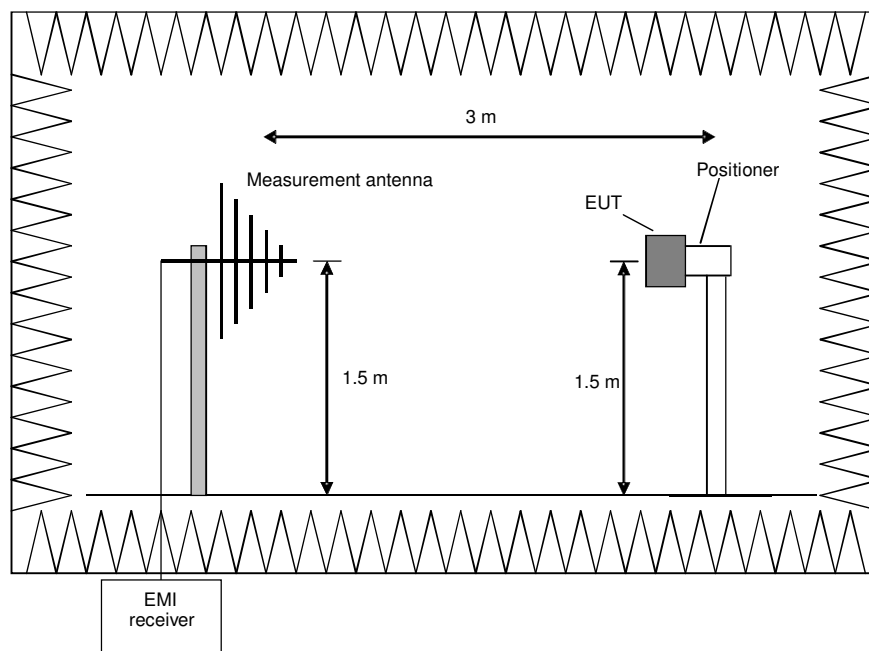

Procedure preliminary measurement:

Prescans were performed in the frequency range 30 MHz to 230 MHz and 230 MHz to 1 GHz.
The following procedure will be used:

1. Monitor the frequency range at horizontal polarisation and a EUT azimuth of 0 °.
2. Manipulate the system cables within the range to produce the maximum level of emission.
3. Rotate the EUT by 360 ° to maximize the detected signals.
4. Repeat 1) to 3) with the vertical polarisation of the measuring antenna.
5. Make a hardcopy of the spectrum.
6. Repeat 1) to 5) with the EUT raised by an angle of 30 ° (60 °, 90 °, 120 ° and 150 °) according to 6.6.5.4 in [1].
7. Measure the frequency of the detected emissions with a lower span and resolution bandwidth to increase the accuracy and note the frequency value.

Final measurement (30 MHz to 1 GHz)

A final measurement on an open area test site will be performed on selected frequencies found in the preliminary measurement. During this test the EUT will be rotated in the range of 0 ° to 360 °, the measuring antenna will be set to horizontal and vertical polarisation and raised and lowered in the range from 1 m to 4 m to find the maximum level of emissions.

The resolution bandwidth of the EMI Receiver will be set to the following values:

Frequency range	Resolution bandwidth
30 MHz to 1 GHz	120 kHz

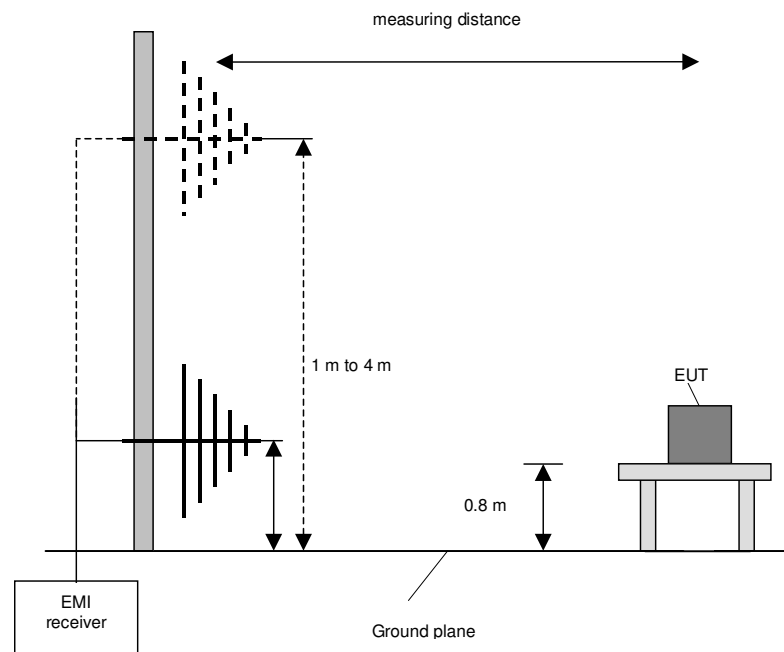

Procedure final measurement:

The following procedure will be used:

- 1) Measure on the selected frequencies at an antenna height of 1 m and a EUT azimuth of 23 °.
- 2) Move the antenna from 1 m to 4 m and note the maximum value at each frequency.
- 3) Rotate the EUT by 45 ° and repeat 2) until an azimuth of 337 ° is reached.
- 4) Repeat 1) to 3) for the other orthogonal antenna polarization.
- 5) Move the antenna and the turntable to the position where the maximum value is detected.
- 6) Measure while moving the antenna slowly +/- 1 m.
- 7) Set the antenna to the position where the maximum value is found.
- 8) Measure while moving the turntable +/- 45 °.
- 9) Set the turntable to the azimuth where the maximum value is found.
- 10) Measure with Final detector (QP and AV) and note the value.
- 11) Repeat 5) to 10) for each frequency.
- 12) Repeat 1) to 11) for each orthogonal axes of the EUT (because of EUT is a module and might be used in a handheld equipment application).

Preliminary and final measurement (1 GHz to 40 GHz)

This measurement will be performed in a fully anechoic chamber. Table top devices will set up on a non-conducting turn device on the height of 1.5 m. The set-up of the Equipment under test will be in accordance to [1].

Preliminary measurement (1 GHz to 40 GHz)

The frequency range will be divided into different sub ranges depending of the frequency range of the used horn antenna. The spectrum analyser set to MAX Hold mode and a resolution bandwidth of 100 kHz. The measurement will be performed in horizontal and vertical polarisation of the measuring antenna and while rotating the EUT in its vertical axis in the range of 0 ° to 360 °. This measurement is repeated after raising the EUT in 30 ° steps according 6.6.5.4 in [1].

The resolution bandwidth of the EMI Receiver will be set to the following values:

Frequency range	Resolution bandwidth
1 GHz to 4 GHz	100 kHz
4 GHz to 12 GHz	100 kHz
12 GHz to 18 GHz	100 kHz
18 GHz to 25 / 26.5 GHz	100 kHz
26.5 GHz to 40 GHz	100 kHz

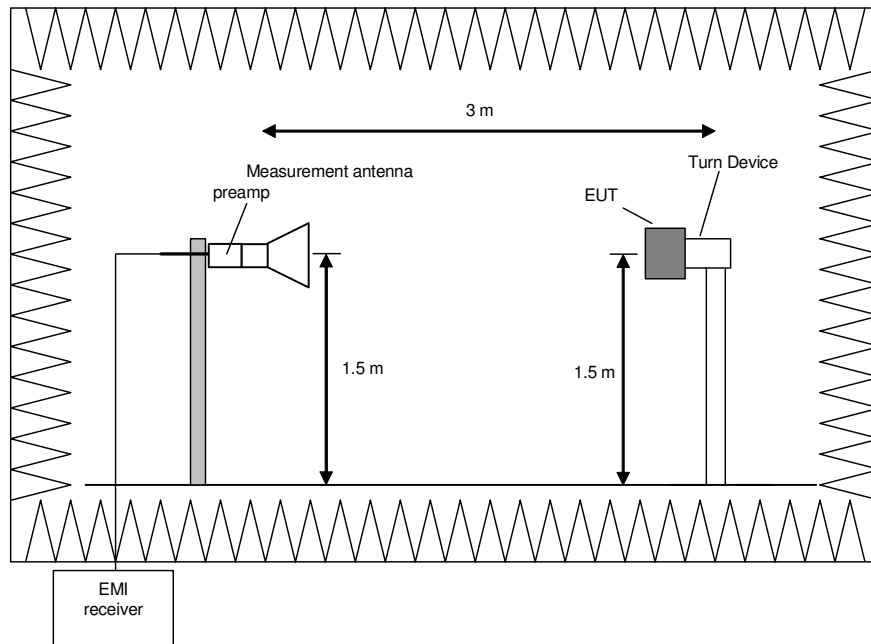

Procedure preliminary measurement:

Prescans were performed in the frequency range 1 to 40 GHz.

The following procedure will be used:

1. Monitor the frequency range at horizontal polarisation and a EUT azimuth of 0 °.
2. Rotate the EUT by 360° to maximize the detected signals.
3. Repeat 1) to 2) with the vertical polarisation of the measuring antenna.
4. Make a hardcopy of the spectrum.
5. Repeat 1) to 4) with the EUT raised by an angle of 30° (60°, 90°, 120° and 150°) according to 6.6.5.4 in [1].
6. Measure the frequency of the detected emissions with a lower span and resolution bandwidth to increase the accuracy and note the frequency value.
7. The measurement antenna polarisation, with the according EUT position (Turntable and Turn device) which produces the highest emission for each frequency will be used for the final measurement. The six closest values to the applicable limit will be used for the final measurement.

Final measurement (1 GHz to 40 GHz)

The frequency range will be divided into different sub ranges depending of the frequency range of the used horn antenna. The EMI Receiver set to peak and average mode and a resolution bandwidth of 1 MHz. The measurement will be performed by rotating the turntable through 0 to 360° in the worst-case EUT orientation which was obtained during the preliminary measurements.

The resolution bandwidth of the EMI Receiver will be set to the following values:

Frequency range	Resolution bandwidth
1 GHz to 4 GHz	1 MHz
4 GHz to 12 GHz	1 MHz
12 GHz to 18 GHz	1 MHz
18 GHz to 25 / 26.5 GHz	1 MHz
26.5 GHz to 40 GHz	1 MHz

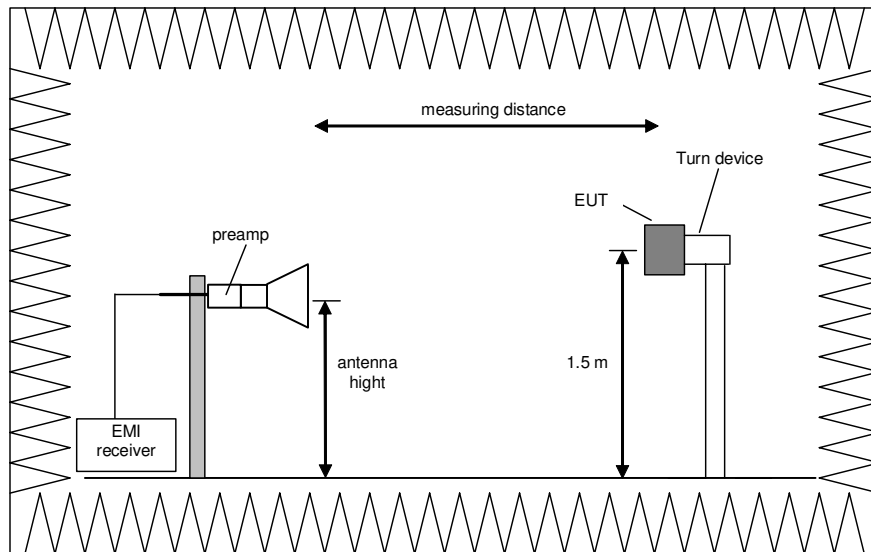

Procedure of measurement:

The measurements were performed in the frequency ranges 1 GHz to 4 GHz, 4 GHz to 12 GHz, 12 GHz to 18 GHz, 18 GHz to 25 /26.5 GHz and 26.5 GHz to 40 GHz.

The following procedure will be used:

- 1) Set the turntable and the turn device to obtain the worst-case emission for the first frequency identified in the preliminary measurements.
- 2) Set the measurement antenna polarisation to the orientation with the highest emission for the first frequency identified in the preliminary measurements.
- 3) Set the spectrum analyser to EMI mode with peak and average detector activated.
- 4) Rotate the turntable from 0° to 360° to find the EUT angle that produces the highest emissions.
- 5) Note the highest displayed peak and average values
- 6) Repeat the steps 1) to 5) for each frequency detected during the preliminary measurements.

5.4.2 Test results

5.4.2.1 Preliminary radiated emission measurement (9 kHz to 4 GHz)

Ambient temperature	22 °C	Relative humidity	26 %
---------------------	-------	-------------------	------

Position of EUT:	The EUT was set-up on a non-conducting table of a height of 0.8 m and 1.5 m. The distance between EUT and antenna was 3 m.
Cable guide:	For detail information of test set-up refer to the pictures in annex A of this test report.
Test record:	All results are shown in the following.
Supply voltage:	During all measurements the EUT was supplied with 3 V _{DC} by battery.
Frequency range:	The preliminary measurement was carried out in the frequency range 9 kHz to 4 GHz according to [2].
Mode of EUT:	Test mode: EUT transmits continuously with a data rate of 10 kBd and a duty cycle of 100%.

Transmitter operates at 314.45 MHz

161755 spur 9-150k 314,45M.wmf: Spurious emissions from 9 kHz to 150 kHz:

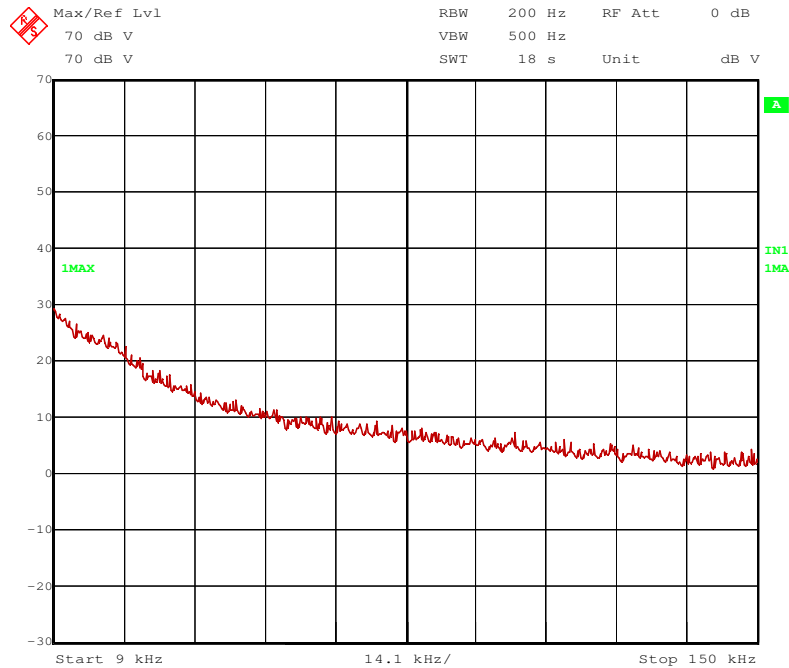

161755 spur 150k-1M 314,45M.wmf: Spurious emissions from 150 kHz to 1 MHz:

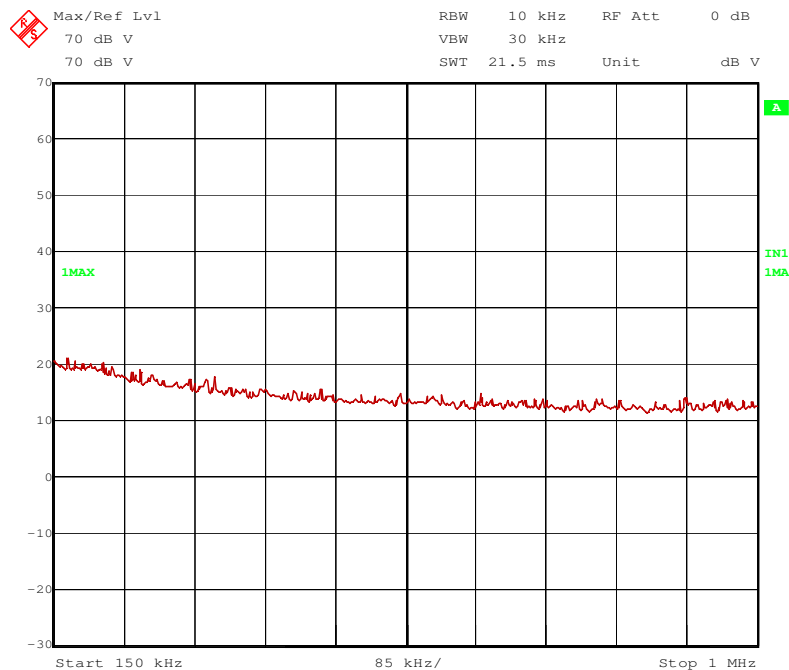

161755_spur_1-30M_314,45M.wmf: Spurious emissions from 1 MHz to 30 MHz:

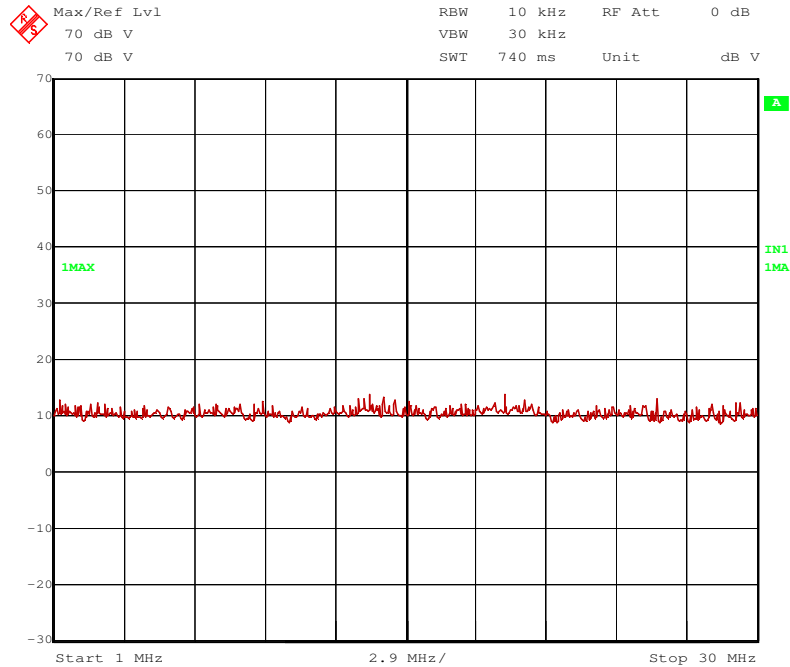

No significant frequencies above the noise floor of the system were found during the preliminary radiated emission test, so no measurements were carried out on the outdoor test site.

Test equipment used (see chapter 6):

9, 11 - 13, 20

161755_spur_30M-1G_314,45M.wmf: Spurious emissions from 30 MHz to 1 GHz:

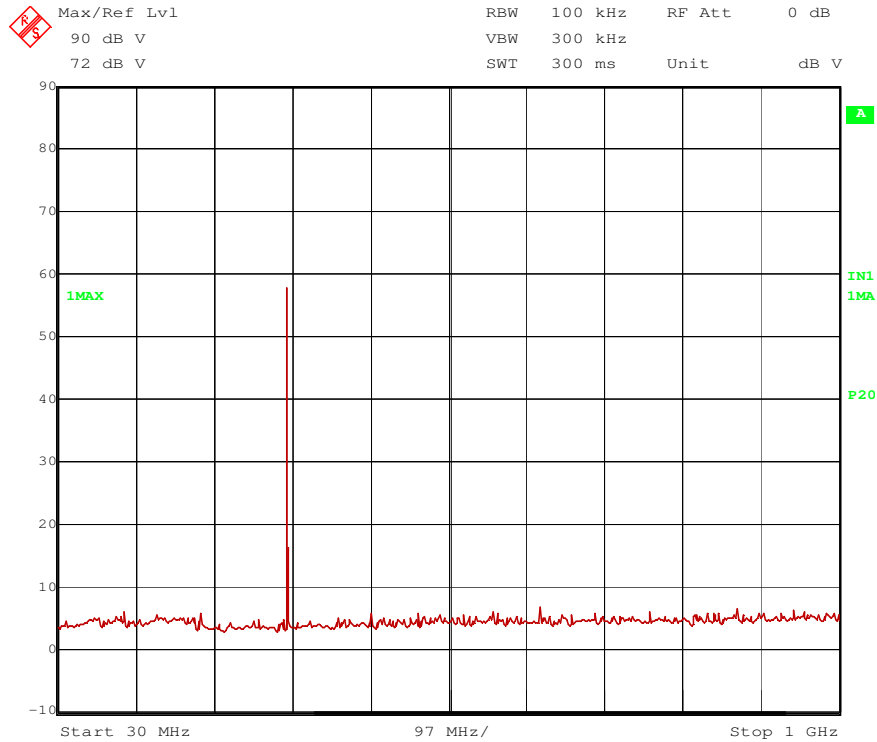

Only the nominal frequency of the transmitter was found during the preliminary radiated emission test:

This frequency will be measured in a final measurement. The results are shown in chapter 5.4.2.3.

Test equipment used (see chapter 6):

9, 11 - 15, 17, 19

161755_spur_1-4G_314,45M.wmf: Spurious emissions from 1 GHz to 4 GHz:

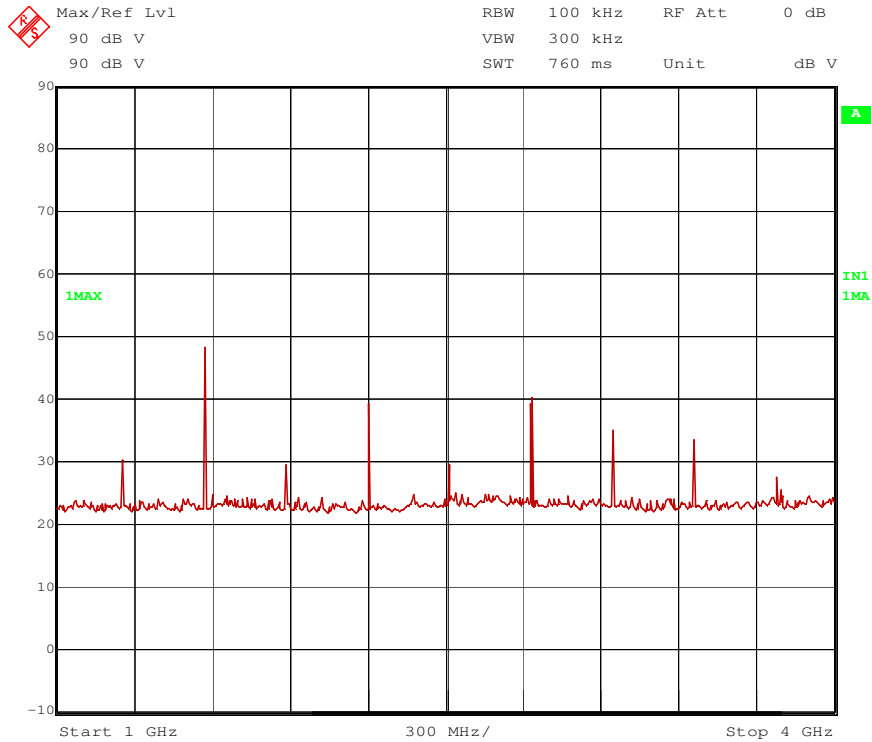

The following frequencies were found during the preliminary radiated emission test:

Inside restricted bands: 1572.2, MHz, 2201.1 MHz and 3773.4 MHz

Outside restricted bands: 1257.8 MHz, 1886.7 MHz, 2515.6 MHz, 2830.1 MHz, 3144.5 MHz and 3458.9 MHz

These frequencies have to be measured in a final measurement. The results are shown in chapter 5.4.2.4.

Test equipment used (see chapter 6):

9, 11 - 14, 16, 17, 21 - 23

5.4.2.2 Final radiated emission measurement (9 kHz to 30 MHz)

No significant frequencies above the noise floor of the system were found during the preliminary radiated emission test, so no final measurements were carried out on the outdoor test site.

5.4.2.3 Final radiated emission measurement (30 MHz to 1 GHz)

Ambient temperature	18 °C	Relative humidity	36 %
---------------------	-------	-------------------	------

Position of EUT:	The EUT was set-up on a non-conducting table of a height of 0.8 m. The distance between EUT and antenna was 3 m.
Cable guide:	For detail information of test set-up and the cable guide refer to the pictures in annex A of this test report.
Test record:	All results are shown in the following.
Supply voltage:	During all measurements the EUT was supplied with 3 V _{DC} by battery.
Mode of EUT:	Test mode: EUT transmits continuously with a data rate of 10 kBd and a duty cycle of 100%.
Test results:	The test results were calculated with the following formula:

$$\text{Result [dB}\mu\text{V/m]} = \text{reading [dB}\mu\text{V]} + \text{cable loss [dB]} + \text{antenna factor [dB/m]} + 6 \text{ dB (used attenuator)}$$

The measured points and the limit line in the following diagrams refer to the standard measurement of the emitted interference in compliance with the above-mentioned standard. The measured points marked with an x are the measured results of the standard final measurement on the open area test site.

The results of the standard subsequent measurement on the open area test site are indicated in the table below. The limits as well as the measured results (levels) refer to the above mentioned standard while taking account of the specified requirements for a 3 m measuring distance.

The measurement time with the quasi-peak measuring detector is 1 second.

Transmitter operates at 314.45 MHz

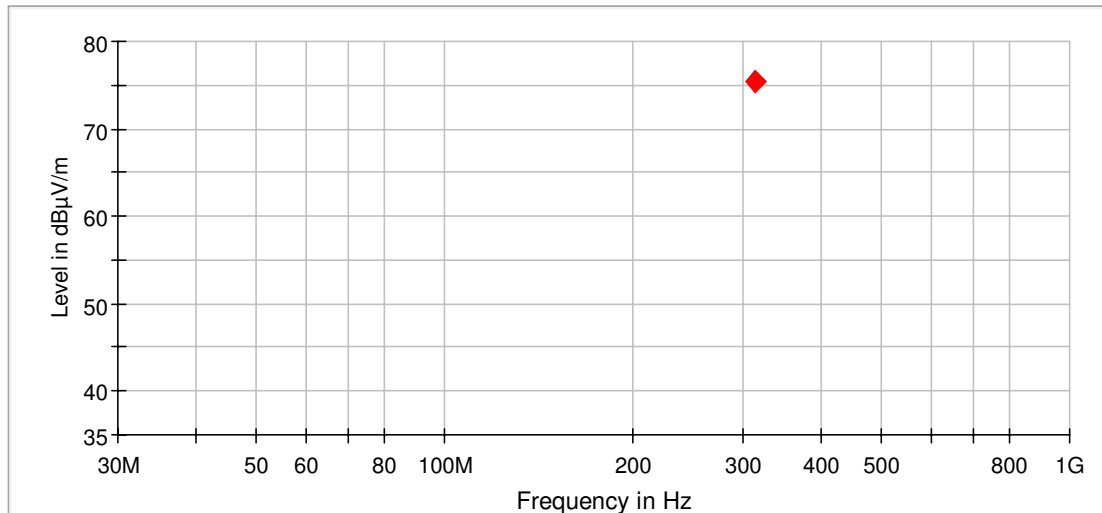

◆ Final_Result QPK

Final_Result

Frequency (MHz)	QuasiPeak (dBµV/m)	Limit * (dBµV/m)	Margin (dB)	Meas. Time (ms)	Bandwidth (kHz)	Height (cm)	Pol	Azimuth (deg)	Corr. (dB)
314.450	75.47	75.59	0.12	1000	120.000	104	H	136	22.7

*) Limit calculated according to [2] Part 15.231 (b)

Test: Passed

Test equipment used (see chapter 6):

1 - 8

5.4.2.4 Final radiated emission measurement (1 GHz to 4 GHz)

Ambient temperature	22 °C	Relative humidity	26 %
---------------------	-------	-------------------	------

Position of EUT:	The EUT was set-up on a non-conducting table of a height of 1.5 m. The distance between EUT and antenna was 3 m.
Cable guide:	For detail information of test set-up and the cable guide refer to the pictures in annex A of this test report.
Test record:	All results are shown in the following.
Supply voltage:	During all measurements the EUT was supplied with 3 V _{DC} by battery.
Resolution bandwidth:	For all measurements a resolution bandwidth of 1 MHz was used.
Mode of EUT:	Test mode: EUT transmits continuously with a data rate of 10 kBd and a duty cycle of 100%.

Transmitter operates at 315.45 MHz

Result [dB μ V/m] = reading [dB μ V] + cable loss [dB] + antenna factor [dB/m] – gain of preamp [dB]

Result measured with the peak detector:

Frequency MHz	Result dB μ V/m	Limit dB μ V/m	Margin dB	Readings dB μ V	Antenna factor 1/m	Preamp dB	Cable loss dB	Height cm	Turntable Angle deg	Pos. Angle deg	Pol.	Restr. Band
1257.8	40.01	74.00	33.99	38.95	24.86	26.50	2.70	150	128	0	Vert.	no
1572.2	51.45	74.00	22.55	49.68	25.27	26.50	3.00	150	262	0	Vert.	yes
1886.7	42.18	74.00	31.82	38.01	27.37	26.50	3.30	150	44	0	Vert.	no
2830.1	49.40	74.00	24.60	42.56	29.24	26.40	4.00	150	177	0	Hor.	yes
3144.5	47.21	74.00	26.79	38.60	30.71	26.40	4.30	150	360	30	Hor.	no
3458.9	47.54	74.00	26.46	38.48	31.06	26.40	4.40	150	7	30	Hor.	no
3773.4	44.35	74.00	29.65	33.74	32.11	26.10	4.60	150	360	60	Hor.	yes
2201.2	49.75	74.00	24.25	44.97	27.68	26.50	3.60	150	156	90	Hor.	yes
2515.6	43.60	74.00	30.40	37.65	28.55	26.40	3.80	150	275	90	Hor.	no

Measurement uncertainty: +2.2 dB / -3.6 dB

Result measured with the average detector:

Frequency MHz	Result dB μ V/m	Limit dB μ V/m	Margin dB	Readings dB μ V	Antenna factor 1/m	Preamp dB	Cable loss dB	Height cm	Turntable Angle °	Pos. Angle °	Pol.	Restr. Band
1257.8	30.65	55.59	24.94	29.59	24.86	26.50	2.70	150	272	0	Vert.	no
1572.2	50.27	54.00	3.73	48.50	25.27	26.50	3.00	150	262	0	Vert.	yes
1886.7	31.96	55.59	23.63	27.79	27.37	26.50	3.30	150	185	0	Vert.	no
2830.1	46.51	54.00	7.49	39.67	29.24	26.40	4.00	150	185	0	Hor.	yes
3144.5	43.05	55.59	12.54	34.44	30.71	26.40	4.30	150	1	30	Hor.	no
3458.9	43.10	55.59	11.49	34.04	31.06	26.40	4.40	150	1	30	Hor.	no
3773.4	34.99	54.00	19.01	24.38	32.11	26.10	4.60	150	358	60	Hor.	yes
2201.2	47.09	54.00	6.91	42.31	27.68	26.50	3.60	150	147	90	Hor.	yes
2515.6	35.62	55.59	19.97	29.67	28.55	26.40	3.80	150	29	90	Hor.	no

Measurement uncertainty: +2.2 dB / -3.6 dB

Remark: The reading of the noise level measured with the peak detector is round about 33 dB μ V.
Therefore the results measured with the peak detector differ from the results measured with the average detector especially at low readings although the duty cycle of the EUT is 100%.

Test: Passed

Test equipment used (see chapter 6):

9, 11 -14, 16, 17, 21 - 23

5.5 Radiated emissions (receiver)

5.5.1 Method of measurement

For the methods of measurements please refer to [5]. The measurements deviate from [5] by using a positioner as described in chapter 5.4.1 of this report instead of a height scan.

5.5.2 Test results

5.5.2.1 Preliminary radiated emission measurement (30 MHz to 2 GHz)

Ambient temperature	22 °C	Relative humidity	26 %
---------------------	-------	-------------------	------

Position of EUT:	The EUT was set-up on a positioner at a height of 1.5 m. The distance between EUT and antenna was 3 m.
Cable guide:	For detail information of test set-up refer to the pictures in annex A of this test report.
Test record:	All results are shown in the following.
Supply voltage:	During all measurements the EUT was supplied with 3 V _{DC} by battery.
Frequency range:	The preliminary measurement was carried out in the frequency range 30 MHz to 2 GHz according to [2].
Mode of EUT:	Test mode (LF and RF receiver active)

161755_RX315_30M-1G.wmf: Spurious emissions from 30 MHz to 1 GHz:

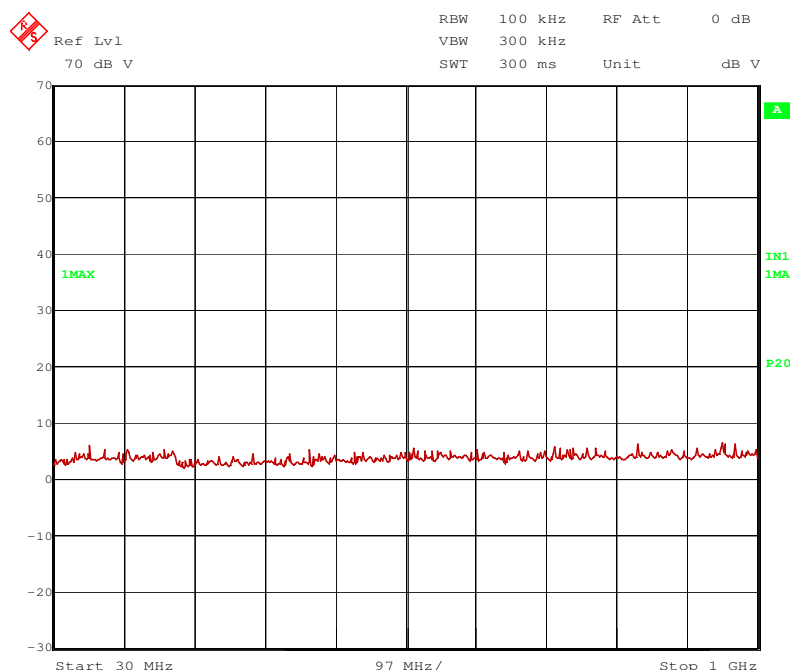

161755_RX315_1-2G.wmf: Spurious emissions from 1 to 2 GHz:

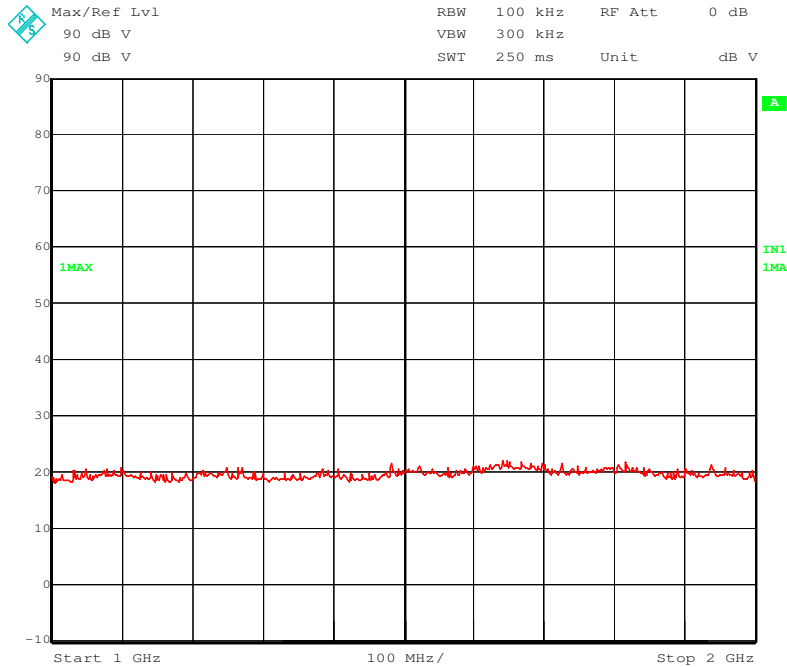

5.5.2.2 Final radiated emission measurement (30 MHz to 2 GHz)

No significant emissions above the noise floor of the measuring system were found in preliminary measurements. Therefore no final measurements were carried out.

Test equipment used (see chapter 6):

9, 11 -14, 16, 17, 21 - 23

6 Test Equipment used for Tests

No.	Test equipment	Type	Manufacturer	Serial No.	PM. No.	Cal. Date	Cal. due
1	EMI Software	EMC 32	Rohde & Schwarz	100061	481022	-	-
2	Open area test site	-	Phoenix Test-Lab	-	480085	Weekly verification (system cal.)	
3	Measuring receiver	ESIB7	Rohde & Schwarz	100304	480521	18.02.2016	02/2018
4	Controller	HD100	Deisel	100/670	480139	-	-
5	Turntable	DS420HE	Deisel	420/620/80	480087	-	-
6	Antenna support	AS615P	Deisel	615/310	480086	-	-
7	Antenna	CBL6111 D	Chase	25761	480894	18.09.2014	09.2017
8	6 dB attenuator	R412706000	Radiall	9833	410082	Weekly verification (system cal.)	
9	Fully anechoic chamber M20	-	Albatross Projects	B83107-E2439-T232	480303	Weekly verification (system cal.)	
10	Spectrum analyser	FSW	Rohde & Schwarz	100586	481720	24.02.2016	02.2017
11	Measuring receiver	ESI 40	Rohde & Schwarz	100064	480355	16.12.2016	02.2017
12	Controller	MCU	Maturo	MCU/043/971107	480832	-	-
13	Turntable	DS420HE	Deisel	420/620/80	480315	-	-
14	Antenna support	AS615P	Deisel	615/310	480187	-	-
15	Antenna	CBL6112 B	Chase	2688	480328	14.04.2014	04.2017
16	Antenna	3115A	EMCO	9609-4918	480183	10.11.2014	11.2017
17	Positioner	TDF 1.5	Maturo	15920215	482034	-	-
18	Test fixture	-	Phoenix Testlab	-	410160	-	-
19	RF-cable No. 36	Sucoflex 106B	Suhner	0587/6B	480865	Weekly verification (system cal.)	
20	Loop antenna	HFH2-Z2	Rohde & Schwarz	100417	481912	20.10.2016	10.2017
21	RF-cable No. 3	Sucoflex 106B	Huber+Suhner	0563/6B / Kabel 3	480670	Weekly verification (system cal.)	
22	RF-cable No. 40	Sucoflex 106B	Huber+Suhner	0708/6B / Kabel 40	481330	Weekly verification (system cal.)	
23	Preamplifier	JS3-00101200-23-5A	Miteq	681851	480337	18.02.2016	02.2018

7 Report History

Report Number	Date	Comment
F161755E6	16.03.2017	Initial test report
-	-	-
-	-	-

8 List of Annexes

ANNEX A	TEST SETUP PHOTOS	4 pages
161755_11	Test setup fully anechoic chamber	
161755_12	Test setup fully anechoic chamber	
161755_13	Test setup fully anechoic chamber	
161755_14	Test setup open area test site	
ANNEX B	EXTERNAL PHOTOS	2 pages
161755_15	DC12A, 3D view 1	
161755_16	DC12A, 3D view 2	
ANNEX C	INTERNAL PHOTOS	3 pages
161755_17	DC12A, bottom view (battery cover removed)	
161755_18	DC12A, PCB, bottom view	
161755_19	DC12A, PCB, top view	