

### Head TSL parameters at 5300 MHz

The following parameters and calculations were applied.

	Temperature	Permittivity	Conductivity
Nominal Head TSL parameters	22.0 °C	35.9	4.76 mho/m
Measured Head TSL parameters	(22.0 ± 0.2) °C	34.4 ± 6 %	4.63 mho/m ± 6 %
Head TSL temperature change during test	< 0.5 °C	----	----

### SAR result with Head TSL at 5300 MHz

SAR averaged over 1 cm <sup>3</sup> (1 g) of Head TSL	Condition	
SAR measured	100 mW input power	8.38 W/kg
SAR for nominal Head TSL parameters	normalized to 1W	<b>83.0 W / kg ± 19.9 % (k=2)</b>

SAR averaged over 10 cm <sup>3</sup> (10 g) of Head TSL	condition	
SAR measured	100 mW input power	2.40 W/kg
SAR for nominal Head TSL parameters	normalized to 1W	<b>23.7 W/kg ± 19.5 % (k=2)</b>

### Head TSL parameters at 5500 MHz

The following parameters and calculations were applied.

	Temperature	Permittivity	Conductivity
Nominal Head TSL parameters	22.0 °C	35.6	4.96 mho/m
Measured Head TSL parameters	(22.0 ± 0.2) °C	34.2 ± 6 %	4.83 mho/m ± 6 %
Head TSL temperature change during test	< 0.5 °C	----	----

### SAR result with Head TSL at 5500 MHz

SAR averaged over 1 cm <sup>3</sup> (1 g) of Head TSL	Condition	
SAR measured	100 mW input power	8.21 W/kg
SAR for nominal Head TSL parameters	normalized to 1W	<b>81.3 W/kg ± 19.9 % (k=2)</b>

SAR averaged over 10 cm <sup>3</sup> (10 g) of Head TSL	condition	
SAR measured	100 mW input power	2.34 W/kg
SAR for nominal Head TSL parameters	normalized to 1W	<b>23.1 W/kg ± 19.5 % (k=2)</b>

### Head TSL parameters at 5600 MHz

The following parameters and calculations were applied.

	Temperature	Permittivity	Conductivity
Nominal Head TSL parameters	22.0 °C	35.5	5.07 mho/m
Measured Head TSL parameters	(22.0 ± 0.2) °C	34.0 ± 6 %	4.93 mho/m ± 6 %
Head TSL temperature change during test	< 0.5 °C	----	----

### SAR result with Head TSL at 5600 MHz

SAR averaged over 1 cm <sup>3</sup> (1 g) of Head TSL	Condition	
SAR measured	100 mW input power	8.38 W/kg
SAR for nominal Head TSL parameters	normalized to 1W	<b>82.9 W/kg ± 19.9 % (k=2)</b>

SAR averaged over 10 cm <sup>3</sup> (10 g) of Head TSL	condition	
SAR measured	100 mW input power	2.39 W/kg
SAR for nominal Head TSL parameters	normalized to 1W	<b>23.6 W/kg ± 19.5 % (k=2)</b>

### Head TSL parameters at 5800 MHz

The following parameters and calculations were applied.

	Temperature	Permittivity	Conductivity
Nominal Head TSL parameters	22.0 °C	35.3	5.27 mho/m
Measured Head TSL parameters	(22.0 ± 0.2) °C	33.7 ± 6 %	5.14 mho/m ± 6 %
Head TSL temperature change during test	< 0.5 °C	----	----

### SAR result with Head TSL at 5800 MHz

SAR averaged over 1 cm <sup>3</sup> (1 g) of Head TSL	Condition	
SAR measured	100 mW input power	7.96 W/kg
SAR for nominal Head TSL parameters	normalized to 1W	<b>78.8 W/kg ± 19.9 % (k=2)</b>

SAR averaged over 10 cm <sup>3</sup> (10 g) of Head TSL	condition	
SAR measured	100 mW input power	2.26 W/kg
SAR for nominal Head TSL parameters	normalized to 1W	<b>22.3 W/kg ± 19.5 % (k=2)</b>

**Body TSL parameters at 5200 MHz**

The following parameters and calculations were applied.

	Temperature	Permittivity	Conductivity
Nominal Body TSL parameters	22.0 °C	49.0	5.30 mho/m
Measured Body TSL parameters	(22.0 ± 0.2) °C	47.5 ± 6 %	5.45 mho/m ± 6 %
Body TSL temperature change during test	< 0.5 °C	----	----

**SAR result with Body TSL at 5200 MHz**

SAR averaged over 1 cm <sup>3</sup> (1 g) of Body TSL	Condition	
SAR measured	100 mW input power	7.48 W/kg
SAR for nominal Body TSL parameters	normalized to 1W	<b>74.4 W/kg ± 19.9 % (k=2)</b>

SAR averaged over 10 cm <sup>3</sup> (10 g) of Body TSL	condition	
SAR measured	100 mW input power	2.10 W/kg
SAR for nominal Body TSL parameters	normalized to 1W	<b>20.9 W/kg ± 19.5 % (k=2)</b>

**Body TSL parameters at 5300 MHz**

The following parameters and calculations were applied.

	Temperature	Permittivity	Conductivity
Nominal Body TSL parameters	22.0 °C	48.9	5.42 mho/m
Measured Body TSL parameters	(22.0 ± 0.2) °C	47.3 ± 6 %	5.59 mho/m ± 6 %
Body TSL temperature change during test	< 0.5 °C	----	----

**SAR result with Body TSL at 5300 MHz**

SAR averaged over 1 cm <sup>3</sup> (1 g) of Body TSL	Condition	
SAR measured	100 mW input power	7.69 W/kg
SAR for nominal Body TSL parameters	normalized to 1W	<b>76.5 W/kg ± 19.9 % (k=2)</b>

SAR averaged over 10 cm <sup>3</sup> (10 g) of Body TSL	condition	
SAR measured	100 mW input power	2.17 W/kg
SAR for nominal Body TSL parameters	normalized to 1W	<b>21.5 W/kg ± 19.5 % (k=2)</b>

**Body TSL parameters at 5500 MHz**

The following parameters and calculations were applied.

	Temperature	Permittivity	Conductivity
Nominal Body TSL parameters	22.0 °C	48.6	5.65 mho/m
Measured Body TSL parameters	(22.0 ± 0.2) °C	47.0 ± 6 %	5.86 mho/m ± 6 %
Body TSL temperature change during test	< 0.5 °C	----	----

**SAR result with Body TSL at 5500 MHz**

SAR averaged over 1 cm <sup>3</sup> (1 g) of Body TSL	Condition	
SAR measured	100 mW input power	8.03 W/kg
SAR for nominal Body TSL parameters	normalized to 1W	<b>79.9 W/kg ± 19.9 % (k=2)</b>

SAR averaged over 10 cm <sup>3</sup> (10 g) of Body TSL	condition	
SAR measured	100 mW input power	2.23 W/kg
SAR for nominal Body TSL parameters	normalized to 1W	<b>22.1 W/kg ± 19.5 % (k=2)</b>

**Body TSL parameters at 5600 MHz**

The following parameters and calculations were applied.

	Temperature	Permittivity	Conductivity
Nominal Body TSL parameters	22.0 °C	48.5	5.77 mho/m
Measured Body TSL parameters	(22.0 ± 0.2) °C	46.8 ± 6 %	6.00 mho/m ± 6 %
Body TSL temperature change during test	< 0.5 °C	----	----

**SAR result with Body TSL at 5600 MHz**

SAR averaged over 1 cm <sup>3</sup> (1 g) of Body TSL	Condition	
SAR measured	100 mW input power	7.95 W/kg
SAR for nominal Body TSL parameters	normalized to 1W	<b>79.1 W/kg ± 19.9 % (k=2)</b>

SAR averaged over 10 cm <sup>3</sup> (10 g) of Body TSL	condition	
SAR measured	100 mW input power	2.23 W/kg
SAR for nominal Body TSL parameters	normalized to 1W	<b>22.1 W/kg ± 19.5 % (k=2)</b>

**Body TSL parameters at 5800 MHz**

The following parameters and calculations were applied.

	Temperature	Permittivity	Conductivity
<b>Nominal Body TSL parameters</b>	22.0 °C	48.2	6.00 mho/m
<b>Measured Body TSL parameters</b>	(22.0 ± 0.2) °C	46.4 ± 6 %	6.29 mho/m ± 6 %
<b>Body TSL temperature change during test</b>	< 0.5 °C	----	----

**SAR result with Body TSL at 5800 MHz**

<b>SAR averaged over 1 cm<sup>3</sup> (1 g) of Body TSL</b>	Condition	
SAR measured	100 mW input power	7.66 W/kg
SAR for nominal Body TSL parameters	normalized to 1W	<b>76.2 W/kg ± 19.9 % (k=2)</b>

<b>SAR averaged over 10 cm<sup>3</sup> (10 g) of Body TSL</b>	condition	
SAR measured	100 mW input power	2.13 W/kg
SAR for nominal Body TSL parameters	normalized to 1W	<b>21.1 W/kg ± 19.5 % (k=2)</b>



**Appendix (Additional assessments outside the scope of SCS 0108)**

**Antenna Parameters with Head TSL at 5200 MHz**

Impedance, transformed to feed point	47.1 $\Omega$ - 5.8 j $\Omega$
Return Loss	- 23.6 dB

**Antenna Parameters with Head TSL at 5300 MHz**

Impedance, transformed to feed point	50.5 $\Omega$ - 3.2 j $\Omega$
Return Loss	- 29.8 dB

**Antenna Parameters with Head TSL at 5500 MHz**

Impedance, transformed to feed point	49.0 $\Omega$ + 2.5 j $\Omega$
Return Loss	- 31.2 dB

**Antenna Parameters with Head TSL at 5600 MHz**

Impedance, transformed to feed point	50.0 $\Omega$ + 0.6 j $\Omega$
Return Loss	- 44.1 dB

**Antenna Parameters with Head TSL at 5800 MHz**

Impedance, transformed to feed point	55.6 $\Omega$ + 1.9 j $\Omega$
Return Loss	- 25.1 dB

**Antenna Parameters with Body TSL at 5200 MHz**

Impedance, transformed to feed point	48.6 $\Omega$ - 3.4 j $\Omega$
Return Loss	- 28.6 dB

**Antenna Parameters with Body TSL at 5300 MHz**

Impedance, transformed to feed point	49.6 $\Omega$ - 2.4 j $\Omega$
Return Loss	- 32.3 dB

**Antenna Parameters with Body TSL at 5500 MHz**

Impedance, transformed to feed point	49.5 $\Omega$ + 2.5 j $\Omega$
Return Loss	- 31.7 dB

**Antenna Parameters with Body TSL at 5600 MHz**

Impedance, transformed to feed point	50.8 $\Omega$ + 2.5 j $\Omega$
Return Loss	- 31.7 dB

**Antenna Parameters with Body TSL at 5800 MHz**

Impedance, transformed to feed point	56.0 $\Omega$ + 3.0 j $\Omega$
Return Loss	- 24.0 dB

**General Antenna Parameters and Design**

Electrical Delay (one direction)	1.191 ns
----------------------------------	----------

After long term use with 100W radiated power, only a slight warming of the dipole near the feedpoint can be measured.

The dipole is made of standard semirigid coaxial cable. The center conductor of the feeding line is directly connected to the second arm of the dipole. The antenna is therefore short-circuited for DC-signals. On some of the dipoles, small end caps are added to the dipole arms in order to improve matching when loaded according to the position as explained in the "Measurement Conditions" paragraph. The SAR data are not affected by this change. The overall dipole length is still according to the Standard.

No excessive force must be applied to the dipole arms, because they might bend or the soldered connections near the feedpoint may be damaged.

**Additional EUT Data**

Manufactured by	SPEAG
Manufactured on	May 04, 2015

**DASY5 Validation Report for Head TSL**

Date: 21.09.2016

Test Laboratory: SPEAG, Zurich, Switzerland

**DUT: Dipole D5GHzV2; Type: D5GHzV2; Serial: D5GHzV2 - SN:1238**

Communication System: UID 0 - CW; Frequency: 5200 MHz, Frequency: 5300 MHz, Frequency: 5500 MHz, Frequency: 5600 MHz, Frequency: 5800 MHz

Medium parameters used: f = 5200 MHz;  $\sigma = 4.54$  S/m;  $\epsilon_r = 34.6$ ;  $\rho = 1000$  kg/m<sup>3</sup>

Medium parameters used: f = 5300 MHz;  $\sigma = 4.63$  S/m;  $\epsilon_r = 34.4$ ;  $\rho = 1000$  kg/m<sup>3</sup>

Medium parameters used: f = 5500 MHz;  $\sigma = 4.83$  S/m;  $\epsilon_r = 34.2$ ;  $\rho = 1000$  kg/m<sup>3</sup>

Medium parameters used: f = 5600 MHz;  $\sigma = 4.93$  S/m;  $\epsilon_r = 34.0$ ;  $\rho = 1000$  kg/m<sup>3</sup>

Medium parameters used: f = 5800 MHz;  $\sigma = 5.14$  S/m;  $\epsilon_r = 33.7$ ;  $\rho = 1000$  kg/m<sup>3</sup>

Phantom section: Flat Section

Measurement Standard: DASY5 (IEEE/IEC/ANSI C63.19-2011)

DASY52 Configuration:

- Probe: EX3DV4 - SN3503; ConvF(5.59, 5.59, 5.59); Calibrated: 30.06.2016, ConvF(5.14, 5.14, 5.14); Calibrated: 30.06.2016, ConvF(5.02, 5.02, 5.02); Calibrated: 30.06.2016, ConvF(4.89, 4.89, 4.89); Calibrated: 30.06.2016, ConvF(4.85, 4.85, 4.85); Calibrated: 30.06.2016;
- Sensor-Surface: 1.4mm (Mechanical Surface Detection)
- Electronics: DAE4 Sn601; Calibrated: 30.12.2015
- Phantom: Flat Phantom 5.0 (front); Type: QD000P50AA; Serial: 1001
- DASY52 52.8.8(1258); SEMCAD X 14.6.10(7372)

**Dipole Calibration for Head Tissue/Pin=100mW, dist=10mm, f=5200 MHz/Zoom Scan, dist=1.4mm (8x8x7)/Cube 0:** Measurement grid: dx=4mm, dy=4mm, dz=1.4mm

Reference Value = 70.35 V/m; Power Drift = 0.02 dB

Peak SAR (extrapolated) = 27.9 W/kg

**SAR(1 g) = 7.76 W/kg; SAR(10 g) = 2.22 W/kg**

Maximum value of SAR (measured) = 17.9 W/kg

**Dipole Calibration for Head Tissue/Pin=100mW, dist=10mm, f=5300 MHz/Zoom Scan, dist=1.4mm (8x8x7)/Cube 0:** Measurement grid: dx=4mm, dy=4mm, dz=1.4mm

Reference Value = 72.80 V/m; Power Drift = 0.01 dB

Peak SAR (extrapolated) = 31.1 W/kg

**SAR(1 g) = 8.38 W/kg; SAR(10 g) = 2.4 W/kg**

Maximum value of SAR (measured) = 19.5 W/kg

**Dipole Calibration for Head Tissue/Pin=100mW, dist=10mm, f=5500 MHz/Zoom Scan, dist=1.4mm (8x8x7)/Cube 0:** Measurement grid: dx=4mm, dy=4mm, dz=1.4mm

Reference Value = 70.90 V/m; Power Drift = -0.01 dB

Peak SAR (extrapolated) = 31.9 W/kg

**SAR(1 g) = 8.21 W/kg; SAR(10 g) = 2.34 W/kg**

Maximum value of SAR (measured) = 19.5 W/kg



**Dipole Calibration for Head Tissue/Pin=100mW, dist=10mm, f=5600 MHz/Zoom Scan, dist=1.4mm (8x8x7)/Cube 0:** Measurement grid: dx=4mm, dy=4mm, dz=1.4mm  
Reference Value = 71.51 V/m; Power Drift = -0.00 dB  
Peak SAR (extrapolated) = 32.8 W/kg  
**SAR(1 g) = 8.38 W/kg; SAR(10 g) = 2.39 W/kg**  
Maximum value of SAR (measured) = 20.0 W/kg

**Dipole Calibration for Head Tissue/Pin=100mW, dist=10mm, f=5800 MHz/Zoom Scan, dist=1.4mm (8x8x7)/Cube 0:** Measurement grid: dx=4mm, dy=4mm, dz=1.4mm  
Reference Value = 69.07 V/m; Power Drift = -0.04 dB  
Peak SAR (extrapolated) = 32.5 W/kg  
**SAR(1 g) = 7.96 W/kg; SAR(10 g) = 2.26 W/kg**  
Maximum value of SAR (measured) = 19.4 W/kg

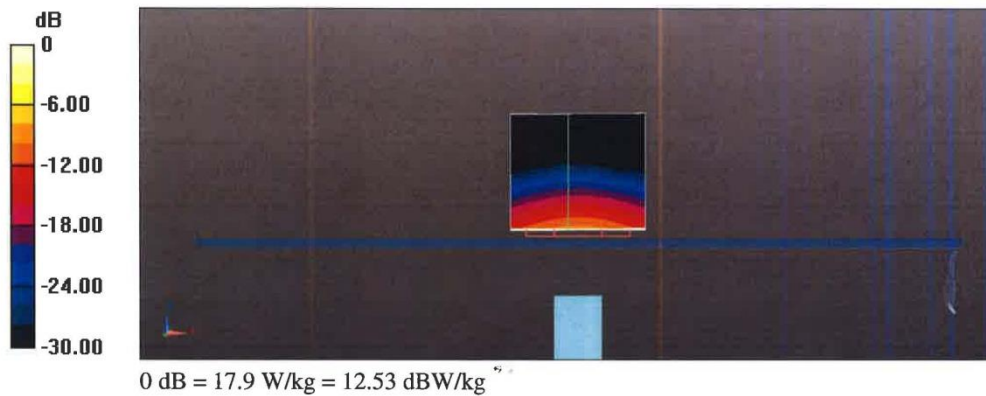

**Impedance Measurement Plot for Head TSL**

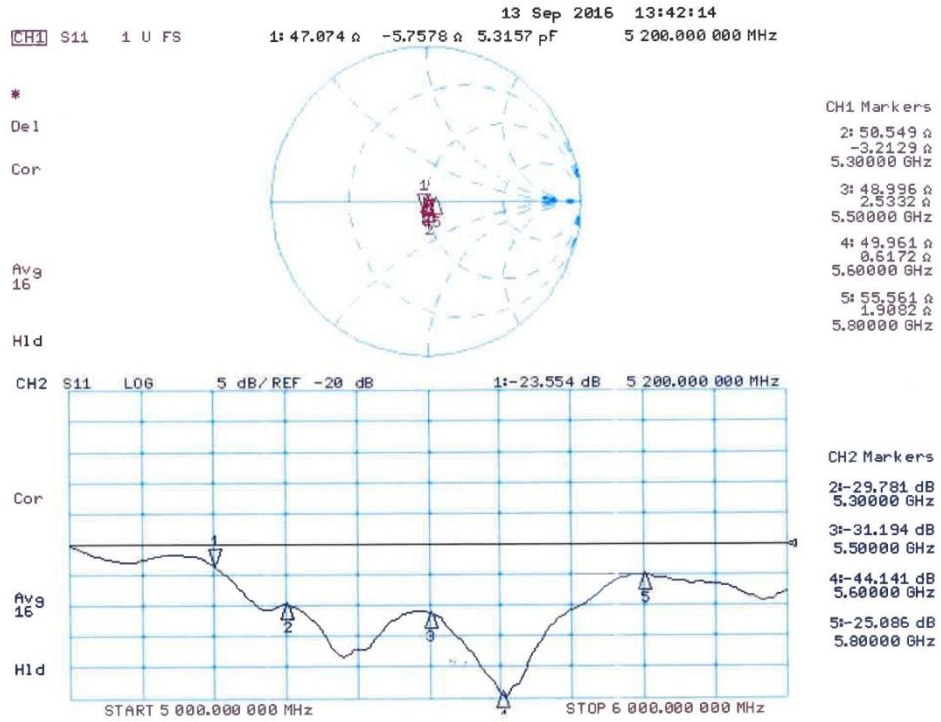

## DASY5 Validation Report for Body TSL

Date: 20.09.2016

Test Laboratory: SPEAG, Zurich, Switzerland

**DUT: Dipole D5GHzV2; Type: D5GHzV2; Serial: D5GHzV2 - SN:1238**

Communication System: UID 0 - CW; Frequency: 5200 MHz, Frequency: 5300 MHz, Frequency: 5500 MHz, Frequency: 5600 MHz, Frequency: 5800 MHz

Medium parameters used:  $f = 5200$  MHz;  $\sigma = 5.45$  S/m;  $\epsilon_r = 47.5$ ;  $\rho = 1000$  kg/m<sup>3</sup>

Medium parameters used:  $f = 5300$  MHz;  $\sigma = 5.59$  S/m;  $\epsilon_r = 47.3$ ;  $\rho = 1000$  kg/m<sup>3</sup>

Medium parameters used:  $f = 5500$  MHz;  $\sigma = 5.86$  S/m;  $\epsilon_r = 47.0$ ;  $\rho = 1000$  kg/m<sup>3</sup>

Medium parameters used:  $f = 5600$  MHz;  $\sigma = 6.00$  S/m;  $\epsilon_r = 46.8$ ;  $\rho = 1000$  kg/m<sup>3</sup>

Medium parameters used:  $f = 5800$  MHz;  $\sigma = 6.29$  S/m;  $\epsilon_r = 46.4$ ;  $\rho = 1000$  kg/m<sup>3</sup>

Phantom section: Flat Section

Measurement Standard: DASY5 (IEEE/IEC/ANSI C63.19-2011)

DASY52 Configuration:

- Probe: EX3DV4 - SN3503; ConvF(4.99, 4.99, 4.99); Calibrated: 30.06.2016, ConvF(4.75, 4.75, 4.75); Calibrated: 30.06.2016, ConvF(4.4, 4.4, 4.4); Calibrated: 30.06.2016, ConvF(4.35, 4.35, 4.35); Calibrated: 30.06.2016, ConvF(4.27, 4.27, 4.27); Calibrated: 30.06.2016;
- Sensor-Surface: 1.4mm (Mechanical Surface Detection)
- Electronics: DAE4 Sn601; Calibrated: 30.12.2015
- Phantom: Flat Phantom 5.0 (back); Type: QD000P50AA; Serial: 1002
- DASY52 52.8.8(1258); SEMCAD X 14.6.10(7372)

**Dipole Calibration for Body Tissue/Pin=100mW, dist=10mm, f=5200MHz/Zoom Scan, dist=1.4mm (8x8x7)/Cube 0:** Measurement grid: dx=4mm, dy=4mm, dz=1.4mm

Reference Value = 66.67 V/m; Power Drift = -0.06 dB

Peak SAR (extrapolated) = 27.8 W/kg

**SAR(1 g) = 7.48 W/kg; SAR(10 g) = 2.1 W/kg**

Maximum value of SAR (measured) = 17.3 W/kg

**Dipole Calibration for Body Tissue/Pin=100mW, dist=10mm, f=5300 MHz/Zoom Scan, dist=1.4mm (8x8x7)/Cube 0:** Measurement grid: dx=4mm, dy=4mm, dz=1.4mm

Reference Value = 67.01 V/m; Power Drift = -0.06 dB

Peak SAR (extrapolated) = 29.4 W/kg

**SAR(1 g) = 7.69 W/kg; SAR(10 g) = 2.17 W/kg**

Maximum value of SAR (measured) = 18.0 W/kg

**Dipole Calibration for Body Tissue/Pin=100mW, dist=10mm, f=5500 MHz/Zoom Scan, dist=1.4mm (8x8x7)/Cube 0:** Measurement grid: dx=4mm, dy=4mm, dz=1.4mm

Reference Value = 67.20 V/m; Power Drift = -0.05 dB

Peak SAR (extrapolated) = 32.4 W/kg

**SAR(1 g) = 8.03 W/kg; SAR(10 g) = 2.23 W/kg**

Maximum value of SAR (measured) = 19.2 W/kg

**Dipole Calibration for Body Tissue/Pin=100mW, dist=10mm, f=5600 MHz/Zoom Scan, dist=1.4mm (8x8x7)/Cube 0:** Measurement grid: dx=4mm, dy=4mm, dz=1.4mm  
Reference Value = 66.47 V/m; Power Drift = -0.07 dB  
Peak SAR (extrapolated) = 32.7 W/kg  
**SAR(1 g) = 7.95 W/kg; SAR(10 g) = 2.23 W/kg**  
Maximum value of SAR (measured) = 19.1 W/kg

**Dipole Calibration for Body Tissue/Pin=100mW, dist=10mm, f=5800 MHz/Zoom Scan, dist=1.4mm (8x8x7)/Cube 0:** Measurement grid: dx=4mm, dy=4mm, dz=1.4mm  
Reference Value = 64.40 V/m; Power Drift = -0.08 dB  
Peak SAR (extrapolated) = 33.2 W/kg  
**SAR(1 g) = 7.66 W/kg; SAR(10 g) = 2.13 W/kg**  
Maximum value of SAR (measured) = 18.8 W/kg



**Impedance Measurement Plot for Body TSL**

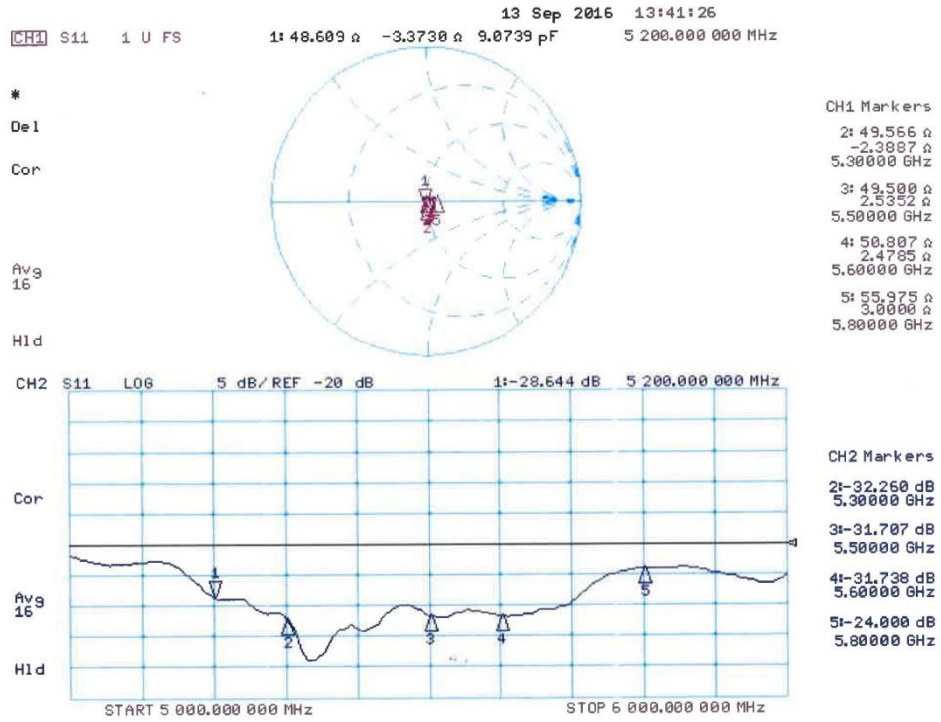



## ANNEX J Extended Calibration SAR Dipole

Referring to KDB865664 D01, if dipoles are verified in return loss ( <-20dBm, within 20% of prior calibration), and in impedance ( within 5 ohm of prior calibration), the annual calibration is not necessary and the calibration interval can be extended.

Justification of Extended Calibration SAR Dipole D5GHzV2– serial no.1238

Head							
Date of Measurement	Frequency	Return-Loss (dB)	Delta (%)	Real Impedance (ohm)	Delta (ohm)	Imaginary Impedance (johm)	Delta (johm)
2016-09-21	5200MHz	-23.6	/	47.1	/	5.80	/
2017-09-20		-21.7	8.1	48.3	1.2	3.38	2.42
2018-09-18		-21.2	10.2	48.7	1.6	3.25	2.55
2016-09-21	5300MHz	-29.8	/	50.5	/	3.20	/
2017-09-20		-27.8	6.7	51.9	1.4	4.51	1.31
2018-09-18		-26.2	12.1	53.3	2.8	4.82	1.62
2016-09-21	5500MHz	-31.2	/	49.0	/	2.50	/
2017-09-20		-29.5	5.4	50.3	1.3	1.24	1.26
2018-09-18		-28.1	9.9	51.4	2.4	1.55	0.95
2016-09-21	5600MHz	-44.1	/	50.0	/	0.60	/
2017-09-20		-42.6	3.4	51.5	1.5	2.55	1.95
2018-09-18		-40.5	8.2	53.3	3.3	3.01	2.41
2016-09-21	5800MHz	-25.1	/	55.6	/	1.90	/
2017-09-20		-23.8	5.2	56.9	1.3	3.04	1.14
2018-09-18		-22.7	9.6	57.3	1.7	2.88	0.98

Body							
Date of Measurement	Frequency	Return-Loss (dB)	Delta (%)	Real Impedance (ohm)	Delta (ohm)	Imaginary Impedance (johm)	Delta (johm)
2016-09-21	5200MHz	-28.6	/	48.6	/	3.40	/
2017-09-20		-26.4	7.7	50.0	1.4	3.72	0.32
2018-09-18		-24.6	14.0	51.2	2.6	3.85	0.45
2016-09-21	5300MHz	-32.3	/	49.6	/	2.40	/
2017-09-20		-30.5	5.6	51.3	1.7	3.64	1.24
2018-09-18		-28.9	10.5	52.6	3.0	3.77	1.37
2016-09-21	5500MHz	-31.7	/	49.5	/	2.50	/
2017-09-20		-29.8	6.0	51.4	1.9	4.25	1.75
2018-09-18		-27.5	13.2	52.8	3.3	4.44	1.94
2016-09-21	5600MHz	-31.7	/	50.8	/	2.50	/
2017-09-20		-29.5	6.9	52.3	1.5	2.91	0.41
2018-09-18		-28.6	9.8	52.9	2.1	3.03	0.53
2016-09-21	5800MHz	-24.0	/	56.0	/	3.00	/
2017-09-20		-22.8	5.0	57.3	1.3	4.23	1.23
2018-09-18		-21.5	10.4	57.8	1.6	4.46	1.46

The Return-Loss is <-20dB, and within 20% of prior calibration; the impedance is within 5 ohm of prior calibration. Therefore the value result should support extended c.

## ANNEX K Spot Check Test

As the test lab for 9540 from Spectralink Corp, we, Shenzhen Academy of Information and Communications Technology, declare on our sole responsibility that, according to “Justification Letter” provided by applicant, only the Spot check test should be performed. The test results are as below.

### K.1 Internal Identification of EUT used during the spot check test

EUT ID*	mac	HW Version	SW Version
EUT 4	00:90:7A:A7:DA:CE	PIO	vF03

### K.2 Measurement results

#### SAR Values (WLAN 2.4G)

Frequency		Test Position		SAR(1g) (W/kg)		
MHz	Ch.			Spot check data		Original data
				Measured SAR	Reported SAR	
<b>Main antenna</b>						
2437	6	Head	Left Touch	<b>0.542</b>	<b>0.62</b>	0.50
2437	6	Body	Rear	0.226	0.26	<b>0.27</b>
<b>Second antenna</b>						
2462	11	Head	Right Touch	0.447	0.49	0.43
2462	11	Body	Rear	<b>0.247</b>	<b>0.27</b>	0.19
<b>MIMO</b>						
2412	1	Head	Left Tilt	0.212	0.25	0.30
2412	1	Body	Rear	0.067	0.08	0.14

**SAR Values (WLAN 5G)**

Frequency		Test Position	SAR(1g) (W/kg)			
MHz	Ch.		Spot check data		Original data	
			Measured SAR	Reported SAR		
<b>Main antenna</b>						
5260	52	Head	Left Touch	0.507	<b>0.68</b>	0.22
5700	140		Left Tilt	0.438	0.61	0.30
5825	165		Left Touch	0.325	0.48	0.13
5260	52	Body	Rear	0.099	0.13	0.19
5700	140		Rear	0.193	<b>0.27</b>	0.24
5825	165		Rear	0.132	0.19	0.11
<b>Second antenna</b>						
5260	52	Head	Right Touch	0.241	0.33	0.51
5500	100		Right Tilt	0.415	0.55	0.73
5785	157		Right Tilt	0.521	<b>0.74</b>	0.49
5260	52	Body	Left	0.143	0.20	<b>0.33</b>
5500	100		Top	0.098	0.13	0.33
5785	157		Top	0.117	0.17	0.17
<b>MIMO</b>						
5260	52	Head	Left Tilt	<b>0.673</b>	<b>0.91</b>	0.36
5500	100		Right Touch	0.607	0.76	0.62
5825	165		Right Tilt	0.633	0.77	0.40
5260	52	Body	Top	0.139	0.19	0.36
5500	100		Top	<b>0.432</b>	<b>0.54</b>	0.35
5785	157		Rear	0.235	0.26	0.18

**Wi-Fi 2.4G Head**

Date: 2018-7-27

Electronics: DAE4 Sn786

Medium: Head 2450 MHz

Medium parameters used (interpolated):  $f = 2437$  MHz;  $\sigma = 1.831$  S/m;  $\epsilon_r = 38.644$ ;  $\rho = 1000$  kg/m<sup>3</sup>

Ambient Temperature: 22.0°C      Liquid Temperature: 21.5°C

Communication System: UID 0, WiFi (0) Frequency: 2437 MHz Duty Cycle: 1:1

Probe: EX3DV4 - SN3633 ConvF (7.42, 7.42, 7.42)

**Left Cheek Middle/Area Scan (61x61x1):** Interpolated grid: dx=1.000 mm, dy=1.000 mm

Maximum value of SAR (interpolated) = 0.646 W/kg

**Left Cheek Middle/Zoom Scan (5x5x7)/Cube 0:** Measurement grid: dx=5mm, dy=5mm, dz=5mm

Reference Value = 12.32 V/m; Power Drift = -0.03 dB

Peak SAR (extrapolated) = 1.17 W/kg

**SAR(1 g) = 0.542 W/kg; SAR(10 g) = 0.253 W/kg**

Maximum value of SAR (measured) = 0.602 W/kg

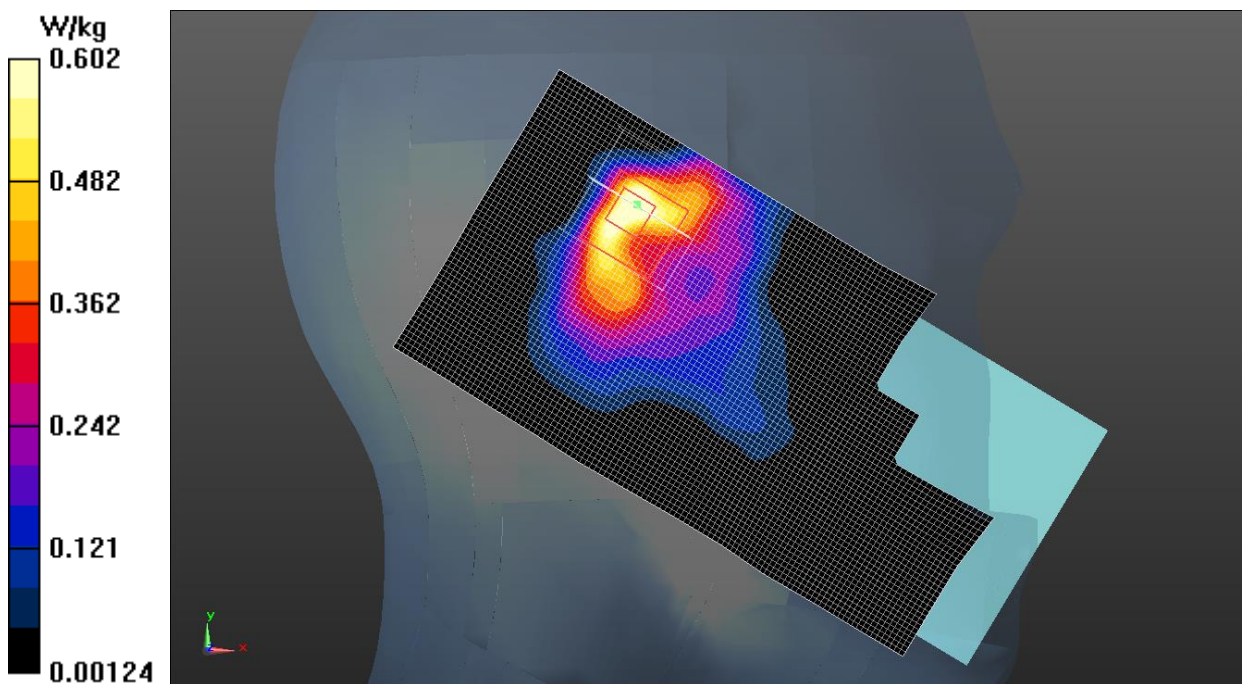



**Wi-Fi 2.4G Body**

Date: 2018-7-27

Electronics: DAE4 Sn786

Medium: Body 2450 MHz

Medium parameters used (interpolated):  $f = 2462$  MHz;  $\sigma = 1.920$  S/m;  $\epsilon_r = 53.825$ ;  $\rho = 1000$  kg/m<sup>3</sup>

Ambient Temperature: 22.0°C      Liquid Temperature: 21.5°C

Communication System: UID 0, WiFi (0) Frequency: 2462 MHz Duty Cycle: 1:1

Probe: EX3DV4 - SN3633 ConvF (7.47, 7.47, 7.47)

**Rear Side High/Area Scan (61x101x1):** Interpolated grid: dx=1.000 mm, dy=1.000 mm

Maximum value of SAR (interpolated) = 0.246 W/kg

**Rear Side High/Zoom Scan (5x5x7)/Cube 0:** Measurement grid: dx=5mm, dy=5mm, dz=5mm

Reference Value = 5.648 V/m; Power Drift = 0.03 dB

Peak SAR (extrapolated) = 0.455 W/kg

**SAR(1 g) = 0.247 W/kg; SAR(10 g) = 0.119 W/kg**

Maximum value of SAR (measured) = 0.295 W/kg

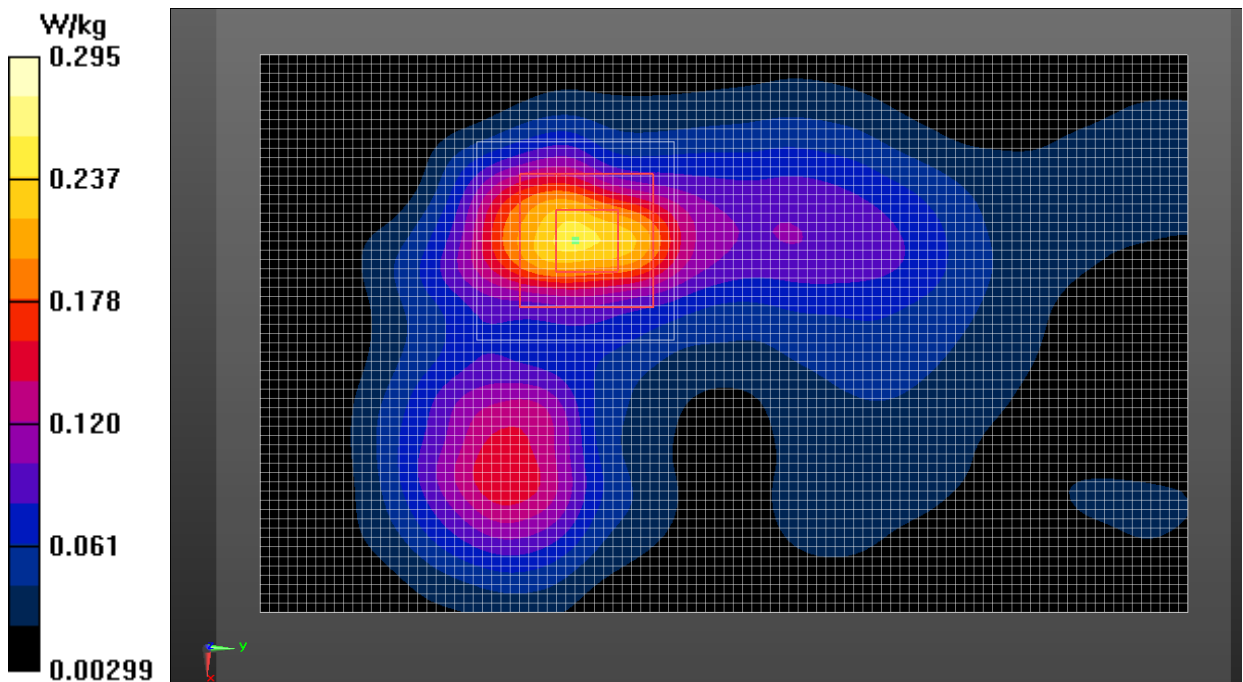

**Wi-Fi 5G Head**

Date: 2018-7-27

Electronics: DAE4 Sn786

Medium: Head 5300 MHz

Medium parameters used:  $f = 5260$  MHz;  $\sigma = 4.767$  S/m;  $\epsilon_r = 35.562$ ;  $\rho = 1000$  kg/m<sup>3</sup>

Ambient Temperature: 22.0°C      Liquid Temperature: 21.5°C

Communication System: UID 0, WIFI 5G (0) Frequency: 5260 MHz Duty Cycle: 1:1

Probe: EX3DV4 - SN3633 ConvF (5.61, 5.61, 5.61)

**Left Tilt CH52/Area Scan (61x61x1):** Interpolated grid: dx=1.000 mm, dy=1.000 mm

Maximum value of SAR (interpolated) = 1.71 W/kg

**Left Tilt CH52/Zoom Scan (5x5x7)/Cube 0:** Measurement grid: dx=4mm, dy=4mm, dz=1.4mm

Reference Value = 4.730 V/m; Power Drift = 0.01 dB

Peak SAR (extrapolated) = 2.64 W/kg

**SAR(1 g) = 0.673 W/kg; SAR(10 g) = 0.194 W/kg**

Maximum value of SAR (measured) = 0.712 W/kg

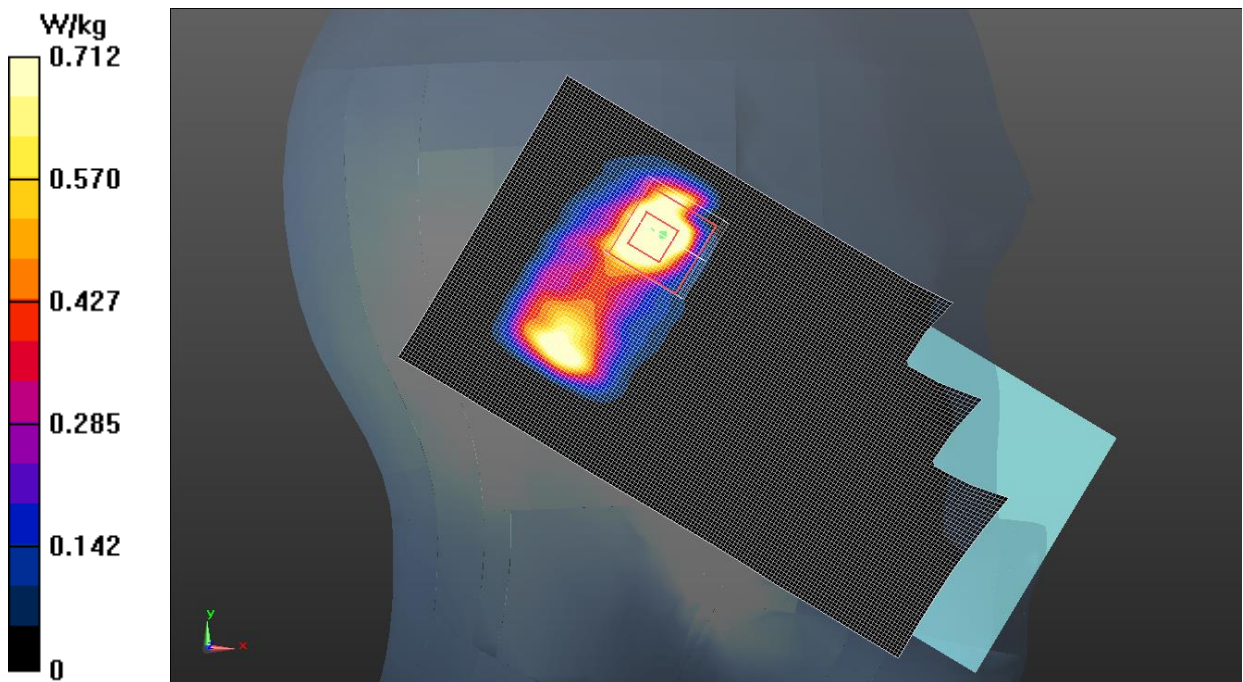

**Wi-Fi 5G Body**

Date: 2018-7-27

Electronics: DAE4 Sn786

Medium: Body 5600 MHz

Medium parameters used:  $f = 5500$  MHz;  $\sigma = 5.598$  S/m;  $\epsilon_r = 48.716$ ;  $\rho = 1000$  kg/m<sup>3</sup>

Ambient Temperature: 22.0°C      Liquid Temperature: 21.5°C

Communication System: UID 0, WIFI 5G (0) Frequency: 5500 MHz Duty Cycle: 1:1

Probe: EX3DV4 - SN3633 ConvF (4.33, 4.33, 4.33)

**Top side CH100/Area Scan (51x91x1):** Interpolated grid: dx=1.000 mm, dy=1.000 mm

Maximum value of SAR (interpolated) = 0.319 W/kg

**Top side CH100/Zoom Scan (7x7x7)/Cube 0:** Measurement grid: dx=4mm, dy=4mm, dz=1.4mm

Reference Value = 5.050 V/m; Power Drift = 0.09 dB

Peak SAR (extrapolated) = 2.42 W/kg

**SAR(1 g) = 0.432 W/kg; SAR(10 g) = 0.179 W/kg**

Maximum value of SAR (measured) = 0.350 W/kg

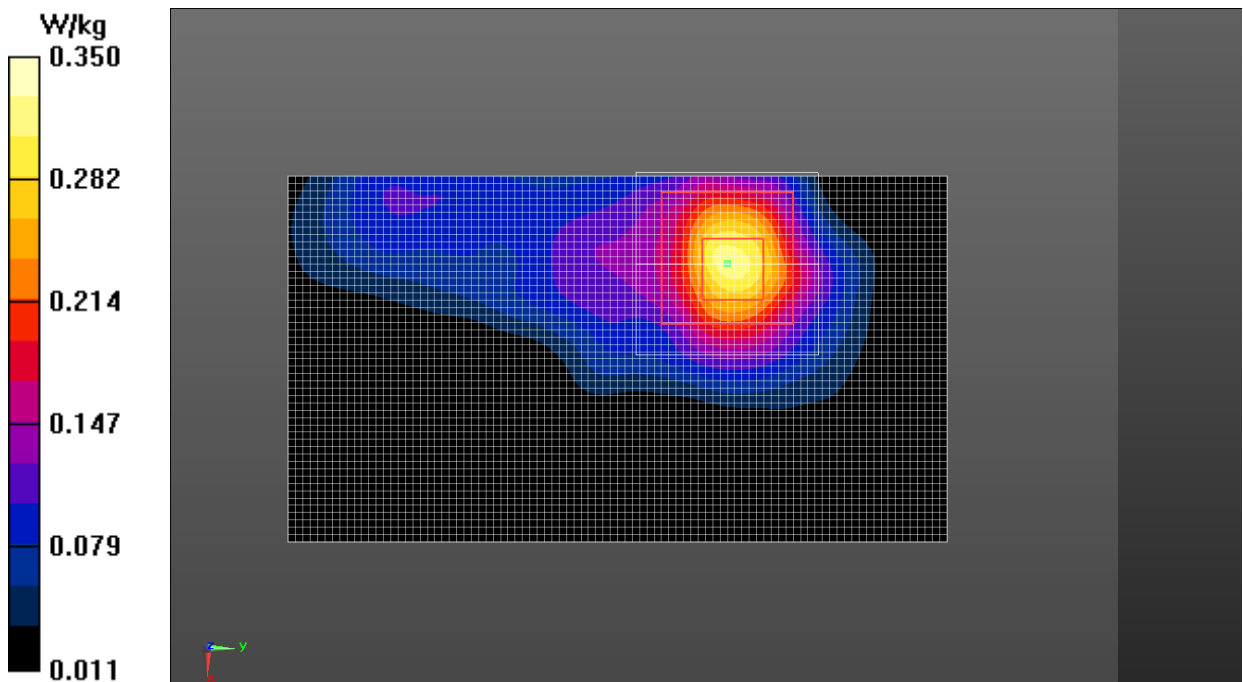

## ANNEX L System Verification Results for Spot Check Test

### 2450MHz

Date: 2018-7-27

Electronics: DAE4 Sn786

Medium: Head 2450 MHz

Medium parameters used:  $f = 2450 \text{ MHz}$ ;  $\sigma = 1.843 \text{ S/m}$ ;  $\epsilon_r = 38.588$ ;  $\rho = 1000 \text{ kg/m}^3$

Ambient Temperature:  $22.0^\circ\text{C}$       Liquid Temperature:  $21.6^\circ\text{C}$

Communication System: CW Frequency: 2450 MHz Duty Cycle: 1:1

Probe: EX3DV4 – SN3633 ConvF (7.42, 7.42, 7.42);

**System Validation /Area Scan (61x81x1):** Interpolated grid:  $dx=1.000 \text{ mm}$ ,  $dy=1.000 \text{ mm}$

Reference Value =  $90.454 \text{ V/m}$ ; Power Drift =  $0.11 \text{ dB}$

**SAR(1 g) =  $13.3 \text{ W/kg}$ ; SAR(10 g) =  $6.11 \text{ W/kg}$**

Maximum value of SAR (interpolated) =  $15.1 \text{ W/kg}$

**System Validation /Zoom Scan (7x7x7)/Cube 0:** Measurement grid:  $dx=5\text{mm}$ ,  $dy=5\text{mm}$ ,  $dz=5\text{mm}$

Reference Value =  $90.454 \text{ V/m}$ ; Power Drift =  $0.11 \text{ dB}$

Peak SAR (extrapolated) =  $24.8 \text{ W/kg}$

**SAR(1 g) =  $13.5 \text{ W/kg}$ ; SAR(10 g) =  $6.14 \text{ W/kg}$**

Maximum value of SAR (measured) =  $15.4 \text{ W/kg}$

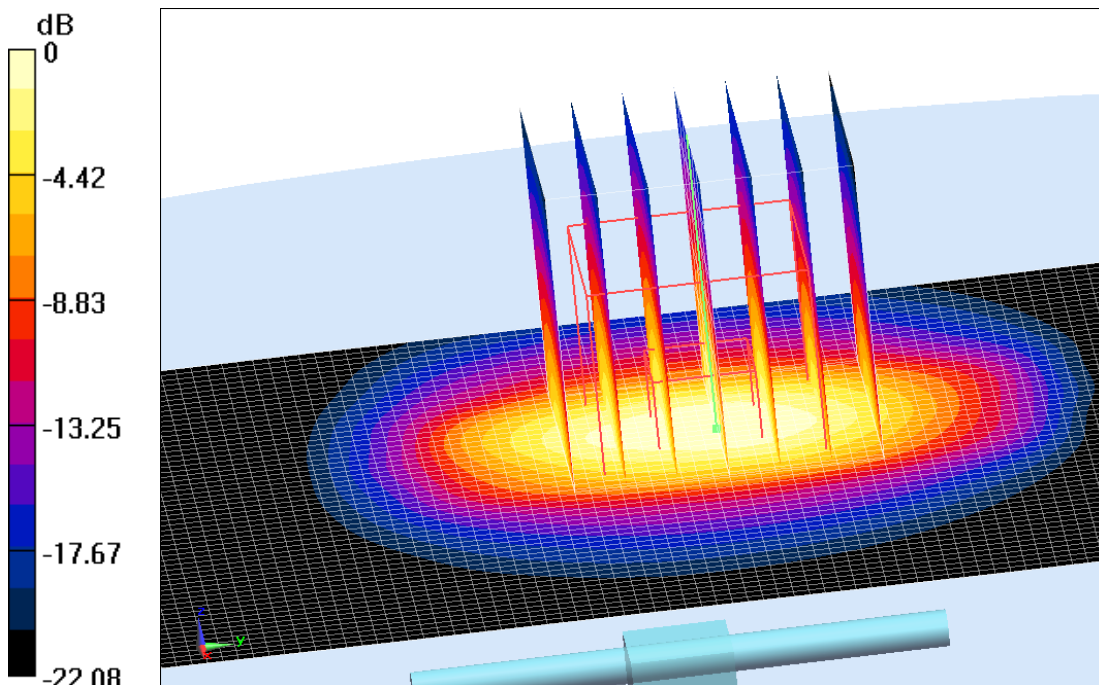

0 dB =  $15.4 \text{ W/kg}$  =  $11.88 \text{ dB W/kg}$

## 2450MHz

Date: 2018-7-27

Electronics: DAE4 Sn786

Medium: Body 2450 MHz

Medium parameters used:  $f = 2450 \text{ MHz}$ ;  $\sigma = 1.907 \text{ S/m}$ ;  $\epsilon_r = 53.862$ ;  $\rho = 1000 \text{ kg/m}^3$

Ambient Temperature:  $22.0^\circ\text{C}$       Liquid Temperature:  $21.6^\circ\text{C}$

Communication System: CW Frequency: 2450 MHz Duty Cycle: 1:1

Probe: EX3DV4 – SN3633 ConvF (7.47, 7.47, 7.47);

**System Validation/Area Scan (81x101x1):** Interpolated grid:  $dx=1.000 \text{ mm}$ ,  $dy=1.000 \text{ mm}$

Reference Value =  $86.225 \text{ V/m}$ ; Power Drift =  $-0.07 \text{ dB}$

**SAR(1 g) =  $12.7 \text{ W/kg}$ ; SAR(10 g) =  $6.05 \text{ W/kg}$**

Maximum value of SAR (interpolated) =  $14.0 \text{ W/kg}$

**System Validation/Zoom Scan (7x7x7)/Cube 0:** Measurement grid:  $dx=5\text{mm}$ ,  $dy=5\text{mm}$ ,  $dz=5\text{mm}$

Reference Value =  $86.225 \text{ V/m}$ ; Power Drift =  $-0.07 \text{ dB}$

Peak SAR (extrapolated) =  $22.5 \text{ W/kg}$

**SAR(1 g) =  $12.5 \text{ W/kg}$ ; SAR(10 g) =  $5.97 \text{ W/kg}$**

Maximum value of SAR (measured) =  $13.8 \text{ W/kg}$

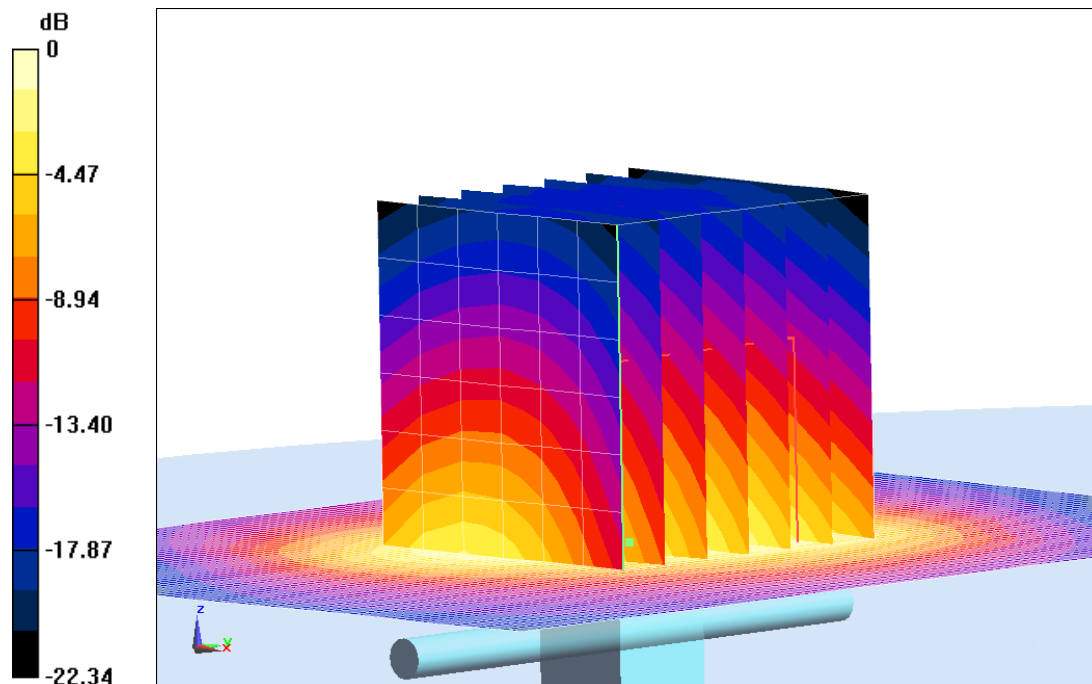

0 dB =  $13.8 \text{ W/kg}$  =  $11.40 \text{ dB W/kg}$



## 5300MHz

Date: 2018-7-27

Electronics: DAE4 Sn786

Medium: Head 5300 MHz

Medium parameters used:  $f = 5300$  MHz;  $\sigma = 4.832$  S/m;  $\epsilon_r = 35.44$ ;  $\rho = 1000$  kg/m<sup>3</sup>

Ambient Temperature: 23.0°C      Liquid Temperature: 22.5°C

Communication System: CW Frequency: 5300 MHz Duty Cycle: 1:1

Probe: EX3DV4 - SN3633 ConvF (5.61, 5.61, 5.61);

**System Validation /Area Scan (91x91x1):** Interpolated grid: dx=1.000 mm, dy=1.000 mm

Reference Value = 58.962 V/m; Power Drift = 0.02 dB

**SAR(1 g) = 8.58 W/kg; SAR(10 g) = 2.42 W/kg**

Maximum value of SAR (interpolated) =10.5 W/kg

**System Validation/Zoom Scan (8x8x8)/Cube0:** Measurement grid: dx=4mm, dy=4mm, dz=4mm

Reference Value = 58.962 V/m; Power Drift = 0.02 dB

Peak SAR (extrapolated) = 32.3 W/kg

**SAR(1 g) = 8.64 W/kg; SAR(10 g) = 2.44 W/kg**

Maximum value of SAR (measured) =10.7 W/kg

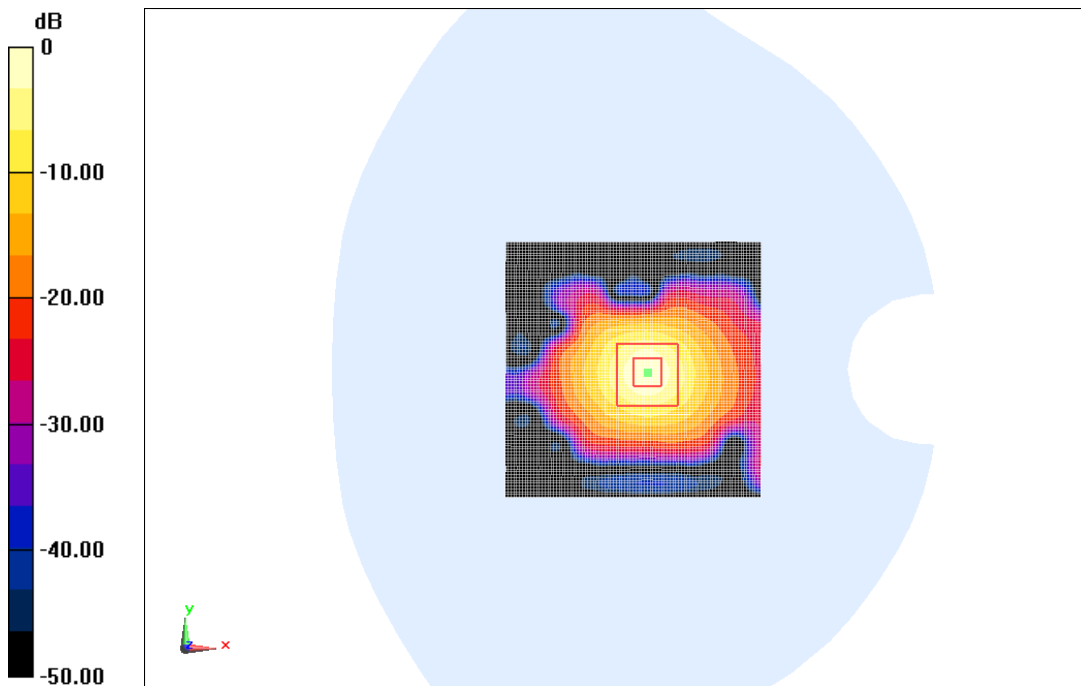

0 dB = 10.7 W/kg = 10.29 dB W/kg

## 5300MHz

Date: 2018-7-27

Electronics: DAE4 Sn786

Medium: Body 5300 MHz

Medium parameters used:  $f = 5300$  MHz;  $\sigma = 5.368$  S/m;  $\epsilon_r = 50.193$ ;  $\rho = 1000$  kg/m<sup>3</sup>

Ambient Temperature: 23.0°C      Liquid Temperature: 22.5°C

Communication System: CW Frequency: 5300 MHz Duty Cycle: 1:1

Probe: EX3DV4 - SN3633 ConvF (5.15, 5.15, 5.15);

**System Validation /Area Scan (91x91x1):** Interpolated grid: dx=1.000 mm, dy=1.000 mm

Reference Value = 56.488 V/m; Power Drift = -0.03 dB

**SAR(1 g) = 7.42 W/kg; SAR(10 g) = 2.14 W/kg**

Maximum value of SAR (interpolated) = 9.79 W/kg

**System Validation/Zoom Scan (8x8x8)/Cube0:** Measurement grid: dx=4mm, dy=4mm, dz=4mm

Reference Value = 56.488 V/m; Power Drift = -0.03 dB

Peak SAR (extrapolated) = 26.9 W/kg

**SAR(1 g) = 7.38 W/kg; SAR(10 g) = 2.11 W/kg**

Maximum value of SAR (measured) = 9.74 W/kg

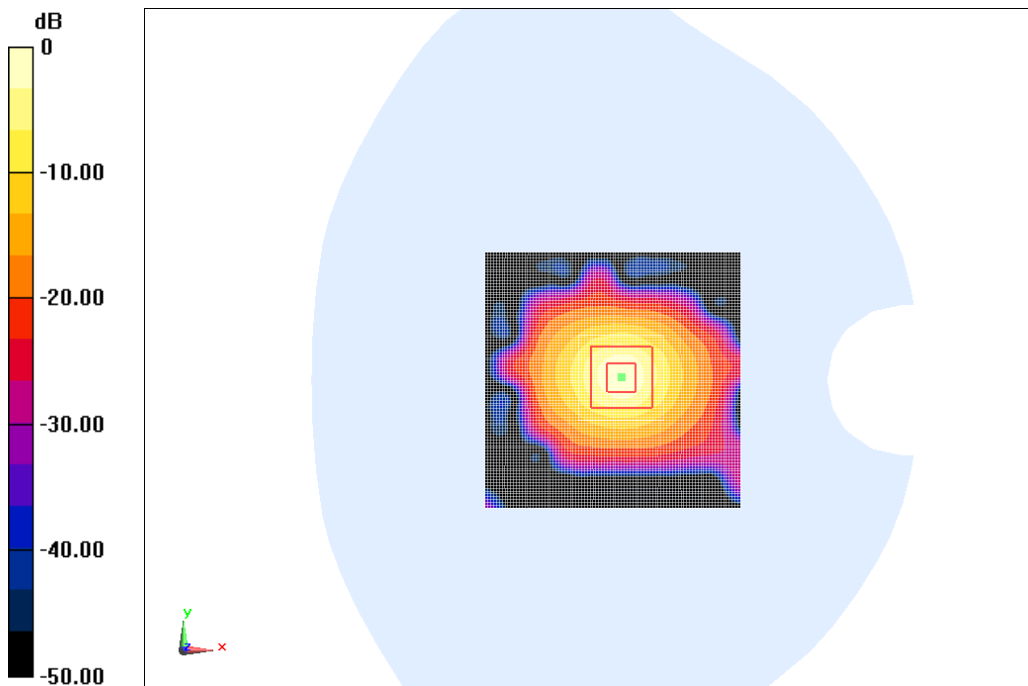

0 dB = 9.74 W/kg = 9.89 dB W/kg

## 5600MHz

Date: 2018-7-27

Electronics: DAE4 Sn786

Medium: Head 5600 MHz

Medium parameters used:  $f = 5600$  MHz;  $\sigma = 5.224$  S/m;  $\epsilon_r = 34.546$ ;  $\rho = 1000$  kg/m<sup>3</sup>

Ambient Temperature: 23.0°C      Liquid Temperature: 22.5°C

Communication System: CW Frequency: 5600 MHz Duty Cycle: 1:1

Probe: EX3DV4 - SN3633 ConvF (4.86, 4.86, 4.86);

**System Validation /Area Scan (91x91x1):** Interpolated grid: dx=1.000 mm, dy=1.000 mm

Reference Value = 68.042 V/m; Power Drift = 0.08 dB

**SAR(1 g) = 8.49 W/kg; SAR(10 g) = 2.37 W/kg**

Maximum value of SAR (interpolated) = 10.0 W/kg

**System Validation/Zoom Scan (8x8x8)/Cube0:** Measurement grid: dx=4mm, dy=4mm, dz=4mm

Reference Value = 68.042 V/m; Power Drift = 0.08 dB

Peak SAR (extrapolated) = 30.2 W/kg

**SAR(1 g) = 8.57 W/kg; SAR(10 g) = 2.39 W/kg**

Maximum value of SAR (measured) = 10.1 W/kg

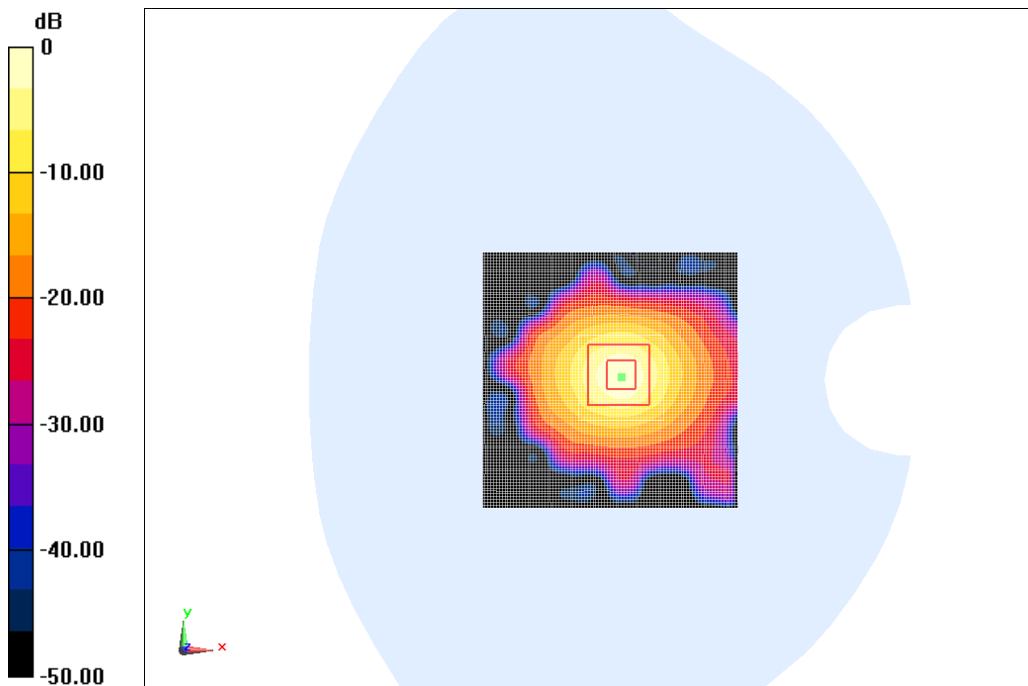

0 dB = 10.3 W/kg = 10.04 dB W/kg

## 5600MHz

Date: 2018-7-27

Electronics: DAE4 Sn786

Medium: Body 5600 MHz

Medium parameters used:  $f = 5600$  MHz;  $\sigma = 5.805$  S/m;  $\epsilon_r = 48.122$ ;  $\rho = 1000$  kg/m<sup>3</sup>

Ambient Temperature: 23.0°C      Liquid Temperature: 22.5°C

Communication System: CW Frequency: 5600 MHz Duty Cycle: 1:1

Probe: EX3DV4 - SN3633 ConvF (4.33, 4.33, 4.33);

**System Validation /Area Scan (91x91x1):** Interpolated grid: dx=1.000 mm, dy=1.000 mm

Reference Value = 60.756 V/m; Power Drift = 0.01 dB

**SAR(1 g) = 8.08 W/kg; SAR(10 g) = 2.22 W/kg**

Maximum value of SAR (interpolated) = 9.88 W/kg

**System Validation/Zoom Scan (8x8x8)/Cube0:** Measurement grid: dx=4mm, dy=4mm, dz=4mm

Reference Value = 60.756 V/m; Power Drift = 0.01 dB

Peak SAR (extrapolated) = 28.2 W/kg

**SAR(1 g) = 8.16 W/kg; SAR(10 g) = 2.26 W/kg**

Maximum value of SAR (measured) = 9.92 W/kg

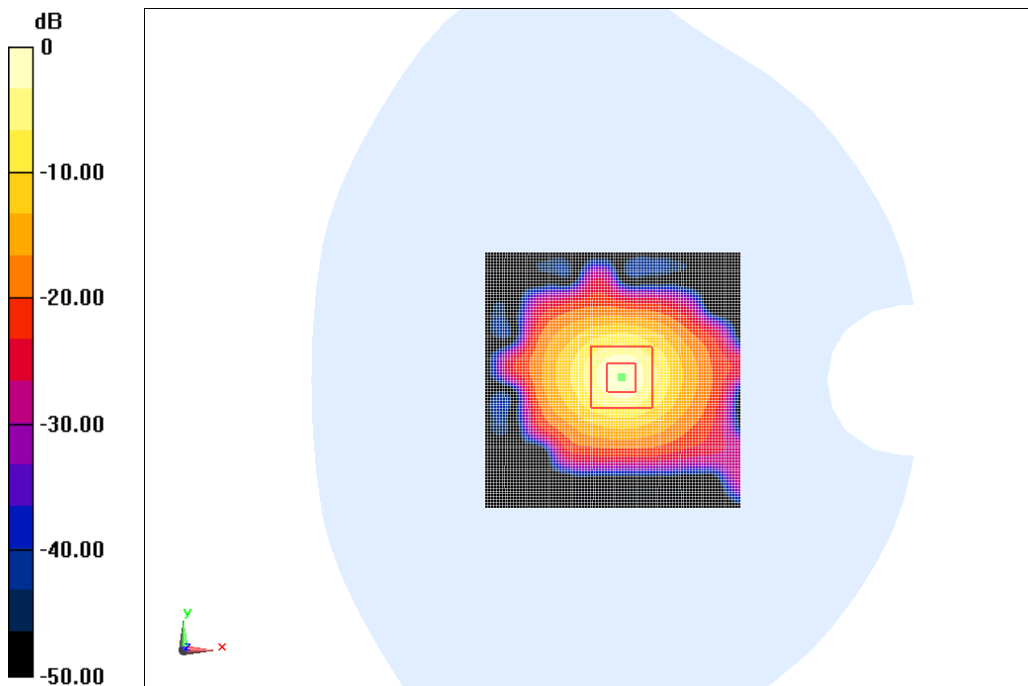

0 dB = 9.92 W/kg = 9.97 dB W/kg

## 5800MHz

Date: 2018-7-27

Electronics: DAE4 Sn786

Medium: Head 5800 MHz

Medium parameters used:  $f = 5800$  MHz;  $\sigma = 5.326$  S/m;  $\epsilon_r = 34.68$ ;  $\rho = 1000$  kg/m<sup>3</sup>

Ambient Temperature: 23.0°C      Liquid Temperature: 22.5°C

Communication System: CW Frequency: 5800 MHz Duty Cycle: 1:1

Probe: EX3DV4 - SN3633 ConvF (4.81, 4.81, 4.81);

**System Validation/Area Scan (91x91x1):** Interpolated grid: dx=1.000 mm, dy=1.000 mm

Reference Value = 59.825 V/m; Power Drift = -0.09 dB

**SAR(1 g) = 7.70 W/kg; SAR(10 g) = 2.22 W/kg**

Maximum value of SAR (interpolated) = 9.73 W/kg

**System Validation/Zoom Scan (8x8x8)/Cube0:** Measurement grid: dx=4mm, dy=4mm, dz=4mm

Reference Value = 59.825 V/m; Power Drift = -0.09 dB

Peak SAR (extrapolated) = 27.7 W/kg

**SAR(1 g) = 7.62 W/kg; SAR(10 g) = 2.19 W/kg**

Maximum value of SAR (measured) = 9.66 W/kg

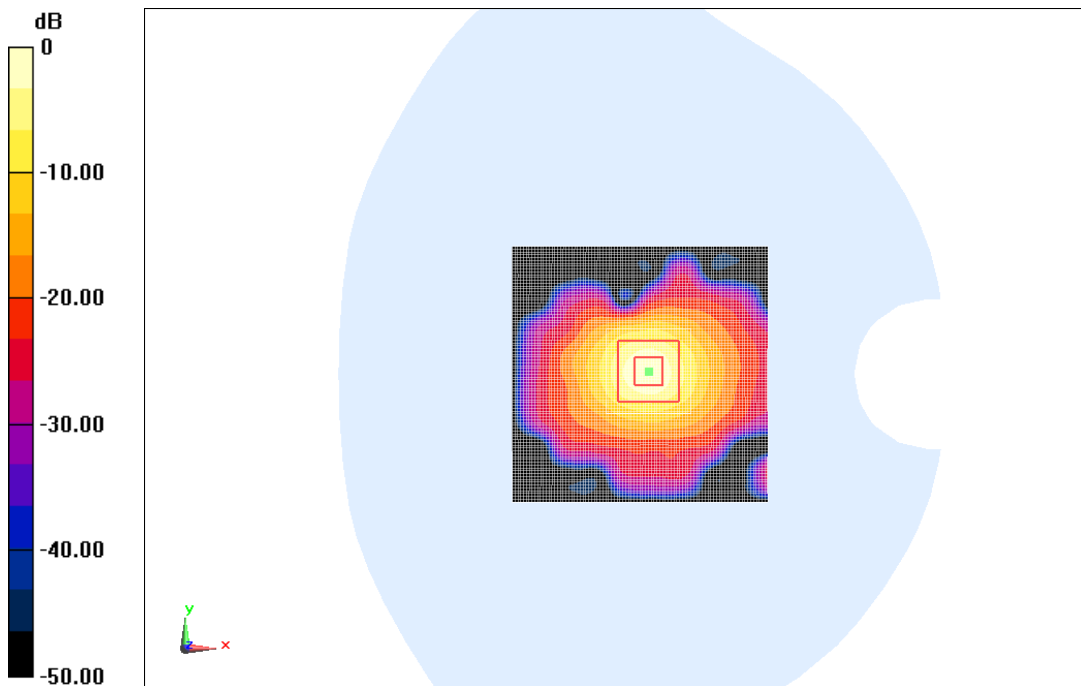

0 dB = 9.66 W/kg = 9.85 dB W/kg



## 5800MHz

Date: 2018-7-27

Electronics: DAE4 Sn786

Medium: Body 5800 MHz

Medium parameters used:  $f = 5800$  MHz;  $\sigma = 6.108$  S/m;  $\epsilon_r = 47.538$ ;  $\rho = 1000$  kg/m<sup>3</sup>

Ambient Temperature: 23.0°C      Liquid Temperature: 22.5°C

Communication System: CW Frequency: 5800 MHz Duty Cycle: 1:1

Probe: EX3DV4 - SN3633 ConvF (4.48, 4.48, 4.48);

**System Validation/Area Scan (91x91x1):** Interpolated grid: dx=1.000 mm, dy=1.000 mm

Reference Value = 60.982 V/m; Power Drift = 0.12 dB

**SAR(1 g) = 7.69 W/kg; SAR(10 g) = 2.10 W/kg**

Maximum value of SAR (interpolated) = 9.81 W/kg

**System Validation/Zoom Scan (8x8x8)/Cube0:** Measurement grid: dx=4mm, dy=4mm, dz=4mm

Reference Value = 60.982 V/m; Power Drift = 0.12 dB

Peak SAR (extrapolated) = 28.0 W/kg

**SAR(1 g) = 7.78 W/kg; SAR(10 g) = 2.13 W/kg**

Maximum value of SAR (measured) = 9.86 W/kg

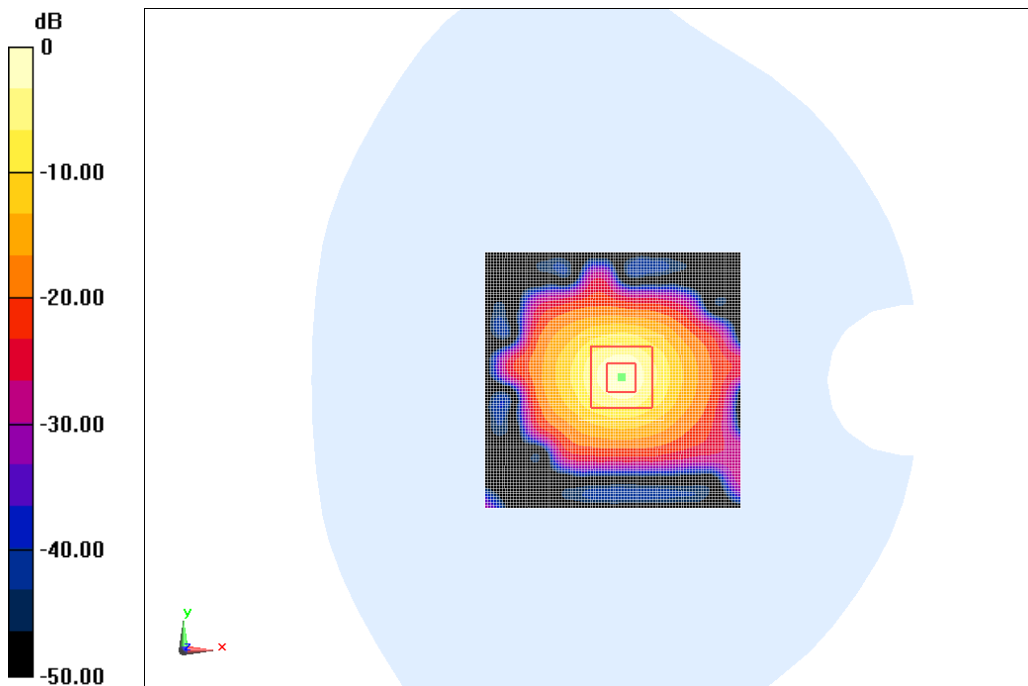

0 dB = 9.86 W/kg = 9.94 dB W/kg

## ANNEX M Second Spot Check Test

As the test lab for 9540 from Spectralink Corp, we, Shenzhen Academy of Information and Communications Technology, declare on our sole responsibility that, according to “Justification Letter” provided by applicant, only the Spot check test should be performed. The test results are as below.

### M.1 Internal Identification of EUT used during the spot check test

EUT ID*	mac	HW Version	SW Version
EUT 5	00:90:7A:A7:DA:D4	PIO	vF03

Note: Battery - NINGBO VEKEN BATTERY CO., LTD

### M.2 Measurement results

#### SAR Values (WLAN 2.4G)

Frequency		Test Position		SAR(1g) (W/kg)		
MHz	Ch.			Spot check data		Original data
				Measured SAR	Reported SAR	
Main antenna						
2437	6	Head	Left Touch	0.355	0.41	0.62
2437	6	Body	Rear	0.149	0.17	<b>0.27</b>
Second antenna						
2462	11	Head	Right Touch	<b>0.618</b>	<b>0.68</b>	0.49
2462	11	Body	Rear	<b>0.244</b>	<b>0.27</b>	<b>0.27</b>
MIMO						
2412	1	Head	Left Tilt	0.123	0.15	0.30
2412	1	Body	Rear	0.074	0.09	0.14

#### SAR Values (WLAN 5G)

Frequency		Test Position		SAR(1g) (W/kg)		
MHz	Ch.			Spot check data		Original data
				Measured SAR	Reported SAR	
Main antenna						
5260	52	Head	Left Touch	0.042	0.06	0.68
5700	140	Body	Rear	<b>0.271</b>	0.40	0.27
Second antenna						
5785	157	Head	Right Tilt	<b>0.638</b>	<b>0.91</b>	0.74
5260	52	Body	Left	0.153	0.21	0.33
MIMO						
5260	52	Head	Left Tilt	0.540	0.73	<b>0.91</b>
5500	100	Body	Top	0.157	0.20	<b>0.54</b>

### M.3 Graph Results for Spot Check

#### Wi-Fi 2.4G Head

Date: 2019-1-25

Electronics: DAE4 Sn1527

Medium: Head 2450 MHz

Medium parameters used:  $f = 2462$  MHz;  $\sigma = 1.871$  S/m;  $\epsilon_r = 38.693$ ;  $\rho = 1000$  kg/m<sup>3</sup>

Ambient Temperature: 22.0°C      Liquid Temperature: 21.5°C

Communication System: UID 0, WiFi (0) Frequency: 2462 MHz Duty Cycle: 1:1

Probe: EX3DV4 – SN3633 ConvF (7.42, 7.42, 7.42);

**Right Cheek High/Area Scan (61x101x1):** Interpolated grid: dx=1.000 mm, dy=1.000 mm

Maximum value of SAR (interpolated) = 0.698 W/kg

**Right Cheek High/Zoom Scan (5x5x7)/Cube 0:** Measurement grid: dx=5mm, dy=5mm, dz=5mm

Reference Value = 12.52 V/m; Power Drift = 0.14 dB

Peak SAR (extrapolated) = 1.54 W/kg

**SAR(1 g) = 0.618 W/kg; SAR(10 g) = 0.289 W/kg**

Maximum value of SAR (measured) = 0.664 W/kg

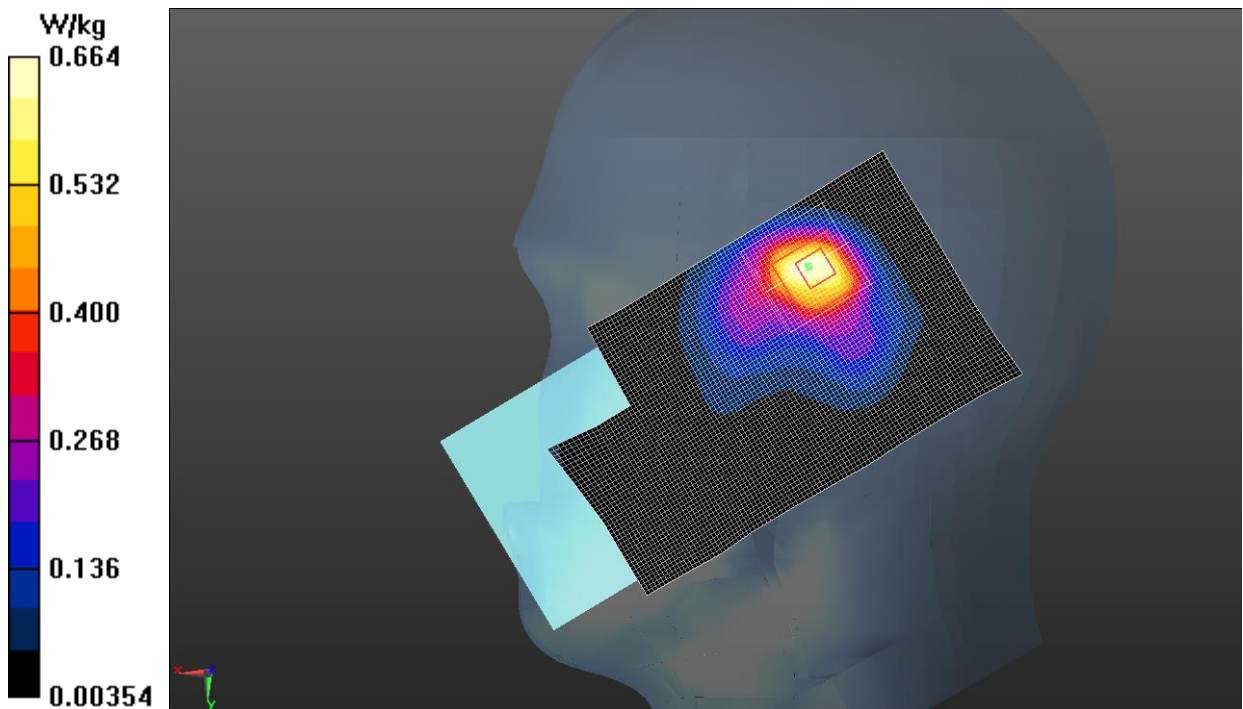

**Wi-Fi 2.4G Body**

Date: 2019-1-25

Electronics: DAE4 Sn1527

Medium: Body 2450 MHz

Medium parameters used:  $f = 2462$  MHz;  $\sigma = 1.943$  S/m;  $\epsilon_r = 53.495$ ;  $\rho = 1000$  kg/m<sup>3</sup>

Ambient Temperature: 22.0°C      Liquid Temperature: 21.5°C

Communication System: UID 0, WiFi (0) Frequency: 2462 MHz Duty Cycle: 1:1

Probe: EX3DV4 – SN3633 ConvF (7.47, 7.47, 7.47);

**Rear Side High/Area Scan (61x101x1):** Interpolated grid: dx=1.000 mm, dy=1.000 mm

Maximum value of SAR (interpolated) = 0.269 W/kg

**Rear Side High/Zoom Scan (5x5x7)/Cube 0:** Measurement grid: dx=5mm, dy=5mm, dz=5mm

Reference Value = 4.984 V/m; Power Drift = 0.04 dB

Peak SAR (extrapolated) = 0.440 W/kg

**SAR(1 g) = 0.244 W/kg; SAR(10 g) = 0.132 W/kg**

Maximum value of SAR (measured) = 0.268 W/kg

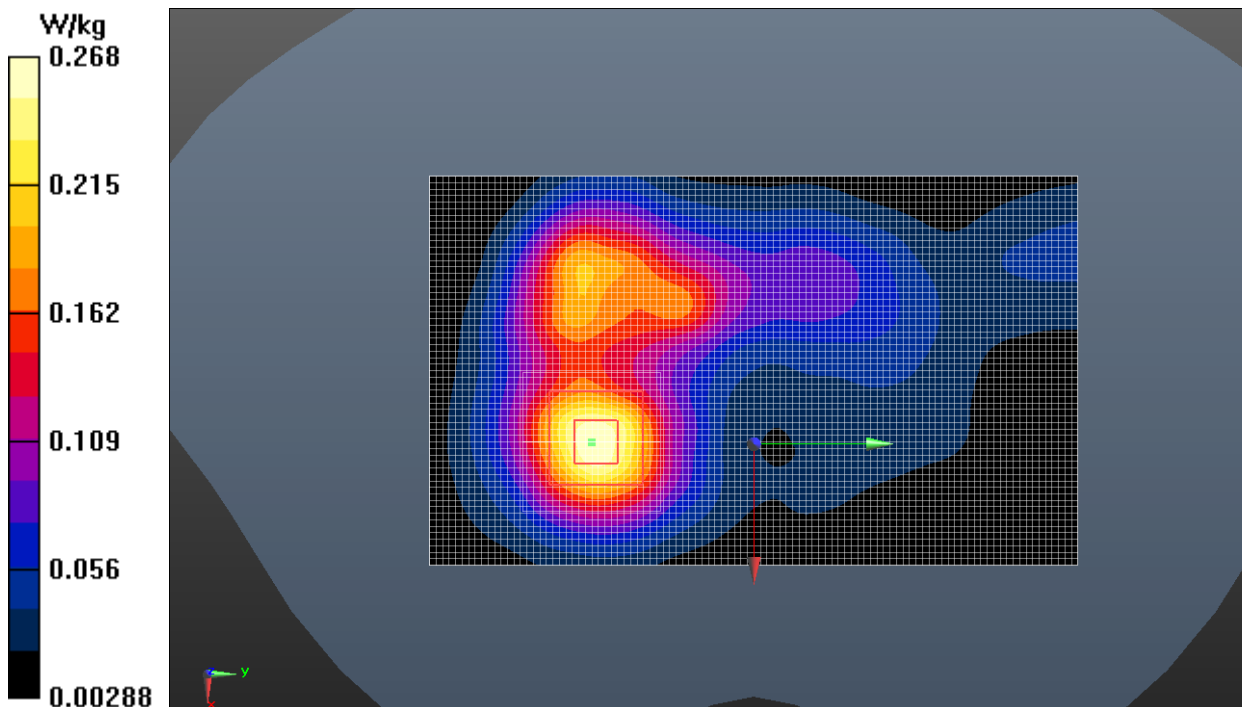

**Wi-Fi 5G Head**

Date: 2019-1-22

Electronics: DAE4 Sn1527

Medium: Head 5800 MHz

Medium parameters used:  $f = 5785$  MHz;  $\sigma = 5.348$  S/m;  $\epsilon_r = 34.921$ ;  $\rho = 1000$  kg/m<sup>3</sup>

Ambient Temperature: 22.0°C      Liquid Temperature: 21.5°C

Communication System: UID 0, WIFI 5G (0) Frequency: 5785 MHz Duty Cycle: 1:1

Probe: EX3DV4 - SN3633 ConvF (4.81, 4.81, 4.81);

**Right Tilt CH157/Area Scan (71x131x1):** Interpolated grid: dx=1.000 mm, dy=1.000 mm

Maximum value of SAR (interpolated) = 1.18 W/kg

**Right Tilt CH157/Zoom Scan (7x7x7)/Cube 0:** Measurement grid: dx=4mm, dy=4mm, dz=1.4mm

Reference Value = 1.680 V/m; Power Drift = 0.04 dB

Peak SAR (extrapolated) = 2.89 W/kg

**SAR(1 g) = 0.638 W/kg; SAR(10 g) = 0.202 W/kg**

Maximum value of SAR (measured) = 1.26 W/kg

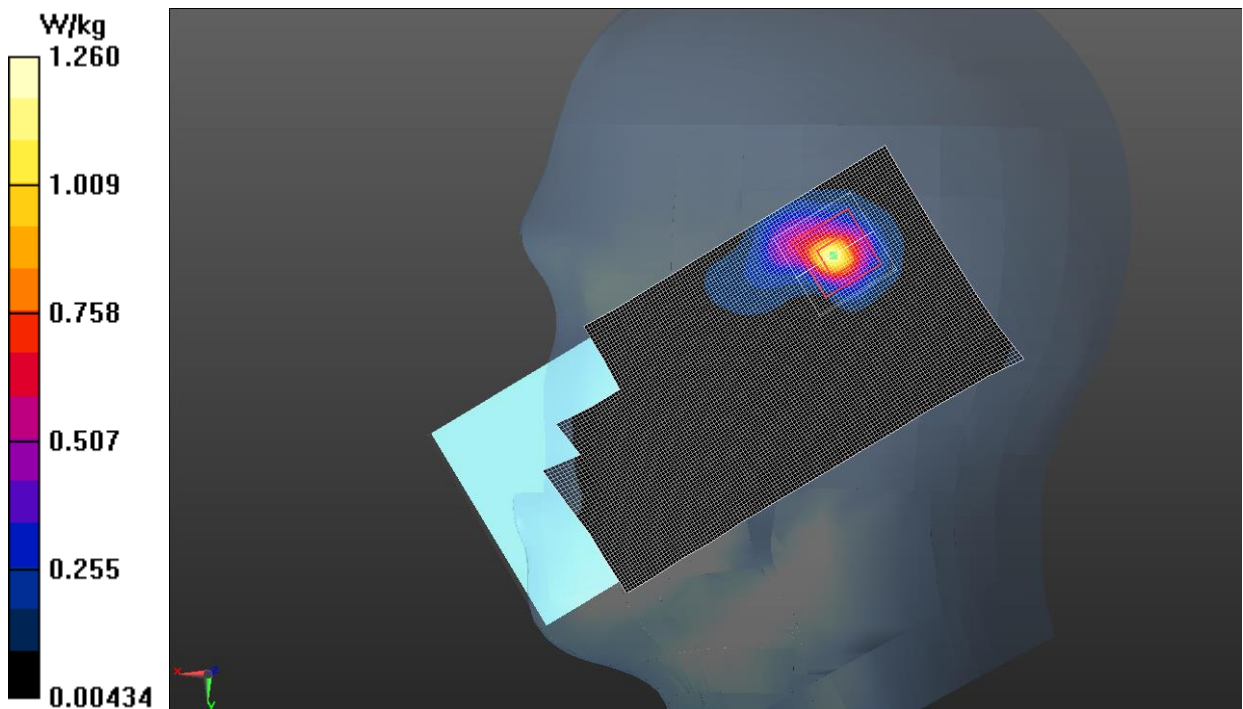



**Wi-Fi 5G Body**

Date: 2019-1-22

Electronics: DAE4 Sn1527

Medium: Body 5600 MHz

Medium parameters used:  $f = 5700$  MHz;  $\sigma = 6.163$  S/m;  $\epsilon_r = 47.034$ ;  $\rho = 1000$  kg/m<sup>3</sup>

Ambient Temperature: 22.0°C      Liquid Temperature: 21.5°C

Communication System: UID 0, WIFI 5G (0) Frequency: 5700 MHz Duty Cycle: 1:1

Probe: EX3DV4 - SN3633 ConvF (4.33, 4.33, 4.33);

**Rear Side CH140/Area Scan (131x71x1):** Interpolated grid: dx=1.000 mm, dy=1.000 mm

Maximum value of SAR (interpolated) = 0.555 W/kg

**Rear Side CH140/Zoom Scan (7x7x7)/Cube 0:** Measurement grid: dx=4mm, dy=4mm, dz=1.4mm

Reference Value = 0.2260 V/m; Power Drift = 0.08 dB

Peak SAR (extrapolated) = 2.50 W/kg

**SAR(1 g) = 0.271 W/kg; SAR(10 g) = 0.141 W/kg**

Maximum value of SAR (measured) = 0.701 W/kg

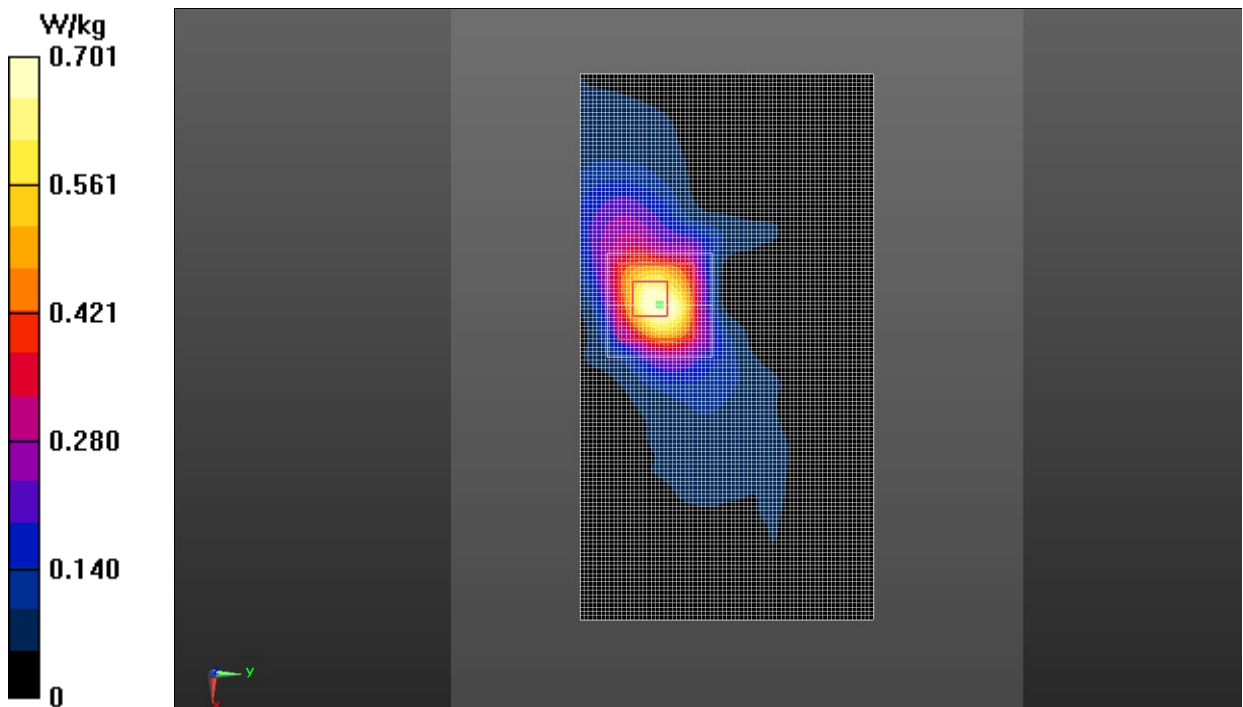

## ANNEX N System Verification Results for Second Spot Check Test

### 2450MHz

Date: 2019-1-25

Electronics: DAE4 Sn1527

Medium: Head 2450 MHz

Medium parameters used:  $f = 2450 \text{ MHz}$ ;  $\sigma = 1.855 \text{ S/m}$ ;  $\epsilon_r = 38.735$ ;  $\rho = 1000 \text{ kg/m}^3$

Ambient Temperature:  $22.0^\circ\text{C}$       Liquid Temperature:  $21.6^\circ\text{C}$

Communication System: CW Frequency: 2450 MHz Duty Cycle: 1:1

Probe: EX3DV4 – SN3633 ConvF (7.42, 7.42, 7.42);

**System Validation /Area Scan (61x81x1):** Interpolated grid:  $dx=1.000 \text{ mm}$ ,  $dy=1.000 \text{ mm}$

Reference Value =  $90.684 \text{ V/m}$ ; Power Drift =  $0.13 \text{ dB}$

**SAR(1 g) =  $13.2 \text{ W/kg}$ ; SAR(10 g) =  $6.05 \text{ W/kg}$**

Maximum value of SAR (interpolated) =  $15.0 \text{ W/kg}$

**System Validation /Zoom Scan (7x7x7)/Cube 0:** Measurement grid:  $dx=5\text{mm}$ ,  $dy=5\text{mm}$ ,  $dz=5\text{mm}$

Reference Value =  $90.684 \text{ V/m}$ ; Power Drift =  $0.13 \text{ dB}$

Peak SAR (extrapolated) =  $26.3 \text{ W/kg}$

**SAR(1 g) =  $13.5 \text{ W/kg}$ ; SAR(10 g) =  $6.16 \text{ W/kg}$**

Maximum value of SAR (measured) =  $15.4 \text{ W/kg}$

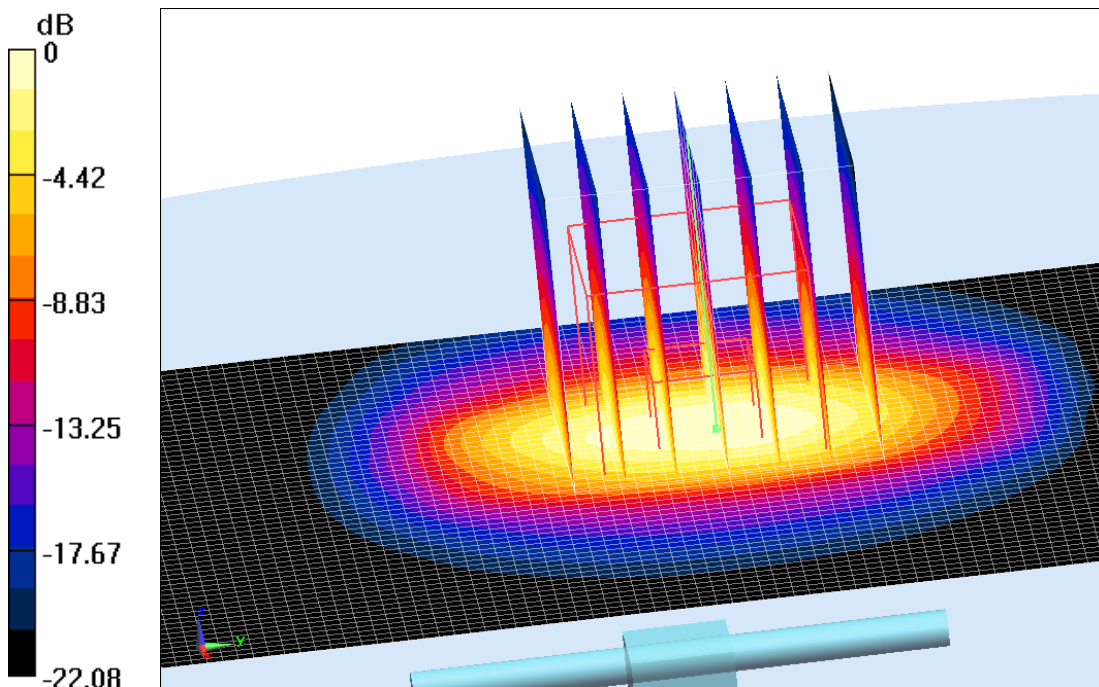

0 dB =  $15.4 \text{ W/kg}$  =  $11.88 \text{ dB W/kg}$

**Fig.N.1 Validation 2450MHz 250mW**

## 2450MHz

Date: 2019-1-25

Electronics: DAE4 Sn1527

Medium: Body 2450 MHz

Medium parameters used:  $f = 2450$  MHz;  $\sigma = 1.928$  S/m;  $\epsilon_r = 53.533$ ;  $\rho = 1000$  kg/m<sup>3</sup>

Ambient Temperature: 22.0°C      Liquid Temperature: 21.6°C

Communication System: CW Frequency: 2450 MHz Duty Cycle: 1:1

Probe: EX3DV4 – SN3633 ConvF (7.47, 7.47, 7.47);

**System Validation/Area Scan (81x101x1):** Interpolated grid: dx=1.000 mm, dy=1.000 mm

Reference Value = 85.361 V/m; Power Drift = -0.01 dB

**SAR(1 g) = 12.4 W/kg; SAR(10 g) = 5.83 W/kg**

Maximum value of SAR (interpolated) = 14.1 W/kg

**System Validation/Zoom Scan (7x7x7)/Cube 0:** Measurement grid: dx=5mm, dy=5mm, dz=5mm

Reference Value = 85.361 V/m; Power Drift = -0.01 dB

Peak SAR (extrapolated) = 24.4 W/kg

**SAR(1 g) = 12.2 W/kg; SAR(10 g) = 5.76 W/kg**

Maximum value of SAR (measured) = 13.8 W/kg

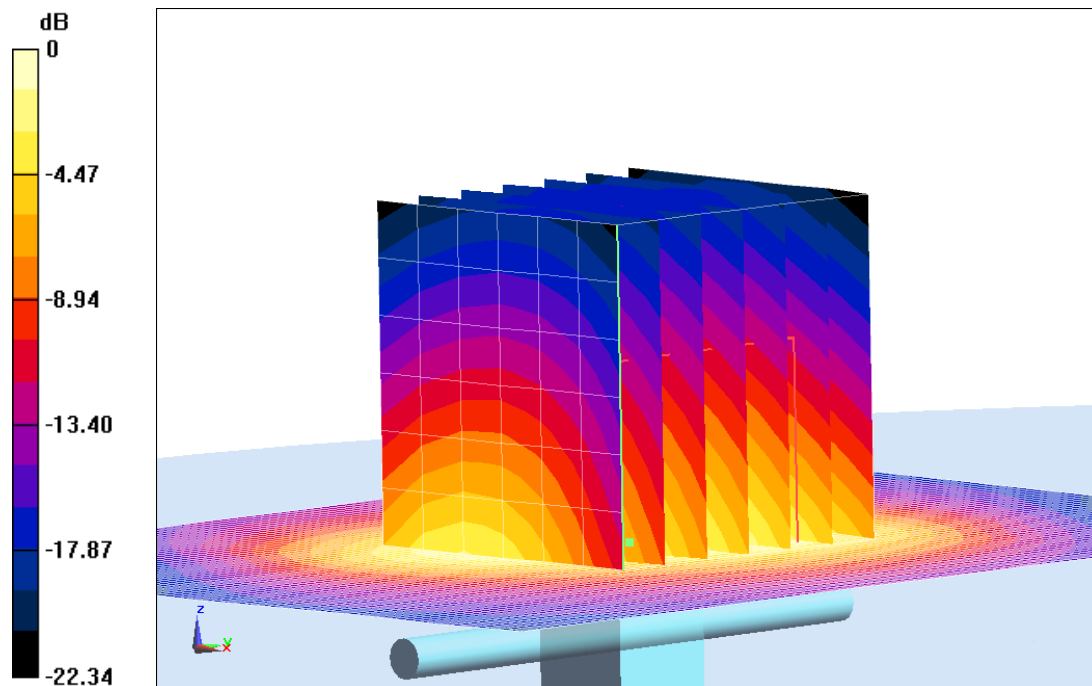

0 dB = 13.8 W/kg = 11.40 dB W/kg

**Fig.N.2 Validation 2450MHz 250mW**

## 5300MHz

Date: 2019-1-22

Electronics: DAE4 Sn1527

Medium: Head 5300 MHz

Medium parameters used:  $f = 5300$  MHz;  $\sigma = 4.655$  S/m;  $\epsilon_r = 36.264$ ;  $\rho = 1000$  kg/m<sup>3</sup>

Ambient Temperature: 23.0°C      Liquid Temperature: 22.5°C

Communication System: CW Frequency: 5300 MHz Duty Cycle: 1:1

Probe: EX3DV4 - SN3633 ConvF (5.61, 5.61, 5.61);

**System Validation /Area Scan (91x91x1):** Interpolated grid: dx=1.000 mm, dy=1.000 mm

Reference Value = 57.621 V/m; Power Drift = -0.08 dB

**SAR(1 g) = 8.12 W/kg; SAR(10 g) = 2.35 W/kg**

Maximum value of SAR (interpolated) = 10.2 W/kg

**System Validation/Zoom Scan (8x8x8)/Cube0:** Measurement grid: dx=4mm, dy=4mm, dz=4mm

Reference Value = 57.621 V/m; Power Drift = -0.08 dB

Peak SAR (extrapolated) = 29.9 W/kg

**SAR(1 g) = 8.05 W/kg; SAR(10 g) = 2.33 W/kg**

Maximum value of SAR (measured) = 9.93 W/kg

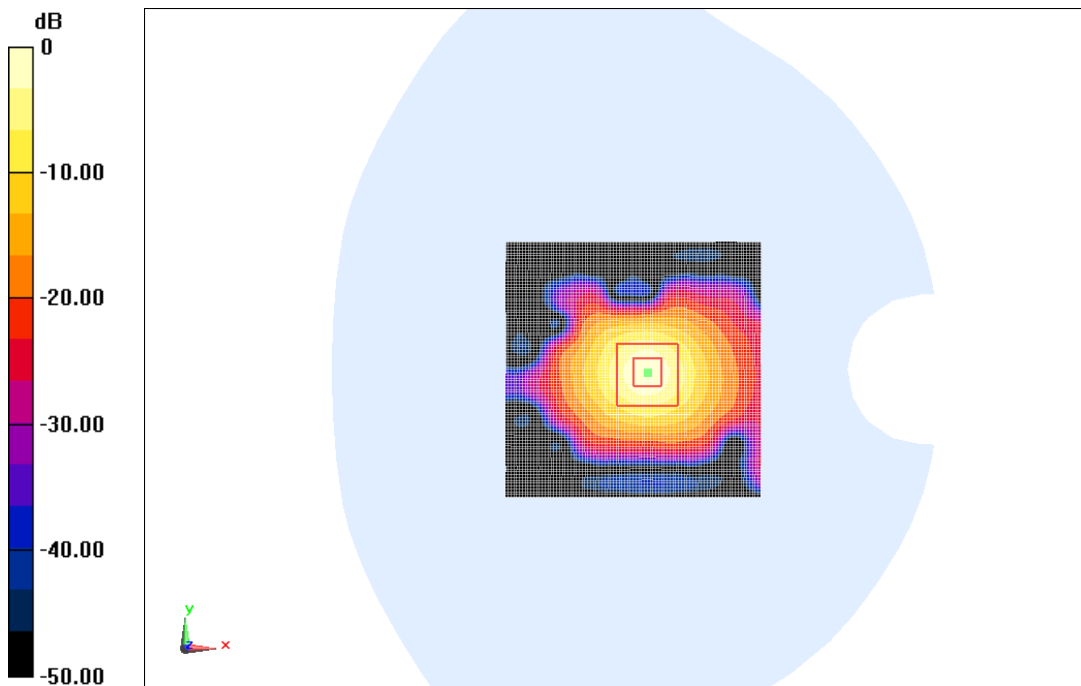

0 dB = 9.93 W/kg = 9.97 dB W/kg

**Fig.N.3 validation 5300MHz 100mW**

## 5300MHz

Date: 2019-1-22

Electronics: DAE4 Sn1527

Medium: Body 5300 MHz

Medium parameters used:  $f = 5300$  MHz;  $\sigma = 5.567$  S/m;  $\epsilon_r = 47.828$ ;  $\rho = 1000$  kg/m<sup>3</sup>

Ambient Temperature: 23.0°C      Liquid Temperature: 22.5°C

Communication System: CW Frequency: 5300 MHz Duty Cycle: 1:1

Probe: EX3DV4 - SN3633 ConvF (5.15, 5.15, 5.15);

**System Validation /Area Scan (91x91x1):** Interpolated grid: dx=1.000 mm, dy=1.000 mm

Reference Value = 56.123 V/m; Power Drift = 0.10 dB

**SAR(1 g) = 7.75 W/kg; SAR(10 g) = 2.16 W/kg**

Maximum value of SAR (interpolated) = 9.82 W/kg

**System Validation/Zoom Scan (8x8x8)/Cube0:** Measurement grid: dx=4mm, dy=4mm, dz=4mm

Reference Value = 56.123 V/m; Power Drift = 0.10 dB

Peak SAR (extrapolated) = 26.3 W/kg

**SAR(1 g) = 7.89 W/kg; SAR(10 g) = 2.19 W/kg**

Maximum value of SAR (measured) = 9.90 W/kg

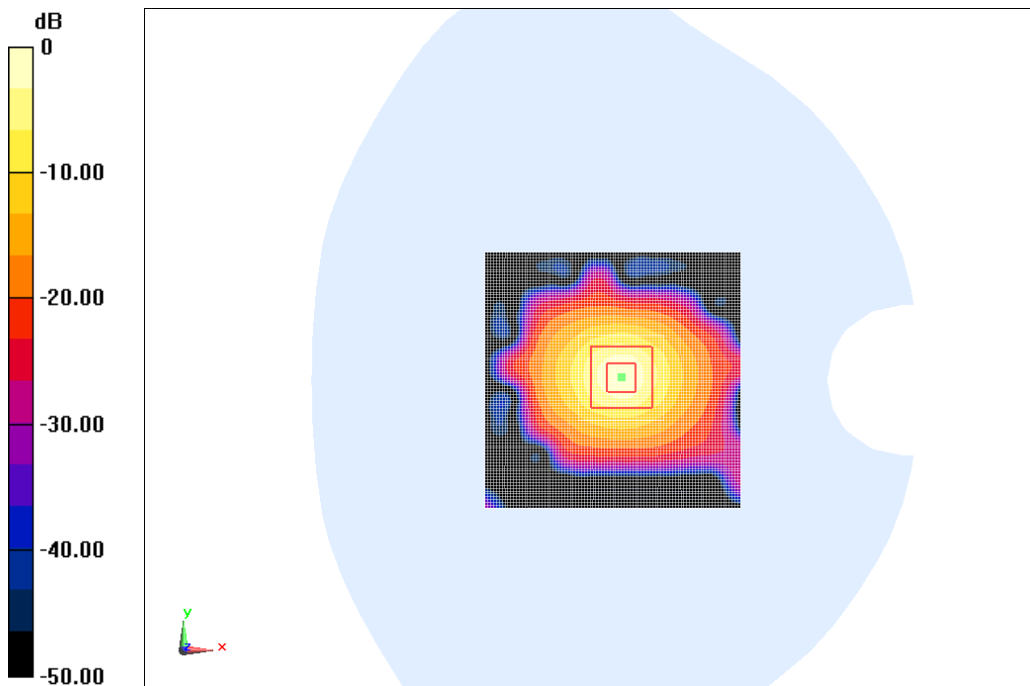

0 dB = 9.90 W/kg = 9.96 dB W/kg

**Fig.N.4 validation 5300MHz 100mW**

## 5600MHz

Date: 2019-1-22

Electronics: DAE4 Sn786

Medium: Body 5600 MHz

Medium parameters used:  $f = 5600$  MHz;  $\sigma = 5.903$  S/m;  $\epsilon_r = 47.787$ ;  $\rho = 1000$  kg/m<sup>3</sup>

Ambient Temperature: 23.0°C      Liquid Temperature: 22.5°C

Communication System: CW Frequency: 5600 MHz Duty Cycle: 1:1

Probe: EX3DV4 - SN3633 ConvF (4.33, 4.33, 4.33);

**System Validation /Area Scan (91x91x1):** Interpolated grid: dx=1.000 mm, dy=1.000 mm

Reference Value = 62.011 V/m; Power Drift = 0.05 dB

**SAR(1 g) = 8.11 W/kg; SAR(10 g) = 2.23 W/kg**

Maximum value of SAR (interpolated) = 9.91 W/kg

**System Validation/Zoom Scan (8x8x8)/Cube0:** Measurement grid: dx=4mm, dy=4mm, dz=4mm

Reference Value = 62.011 V/m; Power Drift = 0.05 dB

Peak SAR (extrapolated) = 28.2 W/kg

**SAR(1 g) = 8.24 W/kg; SAR(10 g) = 2.26 W/kg**

Maximum value of SAR (measured) = 9.98 W/kg

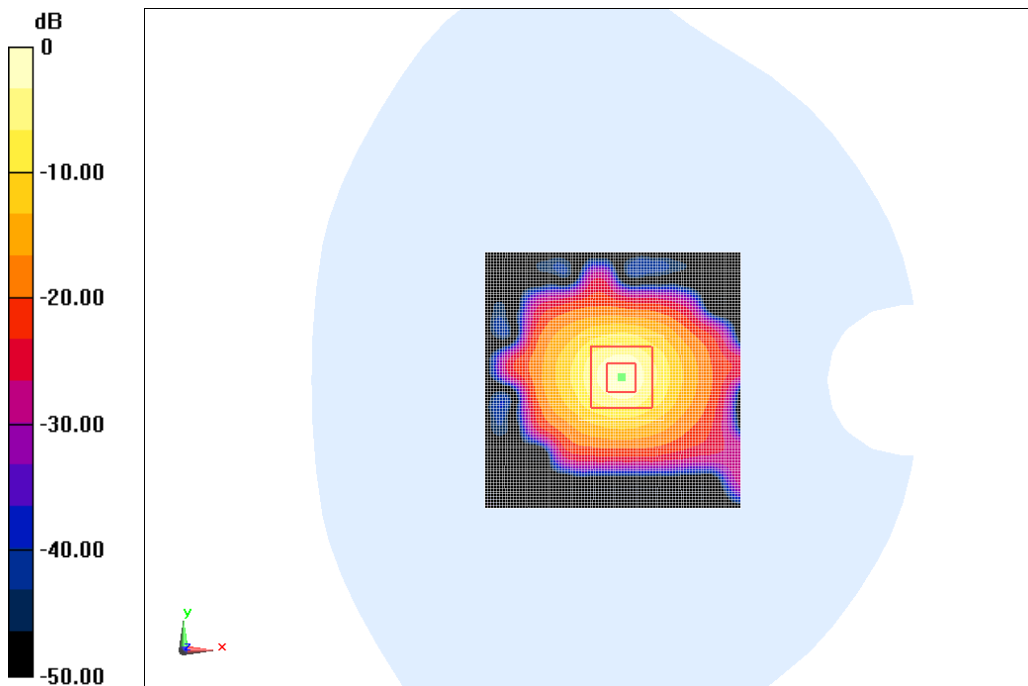

0 dB = 9.98 W/kg = 9.99 dB W/kg

**Fig.N.5 validation 5600MHz 100mW**



## 5800MHz

Date: 2019-1-22

Electronics: DAE4 Sn1527

Medium: Head 5800 MHz

Medium parameters used:  $f = 5800 \text{ MHz}$ ;  $\sigma = 5.368 \text{ S/m}$ ;  $\epsilon_r = 34.882$ ;  $\rho = 1000 \text{ kg/m}^3$

Ambient Temperature:  $23.0^\circ\text{C}$       Liquid Temperature:  $22.5^\circ\text{C}$

Communication System: CW Frequency: 5800 MHz Duty Cycle: 1:1

Probe: EX3DV4 - SN3633 ConvF (4.81, 4.81, 4.81);

**System Validation/Area Scan (91x91x1):** Interpolated grid:  $dx=1.000 \text{ mm}$ ,  $dy=1.000 \text{ mm}$

Reference Value =  $60.313 \text{ V/m}$ ; Power Drift =  $0.08 \text{ dB}$

**SAR(1 g) =  $8.08 \text{ W/kg}$ ; SAR(10 g) =  $2.24 \text{ W/kg}$**

Maximum value of SAR (interpolated) =  $9.89 \text{ W/kg}$

**System Validation/Zoom Scan (8x8x8)/Cube0:** Measurement grid:  $dx=4\text{mm}$ ,  $dy=4\text{mm}$ ,  $dz=4\text{mm}$

Reference Value =  $60.313 \text{ V/m}$ ; Power Drift =  $0.08 \text{ dB}$

Peak SAR (extrapolated) =  $25.2 \text{ W/kg}$

**SAR(1 g) =  $8.14 \text{ W/kg}$ ; SAR(10 g) =  $2.27 \text{ W/kg}$**

Maximum value of SAR (measured) =  $9.83 \text{ W/kg}$

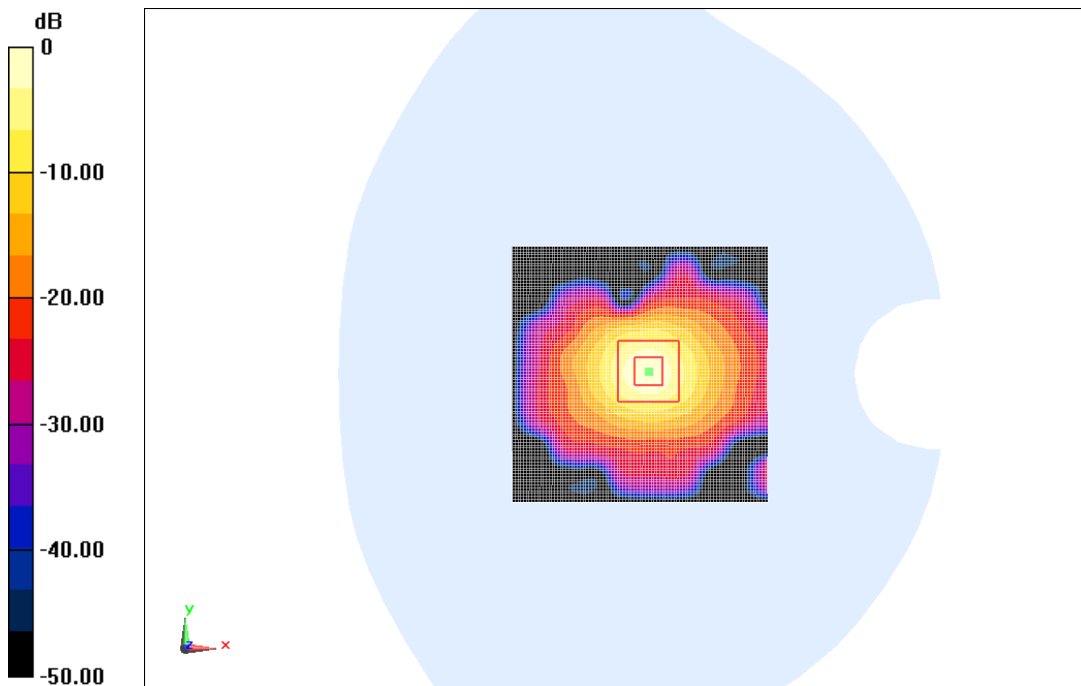

0 dB =  $9.83 \text{ W/kg}$  =  $9.23 \text{ dB W/kg}$

**Fig.N.6 Validation 5800MHz 100mW**