



TEST REPORT

No. I20N01960-DFS

for

Spectralink Corporation

Mobile Phone

Model Name: VC9253

with

Hardware Version: DVT1

Software Version: V138

FCC ID: IYG9253

IC: 2128B-9253

Issued Date: 2020-08-28

Note:

The test results in this test report relate only to the devices specified in this report. This report shall not be reproduced except in full without the written approval of SAICT.

Test Laboratory:

SAICT, Shenzhen Academy of Information and Communications Technology

Building G, Shenzhen International Innovation Center, No.1006 Shennan Road, Futian District, Shenzhen, Guangdong, P. R. China 518026.

Tel:+86(0)755-33322000, Fax:+86(0)755-33322001

Email: yewu@caict.ac.cn. www.saict.ac.cn



CONTENTS

1. SUMMARY OF TEST REPORT.....	3
1.1. TEST ITEMS.....	3
1.2. TEST STANDARDS	3
1.3. TEST RESULT	3
1.4. TESTING LOCATION	3
1.5. PROJECT DATA	3
1.6. SIGNATURE	3
2. CLIENT INFORMATION.....	4
2.1. APPLICANT INFORMATION	4
2.2. MANUFACTURER INFORMATION	4
3. EQUIPMENT UNDER TEST (EUT) AND ANCILLARY EQUIPMENT(AE)	5
3.1. ABOUT EUT	5
3.2. INTERNAL IDENTIFICATION OF EUT USED DURING THE TEST	5
3.3. INTERNAL IDENTIFICATION OF AE USED DURING THE TEST	5
3.4. GENERAL DESCRIPTION.....	5
4. REFERENCE DOCUMENTS	6
4.1. DOCUMENTS SUPPLIED BY APPLICANT	6
4.2. REFERENCE DOCUMENTS FOR TESTING	6
5. TEST RESULTS	7
5.1. TESTING ENVIRONMENT.....	7
5.2. TEST RESULTS	7
5.3. STATEMENTS.....	7
6. TEST EQUIPMENTS UTILIZED	8
7. LABORATORY ENVIRONMENT.....	9
ANNEX A: MEASUREMENT RESULTS.....	10
A.1. MEASUREMENT METHOD	10
A.2. CHANNEL MOVE TIME AND CHANNEL CLOSING TRANSMISSION TIME	12
A.3. NON-OCCUPANCY PERIOD	15
A3.1 ASSOCIATED TEST	15



1. Summary of Test Report

1.1. Test Items

Description	Mobile Phone
Model Name	VC9253
Applicant's name	Spectralink Corporation
Manufacturer's Name	Spectralink Corporation

1.2. Test Standards

FCC Part15-2019; FCC 06-96-2006; RSS-247 Issue 2; RSS-Gen Issue 5 A1; KDB 905462-D02

1.3. Test Result

Pass

1.4. Testing Location

Address: Building G, Shenzhen International Innovation Center, No.1006 Shennan Road,
Futian District, Shenzhen, Guangdong, P. R. China

1.5. Project data

Testing Start Date:	2020-07-24
Testing End Date:	2020-07-24

1.6. Signature

Lin Zechuang
(Prepared this test report)

Tang Weisheng
(Reviewed this test report)

Zhang Bojun
(Approved this test report)



2. Client Information

2.1. Applicant Information

Company Name: Spectralink Corporation
Address: 2560 55th Street, Boulder CO 80301, USA
Contact Person Paul Hampton
E-Mail Paul.Hampton@spectralink.com
Telephone: +1303-441-7593
Fax: /

2.2. Manufacturer Information

Company Name: Spectralink Corporation
Address: 2560 55th Street, Boulder CO 80301, USA
Contact Person Paul Hampton
E-Mail Paul.Hampton@spectralink.com
Telephone: +1303-441-7593
Fax: /

3. Equipment Under Test (EUT) and Ancillary Equipment(AE)

3.1. About EUT

Description	Mobile Phone
Model name	VC9253
Brand Name	Spectralink
RLAN Frequency Range	ISM Bands: 5250MHz~5350MHz 5470MHz~5725MHz
RLAN Protocol	IEEE 802.11a,802.11n-HT20/40,802.11ac-VHT20/40/80
Type of modulation	OFDM
Antenna	Integrated
Antenna Gain	SISO:1.8dBi MIMO:1.7dBi
Power Supply	3.85V DC by Battery
FCC ID	IYG9253
IC	2128B-9253
Device Type (DFS)	Client without radar detection(only support client mode)
Condition of EUT as received	No abnormality in appearance

Note: Components list, please refer to documents of the manufacturer; it is also included in the original test record of Shenzhen Academy of Information and Communications Technology.

3.2. Internal Identification of EUT used during the test

EUT ID*	IMEI	HW Version	SW Version	Receive Date
UT07aa	velc02bdcjd000t	DVT1	V138	2020-07-20

*EUT ID: is used to identify the test sample in the lab internally.

3.3. Internal Identification of AE used during the test

AE ID*	Description	AE ID*
AE1	/	/

*AE ID: is used to identify the test sample in the lab internally.

3.4. General Description

The Equipment under Test (EUT) is a model of Mobile Phone with integrated antenna and battery. It consists of normal options: Lithium Battery, Charger and USB Cable. Manual and specifications of the EUT were provided to fulfil the test. Samples undergoing test were selected by the client.



4. Reference Documents

4.1. Documents supplied by applicant

EUT feature information is supplied by the applicant or manufacturer, which is the basis of testing.

4.2. Reference Documents for testing

The following documents listed in this section are referred for testing.

Reference	Title	Version
FCC Part15	Title 47 of the Code of Federal Regulations; Chapter I Part 15 - Radio frequency devices Subpart E – UNII Devices	2019
FCC 06-96	Revision of Parts 2 and 15 of the Commission’s Rules to Permit Unlicensed National Information Infrastructure (U-NII) devices in the 5 GHz band	2006
RSS-247	Spectrum Management and Telecommunications Radio Standards Specification Digital Transmission Systems (DTSs), Frequency Hopping Systems (FHSs) and License-Exempt Local Area Network (LE-LAN) Devices	Issue 2 February,2017
RSS-Gen	Spectrum Management and Telecommunications Radio Standards Specification General Requirements for Compliance of Radio Apparatus	Issue 5 March,2019 Amendment 1
KDB 905462	Compliance Measurement Procedures for Unlicensed-national Information Infrastructure Devices Operating in the 5250-5350 MHz and 5470-5725 MHz Bands Incorporating Dynamic Frequency Selection	D02

Note: This report is only for DFS



5. Test Results

5.1. Testing Environment

Normal Temperature: 15~35°C

Relative Humidity: 20~75%

5.2. Test Results

No	Test cases	Sub-clause of Part15E	Verdict
1	Channel move time and channel closing transmission time	15.407 (h)(2)(iii)	P
2	Non-Occupancy Period	15.407 (h)(2) (iv)	P

Please refer to **ANNEX A** for detail.

5.3. Statements

SAICT has evaluated the test cases requested by the applicant/manufacture as listed in section 5.2 of this report, for the EUT specified in section 3, according to the standards or reference documents listed in section 4.2.

This report only deal with the UNII DFS functions among the features described in section 3, and The EUT met all requirements of the reference documents.

The end user is not available to get and modify the parameters of the detected Radar Waveforms in this product.



6. Test Equipments Utilized

Conducted test system

No.	Equipment	Model	Serial Number	Manufacturer	Calibration Date	Calibration Due Date
1	Vector Signal Analyzer	FSV40	100903	Rohde & Schwarz	2021-01-15	1 year
2	Vector Signal General	SMU200A	104096	Rohde & Schwarz	2021-01-01	1 year
3	Shielding Room	S81	/	ETS-Lindgren	2022-11-14	3 years
No.	Equipment	Model	FCC ID	Manufacturer	Calibration Date	Calibration Due Date
4	Master AP	RT-AC9600R	MSQ-RTG03H	ASUS	/	/



7. Laboratory Environment

Measurement is performed in shielding room.

Shielded room

Temperature	Min. = 15 °C, Max. = 35 °C
Relative humidity	Min. = 20 %, Max. = 75 %
Shielding effectiveness	0.014 MHz - 1 MHz, > 60 dB; 1 MHz - 1000 MHz, > 90 dB.
Electrical insulation	> 2 MΩ
Ground system resistance	< 4 Ω

ANNEX A: MEASUREMENT RESULTS

A.1. Measurement Method

A.1.1. Conducted Measurements

The below figure shows the DFS setup, where the EUT is a RLAN device operating in slave mode, without Radar Interference Detection function. This setup also contains a device operating in master mode. The radar test signals are injected into the master device. The EUT (slave device) is associated with the master device. WLAN traffic is generated by streaming the mpeg file from the master to the slave in full monitor video mode using the media player.

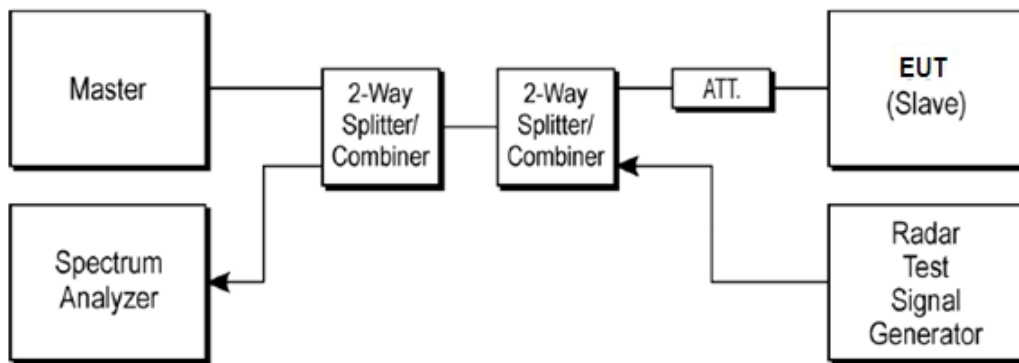

A.1.2. Parameters of DFS test signal

1). Interference threshold values, master or client incorporation in service monitoring. For device Power less than 23dBm (E.I.R.P.), the threshold level is -62 dBm at the antenna port after Correction for antenna gain and procedural adjustments.

Because of conducted measurement performed, the calibration power from radar signal generator to antenna port of DFS test equipment is -62 dBm.

Maximum Transmit Power	Value
> 200 mW	-64 dBm
< 200 mW	-62 dBm

2). DFS requirement values

The required values are as the following table.

Parameter	Value
Non-occupancy	> 1800 s
Channel Availability Check Time	60 s
Channel Move Time	10 s
Channel Closing Transmission Time	200 ms + 60 ms
U-NII Detection Bandwidth	Minimum 80% of the 99% transmission power bandwidth

As the EUT is IP based system, the MPEG video file from NTIA website is used to steam to EUT via the Master device.

3).Parameters of the reference DFS test signal

Pulse width W (μ s)	Pulse repetition frequency PRF (PPS)	Pulses per burst (PPB)
1	700	18

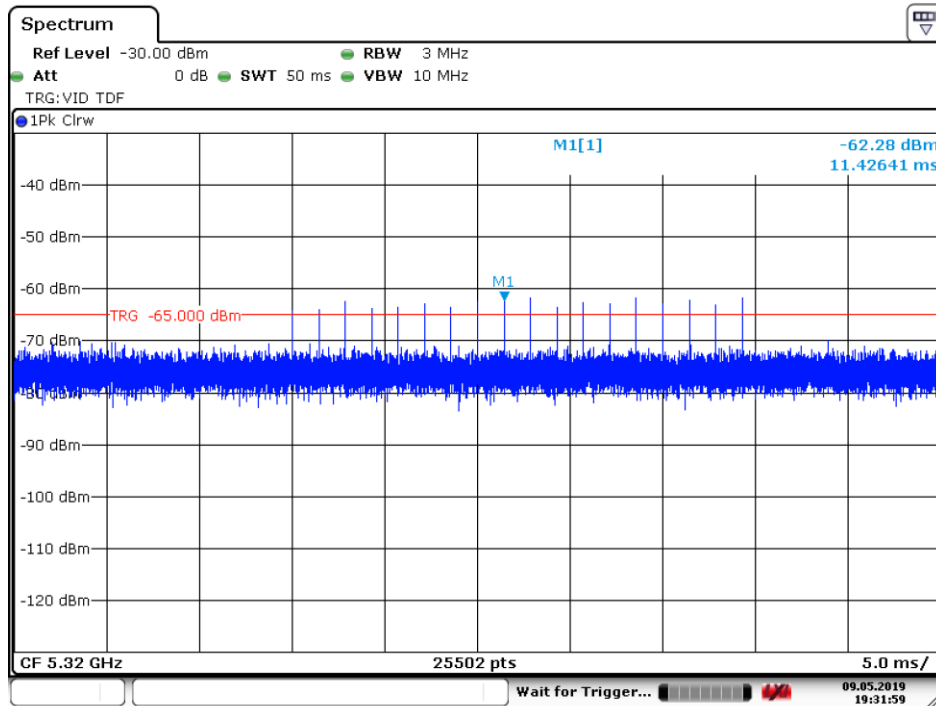

A.2. Channel move time and channel closing transmission time

Measurement Limit:

Test Items	Limit
channel closing transmission time	< 200 ms + 60 ms
Channel move time	< 10 s

Measurement Results:

HT20 Frequency Band: 5250MHz ~ 5350MHz

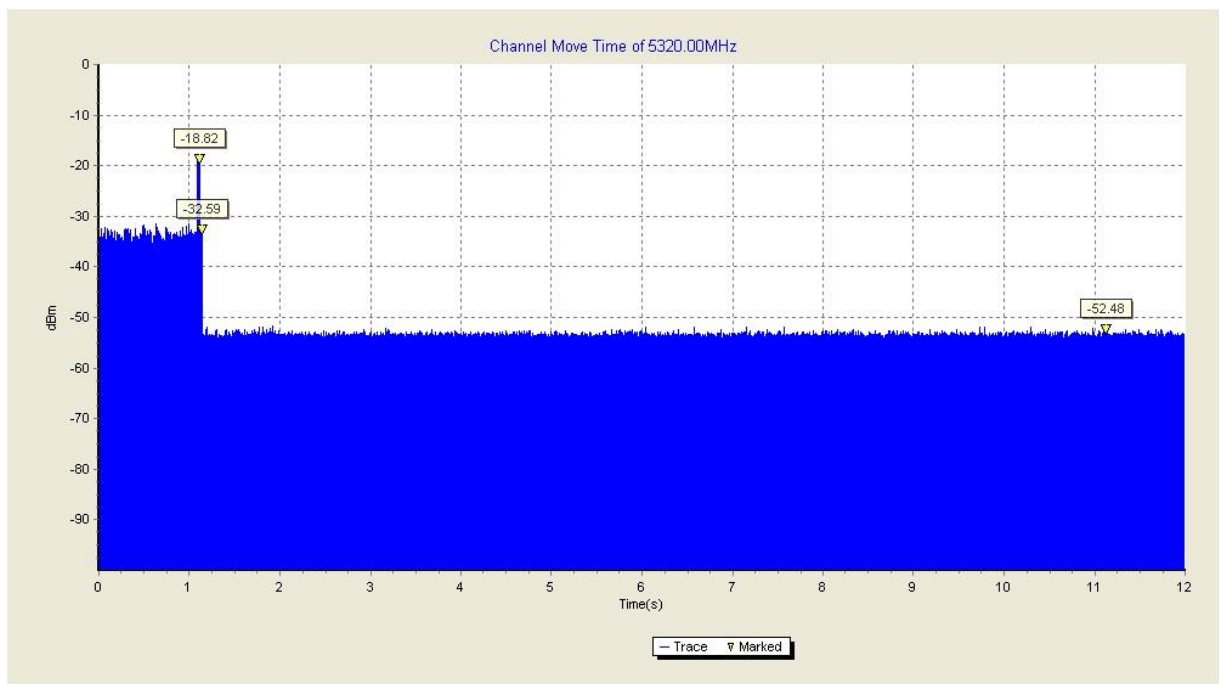

Fig.1 channel move time (HT20 Frequency Band: 5250MHz ~ 5350MHz)

The channel move time is as the figure. It shows the time of the radar and the client pulses. The figure shows that the client stops transmission within 10 seconds, and no transmissions occur after 10 seconds later of the radar burst signal.

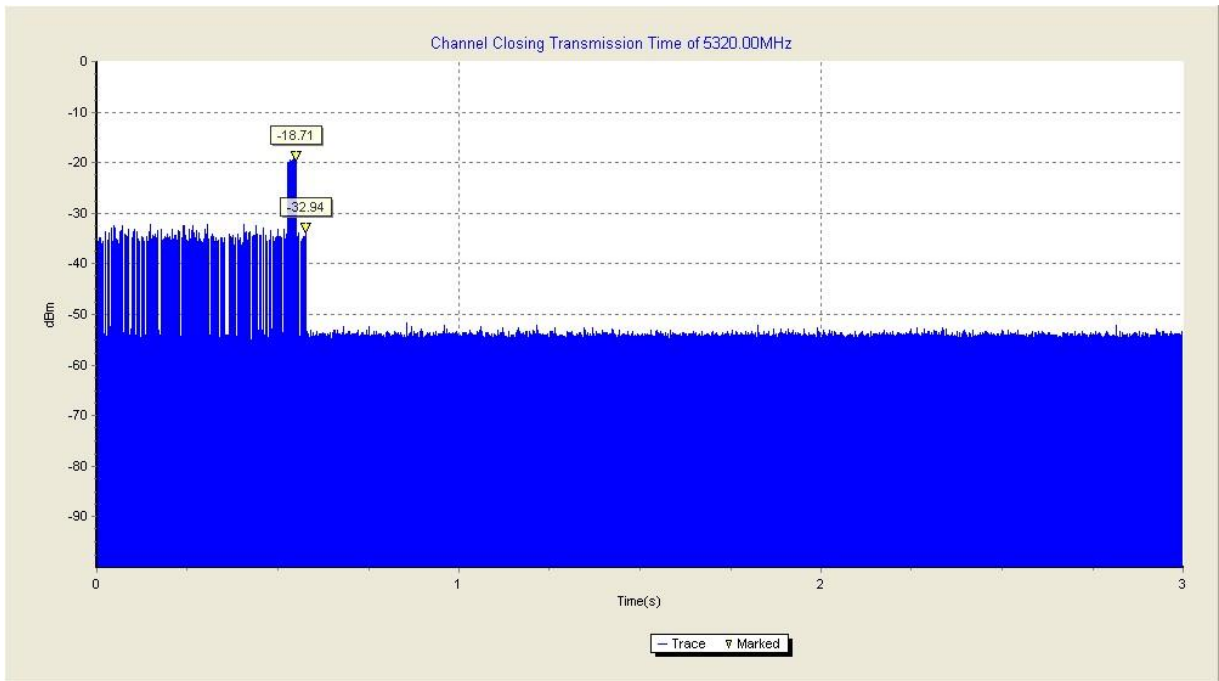

Fig.2 channel closing transmission time (HT20 Frequency Band: 5250MHz ~ 5350MHz)

The closing transmission time is as the figure, and the result is 24ms.

Conclusion: PASS

HT80 Frequency Band: 5470MHz ~ 5725MHz

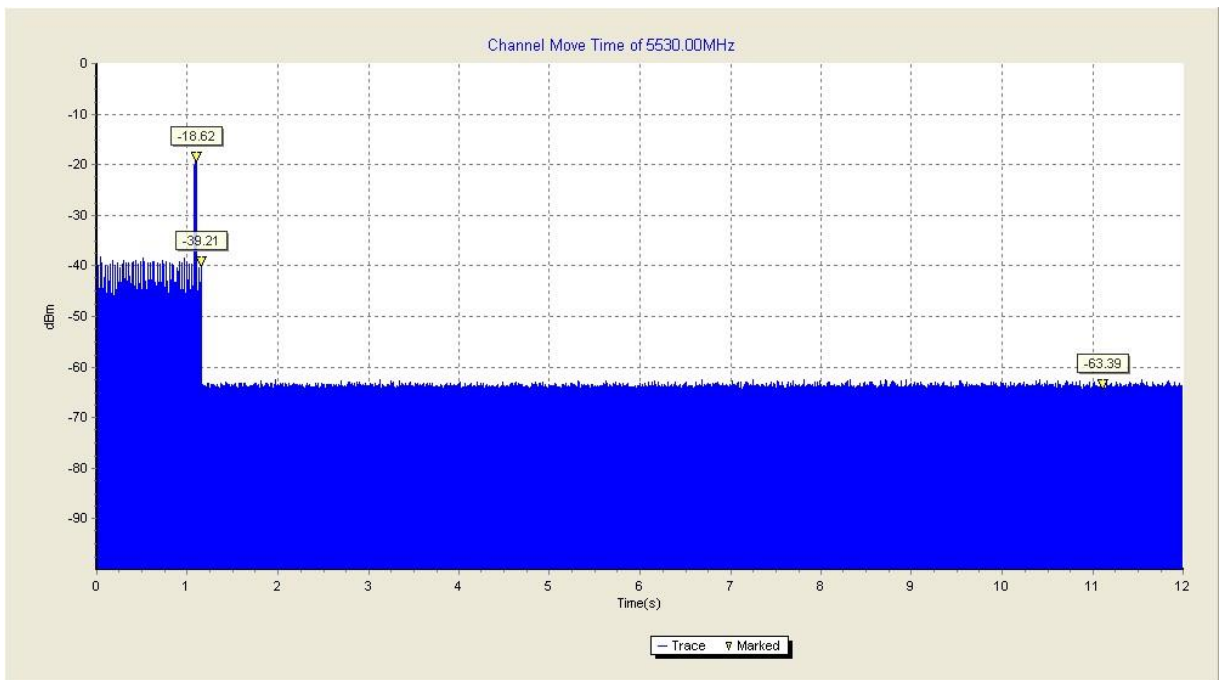

Fig.3 channel move time (HT80 Frequency Band: 5470MHz ~ 5725MHz)

The channel move time is as the figure. It shows the time of the radar and the client pulses. The figure shows that the client stops transmission within 10 seconds, and no transmissions occur

after 10 seconds later of the radar burst signal.

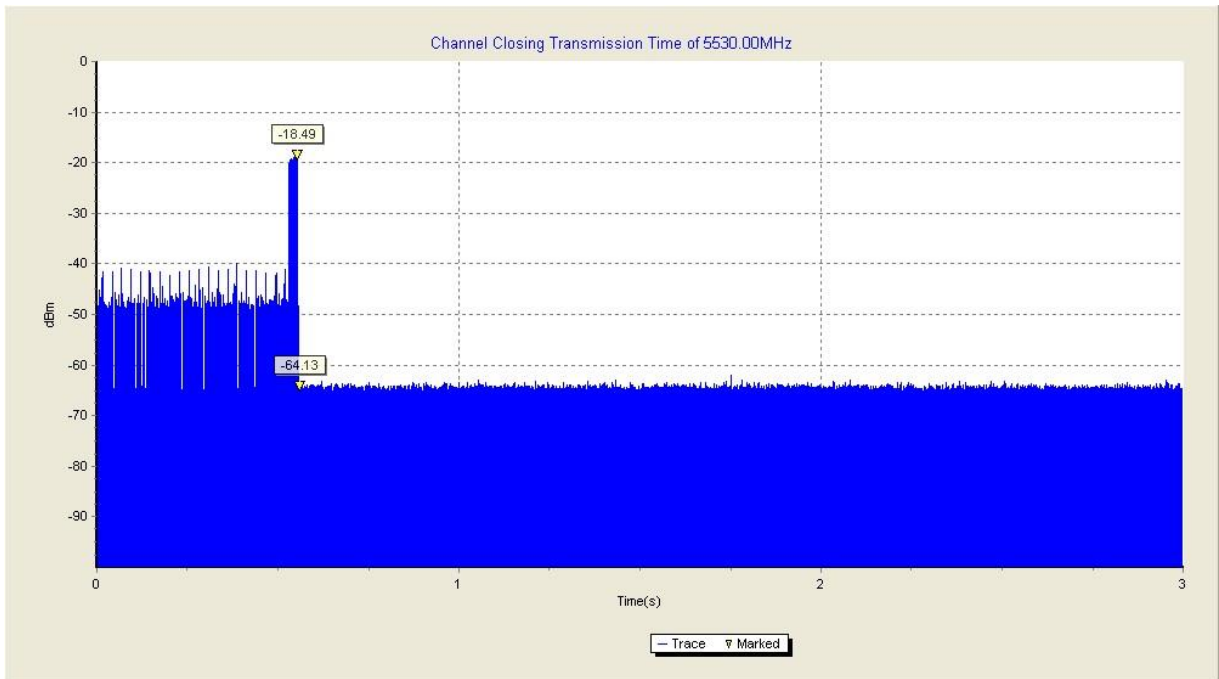

Fig.4 channel closing transmission time (HT80 Frequency Band: 5470MHz ~ 5725MHz)

The closing transmission time is as the figure, and the result is 6ms.

Conclusion: PASS

A.3. Non-Occupancy Period

Measurement Limit:

Test Items	Limit
Non-Occupancy Period	> 1800 s

A3.1 Associated test

Associate the master and client, transmit specified stream between the master and client; monitor the analyzer on the operating frequency to make sure no beacons have been transmitted for 1800 seconds.

HT20 Frequency Band: 5250MHz ~ 5350MHz

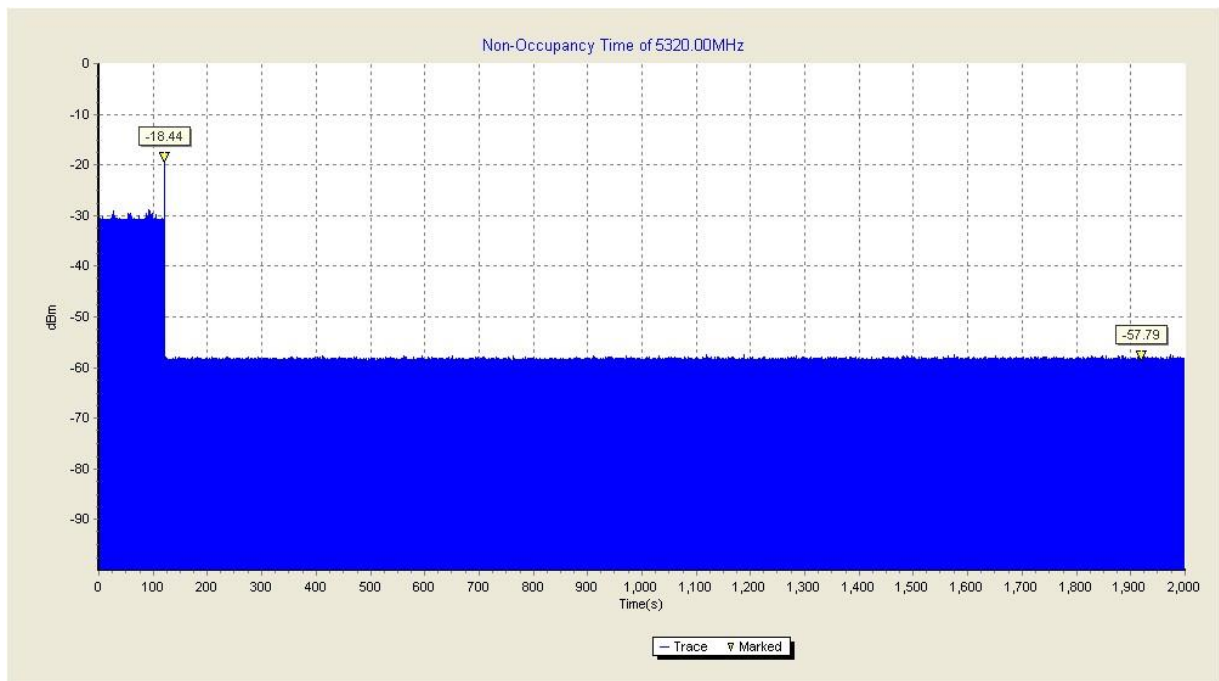

Fig.5 Non-Occupancy Period (HT20 Frequency Band: 5150MHz ~ 5350MHz)

The figure above shows that the client does not transmit any emission within 1800 seconds after getting the order of “stop transmits” from the DFS master (access point).

HT80 Frequency Band: 5470MHz ~ 5725MHz

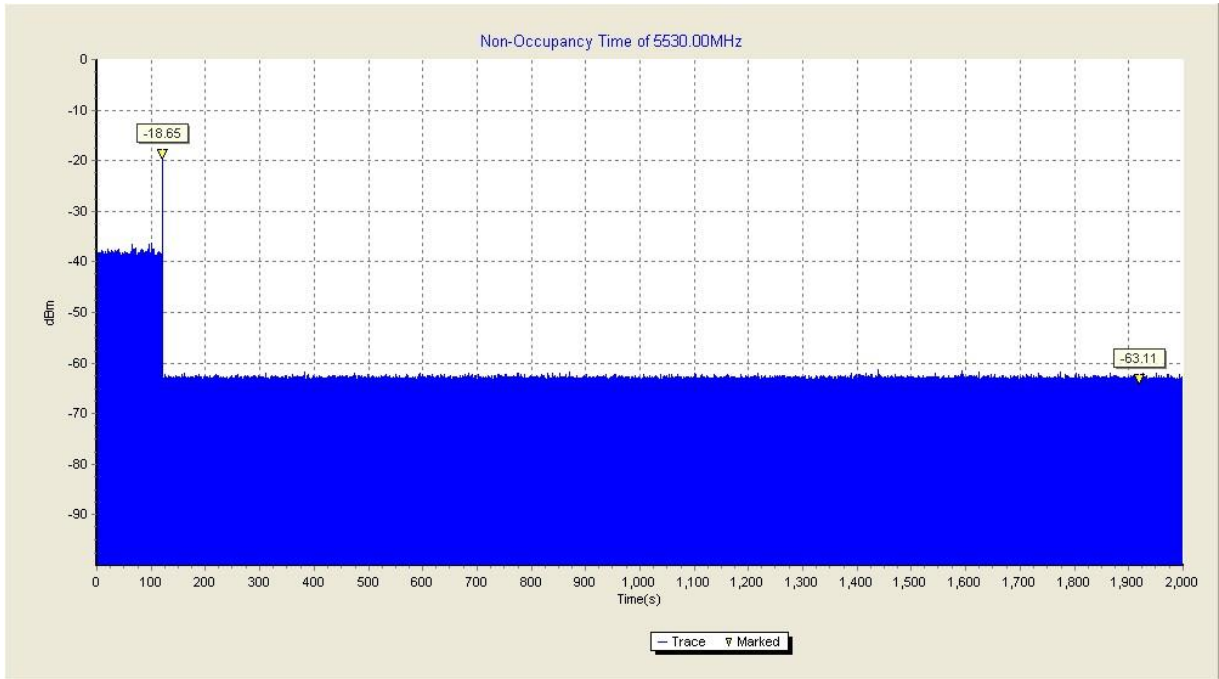

Fig.6 Non-Occupancy Period (HT80 Frequency Band: 5470MHz ~ 5725MHz)

The figure above shows that the client does not transmit any emission within 1800 seconds after getting the order of “stop transmits” from the DFS master (access point).

Conclusion: PASS

***** END OF REPORT BODY *****