



# TEST REPORT

No. I20N01960-NFC

for

**Spectralink Corporation**

**Mobile Phone**

**Model Name: VC9253**

with

**Hardware Version: DVT1**

**Software Version: V138**

**FCC ID: IYG9253**

**IC: 2128B-9253**

**Issued Date: 2020-08-28**

**Note:**

The test results in this test report relate only to the devices specified in this report. This report shall not be reproduced except in full without the written approval of SAICT.

**Test Laboratory:**

**SAICT, Shenzhen Academy of Information and Communications Technology**

Building G, Shenzhen International Innovation Center, No.1006 Shennan Road, Futian District, Shenzhen, Guangdong, P. R. China 518026.

Tel:+86(0)755-33322000, Fax:+86(0)755-33322001

Email: yewu@caict.ac.cn www.saict.ac.cn

## **CONTENTS**

<b>1. SUMMARY OF TEST REPORT.....</b>	<b>3</b>
1.1. TEST ITEMS.....	3
1.2. TEST STANDARDS .....	3
1.3. TEST RESULT .....	3
1.4. TESTING LOCATION .....	3
1.5. PROJECT DATA .....	3
1.6. SIGNATURE .....	3
<b>2. CLIENT INFORMATION.....</b>	<b>4</b>
2.1. APPLICANT INFORMATION .....	4
2.2. MANUFACTURER INFORMATION .....	4
<b>3. EQUIPMENT UNDER TEST (EUT) AND ANCILLARY EQUIPMENT (AE) .....</b>	<b>5</b>
3.1. ABOUT EUT .....	5
3.2. INTERNAL IDENTIFICATION OF EUT USED DURING THE TEST .....	5
3.3. INTERNAL IDENTIFICATION OF AE USED DURING THE TEST .....	5
3.4. GENERAL DESCRIPTION.....	5
3.5. EUT SET-UPS .....	5
<b>4. REFERENCE DOCUMENTS .....</b>	<b>7</b>
4.1. DOCUMENTS SUPPLIED BY APPLICANT .....	7
4.2. REFERENCE DOCUMENTS FOR TESTING.....	7
<b>5. TEST RESULTS .....</b>	<b>8</b>
5.1. TESTING ENVIRONMENT.....	8
5.2. TEST RESULTS .....	8
5.3. STATEMENTS.....	8
<b>6. TEST EQUIPMENTS UTILIZED .....</b>	<b>9</b>
<b>7. LABORATORY ENVIRONMENT .....</b>	<b>10</b>
<b>ANNEX A: MEASUREMENT RESULTS.....</b>	<b>11</b>
A.1. ELECTRIC FIELD STRENGTH OF FUNDAMENTAL AND OUTSIDE THE ALLOCATED BANDS.....	11
A.2. ELECTRIC FIELD RADIATED EMISSIONS (<30MHz) .....	13
A.3. ELECTRIC FIELD RADIATED EMISSIONS ( $\geq$ 30MHz).....	15
A.4. FREQUENCY TOLERANCE.....	17
A.5. 20dB BANDWIDTH.....	19
A.6. CONDUCTED EMISSION .....	21
A.7. OCCUPIED BANDWIDTH.....	24



## 1. Summary of Test Report

### 1.1. Test Items

Description	Mobile Phone
Model Name	VC9253
Applicant's name	Spectralink Corporation
Manufacturer's Name	Spectralink Corporation

### 1.2. Test Standards

FCC Part15-2019; ANSI C63.10-2013; ANSI C63.4-2014; RSS-210 Issue 9; RSS-Gen Issue 5 A1

### 1.3. Test Result

**Pass**

### 1.4. Testing Location

Address: Building G, Shenzhen International Innovation Center, No.1006 Shennan Road, Futian District, Shenzhen, Guangdong, P. R. China

### 1.5. Project data

Testing Start Date:	2020-07-28
Testing End Date:	2020-08-24

### 1.6. Signature

---

Lin Zechuang  
(Prepared this test report)

---

Tang Weisheng  
(Reviewed this test report)

---

Zhang Bojun  
(Approved this test report)



## **2. Client Information**

### **2.1. Applicant Information**

Company Name: Spectralink Corporation  
Address/Post: 2560 55th Street, Boulder CO 80301, USA  
Contact: Paul Hampton  
Email: Paul.Hampton@spectralink.com  
Tel.: +1303-441-7593  
Fax: /

### **2.2. Manufacturer Information**

Company Name: Spectralink Corporation  
Address/Post: 2560 55th Street, Boulder CO 80301, USA  
Contact: Paul Hampton  
Email: Paul.Hampton@spectralink.com  
Tel.: +1303-441-7593  
Fax: /

### **3. Equipment Under Test (EUT) and Ancillary Equipment (AE)**

#### **3.1. About EUT**

Description	Mobile Phone
Model Name	VC9253
Brand Name	Spectralink
Frequency	13.56MHz
Antenna type	Integrated antenna
Extreme Temperature	-20°C/+55°C
Operation Voltage	3.6VDC to 4.4VDC (nominal: 3.85VDC)
Power source	Battery
FCC ID	IYG9253
IC	2128B-9253
Condition of EUT as received	No abnormality in appearance

Note: Components list, please refer to documents of the manufacturer; it is also included in the original test record of Shenzhen Academy of Information and Communications Technology.

#### **3.2. Internal Identification of EUT used during the test**

<b>EUT ID*</b>	<b>IMEI</b>	<b>HW Version</b>	<b>SW Version</b>	<b>Receive Date</b>
UT07aa	velc02bdcjd000t	DVT1	V138	2020-07-20
UT01aa	velc02bdcjd00aw	DVT1	V138	2020-07-22

\*EUT ID: is used to identify the test sample in the lab internally.

#### **3.3. Internal Identification of AE used during the test**

<b>AE ID*</b>	<b>Description</b>	<b>SN</b>
AE1	Power Supply	/
AE2	NFC Card	/

\*AE ID: is used to identify the test sample in the lab internally.

#### **3.4. General Description**

Equipment under Test (EUT) is a model of Mobile Phone with integrated antenna and battery.

It consists of normal options: Lithium Battery, Charger and USB Cable.

Manual and specifications of the EUT were provided to fulfil the test.

Samples undergoing test were selected by the client.

#### **3.5. EUT Set-ups**

<b>EUT Set-up No.</b>	<b>Combination of EUT and AE</b>	<b>Remarks</b>
Set. NFC01	EUT1+AE1+AE2	NFC RF, TX test
Set. NFC02	EUT1+AE1	NFC RF, RX test

CE\_test.apk is installed in the EUT which helps to control the NFC signal transmitting.



The Transmit State of NFC: the NFC function is on. The EUT will transmit the NFC data and command continuously during the test.

The Transmit State without modulation: The EUT will transmit the CW signal at the operating frequency.



## **4. Reference Documents**

### **4.1. Documents supplied by applicant**

EUT feature information is supplied by the applicant or manufacturer, which is the basis of testing.

### **4.2. Reference Documents for testing**

The following documents listed in this section are referred for testing.

<b>Reference</b>	<b>Title</b>	<b>Version</b>
CFR 47 Part 15	FCC CFR 47,Part 15,Subpart C	2019
ANSI C63.10	American National Standard of Procedures for Compliance Testing of Unlicensed Wireless Devices	2013
ANSI C63.4	American National Standard for Methods of Measurement of Radio-Noise Emissions from Low-Voltage Electrical and Electronic Equipment in the Range of 9 kHz to 40 GHz.	2014
RSS-210	License-exempt Radio Apparatus (All Frequency Bands): Category I Equipment Annex 2 - Devices Operating in Frequency Bands for Any Application	Issue 9 2016
RSS-Gen	Spectrum Management and Telecommunications Radio Standards Specification General Requirements for Compliance of Radio Apparatus	Issue 5 March,2019 Amendment 1

## 5. Test Results

### 5.1. Testing Environment

Normal Temperature: 15~35°C

Relative Humidity: 20~75%

### 5.2. Test Results

No	Test Cases	Clause in Regulation	Section in This Report	Verdict
1	Electric Field Strength of Fundamental Emissions	CFR 47 § 15.225(a) RSS-210 Issue9 A2.6	A.1	<b>P</b>
2	Electric Field Strength of Outside the Allocated Bands	CFR 47 § 15.225(b) CFR 47 § 15.225(c) RSS-210 Issue9 A2.6		<b>P</b>
3	Electric Field Radiated Emissions	CFR 47 § 15.209	A.2	<b>P</b>
		CFR 47 § 15.225(d) RSS-210 Issue9 A2.6	A.3	<b>P</b>
4	Frequency Tolerance	CFR 47 § 15.225(e) RSS-210 Issue9 A2.6	A.4	<b>P</b>
5	20dB Bandwidth	CFR 47 § 15.215(c)	A.5	<b>P</b>
6	Conducted Emissions	CFR 47 § 15.207 RSS-Gen section 6.13	A.6	<b>P</b>
7	Occupied Bandwidth	RSS-Gen section 6.7	A.7	<b>P</b>
The measurement is carried out according to ANSI C63.10 and ANSI C63.4. See <b>ANNEX A</b> for details.				

### 5.3. Statements

The test cases listed in Section 5.2 of this report for the EUT specified in Section 3 were performed by SAICT according to the reference documents in Section 4.

The EUT meets all applicable requirements of the regulations and standards in Section 4.2.

This report only deals with the NFC function among the features described in section 3.



## 6. Test Equipments Utilized

### Conducted test system

No.	Equipment	Model	Serial Number	Manufacturer	Calibration Due date	Calibration Period
1	Vector Signal Analyzer	FSV40	100903	Rohde & Schwarz	2021-01-15	1 year
2	DC Power Supply	ZUP60-14	6MY-847Z13 -0001	TDK-Lambda	2021-02-26	1 year
3	Test Receiver	ESCI	100701	Rohde & Schwarz	2021-08-09	1 year
4	LISN	ENV216	102067	Rohde & Schwarz	2021-07-16	1 year

### Climate chamber

No.	Equipment	Model	Serial Number	Manufacturer	Calibration Due date	Calibration Period
1	Climate chamber	SU-242	93008165	ESPEC	2021-03-15	1 year

### Radiated emission test system

No.	Equipment	Model	Serial Number	Manufacturer	Calibration Due date	Calibration Period
1	Test Receiver	ESR7	101676	Rohde & Schwarz	2020-11-27	1 year
2	BiLog Antenna	3142E	00224831	ETS-Lindgren	2021-05-17	3 years
3	Loop Antenna	HLA6120	35779	TESEQ	2022-04-25	3 years
4	Chamber	FACT3-2.0	1285	ETS-Lindgren	2021-07-19	2 years
5	Software	EMC32	V10.01.00	R&S	/	/

## 7. Laboratory Environment

### Semi-anechoic chambe

Temperature	Min. = 15 °C, Max. = 35 °C
Relative humidity	Min. = 20 %, Max. = 75 %
Shielding effectiveness	0.014MHz-1MHz> 60 dB; 1MHz-18000MHz>90 dB
Electrical insulation	> 2MΩ
Ground system resistance	< 4 Ω
Normalised site attenuation (NSA)	< ±4 dB, 3 m distance, from 30 to 1000 MHz

### Shielded room

Temperature	Min. = 15 °C, Max. = 35 °C
Relative humidity	Min. = 20 %, Max. = 75 %
Shielding effectiveness	0.014MHz-1MHz> 60 dB; 1MHz-1000MHz>90 dB
Electrical insulation	> 2MΩ
Ground system resistance	< 4 Ω

### Fully-anechoic chamber

Temperature	Min. = 15 °C, Max. = 35 °C
Relative humidity	Min. = 20 %, Max. = 75 %
Shielding effectiveness	0.014MHz-1MHz> 60 dB; 1MHz-18000MHz>90 dB
Electrical insulation	> 2MΩ
Ground system resistance	< 4 Ω
Voltage Standing Wave Ratio (VSWR)	≤ 6 dB, from 1 to 18 GHz, 3 m distance
Uniformity of field strength	Between 0 and 6 dB, from 80 to 6000 MHz

## **ANNEX A: MEASUREMENT RESULTS**

### **A.1. Electric Field Strength of Fundamental and Outside the Allocated bands**

#### **A.1.1. Reference**

See CFR 47 § 15.225

See RSS-210 Issue9 A2.6

#### **A.1.2. Measurement Methods**

The transmitter carrier output levels (E-Field) from the EUT are measured in a semi-anechoic chamber. The EUT is placed on a non-conductive stand of 80cm high, and at a measurement distance of 3m from the receiving antenna. The center of the receiving loop antenna is 1.0 meter above the ground. The E-field is measured with a shielded loop antenna connected to a measurement receiver. Detected E-field was maximized by rotating the EUT through 360° and adjusting the receiving antenna polarizations. The maximization processes were repeated with the EUT positioned respectively in its three orthogonal axes. The measurements were performed with the peak detector and if required, the quasi-peak detector.

The measurement bandwidth is:

<b>Frequency of Emission (MHz)</b>	<b>RBW/VBW</b>
12.56-14.56	10/30 kHz

The E-field measured at 3m is calculated as:

$$\text{E-field (dB}\mu\text{V/m)} = \text{Rx (dB}\mu\text{V)} + \text{Cable Loss (dB)} + \text{AF@3m (dB/m)}$$

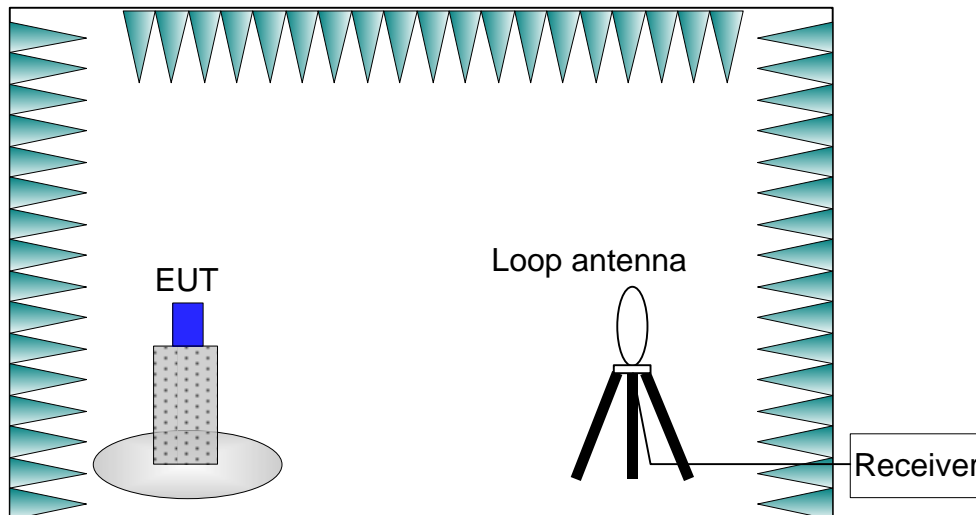

#### **A.1.3. EUT Operating Mode and Test Conditions**

The measurement of EUT is carried out under the transmit state of NFC (See 3.5).

The EUT is powered by a travel adapter.

During the measurements, the ambient temperature of the electromagnetic anechoic chamber is in the range of 15 ~ 25°C.

#### A.1.4. Limits

Frequency Range (MHz)	E-field Strength Limit @ 30 m ( $\mu\text{V}/\text{m}$ )	E-field Strength Limit @ 3 m ( $\text{dB}\mu\text{V}/\text{m}$ )
13.560 $\pm$ 0.007	+15,848	124
13.410 to 13.553 13.567 to 13.710	+334	90
13.110 to 13.410 13.710 to 14.010	+106	81

Note: Where the limits have been defined at one distance, and a signal level measured at another, the limits have been extrapolated using the following formula:  
 Extrapolation (dB) = 40 \* log<sub>10</sub>(Measurement Distance / Specification Distance)

#### A.1.5. Measurement Results

Measurement results of normal conditions see Figure A-1 for different set-ups of EUT. The result displayed take into account applicable antenna factors and cable losses.

**Conclusions: PASS.**

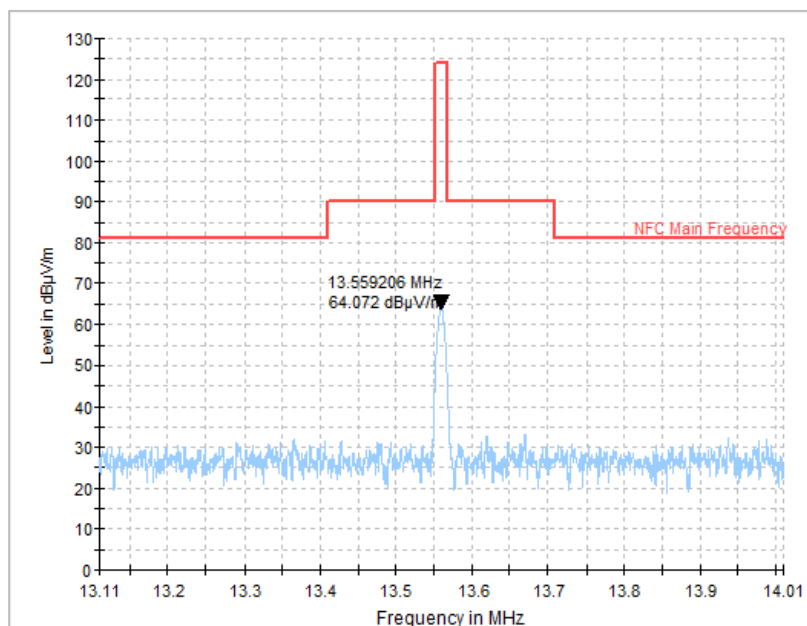

**Figure A-1 Electric Field Strength**

#### A.1.6. Measurement Uncertainty

Measurement uncertainty:  $U = 1.70$  dB,  $k=2$ .

## A.2. Electric Field Radiated Emissions (<30MHz)

### A.2.1. Reference

See CFR 47 § 15.209

See CFR 47 § 15.225(d)

See RSS-210 Issue9 A2.6

### A.2.2. Measurement Methods

The transmitter carrier output levels (E-Field) from the EUT are measured in a semi-anechoic chamber. The EUT is placed on a non-conductive stand of 80cm high, and at a measurement distance of 3m from the receiving antenna. The center of the receiving loop antenna is 1.0 meter above the ground. The E-field is measured with a shielded loop antenna connected to a measurement receiver. Detected E-field was maximized by rotating the EUT through 360° and adjusting the receiving antenna polarizations. The maximization processes were repeated with the EUT positioned respectively in its three orthogonal axes. The measurements were performed with the peak detector and if required, the quasi-peak detector.

The measurement bandwidth is:

Frequency of Emission (MHz)	RBW/VBW
0.009-0.15	100/300 Hz
0.15-30	10/30 kHz

The E-field measured at 3m is calculated as:

$$\text{E-field (dB}\mu\text{V/m)} = \text{Rx (dB}\mu\text{V)} + \text{Cable Loss (dB)} + \text{AF@3m (dB/m)}$$

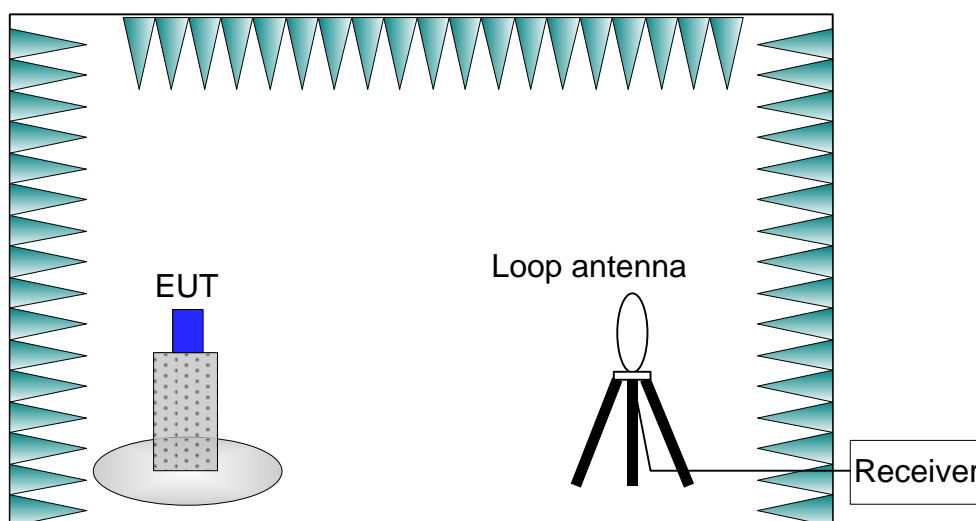

### A.2.3. EUT Operating Mode and Test Conditions

The measurement of EUT is carried out under the transmit state of NFC (See 3.5).

The EUT is powered by a travel adapter.

During the measurements, the ambient temperature of the electromagnetic anechoic chamber is in the range of 15 ~ 25°C.

#### A.2.4. Limits

Frequency Range (MHz)	E-field Strength Limit @ 30m (mV/m)	E-field Strength Limit @ 3m (dB $\mu$ V/m)
0.009-0.490	2400/F(kHz)	129-94
0.490-1.705	24000/F(kHz)	74-63
1.705-30	30	70

Note: Where the limits have been defined at one distance, and a signal level measured at another, the limits have been extrapolated using the following formula:  
 Extrapolation (dB) = 40 \* log<sub>10</sub>(Measurement Distance / Specification Distance)

#### A.2.5. Measurement Results

Measurement results of normal conditions see Figure A-2 for different set-ups of EUT. The result displayed take into account applicable antenna factors and cable losses.

**Conclusions: PASS.**

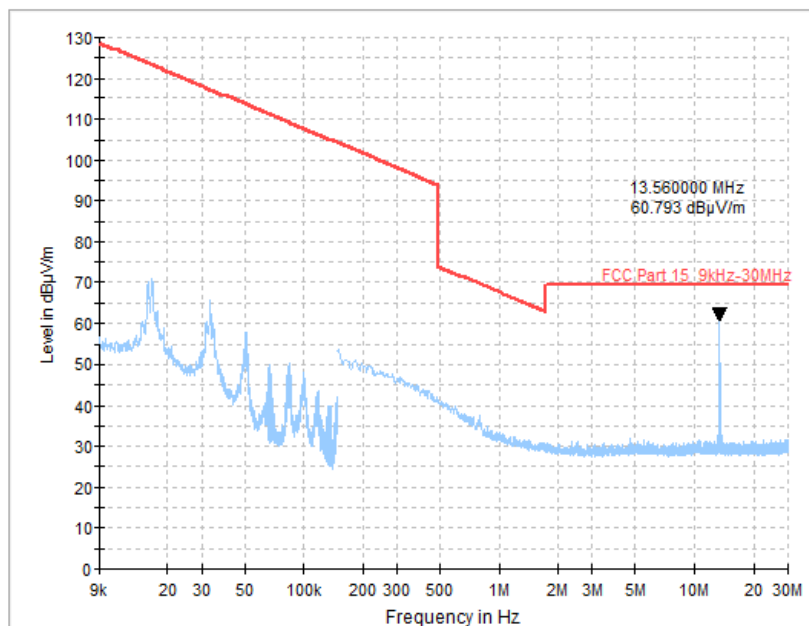

**Figure A-2 Transmit State (9k-30M)**

#### A.2.6. Measurement Uncertainty

Measurement uncertainty:  $U = 1.70$  dB,  $k=2$ .

### A.3. Electric Field Radiated Emissions ( $\geq 30\text{MHz}$ )

#### A.3.1. Reference

See CFR 47 § 15.209

See CFR 47 § 15.225(d)

See RSS-210 Issue9 A2.6

#### A.3.2. Measurement Methods

The electric field radiated emissions from the EUT are measured in a semi-anechoic chamber. The EUT is placed on a non-conductive stand of 80cm high, and at a measurement distance of 10m from the receiving antenna. The receiving antennas connected to a measurement receiver comply with the standard requirements. In order to search for maximum field strength emitted from the EUT, the receiving antenna can be moved between the height of 1.0 m to 4.0 m. Detected E-field was maximized at each frequency by rotating the EUT through 360° and adjusting the receiving antenna positions for both vertical and horizontal antenna polarizations. The maximization processes were repeated with the EUT positioned respectively in its three orthogonal axes. The measurements were performed with the peak detector and if required, the quasi-peak detector.

The measurement bandwidth is:

Frequency of Emission (MHz)	RBW/VBW
30-1000	120kHz

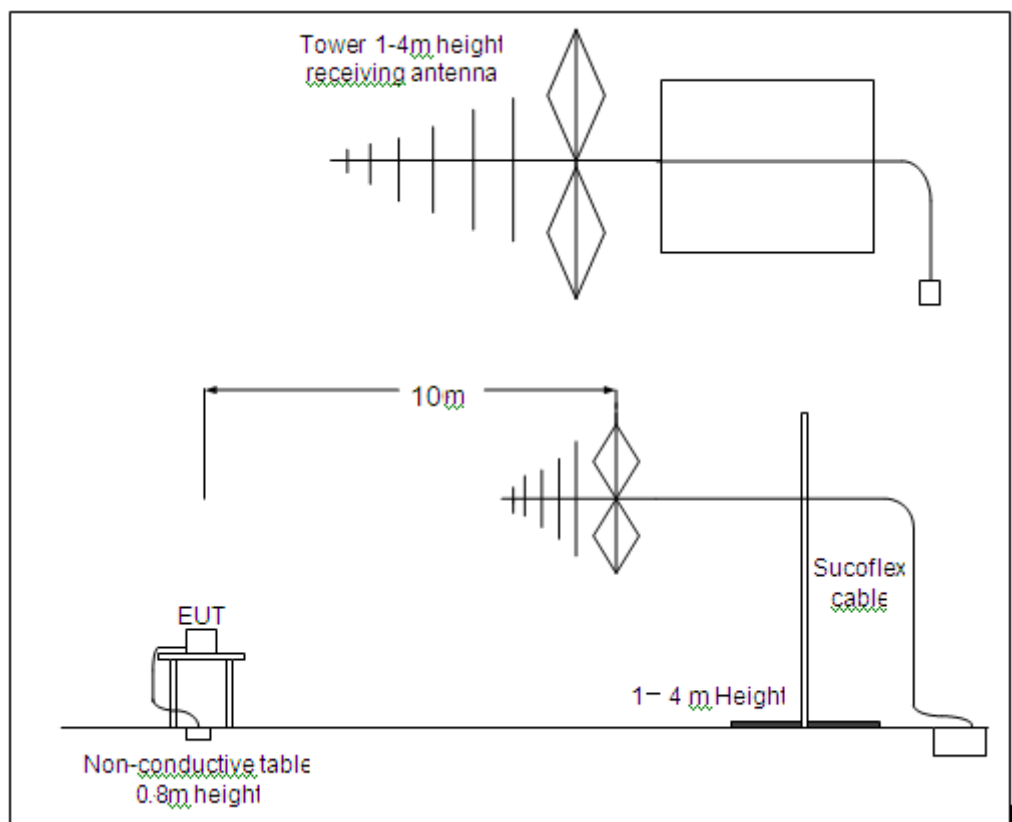

### A.3.3. EUT Operating Mode and Test Conditions

The measurement of EUT is carried out under the transmit state of NFC (See 3.5).

EUT had been connected to a travel adapter.

During the measurements, the ambient temperature of the electromagnetic anechoic chamber is in the range of 15 ~ 25°C.

### A.3.4. Limits

Frequency Range (MHz)	E-field Strength Limit @ 3m (mV/m)	E-field Strength Limit @ 3m (dB $\mu$ V/m)	E-field Strength Limit @ 10m (dB $\mu$ V/m)
30-88	100	40	30
88-216	150	43.5	33.5
216-960	200	46	36
960-1000	500	54	44

### A.3.5. Measurement Results

Measurement results of normal conditions see Figure A-3 for different set-ups of EUT. The result displayed take into account applicable antenna factors and cable losses.

**Conclusions: PASS.**

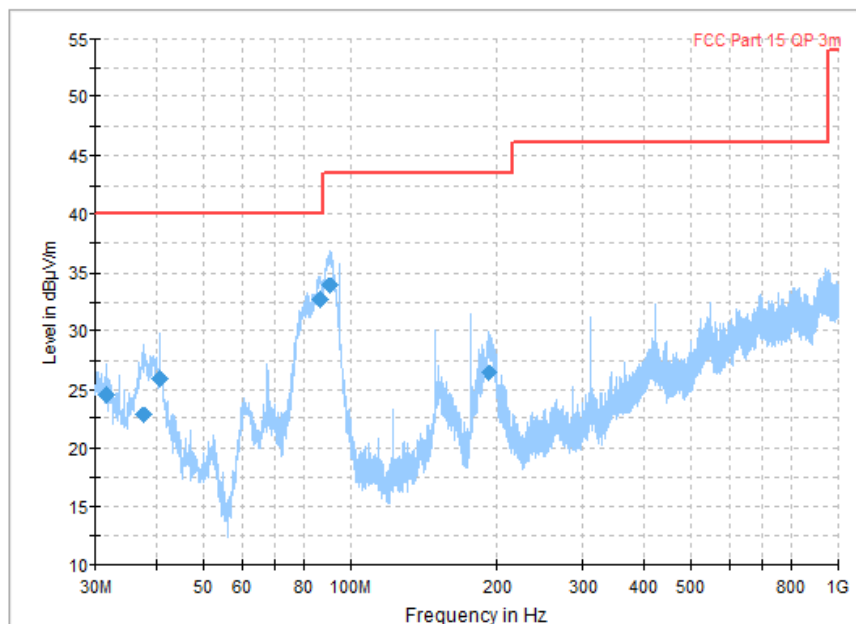

**Figure A-3 Transmit State (30M-1G)**

### A.3.6. Measurement Uncertainty

Measurement uncertainty:  $U = 4.90$  dB,  $k=2$



## **A.4. Frequency Tolerance**

### **A.4.1. Reference**

See CFR 47 § 15.225(e)

See RSS-210 Issue9 A2.6

### **A.4.2. Measurement Methods**

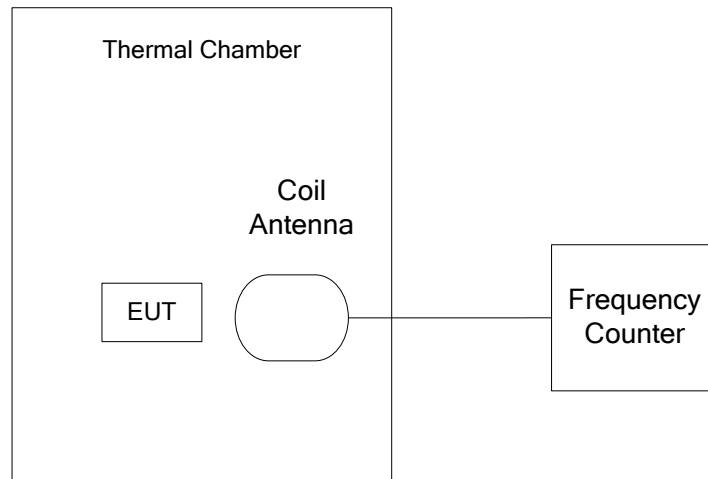

The transmitter output signal was picked up by coil antenna connected to the frequency counter. The center frequency was measured with 30Hz RBW and 1kHz span. During the test, the EUT was placed in a thermal chamber until thermal balance and lasting appropriate time.

### **A.4.3. EUT Operating Mode and Test Conditions**

The measurement of EUT is carried out under the transmit state of without modulation (See 3.5).

EUT had been not connected to a travel adapter.

Operation Temperature: T min, T nom, and T max with V nom.

Operation Voltage: V min and V max with T nom.

### **A.4.4. Test Layouts**

See A.4.2.

### **A.4.5. Limits**

The frequency tolerance of the carrier signal shall be maintained within +/- 0.01% of the operating frequency.

### **A.4.6. Measurement Results**

Measurement results see Table A-1 for different test conditions.

**Conclusions: PASS.**



**Table A-1: Frequency Stability VS Temperature and Voltage**

Temperature	Voltage	Frequency Error (MHz)			
		Startup	2 Min Later	5 Min Later	10 Min Later
T min	V nom	13.559712	13.559711	13.559712	13.559712
T max	V nom	13.559716	13.559720	13.559718	13.559716
T nom	V nom	13.559711	13.559711	13.559714	13.559712

Temperature	Voltage	Frequency Error (%)			
		Startup	2 Min Later	5 Min Later	10 Min Later
T min	V nom	0.002	0.002	0.002	0.002
T max	V nom	0.002	0.002	0.002	0.002
T nom	V nom	0.002	0.002	0.002	0.002

**A.4.7. Measurement Uncertainty**

Measurement uncertainty:  $U = 77$  Hz,  $k=2$

## **A.5. 20dB Bandwidth**

### **A.5.1. Reference**

See CFR 47 § 15.215(c)

### **A.5.2. Measurement Methods**

The transmitter output signal was picked up by coil antenna to the spectrum analyzer.

The transmitter output signal was picked up by coil antenna connected to the spectrum analyzer.  
The bandwidth of the center frequency was measured with 100Hz RBW, 300Hz VBW and 10kHz span.

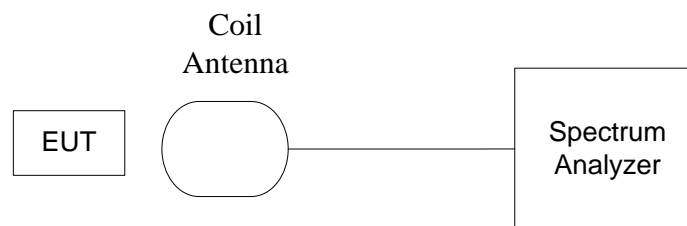

### **A.5.3. EUT Operating Mode and Test Conditions**

The measurement of EUT is carried out under the transmit state of NFC and without modulation (See 3.5).

EUT had been not connected to a travel adapter.

During the measurements, the ambient temperature is in the range of 15 ~ 25°C.

### **A.5.4. Test Layouts**

See A.5.2.

### **A.5.5. Limits**

The 20dB bandwidth shall be less than 80% of the permitted frequency band. For 13.56 MHz NFC, the permitted frequency band is 10 kHz, so the limit is 11.2 kHz.

### **A.5.6. Measurement Results**

Measurement results see Figure A-4.

**Conclusions: PASS.**

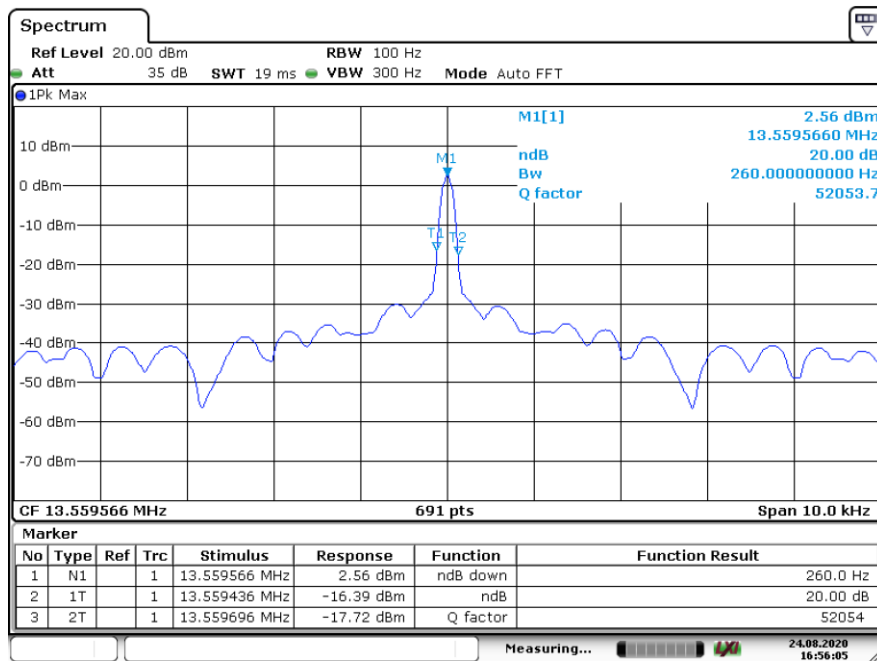

Figure A-4 20dB Bandwidth

### A.5.7. Measurement Uncertainty

Measurement uncertainty:  $U = 77 \text{ Hz}$ ,  $k=2$

## A.6. Conducted emission

### A.6.1. Reference

See CFR 47 § 15.207

See RSS-Gen section 6.13

### A.6.2. Measurement Methods

The conducted emissions from the AC port of the EUT are measured in a shielding room. The EUT is connected to a Line Impedance Stabilization Network (LISN). An overview sweep with peak detection was performed. The measurements were performed with a quasi-peak detector and if required, an average detector.

The conducted emission measurements were made with the following detector of the test receiver: Quasi-Peak / Average Detector.

The measurement bandwidth is:

Frequency of Emission (MHz)	RBW/VBW
0.15-30	9kHz

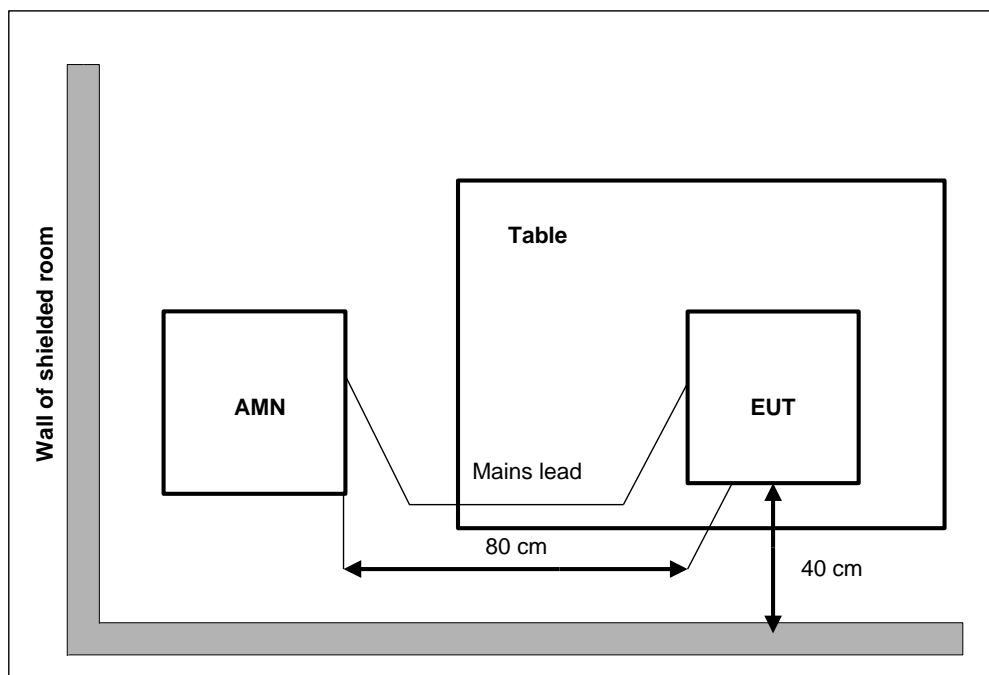

### A.6.3. EUT Operating Mode and Test Conditions

The measurement of EUT is carried out under the transmit state of NFC (See 3.5).

The EUT is powered by a travel adapter.

During the measurements, the ambient temperature is in the range of 15 ~ 25°C.



**A.6.4. Limits**

Frequency range(MHz)	Quasi-peak Limit (dB $\mu$ V)	Average Limit (dB $\mu$ V)
0.15 to 0.5	66 to 56	56 to 46
0.5 to 5	56	46
5 to 30	60	50

**A.6.5. Measurement Results**

Measurement results see Figure A-5, Figure A-6.

**Conclusions: PASS.**

Note: The measurement result at 13.56MHz is the fundamental emission of NFC signal.

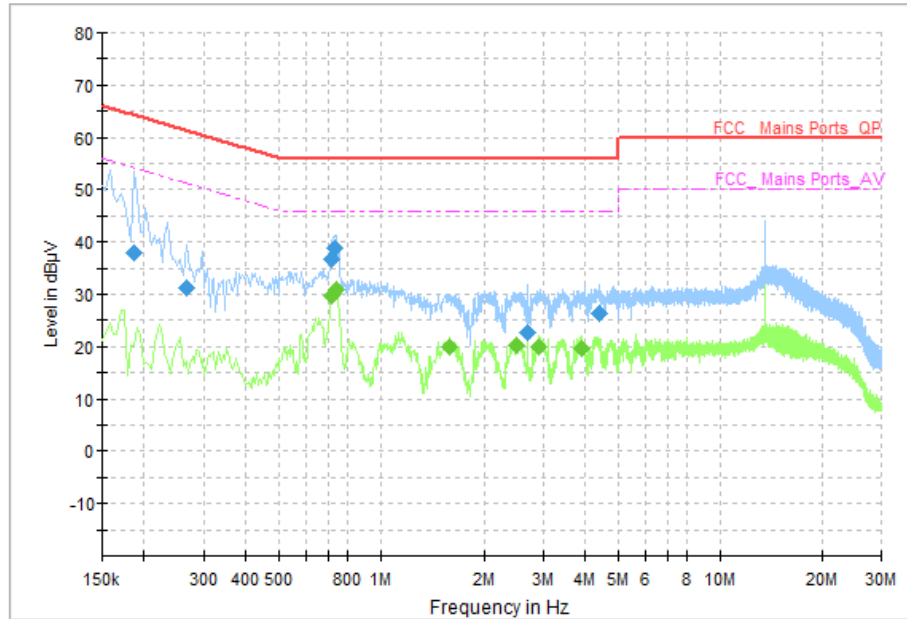

Figure A-5 Test result (120V)

### Final Result 1

Frequency (MHz)	QuasiPeak (dBµV)	Limit (dBµV)	Margin (dB)	Line	Filter	Corr. (dB)
0.186000	37.83	64.21	26.39	L1	ON	10
0.266000	31.20	61.24	30.04	N	ON	10
0.714000	36.61	56.00	19.39	N	ON	10
0.734000	38.81	56.00	17.19	N	ON	10
2.698000	22.75	56.00	33.25	N	ON	10
4.406000	26.48	56.00	29.52	L1	ON	10

### Final Result 2

Frequency (MHz)	Average (dBµV)	Limit (dBµV)	Margin (dB)	Line	Filter	Corr. (dB)
0.718000	29.75	46.00	16.25	N	ON	10
0.738000	30.89	46.00	15.11	N	ON	10
1.586000	19.87	46.00	26.13	N	ON	10
2.498000	20.18	46.00	25.82	L1	ON	10
2.898000	19.98	46.00	26.02	N	ON	10
3.894000	19.78	46.00	26.22	N	ON	10

#### A.6.6. Measurement Uncertainty

Measurement uncertainty:  $U = 3.0$  dB,  $k=2$

## **A.7. Occupied Bandwidth**

### **A.7.1. Reference**

See RSS-Gen section 6.7

### **A.7.2. Measurement Methods**

The transmitter output signal was picked up by coil antenna to the spectrum analyzer.

The transmitter output signal was picked up by coil antenna connected to the spectrum analyzer. The bandwidth of the center frequency was measured with 100Hz RBW, 300Hz VBW and 10kHz span.

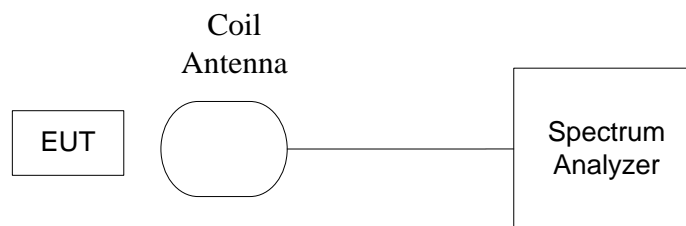

### **A.7.3. EUT Operating Mode and Test Conditions**

The measurement of EUT is carried out under the transmit state of NFC and without modulation (See 3.5).

EUT had been not connected to a travel adapter.

During the measurements, the ambient temperature is in the range of 15 ~ 25°C.

### **A.7.4. Test Layouts**

See A.7.2.

### **A.7.5. Limits**

When the occupied bandwidth limit is not stated in the applicable RSS or reference measurement method, the transmitted signal bandwidth shall be reported as the 99% emission bandwidth, as calculated or measured.

### **A.7.6. Measurement Results**

Measurement results see Figure A-7.

**Conclusions: PASS**



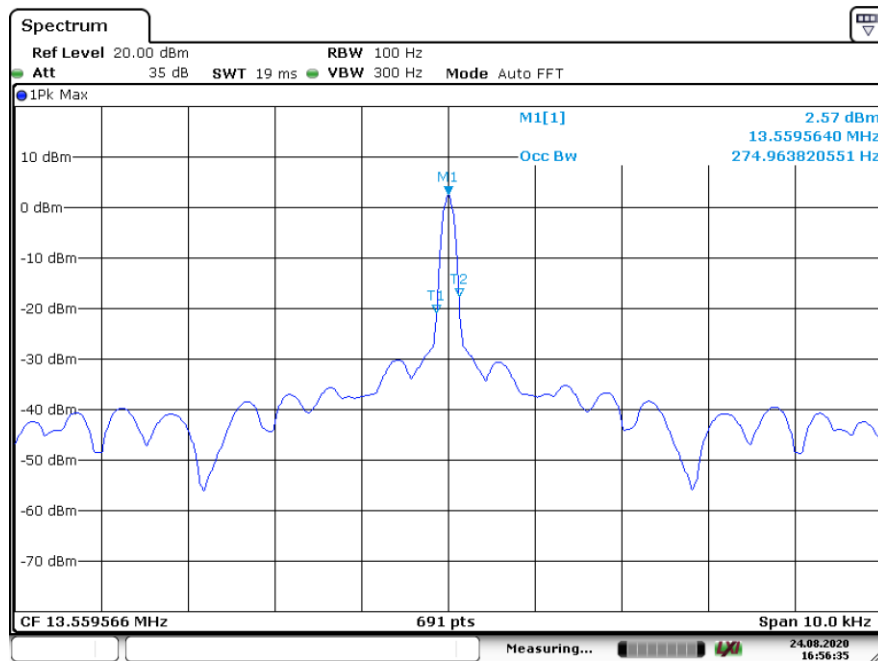

**Figure A-6 Occupied Bandwidth**

**A.7.7. Measurement Uncertainty**

Measurement uncertainty:  $U = 77$  Hz,  $k=2$

**\*\*\*END OF REPORT\*\*\***