

Test of Spectralink 8753 Enhanced IP Telephone

To: FCC 47 CFR Part 15.407 & IC RSS-210

Test Report Serial No.: SPEC27-U6 Rev A



TEST REPORT

FROM



Test of Spectralink 8753 Enhanced IP Telephone

to

To FCC 47 CFR Part 15.407 & IC RSS-210

Test Report Serial No.: SPEC27-U6 Rev A

Note: this report contains data with regard to the 5,150 - 5,350 and 5,470 - 5,725 MHz (DFS) bands for Spectralink 8753 Enhanced IP Telephone 2.4 GHz test data are reported in MiCOM Labs test report SPEC27-U2.

This report supersedes NONE

Applicant: Spectralink Corporation
2560 55th Street
Boulder, Colorado, 80301
USA

Product Function: 802.11a/b/g/n Wireless Telephone

Copy No: pdf Issue Date: 2nd January 2014

This Test Report is Issued Under the Authority of:

MiCOM Labs, Inc.
575 Boulder Court,
Pleasanton, CA 94566 USA
Phone: +1 (925) 462-0304
Fax: +1 (925) 462-0306
www.micomlabs.com



TESTING CERT #2381.01

MiCOM Labs is an ISO 17025 Accredited Testing Laboratory



Title: Spectralink 8753 Enhanced IP Telephone
To: FCC 47 CFR Part 15.407 & IC RSS-210
Serial #: SPEC27-U6 Rev A
Issue Date: 2nd January 2014
Page: 3 of 144

This page has been left intentionally blank

This test report may be reproduced in full only. The document may only be updated by MiCOM Labs personnel. Any changes will be noted in the Document History section of the report.



TABLE OF CONTENTS

ACCREDITATION, LISTINGS & RECOGNITION	5
TESTING ACCREDITATION	5
RECOGNITION	6
PRODUCT CERTIFICATION	7
1. TEST RESULT CERTIFICATE	9
2. REFERENCES AND MEASUREMENT UNCERTAINTY	10
2.1. Normative References.....	10
2.2. Test and Uncertainty Procedures.....	11
3. PRODUCT DETAILS AND TEST CONFIGURATIONS	12
3.1. Technical Details.....	12
3.2. Scope of Test Program	14
3.3. Equipment Model(s) and Serial Number(s).....	17
3.4. Antenna Details.....	17
3.5. Cabling and I/O Ports.....	17
3.6. Test Configurations	18
3.7. Equipment Modifications	19
3.8. Deviations from the Test Standard.....	19
3.9. Subcontracted Testing or Third Party Data.....	19
4. TESTING EQUIPMENT CONFIGURATION(S)	20
4.1. Conducted RF Emission Test Set-up.....	20
4.2. Radiated Spurious Emission Test Set-up > 1 GHz	21
4.3. Digital Emissions Test Set-up (0.03 – 1 GHz).....	22
4.4. ac Wireline Emission Test Set-up	23
5. TEST SUMMARY	24
6. TEST RESULTS	27
6.1. Device Characteristics.....	27
6.1.1. <i>Conducted Testing</i>	27
6.1.2. <i>Radiated Emission Testing</i>	62
6.1.3. <i>AC Wireline Conducted Emissions (150 kHz – 30 MHz)</i>	80
6.1.4. <i>Dynamic Frequency Selection (DFS)</i>	84
7. PHOTOGRAPHS	96
7.1. Test Setup – RF Conducted.....	96
7.2. Test Setup - Digital Emissions 0.03 - 1 GHz.....	97
7.3. Test Setup - Spurious Emissions > 1 GHz.....	98
7.4. Dynamic Frequency Selection (DFS).....	99
8. TEST EQUIPMENT	100
APPENDIX	101
A. SUPPORTING INFORMATION	101
A.1. CONDUCTED TEST PLOTS	101
A.1.1. <i>26 dB & 99% Bandwidth</i>	102
A.1.2. <i>Peak Power Spectral Density</i>	120
A.1.3. <i>Peak Excursion Ratio</i>	138

This test report may be reproduced in full only. The document may only be updated by MiCOM Labs personnel. Any changes will be noted in the Document History section of the report.

ACCREDITATION, LISTINGS & RECOGNITION

TESTING ACCREDITATION

MiCOM Labs, Inc. an accredited laboratory complies with the international standard BS EN ISO/IEC 17025. The company is accredited by the American Association for Laboratory Accreditation (A2LA) www.a2la.org test laboratory number 2381.01. MiCOM Labs test schedule is available at the following URL; <http://www.a2la.org/scopepdf/2381-01.pdf>



The American Association for Laboratory Accreditation

World Class Accreditation

Accredited Laboratory

A2LA has accredited

MICOM LABS

Pleasanton, CA

for technical competence in the field of

Electrical Testing

This laboratory is accredited in accordance with the recognized International Standard ISO/IEC 17025:2005 *General Requirements for the Competence of Testing and Calibration Laboratories*. This accreditation demonstrates technical competence for a defined scope and the operation of a laboratory quality management system (refer to joint ISO-ILAC-IAF Communiqué dated 8 January 2009).

Presented this 27th day of March 2012.



President & CEO
For the Accreditation Council
Certificate Number 2381.01
Valid to February 28, 2014
Revised November 11, 2013

For the tests or types of tests to which this accreditation applies, please refer to the laboratory's Electrical Scope of Accreditation.

This test report may be reproduced in full only. The document may only be updated by MiCOM Labs personnel. Any changes will be noted in the Document History section of the report.



RECOGNITION

MiCOM Labs, Inc has widely recognized Electrical testing capabilities. Our international recognition includes Conformity Assessment Body designation by APEC MRA** countries. Our test reports are widely accepted for global type approvals.

Country	Recognition Body	Status	Phase	Identification No.
USA	Federal Communications Commission (FCC)	TCB	-	US0159 Listing #: 102167
Canada	Industry Canada (IC)	FCB	APEC MRA 2	US0159 Listing #: 4143A-2 4143A-3
Japan	MIC (Ministry of Internal Affairs and Communication)	CAB	APEC MRA 2	RCB 210
	VCCI	--	--	A-0012
Europe	European Commission	NB	EU MRA	NB 2280
Australia	Australian Communications and Media Authority (ACMA)	CAB	APEC MRA 1	US0159
Hong Kong	Office of the Telecommunication Authority (OFTA)	CAB	APEC MRA 1	
Korea	Ministry of Information and Communication Radio Research Laboratory (RRL)	CAB	APEC MRA 1	
Singapore	Infocomm Development Authority (IDA)	CAB	APEC MRA 1	
Taiwan	National Communications Commission (NCC) Bureau of Standards, Metrology and Inspection (BSMI)	CAB	APEC MRA 1	
Vietnam	Ministry of Communication (MIC)	CAB	APEC MRA 1	

**APEC MRA – Asia Pacific Economic Community Mutual Recognition Agreement.

Is a recognition agreement under which test lab is accredited to regulatory standards of the APEC member countries.

Phase I - recognition for product testing

Phase II – recognition for both product testing and certification

N/A – Not Applicable

**EU MRA – European Union Mutual Recognition Agreement.

Is a recognition agreement under which test lab is accredited to regulatory standards of the EU member countries.

**NB – Notified Body

This test report may be reproduced in full only. The document may only be updated by MiCOM Labs personnel. Any changes will be noted in the Document History section of the report.

PRODUCT CERTIFICATION

MiCOM Labs, Inc. is an accredited Product Certification Body per the international standard EN ISO/IEC Guide 65. The company is accredited by the American Association for Laboratory Accreditation (A2LA) www.a2la.org test laboratory number 2381.02. MiCOM Labs test schedule is available at the following URL; <http://www.a2la.org/scopepdf/2381-02.pdf>



The American Association for Laboratory Accreditation

"World Class Accreditation"

Accredited Product Certification Body

A2LA has accredited

MICOM LABS

Pleasanton, CA

for technical competence as a

Product Certification Body

This product certification body is accredited in accordance with the recognized International Standard ISO/IEC Guide 65:1996 *General requirements for bodies operating product certification systems*. This accreditation demonstrates technical competence for a defined scope and the operation of a quality management system.

Presented this 27th day of March 2012.



President & CEO
For the Accreditation Council
Certificate Number 2381.02
Valid to February 28, 2014
Revised November 11, 2013

For the product certification schemes to which this accreditation applies, please refer to the organization's Product Certification Scope of Accreditation

United States of America – Telecommunication Certification Body (TCB)

TCB Identifier – US0159

Industry Canada – Certification Body

CAB Identifier – US0159

Europe – Notified Body

Notified Body Identifier - 2280

Japan – Recognized Certification Body (RCB)

RCB Identifier - 210

This test report may be reproduced in full only. The document may only be updated by MiCOM Labs personnel. Any changes will be noted in the Document History section of the report.



Title: Spectralink 8753 Enhanced IP Telephone
To: FCC 47 CFR Part 15.407 & IC RSS-210
Serial #: SPEC27-U6 Rev A
Issue Date: 2nd January 2014
Page: 8 of 144

DOCUMENT HISTORY

Document History		
Revision	Date	Comments
Draft		
Rev A	2 nd January 2014	Initial release

This test report may be reproduced in full only. The document may only be updated by MiCOM Labs personnel. Any changes will be noted in the Document History section of the report.



Title: Spectralink 8753 Enhanced IP Telephone
To: FCC 47 CFR Part 15.407 & IC RSS-210
Serial #: SPEC27-U6 Rev A
Issue Date: 2nd January 2014
Page: 9 of 144

1. TEST RESULT CERTIFICATE

Applicant:	Spectralink Corporation 2560 55th Street Boulder, Colorado, 80301 USA	Tested By:	MiCOM Labs, Inc. 575 Boulder Court Pleasanton California, 94566, USA
EUT:	802.11a/b/g/n Wireless Telephone	Tel:	+1 925 462 0304
Model:	8753	Fax:	+1 925 462 0306
S/N:	Development Model		
Test Date(s):	30th Oct - 17th Nov 2013	Website:	www.micomlabs.com

STANDARD(S)	TEST RESULTS
FCC 47 CFR Part 15.407 & IC RSS-210 (Including DFS testing for a Client Device without radar detection)	EQUIPMENT COMPLIES

MiCOM Labs, Inc. tested the equipment mentioned in accordance with the requirements set forth in the above standards. Test results indicate that the equipment tested is capable of demonstrating compliance with the requirements as documented within this report.

Notes:

1. This document reports conditions under which testing was conducted and the results of testing performed.
2. Details of test methods used have been recorded and kept on file by the laboratory.
3. Test results apply only to the item(s) tested.

Approved & Released for MiCOM Labs, Inc. by:



TESTING CERT #2381.01



Graeme Grieye
Quality Manager MiCOM Labs,

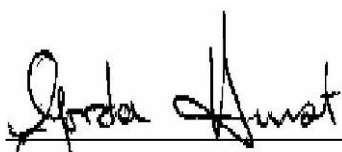

Gordon Hurst
President & CEO MiCOM Labs, Inc.

This test report may be reproduced in full only. The document may only be updated by MiCOM Labs personnel. Any changes will be noted in the Document History section of the report.

2. REFERENCES AND MEASUREMENT UNCERTAINTY

2.1. Normative References

Ref.	Publication	Year	Title
(i)	FCC 47 CFR Part 15.407	2013	Code of Federal Regulations
(ii)	FCC 06-96	June 2006	Memorandum Opinion and Order
(iii)	FCC OET KDB 662911	4 th April 2011	Emissions Testing of Transmitters with Multiple Outputs in the Same Band
(iv)	Industry Canada RSS-210	2010	Low Power License-Exempt Radiocommunication Devices (All Frequency Bands): Category 1 Equipment
(v)	Industry Canada RSS-Gen	2010	General Requirements and Information for the Certification of Radiocommunication Equipment
(vi)	ANSI C63.4	2009	American National Standards for Methods of Measurement of Radio-Noise Emissions from Low-Voltage Electrical and Electronic Equipment in the Range of 9 kHz to 40 GHz
(vii)	CISPR 22/ EN 55022	2008 2006+A1:2007	Limits and Methods of Measurements of Radio Disturbance Characteristics of Information Technology Equipment
(viii)	M 3003	Edition 1 Dec. 1997	Expression of Uncertainty and Confidence in Measurements
(ix)	LAB34	Edition 1 Aug 2002	The expression of uncertainty in EMC Testing
(x)	ETSI TR 100 028	2001	Parts 1 and 2 Electromagnetic compatibility and Radio Spectrum Matters (ERM); Uncertainties in the measurement of mobile radio equipment characteristics
(xi)	A2LA	July 2012	Reference to A2LA Accreditation Status – A2LA Advertising Policy
(xii)	FCC Public Notice – DA 02-2138	2002	Guidelines for Assessing Unlicensed National Information Infrastructure (U-NII) Devices



Title: Spectralink 8753 Enhanced IP Telephone
To: FCC 47 CFR Part 15.407 & IC RSS-210
Serial #: SPEC27-U6 Rev A
Issue Date: 2nd January 2014
Page: 11 of 144

2.2. Test and Uncertainty Procedures

Conducted and radiated emission measurements were conducted in accordance with American National Standards Institute ANSI C63.4, listed in the Normative References section of this report.

Measurement uncertainty figures are calculated in accordance with ETSI TR 100 028 Parts 1 and 2.

Measurement uncertainties stated are based on a standard uncertainty multiplied by a coverage factor $k = 2$, providing a level of confidence of approximately 95 % in accordance with UKAS document M 3003 listed in the Normative References section of this report.

This test report may be reproduced in full only. The document may only be updated by MiCOM Labs personnel. Any changes will be noted in the Document History section of the report.



Title: Spectralink 8753 Enhanced IP Telephone
To: FCC 47 CFR Part 15.407 & IC RSS-210
Serial #: SPEC27-U6 Rev A
Issue Date: 2nd January 2014
Page: 12 of 144

3. PRODUCT DETAILS AND TEST CONFIGURATIONS

3.1. Technical Details

Details	Description
Purpose:	Test of the Spectralink 8753 Enhanced IP Telephone in the frequency range 5,150 - 5,250, 5,250 – 5,350 and 5,470 - 5725 MHz to FCC Part 15.407 and Industry Canada RSS-210 regulations.
Applicant:	Spectralink Corporation 2560 55th Street Boulder, Colorado, 80301,USA
Manufacturer:	Celestica (Thailand) Ltd 49.18 Moo 5, Laem Chabang Industrial Estate Tungskhla, Chonburi, Thailand 20230
Laboratory performing the tests:	MiCOM Labs, Inc. 575 Boulder Court Pleasanton, California 94566 USA
Test report reference number:	SPEC27-U6 Rev A
Date EUT received:	24th October 2013
Standard(s) applied:	FCC 47 CFR Part 15.407 & IC RSS-210
Dates of test (from - to):	30th Oct - 17th Nov 2013
No of Units Tested:	Conducted Testing : Test code with coaxial cable Radiated Testing : Test code operating in normal phone
Type of Equipment:	Product Description
Manufacturers Trade Name:	Spectralink
Model(s):	8753
Location for use:	Indoor
Declared Frequency Range(s):	5,150 – 5,250, 5250 – 5,350 and 5,470 – 5,725 MHz
Hardware Rev	930-0002-003Rev X1
Software Rev	Build 1835
Type of Modulation:	Per 802.11 – CCK, OFDM
Declared Nominal Average Output Power:	5150 – 5250 MHz +14 dBm 5250 – 5350 MHz +21 dBm 5470 - 5725 MHz +21 dBm
EUT Modes of Operation:	802.11a, n HT-20
DFS Operation:	Client Without Radar Detection
Transmit/Receive Operation:	Time Division Duplex
System Beam Forming:	EUT has no capability for antenna beam forming
Rated Input Voltage and Current:	3.6 Vdc (Battery)
Operating Temperature Range:	Declared range 0° to +40°C

This test report may be reproduced in full only. The document may only be updated by MiCOM Labs personnel. Any changes will be noted in the Document History section of the report.



Title: Spectralink 8753 Enhanced IP Telephone
To: FCC 47 CFR Part 15.407 & IC RSS-210
Serial #: SPEC27-U6 Rev A
Issue Date: 2nd January 2014
Page: 13 of 144

ITU Emission Designator:	<u>5150 - 5350 MHz</u> 802.11a 17M4D1D 802.11n HT-20 18M0D1D <u>5470 – 5725 MHz</u> 802.11a 24M6D1D 802.11n HT-20 25M4D1D
Equipment Dimensions:	144.6 (h) x 77.2 (w) x 27.3 (t) mm
Weight:	250 grams
Primary function of equipment:	Wireless Telephony

This test report may be reproduced in full only. The document may only be updated by MiCOM Labs personnel. Any changes will be noted in the Document History section of the report.

3.2. Scope of Test Program

Spectralink 8753 Enhanced IP Telephone RF Testing

The scope of the test program was to test the Spectralink 8753 Enhanced IP Telephone in the frequency range 5,150 – 5,350 and 5,470 – 5,725 MHz for compliance against FCC 47 CFR Part 15.407 and Industry Canada RSS-210 specifications.

Spectralink 8753 Enhanced IP Telephone (Front)

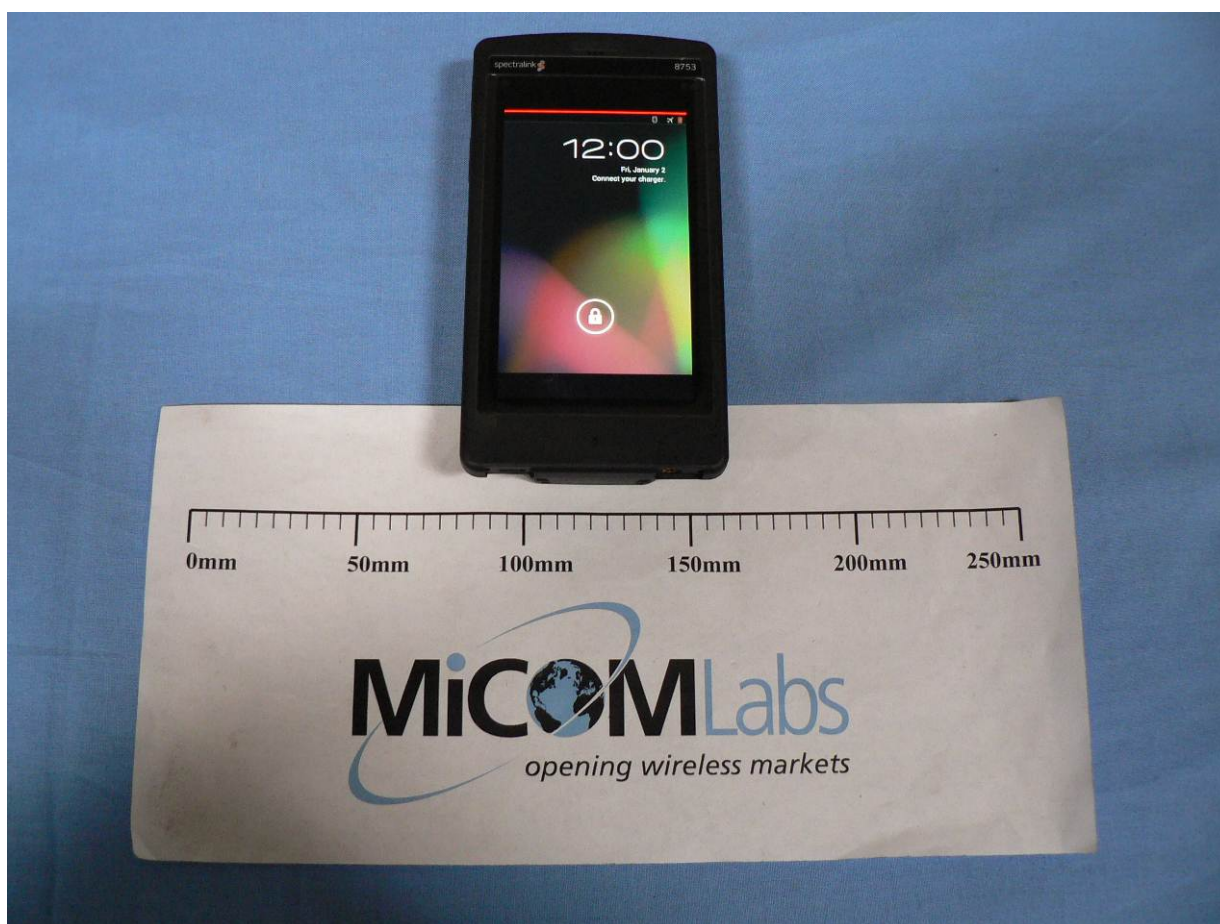

This test report may be reproduced in full only. The document may only be updated by MiCOM Labs personnel. Any changes will be noted in the Document History section of the report.

Spectralink 8753 Enhanced IP Telephone (Rear)



This test report may be reproduced in full only. The document may only be updated by MiCOM Labs personnel. Any changes will be noted in the Document History section of the report.

Spectralink 8753 Enhanced IP Telephone (Barcode Scanner)

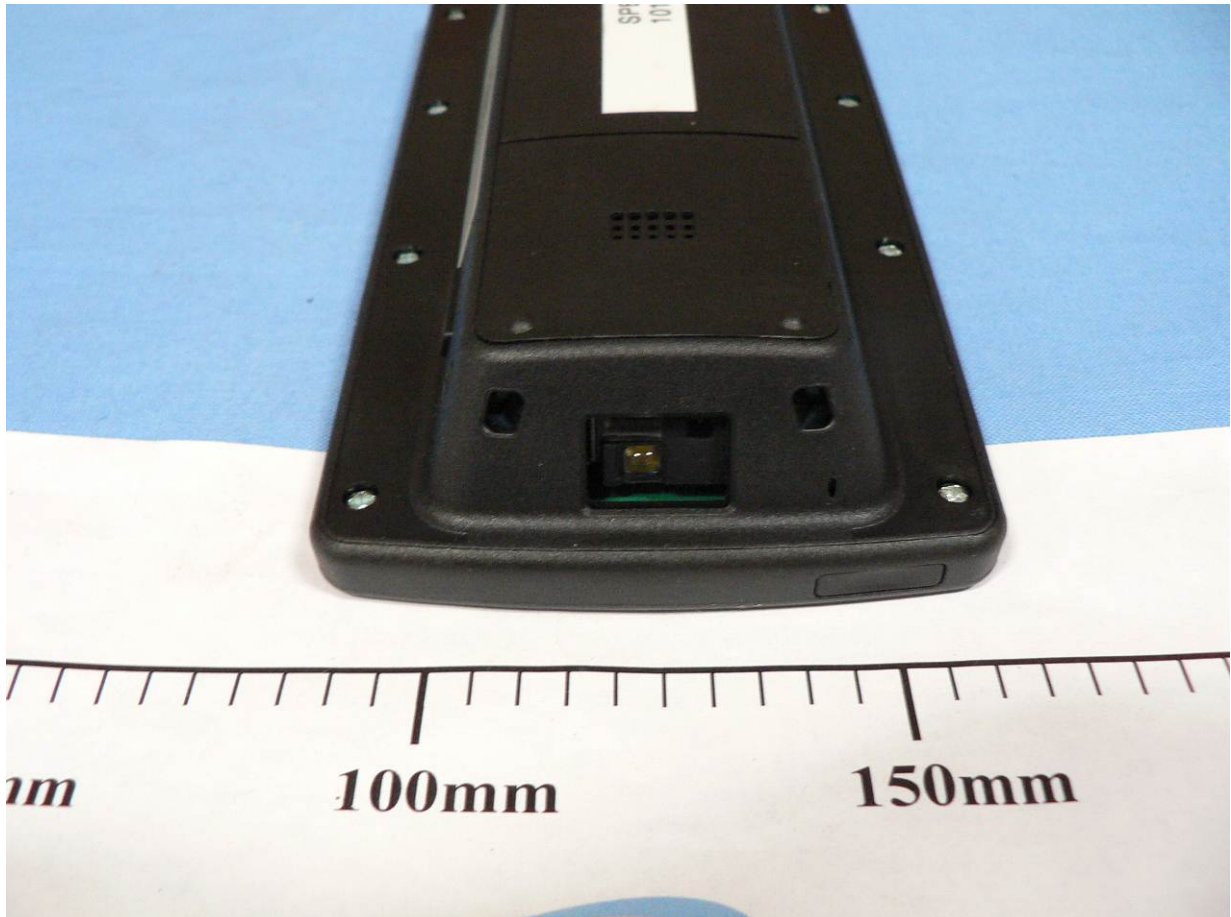



3.3. Equipment Model(s) and Serial Number(s)

Equipment Type	Equipment Description (Including Brand Name)	Mfr	Model No.	Serial No.
EUT	Wireless IP Phone (Radiated Test Phone)	Spectralink	8753	Development Model
EUT	Wireless IP Phone (Conducted Test Phone)	Spectralink	8753	Development Model
Support	Laptop PC	IBM	Thinkpad	None

3.4. Antenna Details

Antenna Type	Manufacturer	Model Number	Antenna Gain (dBi)	
			2.4 GHz	5 GHz
Plated on PCB	Spectralink	Not Applicable	1.2	4.0

3.5. Cabling and I/O Ports

Number and type of I/O ports

1. 1 x Micro USB On The Go (OTG) + Charging



3.6. Test Configurations

Testing was performed to determine the highest power level versus bit rate. The variant with the highest power was used to exercise the product.

Matrix of test configurations

Bands (MHz)	Variant	Data Rates with Highest Power	Frequencies (MHz)
5150 - 5250	802.11a	6 MBit/s	5180, 5200, 5240
5250 - 5350	802.11n HT-20	6.5 MBit/s	5260, 5300, 5320
5470 - 5725			5500, 5580, 5700

Spurious Emission and Band-Edge Test Strategy

Bands 5,150 – 5,350

11a	11n HT-20
SE 5180	SE 5180
SE 5200	SE 5200
SE 5240	SE 5240
SE 5260	SE 5260
SE 5300	SE 5300
SE 5320	SE 5320
BE 5150	BE 5150
BE 5350	BE 5350

Band 5,470 – 5,725

11a	11n HT-20
SE 5500	SE 5500
SE 5580	SE 5580
SE 5700	SE 5700
BE 5470	BE 5470

KEY:-
SE – Spurious Emissions
BE – Band-Edge



Title: Spectralink 8753 Enhanced IP Telephone
To: FCC 47 CFR Part 15.407 & IC RSS-210
Serial #: SPEC27-U6 Rev A
Issue Date: 2nd January 2014
Page: 19 of 144

3.7. Equipment Modifications

The following modifications were required to bring the equipment into compliance:

1. NONE

3.8. Deviations from the Test Standard

The following deviations from the test standard were required in order to complete the test program:

1. NONE

3.9. Subcontracted Testing or Third Party Data

1. NONE

This test report may be reproduced in full only. The document may only be updated by MiCOM Labs personnel. Any changes will be noted in the Document History section of the report.

4. TESTING EQUIPMENT CONFIGURATION(S)

4.1. Conducted RF Emission Test Set-up

The following tests were performed using the conducted test set-up shown in the diagram below.

1. Section 6.1.1.1. 26 dB and 99% Bandwidth
2. Section 6.1.1.2. Maximum Conducted Output Power
3. Section 6.1.1.3. Peak Power Spectral Density
4. Section 6.1.1.4. Peak Excursion Ratio

Conducted Test Set-Up Pictorial Representation

3 - Port Test Configuration

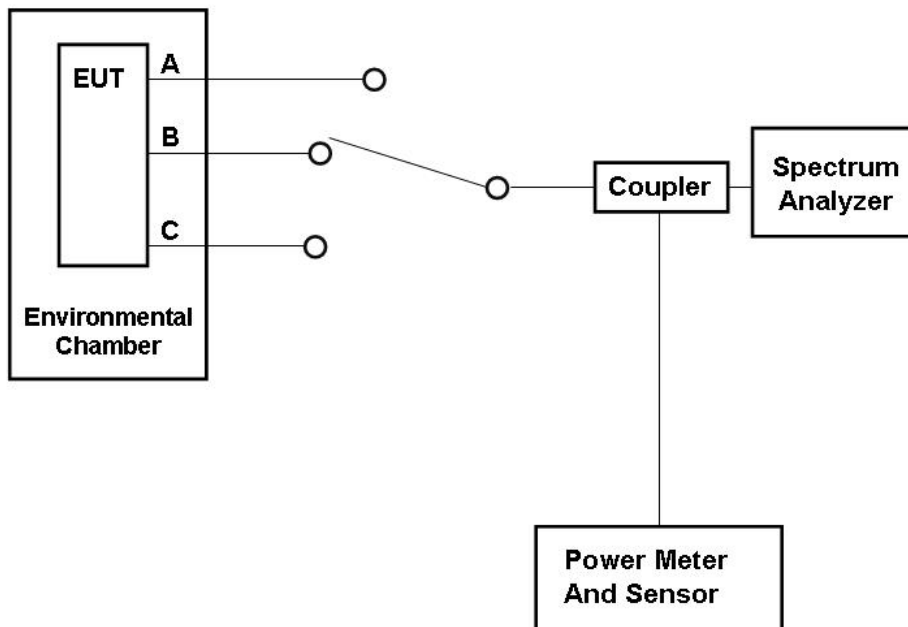

This test report may be reproduced in full only. The document may only be updated by MiCOM Labs personnel. Any changes will be noted in the Document History section of the report.

4.2. Radiated Spurious Emission Test Set-up > 1 GHz

The following tests were performed using the conducted test set-up shown in the diagram below.

Radiated Emission Measurement Setup – Above 1 GHz

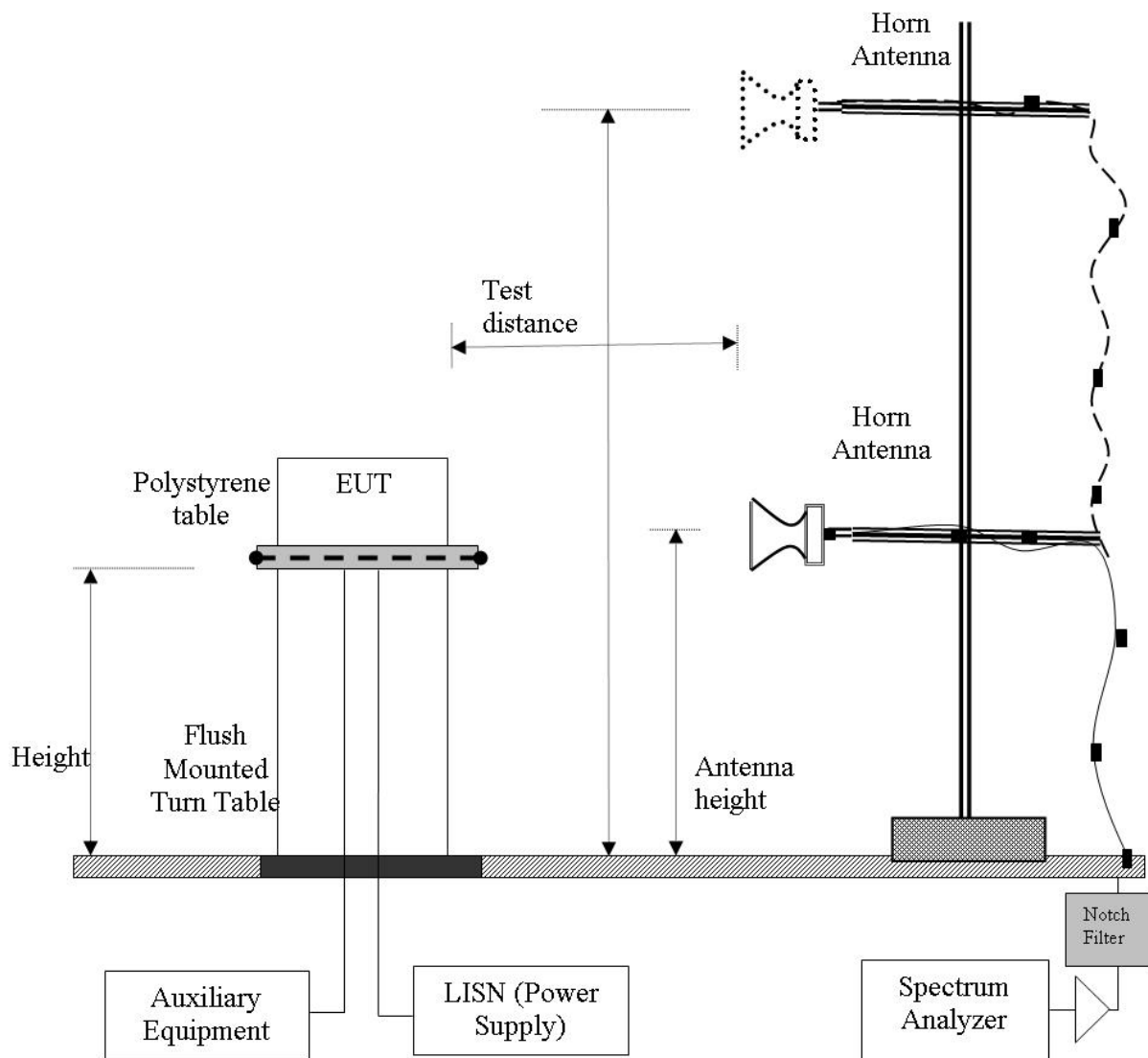

This test report may be reproduced in full only. The document may only be updated by MiCOM Labs personnel. Any changes will be noted in the Document History section of the report.

4.3. Digital Emissions Test Set-up (0.03 – 1 GHz)

The following tests were performed using the conducted test set-up shown in the diagram below.

1. Section 6.1.2.4. Digital Emissions

Digital Emission Measurement Setup – Below 1 GHz

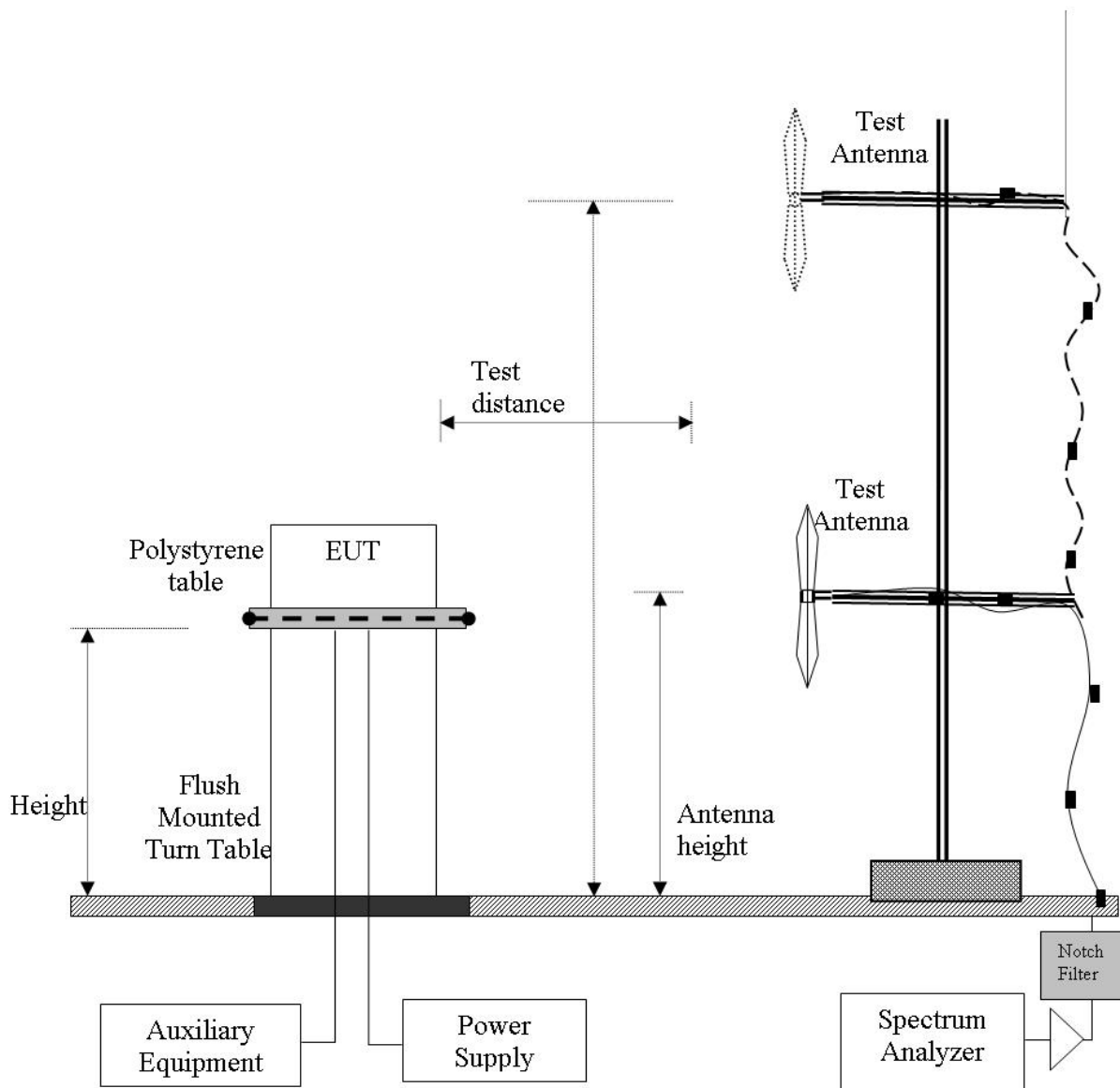

This test report may be reproduced in full only. The document may only be updated by MiCOM Labs personnel. Any changes will be noted in the Document History section of the report.

4.4. ac Wireline Emission Test Set-up

The following tests were performed using the conducted test set-up shown in the diagram below.

1. Section 6.1.3 ac Wireline Conducted Emissions

Conducted Test Set-Up Pictorial Representation

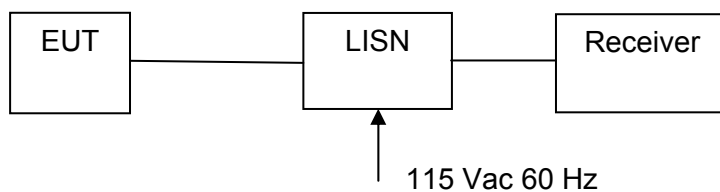

Measurement set up for ac Wireline Conducted Emissions Test



5. TEST SUMMARY

List of Measurements

The following table represents the list of measurements required under the **FCC CFR47 Part 15.407** and **Industry Canada RSS-210** and **Industry Canada RSS-Gen**.

Section(s)	Test Items	Description	Condition	Result	Test Report Section
15.407(a) A9.2(2) 4.4	26dB and 99% Emission BW	Emission bandwidth measurement	Conducted	Complies	6.1.1.1 A.1.1
15.407(a) A9.2(2) 4.6	Maximum Conducted Output Power	Power Measurement	Conducted	Complies	6.1.1.2
15.407(a) A9.2(2)	Peak Power Spectral Density	PPSD	Conducted	Complies	6.1.1.3 A.1.2
15.407(a)(6)	Peak Excursion Ratio	<13dB in any 1MHz bandwidth	Conducted	Complies	6.1.1.4 A.1.3
15.407(g) 15.31 2.1 4.5	Frequency Stability	Limits: contained within band of operation at all times.	Applicant declaration	Complies	6.1.1.5

This test report may be reproduced in full only. The document may only be updated by MiCOM Labs personnel. Any changes will be noted in the Document History section of the report.



List of Measurements (continued)

The following table represents the list of measurements required under the **FCC CFR47 Part 15.407** and **Industry Canada RSS-210** and **Industry Canada RSS-Gen**.

Section(s)	Test Items	Description	Condition	Result	Test Report Section
15.407(b)(2) 15.205(a) 15.209(a) 2.2 2.6 A9.3(2) 4.7	Radiated Emissions		Radiated		6.1.2
	Transmitter Radiated Spurious Emissions	Emissions above 1 GHz		Complies	6.1.2.1 6.1.2.2 6.1.2.3
	Radiated Band Edge	Band edge results		Complies	6.1.2.1 6.1.2.2 6.1.2.3
15.407(b)(6) 15.205(a) 15.209(a) 2.2	Radiated Emissions	Emissions <1 GHz (30M-1 GHz)		Complies	6.1.2.4
15.407(b)(6) 15.207 7.2.2	AC Wireline Conducted Emissions 150 kHz–30 MHz	Conducted Emissions	Conducted	Complies	6.1.3

Note 1: Test results reported in this document relate only to the items tested

Note 2: The required tests demonstrated compliance as per client declaration of test configuration, monitoring methodology and associated pass/fail criteria

Note 3: Section 3.7 Equipment Modifications highlights the equipment modifications that were required to bring the product into compliance with the above test matrix



List of Measurements (cont'd)

Dynamic Frequency Selection (DFS)

The following table represents the list of measurements required under the **FCC CFR47 Part 15.407(h)(2)** and **FCC Memorandum Opinion and Order FCC 06-96 (Compliance Measurement procedures for Unlicensed National Information Infrastructure devices operating in the 5250-5350 MHz and 5470-5725 MHz bands incorporating dynamic frequency selection).**

Tests performed on Client Device

Section	Test Items	Description	Condition	Result	Test Report Section
	DFS	Dynamic Frequency Selection	Conducted		6.1.4
7.8.1	Detection Bandwidth	UNII Detection Bandwidth	Conducted	Not Applicable	
7.8.2.1	Performance Requirements Check	Initial Channel Availability Check Time	Conducted	Not Applicable	
7.8.2.2		Radar Burst at the Beginning of the Channel Availability Check Time	Conducted	Not Applicable	
7.8.2.3		Radar Burst at the End of the Channel Availability Check Time	Conducted	Not Applicable	
7.8.3	In-Service Monitoring	In-Service Monitoring for Channel Move Time, Channel Closing Transmission Time.	Conducted	Complies	
7.8.4	Radar Detection	Statistical Performance Check	Conducted	Not Applicable	

This test report may be reproduced in full only. The document may only be updated by MiCOM Labs personnel. Any changes will be noted in the Document History section of the report.



Title: Spectralink 8753 Enhanced IP Telephone
To: FCC 47 CFR Part 15.407 & IC RSS-210
Serial #: SPEC27-U6 Rev A
Issue Date: 2nd January 2014
Page: 27 of 144

6. TEST RESULTS

6.1. Device Characteristics

6.1.1. Conducted Testing

6.1.1.1. 26 dB and 99 % Bandwidth

Conducted Test Conditions for 26 dB and 99% Bandwidth			
Standard:	FCC CFR 47:15.407	Ambient Temp. (°C):	24.0 - 27.5
Test Heading:	26 dB and 99 % Bandwidth	Rel. Humidity (%):	32 - 45
Standard Section(s):	15.407 (a)	Pressure (mBars):	999 - 1001
Reference Document(s):	KDB 789033 - D01 DTS General UNII Test Procedures v01		

Test Procedure for 26 dB and 99% Bandwidth Measurement

The bandwidth at 26 dB and 99 % is measured with a spectrum analyzer connected to the antenna terminal, while EUT is operating in transmission mode at the appropriate center frequency. KDB 789033 Section 5.1 Emission Bandwidth was used in order to prove compliance. The Resolution Bandwidth was set to approximately 1% of the emission bandwidth.

This test report may be reproduced in full only. The document may only be updated by MiCOM Labs personnel. Any changes will be noted in the Document History section of the report.



Title: Spectralink 8753 Enhanced IP Telephone
To: FCC 47 CFR Part 15.407 & IC RSS-210
Serial #: SPEC27-U6 Rev A
Issue Date: 2nd January 2014
Page: 28 of 144

Measurement Results for 26 dB and 99 % Operational Bandwidth(s)

Equipment Configuration for 26 dB & 99% Occupied Bandwidth

Variant:	802.11a	Duty Cycle (%):	99
Data Rate:	6 MBit/s	Antenna Gain (dBi):	Not Applicable
Modulation:	OFDM	Beam Forming Gain (Y):	Not Applicable
TPC:	Not Applicable	Tested By:	CC
Engineering Test Notes:			

Test Measurement Results

Test Frequency	Measured 26 dB Bandwidth (MHz)				26 dB Bandwidth (MHz)			
	Port(s)				Highest	Lowest		
MHz	a	b	c	d				
5180.0	22.645				22.645	22.645		
5200.0	22.445				22.445	22.445		
5240.0	22.244				22.244	22.244		

Test Frequency	Measured 99% Bandwidth (MHz)				99% Bandwidth (MHz)			
	Port(s)				Highest	Lowest		
MHz	a	b	c	d				
5180.0	16.633				16.633	16.633		
5200.0	16.533				16.533	16.533		
5240.0	16.533				16.533	16.533		

Traceability to Industry Recognized Test Methodologies

Work Instruction:	WI-03 MEASURING RF SPECTRUM MASK
Measurement Uncertainty:	±2.81 dB

This test report may be reproduced in full only. The document may only be updated by MiCOM Labs personnel. Any changes will be noted in the Document History section of the report.



Title: Spectralink 8753 Enhanced IP Telephone
To: FCC 47 CFR Part 15.407 & IC RSS-210
Serial #: SPEC27-U6 Rev A
Issue Date: 2nd January 2014
Page: 29 of 144

Equipment Configuration for 26 dB & 99% Occupied Bandwidth

Variant:	802.11n HT-20	Duty Cycle (%):	99
Data Rate:	6.5 MBit/s	Antenna Gain (dBi):	Not Applicable
Modulation:	OFDM	Beam Forming Gain (Y):	Not Applicable
TPC:	Not Applicable	Tested By:	CC
Engineering Test Notes:			

Test Measurement Results

Test Frequency	Measured 26 dB Bandwidth (MHz)				26 dB Bandwidth (MHz)			
	Port(s)				Highest	Lowest		
MHz	a	b	c	d				
5180.0	23.647				23.647	23.647		
5200.0	23.647				23.647	23.647		
5240.0	23.848				23.848	23.848		

Test Frequency	Measured 99% Bandwidth (MHz)				99% Bandwidth (MHz)			
	Port(s)				Highest	Lowest		
MHz	a	b	c	d				
5180.0	17.735				17.735	17.735		
5200.0	17.735				17.735	17.735		
5240.0	17.735				17.735	17.735		

Traceability to Industry Recognized Test Methodologies

Work Instruction:	WI-03 MEASURING RF SPECTRUM MASK
Measurement Uncertainty:	±2.81 dB

This test report may be reproduced in full only. The document may only be updated by MiCOM Labs personnel. Any changes will be noted in the Document History section of the report.



Title: Spectralink 8753 Enhanced IP Telephone
To: FCC 47 CFR Part 15.407 & IC RSS-210
Serial #: SPEC27-U6 Rev A
Issue Date: 2nd January 2014
Page: 30 of 144

Equipment Configuration for 26 dB & 99% Occupied Bandwidth

Variant:	802.11a	Duty Cycle (%):	99
Data Rate:	6 MBit/s	Antenna Gain (dBi):	Not Applicable
Modulation:	OFDM	Beam Forming Gain (Y):	Not Applicable
TPC:	Not Applicable	Tested By:	CC
Engineering Test Notes:			

Test Measurement Results

Test Frequency	Measured 26 dB Bandwidth (MHz)				26 dB Bandwidth (MHz)			
	Port(s)				Highest	Lowest		
MHz	a	b	c	d				
5260.0	37.375				37.375	37.375		
5300.0	37.375				37.375	37.375		
5320.0	37.675				37.675	37.675		

Test Frequency	Measured 99% Bandwidth (MHz)				99% Bandwidth (MHz)			
	Port(s)				Highest	Lowest		
MHz	a	b	c	d				
5260.0	23.848				23.848	23.848		
5300.0	23.747				23.747	23.747		
5320.0	23.447				23.447	23.447		

Traceability to Industry Recognized Test Methodologies

Work Instruction:	WI-03 MEASURING RF SPECTRUM MASK
Measurement Uncertainty:	±2.81 dB

This test report may be reproduced in full only. The document may only be updated by MiCOM Labs personnel. Any changes will be noted in the Document History section of the report.



Title: Spectralink 8753 Enhanced IP Telephone
To: FCC 47 CFR Part 15.407 & IC RSS-210
Serial #: SPEC27-U6 Rev A
Issue Date: 2nd January 2014
Page: 31 of 144

Equipment Configuration for 26 dB & 99% Occupied Bandwidth

Variant:	802.11n HT-20	Duty Cycle (%):	99
Data Rate:	6.5 MBit/s	Antenna Gain (dBi):	Not Applicable
Modulation:	OFDM	Beam Forming Gain (Y):	Not Applicable
TPC:	Not Applicable	Tested By:	CC
Engineering Test Notes:			

Test Measurement Results

Test Frequency	Measured 26 dB Bandwidth (MHz)				26 dB Bandwidth (MHz)			
	Port(s)				Highest	Lowest		
MHz	a	b	c	d				
5260.0	39.379				39.379	39.379		
5300.0	39.379				39.379	39.379		
5320.0	39.078				39.078	39.078		

Test Frequency	Measured 99% Bandwidth (MHz)				99% Bandwidth (MHz)			
	Port(s)				Highest	Lowest		
MHz	a	b	c	d				
5260.0	24.549				24.549	24.549		
5300.0	24.449				24.449	24.449		
5320.0	24.549				24.549	24.549		

Traceability to Industry Recognized Test Methodologies

Work Instruction:	WI-03 MEASURING RF SPECTRUM MASK
Measurement Uncertainty:	±2.81 dB

This test report may be reproduced in full only. The document may only be updated by MiCOM Labs personnel. Any changes will be noted in the Document History section of the report.



Title: Spectralink 8753 Enhanced IP Telephone
To: FCC 47 CFR Part 15.407 & IC RSS-210
Serial #: SPEC27-U6 Rev A
Issue Date: 2nd January 2014
Page: 32 of 144

Equipment Configuration for 26 dB & 99% Occupied Bandwidth

Variant:	802.11a	Duty Cycle (%):	99
Data Rate:	6 MBit/s	Antenna Gain (dBi):	Not Applicable
Modulation:	OFDM	Beam Forming Gain (Y):	Not Applicable
TPC:	Not Applicable	Tested By:	CC
Engineering Test Notes:			

Test Measurement Results

Test Frequency	Measured 26 dB Bandwidth (MHz)				26 dB Bandwidth (MHz)			
	Port(s)				Highest	Lowest		
MHz	a	b	c	d				
5500.0	33.066				33.066	33.066		
5580.0	36.072				36.072	36.072		
5700.0	38.878				38.878	38.878		

Test Frequency	Measured 99% Bandwidth (MHz)				99% Bandwidth (MHz)			
	Port(s)				Highest	Lowest		
MHz	a	b	c	d				
5500.0	19.439				19.439	19.439		
5580.0	22.244				22.244	22.244		
5700.0	24.449				24.449	24.449		

Traceability to Industry Recognized Test Methodologies

Work Instruction:	WI-03 MEASURING RF SPECTRUM MASK
Measurement Uncertainty:	±2.81 dB

This test report may be reproduced in full only. The document may only be updated by MiCOM Labs personnel. Any changes will be noted in the Document History section of the report.



Title: Spectralink 8753 Enhanced IP Telephone
To: FCC 47 CFR Part 15.407 & IC RSS-210
Serial #: SPEC27-U6 Rev A
Issue Date: 2nd January 2014
Page: 33 of 144

Equipment Configuration for 26 dB & 99% Occupied Bandwidth

Variant:	802.11n HT-20	Duty Cycle (%):	99
Data Rate:	6.5 MBit/s	Antenna Gain (dBi):	Not Applicable
Modulation:	OFDM	Beam Forming Gain (Y):	Not Applicable
TPC:	Not Applicable	Tested By:	CC
Engineering Test Notes:			

Test Measurement Results

Test Frequency	Measured 26 dB Bandwidth (MHz)				26 dB Bandwidth (MHz)			
	Port(s)				Highest	Lowest		
MHz	a	b	c	d				
5500.0	38.978				38.978	38.978		
5580.0	36.974				36.974	36.974		
5700.0	39.279				39.279	39.279		

Test Frequency	Measured 99% Bandwidth (MHz)				99% Bandwidth (MHz)			
	Port(s)				Highest	Lowest		
MHz	a	b	c	d				
5500.0	24.549				24.549	24.549		
5580.0	23.046				23.046	23.046		
5700.0	25.251				25.251	25.251		

Traceability to Industry Recognized Test Methodologies

Work Instruction:	WI-03 MEASURING RF SPECTRUM MASK
Measurement Uncertainty:	±2.81 dB

This test report may be reproduced in full only. The document may only be updated by MiCOM Labs personnel. Any changes will be noted in the Document History section of the report.



Specification

Limits

FCC, Part 15 §15.407 (a)(1), (a)(2) and Industry Canada RSS-210 § A9.2(2)

(a)(1) For the band 5.15-5.25 GHz the maximum conducted output power over the frequency band of operation shall not exceed the lesser of 50 mW or +4 dBm + 10 log B, where B is the 26 dB emission bandwidth in megahertz. In addition, the peak power spectral density shall not exceed +4 dBm in any 1 megahertz band.

(a)(2) For the 5.25-5.35 GHz band the maximum conducted output power over the frequency band of operation shall not exceed the lesser of 250 mW or +11 dBm + 10 log B, where B is the 26 dB emission bandwidth in megahertz. In addition, the peak power spectral density shall not exceed +11 dBm in any 1 megahertz band.

Industry Canada RSS-Gen 4.4

When an occupied bandwidth value is not specified in the applicable RSS, the transmitted signal bandwidth to be reported is to be its 99% emission bandwidth, as calculated or measured.

Traceability

Test Equipment Used
0158, 0287, 0252, 0313, 0314, 0070, 0116, 0117



Title: Spectralink 8753 Enhanced IP Telephone
To: FCC 47 CFR Part 15.407 & IC RSS-210
Serial #: SPEC27-U6 Rev A
Issue Date: 2nd January 2014
Page: 35 of 144

6.1.1.2. Maximum Conducted Output Power

Conducted Test Conditions for Maximum Conducted Output Power			
Standard:	FCC CFR 47:15.407	Ambient Temp. (°C):	24.0 - 27.5
Test Heading:	Maximum Conducted Output Power	Rel. Humidity (%):	32 - 45
Standard Section(s):	15.407 (a)	Pressure (mBars):	999 - 1001
Reference Document(s):	KDB 789033 - D01 DTS General UNII Test Procedures v01		
Test Procedure for Maximum Conducted Output Power Measurement			
<p>Method PM (Measurement using an RF average power meter). Section C) 4) of KDB 789033 defines a methodology using an average wideband power meter. Measurements were made while the EUT was operating in a continuous transmission mode (100% duty cycle) at the appropriate center frequency. All cable losses and offsets were taken into consideration in the measured result. All operational modes and frequency bands were measured independently and the resultant \square calculated. For multiple outputs, the measurements were made simultaneously on each output port and summed in a linear fashion. This technique was used in order to prove compliance.</p>			

This test report may be reproduced in full only. The document may only be updated by MiCOM Labs personnel. Any changes will be noted in the Document History section of the report.



Maximum Transmit (Conducted) Power, FCC Limits and Industry Canada Limits

FCC Limits

Bands 5150 – 5250 MHz

Limit lesser of: 50 mW or 4 dBm + 10 log (B) dBm.

Mode	Frequency Range (MHz)	26 dB Bandwidth (MHz)	11 + 10 Log (B) (dBm)	Conducted Power Limit (dBm)
a	5150 – 5250	22.244	+27.47	+17.0
HT-20		23.647	+17.73	+17.0

Bands 5250 – 5350 MHz and 5470 – 5725 MHz

Limit lesser of: 250 mW or 11 dBm + 10 log (B) dBm.

Mode	Frequency Range (MHz)	26 dB Bandwidth (MHz)	11 + 10 Log (B) (dBm)	Conducted Power Limit (dBm)
a	5250 – 5350	37.375	+26.57	+24.0
HT-20		39.078	+26.91	+24.0
a	5470 – 5725	33.066	+26.19	+24.0
HT-20		36.974	+26.68	+24.0



Industry Canada Limits

Bands 5150 – 5250 MHz

The maximum e.i.r.p. shall not exceed 200 mW or $10 + 10 \log_{10} B$, dBm

Mode	Frequency Range (MHz)	99% Bandwidth (MHz)	11 + 10 Log (B) (dBm)	EIRP Limit (dBm)
a	5150 – 5250	16.533	+22.18	+22.18
HT-20		17.735	+22.49	+22.49

Bands 5250 – 5350 MHz and 5470 – 5725 MHz

Limit lesser of: 250 mW or $11 \text{ dBm} + 10 \log (B)$ dBm.

Mode	Frequency Range (MHz)	99% Bandwidth (MHz)	11 + 10 Log (B) (dBm)	Conducted Power Limit (dBm)
a	5250 – 5350	23.447	+24.70	+24.0
HT-20		24.449	+24.88	+24.0
a	5470 – 5725	19.439	+23.88	+24.0
HT-20		23.046	+24.62	+24.0



Title: Spectralink 8753 Enhanced IP Telephone
To: FCC 47 CFR Part 15.407 & IC RSS-210
Serial #: SPEC27-U6 Rev A
Issue Date: 2nd January 2014
Page: 38 of 144

Equipment Configuration for Peak Transmit Power

Variant:	802.11a	Duty Cycle (%):	99
Data Rate:	6 MBit/s	Antenna Gain (dBi):	3.30
Modulation:	OFDM	Beam Forming Gain (Y):	Not Applicable
TPC:	Not Applicable	Tested By:	CC
Engineering Test Notes:			

Test Measurement Results

Test Frequency	Measured Conducted Output Power (dBm)				Calculated Total Power	Minimum 26 dB Bandwidth	Limit	Margin	EUT Power Setting
	Port(s)								
MHz	a	b	c	d	Σ Port(s) dBm	MHz	dBm	dBm	
5180.0	13.01				13.01	22.645	17.00	-3.99	11.00
5200.0	13.08				13.08	22.445	17.00	-3.92	11.00
5240.0	13.33				13.33	22.244	17.00	-3.67	11.00

Traceability to Industry Recognized Test Methodologies

Work Instruction:	WI-03 MEASURING RF SPECTRUM MASK
Measurement Uncertainty:	±2.81 dB

This test report may be reproduced in full only. The document may only be updated by MiCOM Labs personnel. Any changes will be noted in the Document History section of the report.



Title: Spectralink 8753 Enhanced IP Telephone
To: FCC 47 CFR Part 15.407 & IC RSS-210
Serial #: SPEC27-U6 Rev A
Issue Date: 2nd January 2014
Page: 39 of 144

Equipment Configuration for Peak Transmit Power

Variant:	802.11n HT-20	Duty Cycle (%):	99
Data Rate:	6.5 MBit/s	Antenna Gain (dBi):	3.30
Modulation:	OFDM	Beam Forming Gain (Y):	Not Applicable
TPC:	Not Applicable	Tested By:	CC
Engineering Test Notes:			

Test Measurement Results

Test Frequency	Measured Conducted Output Power (dBm)				Calculated Total Power Σ Port(s) dBm	Minimum 26 dB Bandwidth MHz	Limit dBm	Margin dBm	EUT Power Setting
	a	b	c	d					
5180.0	13.75				13.75	23.647	17.00	-3.25	12.00
5200.0	13.95				13.95	23.647	17.00	-3.05	12.00
5240.0	14.18				14.18	23.848	17.00	-2.82	12.00

Traceability to Industry Recognized Test Methodologies

Work Instruction:	WI-03 MEASURING RF SPECTRUM MASK
Measurement Uncertainty:	±2.81 dB

This test report may be reproduced in full only. The document may only be updated by MiCOM Labs personnel. Any changes will be noted in the Document History section of the report.



Title: Spectralink 8753 Enhanced IP Telephone
To: FCC 47 CFR Part 15.407 & IC RSS-210
Serial #: SPEC27-U6 Rev A
Issue Date: 2nd January 2014
Page: 40 of 144

Equipment Configuration for Peak Transmit Power

Variant:	802.11a	Duty Cycle (%):	99
Data Rate:	6 MBit/s	Antenna Gain (dBi):	3.30
Modulation:	OFDM	Beam Forming Gain (Y):	Not Applicable
TPC:	Not Applicable	Tested By:	CC
Engineering Test Notes:			

Test Measurement Results

Test Frequency	Measured Conducted Output Power (dBm)				Calculated Total Power	Minimum 26 dB Bandwidth	Limit	Margin	EUT Power Setting
	Port(s)								
MHz	a	b	c	d	Σ Port(s) dBm	MHz	dBm	dBm	
5260.0	20.64				20.64	37.375	24.00	-3.36	20.00
5300.0	20.76				20.76	37.375	24.00	-3.24	20.00
5320.0	20.73				20.73	37.675	24.00	-3.27	20.00

Traceability to Industry Recognized Test Methodologies

Work Instruction:	WI-03 MEASURING RF SPECTRUM MASK
Measurement Uncertainty:	±2.81 dB

This test report may be reproduced in full only. The document may only be updated by MiCOM Labs personnel. Any changes will be noted in the Document History section of the report.



Title: Spectralink 8753 Enhanced IP Telephone
To: FCC 47 CFR Part 15.407 & IC RSS-210
Serial #: SPEC27-U6 Rev A
Issue Date: 2nd January 2014
Page: 41 of 144

Equipment Configuration for Peak Transmit Power

Variant:	802.11n HT-20	Duty Cycle (%):	99
Data Rate:	6.5 MBit/s	Antenna Gain (dBi):	3.30
Modulation:	OFDM	Beam Forming Gain (Y):	Not Applicable
TPC:	Not Applicable	Tested By:	CC
Engineering Test Notes:			

Test Measurement Results

Test Frequency	Measured Conducted Output Power (dBm)				Calculated Total Power	Minimum 26 dB Bandwidth	Limit	Margin	EUT Power Setting
	Port(s)								
MHz	a	b	c	d	Σ Port(s) dBm	MHz	dBm	dBm	
5260.0	20.57				20.57	39.379	24.00	-3.43	20.00
5300.0	20.66				20.66	39.379	24.00	-3.34	20.00
5320.0	20.64				20.64	39.078	24.00	-3.36	20.00

Traceability to Industry Recognized Test Methodologies

Work Instruction:	WI-03 MEASURING RF SPECTRUM MASK
Measurement Uncertainty:	±2.81 dB

This test report may be reproduced in full only. The document may only be updated by MiCOM Labs personnel. Any changes will be noted in the Document History section of the report.



Title: Spectralink 8753 Enhanced IP Telephone
To: FCC 47 CFR Part 15.407 & IC RSS-210
Serial #: SPEC27-U6 Rev A
Issue Date: 2nd January 2014
Page: 42 of 144

Equipment Configuration for Peak Transmit Power

Variant:	802.11a	Duty Cycle (%):	99
Data Rate:	6 MBit/s	Antenna Gain (dBi):	4.10
Modulation:	OFDM	Beam Forming Gain (Y):	Not Applicable
TPC:	Not Applicable	Tested By:	CC
Engineering Test Notes:			

Test Measurement Results

Test Frequency	Measured Conducted Output Power (dBm)				Calculated Total Power	Minimum 26 dB Bandwidth	Limit	Margin	EUT Power Setting
	Port(s)								
MHz	a	b	c	d	Σ Port(s) dBm	MHz	dBm	dBm	
5500.0	20.14				20.24	33.066	24.00	-3.76	19.00
5580.0	20.05				20.15	36.072	24.00	-3.85	20.00
5700.0	21.08				21.18	38.878	24.00	-2.82	20.00

Traceability to Industry Recognized Test Methodologies

Work Instruction:	WI-03 MEASURING RF SPECTRUM MASK
Measurement Uncertainty:	±2.81 dB

This test report may be reproduced in full only. The document may only be updated by MiCOM Labs personnel. Any changes will be noted in the Document History section of the report.



Title: Spectralink 8753 Enhanced IP Telephone
To: FCC 47 CFR Part 15.407 & IC RSS-210
Serial #: SPEC27-U6 Rev A
Issue Date: 2nd January 2014
Page: 43 of 144

Equipment Configuration for Peak Transmit Power

Variant:	802.11n HT-20	Duty Cycle (%):	99
Data Rate:	6.5 MBit/s	Antenna Gain (dBi):	4.10
Modulation:	OFDM	Beam Forming Gain (Y):	Not Applicable
TPC:	Not Applicable	Tested By:	CC
Engineering Test Notes:			

Test Measurement Results

Test Frequency	Measured Conducted Output Power (dBm)				Calculated Total Power	Minimum 26 dB Bandwidth	Limit	Margin	EUT Power Setting
	Port(s)								
MHz	a	b	c	d	Σ Port(s) dBm	MHz	dBm	dBm	
5500.0	21.13				21.23	38.978	24.00	-2.77	20.00
5580.0	19.93				20.03	36.974	24.00	-3.97	20.00
5700.0	21.00				21.10	39.279	24.00	-2.90	20.00

Traceability to Industry Recognized Test Methodologies

Work Instruction:	WI-03 MEASURING RF SPECTRUM MASK
Measurement Uncertainty:	±2.81 dB

This test report may be reproduced in full only. The document may only be updated by MiCOM Labs personnel. Any changes will be noted in the Document History section of the report.



Measurement Results for Maximum Conducted Output Power

Specification Limits

FCC, Part 15 §15.407 (a)(1), (a)(2) and Industry Canada RSS-210 § A9.2(2)

(a)(1) For the band 5.15-5.25 GHz the maximum conducted output power over the frequency band of operation shall not exceed the lesser of 50 mW or +4 dBm + 10 log B, where B is the 26 dB emission bandwidth in megahertz. In addition, the peak power spectral density shall not exceed +4 dBm in any 1 megahertz band.

(a)(2) For the 5.25-5.35 and 5470-5725 MHz GHz band the maximum conducted output power over the frequency band of operation shall not exceed the lesser of 250 mW or +11 dBm + 10 log B, where B is the 26 dB emission bandwidth in megahertz. In addition, the peak power spectral density shall not exceed +11 dBm in any 1 megahertz band.

Industry Canada RSS-210 §A9.2(2)

For the band 5150-5250 MHz, the maximum equivalent isotropically radiated power (e.i.r.p.) shall not exceed 200 mW or 10 + 10 log₁₀ B, dBm, whichever power is less. B is the 99% emission bandwidth in MHz. The e.i.r.p. spectral density shall not exceed 10 dBm in any 1.0 MHz band.

For the band 5250-5350 MHz and 5470-5725 MHz, the maximum conducted output power shall not exceed 250 mW or 11 + 10 log₁₀ B, dBm, whichever power is less. The power spectral density shall not exceed 11 dBm in any 1.0 MHz band. The maximum e.i.r.p. shall not exceed 1.0 W or 17 + 10 log₁₀ B, dBm, whichever power is less. B is the 99% emission bandwidth in MHz.

Traceability

Test Equipment Used

0158, 0287, 0252, 0313, 0314, 0070, 0116, 0117



Title: Spectralink 8753 Enhanced IP Telephone
To: FCC 47 CFR Part 15.407 & IC RSS-210
Serial #: SPEC27-U6 Rev A
Issue Date: 2nd January 2014
Page: 45 of 144

6.1.1.3. Peak Power Spectral Density

Conducted Test Conditions for Power Spectral Density			
Standard:	FCC CFR 47:15.407	Ambient Temp. (°C):	24.0 - 27.5
Test Heading:	Power Spectral Density	Rel. Humidity (%):	32 - 45
Standard Section(s):	15.247 (a)	Pressure (mBars):	999 - 1001
Reference Document(s):	KDB 789033 - D01 DTS General UNII Test Procedures v01		
Test Procedure for Power Spectral Density			
The In-Band power spectral density was measured using the measure and sum approach per FCC KDB 662911 (D01 Multiple Transmitter Output v01.)			
<u>Measure and sum the spectra across the outputs.</u> With this technique, spectra are measured at each output of the device at the required resolution bandwidth. The individual spectra are then summed mathematically in linear power units. Unlike in-band power measurements, in which the sum involves a single measured value (output power) from each output, measurements for compliance with PSD limits involve summing entire spectra across corresponding frequency bins on the various outputs. Consistency is maintained for any device with N transmitter outputs to be certain the individual outputs are all aligned with the same span and same number of points. In this instance, the linear power spectrum value within the first spectral bin of output 0 is summed with that in the first spectral bin of output 1, and the first spectral bin of output 2, and so on up to the Nth output to obtain the true value for the first frequency bin of the summed spectrum. The summed spectrum value for each frequency bin is computed in this fashion. These summed spectral values were calculated on a computer, and the results read back into the spectrum analyzer as a data file to produce a representative plot of total spectral power density.			
Calculated Power = $A + 10 \log (1/x)$ dBm			
A = Total Power Spectral Density [10 Log ₁₀ (10a/10 + 10 b/10 + 10c/10 + 10d/10)]			
x = Duty Cycle			

This test report may be reproduced in full only. The document may only be updated by MiCOM Labs personnel. Any changes will be noted in the Document History section of the report.



Title: Spectralink 8753 Enhanced IP Telephone
To: FCC 47 CFR Part 15.407 & IC RSS-210
Serial #: SPEC27-U6 Rev A
Issue Date: 2nd January 2014
Page: 46 of 144

Equipment Configuration for Peak Power Spectral Density

Variant:	802.11a	Duty Cycle (%):	99
Data Rate:	6 MBit/s	Antenna Gain (dBi):	4.00
Modulation:	OFDM	Beam Forming Gain (Y):	Not Applicable
TPC:	Not Applicable	Tested By:	CC
Engineering Test Notes:			

Test Measurement Results

Test Frequency	Measured Power Spectral Density				Calculated Power Spectral Density Σ Port(s)	Limit	Margin
	Port(s) (dBm/MHz)						
MHz	a	b	c	d	dBm/MHz	dBm/MHz	dB
5180.0	3.321				3.321	4.0	-0.7
5200.0	3.274				3.274	4.0	-0.7
5240.0	3.266				3.266	4.0	-0.7

Traceability to Industry Recognized Test Methodologies

Work Instruction:	WI-03 MEASURING RF SPECTRUM MASK
Measurement Uncertainty:	± 2.81 dB

This test report may be reproduced in full only. The document may only be updated by MiCOM Labs personnel. Any changes will be noted in the Document History section of the report.



Title: Spectralink 8753 Enhanced IP Telephone
To: FCC 47 CFR Part 15.407 & IC RSS-210
Serial #: SPEC27-U6 Rev A
Issue Date: 2nd January 2014
Page: 47 of 144

Equipment Configuration for Peak Power Spectral Density
--

Variant:	802.11n HT-20	Duty Cycle (%):	99
Data Rate:	6.5 MBit/s	Antenna Gain (dBi):	4.00
Modulation:	OFDM	Beam Forming Gain (Y):	Not Applicable
TPC:	Not Applicable	Tested By:	CC
Engineering Test Notes:			

Test Measurement Results

Test Frequency	Measured Power Spectral Density				Calculated Power Spectral Density Σ Port(s)	Limit	Margin
	Port(s) (dBm/MHz)						
MHz	a	b	c	d	dBm/MHz	dBm/MHz	dB
5180.0	3.591				3.591	4.0	-0.4
5200.0	3.787				3.787	4.0	-0.2
5240.0	3.747				3.747	4.0	-0.3

Traceability to Industry Recognized Test Methodologies

Work Instruction:	WI-03 MEASURING RF SPECTRUM MASK
Measurement Uncertainty:	± 2.81 dB

This test report may be reproduced in full only. The document may only be updated by MiCOM Labs personnel. Any changes will be noted in the Document History section of the report.



Title: Spectralink 8753 Enhanced IP Telephone
To: FCC 47 CFR Part 15.407 & IC RSS-210
Serial #: SPEC27-U6 Rev A
Issue Date: 2nd January 2014
Page: 48 of 144

Equipment Configuration for Peak Power Spectral Density
--

Variant:	802.11a	Duty Cycle (%):	99
Data Rate:	6 MBit/s	Antenna Gain (dBi):	4.00
Modulation:	OFDM	Beam Forming Gain (Y):	Not Applicable
TPC:	Not Applicable	Tested By:	CC
Engineering Test Notes:			

Test Measurement Results

Test Frequency	Measured Power Spectral Density				Calculated Power Spectral Density Σ Port(s)	Limit	Margin
	Port(s) (dBm/MHz)						
	MHz	a	b	c			
5260.0	10.760				10.760	11.0	-0.2
5300.0	10.675				10.675	11.0	-0.3
5320.0	10.695				10.695	11.0	-0.3

Traceability to Industry Recognized Test Methodologies

Work Instruction:	WI-03 MEASURING RF SPECTRUM MASK
Measurement Uncertainty:	± 2.81 dB

This test report may be reproduced in full only. The document may only be updated by MiCOM Labs personnel. Any changes will be noted in the Document History section of the report.



Title: Spectralink 8753 Enhanced IP Telephone
To: FCC 47 CFR Part 15.407 & IC RSS-210
Serial #: SPEC27-U6 Rev A
Issue Date: 2nd January 2014
Page: 49 of 144

Equipment Configuration for Peak Power Spectral Density
--

Variant:	802.11n HT-20	Duty Cycle (%):	99.0
Data Rate:	6.5 MBit/s	Antenna Gain (dBi):	4.00
Modulation:	OFDM	Beam Forming Gain (Y):	Not Applicable
TPC:	Not Applicable	Tested By:	CC
Engineering Test Notes:			

Test Measurement Results

Test Frequency	Measured Power Spectral Density				Calculated Power Spectral Density Σ Port(s) + Duty Cycle Offset	Limit	Margin
	Port(s) (dBm/MHz)						
MHz	a	b	c	d	dBm/MHz	dBm/MHz	dB
5260.0	10.376				10.376	11.0	-0.6
5300.0	10.310				10.310	11.0	-0.7
5320.0	10.324				10.324	11.0	-0.7

Traceability to Industry Recognized Test Methodologies

Work Instruction:	WI-03 MEASURING RF SPECTRUM MASK
Measurement Uncertainty:	± 2.81 dB

This test report may be reproduced in full only. The document may only be updated by MiCOM Labs personnel. Any changes will be noted in the Document History section of the report.



Title: Spectralink 8753 Enhanced IP Telephone
To: FCC 47 CFR Part 15.407 & IC RSS-210
Serial #: SPEC27-U6 Rev A
Issue Date: 2nd January 2014
Page: 50 of 144

Equipment Configuration for Peak Power Spectral Density
--

Variant:	802.11a	Duty Cycle (%):	99
Data Rate:	6 MBit/s	Antenna Gain (dBi):	4.00
Modulation:	OFDM	Beam Forming Gain (Y):	Not Applicable
TPC:	Not Applicable	Tested By:	CC
Engineering Test Notes:			

Test Measurement Results

Test Frequency	Measured Power Spectral Density				Calculated Power Spectral Density Σ Port(s)	Limit	Margin
	Port(s) (dBm/MHz)						
	MHz	a	b	c			
5500.0	10.124				10.124	11.0	-0.9
5580.0	10.392				10.392	11.0	-0.6
5700.0	10.550				10.550	11.0	-0.4

Traceability to Industry Recognized Test Methodologies

Work Instruction:	WI-03 MEASURING RF SPECTRUM MASK
Measurement Uncertainty:	± 2.81 dB

This test report may be reproduced in full only. The document may only be updated by MiCOM Labs personnel. Any changes will be noted in the Document History section of the report.



Title: Spectralink 8753 Enhanced IP Telephone
To: FCC 47 CFR Part 15.407 & IC RSS-210
Serial #: SPEC27-U6 Rev A
Issue Date: 2nd January 2014
Page: 51 of 144

Equipment Configuration for Peak Power Spectral Density

Variant:	802.11n HT-20	Duty Cycle (%):	99
Data Rate:	6.5 MBit/s	Antenna Gain (dBi):	4.00
Modulation:	OFDM	Beam Forming Gain (Y):	Not Applicable
TPC:	Not Applicable	Tested By:	CC
Engineering Test Notes:			

Test Measurement Results

Test Frequency	Measured Power Spectral Density				Calculated Power Spectral Density Σ Port(s)	Limit	Margin
	Port(s) (dBm/MHz)						
MHz	a	b	c	d	dBm/MHz	dBm/MHz	dB
5500.0	10.705				10.705	11.0	-0.3
5580.0	10.002				10.002	11.0	-1.0
5700.0	10.290				10.290	11.0	-0.7

Traceability to Industry Recognized Test Methodologies

Work Instruction:	WI-03 MEASURING RF SPECTRUM MASK
Measurement Uncertainty:	± 2.81 dB

This test report may be reproduced in full only. The document may only be updated by MiCOM Labs personnel. Any changes will be noted in the Document History section of the report.



Specification

FCC, Part 15 §15.407 (a)(1), (a)(2)

5150 – 5250 MHz

(a)(1) The peak power spectral density shall not exceed +4 dBm in any 1 megahertz band.

5250 – 5350 MHz & 5470 – 5725 MHz

(a)(2) The peak power spectral density shall not exceed +11 dBm in any 1 megahertz band.

Industry Canada RSS-210 § A9.2(1), A9.2(2)

5150 – 5250 MHz

§ **A9.2(1)** The eirp spectral density shall not exceed +10 dBm in any 1 MHz band

5250 – 5350 MHz & 5470 – 5725 MHz

§ **A9.2(2)** The power spectral density shall not exceed +11 dBm in any 1 MHz band

Traceability

Test Equipment Used

0158, 0287, 0252, 0313, 0314, 0070, 0116, 0117
--



Title: Spectralink 8753 Enhanced IP Telephone
To: FCC 47 CFR Part 15.407 & IC RSS-210
Serial #: SPEC27-U6 Rev A
Issue Date: 2nd January 2014
Page: 53 of 144

6.1.1.4. Peak Excursion Ratio

Conducted Test Conditions for Peak Excursion Ratio			
Standard:	FCC CFR 47:15.407	Ambient Temp. (°C):	24.0 - 27.5
Test Heading:	Peak Excursion Ratio	Rel. Humidity (%):	32 - 45
Standard Section(s):	15.407 (a)(6)	Pressure (mBars):	999 - 1001
Reference Document(s):	KDB 789033 - D01 DTS General UNII Test Procedures v01		

Test Procedure for Peak Excursion Ratio

Compliance with the peak excursion requirement is demonstrated by confirming the ratio of the maximum of the peak-hold spectrum to the maximum of the average spectrum during continuous transmission. Section F) of KDB 789033 was used in order to prove compliance. This is a conducted measurement using a spectrum analyzer using dual traces. Peak Excursion Ratio is the difference in amplitude (dB) between both traces; The following identifies two spectrum traces on the same plot. Trace 1 is the max hold Peak detector, and Trace 2 is the recalled trace data from Peak Power Spectral Density measurements. Each frequency and operational mode is recalled in order to prove compliance.

This test report may be reproduced in full only. The document may only be updated by MiCOM Labs personnel. Any changes will be noted in the Document History section of the report.



Title: Spectralink 8753 Enhanced IP Telephone
To: FCC 47 CFR Part 15.407 & IC RSS-210
Serial #: SPEC27-U6 Rev A
Issue Date: 2nd January 2014
Page: 54 of 144

Equipment Configuration for Peak Excursion Ratio

Variant:	802.11a	Duty Cycle (%):	99
Data Rate:	6 MBit/s	Antenna Gain (dBi):	Not Applicable
Modulation:	OFDM	Beam Forming Gain (Y):	Not Applicable
TPC:	Not Applicable	Tested By:	CC
Engineering Test Notes:			

Test Measurement Results

Test Frequency	Measured Peak Excursion (dB)				Ratio (dB)		Limit	Lowest Margin
	Port(s)				Highest	Lowest		
MHz	a	b	c	d				
5180.0	8.55				8.55	8.55	13.0	-4.45

Traceability to Industry Recognized Test Methodologies

Work Instruction:	WI-03 MEASURING RF SPECTRUM MASK
Measurement Uncertainty:	±2.81 dB

This test report may be reproduced in full only. The document may only be updated by MiCOM Labs personnel. Any changes will be noted in the Document History section of the report.



Title: Spectralink 8753 Enhanced IP Telephone
To: FCC 47 CFR Part 15.407 & IC RSS-210
Serial #: SPEC27-U6 Rev A
Issue Date: 2nd January 2014
Page: 55 of 144

Equipment Configuration for Peak Excursion Ratio

Variant:	802.11n HT-20	Duty Cycle (%):	99
Data Rate:	6.5 MBit/s	Antenna Gain (dBi):	Not Applicable
Modulation:	OFDM	Beam Forming Gain (Y):	Not Applicable
TPC:	Not Applicable	Tested By:	CC
Engineering Test Notes:			

Test Measurement Results

Test Frequency	Measured Peak Excursion (dB)				Ratio (dB)		Limit	Lowest Margin
	Port(s)				Highest	Lowest		
MHz	a	b	c	d			dB	MHz
5180.0	9.01				9.01	9.01	13.0	-3.99

Traceability to Industry Recognized Test Methodologies

Work Instruction:	WI-03 MEASURING RF SPECTRUM MASK
Measurement Uncertainty:	±2.81 dB

This test report may be reproduced in full only. The document may only be updated by MiCOM Labs personnel. Any changes will be noted in the Document History section of the report.



Title: Spectralink 8753 Enhanced IP Telephone
To: FCC 47 CFR Part 15.407 & IC RSS-210
Serial #: SPEC27-U6 Rev A
Issue Date: 2nd January 2014
Page: 56 of 144

Equipment Configuration for Peak Excursion Ratio

Variant:	802.11a	Duty Cycle (%):	99
Data Rate:	6 MBit/s	Antenna Gain (dBi):	Not Applicable
Modulation:	OFDM	Beam Forming Gain (Y):	Not Applicable
TPC:	Not Applicable	Tested By:	CC
Engineering Test Notes:			

Test Measurement Results

Test Frequency	Measured Peak Excursion (dB)				Ratio (dB)		Limit	Lowest Margin
	Port(s)				Highest	Lowest		
MHz	a	b	c	d				
5260.0	9.14				9.14	9.14	13.0	-3.86

Traceability to Industry Recognized Test Methodologies

Work Instruction:	WI-03 MEASURING RF SPECTRUM MASK
Measurement Uncertainty:	±2.81 dB

This test report may be reproduced in full only. The document may only be updated by MiCOM Labs personnel. Any changes will be noted in the Document History section of the report.



Title: Spectralink 8753 Enhanced IP Telephone
To: FCC 47 CFR Part 15.407 & IC RSS-210
Serial #: SPEC27-U6 Rev A
Issue Date: 2nd January 2014
Page: 57 of 144

Equipment Configuration for Peak Excursion Ratio

Variant:	802.11n HT-20	Duty Cycle (%):	99
Data Rate:	6.5 MBit/s	Antenna Gain (dBi):	Not Applicable
Modulation:	OFDM	Beam Forming Gain (Y):	Not Applicable
TPC:	Not Applicable	Tested By:	CC
Engineering Test Notes:			

Test Measurement Results

Test Frequency	Measured Peak Excursion (dB)				Ratio (dB)		Limit	Lowest Margin
	Port(s)				Highest	Lowest		
MHz	a	b	c	d	Highest	Lowest	dB	MHz
5260.0	9.34				9.34	9.34	13.0	-3.66

Traceability to Industry Recognized Test Methodologies

Work Instruction:	WI-03 MEASURING RF SPECTRUM MASK
Measurement Uncertainty:	±2.81 dB

This test report may be reproduced in full only. The document may only be updated by MiCOM Labs personnel. Any changes will be noted in the Document History section of the report.



Title: Spectralink 8753 Enhanced IP Telephone
To: FCC 47 CFR Part 15.407 & IC RSS-210
Serial #: SPEC27-U6 Rev A
Issue Date: 2nd January 2014
Page: 58 of 144

Equipment Configuration for Peak Excursion Ratio

Variant:	802.11a	Duty Cycle (%):	99
Data Rate:	6 MBit/s	Antenna Gain (dBi):	Not Applicable
Modulation:	OFDM	Beam Forming Gain (Y):	Not Applicable
TPC:	Not Applicable	Tested By:	CC
Engineering Test Notes:			

Test Measurement Results

Test Frequency	Measured Peak Excursion (dB)				Ratio (dB)		Limit	Lowest Margin
	Port(s)				Highest	Lowest		
MHz	a	b	c	d				
5500.0	<u>8.71</u>				8.71	8.71	13.0	-4.29

Traceability to Industry Recognized Test Methodologies

Work Instruction:	WI-03 MEASURING RF SPECTRUM MASK
Measurement Uncertainty:	±2.81 dB

This test report may be reproduced in full only. The document may only be updated by MiCOM Labs personnel. Any changes will be noted in the Document History section of the report.



Title: Spectralink 8753 Enhanced IP Telephone
To: FCC 47 CFR Part 15.407 & IC RSS-210
Serial #: SPEC27-U6 Rev A
Issue Date: 2nd January 2014
Page: 59 of 144

Equipment Configuration for Peak Excursion Ratio

Variant:	802.11n HT-20	Duty Cycle (%):	99
Data Rate:	6.5 MBit/s	Antenna Gain (dBi):	Not Applicable
Modulation:	OFDM	Beam Forming Gain (Y):	Not Applicable
TPC:	Not Applicable	Tested By:	CC
Engineering Test Notes:			

Test Measurement Results

Test Frequency	Measured Peak Excursion (dB)				Ratio (dB)		Limit	Lowest Margin
	Port(s)				Highest	Lowest		
MHz	a	b	c	d			dB	MHz
5500.0	9.10				9.10	9.10	13.0	-3.90

Traceability to Industry Recognized Test Methodologies

Work Instruction:	WI-03 MEASURING RF SPECTRUM MASK
Measurement Uncertainty:	±2.81 dB

This test report may be reproduced in full only. The document may only be updated by MiCOM Labs personnel. Any changes will be noted in the Document History section of the report.



Title: Spectralink 8753 Enhanced IP Telephone
To: FCC 47 CFR Part 15.407 & IC RSS-210
Serial #: SPEC27-U6 Rev A
Issue Date: 2nd January 2014
Page: 60 of 144

Specification

Limits

§15.407 (a)(6) The ratio of the peak excursion of the modulation envelope (measured using a peak hold function) to the peak transmit power (measured as specified in this paragraph) shall not exceed 13dB across any 1MHz bandwidth or the emission bandwidth whichever is less

Traceability

Test Equipment Used

0158, 0287, 0252, 0313, 0314, 0070, 0116, 0117
--

This test report may be reproduced in full only. The document may only be updated by MiCOM Labs personnel. Any changes will be noted in the Document History section of the report.



6.1.1.5. Frequency Stability

FCC, Part 15 Subpart C §15.407(g)
Industry Canada RSS-210 §2.1

Test Procedure

The manufacturer of the equipment is responsible for ensuring that the frequency stability is such that emissions are always maintained within the band of operation under all conditions.

Manufacturer Declaration

The frequency stability of the reference oscillator sets the frequency stability of the RF transceiver signals. Therefore all of the RF signals should have ± 20 ppm stability.

This stability accounts for room temp tolerance of the crystal oscillator circuit, frequency variation across temperature, and crystal ageing.

± 20 ppm at 5.250 GHz translates to a maximum frequency shift of ± 105 KHz. As the edge of the channels is at least one MHz from either of the band edges, ± 105 KHz is more than sufficient to guarantee that the intentional emission will remain in the band over the entire operating range of the EUT.

Specification

Limits

§15.407 (g) Manufacturers of U-NII devices are responsible for ensuring frequency stability such that an emission is maintained within the band of operation under all conditions of normal operation as specified in the user's manual.



Title: Spectralink 8753 Enhanced IP Telephone
To: FCC 47 CFR Part 15.407 & IC RSS-210
Serial #: SPEC27-U6 Rev A
Issue Date: 2nd January 2014
Page: 62 of 144

6.1.2. Radiated Emission Testing

FCC, Part 15 Subpart C §15.407(b)(2), §15.205(a)/15.209(a)
Industry Canada RSS-210 §A9.3(2); §2.2; §2.6; RSS-Gen §4.7

Test Procedure

Testing was performed in a 3-meter anechoic chamber. Preliminary radiated emissions were measured on every azimuth and with the receiving antenna in both horizontal and vertical polarizations. Preliminary emissions were recorded with in Spectrum Analyzer mode, using a maximum peak detector while in peak hold mode. Depending on the frequency band spanned a notch filter and/or waveguide filter was used to remove the fundamental frequency.

Emissions nearest the limits were chosen for maximization and formal measurement using a CISPR compliant receiver. Emissions above 1000 MHz are measured utilizing a CISPR compliant average detector with a tuned receiver, using a bandwidth of 1 MHz. Emissions from 30 MHz – 1000 MHz are measured utilizing a CISPR compliant quasi-peak detector with a tuned receiver, using a bandwidth of 120 kHz. Only the highest emissions relative to the limit are listed.

Radiated Emissions Test Strategy

802.11a mode was exercised for spurious emissions as it provides the highest spectral power density and represents the worst case for emissions.

Radiated band-edge emissions testing was performed for all operational modes.

This test report may be reproduced in full only. The document may only be updated by MiCOM Labs personnel. Any changes will be noted in the Document History section of the report.



Field Strength Calculation

The field strength is calculated by adding the Antenna Factor and Cable Loss, and subtracting Amplifier Gain from the measured reading. All factors are included in the reported data.

$$FS = R + AF + CORR - FO$$

FS = Field Strength
R = Measured Spectrum analyzer Input Amplitude
AF = Antenna Factor

$$CORR = \text{Correction Factor} = CL - AG + NFL$$

CL = Cable Loss
AG = Amplifier Gain
FO = Distance Falloff Factor
NFL = Notch Filter Loss or Waveguide Loss

Field Strength Calculation Example:

Given receiver input reading of 51.5 dB μ V; Antenna Factor of 8.5 dB; Cable Loss of 1.3 dB; Falloff Factor of 0 dB, an Amplifier Gain of 26 dB and Notch Filter Loss of 1 dB. The Field Strength of the measured emission is:

$$FS = 51.5 + 8.5 + 1.3 - 26.0 + 1 = 36.3 \text{ dB}\mu\text{V/m}$$

Conversion between dB μ V/m (or dB μ V) and μ V/m (or μ V) are done as:

$$\text{Level (dB}\mu\text{V/m)} = 20 * \text{Log (level (\mu\text{V/m}))}$$

$$40 \text{ dB}\mu\text{V/m} = 100 \mu\text{V/m}$$

$$48 \text{ dB}\mu\text{V/m} = 250 \mu\text{V/m}$$

The following formula is used to convert the equipment isotropic radiated power (eirp) to field strength (dB μ V/m);

$$E = 1000000 \times \sqrt{30P} / 3 \mu\text{V/m}$$

where P is the EIRP in Watts

$$\text{Therefore: } -27 \text{ dBm/MHz} = 68.23 \text{ dB}\mu\text{V/m}$$

Note: The data in this Section identifies that the EUT is in compliance with the -27dBm/MHz EIRP limit (68.23 dB μ V/m) for out of band emissions. All out of band emissions are less than 68.23 dB μ V/m.

This test report may be reproduced in full only. The document may only be updated by MiCOM Labs personnel. Any changes will be noted in the Document History section of the report.



Title: Spectralink 8753 Enhanced IP Telephone
To: FCC 47 CFR Part 15.407 & IC RSS-210
Serial #: SPEC27-U6 Rev A
Issue Date: 2nd January 2014
Page: 64 of 144

Specification

Radiated Spurious Emissions

15.407 (b)(2). All emissions outside of the 5,150-5,350MHz band shall not exceed an EIRP of -27dBm/MHz.

FCC §15.205 (a) Except as shown in paragraph (d) of 15.205 (a), only spurious emissions are permitted in any of the frequency bands listed.

FCC §15.205 (a) Except as shown in paragraphs (d) and (e) of this section, the field strength of emissions appearing within these frequency bands shall not exceed the limits shown in Section §15.209. At frequencies equal to or less than 1000 MHz, compliance with the limits in Section 15.209 shall be demonstrated using measurement instrumentation employing a CISPR quasi-peak detector. Above 1000 MHz, compliance with the emission limits in Section 15.209 shall be demonstrated based on the average value of the measured emissions. The provisions in Section 15.35 apply to these measurements.

FCC §15.209 (a) Except as provided elsewhere in this subpart, the emissions from an intentional radiator shall not exceed the field strength levels specified in the following table.

RSS-210 §A9.3(2) For transmitters operating in the 5250-5350 MHz band, all emissions outside the 5150-5350 MHz band shall not exceed -27 dBm/MHz e.i.r.p. Devices operating in the 5250-5350 MHz band that generate emissions in the 5150-5250 MHz band shall not exceed out of band emission limit of 27 dBm/MHz e.i.r.p. in the 5150-5250 MHz band in order to operate indoor/outdoor, or alternatively shall comply with the spectral power density for operation within the 5150-5250 MHz band and shall be labeled "for indoor use only".

RSS-Gen §4.7 The search for unwanted emissions shall be from the lowest frequency internally generated or used in the device (local oscillator, intermediate of carrier frequency), or from 30 MHz, whichever is the lowest frequency, to the 5th harmonic of the highest frequency generated without exceeding 40 GHz.

RSS-Gen §6 Receiver Spurious Emission Standard

If a radiated measurement is made, all spurious emissions shall comply with the limits of the following Table. The resolution bandwidth of the spectrum analyzer shall be 100 kHz for spurious emission measurements below 1.0 GHz and 1.0 MHz for measurements above 1.0 GHz

This test report may be reproduced in full only. The document may only be updated by MiCOM Labs personnel. Any changes will be noted in the Document History section of the report.



Title: Spectralink 8753 Enhanced IP Telephone
To: FCC 47 CFR Part 15.407 & IC RSS-210
Serial #: SPEC27-U6 Rev A
Issue Date: 2nd January 2014
Page: 65 of 144

Table 1: FCC 15.209 Spurious Emissions Limits

Frequency (MHz)	Field Strength ($\mu\text{V/m}$)	Field Strength ($\text{dB}\mu\text{V/m}$)	Measurement Distance (meters)
30-88	100	40.0	3
88-216	150	43.5	3
216-960	200	46.0	3
Above 960	500	54.0	3

Traceability:

Test Equipment Used
0088, 0158, 0134, 0304, 0311, 0315, 0310, 0312

This test report may be reproduced in full only. The document may only be updated by MiCOM Labs personnel. Any changes will be noted in the Document History section of the report.



6.1.2.1. Integral Antenna – Spurious Emissions

Test Freq.	5180 MHz	Engineer	SB
Variant	802.11a; 6 Mbit/s	Temp (°C)	22
Freq. Range	1000 MHz - 18000 MHz	Rel. Hum.(%)	44
Power Setting	Max	Press. (mBars)	1005
Antenna	Integral	Duty Cycle (%)	100
Test Notes 1			

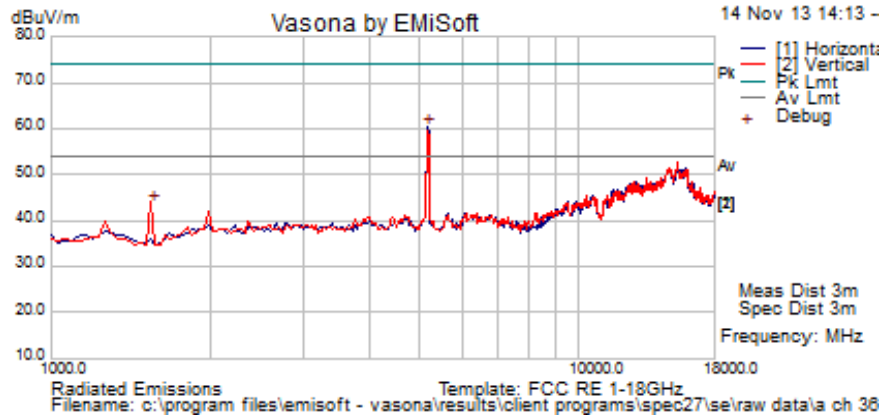

Formally measured emission peaks

Frequency MHz	Raw dBuV	Cable Loss	AF dB	Level dBuV/m	Measurement Type	Pol	Hgt cm	Azt Deg	Limit dBuV/m	Margin dB	Pass /Fail	Comments
5156.313	65.6	4.6	-9.9	60.3	Peak [Scan]	H						FUND
1546.994	56.1	2.4	-15.1	43.4	Peak [Scan]	V	98	361	54	-10.6	Pass	RB

Legend: TX = Transmitter Emissions; DIG = Digital Emissions; FUND = Fundamental; WB = Wideband Emission
 NRB = Non-Restricted Band. Limit = 68.23 dBuV/m; RB = Restricted Band. Limits per 15.205

This test report may be reproduced in full only. The document may only be updated by MiCOM Labs personnel. Any changes will be noted in the Document History section of the report.



Title: Spectralink 8753 Enhanced IP Telephone
To: FCC 47 CFR Part 15.407 & IC RSS-210
Serial #: SPEC27-U6 Rev A
Issue Date: 2nd January 2014
Page: 67 of 144

Test Freq.	5200 MHz	Engineer	SB
Variant	802.11a; 6 Mbit/s	Temp (°C)	22
Freq. Range	1000 MHz - 18000 MHz	Rel. Hum.(%)	44
Power Setting	Max	Press. (mBars)	1005
Antenna	Integral	Duty Cycle (%)	100
Test Notes 1			

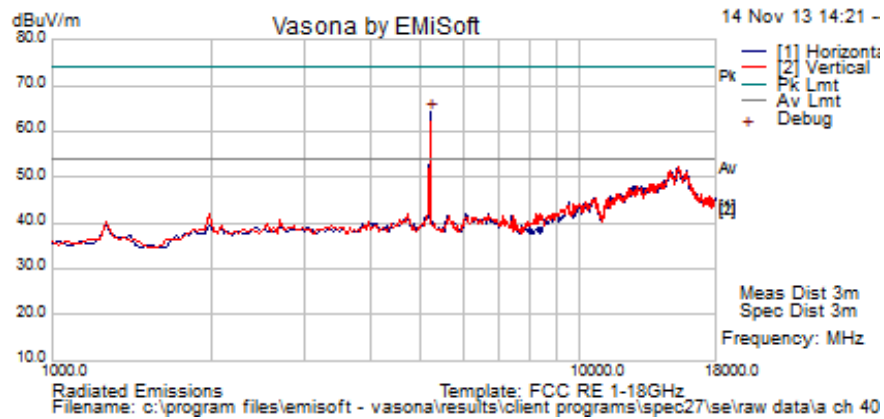

Formally measured emission peaks

Frequency MHz	Raw dBuV	Cable Loss	AF dB	Level dBuV/m	Measurement Type	Pol	Hgt cm	Azt Deg	Limit dBuV/m	Margin dB	Pass /Fail	Comments
5190.381	69.4	4.6	-9.9	64.1	Peak [Scan]	H						FUND
Legend: TX = Transmitter Emissions; DIG = Digital Emissions; FUND = Fundamental; WB = Wideband Emission NRB = Non-Restricted Band. Limit = 68.23 dBuV/m; RB = Restricted Band. Limits per 15.205												

This test report may be reproduced in full only. The document may only be updated by MiCOM Labs personnel. Any changes will be noted in the Document History section of the report.



Title: Spectralink 8753 Enhanced IP Telephone
To: FCC 47 CFR Part 15.407 & IC RSS-210
Serial #: SPEC27-U6 Rev A
Issue Date: 2nd January 2014
Page: 68 of 144

Test Freq.	5240 MHz	Engineer	SB
Variant	802.11a; 6 Mbit/s	Temp (°C)	22
Freq. Range	1000 MHz - 18000 MHz	Rel. Hum.(%)	44
Power Setting	Max	Press. (mBars)	1005
Antenna	Integral	Duty Cycle (%)	100
Test Notes 1			

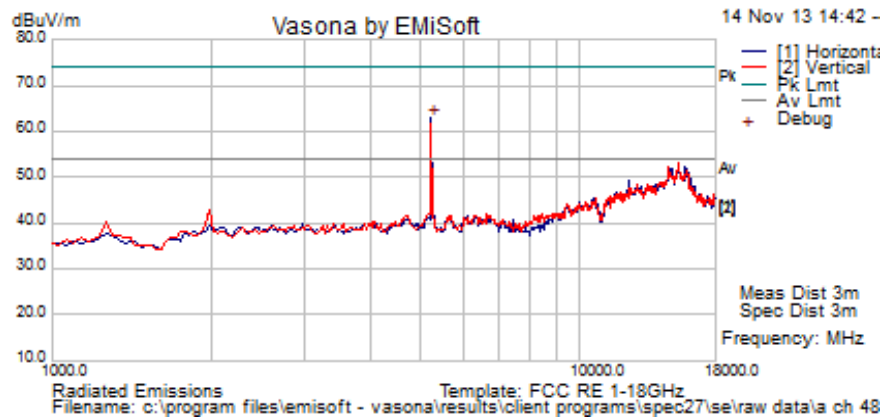

Formally measured emission peaks

Frequency MHz	Raw dBuV	Cable Loss	AF dB	Level dBuV/m	Measurement Type	Pol	Hgt cm	Azt Deg	Limit dBuV/m	Margin dB	Pass /Fail	Comments
5224.228	66.8	4.6	-9.8	61.6	Peak [Scan]	V						FUND
Legend: TX = Transmitter Emissions; DIG = Digital Emissions; FUND = Fundamental; WB = Wideband Emission NRB = Non-Restricted Band. Limit = 68.23 dBuV/m; RB = Restricted Band. Limits per 15.205												

This test report may be reproduced in full only. The document may only be updated by MiCOM Labs personnel. Any changes will be noted in the Document History section of the report.



Title: Spectralink 8753 Enhanced IP Telephone
To: FCC 47 CFR Part 15.407 & IC RSS-210
Serial #: SPEC27-U6 Rev A
Issue Date: 2nd January 2014
Page: 69 of 144

Test Freq.	5260 MHz	Engineer	SB
Variant	802.11a; 6 Mbit/s	Temp (°C)	22
Freq. Range	1000 MHz - 18000 MHz	Rel. Hum.(%)	44
Power Setting	Max	Press. (mBars)	1005
Antenna	Integral	Duty Cycle (%)	100
Test Notes 1			

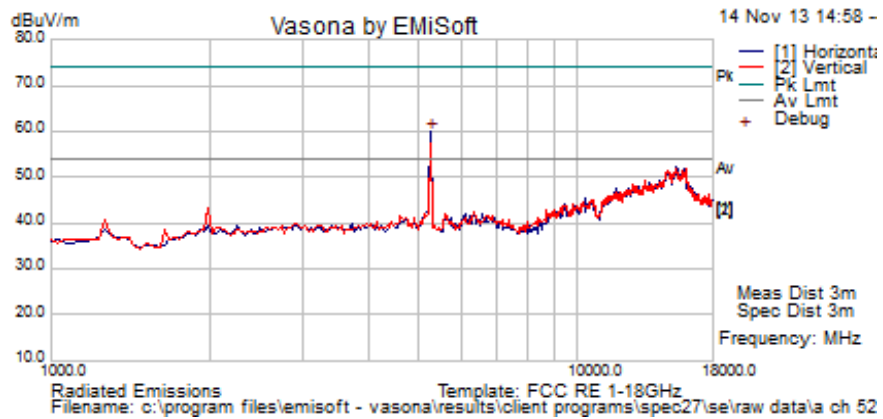

Formally measured emission peaks

Frequency MHz	Raw dBuV	Cable Loss	AF dB	Level dBuV/m	Measurement Type	PoI	Hgt cm	Azt Deg	Limit dBuV/m	Margin dB	Pass /Fail	Comments
5258.517	65.1	4.6	-9.7	59.9	Peak [Scan]	H						FUND
Legend: TX = Transmitter Emissions; DIG = Digital Emissions; FUND = Fundamental; WB = Wideband Emission NRB = Non-Restricted Band. Limit = 68.23 dBuV/m; RB = Restricted Band. Limits per 15.205												

This test report may be reproduced in full only. The document may only be updated by MiCOM Labs personnel. Any changes will be noted in the Document History section of the report.



Title: Spectralink 8753 Enhanced IP Telephone
To: FCC 47 CFR Part 15.407 & IC RSS-210
Serial #: SPEC27-U6 Rev A
Issue Date: 2nd January 2014
Page: 70 of 144

Test Freq.	5300 MHz	Engineer	SB
Variant	802.11a; 6 Mbit/s	Temp (°C)	22
Freq. Range	1000 MHz - 18000 MHz	Rel. Hum.(%)	44
Power Setting	Max	Press. (mBars)	1005
Antenna	Integral	Duty Cycle (%)	100
Test Notes 1			

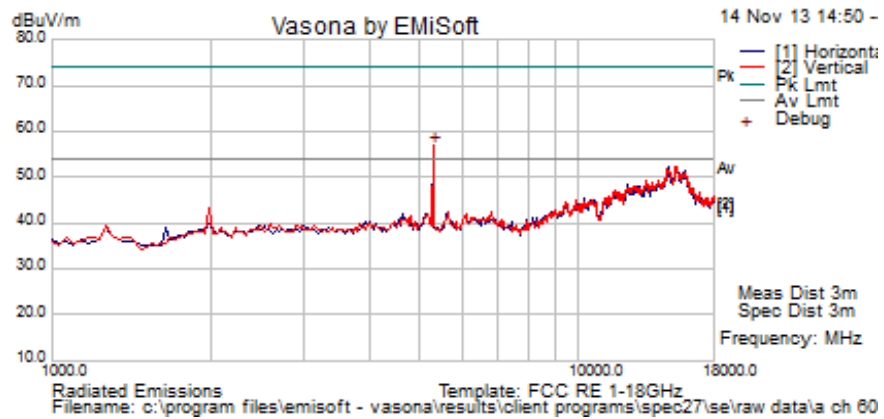

Formally measured emission peaks

Frequency MHz	Raw dBuV	Cable Loss	AF dB	Level dBuV/m	Measurement Type	PoI	Hgt cm	Azt Deg	Limit dBuV/m	Margin dB	Pass /Fail	Comments
5292.585	62.0	4.6	-9.6	57.0	Peak [Scan]	H						FUND

Legend: TX = Transmitter Emissions; DIG = Digital Emissions; FUND = Fundamental; WB = Wideband Emission
 NRB = Non-Restricted Band. Limit = 68.23 dBuV/m; RB = Restricted Band. Limits per 15.205

This test report may be reproduced in full only. The document may only be updated by MiCOM Labs personnel. Any changes will be noted in the Document History section of the report.



Title: Spectralink 8753 Enhanced IP Telephone
To: FCC 47 CFR Part 15.407 & IC RSS-210
Serial #: SPEC27-U6 Rev A
Issue Date: 2nd January 2014
Page: 71 of 144

Test Freq.	5320 MHz	Engineer	SB
Variant	802.11a; 6 Mbit/s	Temp (°C)	22
Freq. Range	1000 MHz - 18000 MHz	Rel. Hum.(%)	44
Power Setting	Max	Press. (mBars)	1005
Antenna	Integral	Duty Cycle (%)	100
Test Notes 1			

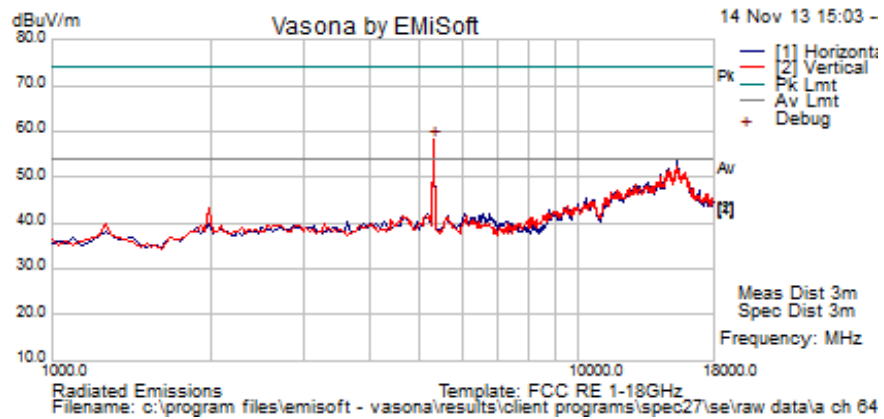

Formally measured emission peaks

Frequency MHz	Raw dBuV	Cable Loss	AF dB	Level dBuV/m	Measurement Type	PoI	Hgt cm	Azt Deg	Limit dBuV/m	Margin dB	Pass /Fail	Comments
5320.024	61.9	4.6	-9.5	57.0	Peak [Scan]	V						FUND
Legend: TX = Transmitter Emissions; DIG = Digital Emissions; FUND = Fundamental; WB = Wideband Emission NRB = Non-Restricted Band. Limit = 68.23 dBuV/m; RB = Restricted Band. Limits per 15.205												

This test report may be reproduced in full only. The document may only be updated by MiCOM Labs personnel. Any changes will be noted in the Document History section of the report.



Title: Spectralink 8753 Enhanced IP Telephone
To: FCC 47 CFR Part 15.407 & IC RSS-210
Serial #: SPEC27-U6 Rev A
Issue Date: 2nd January 2014
Page: 72 of 144

Test Freq.	5500 MHz	Engineer	SB
Variant	802.11a; 6 Mbit/s	Temp (°C)	22
Freq. Range	1000 MHz - 18000 MHz	Rel. Hum.(%)	44
Power Setting	Max	Press. (mBars)	1005
Antenna	Integral	Duty Cycle (%)	100
Test Notes 1			

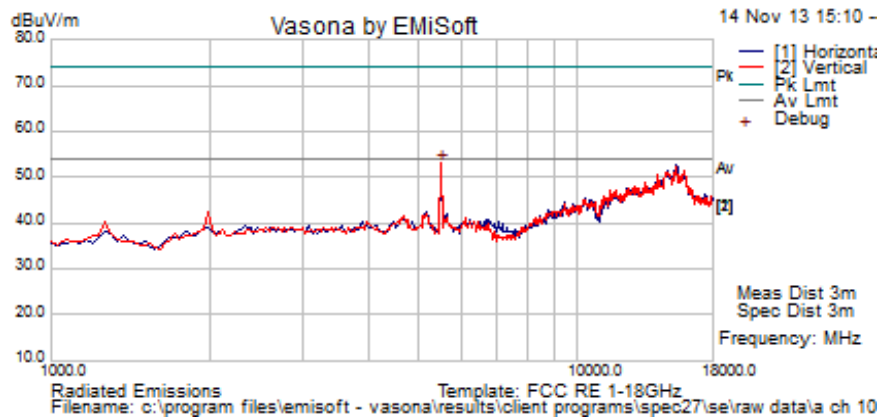

Formally measured emission peaks

Frequency MHz	Raw dBuV	Cable Loss	AF dB	Level dBuV/m	Measurement Type	Pol	Hgt cm	Azt Deg	Limit dBuV/m	Margin dB	Pass /Fail	Comments
5496.994	58.1	4.6	-9.6	53.1	Peak [Scan]	V						FUND
Legend: TX = Transmitter Emissions; DIG = Digital Emissions; FUND = Fundamental; WB = Wideband Emission NRB = Non-Restricted Band. Limit = 68.23 dBuV/m; RB = Restricted Band. Limits per 15.205												

This test report may be reproduced in full only. The document may only be updated by MiCOM Labs personnel. Any changes will be noted in the Document History section of the report.



Title: Spectralink 8753 Enhanced IP Telephone
To: FCC 47 CFR Part 15.407 & IC RSS-210
Serial #: SPEC27-U6 Rev A
Issue Date: 2nd January 2014
Page: 73 of 144

Test Freq.	5580 MHz	Engineer	SB
Variant	802.11a; 6 Mbit/s	Temp (°C)	22
Freq. Range	1000 MHz - 18000 MHz	Rel. Hum.(%)	44
Power Setting	Max	Press. (mBars)	1005
Antenna	Integral	Duty Cycle (%)	100
Test Notes 1			

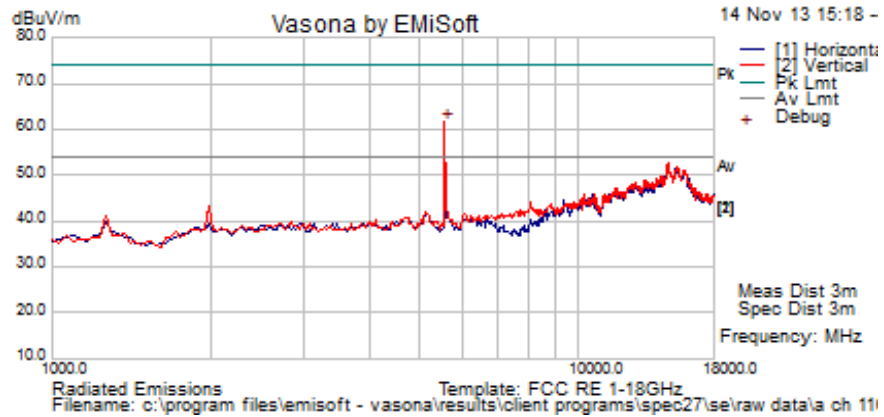

Formally measured emission peaks

Frequency MHz	Raw dBuV	Cable Loss	AF dB	Level dBuV/m	Measurement Type	Pol	Hgt cm	Azt Deg	Limit dBuV/m	Margin dB	Pass /Fail	Comments
5565.130	66.8	4.7	-9.7	61.7	Peak [Scan]	V						FUND
Legend: TX = Transmitter Emissions; DIG = Digital Emissions; FUND = Fundamental; WB = Wideband Emission NRB = Non-Restricted Band. Limit = 68.23 dBuV/m; RB = Restricted Band. Limits per 15.205												

This test report may be reproduced in full only. The document may only be updated by MiCOM Labs personnel. Any changes will be noted in the Document History section of the report.



Title: Spectralink 8753 Enhanced IP Telephone
To: FCC 47 CFR Part 15.407 & IC RSS-210
Serial #: SPEC27-U6 Rev A
Issue Date: 2nd January 2014
Page: 74 of 144

Test Freq.	5700 MHz	Engineer	SB
Variant	802.11a; 6 Mbit/s	Temp (°C)	22
Freq. Range	1000 MHz - 18000 MHz	Rel. Hum.(%)	44
Power Setting	Max	Press. (mBars)	1005
Antenna	Integral	Duty Cycle (%)	100
Test Notes 1			

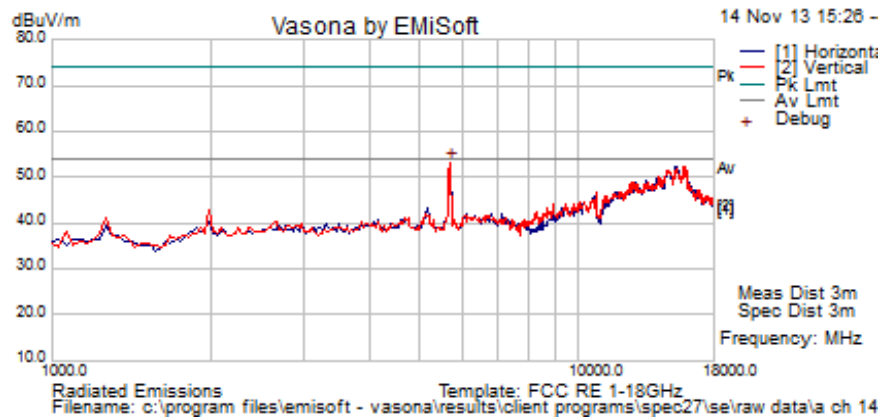

Formally measured emission peaks

Frequency MHz	Raw dBuV	Cable Loss	AF dB	Level dBuV/m	Measurement Type	Pol	Hgt cm	Azt Deg	Limit dBuV/m	Margin dB	Pass /Fail	Comments
5701.403	58.1	4.7	-9.6	53.3	Peak [Scan]	V						FUND
Legend: TX = Transmitter Emissions; DIG = Digital Emissions; FUND = Fundamental; WB = Wideband Emission NRB = Non-Restricted Band. Limit = 68.23 dBuV/m; RB = Restricted Band. Limits per 15.205												

This test report may be reproduced in full only. The document may only be updated by MiCOM Labs personnel. Any changes will be noted in the Document History section of the report.



6.1.2.2. Integral Antenna - Radiated Band-Edge

Peak Limit 74.0 dB μ V, Peak Limit 54.0 dB μ V

5150 MHz			
Operational Mode	dB μ V		Power Setting
	Peak	Average	
a	46.47	34.43	11
n HT-20	46.30	34.20	12

5350 MHz			
Operational Mode	dB μ V		Power Setting
	Peak	Average	
a	68.10	47.58	20
n HT-20	68.65	48.24	20

5460 MHz			
Operational Mode	Peak	Average	Power Setting
a	57.59	39.13	19
n HT-20	61.14	42.12	20

This test report may be reproduced in full only. The document may only be updated by MiCOM Labs personnel. Any changes will be noted in the Document History section of the report.



6.1.2.3. Digital Emissions (30M-1 GHz)

FCC, Part 15 Subpart C §15.205/ §15.209
Industry Canada RSS-210 §2.2

Test Procedure

Testing 30M-1 GHz was performed in a 3-meter anechoic chamber using a CISPR compliant receiver. Preliminary radiated emissions were measured on every azimuth and with the receiving antenna in both horizontal and vertical polarizations. To further maximize emissions the receive antenna was varied between 1 and 4 meters. The emissions are recorded with receiver in peak hold mode. Emissions closest to the limits are measured in the quasi-peak mode with the tuned receiver using a bandwidth of 120 kHz. Only the highest emissions relative to the limit are listed. The anechoic chamber test set-up is identified in Section 6 Test Set-Up Photographs.

The EUT had two methods of powering on ac/dc converter and Power over Ethernet (POE). Both modes were tested for emissions below 1GHz.

Field Strength Calculation

The field strength is calculated by adding the Antenna Factor and Cable Loss, and subtracting Amplifier Gain from the measured reading. In this test facility, the Antenna Factor, Cable Loss, and Amplifier Gains are loaded into the Rohde & Schwarz Receiver and the corrected field strength can be read directly on the receiver.

$$FS = R + AF + CORR$$

where:

FS = Field Strength
R = Measured Receiver Input Amplitude
AF = Antenna Factor
CORR = Correction Factor = CL – AG + NFL
CL = Cable Loss
AG = Amplifier Gain

For example:

Given a Receiver input reading of 51.5dB μ V; Antenna Factor of 8.5dB; Cable Loss of 1.3dB; Falloff Factor of 0dB, an Amplifier Gain of 26dB and Notch Filter Loss of 1dB. The Field Strength of the measured emission is:

$$FS = 51.5 + 8.5 + 1.3 - 26.0 + 1 = 36.3\text{dB}\mu\text{V/m}$$

Conversion between dB μ V/m (or dB μ V) and μ V/m (or μ V) are done as:

$$\text{Level (dB}\mu\text{V/m)} = 20 * \text{Log (level (\mu\text{V/m}))}$$

$$40 \text{ dB}\mu\text{V/m} = 100\mu\text{V/m}$$

$$48 \text{ dB}\mu\text{V/m} = 250\mu\text{V/m}$$

This test report may be reproduced in full only. The document may only be updated by MiCOM Labs personnel. Any changes will be noted in the Document History section of the report.



Title: Spectralink 8753 Enhanced IP Telephone
To: FCC 47 CFR Part 15.407 & IC RSS-210
Serial #: SPEC27-U6 Rev A
Issue Date: 2nd January 2014
Page: 77 of 144

Radiated Emissions < 1GHz: JE AC Adapter 1.0A

Test Freq.	Not Applicable	Engineer	JMH
Variant	Not Applicable	Temp (°C)	18.5
Freq. Range	30 MHz - 1 GHz	Rel. Hum.(%)	41
Power Setting	Maximum	Press. (mBars)	1010
Antenna	Integral		
Test Notes 1	GCI AC Adapter 1A		
Test Notes 2			

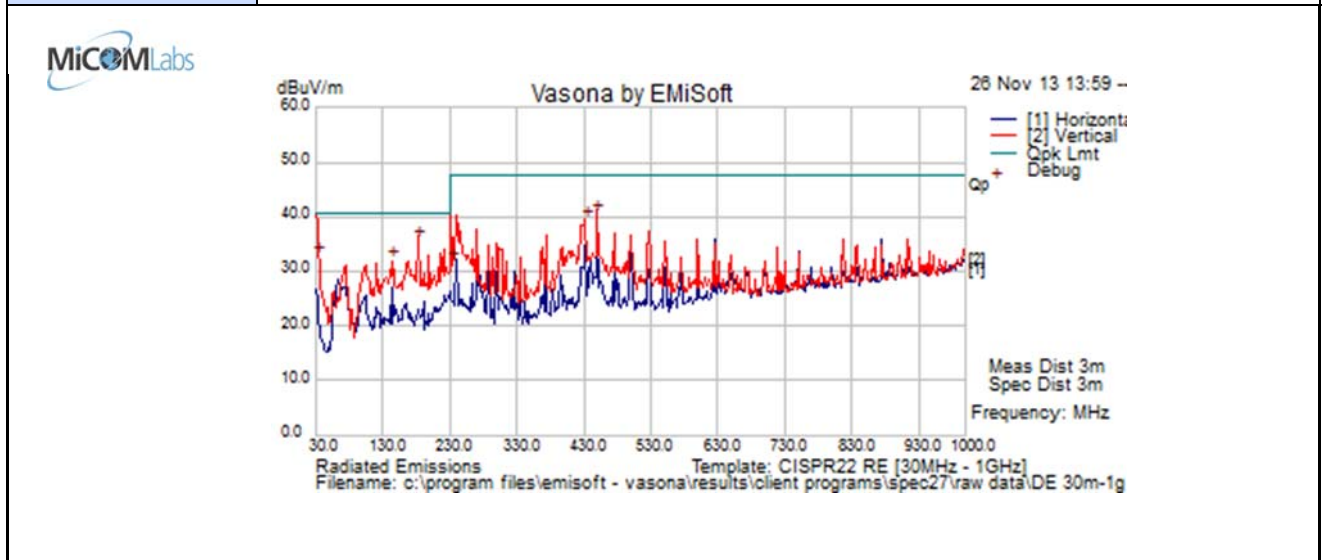

Formally measured emission peaks

Frequency MHz	Raw dBuV	Cable Loss	AF dB	Level dBuV/m	Measurement Type	Pol	Hgt cm	Azt Deg	Limit dBuV/m	Margin dB	Pass /Fail	Comments
31.203	39.6	3.5	-10.4	32.650	Quasi Max	V	149	333	40.5	-7.9	Pass	
142.843	45.7	4.3	-18.2	31.9	Peak [Scan]	V	98	-1	40.5	-8.6	Pass	
183.191	50.8	4.6	-19.6	35.8	Quasi Max	V	100	285	40.5	-4.7	Pass	
232.720	46.0	4.8	-19.0	31.8	Quasi Max	V	110	313	47.5	-15.8	Pass	
431.888	47.8	5.6	-14.0	39.4	Peak [Scan]	V	98	-1	47.5	-8.1	Pass	
449.681	48.5	5.7	-13.8	40.4	Peak [Scan]	V	98	-1	47.5	-7.1	Pass	

Legend:	DIG = Digital Device Emission; TX = Transmitter Emission; FUND = Fundamental Frequency
	NRB = Non-Restricted Band, Limit is 20 dB below Fundamental; RB = Restricted Band

This test report may be reproduced in full only. The document may only be updated by MiCOM Labs personnel. Any changes will be noted in the Document History section of the report.



Title: Spectralink 8753 Enhanced IP Telephone
To: FCC 47 CFR Part 15.407 & IC RSS-210
Serial #: SPEC27-U6 Rev A
Issue Date: 2nd January 2014
Page: 78 of 144

Radiated Emissions < 1GHz: JE AC Adapter 1.5A

Test Freq.	Not Applicable	Engineer	JMH
Variant	Not Applicable	Temp (°C)	18.5
Freq. Range	30 MHz - 1 GHz	Rel. Hum.(%)	41
Power Setting	Maximum	Press. (mBars)	1010
Antenna	Integral		
Test Notes 1	JE AC Adapter 1.5A		
Test Notes 2			

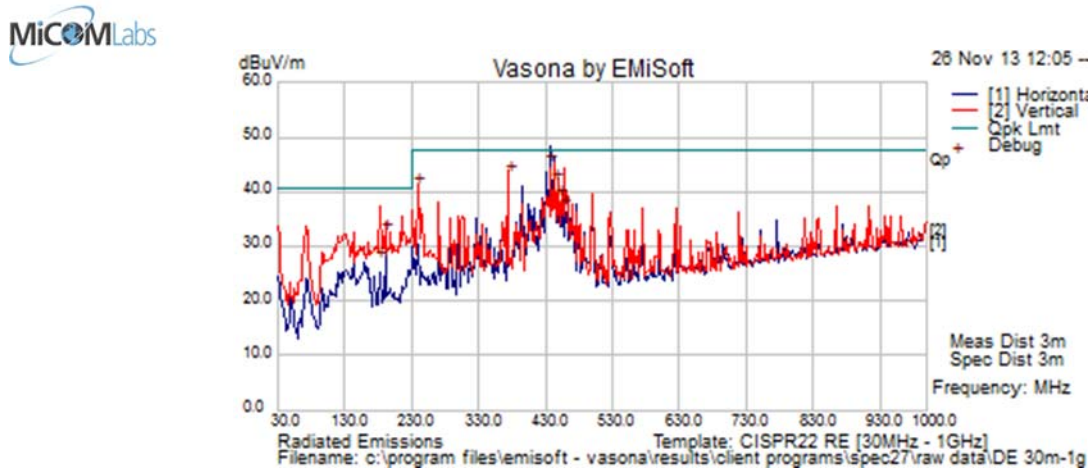

Formally measured emission peaks

Frequency MHz	Raw dBuV	Cable Loss	AF dB	Level dBuV/m	Measurement Type	Pol	Hgt cm	Azt Deg	Limit dBuV/m	Margin dB	Pass /Fail	Comments
437.465	53.1	5.6	-14.0	44.760	Quasi Max	H	225	307	47.5	-2.7	Pass	
375.005	53.0	5.4	-15.3	43.0	Quasi Max	V	99	158	47.5	-4.5	Pass	
443.758	49.9	5.7	-13.9	41.7	Quasi Max	H	213	213	47.5	-5.8	Pass	
240.005	54.8	4.8	-18.7	40.9	Peak [Scan]	V	98	0	47.5	-6.6	Pass	
192.029	46.9	4.6	-19.0	32.4	Quasi Max	V	101	39	40.5	-8.1	Pass	
450.025	46.9	5.7	-13.8	38.8	Quasi Max	V	153	89	47.5	-8.7	Pass	
458.402	44.5	5.7	-13.5	36.7	Quasi Max	V	144	61	47.5	-10.8	Pass	
181.623	42.2	4.5	-19.6	27.1	Quasi Max	V	99	302	40.5	-13.4	Pass	

Legend: DIG = Digital Device Emission; TX = Transmitter Emission; FUND = Fundamental Frequency
 NRB = Non-Restricted Band, Limit is 20 dB below Fundamental; RB = Restricted Band

This test report may be reproduced in full only. The document may only be updated by MiCOM Labs personnel. Any changes will be noted in the Document History section of the report.



Specification

Limits

§15.205 (a) Except as shown in paragraph (d) of 15.205 (a), only spurious emissions are permitted in any of the frequency bands listed.

§15.205 (a) Except as shown in paragraphs (d) and (e) of this section, the field strength of emissions appearing within these frequency bands shall not exceed the limits shown in Section §15.209. At frequencies equal to or less than 1000 MHz, compliance with the limits in Section 15.209 shall be demonstrated using measurement instrumentation employing a CISPR quasi-peak detector. Above 1000 MHz, compliance with the emission limits in Section 15.209 shall be demonstrated based on the average value of the measured emissions. The provisions in Section 15.35 apply to these measurements.

§15.209 (a) Except as provided elsewhere in this subpart, the emissions from an intentional radiator shall not exceed the field strength levels specified in the following table.

§15.209 (a) and RSS-Gen §2.2 Limit Matrix

Frequency(MHz)	Field Strength (µV/m)	Field Strength (dBµV/m)	Measurement Distance (meters)
30-88	100	40.0	3
88-216	150	43.5	3
216-960	200	46.0	3
Above 960	500	54.0	3

Laboratory Measurement Uncertainty for Radiated Emissions

Measurement uncertainty	+5.6/ -4.5 dB
-------------------------	---------------

Traceability

Method	Test Equipment Used
Measurements were made per work instruction WI-03 'Measurement of Radiated Emissions'	0088, 0158, 0134, 0304, 0311, 0315, 0310, 0312

6.1.3. AC Wireline Conducted Emissions (150 kHz – 30 MHz)

FCC, Part 15 Subpart C §15.207
Industry Canada RSS-Gen §7.2.2

Test Procedure

The EUT is configured in accordance with ANSI C63.4. The conducted emissions are measured in a shielded room with a spectrum analyzer in peak hold in the first instance. Emissions closest to the limit are measured in the quasi-peak mode (QP) with the tuned receiver using a bandwidth of 9 kHz. The emissions are maximized further by cable manipulation. The highest emissions relative to the limit are listed.

Test Measurement Set up

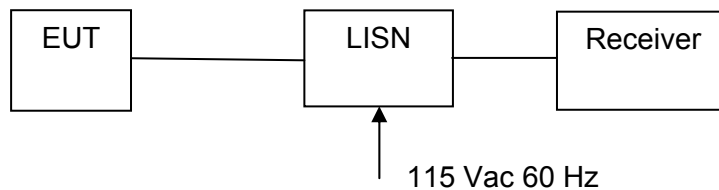

Measurement set up for AC Wireline Conducted Emissions Test

Measurement Results for AC Wireline Conducted Emissions (150 kHz – 30 MHz)

Ambient conditions.

Temperature: 17 to 23 °C Relative humidity: 31 to 57 % Pressure: 999 to 1012 mbar



Title: Spectralink 8753 Enhanced IP Telephone
To: FCC 47 CFR Part 15.407 & IC RSS-210
Serial #: SPEC27-U6 Rev A
Issue Date: 2nd January 2014
Page: 81 of 144

Test Freq.	N/A	Engineer	JMH
Variant	AC Line Emissions	Temp (°C)	11
Freq. Range	0.150 MHz - 30 MHz	Rel. Hum.(%)	27
Power Setting	Maximum	Press. (mBars)	1002
Antenna	Not Applicable		
Test Notes 1	110V 60 Hz PS GCI 1 A		

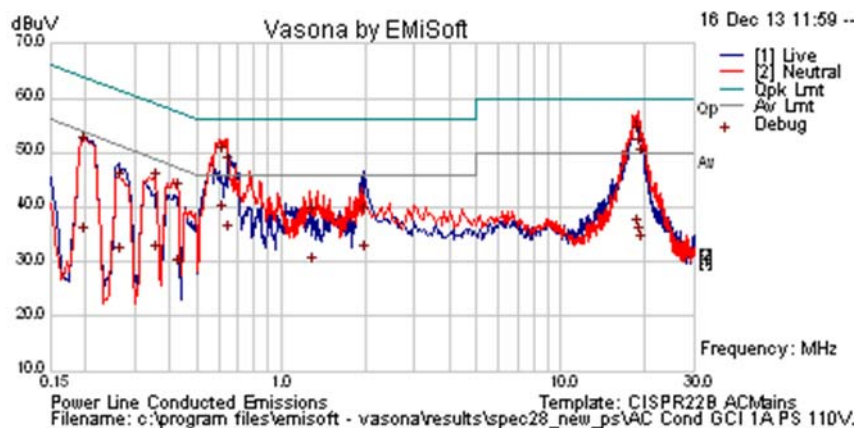

Formally measured emission peaks

Frequency MHz	Raw dBuV	Cable Loss	Factors dB	Level dBuV	Measurement Type	Line	Limit dBuV	Margin dB	Pass /Fail	Comments
0.195	41.1	9.9	0.1	51.1	Quasi Peak	Live	63.82	-12.8	Pass	
0.195	24.7	9.9	0.1	34.6	Average	Live	53.82	-19.2	Pass	
0.261	21.0	9.9	0.1	30.9	Average	Live	51.4	-20.5	Pass	
0.261	34.6	9.9	0.1	44.6	Quasi Peak	Live	61.4	-16.8	Pass	
0.352	21.3	9.9	0.1	31.3	Average	Neutral	48.92	-17.6	Pass	
0.352	34.6	9.9	0.1	44.5	Quasi Peak	Neutral	58.92	-14.4	Pass	
0.423	32.9	9.9	0.1	42.8	Quasi Peak	Neutral	57.39	-14.6	Pass	
0.423	18.8	9.9	0.1	28.7	Average	Neutral	47.39	-18.6	Pass	
0.614	39.3	10.0	0.1	49.4	Quasi Peak	Neutral	56	-6.6	Pass	
0.614	28.7	10.0	0.1	38.7	Average	Neutral	46	-7.3	Pass	
0.638	37.6	10.0	0.1	47.7	Quasi Peak	Neutral	56	-8.3	Pass	
0.638	25.1	10.0	0.1	35.1	Average	Neutral	46	-10.9	Pass	
1.273	28.3	10.0	0.1	38.4	Quasi Peak	Neutral	56	-17.7	Pass	
1.273	19.1	10.0	0.1	29.2	Average	Neutral	46	-16.9	Pass	
1.953	21.2	10.0	0.1	31.4	Average	Live	46	-14.6	Pass	
1.953	28.2	10.0	0.1	38.4	Quasi Peak	Live	56	-17.7	Pass	
18.699	24.9	10.5	0.7	36.1	Average	Neutral	50	-13.9	Pass	
18.699	41.9	10.5	0.7	53.1	Quasi Peak	Neutral	60	-6.9	Pass	
18.980	39.6	10.5	0.7	50.8	Quasi Peak	Neutral	60	-9.2	Pass	
18.980	23.6	10.5	0.7	34.8	Average	Neutral	50	-15.2	Pass	
19.094	37.9	10.5	0.7	49.2	Quasi Peak	Neutral	60	-10.8	Pass	
19.094	21.9	10.5	0.7	33.1	Average	Neutral	50	-16.9	Pass	

Legend: DIG = Digital Device Emission; TX = Transmitter Emission; FUND = Fundamental Frequency
 NRB = Non-Restricted Band, Limit is 20 dB below Fundamental; RB = Restricted Band

This test report may be reproduced in full only. The document may only be updated by MiCOM Labs personnel. Any changes will be noted in the Document History section of the report.



Title: Spectralink 8753 Enhanced IP Telephone
To: FCC 47 CFR Part 15.407 & IC RSS-210
Serial #: SPEC27-U6 Rev A
Issue Date: 2nd January 2014
Page: 82 of 144

Test Freq.	N/A	Engineer	JMH
Variant	AC Line Emissions	Temp (°C)	11
Freq. Range	0.150 MHz - 30 MHz	Rel. Hum.(%)	27
Power Setting		Press. (mBars)	1002
Antenna			
Test Notes 1	110V 60 Hz JE1.5A Power Supply		

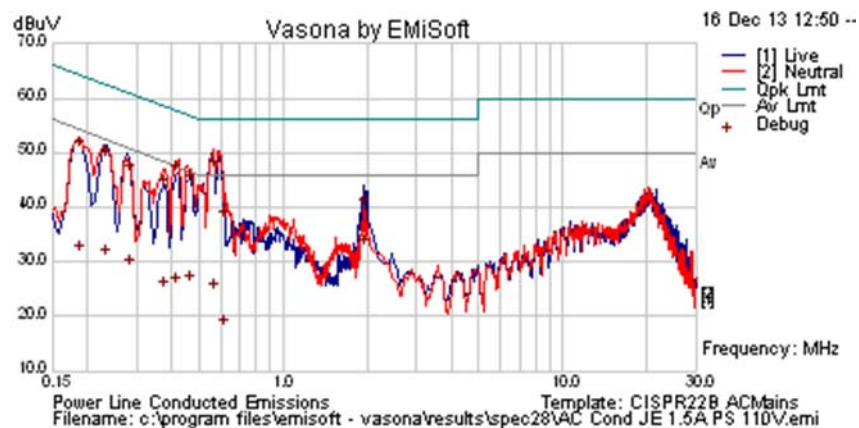

Formally measured emission peaks

Frequency MHz	Raw dBuV	Cable Loss	Factors dB	Level dBuV	Measurement Type	Line	Limit dBuV	Margin dB	Pass /Fail	Comments
0.186	21.4	9.9	0.1	31.4	Average	Neutral	54.2	-22.8	Pass	
0.186	40.6	9.9	0.1	50.6	Quasi Peak	Neutral	64.2	-13.6	Pass	
0.232	38.8	9.9	0.1	48.8	Quasi Peak	Live	62.38	-13.6	Pass	
0.232	20.5	9.9	0.1	30.5	Average	Live	52.38	-21.9	Pass	
0.279	36.2	9.9	0.1	46.2	Quasi Peak	Live	60.83	-14.7	Pass	
0.279	18.7	9.9	0.1	28.7	Average	Live	50.83	-22.1	Pass	
0.374	14.9	9.9	0.1	24.8	Average	Neutral	48.42	-23.6	Pass	
0.374	33.5	9.9	0.1	43.5	Quasi Peak	Neutral	58.42	-15.0	Pass	
0.408	15.7	9.9	0.1	25.6	Average	Neutral	47.69	-22.1	Pass	
0.408	36.0	9.9	0.1	45.9	Quasi Peak	Neutral	57.69	-11.8	Pass	
0.459	15.7	9.9	0.1	25.7	Average	Neutral	46.7	-21.0	Pass	
0.459	34.4	9.9	0.1	44.4	Quasi Peak	Neutral	56.7	-12.3	Pass	
0.564	14.3	9.9	0.1	24.3	Average	Neutral	46	-21.7	Pass	
0.564	36.9	9.9	0.1	46.9	Quasi Peak	Neutral	56	-9.1	Pass	
1.948	22.2	10.0	0.1	32.3	Average	Live	46	-13.7	Pass	
1.948	29.8	10.0	0.1	39.9	Quasi Peak	Live	56	-16.1	Pass	

Legend: DIG = Digital Device Emission; TX = Transmitter Emission; FUND = Fundamental Frequency
 NRB = Non-Restricted Band, Limit is 20 dB below Fundamental; RB = Restricted Band

This test report may be reproduced in full only. The document may only be updated by MiCOM Labs personnel. Any changes will be noted in the Document History section of the report.



Specification

Limit

§15.207 (a) Except as shown in paragraphs (b) and (c) of this section, for an intentional radiator that is designed to be connected to the public utility (AC) power line, the radio frequency voltage that is conducted back onto the AC power line on any frequency or frequencies within the band 150 kHz to 30 MHz shall not exceed the limits in the following table, as measured using a 50 $\mu\Omega$ line impedance stabilization network (LISN), see §15.207 (a) matrix below. Compliance with the provisions of this paragraph shall be based on the measurement of the radio frequency voltage between each power line and ground at the power terminal.

RSS-Gen §7.2.2

The radio frequency voltage that is conducted back into the AC power lines in the frequency range of 0.15 MHz to 30 MHz shall not exceed the limits shown in the table below. The tighter limit applies at the frequency range boundaries.

§15.207 (a) and RSS-Gen §7.2.2 Limit Matrix

The lower limit applies at the boundary between frequency ranges

Frequency of Emission (MHz)	Conducted Limit (dB μ V)	
	Quasi-peak	Average
0.15-0.5	66 to 56*	56 to 46*
0.5-5	56	46
5-30	60	50

* Decreases with the logarithm of the frequency

Laboratory Measurement Uncertainty for Conducted Emissions

Measurement uncertainty	± 2.64 dB
-------------------------	---------------

Traceability

Method	Test Equipment Used
Measurements were made per work instruction WI-EMC-01 'Measurement of Conducted Emissions'	0158, 0184, 0287, 0190, 0293, 0307



6.1.4. Dynamic Frequency Selection (DFS)

FCC, Part 15 Subpart C §15.407(h)
FCC 06-96 Memorandum Opinion and Order
Industry Canada RSS-210 A9.4

6.1.4.1. Interference Threshold values, Master or Client incorporating In-Service Monitoring

Maximum Transmit Power	Value (see note)
≥ 200 milliwatt	-64 dBm
< 200 milliwatt	-62 dBm
Note 1: This is the level at the input of the receiver assuming a 0 dBi receive antenna	

DFS Response requirement values

Parameter	Value
<i>Non-occupancy period</i>	Minimum 30 minutes
<i>Channel Availability Check Time</i>	60 seconds
<i>Channel Move Time</i>	10 seconds See Note 1.
<i>Channel Closing Transmission Time</i>	200 milliseconds + an aggregate of 60 milliseconds over remaining 10 second period. See Notes 1 and 2.
<i>U-NII Detection Bandwidth</i>	Minimum 80% of the 99% power bandwidth See Note 3.

Note 1: The instant that the *Channel Move Time* and the *Channel Closing Transmission Time* begins is as follows:

- For the Short pulse radar Test Signals this instant is the end of the *Burst*.
- For the Frequency Hopping radar Test Signal, this instant is the end of the last radar *Burst* generated.
- For the Long Pulse radar Test Signal this instant is the end of the 12 second period defining the radar transmission.

Note 2: The *Channel Closing Transmission Time* is comprised of 200 milliseconds starting at the beginning of the *Channel Move Time* plus any additional intermittent control signals required to facilitate *Channel* changes (an aggregate of 60 milliseconds) during the remainder of the 10 second period. The aggregate duration of control signals will not count quiet periods in between transmissions.

Note 3: During the *U-NII Detection Bandwidth* detection test, radar type 1 is used and for each frequency step the minimum percentage of detection is 90%. Measurements are performed with no data traffic.



6.1.4.2. Radar Test Waveforms

This section provides the parameters for required test waveforms, minimum percentage of successful detections, and the minimum number of trials that must be used for determining DFS conformance. Step intervals of 0.1 microsecond for Pulse Width, 1 microsecond for PRI, 1 MHz for chirp width and 1 for the number of pulses will be utilized for the random determination of specific test waveforms.

Short Pulse Radar Test Waveforms

Radar Type	Pulse Width (µsec)	PRI (µsec)	Number of Pulses	Minimum Percentage of Successful Detection	Minimum Trials
1	1	1428	18	60%	30
2	1-5	150-230	23-29	60%	30
3	6-10	200-500	16-18	60%	30
4	11-20	200-500	12-16	60%	30
Aggregate (Radar Types 1-4)				80%	120

A minimum of 30 unique waveforms are required for each of the short pulse radar types 2 through 4. For short pulse radar type 1, the same waveform is used a minimum of 30 times. If more than 30 waveforms are used for short pulse radar types 2 through 4, then each additional waveform must also be unique and not repeated from the previous waveforms. The aggregate is the average of the percentage of successful detections of short pulse radar types 1-4.

Long Pulse Radar Test Waveform

Radar Type	Pulse Width (µsec)	Chirp Width (MHz)	PRI (µsec)	Number of Pulses per Burst	Number of Bursts	Minimum Percentage of Successful Detection	Minimum Trials
5	50-100	5-20	1000-2000	1-3	8-20	80%	30

The parameters for this waveform are randomly chosen. Thirty unique waveforms are required for the Long Pulse radar test signal. If more than 30 waveforms are used for the Long Pulse radar test signal, then each additional waveform must also be unique and not repeated from the previous waveforms.



Title: Spectralink 8753 Enhanced IP Telephone
To: FCC 47 CFR Part 15.407 & IC RSS-210
Serial #: SPEC27-U6 Rev A
Issue Date: 2nd January 2014
Page: 86 of 144

Each waveform is defined as follows:

- 1) The transmission period for the Long Pulse Radar test signal is 12 seconds.
- 2) There are a total of 8 to 20 *Bursts* in the 12 second period, with the number of *Bursts* being randomly chosen. This number is *Burst Count*.
- 3) Each *Burst* consists of 1 to 3 pulses, with the number of pulses being randomly chosen. Each *Burst* within the 12 second sequence may have a different number of pulses.
- 4) The pulse width is between 50 and 100 microseconds, with the pulse width being randomly chosen. Each pulse within a *Burst* will have the same pulse width. Pulses in different *Bursts* may have different pulse widths.
- 5) Each pulse has a linear FM chirp between 5 and 20 MHz, with the chirp width being randomly chosen. Each pulse within a *Burst* will have the same chirp width. Pulses in different *Bursts* may have different chirp widths. The chirp is centered on the pulse. For example, with a radar frequency of 5300 MHz and a 20 MHz chirped signal, the chirp starts at 5290 MHz and ends at 5310 MHz.
- 6) If more than one pulse is present in a *Burst*, the time between the pulses will be between 1000 and 2000 microseconds, with the time being randomly chosen. If three pulses are present in a *Burst*, the time between the first and second pulses is chosen independently of the time between the second and third pulses.
- 7) The 12 second transmission period is divided into even intervals. The number of intervals is equal to *Burst_Count*. Each interval is of length $(12,000,000 / \textit{Burst_Count})$ microseconds. Each interval contains one *Burst*. The start time for the *Burst*, relative to the beginning of the interval, is between 1 and $[(12,000,000 / \textit{Burst_Count}) - (\textit{Total Burst Length}) + (\textit{One Random PRI Interval})]$ microseconds, with the start time being randomly chosen. The step interval for the start time is 1 microsecond. The start time for each *Burst* is chosen independently.

This test report may be reproduced in full only. The document may only be updated by MiCOM Labs personnel. Any changes will be noted in the Document History section of the report.

A representative example of a Long Pulse radar test waveform:

- 1) The total test signal length is 12 seconds.
- 2) 8 *Bursts* are randomly generated for the *Burst_Count*.
- 3) *Burst 1* has 2 randomly generated pulses.
- 4) The pulse width (for both pulses) is randomly selected to be 75 microseconds.
- 5) The PRI is randomly selected to be at 1213 microseconds.
- 6) *Bursts 2* through 8 are generated using steps 3 – 5.
- 7) Each *Burst* is contained in even intervals of 1,500,000 microseconds. The starting location for Pulse 1, *Burst 1* is randomly generated (1 to 1,500,000 minus the total *Burst 1* length + 1 random PRI interval) at the 325,001 microsecond step. *Bursts 2* through 8 randomly fall in successive 1,500,000 microsecond intervals (i.e. *Burst 2* falls in the 1,500,001 – 3,000,000 microsecond range).

Graphical representation of the Long Pulse radar Test Waveform.

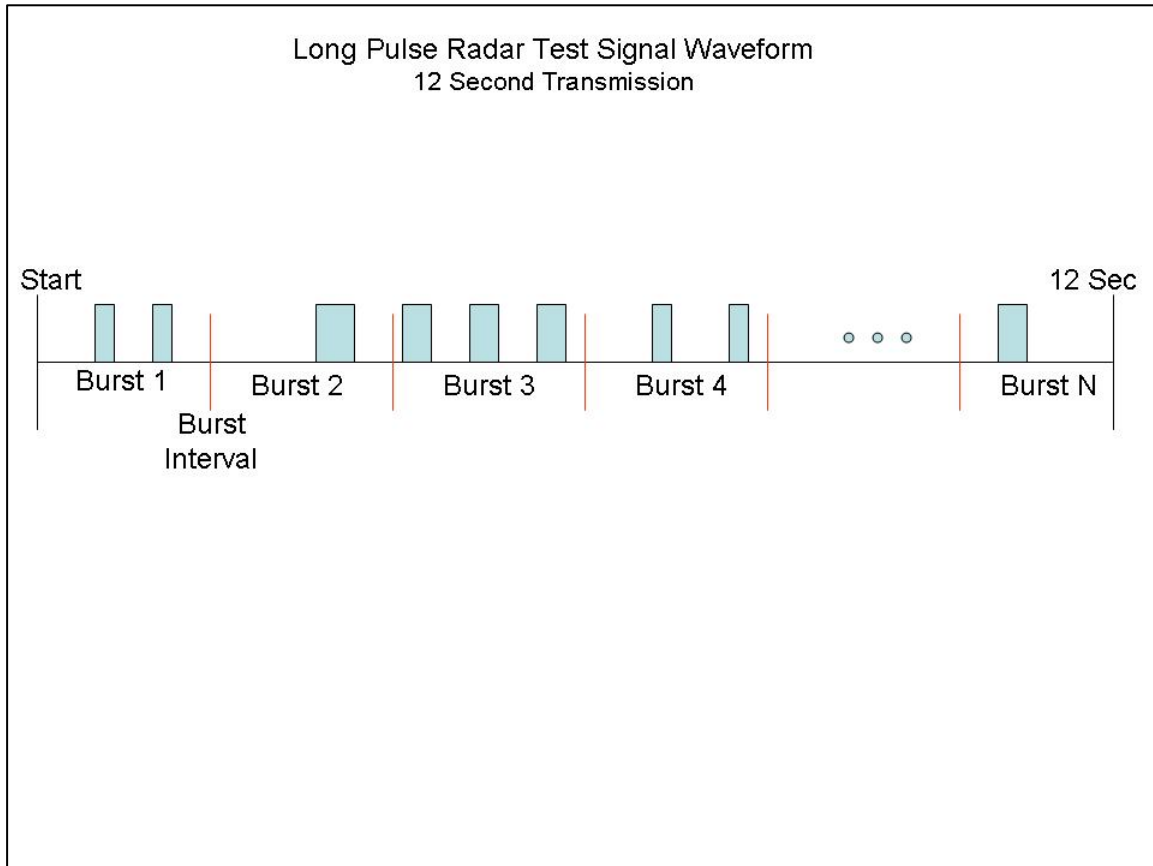

6.1.4.3. Frequency Hopping Radar Test Waveform

Frequency Hopping Radar Test Waveform

Radar Type	Pulse Width (μsec)	PRI (μsec)	Pulses per Hop	Hopping Rate (kHz)	Hopping Sequence Length (msec)	Minimum Percentage of Successful Detection	Minimum Trials
6	1	333	9	.333	300	70%	30

For the Frequency Hopping Radar Type, the same *Burst* parameters are used for each waveform. The hopping sequence is different for each waveform and a 100-length segment is selected from the hopping sequence defined by the following algorithm:

6.1.4.4. Radar Waveform Calibration

The following equipment setup was used to calibrate the conducted Radar Waveform. A spectrum analyzer was used to establish the test signal level for each radar type. During this process there were no transmissions by either the Master or Client Device. The spectrum analyzer was switched to the zero span (Time Domain) mode at the frequency of the Radar Waveform generator. Peak detection was utilized. The spectrum analyzer resolution bandwidth (RBW) and video bandwidth (VBW) were set to 3 MHz.

The signal generator amplitude was set so that the power level measured at the spectrum analyzer was -61dBm (Ref Section 5.1). The 30dB amplifier gain was entered as an amplitude offset on the spectrum analyzer.

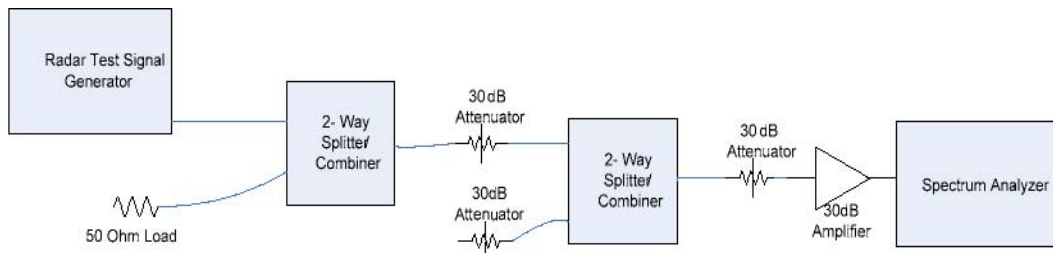

Conducted Calibration Setup

6.1.4.5. DFS Test Set Up

Setup for Conducted Measurements where the EUT is the Master with injection of Radar Test Waveforms at the Master.

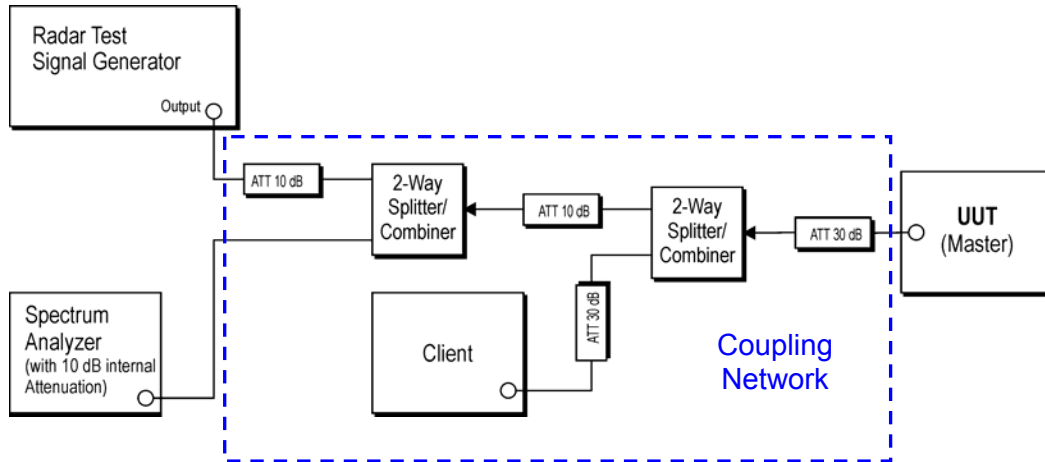

Support Equipment Configuration

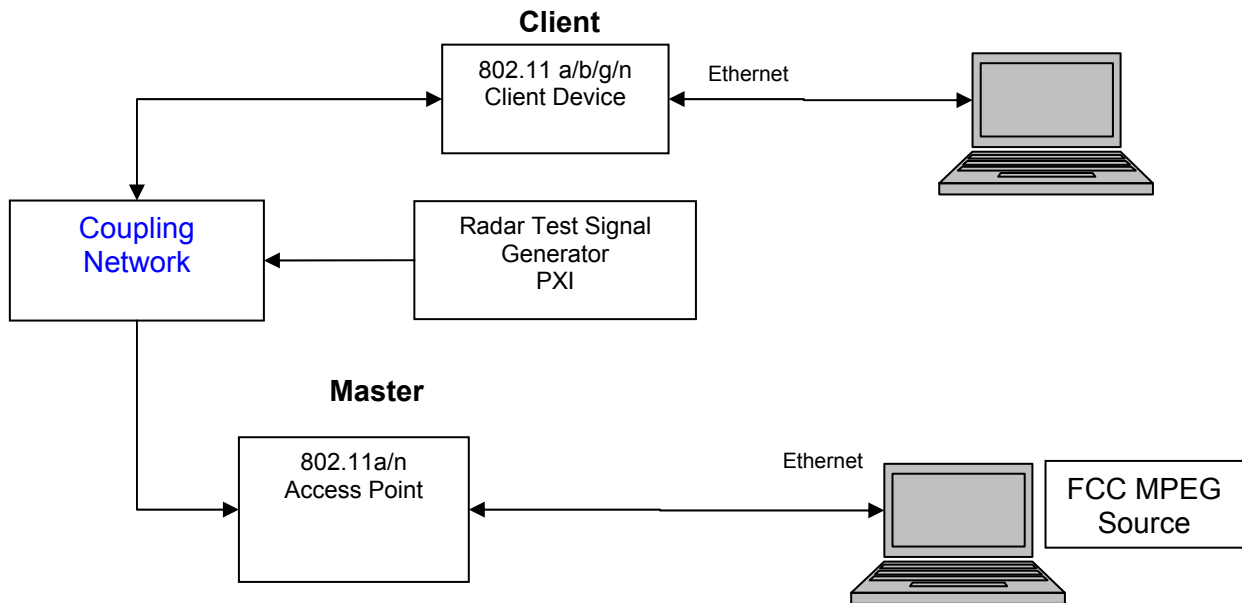

This test report may be reproduced in full only. The document may only be updated by MiCOM Labs personnel. Any changes will be noted in the Document History section of the report.



The EUT is a Client Device without radar detection.

Applicability of DFS Requirements Prior to Use of a Channel
(Ref Table 1 of FCC 06-96)

Requirement	Operational Mode		
	Master	Client Without Radar Detection	Client With Radar Detection
<i>Non-Occupancy Period</i>	Yes	Not required	Yes
<i>DFS Detection Threshold</i>	Yes	Not required	Yes
<i>Channel Availability Check Time</i>	Yes	Not required	Not required
<i>Uniform Spreading</i>	Yes	Not required	Not required
<i>U-NII Detection Bandwidth</i>	Yes	Not required	Yes

Applicability of DFS requirements during normal operation
(Ref Table 2 of FCC 06-96)

Requirement	Operational Mode		
	Master	Client Without Radar Detection	Client With Radar Detection
<i>DFS Detection Threshold</i>	Yes	Not required	Yes
<i>Channel Closing Transmission Time</i>	Yes	Yes	Yes
<i>Channel Move Time</i>	Yes	Yes	Yes
<i>U-NII Detection Bandwidth</i>	Yes	Not required	Yes

This test report may be reproduced in full only. The document may only be updated by MiCOM Labs personnel. Any changes will be noted in the Document History section of the report.



Therefore, pulses seen after the end of radar transmission are identified and totaled to provide an aggregate total of transmissions in order to determine whether the EUT is compliant with the Channel Closing Transmission Time requirements as described in MO&O FCC 06-96. In this case, it was found that an aggregate total of 0.00 ms of transmission time accrued. This value is found at the right hand side at the foot of the following plot (10s Total).

5,500 MHz (802.11a mode)

Channel Closing Transmission Time = 0.0 mSecs (limit 260 mSecs)

Channel Move Time = 0.0 Secs (limit 10 Secs)

Channel Move Time, Channel Closing Transmission Time for Type 1 Radar Captured by the Test System - 0 to 12 seconds

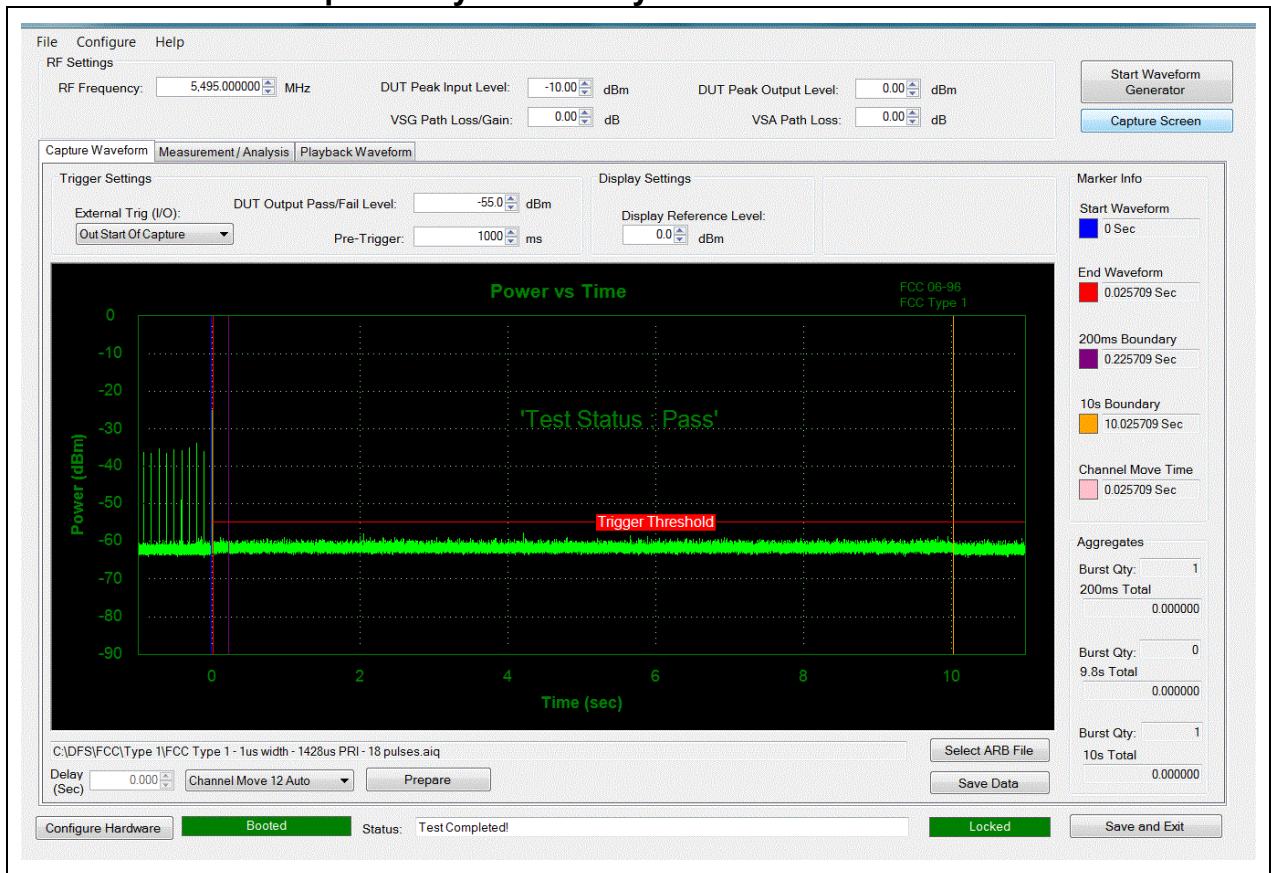

This test report may be reproduced in full only. The document may only be updated by MiCOM Labs personnel. Any changes will be noted in the Document History section of the report.



Title: Spectralink 8753 Enhanced IP Telephone
To: FCC 47 CFR Part 15.407 & IC RSS-210
Serial #: SPEC27-U6 Rev A
Issue Date: 2nd January 2014
Page: 93 of 144

Close up of Type 1 radar injection and approximately 1.5 second period after the end of the radar pulse.

Channel Move Time, Channel Closing Transmission Time for Type 1 Radar Captured by the Test System - 0 to 1.5 seconds

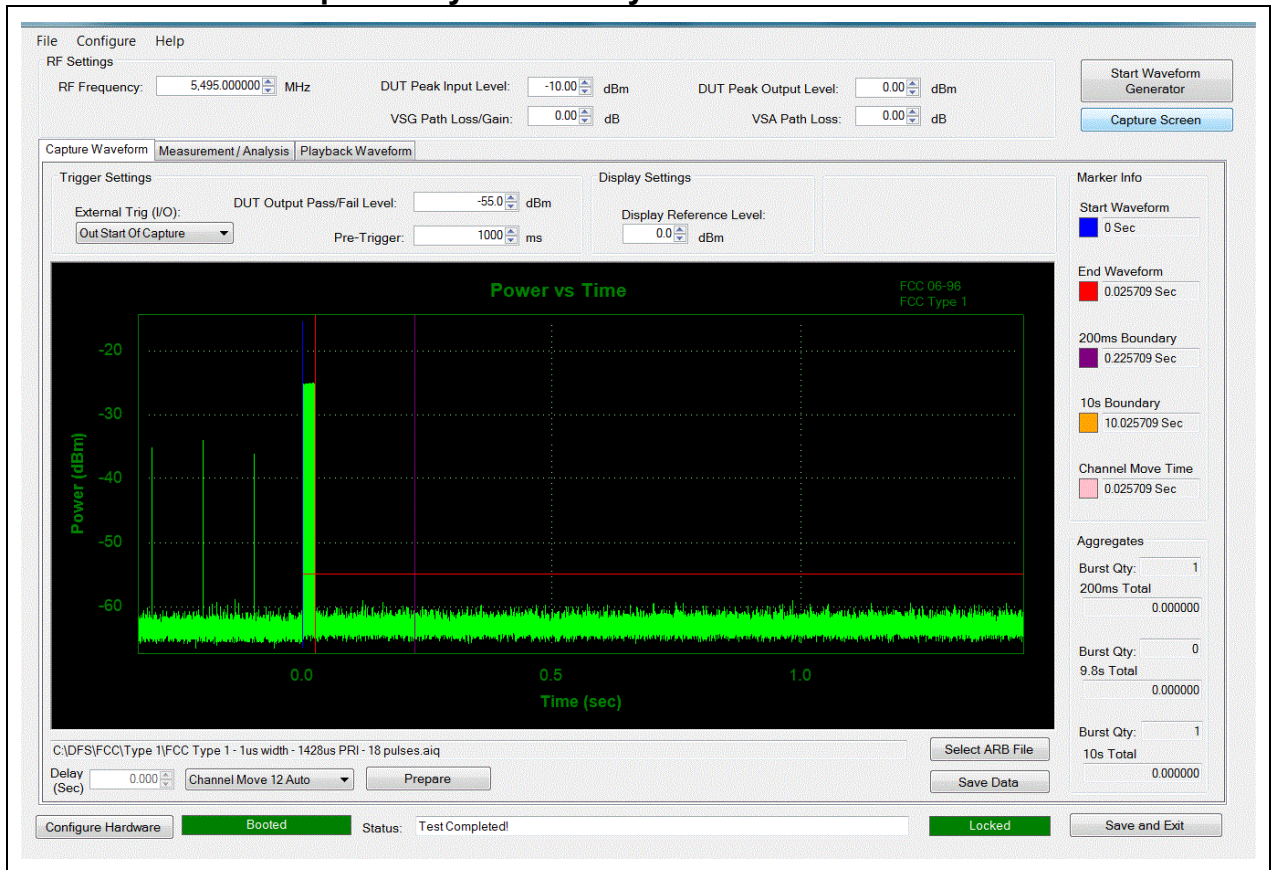

This test report may be reproduced in full only. The document may only be updated by MiCOM Labs personnel. Any changes will be noted in the Document History section of the report.



30 Minute Non-Occupancy Period

The EUT is monitored for more than 30 minutes following the channel close/move time to verify no transmissions resume on this Channel.

30 Minute Non-Occupancy Period Type 1 Radar 5,500MHz 802.11a

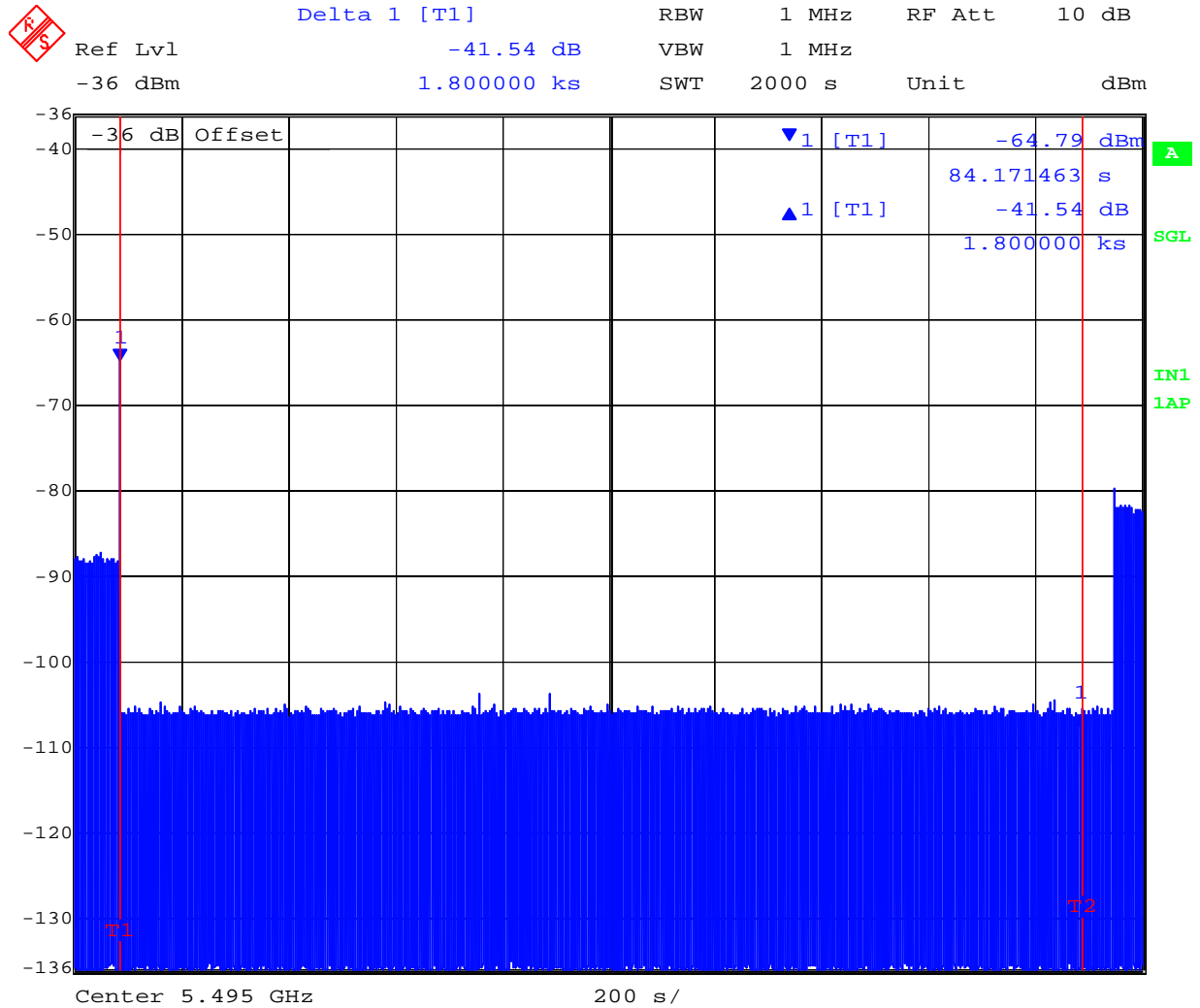

Date: 15.NOV.2013 13:23:15

This test report may be reproduced in full only. The document may only be updated by MiCOM Labs personnel. Any changes will be noted in the Document History section of the report.



Title: Spectralink 8753 Enhanced IP Telephone
To: FCC 47 CFR Part 15.407 & IC RSS-210
Serial #: SPEC27-U6 Rev A
Issue Date: 2nd January 2014
Page: 95 of 144

Measurement Uncertainty Time/Power

Measurement uncertainty		
- Time		4%
- Power		1.33dB

Traceability

Test Equipment Used
0072, 0083, 0098, 0116, 0132, 0158, 0313, 0314, 0193, 0223, 0252, 0253, 0251, 0256, 0328, 0329

This test report may be reproduced in full only. The document may only be updated by MiCOM Labs personnel. Any changes will be noted in the Document History section of the report.

7. PHOTOGRAPHS

7.1. Test Setup – RF Conducted

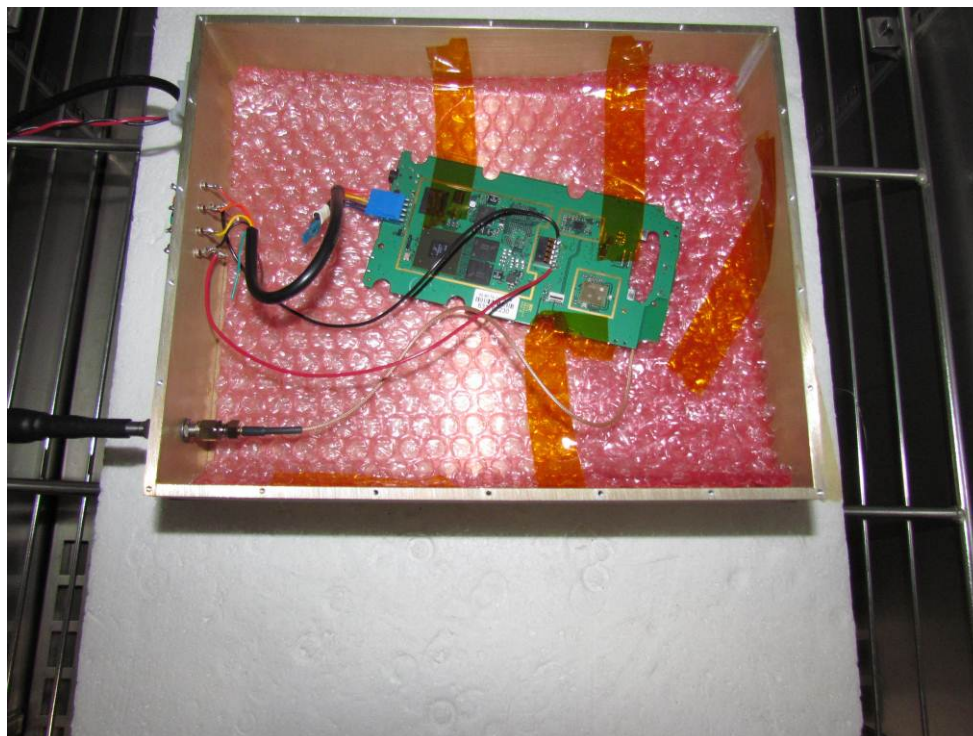

This test report may be reproduced in full only. The document may only be updated by MiCOM Labs personnel. Any changes will be noted in the Document History section of the report.

7.2. Test Setup - Digital Emissions 0.03 - 1 GHz

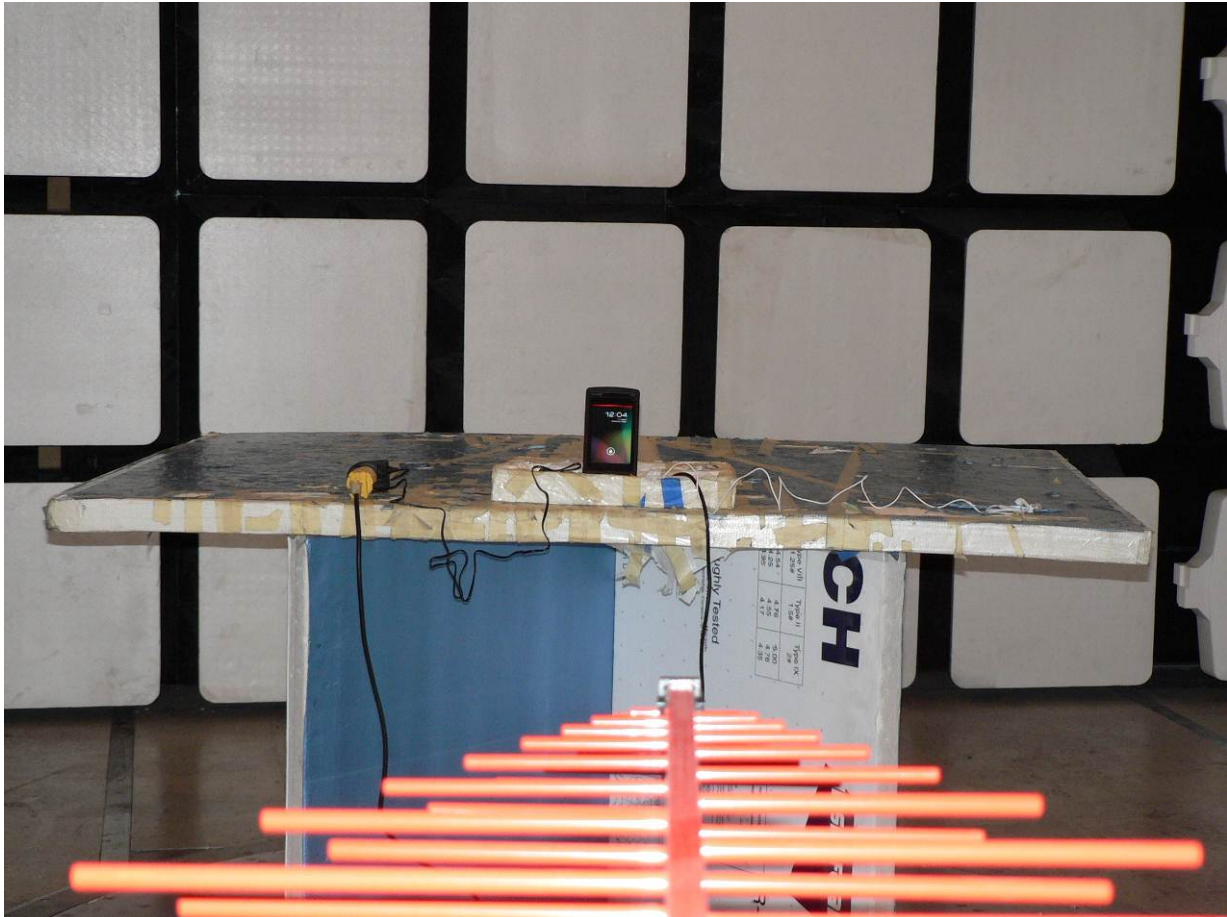

This test report may be reproduced in full only. The document may only be updated by MiCOM Labs personnel. Any changes will be noted in the Document History section of the report.

7.3. Test Setup - Spurious Emissions > 1 GHz

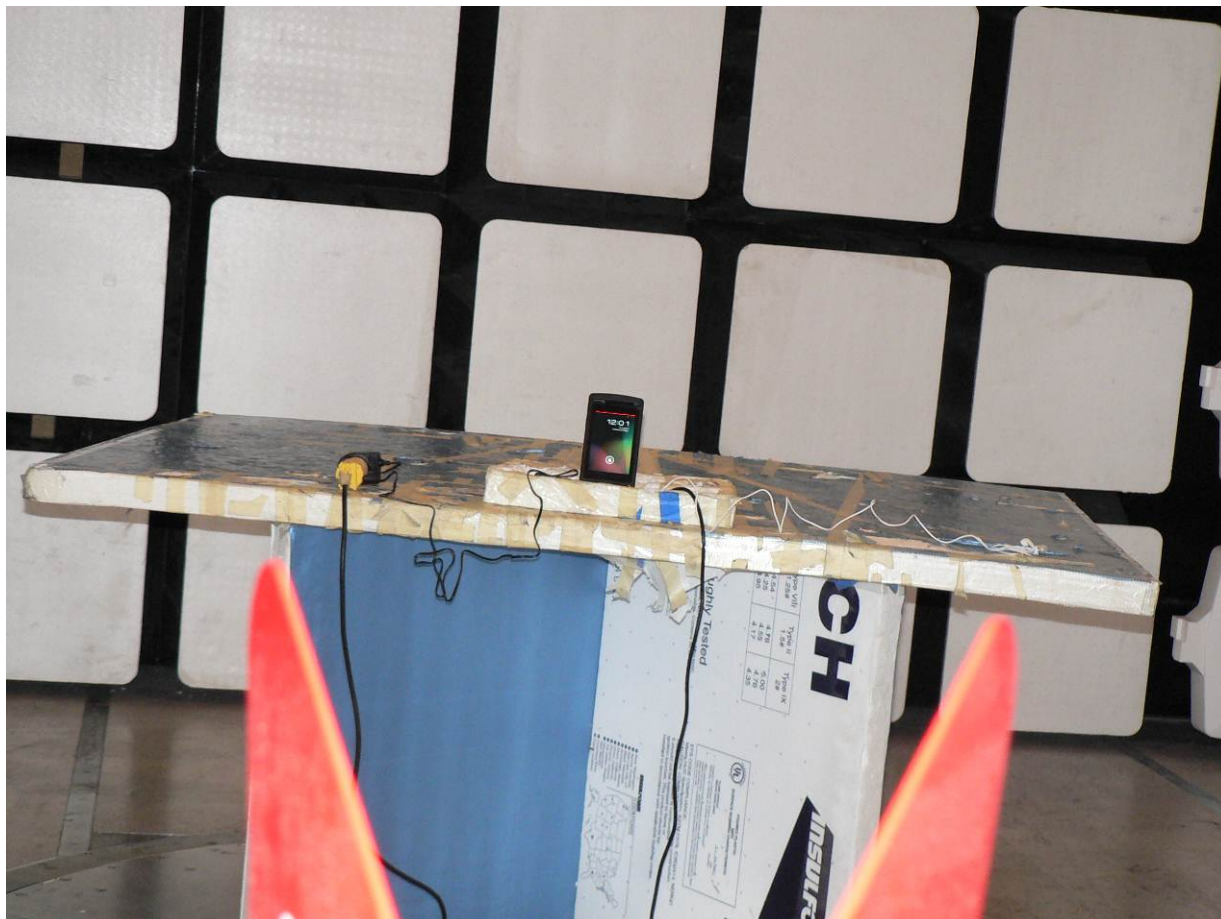

This test report may be reproduced in full only. The document may only be updated by MiCOM Labs personnel. Any changes will be noted in the Document History section of the report.

7.4. Dynamic Frequency Selection (DFS)



This test report may be reproduced in full only. The document may only be updated by MiCOM Labs personnel. Any changes will be noted in the Document History section of the report.



Title: Spectralink 8753 Enhanced IP Telephone
To: FCC 47 CFR Part 15.407 & IC RSS-210
Serial #: SPEC27-U6 Rev A
Issue Date: 2nd January 2014
Page: 100 of 144

8. TEST EQUIPMENT

Asset #	Instrument	Manufacturer	Part #	Serial #	Calibration Due Date
0117	Power Sensor	Hewlett Packard	8487D	3318A00371	18 th Oct 14
0223	Power Meter	Hewlett Packard	EPM-442A	US37480256	18 th Oct 14
0376	Power Sensor	Agilent	U2000A	MY51440005	28 th Oct 14
0390	Power Sensor	Agilent	U2002A	MY50000103	17 th Oct 14
0158	Barometer /Thermometer	Control Co.	4196	E2846	8 th Jan 14
0193	EMI Receiver	Rhode & Schwartz	ESI 7	838496/007	2 nd Dec 13
0287	EMI Receiver	Rhode & Schwartz	ESIB40	100201	31 st Jul 14
0378	EMI Receiver	Rhode & Schwartz	ESIB40	100107/040	17 th Jul 14
0338	30 - 3000 MHz Antenna	Sunol	JB3	A052907	14 th Aug 14
0399	1-18 GHz Horn Antenna	EMCO	3117	00154575	10 th Oct 14
0252	SMA Cable	Megaphase	Sucoflex 104	None	N/A
0310	2m SMA Cable	Micro-Coax	UFA210A-0-0787-3G03G0	209089-001	N/A
0312	3m SMA Cable	Micro-Coax	UFA210A-1-1181-3G0300	209092-001	N/A
0314	30dB N-Type Attenuator	ARRA	N9444-30	1623	N/A
0359	DFS Test System	Aeroflex	PXI-1042	300001/004	21 st Oct 14
0299	DFS Test Software	Aeroflex	PXI Module	Version 7.1.0	N/A
0502	EMC Test Software	EMISoft	Vasona	5.0051	N/A
0503	RF Conducted Test Software	National Instruments	Labview	Version 8.2	N/A
0398	RF Conducted Test Software	MiCOM Labs ATS	--	Version 1.8	N/A
0380	RF Switch	MiCOM Labs	MIC001	MIC001	20 th Dec 13

This test report may be reproduced in full only. The document may only be updated by MiCOM Labs personnel. Any changes will be noted in the Document History section of the report.



Title: Spectralink 8753 Enhanced IP Telephone
To: FCC 47 CFR Part 15.407 & IC RSS-210
Serial #: SPEC27-U6 Rev A
Issue Date: 2nd January 2014
Page: 101 of 144

APPENDIX

A. SUPPORTING INFORMATION

A.1. CONDUCTED TEST PLOTS

This test report may be reproduced in full only. The document may only be updated by MiCOM Labs personnel. Any changes will be noted in the Document History section of the report.

A.1.1. 26 dB & 99% Bandwidth



26 dB & 99% BANDWIDTH

Variant: 802.11a, Channel: 5180.00 MHz, Chain a, Temp: Ambient, Voltage: 3.6 Vdc

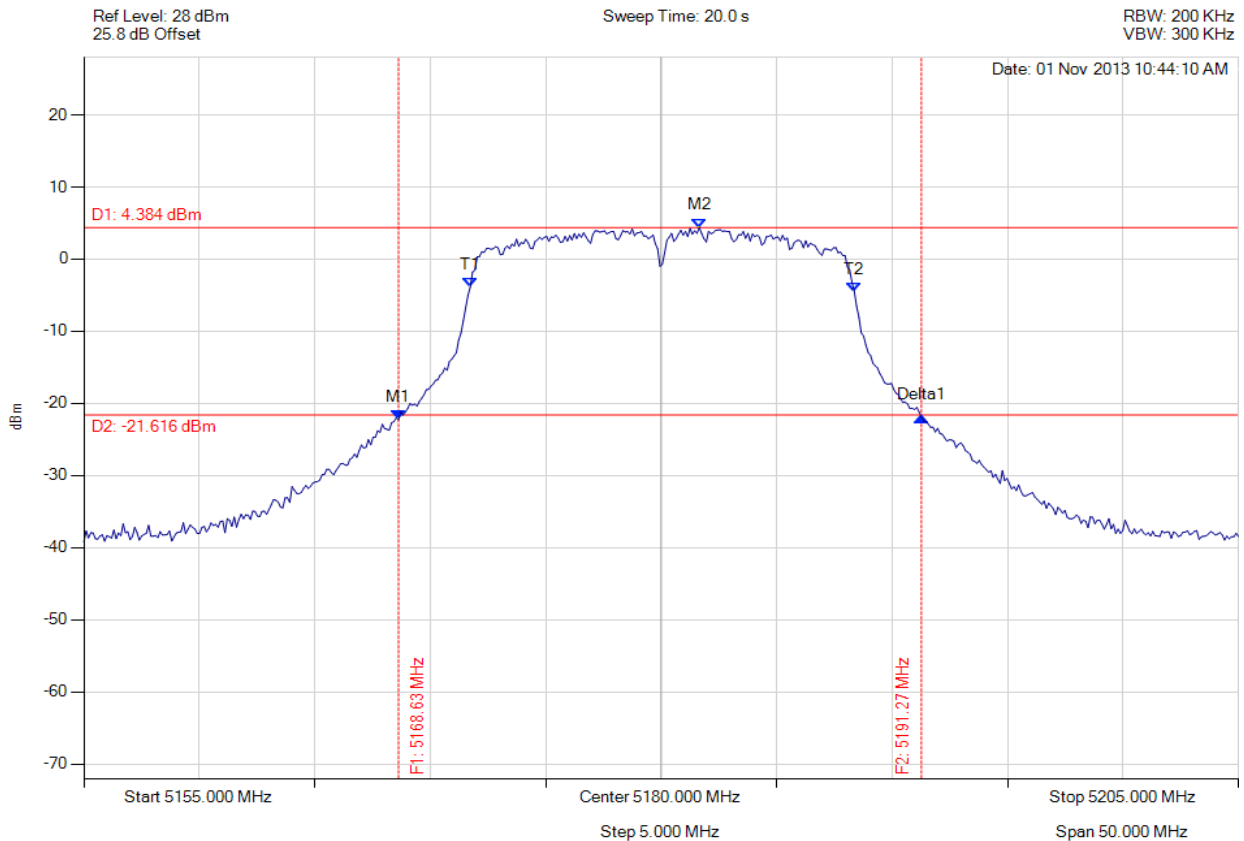

Analyser Setup	Marker : Frequency : Amplitude	Test Results
Detector = MAX PEAK Sweep Count = 0 RF Atten (dB) = 20 Trace Mode = VIEW	M1 : 5168.627 MHz : -22.270 dBm M2 : 5181.653 MHz : 4.384 dBm Delta1 : 22.645 MHz : 0.368 dB T1 : 5171.733 MHz : -3.889 dBm T2 : 5188.367 MHz : -4.528 dBm OBW : 16.633 MHz	Measured 26 dB Bandwidth: 22.645 MHz Measured 99% Bandwidth: 16.633 MHz

[Back to the Matrix](#)

This test report may be reproduced in full only. The document may only be updated by MiCOM Labs personnel. Any changes will be noted in the Document History section of the report.



26 dB & 99% BANDWIDTH

Variant: 802.11a, Channel: 5200.00 MHz, Chain a, Temp: Ambient, Voltage: 3.6 Vdc

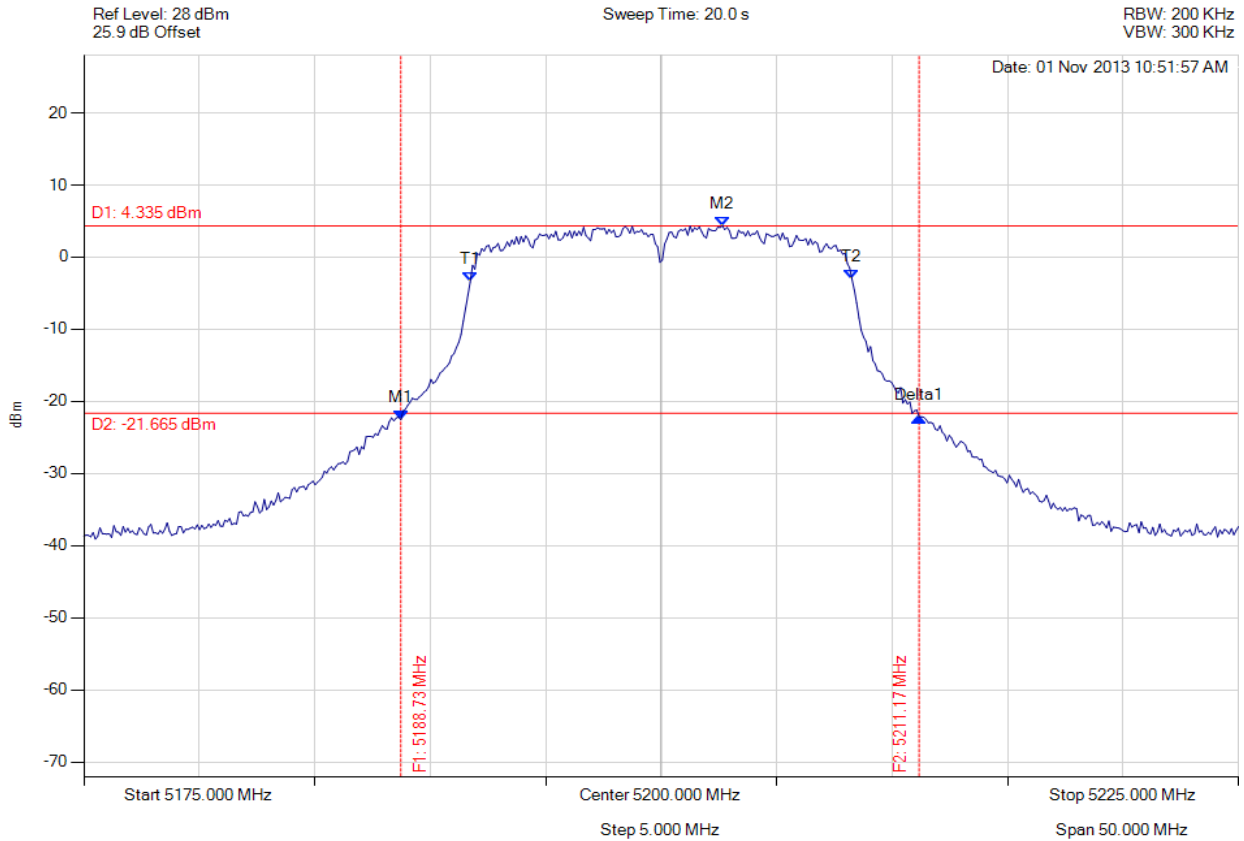

Analyser Setup	Marker : Frequency : Amplitude	Test Results
Detector = MAX PEAK Sweep Count = 0 RF Atten (dB) = 20 Trace Mode = VIEW	M1 : 5188.727 MHz : -22.526 dBm M2 : 5202.655 MHz : 4.335 dBm Delta1 : 22.445 MHz : 0.362 dB T1 : 5191.733 MHz : -3.423 dBm T2 : 5208.267 MHz : -3.076 dBm OBW : 16.533 MHz	Measured 26 dB Bandwidth: 22.445 MHz Measured 99% Bandwidth: 16.533 MHz

[Back to the Matrix](#)

This test report may be reproduced in full only. The document may only be updated by MiCOM Labs personnel. Any changes will be noted in the Document History section of the report.



26 dB & 99% BANDWIDTH

Variant: 802.11a, Channel: 5240.00 MHz, Chain a, Temp: Ambient, Voltage: 3.6 Vdc

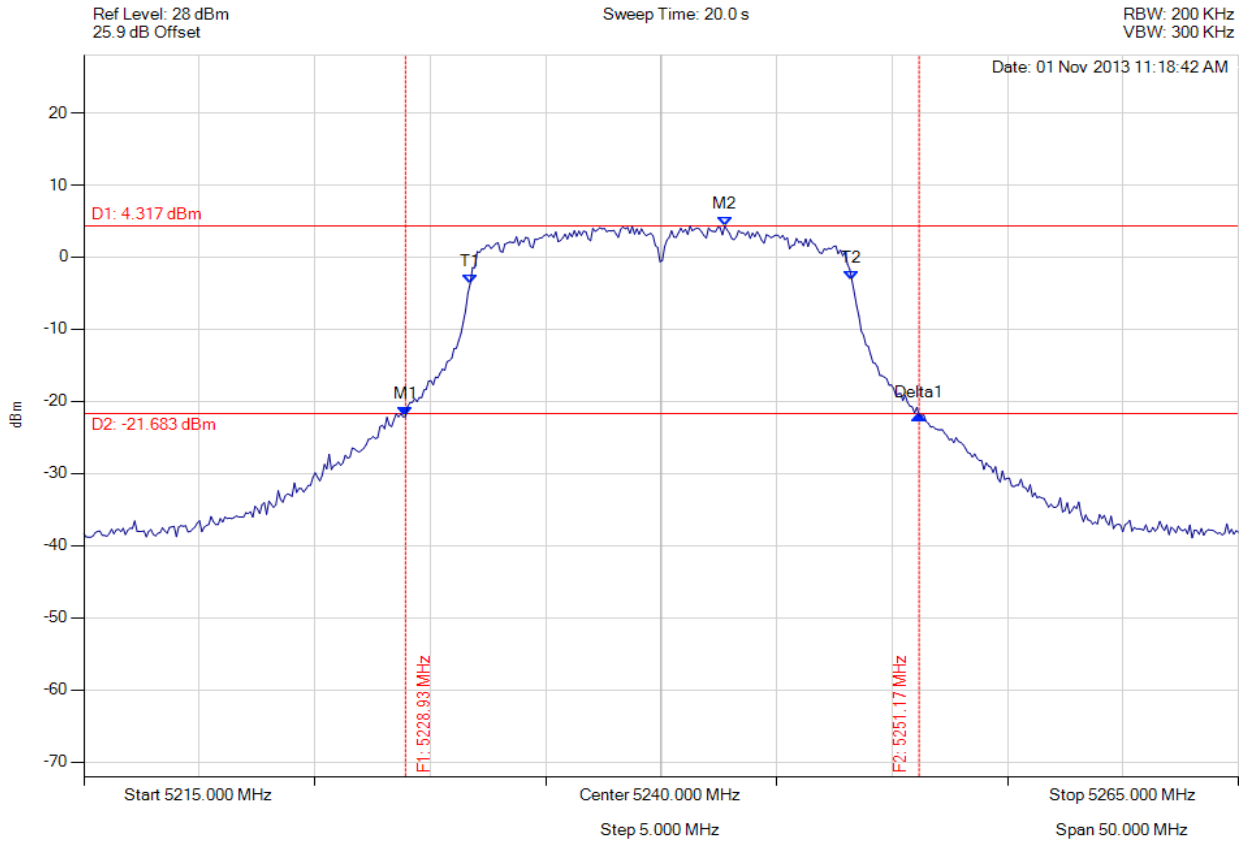

Analyser Setup	Marker : Frequency : Amplitude	Test Results
Detector = MAX PEAK Sweep Count = 0 RF Atten (dB) = 20 Trace Mode = VIEW	M1 : 5228.928 MHz : -22.114 dBm M2 : 5242.756 MHz : 4.317 dBm Delta1 : 22.244 MHz : 0.163 dB T1 : 5231.733 MHz : -3.657 dBm T2 : 5248.267 MHz : -3.253 dBm OBW : 16.533 MHz	Measured 26 dB Bandwidth: 22.244 MHz Measured 99% Bandwidth: 16.533 MHz

[Back to the Matrix](#)

This test report may be reproduced in full only. The document may only be updated by MiCOM Labs personnel. Any changes will be noted in the Document History section of the report.



26 dB & 99% BANDWIDTH

Variant: 802.11n HT-20, Channel: 5180.00 MHz, Chain a, Temp: Ambient, Voltage: 3.6 Vdc

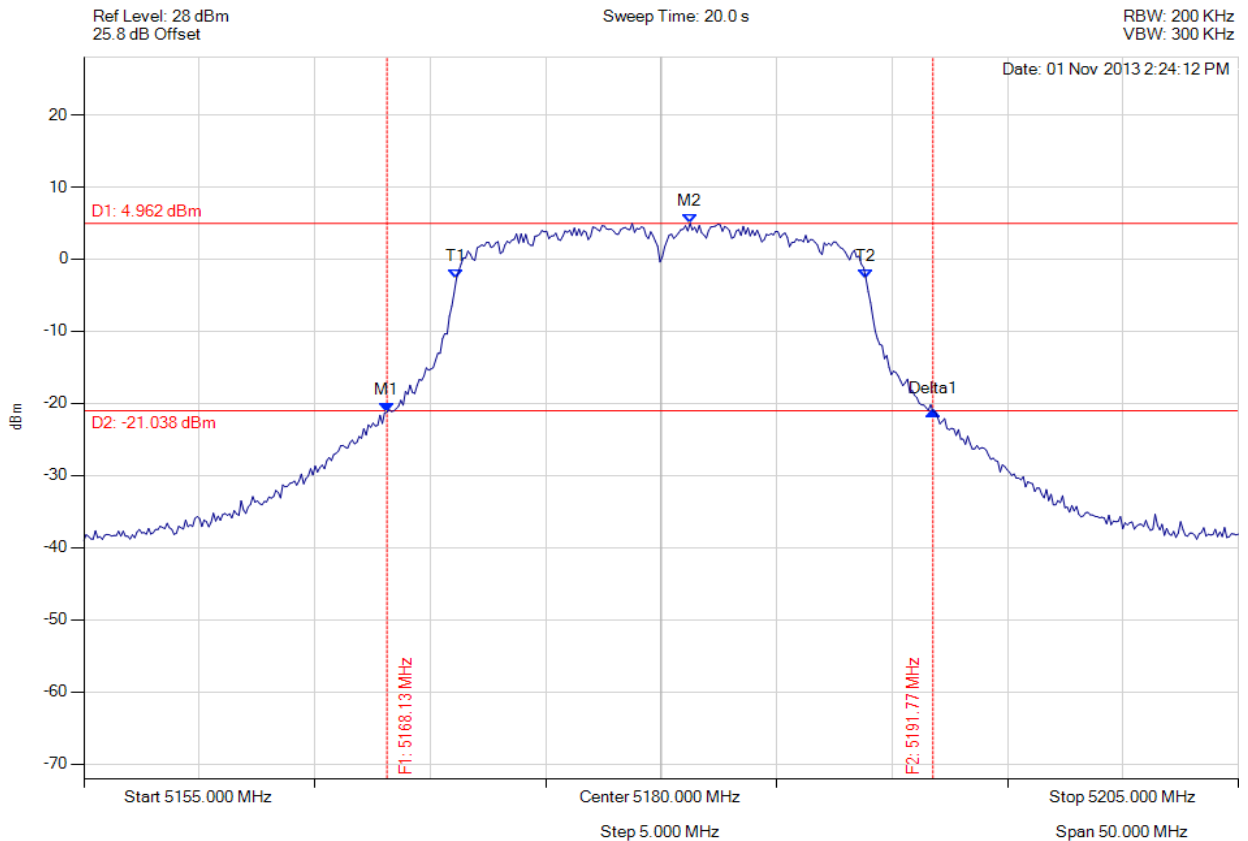

Analyser Setup	Marker : Frequency : Amplitude	Test Results
Detector = MAX PEAK Sweep Count = 0 RF Atten (dB) = 20 Trace Mode = VIEW	M1 : 5168.126 MHz : -21.239 dBm M2 : 5181.253 MHz : 4.962 dBm Delta1 : 23.647 MHz : 0.153 dB T1 : 5171.132 MHz : -2.732 dBm T2 : 5188.868 MHz : -2.708 dBm OBW : 17.735 MHz	Measured 26 dB Bandwidth: 23.647 MHz Measured 99% Bandwidth: 17.735 MHz

[Back to the Matrix](#)

This test report may be reproduced in full only. The document may only be updated by MiCOM Labs personnel. Any changes will be noted in the Document History section of the report.



26 dB & 99% BANDWIDTH

Variant: 802.11n HT-20, Channel: 5200.00 MHz, Chain a, Temp: Ambient, Voltage: 3.6 Vdc

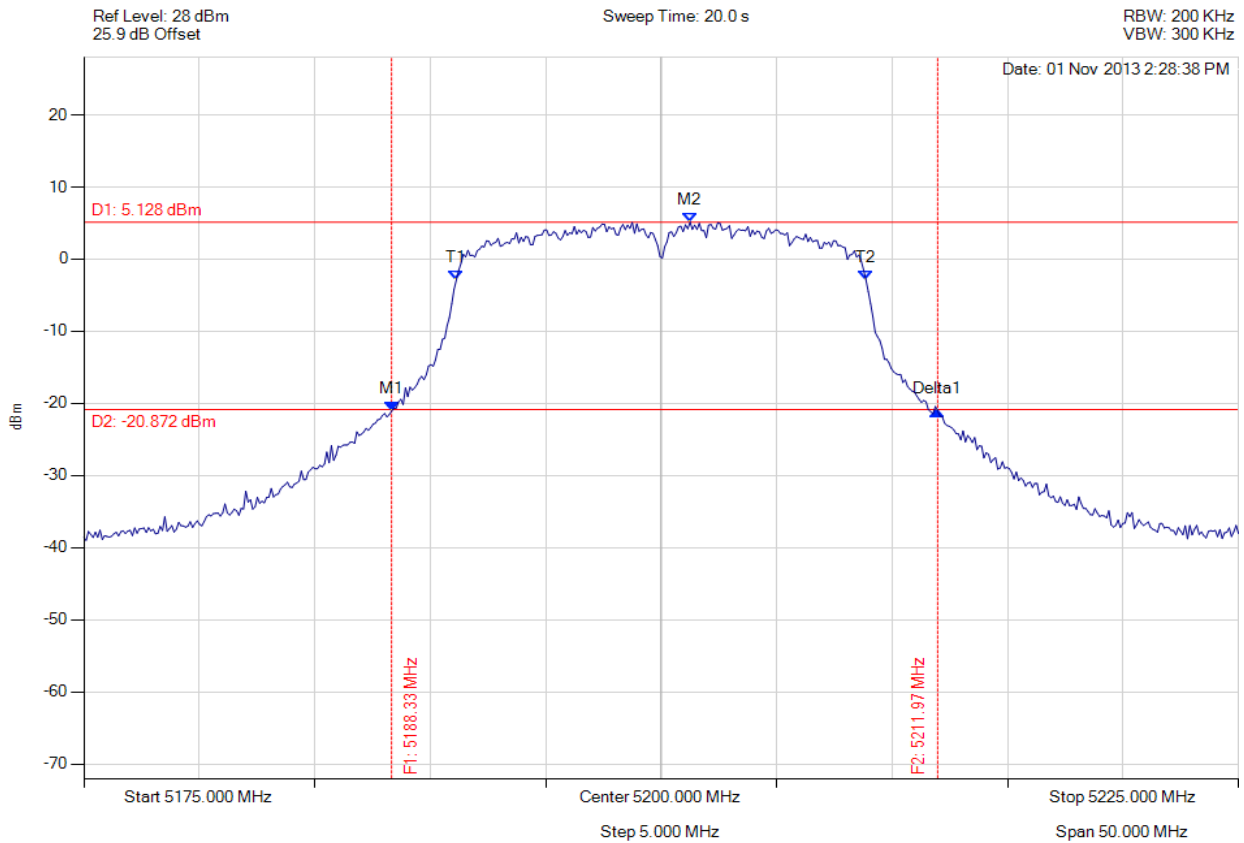

Analyser Setup	Marker : Frequency : Amplitude	Test Results
Detector = MAX PEAK Sweep Count = 0 RF Atten (dB) = 20 Trace Mode = VIEW	M1 : 5188.327 MHz : -21.078 dBm M2 : 5201.253 MHz : 5.128 dBm Delta1 : 23.647 MHz : 0.067 dB T1 : 5191.132 MHz : -2.860 dBm T2 : 5208.868 MHz : -2.852 dBm OBW : 17.735 MHz	Measured 26 dB Bandwidth: 23.647 MHz Measured 99% Bandwidth: 17.735 MHz

[Back to the Matrix](#)

This test report may be reproduced in full only. The document may only be updated by MiCOM Labs personnel. Any changes will be noted in the Document History section of the report.



26 dB & 99% BANDWIDTH

Variant: 802.11n HT-20, Channel: 5240.00 MHz, Chain a, Temp: Ambient, Voltage: 3.6 Vdc

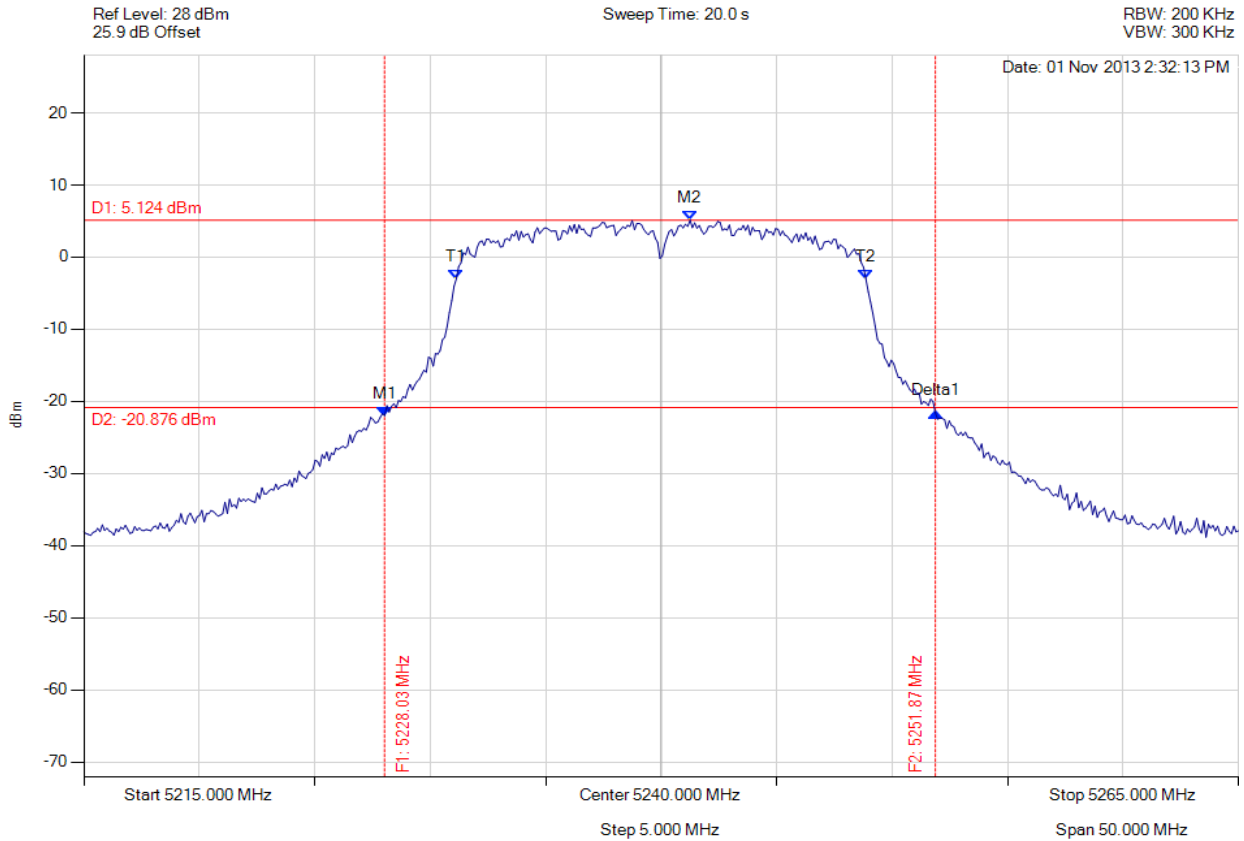

Analyser Setup	Marker : Frequency : Amplitude	Test Results
Detector = MAX PEAK Sweep Count = 0 RF Atten (dB) = 20 Trace Mode = VIEW	M1 : 5228.026 MHz : -21.987 dBm M2 : 5241.253 MHz : 5.124 dBm Delta1 : 23.848 MHz : 0.393 dB T1 : 5231.132 MHz : -2.984 dBm T2 : 5248.868 MHz : -3.051 dBm OBW : 17.735 MHz	Measured 26 dB Bandwidth: 23.848 MHz Measured 99% Bandwidth: 17.735 MHz

[Back to the Matrix](#)

This test report may be reproduced in full only. The document may only be updated by MiCOM Labs personnel. Any changes will be noted in the Document History section of the report.



Title: Spectralink 8753 Enhanced IP Telephone
To: FCC 47 CFR Part 15.407 & IC RSS-210
Serial #: SPEC27-U6 Rev A
Issue Date: 2nd January 2014
Page: 108 of 144



26 dB & 99% BANDWIDTH

Variant: 802.11a, Channel: 5260.00 MHz, Chain a, Temp: Ambient, Voltage: 3.6 Vdc

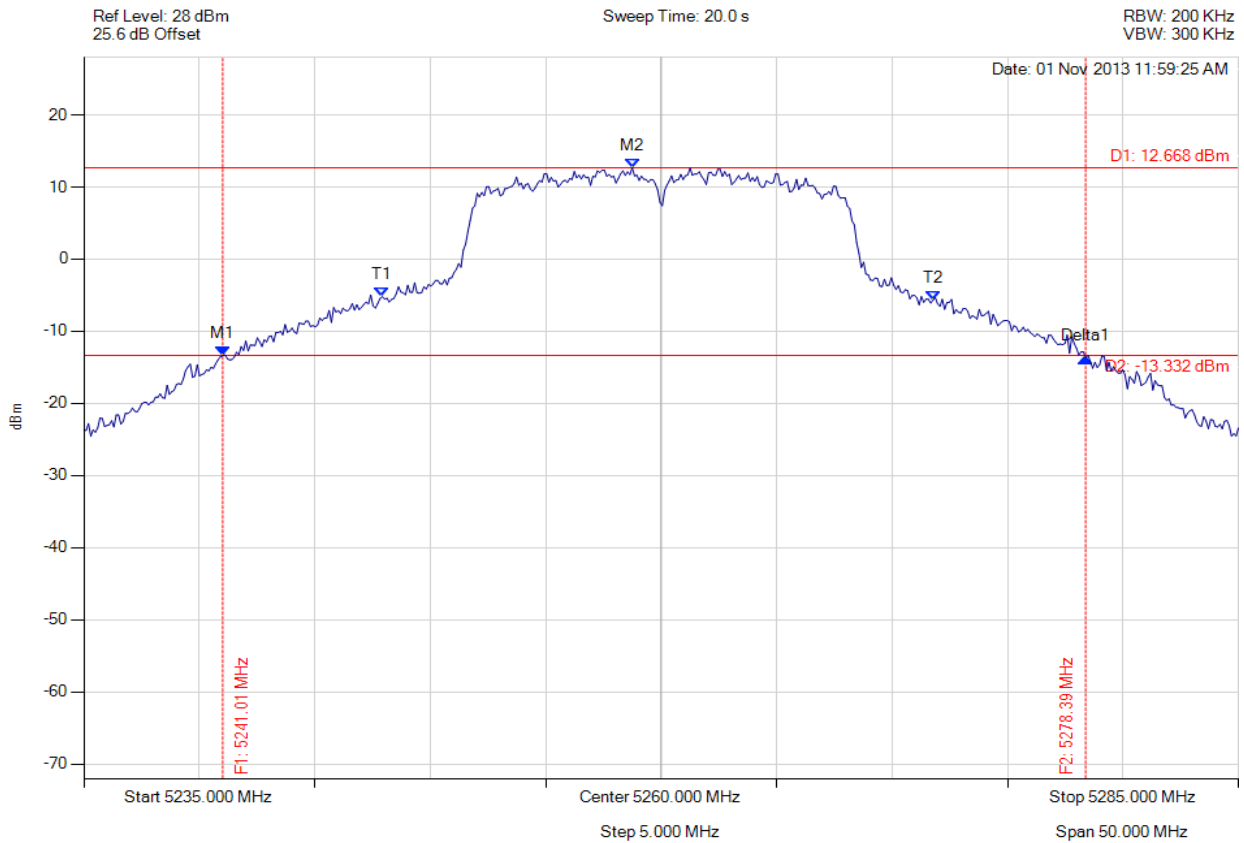

Analyser Setup	Marker : Frequency : Amplitude	Test Results
Detector = MAX PEAK Sweep Count = 0 RF Atten (dB) = 20 Trace Mode = VIEW	M1 : 5241.012 MHz : -13.393 dBm M2 : 5258.747 MHz : 12.668 dBm Delta1 : 37.375 MHz : -0.256 dB T1 : 5247.926 MHz : -5.197 dBm T2 : 5271.774 MHz : -5.695 dBm OBW : 23.848 MHz	Measured 26 dB Bandwidth: 37.375 MHz Measured 99% Bandwidth: 23.848 MHz

[Back to the Matrix](#)

This test report may be reproduced in full only. The document may only be updated by MiCOM Labs personnel. Any changes will be noted in the Document History section of the report.



26 dB & 99% BANDWIDTH

Variant: 802.11a, Channel: 5300.00 MHz, Chain a, Temp: Ambient, Voltage: 3.6 Vdc

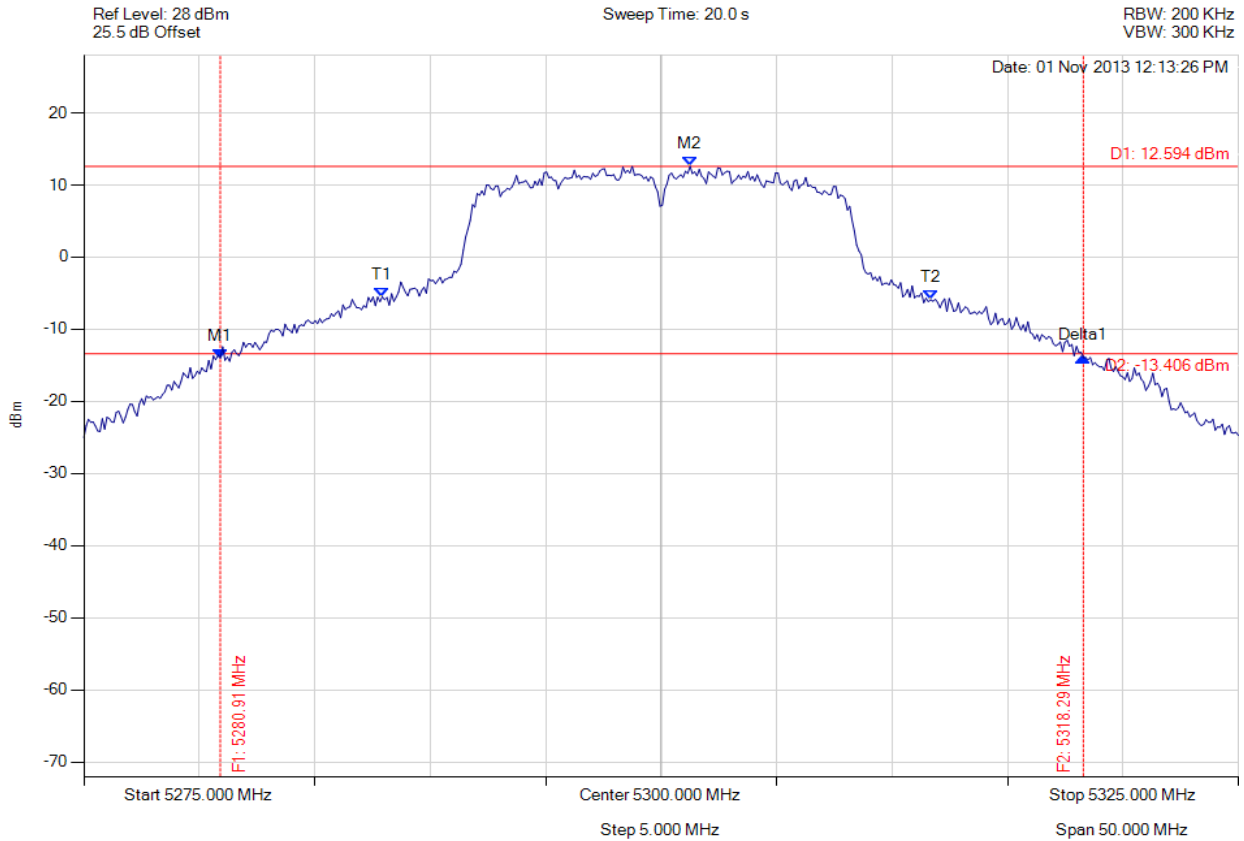

Analyser Setup	Marker : Frequency : Amplitude	Test Results
Detector = MAX PEAK Sweep Count = 0 RF Atten (dB) = 20 Trace Mode = VIEW	M1 : 5280.912 MHz : -14.013 dBm M2 : 5301.253 MHz : 12.594 dBm Delta1 : 37.375 MHz : 0.087 dB T1 : 5287.926 MHz : -5.490 dBm T2 : 5311.673 MHz : -5.907 dBm OBW : 23.747 MHz	Measured 26 dB Bandwidth: 37.375 MHz Measured 99% Bandwidth: 23.747 MHz

[Back to the Matrix](#)

This test report may be reproduced in full only. The document may only be updated by MiCOM Labs personnel. Any changes will be noted in the Document History section of the report.



26 dB & 99% BANDWIDTH

Variant: 802.11a, Channel: 5320.00 MHz, Chain a, Temp: Ambient, Voltage: 3.6 Vdc

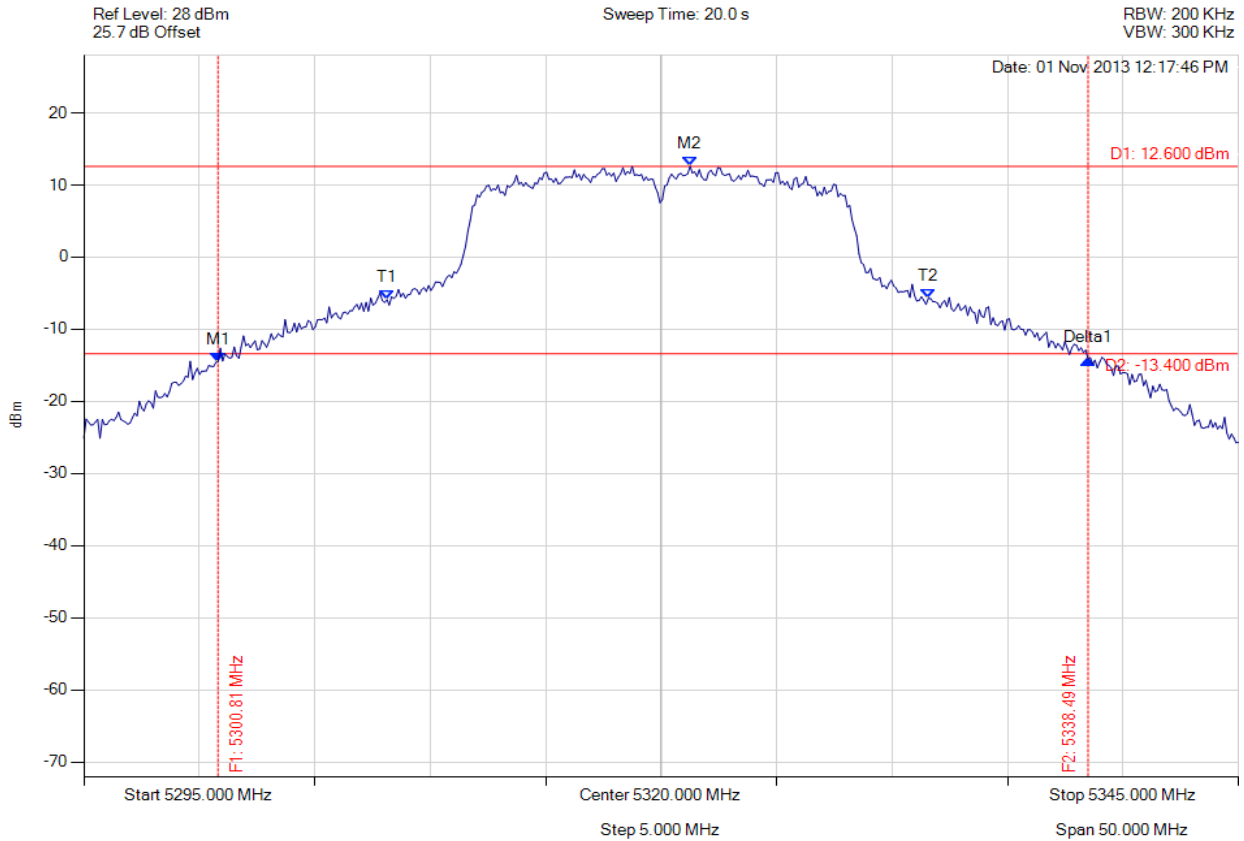

Analyser Setup	Marker : Frequency : Amplitude	Test Results
Detector = MAX PEAK Sweep Count = 0 RF Atten (dB) = 20 Trace Mode = VIEW	M1 : 5300.812 MHz : -14.473 dBm M2 : 5321.253 MHz : 12.600 dBm Delta1 : 37.675 MHz : 0.319 dB T1 : 5308.126 MHz : -5.898 dBm T2 : 5331.573 MHz : -5.707 dBm OBW : 23.447 MHz	Measured 26 dB Bandwidth: 37.675 MHz Measured 99% Bandwidth: 23.447 MHz

[Back to the Matrix](#)

This test report may be reproduced in full only. The document may only be updated by MiCOM Labs personnel. Any changes will be noted in the Document History section of the report.



Title: Spectralink 8753 Enhanced IP Telephone
To: FCC 47 CFR Part 15.407 & IC RSS-210
Serial #: SPEC27-U6 Rev A
Issue Date: 2nd January 2014
Page: 111 of 144



26 dB & 99% BANDWIDTH

Variant: 802.11n HT-20, Channel: 5260.00 MHz, Chain a, Temp: Ambient, Voltage: 3.6 Vdc

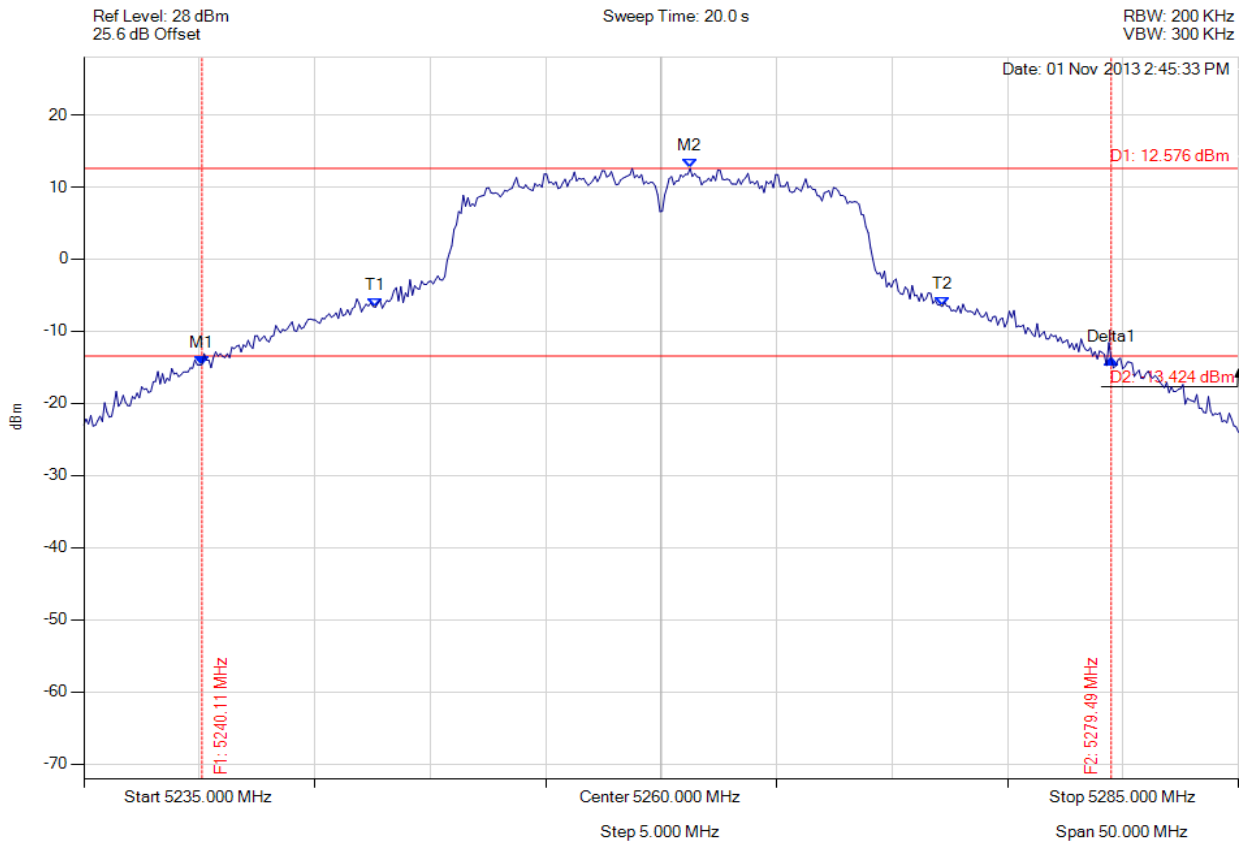

Analyser Setup	Marker : Frequency : Amplitude	Test Results
Detector = MAX PEAK Sweep Count = 0 RF Atten (dB) = 20 Trace Mode = VIEW	M1 : 5240.110 MHz : -14.644 dBm M2 : 5261.253 MHz : 12.576 dBm Delta1 : 39.379 MHz : 0.799 dB T1 : 5247.625 MHz : -6.679 dBm T2 : 5272.174 MHz : -6.568 dBm OBW : 24.549 MHz	Measured 26 dB Bandwidth: 39.379 MHz Measured 99% Bandwidth: 24.549 MHz

[Back to the Matrix](#)

This test report may be reproduced in full only. The document may only be updated by MiCOM Labs personnel. Any changes will be noted in the Document History section of the report.



26 dB & 99% BANDWIDTH

Variant: 802.11n HT-20, Channel: 5300.00 MHz, Chain a, Temp: Ambient, Voltage: 3.6 Vdc

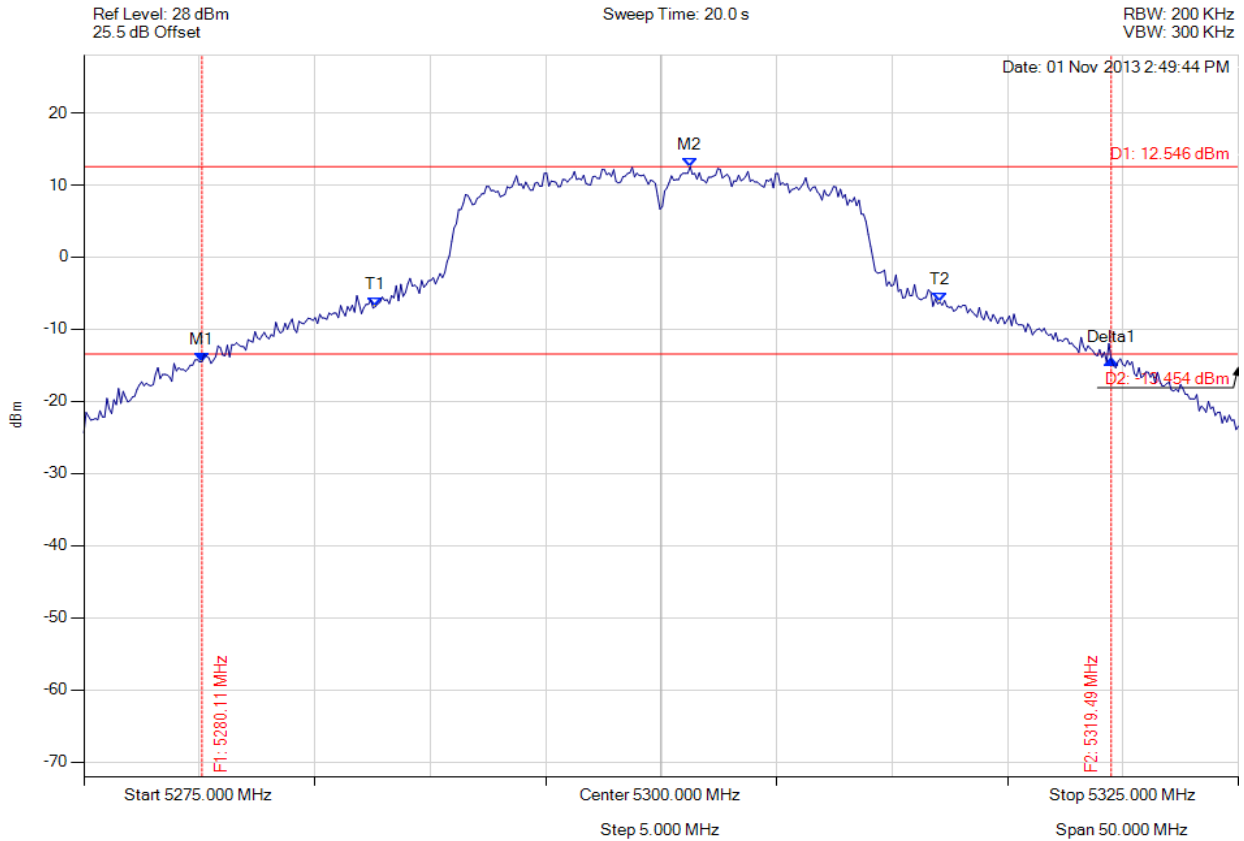

Analyser Setup	Marker : Frequency : Amplitude	Test Results
Detector = MAX PEAK Sweep Count = 0 RF Atten (dB) = 20 Trace Mode = VIEW	M1 : 5280.110 MHz : -14.515 dBm M2 : 5301.253 MHz : 12.546 dBm Delta1 : 39.379 MHz : 0.327 dB T1 : 5287.625 MHz : -6.840 dBm T2 : 5312.074 MHz : -6.238 dBm OBW : 24.449 MHz	Measured 26 dB Bandwidth: 39.379 MHz Measured 99% Bandwidth: 24.449 MHz

[Back to the Matrix](#)

This test report may be reproduced in full only. The document may only be updated by MiCOM Labs personnel. Any changes will be noted in the Document History section of the report.



26 dB & 99% BANDWIDTH

Variant: 802.11n HT-20, Channel: 5320.00 MHz, Chain a, Temp: Ambient, Voltage: 3.6 Vdc

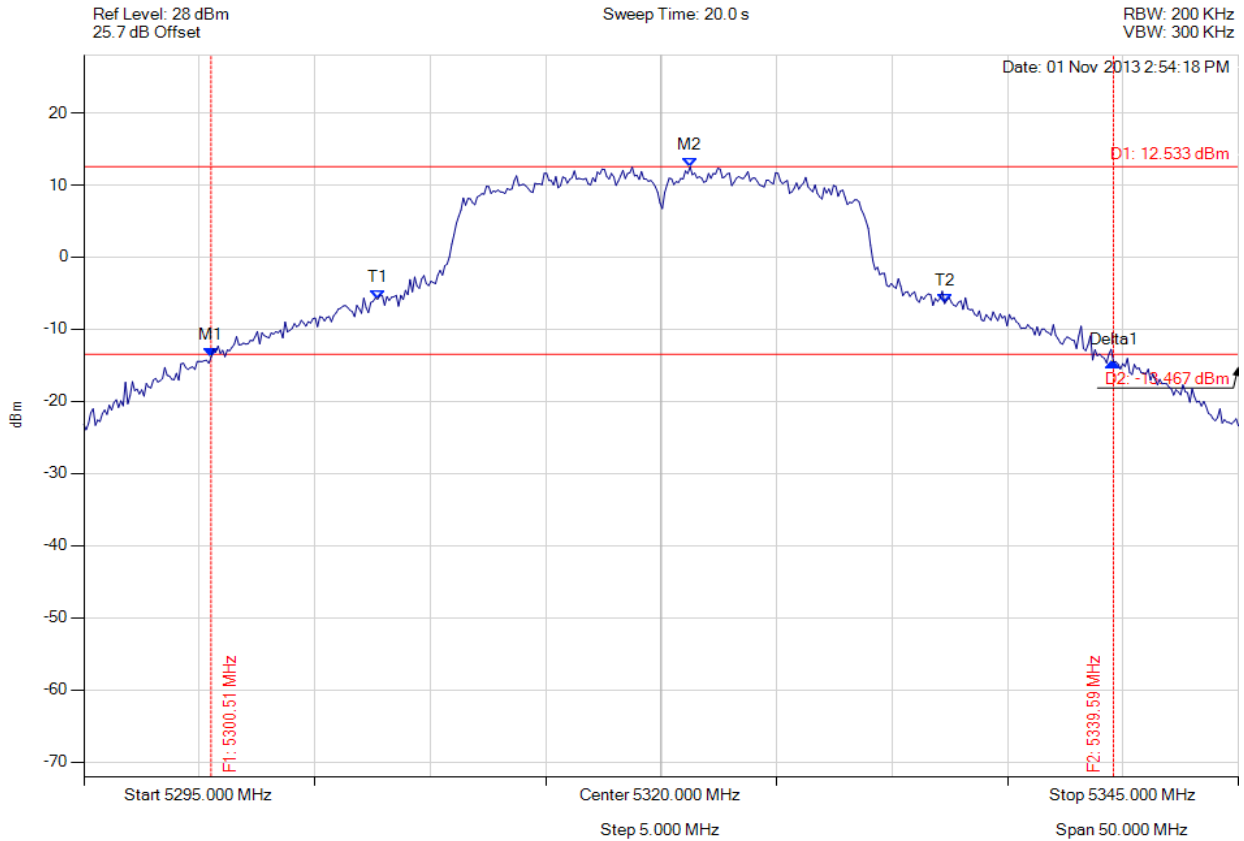

Analyser Setup	Marker : Frequency : Amplitude	Test Results
Detector = MAX PEAK Sweep Count = 0 RF Atten (dB) = 20 Trace Mode = VIEW	M1 : 5300.511 MHz : -13.901 dBm M2 : 5321.253 MHz : 12.533 dBm Delta1 : 39.078 MHz : -0.618 dB T1 : 5307.725 MHz : -5.831 dBm T2 : 5332.275 MHz : -6.448 dBm OBW : 24.549 MHz	Measured 26 dB Bandwidth: 39.078 MHz Measured 99% Bandwidth: 24.549 MHz

[Back to the Matrix](#)

This test report may be reproduced in full only. The document may only be updated by MiCOM Labs personnel. Any changes will be noted in the Document History section of the report.



26 dB & 99% BANDWIDTH

Variant: 802.11a, Channel: 5500.00 MHz, Chain a, Temp: Ambient, Voltage: 3.6 Vdc

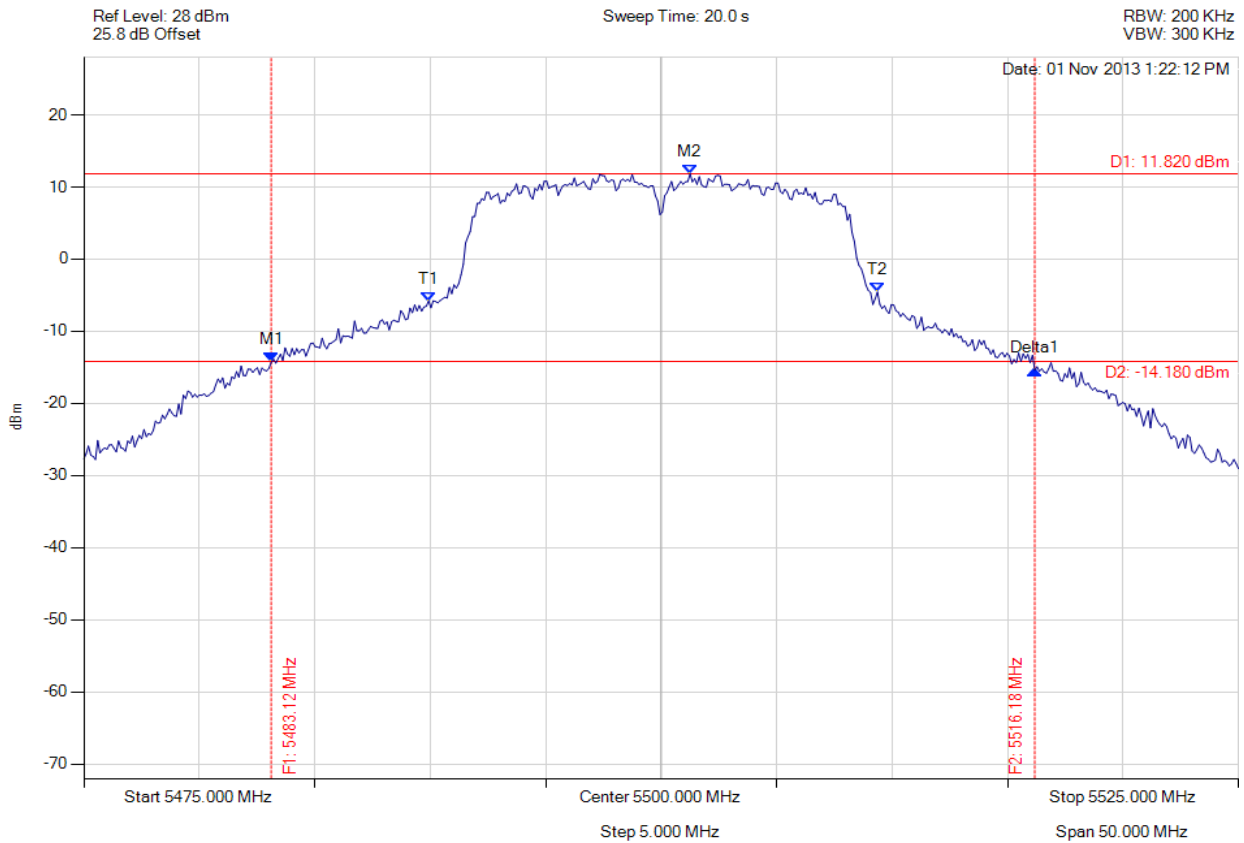

Analyser Setup	Marker : Frequency : Amplitude	Test Results
Detector = MAX PEAK Sweep Count = 0 RF Atten (dB) = 20 Trace Mode = VIEW	M1 : 5483.116 MHz : -14.290 dBm M2 : 5501.253 MHz : 11.820 dBm Delta1 : 33.066 MHz : -1.121 dB T1 : 5489.930 MHz : -5.803 dBm T2 : 5509.369 MHz : -4.554 dBm OBW : 19.439 MHz	Measured 26 dB Bandwidth: 33.066 MHz Measured 99% Bandwidth: 19.439 MHz

[Back to the Matrix](#)

This test report may be reproduced in full only. The document may only be updated by MiCOM Labs personnel. Any changes will be noted in the Document History section of the report.



26 dB & 99% BANDWIDTH

Variant: 802.11a, Channel: 5580.00 MHz, Chain a, Temp: Ambient, Voltage: 3.6 Vdc

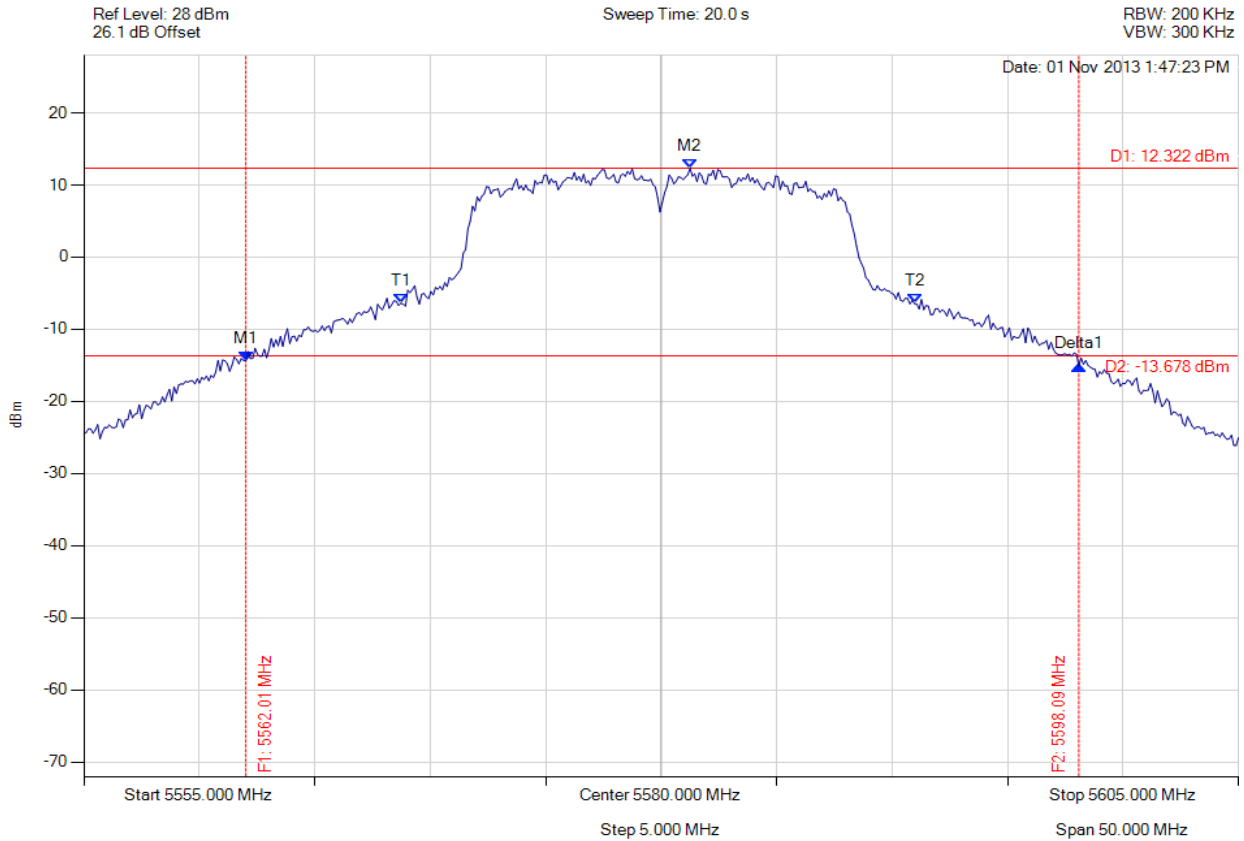

Analyser Setup	Marker : Frequency : Amplitude	Test Results
Detector = MAX PEAK Sweep Count = 0 RF Atten (dB) = 20 Trace Mode = VIEW	M1 : 5562.014 MHz : -14.367 dBm M2 : 5581.253 MHz : 12.322 dBm Delta1 : 36.072 MHz : -0.724 dB T1 : 5568.727 MHz : -6.385 dBm T2 : 5590.972 MHz : -6.431 dBm OBW : 22.244 MHz	Measured 26 dB Bandwidth: 36.072 MHz Measured 99% Bandwidth: 22.244 MHz

[Back to the Matrix](#)

This test report may be reproduced in full only. The document may only be updated by MiCOM Labs personnel. Any changes will be noted in the Document History section of the report.



26 dB & 99% BANDWIDTH

Variant: 802.11a, Channel: 5700.00 MHz, Chain a, Temp: Ambient, Voltage: 3.6 Vdc

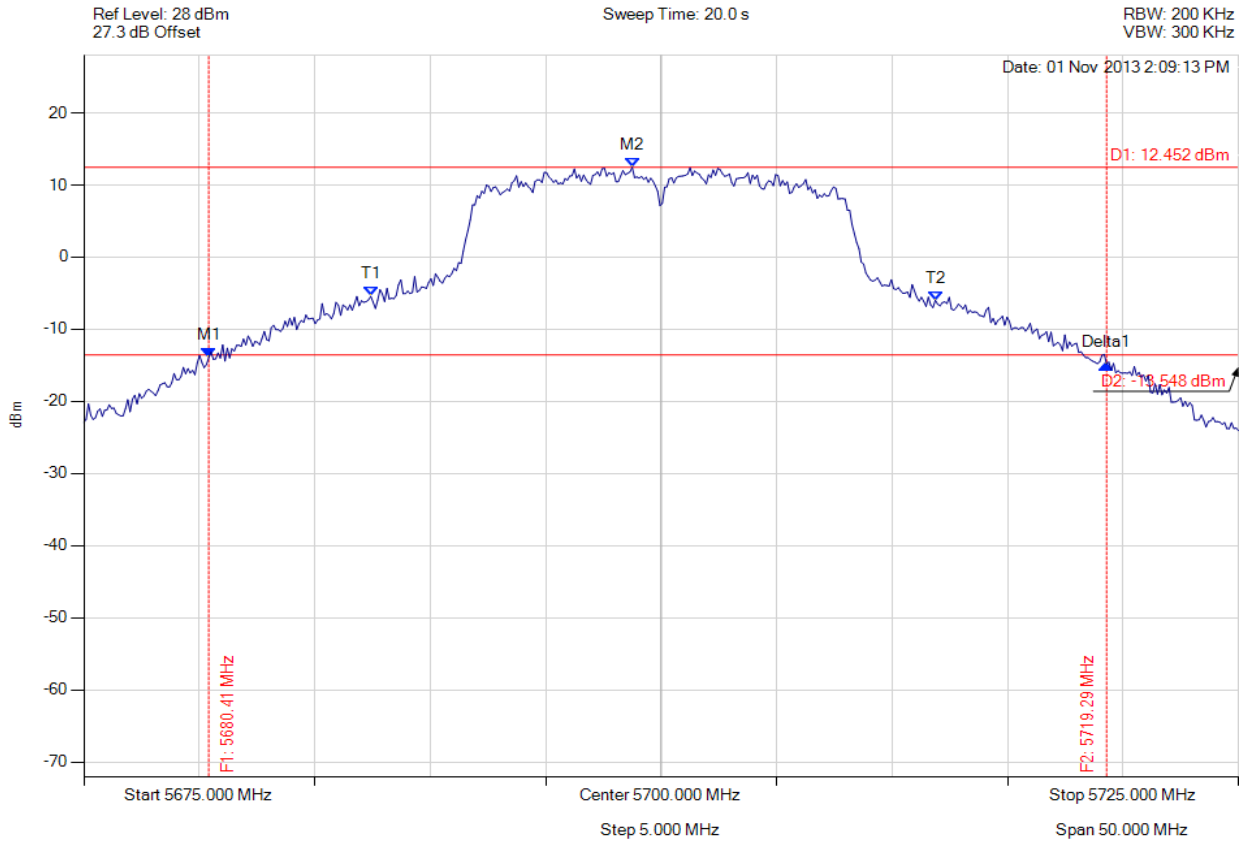

Analyser Setup	Marker : Frequency : Amplitude	Test Results
Detector = MAX PEAK Sweep Count = 0 RF Atten (dB) = 20 Trace Mode = VIEW	M1 : 5680.411 MHz : -13.924 dBm M2 : 5698.747 MHz : 12.452 dBm Delta1 : 38.878 MHz : -0.887 dB T1 : 5687.425 MHz : -5.439 dBm T2 : 5711.874 MHz : -5.980 dBm OBW : 24.449 MHz	Measured 26 dB Bandwidth: 38.878 MHz Measured 99% Bandwidth: 24.449 MHz

[Back to the Matrix](#)

This test report may be reproduced in full only. The document may only be updated by MiCOM Labs personnel. Any changes will be noted in the Document History section of the report.



26 dB & 99% BANDWIDTH

Variant: 802.11n HT-20, Channel: 5500.00 MHz, Chain a, Temp: Ambient, Voltage: 3.6 Vdc

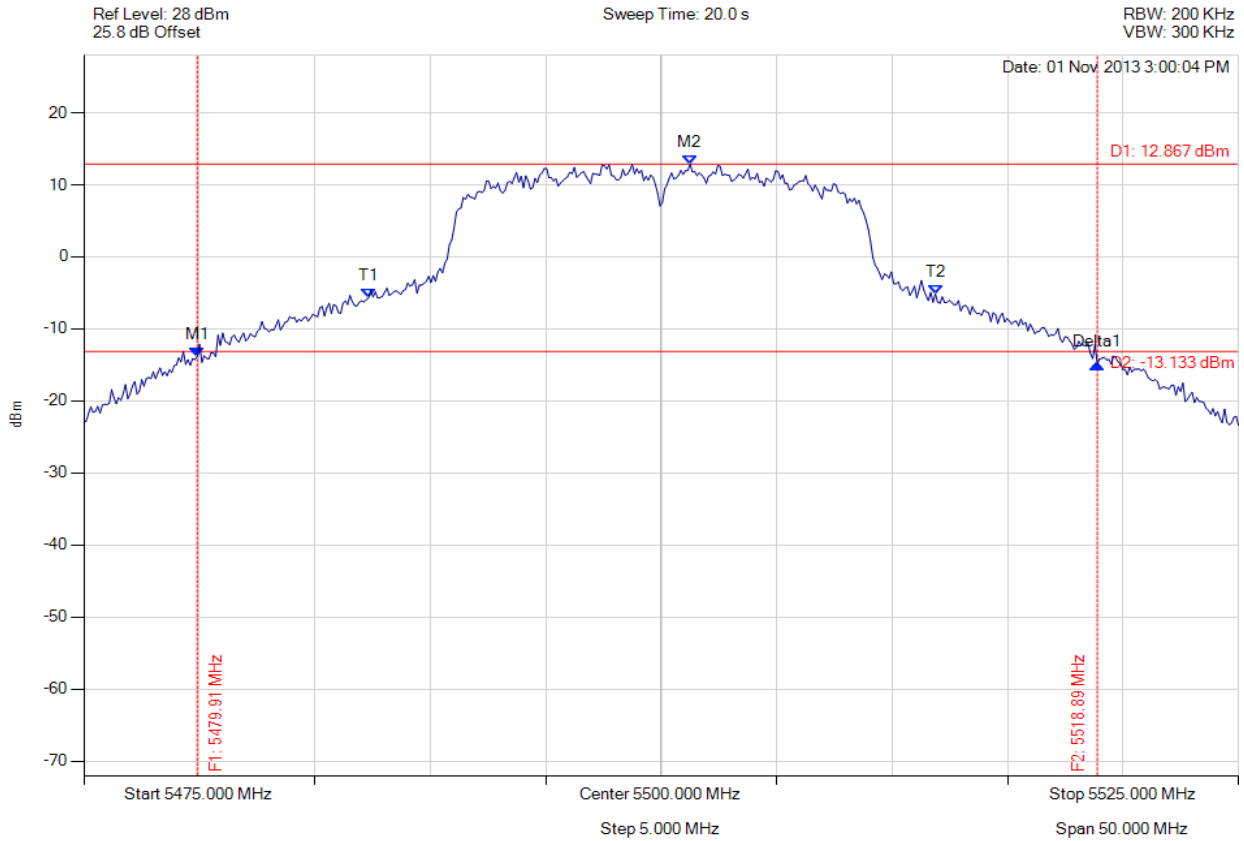

Analyser Setup	Marker : Frequency : Amplitude	Test Results
Detector = MAX PEAK Sweep Count = 0 RF Atten (dB) = 20 Trace Mode = VIEW	M1 : 5479.910 MHz : -13.806 dBm M2 : 5501.253 MHz : 12.867 dBm Delta1 : 38.978 MHz : -1.039 dB T1 : 5487.325 MHz : -5.722 dBm T2 : 5511.874 MHz : -5.140 dBm OBW : 24.549 MHz	Measured 26 dB Bandwidth: 38.978 MHz Measured 99% Bandwidth: 24.549 MHz

[Back to the Matrix](#)

This test report may be reproduced in full only. The document may only be updated by MiCOM Labs personnel. Any changes will be noted in the Document History section of the report.



26 dB & 99% BANDWIDTH

Variant: 802.11n HT-20, Channel: 5580.00 MHz, Chain a, Temp: Ambient, Voltage: 3.6 Vdc

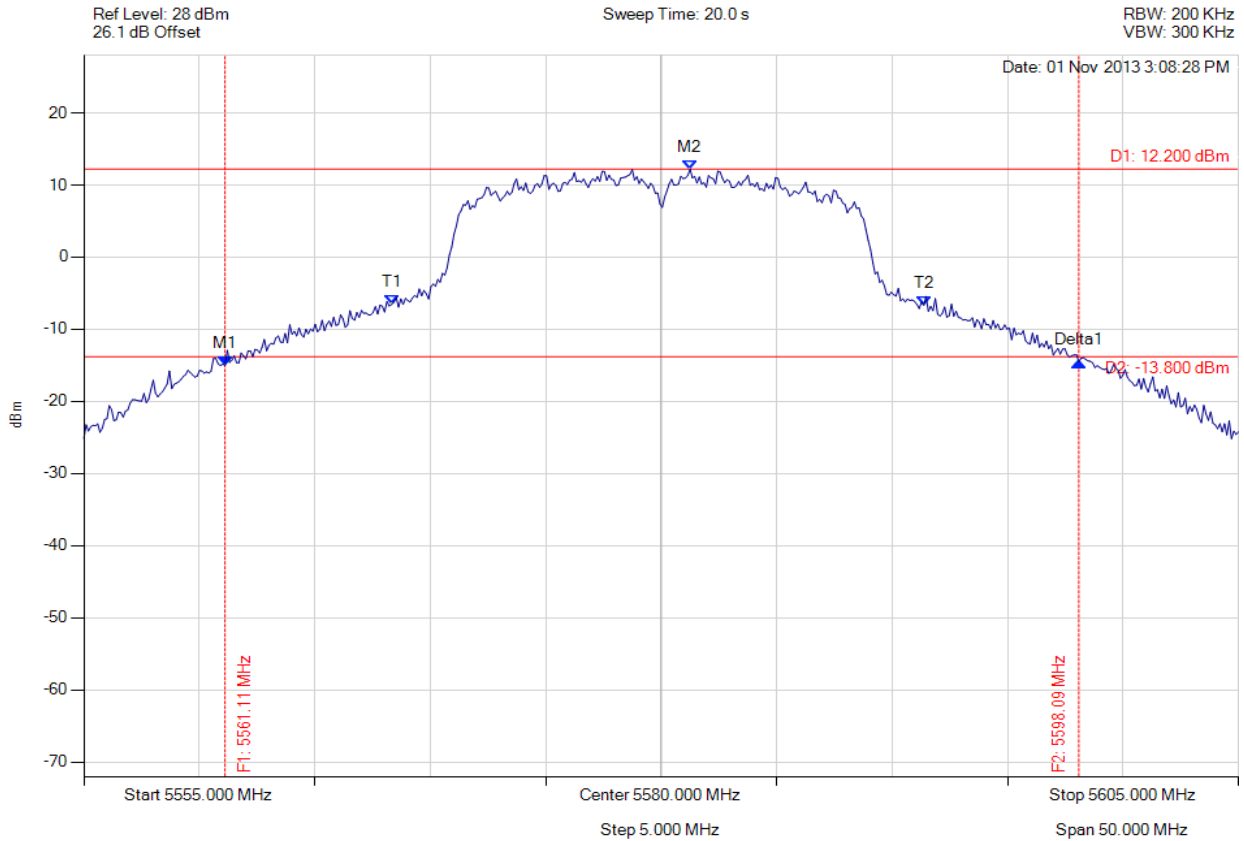

Analyser Setup	Marker : Frequency : Amplitude	Test Results
Detector = MAX PEAK Sweep Count = 0 RF Atten (dB) = 20 Trace Mode = VIEW	M1 : 5561.112 MHz : -15.042 dBm M2 : 5581.253 MHz : 12.200 dBm Delta1 : 36.974 MHz : 0.549 dB T1 : 5568.327 MHz : -6.564 dBm T2 : 5591.373 MHz : -6.677 dBm OBW : 23.046 MHz	Measured 26 dB Bandwidth: 36.974 MHz Measured 99% Bandwidth: 23.046 MHz

[Back to the Matrix](#)

This test report may be reproduced in full only. The document may only be updated by MiCOM Labs personnel. Any changes will be noted in the Document History section of the report.



26 dB & 99% BANDWIDTH

Variant: 802.11n HT-20, Channel: 5700.00 MHz, Chain a, Temp: Ambient, Voltage: 3.6 Vdc

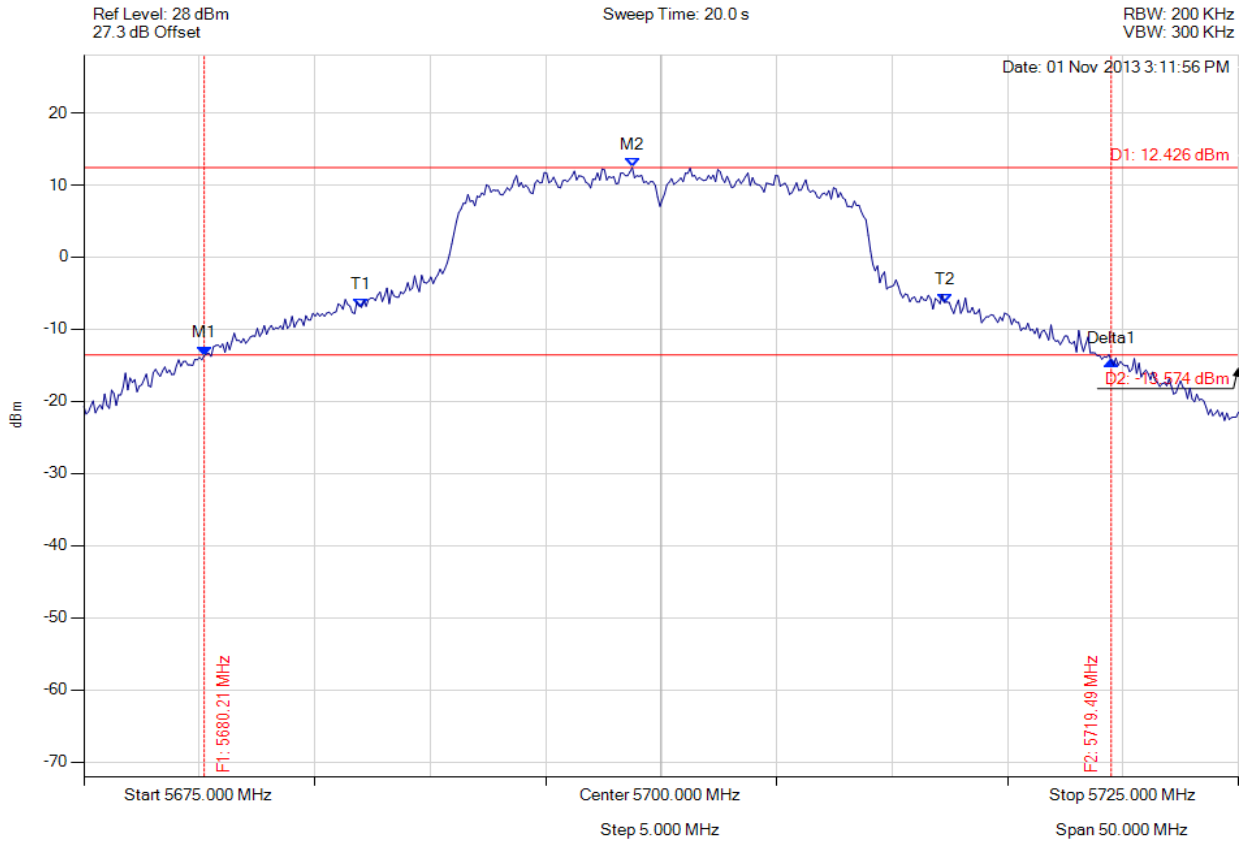

Analyser Setup	Marker : Frequency : Amplitude	Test Results
Detector = MAX PEAK Sweep Count = 0 RF Atten (dB) = 20 Trace Mode = VIEW	M1 : 5680.210 MHz : -13.635 dBm M2 : 5698.747 MHz : 12.426 dBm Delta1 : 39.279 MHz : -0.708 dB T1 : 5687.024 MHz : -6.962 dBm T2 : 5712.275 MHz : -6.289 dBm OBW : 25.251 MHz	Measured 26 dB Bandwidth: 39.279 MHz Measured 99% Bandwidth: 25.251 MHz

[Back to the Matrix](#)

This test report may be reproduced in full only. The document may only be updated by MiCOM Labs personnel. Any changes will be noted in the Document History section of the report.



A.1.2. Peak Power Spectral Density



PEAK POWER SPECTRAL DENSITY

Variant: 802.11a, Channel: 5180.00 MHz, Chain a, Temp: Ambient, Voltage: 3.6 Vdc

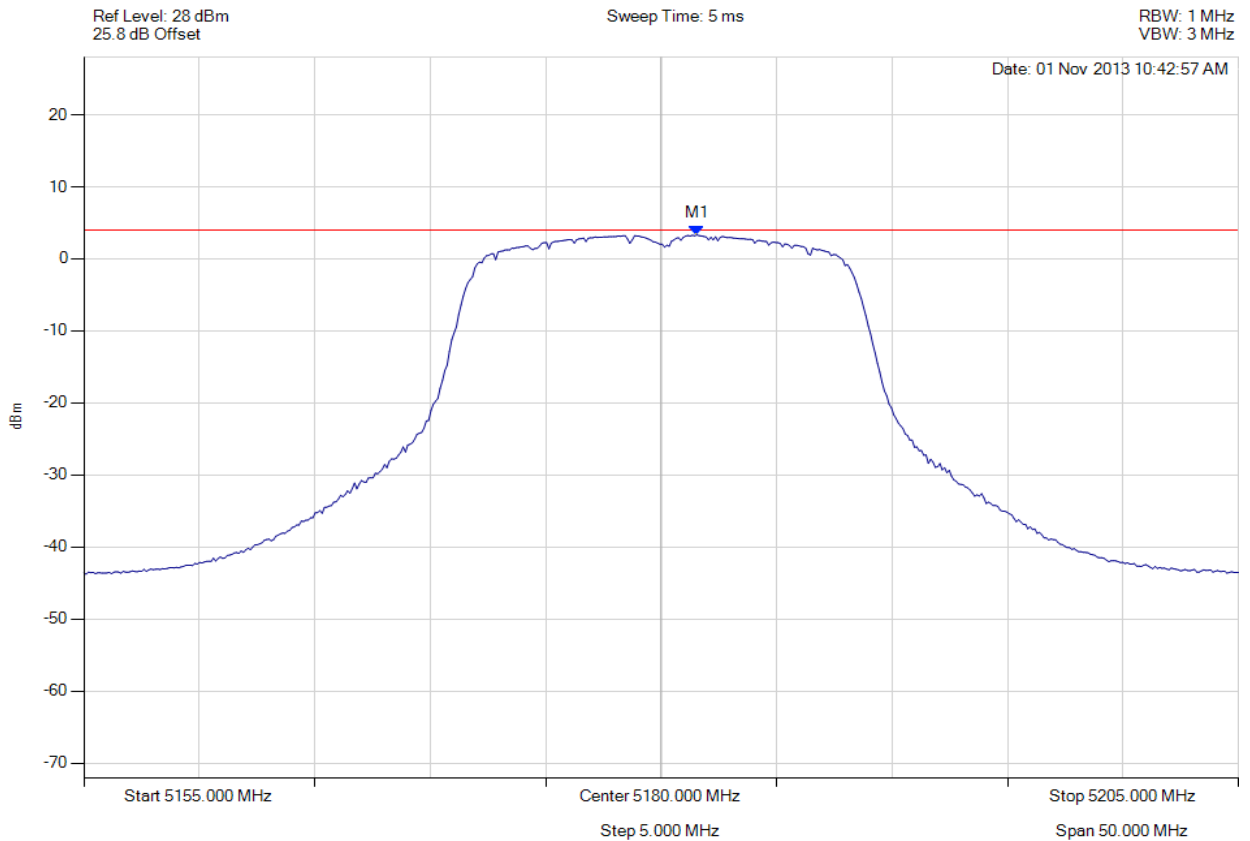

Analyser Setup	Marker : Frequency : Amplitude	Test Results
Detector = RMS Sweep Count = 100 RF Atten (dB) = 20 Trace Mode = VIEW	M1 : 5181.553 MHz : 3.321 dBm	Limit: ≤ 4.000 dBm Margin: -0.68 dB

[Back to the Matrix](#)

This test report may be reproduced in full only. The document may only be updated by MiCOM Labs personnel. Any changes will be noted in the Document History section of the report.



PEAK POWER SPECTRAL DENSITY

Variant: 802.11a, Channel: 5200.00 MHz, Chain a, Temp: Ambient, Voltage: 3.6 Vdc

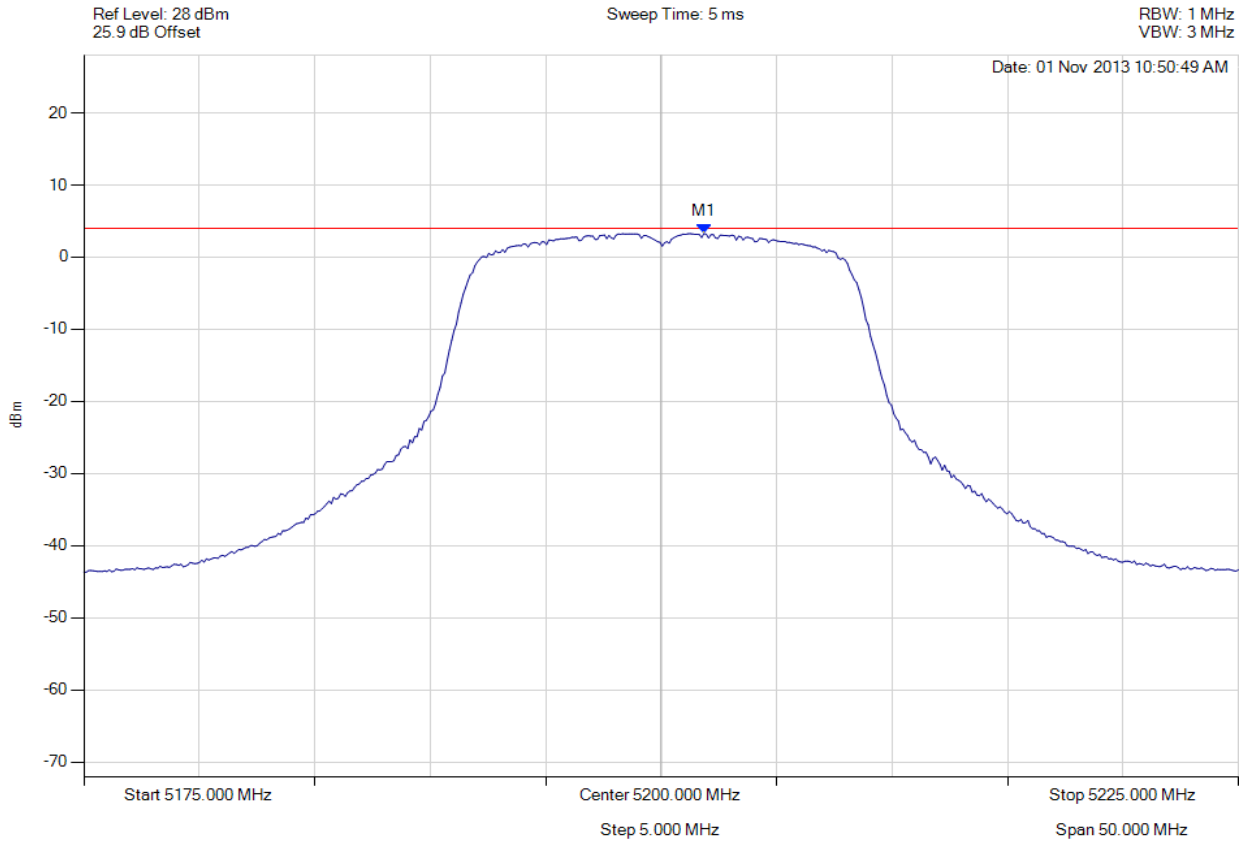

Analyser Setup	Marker : Frequency : Amplitude	Test Results
Detector = RMS Sweep Count = 100 RF Atten (dB) = 20 Trace Mode = VIEW	M1 : 5201.854 MHz : 3.274 dBm	Limit: ≤ 4.000 dBm Margin: -0.73 dB

[Back to the Matrix](#)

This test report may be reproduced in full only. The document may only be updated by MiCOM Labs personnel. Any changes will be noted in the Document History section of the report.



Title: Spectralink 8753 Enhanced IP Telephone
To: FCC 47 CFR Part 15.407 & IC RSS-210
Serial #: SPEC27-U6 Rev A
Issue Date: 2nd January 2014
Page: 122 of 144



PEAK POWER SPECTRAL DENSITY

Variant: 802.11a, Channel: 5240.00 MHz, Chain a, Temp: Ambient, Voltage: 3.6 Vdc

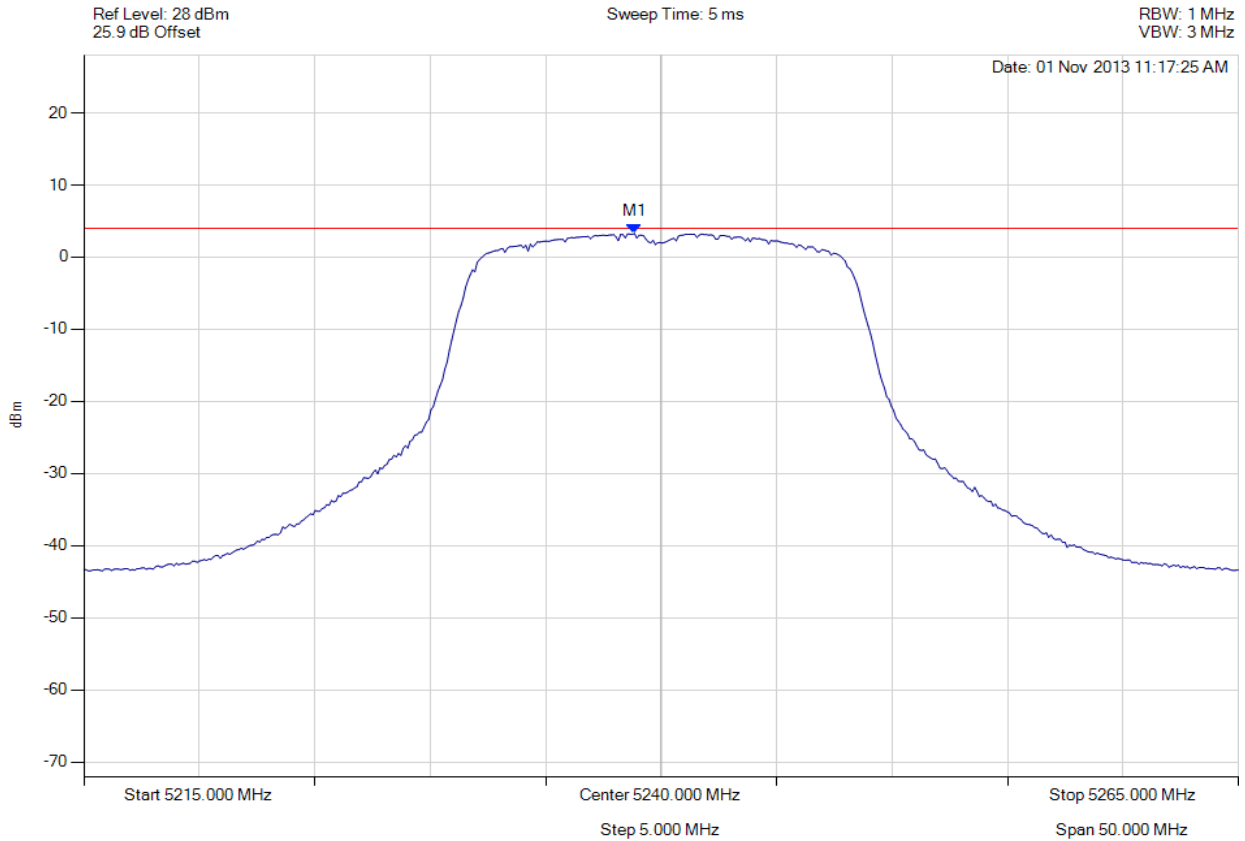

Analyser Setup	Marker : Frequency : Amplitude	Test Results
Detector = RMS Sweep Count = 100 RF Atten (dB) = 20 Trace Mode = VIEW	M1 : 5238.848 MHz : 3.266 dBm	Limit: ≤ 4.000 dBm Margin: -0.73 dB

[Back to the Matrix](#)

This test report may be reproduced in full only. The document may only be updated by MiCOM Labs personnel. Any changes will be noted in the Document History section of the report.



Title: Spectralink 8753 Enhanced IP Telephone
To: FCC 47 CFR Part 15.407 & IC RSS-210
Serial #: SPEC27-U6 Rev A
Issue Date: 2nd January 2014
Page: 123 of 144



PEAK POWER SPECTRAL DENSITY

Variant: 802.11n HT-20, Channel: 5180.00 MHz, Chain a, Temp: Ambient, Voltage: 3.6 Vdc

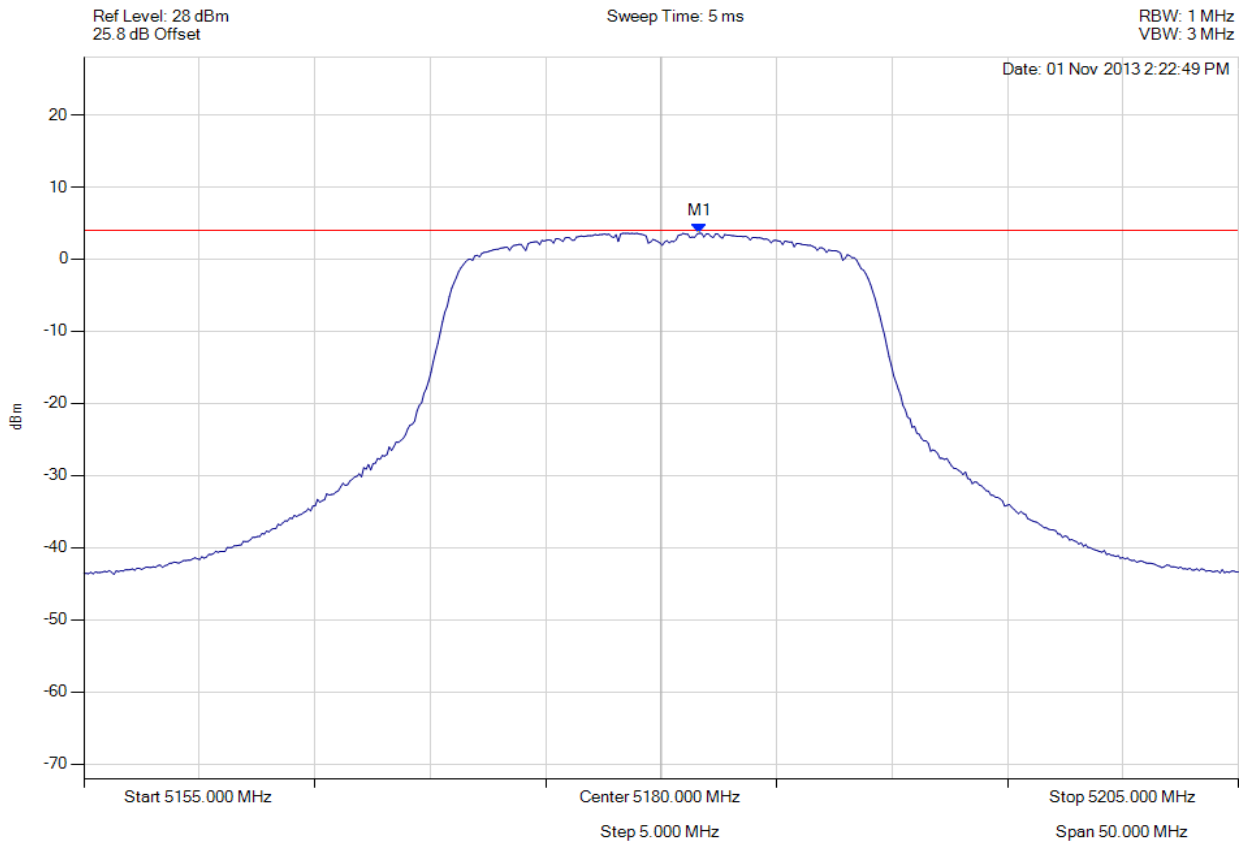

Analyser Setup	Marker : Frequency : Amplitude	Test Results
Detector = RMS Sweep Count = 100 RF Atten (dB) = 20 Trace Mode = VIEW	M1 : 5181.653 MHz : 3.591 dBm	Limit: ≤ 4.000 dBm Margin: -0.41 dB

[Back to the Matrix](#)

This test report may be reproduced in full only. The document may only be updated by MiCOM Labs personnel. Any changes will be noted in the Document History section of the report.



Title: Spectralink 8753 Enhanced IP Telephone
To: FCC 47 CFR Part 15.407 & IC RSS-210
Serial #: SPEC27-U6 Rev A
Issue Date: 2nd January 2014
Page: 124 of 144



PEAK POWER SPECTRAL DENSITY

Variant: 802.11n HT-20, Channel: 5200.00 MHz, Chain a, Temp: Ambient, Voltage: 3.6 Vdc

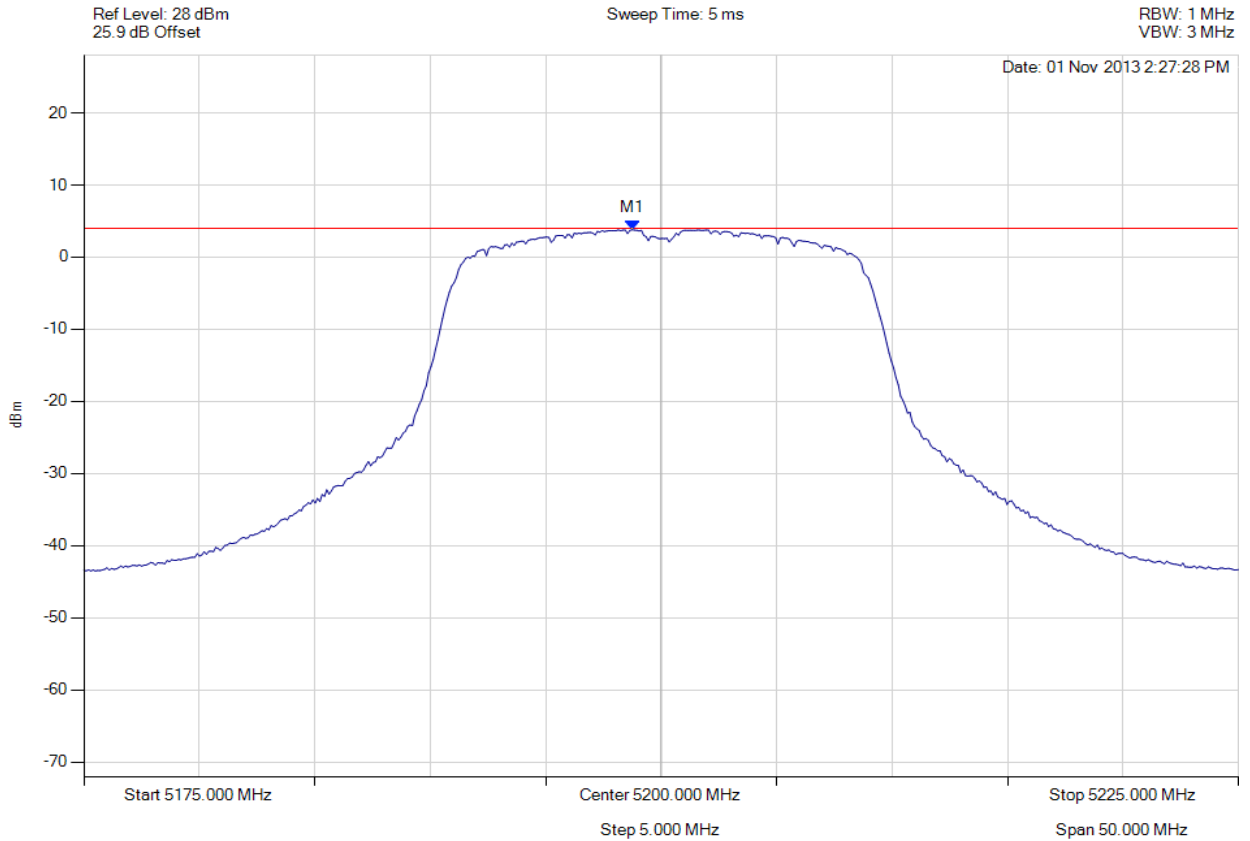

Analyser Setup	Marker : Frequency : Amplitude	Test Results
Detector = RMS Sweep Count = 100 RF Atten (dB) = 20 Trace Mode = VIEW	M1 : 5198.747 MHz : 3.787 dBm	Limit: ≤ 4.000 dBm Margin: -0.21 dB

[Back to the Matrix](#)

This test report may be reproduced in full only. The document may only be updated by MiCOM Labs personnel. Any changes will be noted in the Document History section of the report.



PEAK POWER SPECTRAL DENSITY

Variant: 802.11n HT-20, Channel: 5240.00 MHz, Chain a, Temp: Ambient, Voltage: 3.6 Vdc

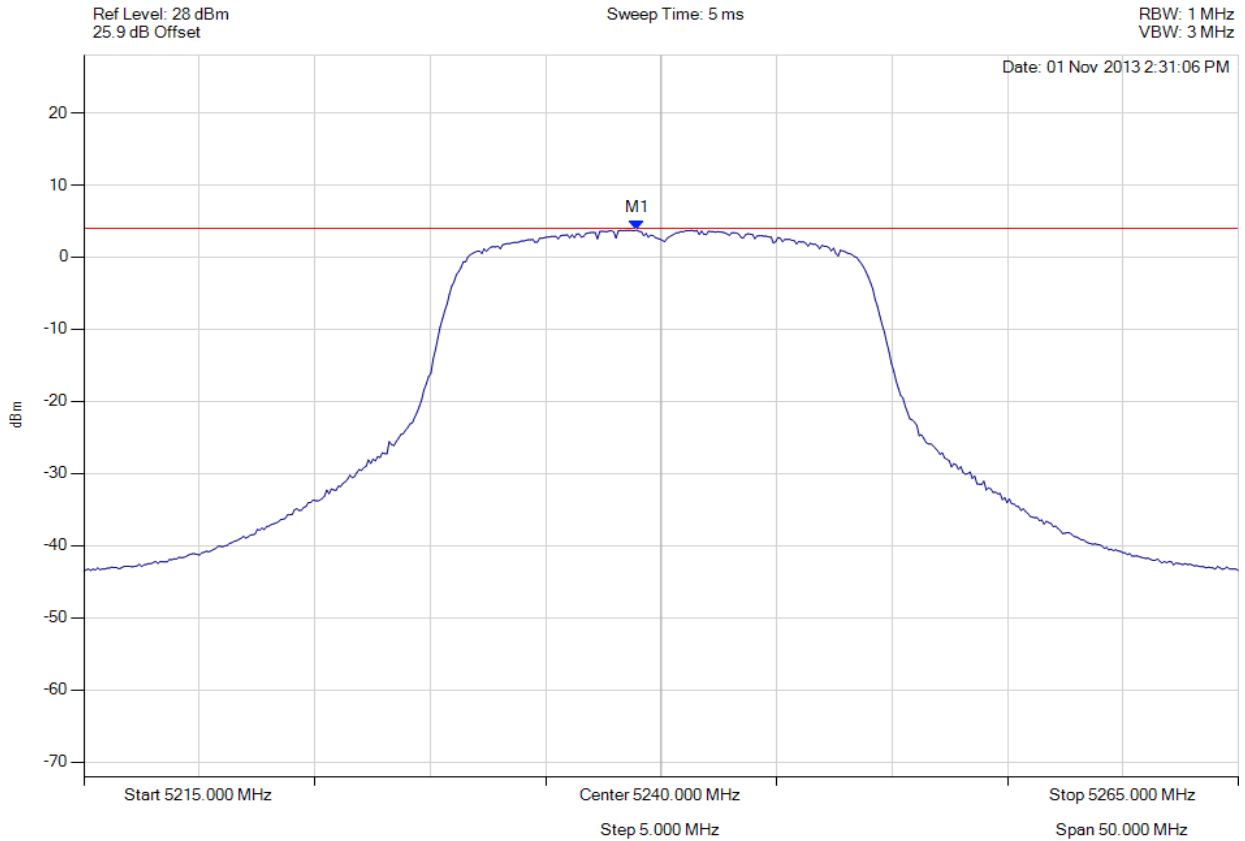

Analyser Setup	Marker : Frequency : Amplitude	Test Results
Detector = RMS Sweep Count = 100 RF Atten (dB) = 20 Trace Mode = VIEW	M1 : 5238.948 MHz : 3.747 dBm	Limit: ≤ 4.000 dBm Margin: -0.25 dB

[Back to the Matrix](#)

This test report may be reproduced in full only. The document may only be updated by MiCOM Labs personnel. Any changes will be noted in the Document History section of the report.



Title: Spectralink 8753 Enhanced IP Telephone
To: FCC 47 CFR Part 15.407 & IC RSS-210
Serial #: SPEC27-U6 Rev A
Issue Date: 2nd January 2014
Page: 126 of 144



PEAK POWER SPECTRAL DENSITY

Variant: 802.11a, Channel: 5260.00 MHz, Chain a, Temp: Ambient, Voltage: 3.6 Vdc

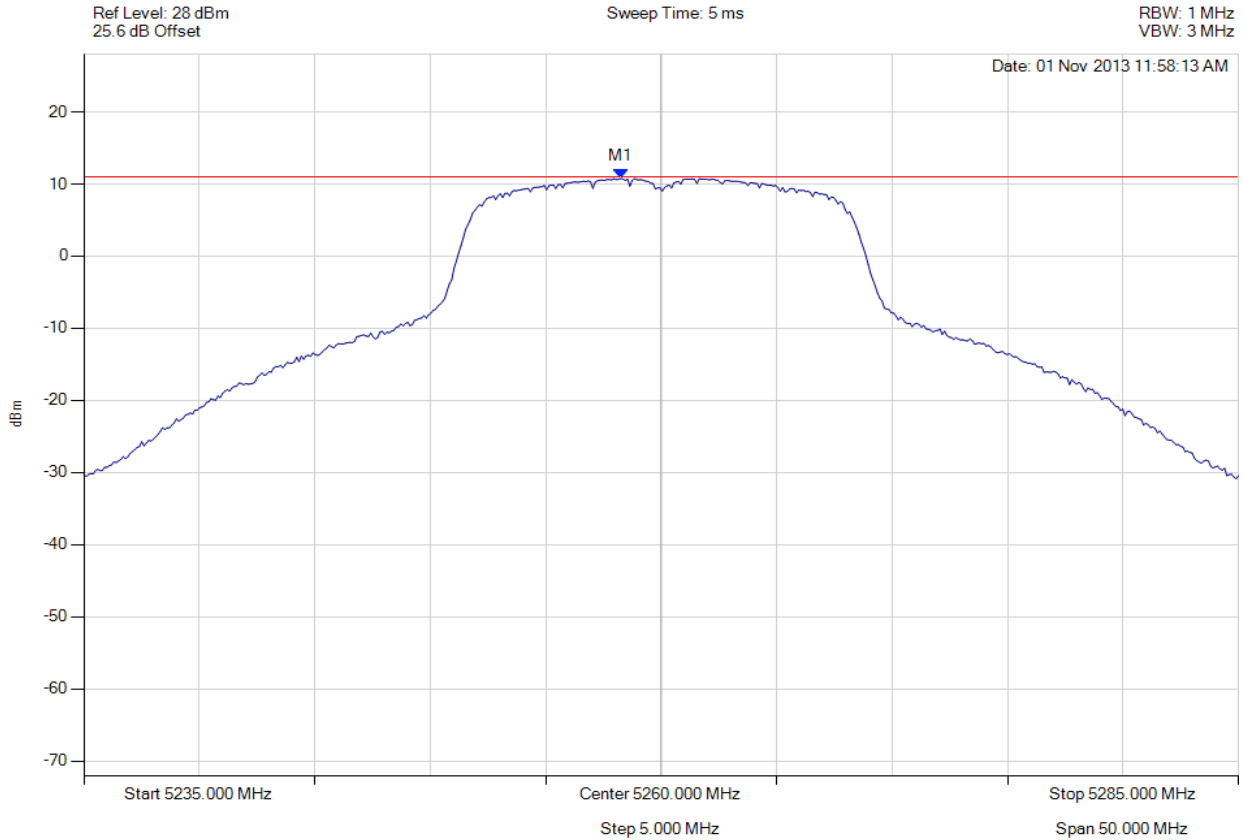

Analyser Setup	Marker : Frequency : Amplitude	Test Results
Detector = RMS Sweep Count = 100 RF Atten (dB) = 20 Trace Mode = VIEW	M1 : 5258.246 MHz : 10.760 dBm	Limit: ≤ 11.000 dBm Margin: -0.24 dB

[Back to the Matrix](#)

This test report may be reproduced in full only. The document may only be updated by MiCOM Labs personnel. Any changes will be noted in the Document History section of the report.



Title: Spectralink 8753 Enhanced IP Telephone
To: FCC 47 CFR Part 15.407 & IC RSS-210
Serial #: SPEC27-U6 Rev A
Issue Date: 2nd January 2014
Page: 127 of 144



PEAK POWER SPECTRAL DENSITY

Variant: 802.11a, Channel: 5300.00 MHz, Chain a, Temp: Ambient, Voltage: 3.6 Vdc

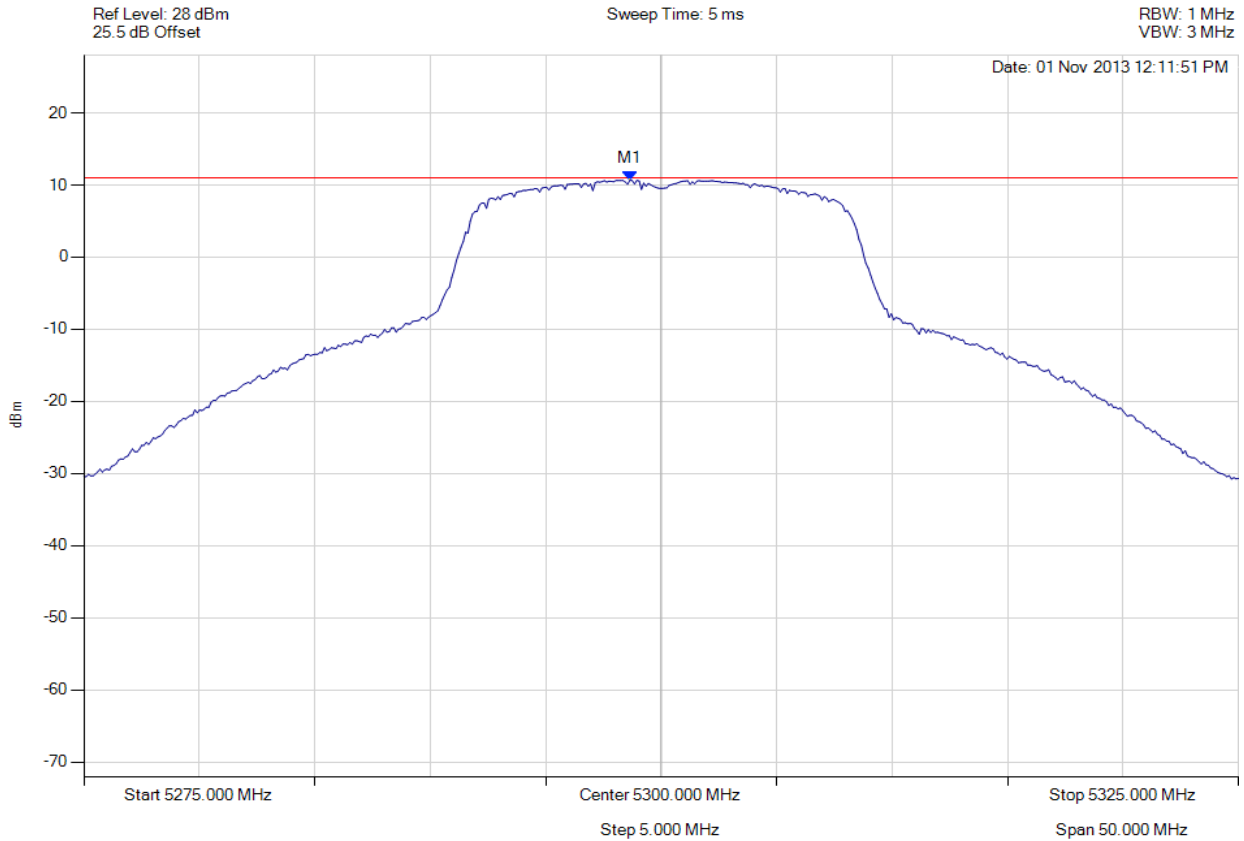

Analyser Setup	Marker : Frequency : Amplitude	Test Results
Detector = RMS Sweep Count = 100 RF Atten (dB) = 20 Trace Mode = VIEW	M1 : 5298.647 MHz : 10.675 dBm	Limit: ≤ 11.000 dBm Margin: -0.32 dB

[Back to the Matrix](#)

This test report may be reproduced in full only. The document may only be updated by MiCOM Labs personnel. Any changes will be noted in the Document History section of the report.



PEAK POWER SPECTRAL DENSITY

Variant: 802.11a, Channel: 5320.00 MHz, Chain a, Temp: Ambient, Voltage: 3.6 Vdc

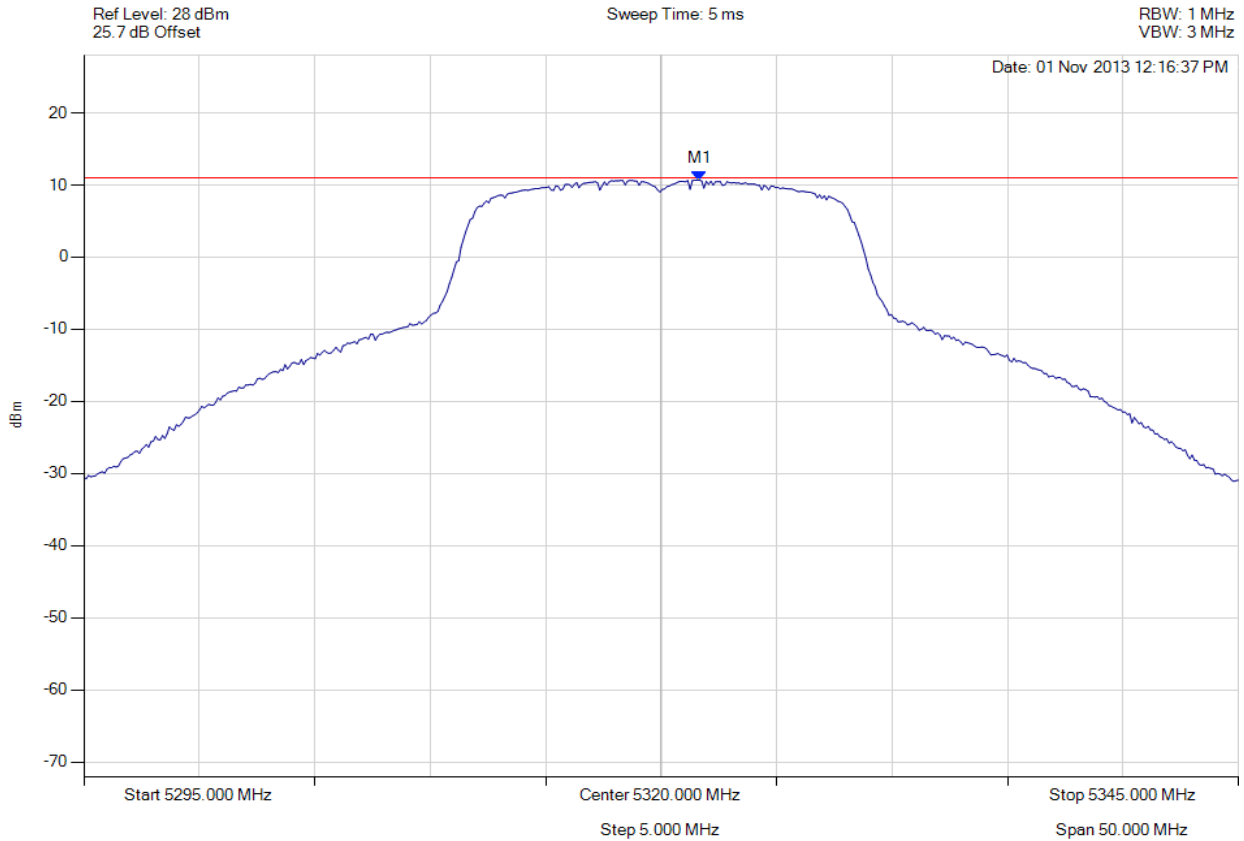

Analyser Setup	Marker : Frequency : Amplitude	Test Results
Detector = RMS Sweep Count = 100 RF Atten (dB) = 20 Trace Mode = VIEW	M1 : 5321.653 MHz : 10.695 dBm	Limit: ≤ 11.000 dBm Margin: -0.30 dB

[Back to the Matrix](#)

This test report may be reproduced in full only. The document may only be updated by MiCOM Labs personnel. Any changes will be noted in the Document History section of the report.



Title: Spectralink 8753 Enhanced IP Telephone
To: FCC 47 CFR Part 15.407 & IC RSS-210
Serial #: SPEC27-U6 Rev A
Issue Date: 2nd January 2014
Page: 129 of 144



PEAK POWER SPECTRAL DENSITY

Variant: 802.11n HT-20, Channel: 5260.00 MHz, Chain a, Temp: Ambient, Voltage: 3.6 Vdc

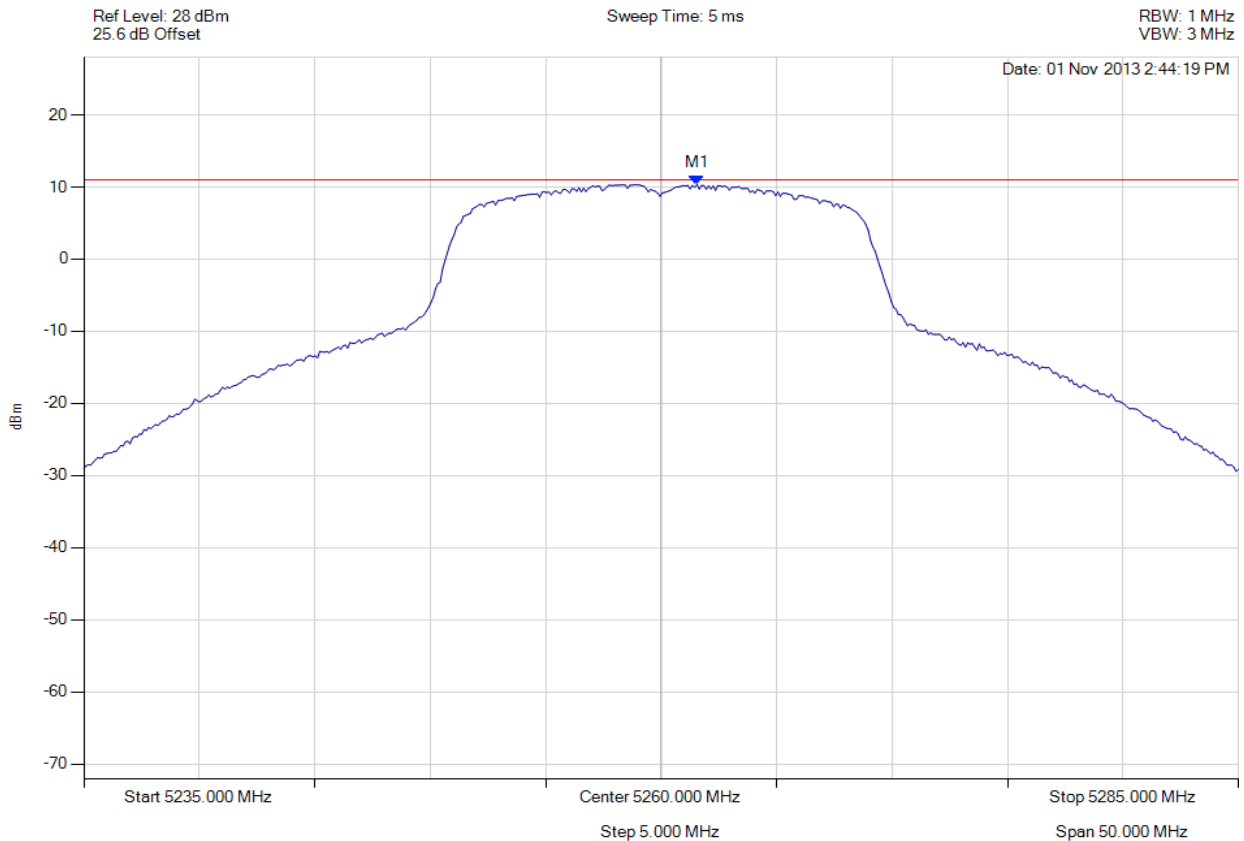

Analyser Setup	Marker : Frequency : Amplitude	Test Results
Detector = RMS Sweep Count = 100 RF Atten (dB) = 20 Trace Mode = VIEW	M1 : 5261.553 MHz : 10.376 dBm	Limit: ≤ 11.000 dBm Margin: -0.62 dB

[Back to the Matrix](#)

This test report may be reproduced in full only. The document may only be updated by MiCOM Labs personnel. Any changes will be noted in the Document History section of the report.



PEAK POWER SPECTRAL DENSITY

Variant: 802.11n HT-20, Channel: 5300.00 MHz, Chain a, Temp: Ambient, Voltage: 3.6 Vdc

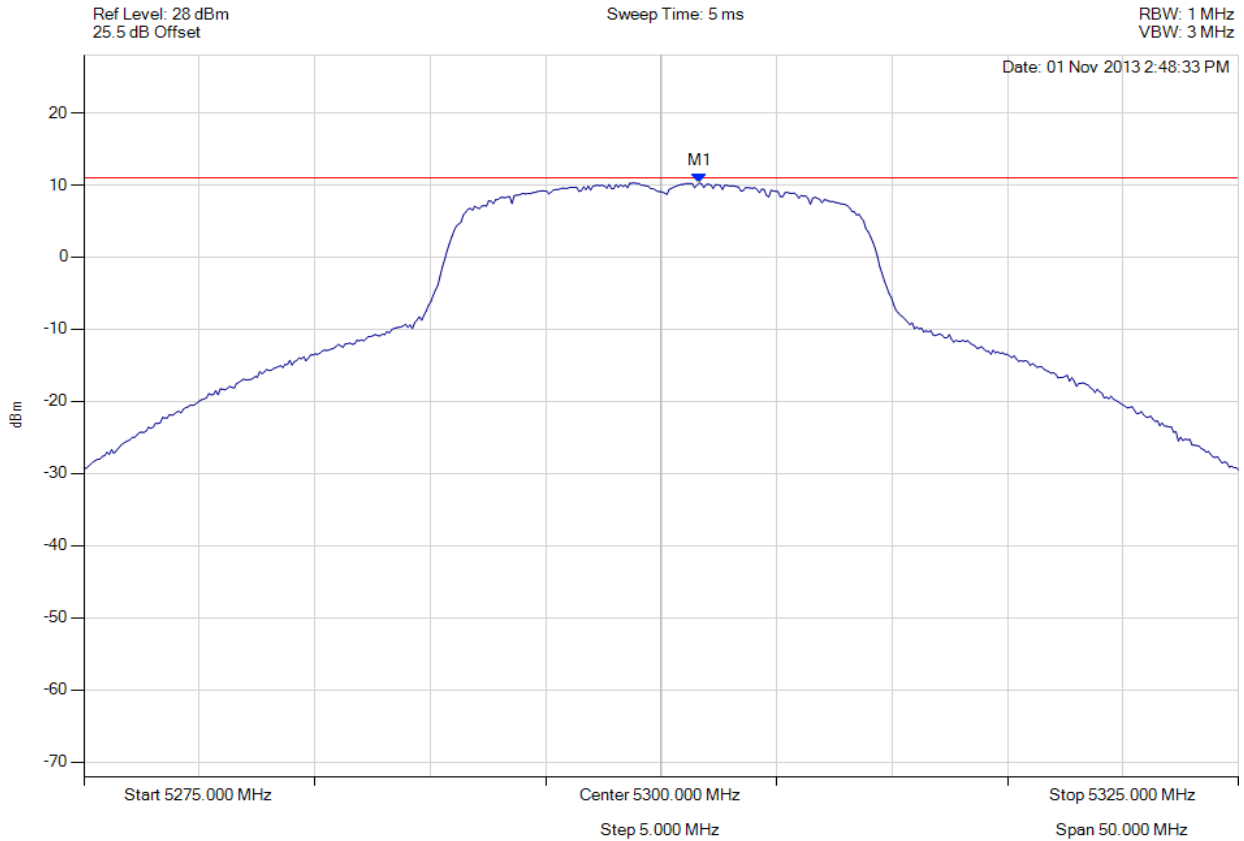

Analyser Setup	Marker : Frequency : Amplitude	Test Results
Detector = RMS Sweep Count = 100 RF Atten (dB) = 20 Trace Mode = VIEW	M1 : 5301.653 MHz : 10.310 dBm	Limit: ≤ 11.000 dBm Margin: -0.69 dB

[Back to the Matrix](#)

This test report may be reproduced in full only. The document may only be updated by MiCOM Labs personnel. Any changes will be noted in the Document History section of the report.



PEAK POWER SPECTRAL DENSITY

Variant: 802.11n HT-20, Channel: 5320.00 MHz, Chain a, Temp: Ambient, Voltage: 3.6 Vdc

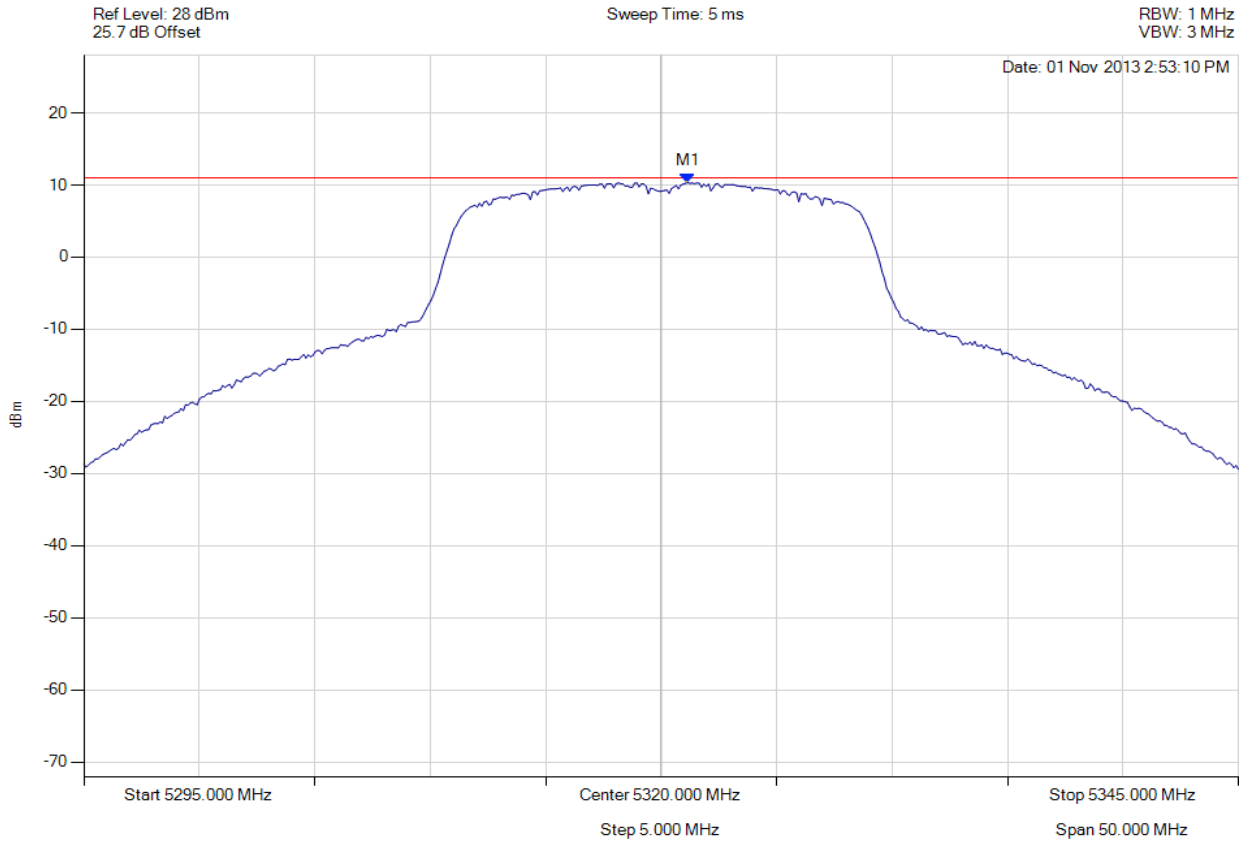

Analyser Setup	Marker : Frequency : Amplitude	Test Results
Detector = RMS Sweep Count = 100 RF Atten (dB) = 20 Trace Mode = VIEW	M1 : 5321.152 MHz : 10.324 dBm	Limit: ≤ 11.000 dBm Margin: -0.68 dB

[Back to the Matrix](#)

This test report may be reproduced in full only. The document may only be updated by MiCOM Labs personnel. Any changes will be noted in the Document History section of the report.



Title: Spectralink 8753 Enhanced IP Telephone
To: FCC 47 CFR Part 15.407 & IC RSS-210
Serial #: SPEC27-U6 Rev A
Issue Date: 2nd January 2014
Page: 132 of 144



PEAK POWER SPECTRAL DENSITY

Variant: 802.11a, Channel: 5500.00 MHz, Chain a, Temp: Ambient, Voltage: 3.6 Vdc

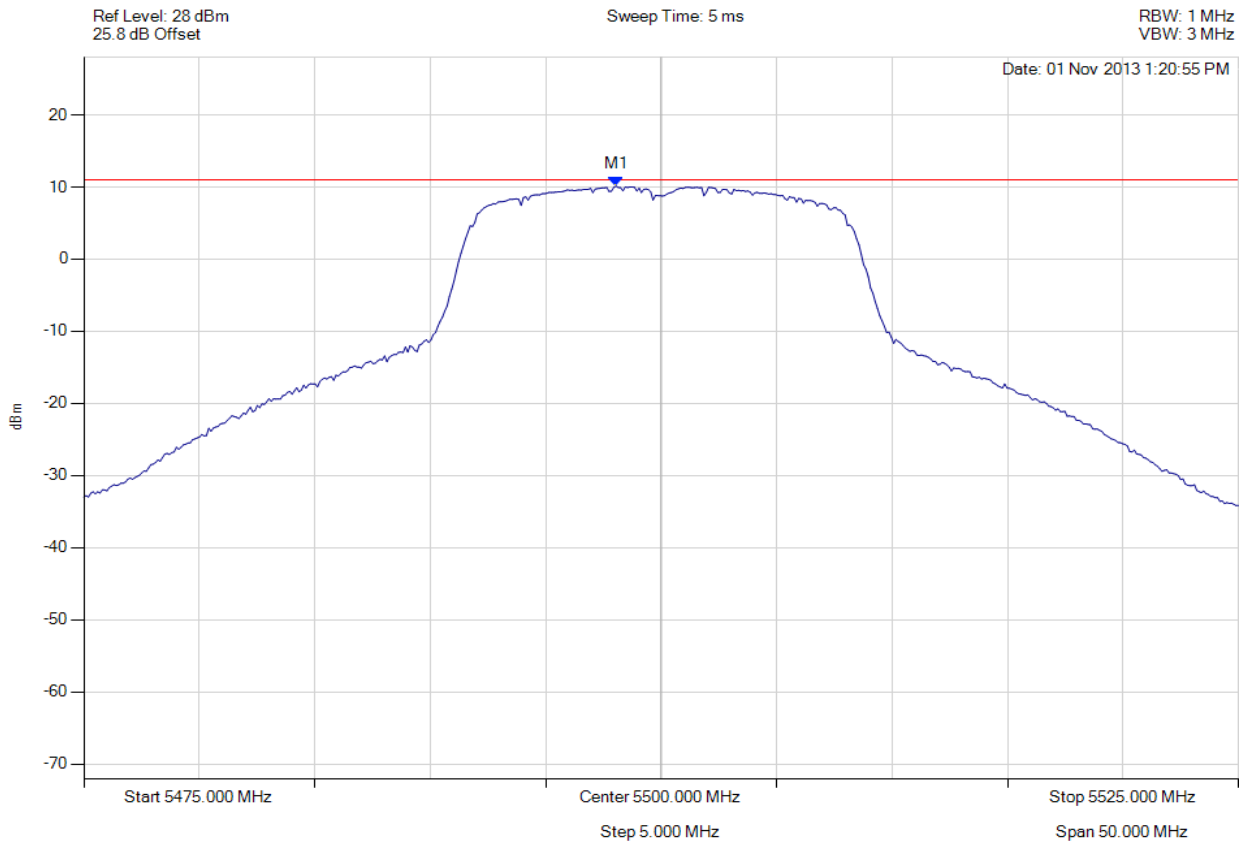

Analyser Setup	Marker : Frequency : Amplitude	Test Results
Detector = RMS Sweep Count = 100 RF Atten (dB) = 20 Trace Mode = VIEW	M1 : 5498.046 MHz : 10.124 dBm	Limit: ≤ 11.000 dBm Margin: -0.88 dB

[Back to the Matrix](#)

This test report may be reproduced in full only. The document may only be updated by MiCOM Labs personnel. Any changes will be noted in the Document History section of the report.



PEAK POWER SPECTRAL DENSITY

Variant: 802.11a, Channel: 5580.00 MHz, Chain a, Temp: Ambient, Voltage: 3.6 Vdc

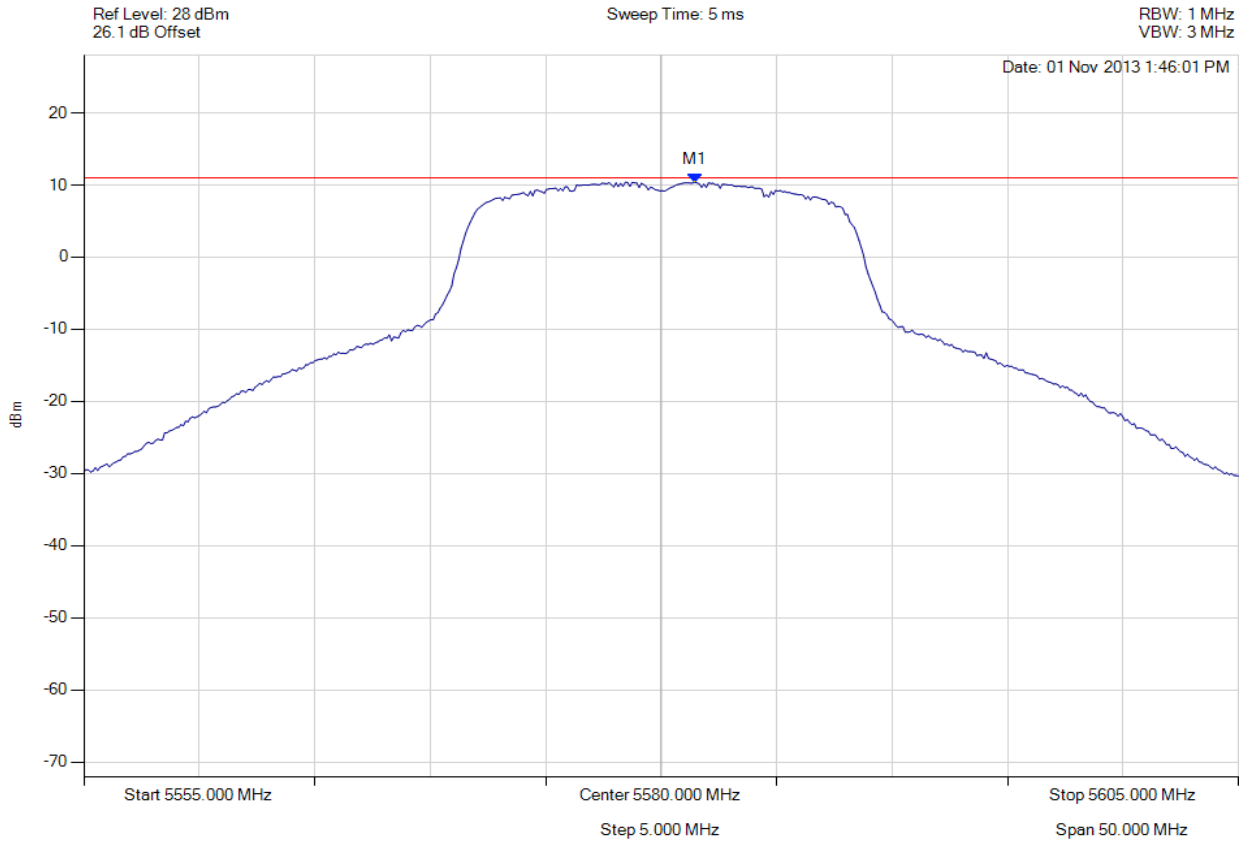

Analyser Setup	Marker : Frequency : Amplitude	Test Results
Detector = RMS Sweep Count = 100 RF Atten (dB) = 20 Trace Mode = VIEW	M1 : 5581.453 MHz : 10.392 dBm	Limit: ≤ 11.000 dBm Margin: -0.61 dB

[Back to the Matrix](#)

This test report may be reproduced in full only. The document may only be updated by MiCOM Labs personnel. Any changes will be noted in the Document History section of the report.



PEAK POWER SPECTRAL DENSITY

Variant: 802.11a, Channel: 5700.00 MHz, Chain a, Temp: Ambient, Voltage: 3.6 Vdc

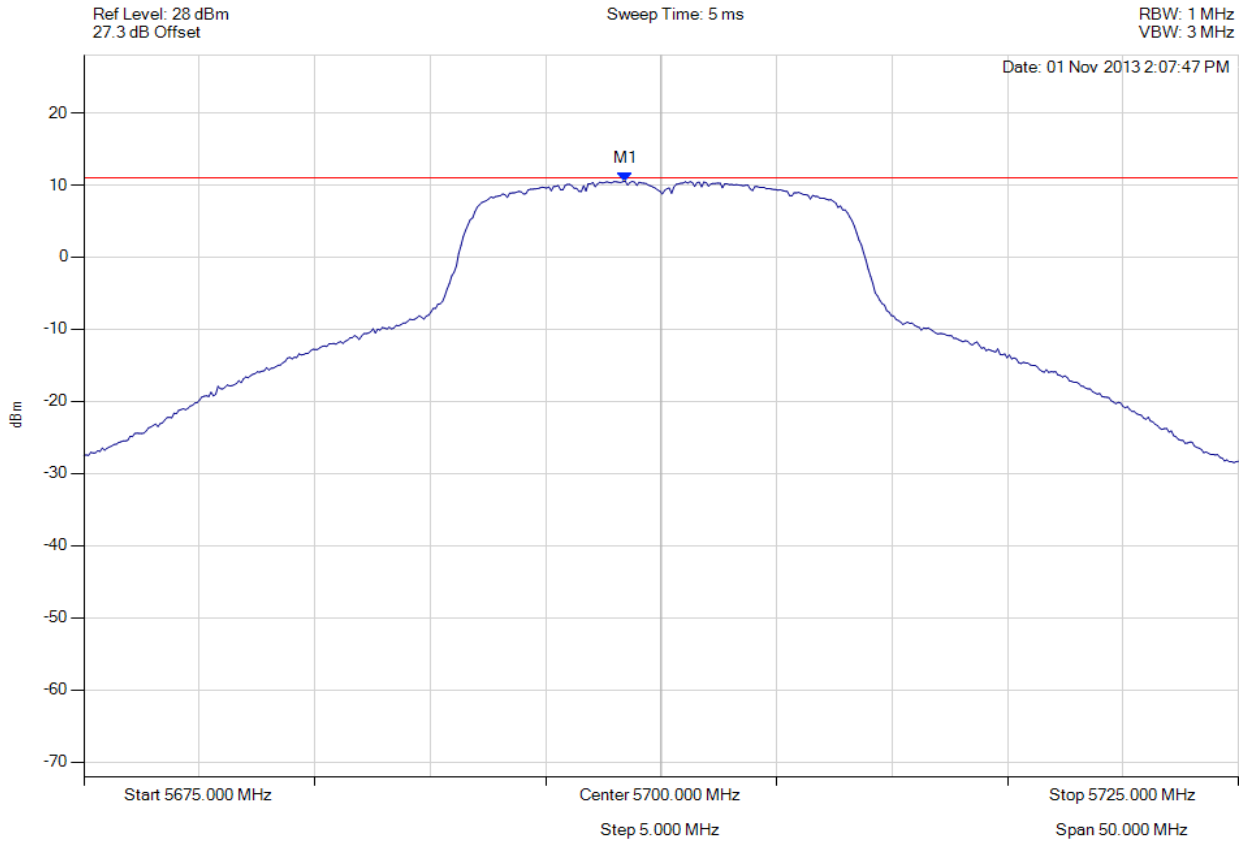

Analyser Setup	Marker : Frequency : Amplitude	Test Results
Detector = RMS Sweep Count = 100 RF Atten (dB) = 20 Trace Mode = VIEW	M1 : 5698.447 MHz : 10.550 dBm	Limit: ≤ 11.000 dBm Margin: -0.45 dB

[Back to the Matrix](#)

This test report may be reproduced in full only. The document may only be updated by MiCOM Labs personnel. Any changes will be noted in the Document History section of the report.



Title: Spectralink 8753 Enhanced IP Telephone
To: FCC 47 CFR Part 15.407 & IC RSS-210
Serial #: SPEC27-U6 Rev A
Issue Date: 2nd January 2014
Page: 135 of 144



PEAK POWER SPECTRAL DENSITY

Variant: 802.11n HT-20, Channel: 5500.00 MHz, Chain a, Temp: Ambient, Voltage: 3.6 Vdc

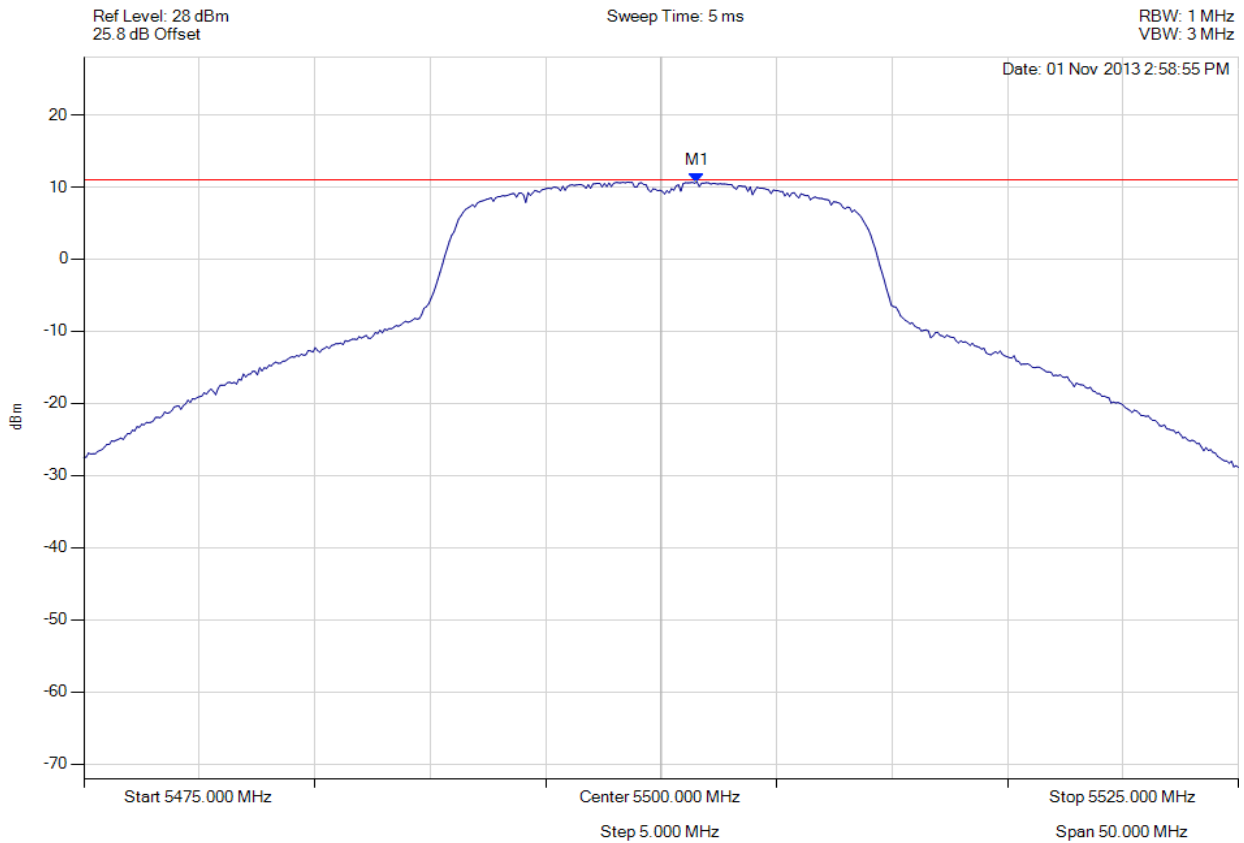

Analyser Setup	Marker : Frequency : Amplitude	Test Results
Detector = RMS Sweep Count = 100 RF Atten (dB) = 20 Trace Mode = VIEW	M1 : 5501.553 MHz : 10.705 dBm	Limit: ≤ 11.000 dBm Margin: -0.29 dB

[Back to the Matrix](#)

This test report may be reproduced in full only. The document may only be updated by MiCOM Labs personnel. Any changes will be noted in the Document History section of the report.



Title: Spectralink 8753 Enhanced IP Telephone
To: FCC 47 CFR Part 15.407 & IC RSS-210
Serial #: SPEC27-U6 Rev A
Issue Date: 2nd January 2014
Page: 136 of 144



PEAK POWER SPECTRAL DENSITY

Variant: 802.11n HT-20, Channel: 5580.00 MHz, Chain a, Temp: Ambient, Voltage: 3.6 Vdc

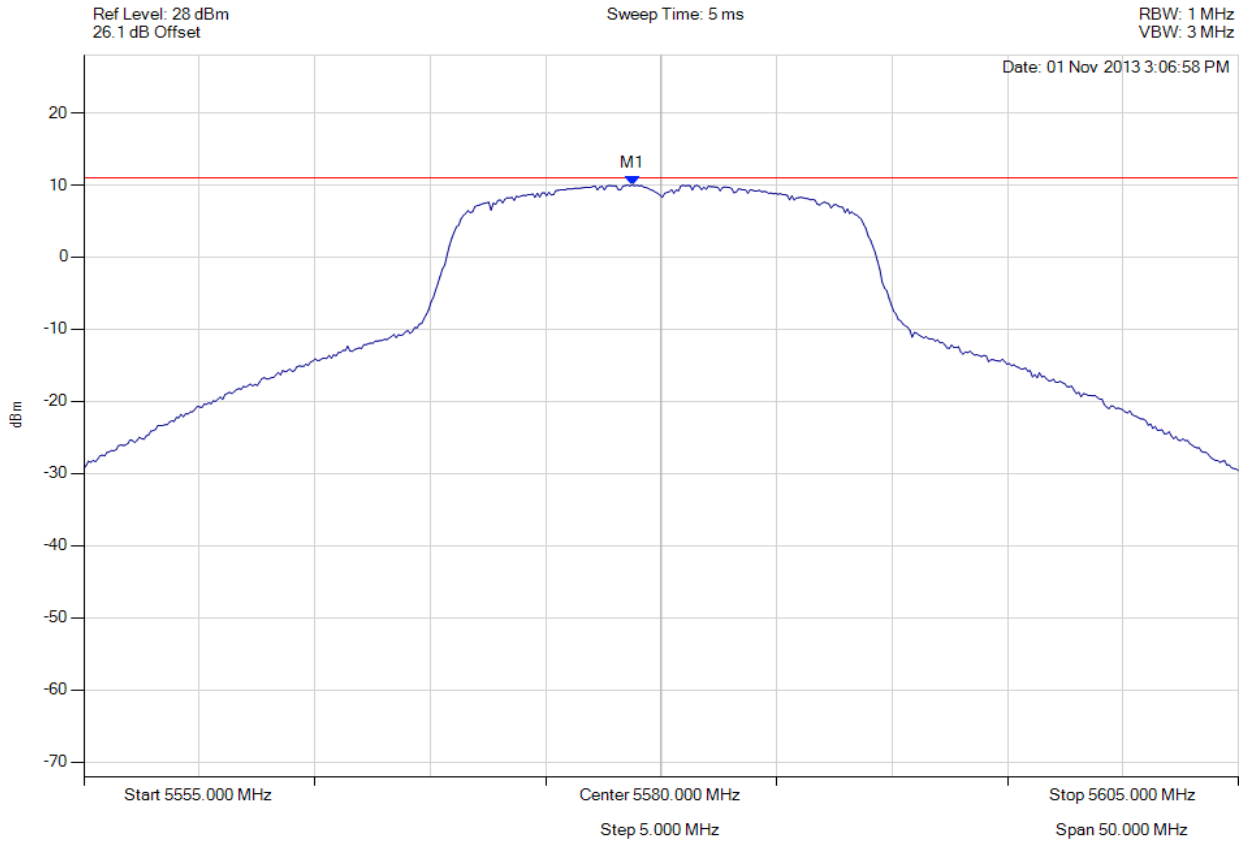

Analyser Setup	Marker : Frequency : Amplitude	Test Results
Detector = RMS Sweep Count = 100 RF Atten (dB) = 20 Trace Mode = VIEW	M1 : 5578.747 MHz : 10.002 dBm	Limit: ≤ 11.000 dBm Margin: -1.00 dB

[Back to the Matrix](#)

This test report may be reproduced in full only. The document may only be updated by MiCOM Labs personnel. Any changes will be noted in the Document History section of the report.



PEAK POWER SPECTRAL DENSITY

Variant: 802.11n HT-20, Channel: 5700.00 MHz, Chain a, Temp: Ambient, Voltage: 3.6 Vdc

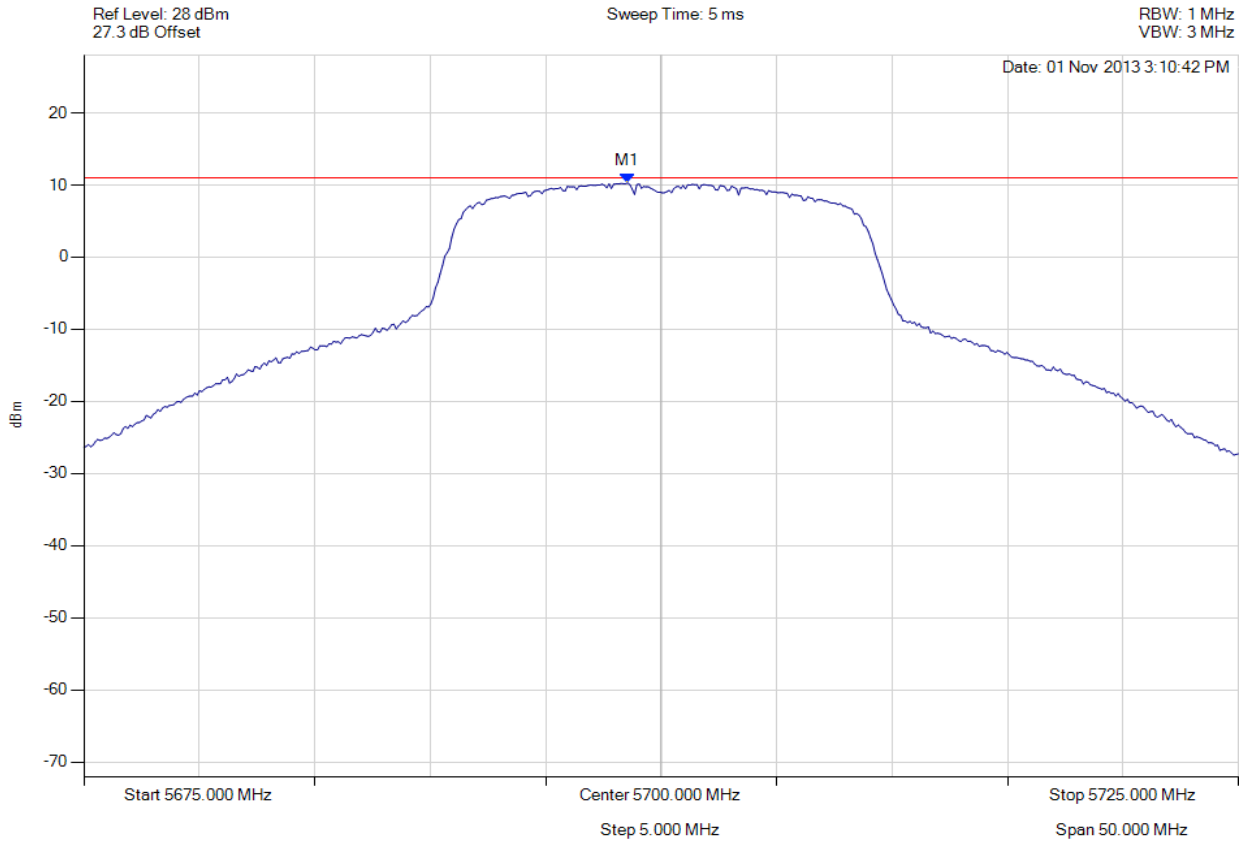

Analyser Setup	Marker : Frequency : Amplitude	Test Results
Detector = RMS Sweep Count = 100 RF Atten (dB) = 20 Trace Mode = VIEW	M1 : 5698.547 MHz : 10.290 dBm	Limit: ≤ 11.000 dBm Margin: -0.71 dB

[Back to the Matrix](#)

This test report may be reproduced in full only. The document may only be updated by MiCOM Labs personnel. Any changes will be noted in the Document History section of the report.

A.1.3. Peak Excursion Ratio



PEAK EXCURSION RATIO

Variant: 802.11a, Channel: 5180.00 MHz, Chain a, Temp: Ambient, Voltage: 3.6 Vdc

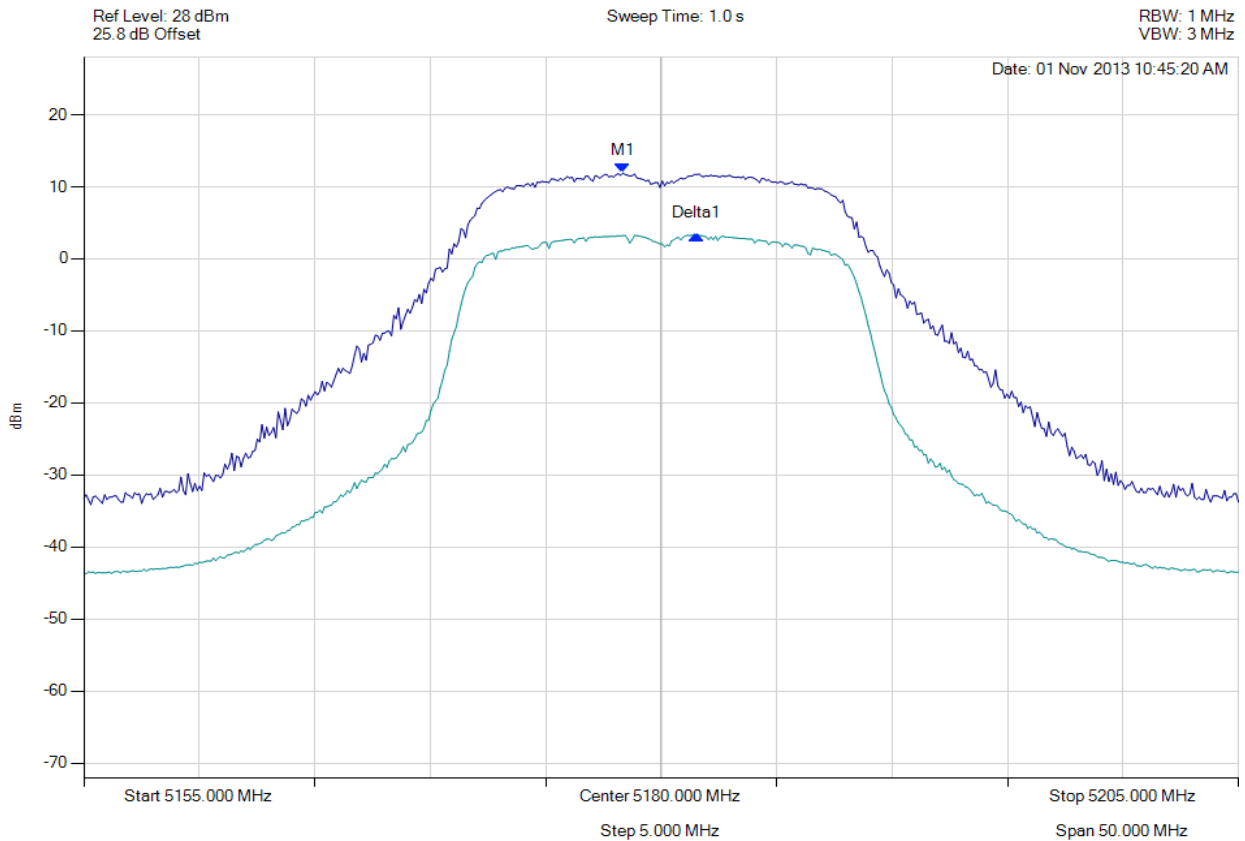

Analyser Setup	Marker : Frequency : Amplitude	Test Results
Sweep Count = 0 RF Atten (dB) = 20 TRACE 1: Detector = MAX PEAK Trace Mode = VIEW TRACE 2: Detector = RMS Trace Mode = VIEW	M1 : 5178.347 MHz : 11.913 dBm Delta1 : 3.206 MHz : -8.552 dB	Measured Excursion Ratio: 8.55 dB Limit: 13.0 dB Margin: -4.45 dB

[Back to the Matrix](#)

This test report may be reproduced in full only. The document may only be updated by MiCOM Labs personnel. Any changes will be noted in the Document History section of the report.



PEAK EXCURSION RATIO

Variant: 802.11n HT-20, Channel: 5180.00 MHz, Chain a, Temp: Ambient, Voltage: 3.6 Vdc

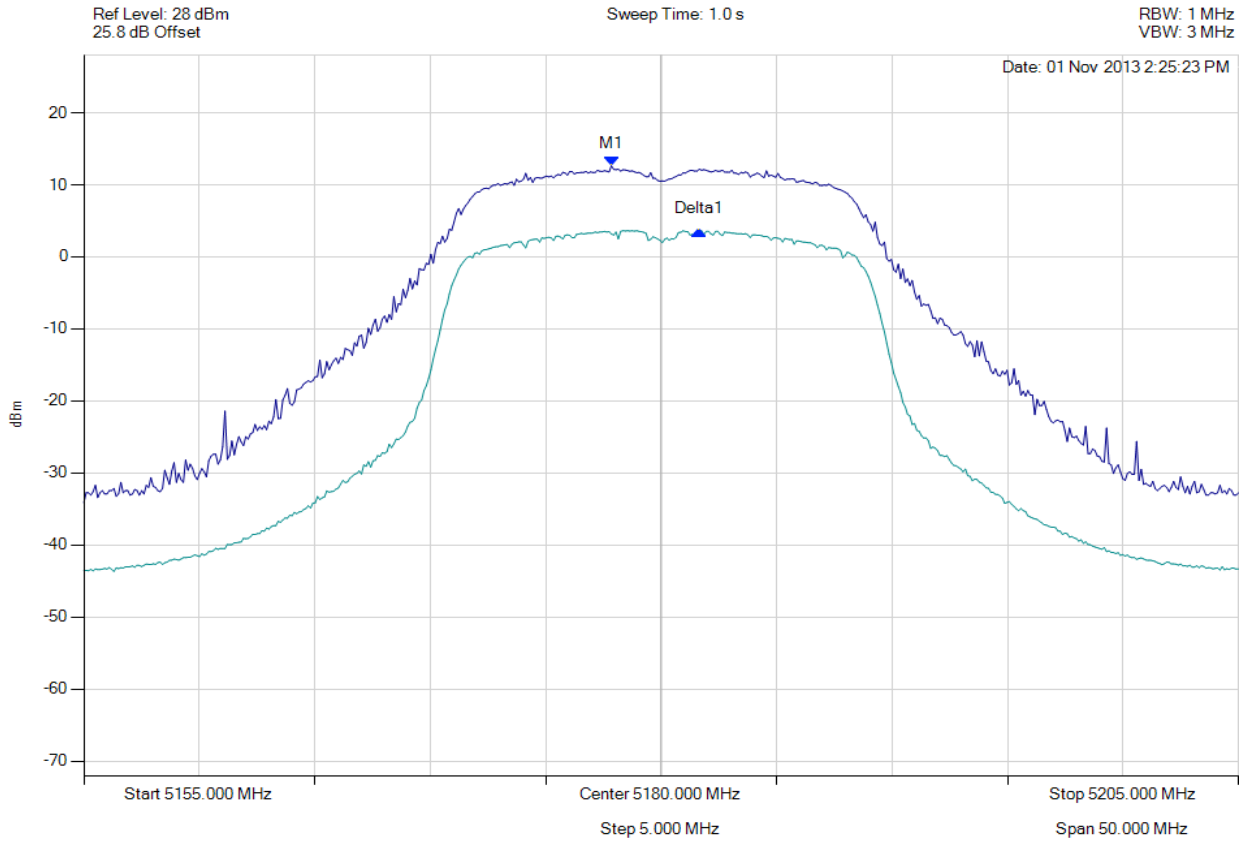

Analyser Setup	Marker : Frequency : Amplitude	Test Results
Sweep Count = 0 RF Atten (dB) = 20 TRACE 1: Detector = MAX PEAK Trace Mode = VIEW TRACE 2: Detector = RMS Trace Mode = VIEW	M1 : 5177.846 MHz : 12.643 dBm Delta1 : 3.808 MHz : -9.012 dB	Measured Excursion Ratio: 9.01 dB Limit: 13.0 dB Margin: -3.99 dB

[Back to the Matrix](#)

This test report may be reproduced in full only. The document may only be updated by MiCOM Labs personnel. Any changes will be noted in the Document History section of the report.



PEAK EXCURSION RATIO

Variant: 802.11a, Channel: 5260.00 MHz, Chain a, Temp: Ambient, Voltage: 3.6 Vdc

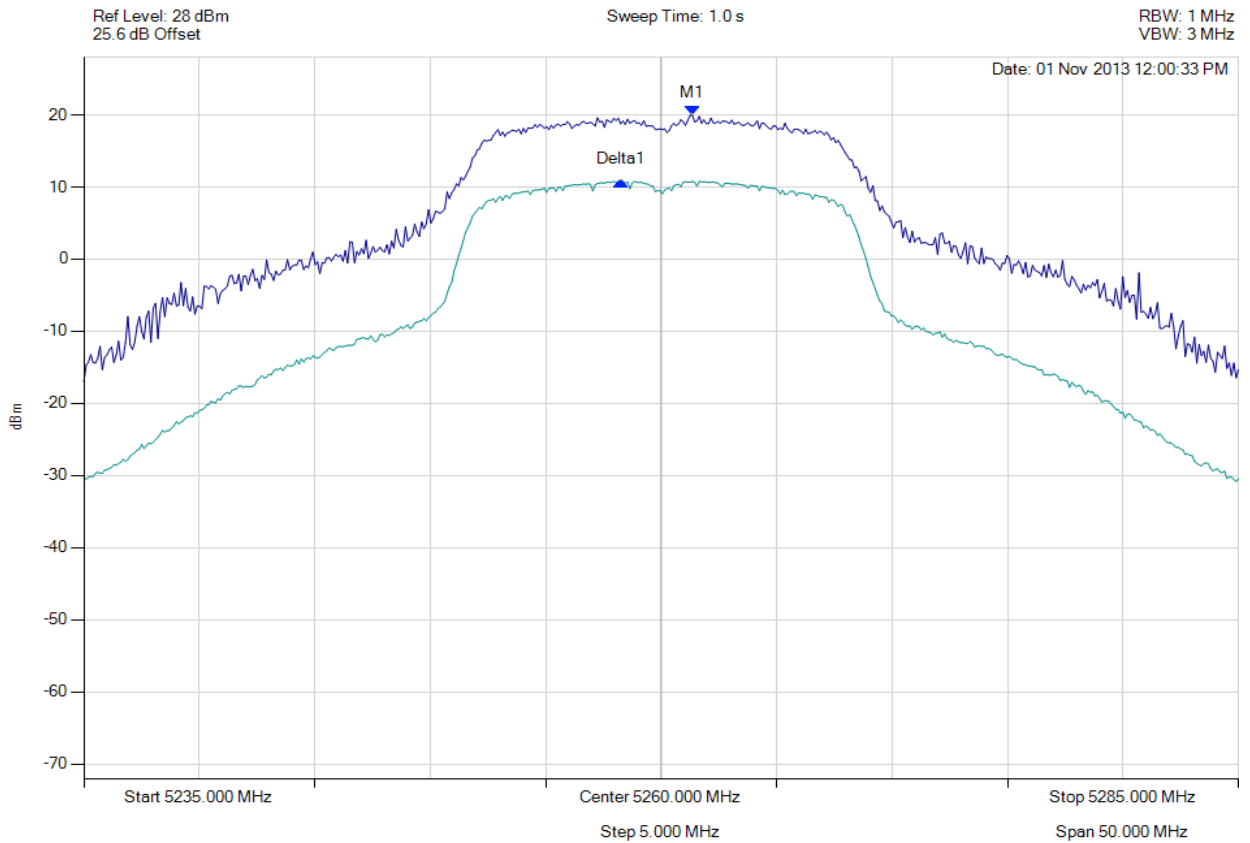

Analyser Setup	Marker : Frequency : Amplitude	Test Results
Sweep Count = 0 RF Atten (dB) = 20 TRACE 1: Detector = MAX PEAK Trace Mode = VIEW TRACE 2: Detector = RMS Trace Mode = VIEW	M1 : 5261.353 MHz : 19.938 dBm Delta1 : -3106212 Hz : -9.138 dB	Measured Excursion Ratio: 9.14 dB Limit: 13.0 dB Margin: -3.86 dB

[Back to the Matrix](#)

This test report may be reproduced in full only. The document may only be updated by MiCOM Labs personnel. Any changes will be noted in the Document History section of the report.



PEAK EXCURSION RATIO

Variant: 802.11n HT-20, Channel: 5260.00 MHz, Chain a, Temp: Ambient, Voltage: 3.6 Vdc

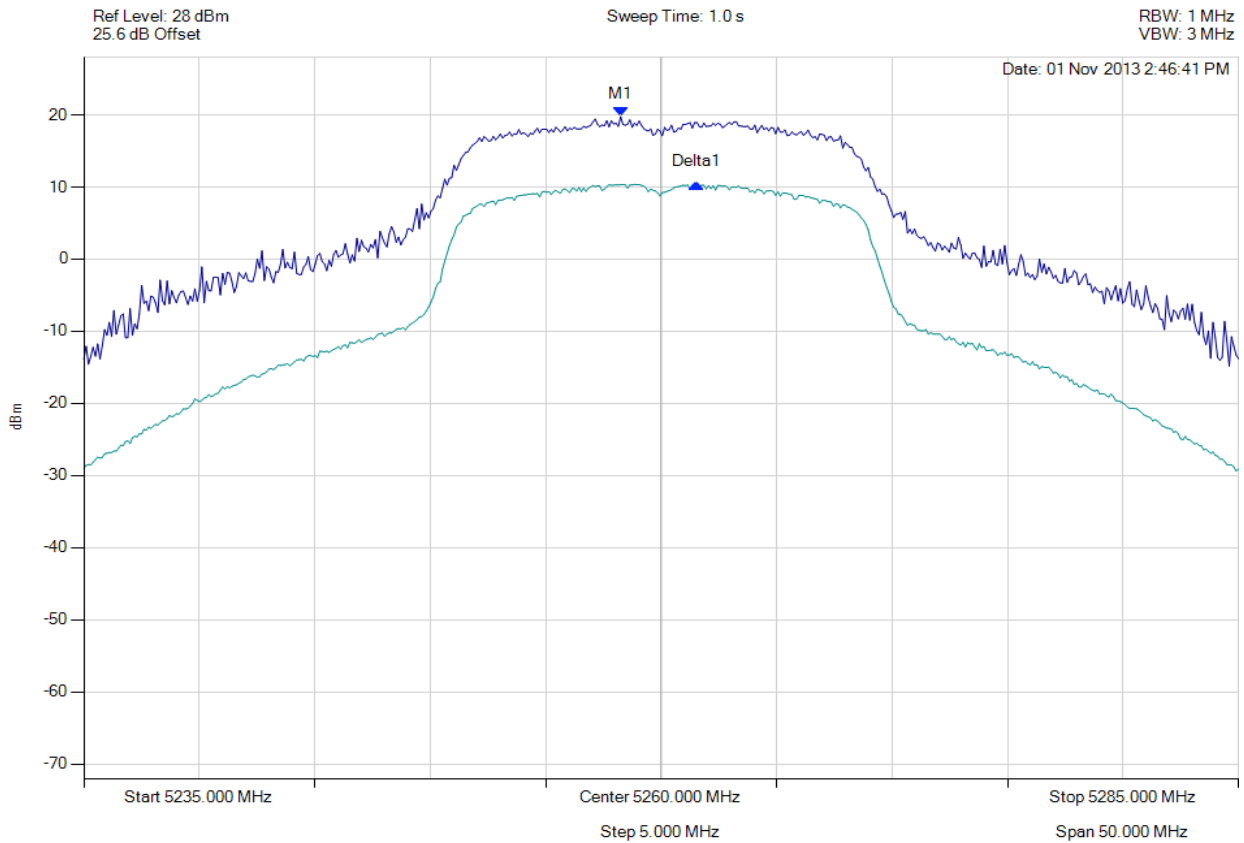

Analyser Setup	Marker : Frequency : Amplitude	Test Results
Sweep Count = 0 RF Atten (dB) = 20 TRACE 1: Detector = MAX PEAK Trace Mode = VIEW TRACE 2: Detector = RMS Trace Mode = VIEW	M1 : 5258.246 MHz : 19.760 dBm Delta1 : 3.307 MHz : -9.344 dB	Measured Excursion Ratio: 9.34 dB Limit: 13.0 dB Margin: -3.66 dB

[Back to the Matrix](#)

This test report may be reproduced in full only. The document may only be updated by MiCOM Labs personnel. Any changes will be noted in the Document History section of the report.



PEAK EXCURSION RATIO

Variant: 802.11a, Channel: 5500.00 MHz, Chain a, Temp: Ambient, Voltage: 3.6 Vdc

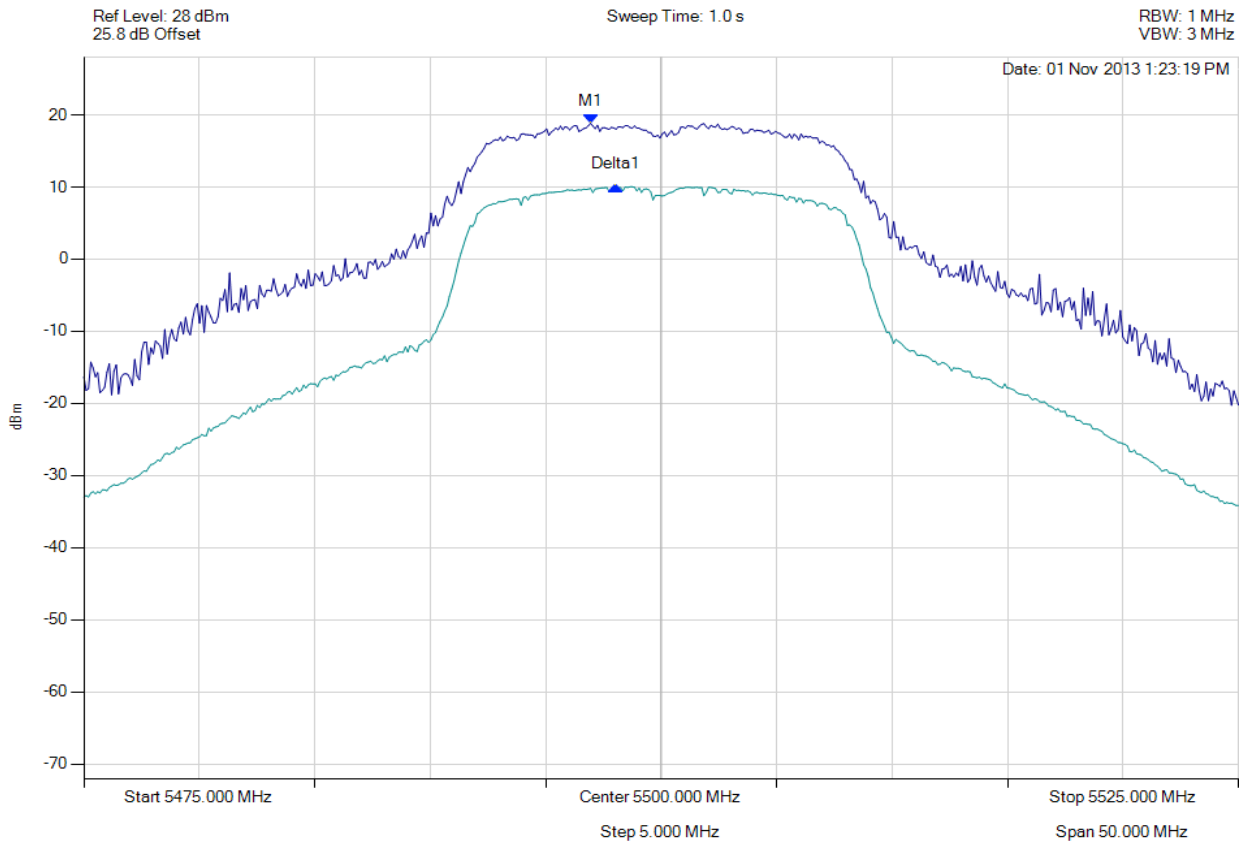

Analyser Setup	Marker : Frequency : Amplitude	Test Results
Sweep Count = 0 RF Atten (dB) = 20 TRACE 1: Detector = MAX PEAK Trace Mode = VIEW TRACE 2: Detector = RMS Trace Mode = VIEW	M1 : 5496.944 MHz : 18.845 dBm Delta1 : 1.102 MHz : -8.711 dB	Measured Excursion Ratio: 8.71 dB Limit: 13.0 dB Margin: -4.29 dB

[Back to the Matrix](#)

This test report may be reproduced in full only. The document may only be updated by MiCOM Labs personnel. Any changes will be noted in the Document History section of the report.



PEAK EXCURSION RATIO

Variant: 802.11n HT-20, Channel: 5500.00 MHz, Chain a, Temp: Ambient, Voltage: 3.6 Vdc

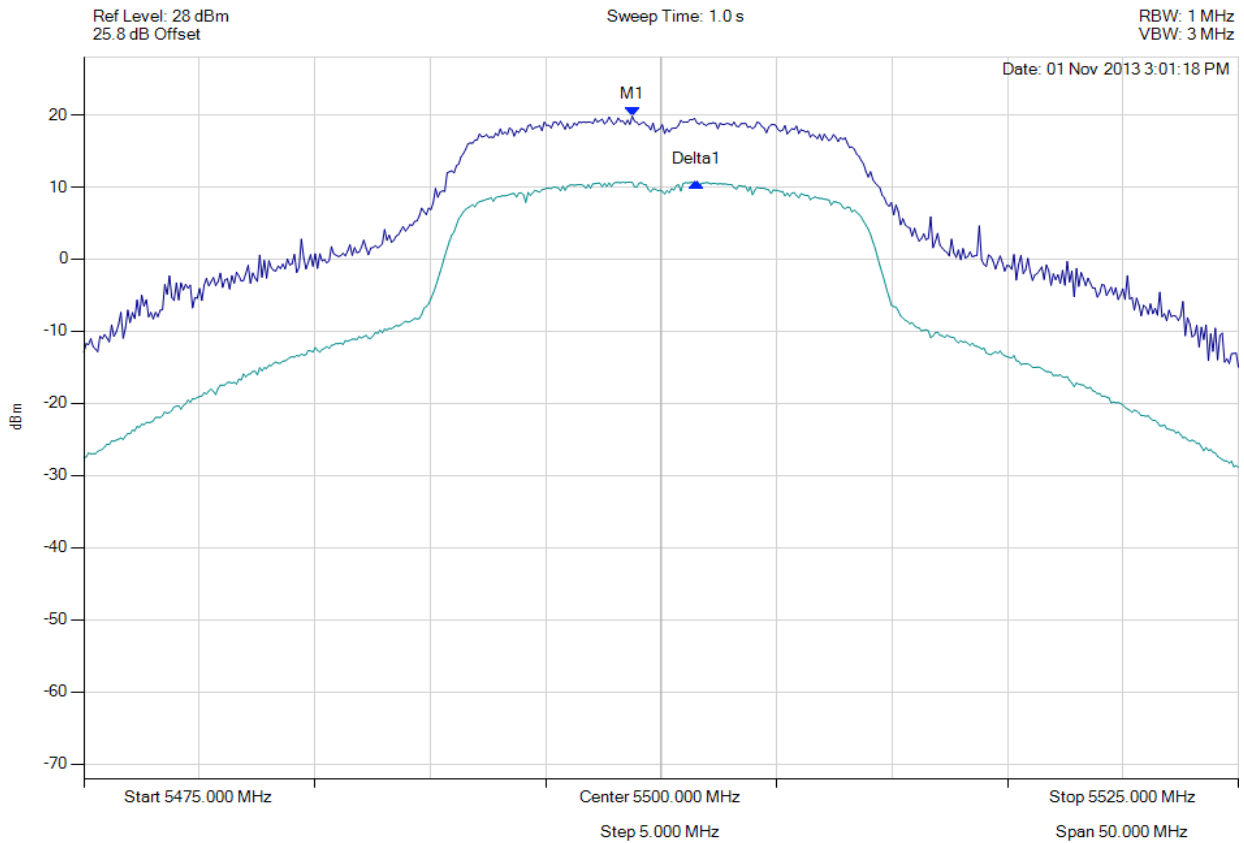

Analyser Setup	Marker : Frequency : Amplitude	Test Results
Sweep Count = 0 RF Atten (dB) = 20 TRACE 1: Detector = MAX PEAK Trace Mode = VIEW TRACE 2: Detector = RMS Trace Mode = VIEW	M1 : 5498.747 MHz : 19.817 dBm Delta1 : 2.806 MHz : -9.102 dB	Measured Excursion Ratio: 9.10 dB Limit: 13.0 dB Margin: -3.90 dB

[Back to the Matrix](#)

This test report may be reproduced in full only. The document may only be updated by MiCOM Labs personnel. Any changes will be noted in the Document History section of the report.



575 Boulder Court,
Pleasanton,
CA 94566, USA
Tel: 1.925.462.0304
Fax: 1.925.462.0306
www.micomlabs.com