

Antenna Pattern for Bluetooth USB Dongle

The integration of a high performance etched PCB antenna makes the Dongle more cost effective and performance is guaranteed during the production.

Layout

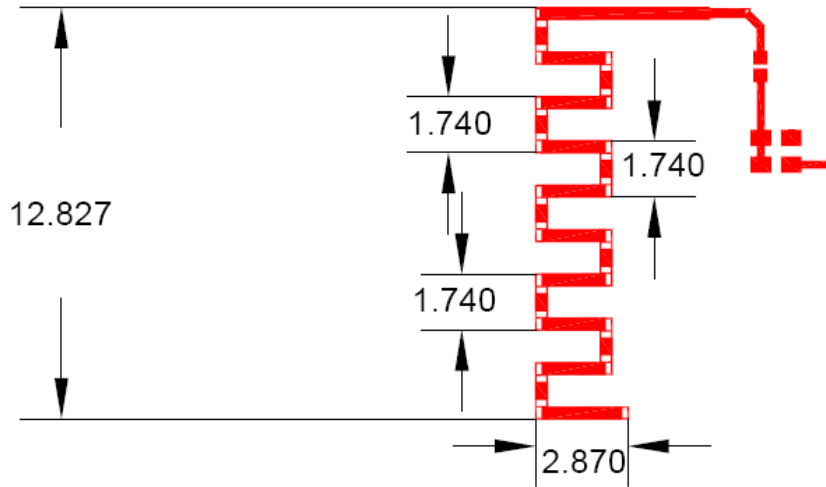

Schematic

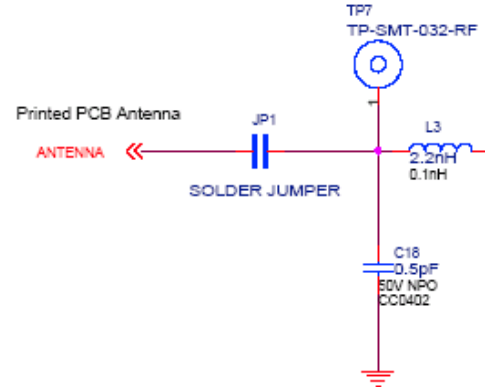

Gain

		Peak	Average	
X Plane	Horizontal	1.87	-5.17	
	Vertical	-8.13	-10.84	
Y Plane	Horizontal	2.03	-4.91	
	Vertical	-7.63	-11.39	
Z Plane	Horizontal	-4.97	-17.24	
	Vertical	0.7	-1.1	Unit: dBi



SIZE
A

DRAWING NO.

USB Bluetooth Button Dongle

REV
A

DRAWN

SCALE 1/1

SHEET 1 OF 7

7

rand/ Model: USB Bluetooth Button Dongle X Plane and Horizontal.

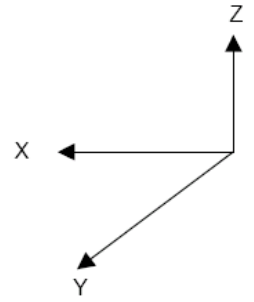

USI 環隆電氣股份有限公司
 Universal Scientific Industrial Co., Ltd.

Model No: BT Ant

Antenna Position: Horizontal

Frequency MHz

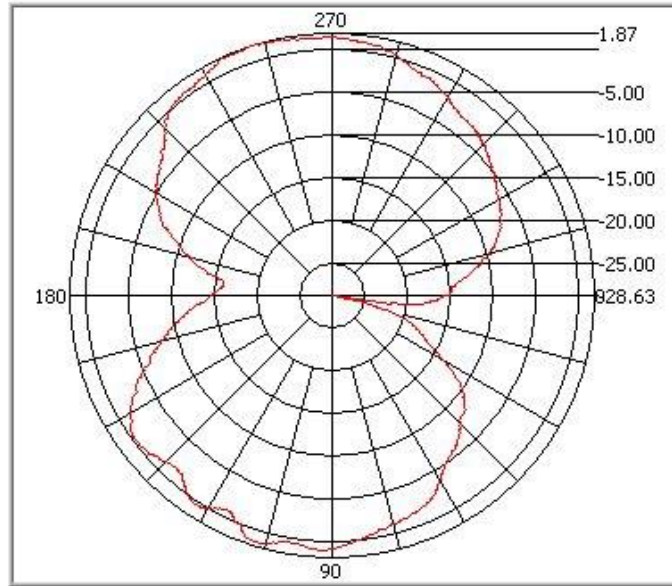

Peak: 1.87 dBi

Peak Angle: 250.24 Degree

Average: -5.17 dBi

Test engineer: _____

Test date: 2004/7/12 at 下午 04:



SIZE
A

DRAWING NO.

USB Bluetooth Button Dongle

REV
A

DRAWN

SCALE 1/1

SHEET 2 OF 7

Brand/ Model: USB Bluetooth Button Dongle X Plane and Vertical

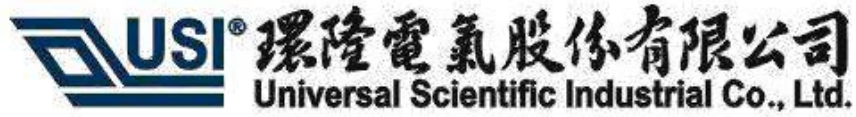

Model No: BT Ant

Antenna Position: Vertical

Frequency MHz

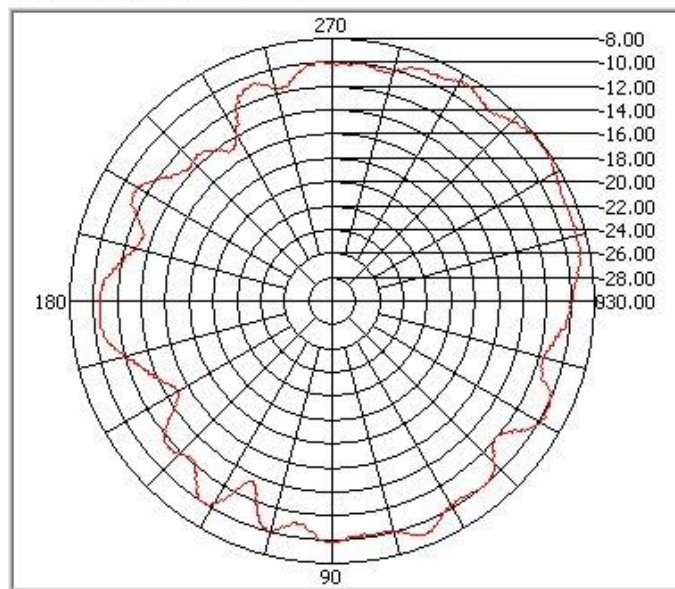

Peak: -8.13 dBi

Peak Angle: 319.37 Degree

Average: -10.84 dBi

Test engineer: _____

Test date: 2004/7/12 at 下午 04:



SIZE
A

DRAWING NO.

USB Bluetooth Button Dongle

REV
A

DRAWN

SCALE 1/1

SHEET 3 OF 7

7

Brand/ Model: USB Bluetooth Button Dongle Y Plane and Horizontal.

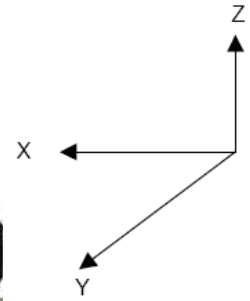
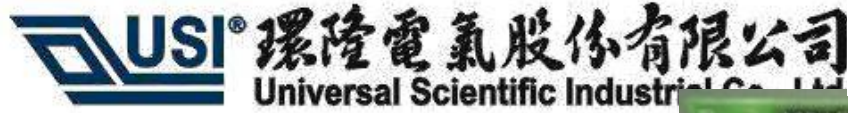

Model No: BT Ant

Antenna Position: Horizontal

Frequency MHz

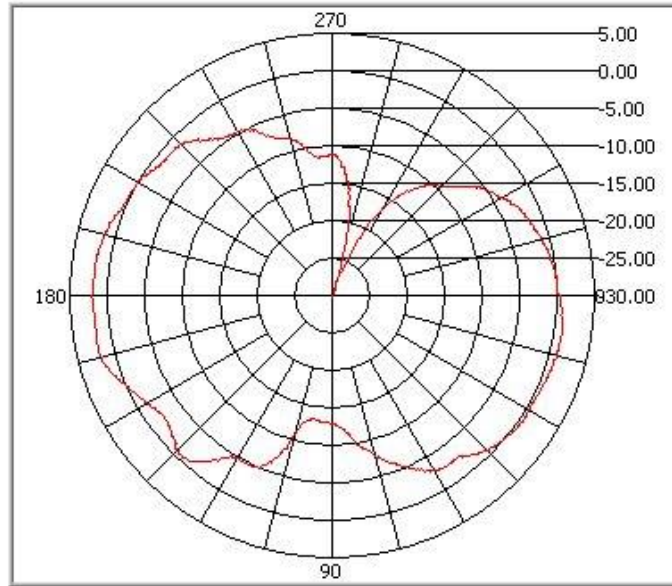

Peak: 2.03 dBi

Peak Angle: 165.85 Degree

Average: -4.91 dBi

Test engineer: _____

Test date: 2004/7/12 at 下午 04:



SIZE
A

DRAWING NO.

USB Bluetooth Button Dongle

REV
A

DRAWN

SCALE 1/1

SHEET 4 OF 7

Brand/ Model: USB Bluetooth Button Dongle Y Plane and Vertical

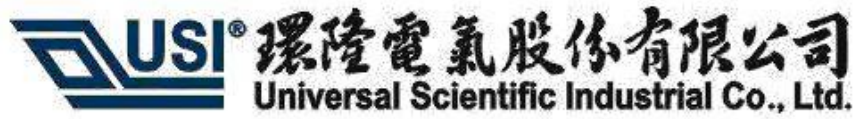

Model No: BT Ant

Antenna Position: Vertical

Frequency MHz

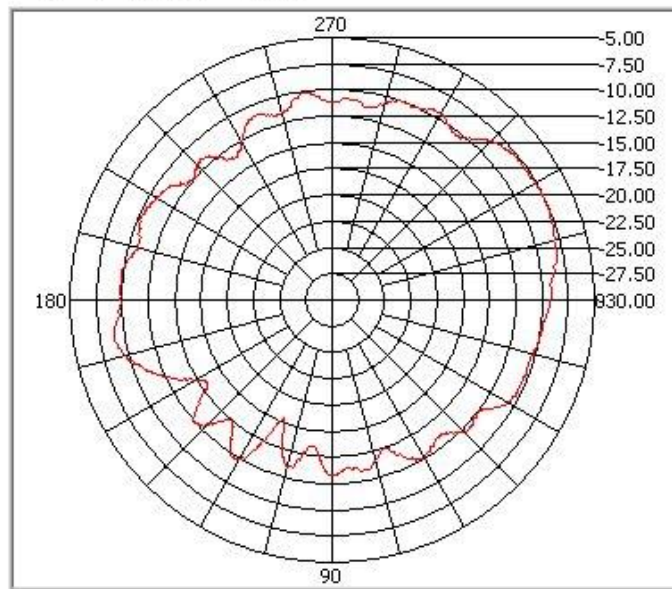

Peak: -7.63 dBi

Peak Angle: 326.76 Degree

Average: -11.39 dBi

Test engineer: _____

Test date: 2004/7/12 at 下午 04:



SIZE
A

DRAWING NO.

USB Bluetooth Button Dongle

REV
A

DRAWN

SCALE 1/1

SHEET 5 OF 7

7

Brand/ Model: USB Bluetooth Button Dongle Z Plane and Horizontal.

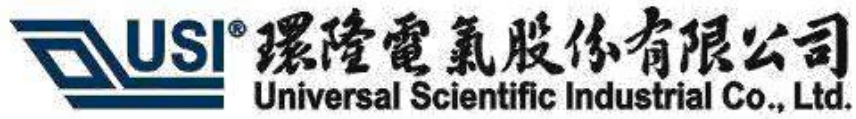

Model No: BT Ant

Antenna Position: Horizontal

Frequency MHz

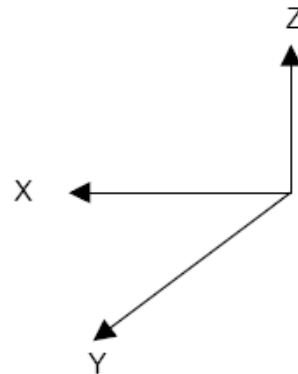
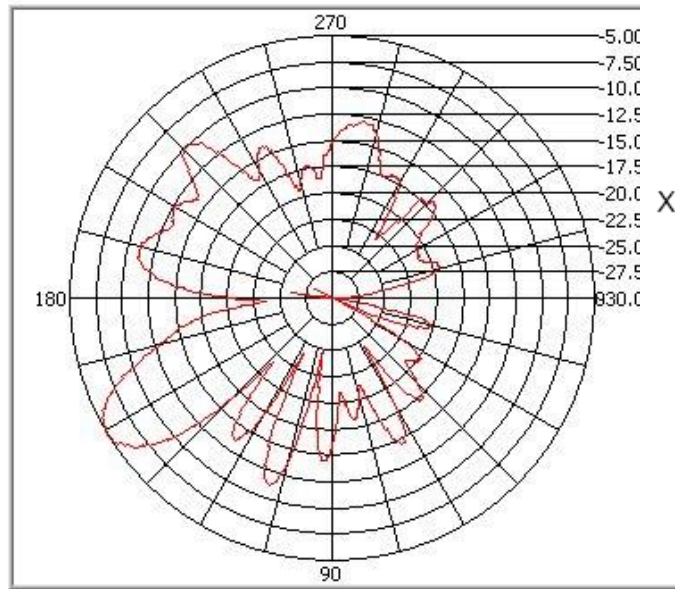

Peak: -4.97 dBi

Peak Angle: 147.76 Degree

Average: -17.24 dBi

Test engineer: _____

Test date: 2004/7/12 at 下午 04:



SIZE
A

DRAWING NO.

USB Bluetooth Button Dongle

REV
A

DRAWN

SCALE 1/1

SHEET 6 OF 7

Brand/ Model: USB Bluetooth Button Dongle Z Plane and Vertical

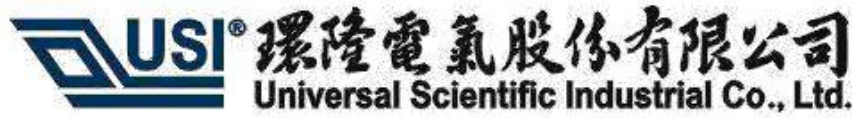

Model No: BT Ant

Antenna Position: Vertical

Frequency MHz

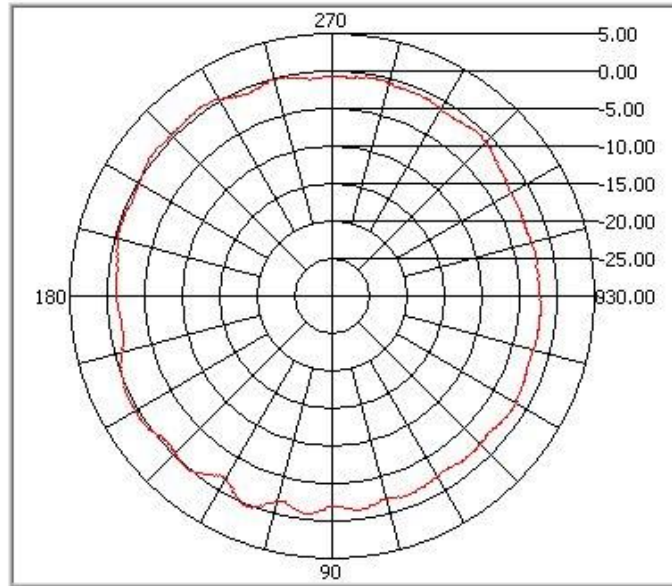

Peak: 0.70 dBi

Peak Angle: 233.22 Degree

Average: -1.10 dBi

Test engineer: _____

Test date: 2004/7/12 at 下午 04:



SIZE
A

DRAWING NO.
USB Bluetooth Button Dongle

REV
A

DRAWN

SCALE 1/1

SHEET 7 OF 7