



FCC TEST REPORT

REPORT NO. : RF940201H04

MODEL NO. : CTE - 630BT

RECEIVED : Feb. 01, 2005

TESTED : Feb. 01 to 28, 2005

ISSUED : Mar. 01, 2005

APPLICANT : UNIVERSAL SCIENTIFIC INDUSTRIAL CO., LTD.

ADDRESS : 141, Lane 351, Taiping Road, Sec. 1, Tsao Tuen,
Nan-Tou, Taiwan, R.O.C.

ISSUED BY : Advance Data Technology Corporation

LAB LOCATION : No. 81-1, Lu Liao Keng, 9 Ling, Wu Lung Tsuen,
Chiung Lin Hsiang, Hsin Chu Hsien,
Taiwan, R.O.C.

This test report consists of 23 pages in total. It may be duplicated completely for legal use with the approval of the applicant. It should not be reproduced except in full, without the written approval of our laboratory. The client should not use it to claim product endorsement by CNLA, A2LA or any government agencies. The test results in the report only apply to the tested sample. The test results in this report are traceable to the national or international standards.



0536
ILAC MRA



No. 2177-01



Table of Contents

1	CERTIFICATION.....	3
2	SUMMARY OF TEST RESULTS	4
2.1	MEASUREMENT UNCERTAINTY	4
3	GENERAL INFORMATION	5
3.1	GENERAL DESCRIPTION OF EUT	5
3.2	DESCRIPTION OF SUPPORT UNITS	7
3.3	CONFIGURATION OF SYSTEM UNDER TEST	8
4	EMISSION TEST	9
4.1	CONDUCTED EMISSION MEASUREMENT.....	9
4.1.1	LIMITS OF CONDUCTED EMISSION MEASUREMENT	9
4.1.2	TEST INSTRUMENTS.....	9
4.1.3	TEST PROCEDURE.....	10
4.1.4	DEVIATION FROM TEST STANDARD.....	10
4.1.5	TEST SETUP.....	10
4.1.6	EUT OPERATING CONDITIONS	11
4.1.7	TEST RESULTS	12
4.2	RADIATED EMISSION MEASUREMENT.....	14
4.2.1	LIMITS OF RADIATED EMISSION MEASUREMENT	14
4.2.2	TEST INSTRUMENTS.....	15
4.2.3	TEST PROCEDURE.....	16
4.2.4	DEVIATION FROM TEST STANDARD.....	16
4.2.5	TEST SETUP.....	17
4.2.6	EUT OPERATING CONDITIONS	17
4.2.7	TEST RESULTS	18
4.2.8	TEST RESULTS (SPECTRUM BANDWIDTH)	20
5	PHOTOGRAPHS OF THE TEST CONFIGURATION	21
6	APPENDIX - INFORMATION ON THE TESTING LABORATORIES	23



1 CERTIFICATION

PRODUCT : Graphire 3 wireless Tablet
MODEL NO. : CTE - 630BT
BRAND : WACOM
APPLICANT : UNIVERSAL SCIENTIFIC INDUSTRIAL CO., LTD.
STANDARDS : 47 CFR Part 15, Subpart C (Section 15.209)
ANSI C63.4-2003

The above equipment (Model: CTE - 630BT) has been tested by **Advance Data Technology Corporation**, and found compliance with the requirement of the above standards. The test record, data evaluation & Equipment Under Test (EUT) configurations represented herein are true and accurate accounts of the measurements of the sample's EMC characteristics under the conditions specified in this report.

PREPARED BY : Carol Liao , **DATE:** Mar. 01, 2005
(Carol Liao)

TECHNICAL ACCEPTANCE : Hank Chung , **DATE:** Mar. 01, 2005
Responsible for RF (Hank Chung)

APPROVED BY : Eric Lin , **DATE:** Mar. 01, 2005
(Eric Lin, Manager)

2 SUMMARY OF TEST RESULTS

The EUT has been tested according to the following specifications:

APPLIED STANDARD: 47 CFR Part 15, Subpart C			
Standard	Test Type	Result	Remarks
47 CFR Part 15, Subpart C	Conducted Test	PASS	Meets Class B Limit Minimum passing margin is -15.73 dB at 12.754 MHz
	Radiated Test	PASS	Meets Class B Limit Minimum passing margin is -13.2 dB at 240.00 MHz

2.1 MEASUREMENT UNCERTAINTY

Where relevant, the following measurement uncertainty levels have been estimated for tests performed on the EUT as specified in CISPR 16-4:

Measurement	Value
Conducted emissions	2.53 dB
Radiated emissions (30MHz-1GHz)	2.98 dB
Radiated emissions (1GHz ~18GHz)	2.21 dB

3 GENERAL INFORMATION

3.1 GENERAL DESCRIPTION OF EUT

PRODUCT	Graphire 3 wireless Tablet
MODEL NO.	CTE - 630BT
POWER SUPPLY	Power adapter or battery
CARRIER FREQUENCY	750 KHz +/- 10 %
DATA CABLE	NA
POWER CORD	NA
ANTENNA TYPE	Ceramic Antenna with 0dBi antenna gain
I/O PORTS	NA
ASSOCIATED DEVICES	NA

Note:

1. The EUT was powered by following power adapter or battery:

Adapter	
Brand:	WACOM
Model No.:	A10W-06101
Input power :	100-240V 50/60Hz 0.3A
Output power :	6V 1.0A 1.8m non-shielded without core

Battery	
Brand:	WACOM
Model No.:	GWL-001
Output power :	DC3.7V 1800mA

2. Following Pen and Mouse will be sold together with the EUT:

PRODUCT NAME	BRAND	MODEL NO.	Physical size	Weight
Graphire3 Pen	WACOM	EP - 130E	L*D:145*12.5 mm (5.71*0.19 in)	11g(0.02 lb), approximately
Graphire3 Mouse	WACOM	EC -130	L*W*H:115*60*38 mm (4.53*2.36*1.50 in)	90g(0.2 lb), approximately

3. The EUT was pre-tested under the following modes:

Pre-test Mode	Description
Mode A	Adapter only with Mouse
Mode B	Battery only with Mouse
Mode C	Adapter+Battery with Mouse
Mode D	Adapter+Battery with Pen

From the above modes, the worst emission levels were found in **Mode C**. Therefore only the test data of the mode were recorded in this report individually.

4. The above EUT information was declared by the manufacturer and for more detailed features description, please refer to the manufacturer's specifications or User's Manual.



3.2 DESCRIPTION OF SUPPORT UNITS

The EUT has been tested as an independent unit together with other necessary accessories or support units. The following support units or accessories were used to form a representative test configuration during the tests.

No.	Product	Brand	Model No.	Serial No.	FCC ID
1	PERSONAL COMPUTER	IBM	Think Centre Series PC	NA	NA
2	MONITOR	ADI	G1000	240058T00100081	NA
3	PRINTER	HP	C2642A	MY79F1C3MZ	B94C2642X
4	MODEM	ACEEX	1414	0206026773	IFAXDM1414
5	KEYBOARD	HP	SK-2502C	M020235183	FCC DoC
6	MOUSE	BTC	M851	G00347024431	NA
7	Graphire3 Mouse	WACOM	EC -130	NA	NA
8	BT USB dongle	USI	UD-23011	UD-23011-1000	IXMUD23011

No.	Signal cable description
1	NA
2	1.8 m braid shielded wire, terminated with VGA connector via metallic frame, w/o core
3	1.8 m braid shielded wire, terminated with DB25 and Centronics connector via metallic frame, w/o core.
4	1.3 m braid shielded wire, terminated with DB25 and DB9 connector via metallic frame, w/o core.
5	1.8 m foil shielded wire, terminal by frame, PS2 Connector, w/o Core.
6	1.8 m foil shielded wire, terminated with PS2 connector via drain wire, w/o core.
7	NA
8	NA

Note: 1. The power cords of the above support units were unshielded (1.8m).

3.3 CONFIGURATION OF SYSTEM UNDER TEST

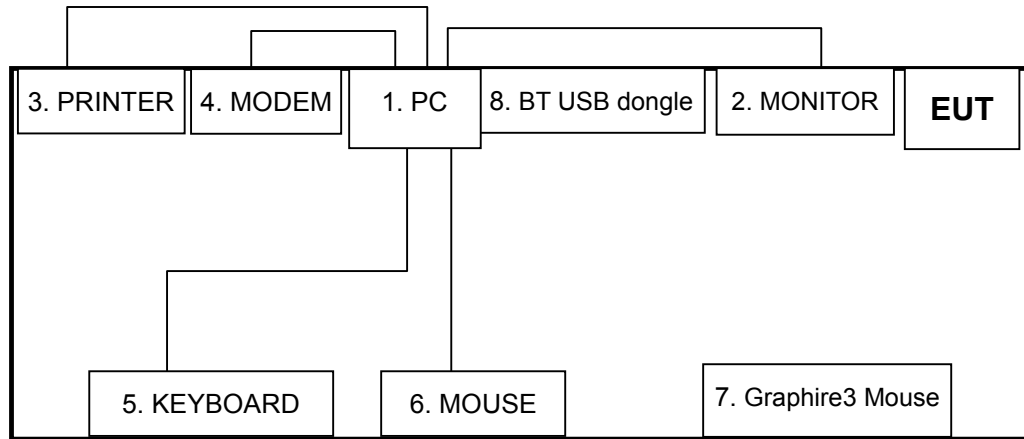

NOTE: 1. Please refer to the photos of test configuration in Item 5 also.

4 EMISSION TEST

4.1 CONDUCTED EMISSION MEASUREMENT

4.1.1 LIMITS OF CONDUCTED EMISSION MEASUREMENT

FREQUENCY (MHz)	Class A (dBuV)		Class B (dBuV)	
	Quasi-peak	Average	Quasi-peak	Average
0.15 - 0.5	79	66	66 - 56	56 - 46
0.50 - 5.0	73	60	56	46
5.0 - 30.0	73	60	60	50

- NOTES:** (1) The lower limit shall apply at the transition frequencies.
- (2) The limit decreases in line with the logarithm of the frequency in the range of 0.15 to 0.50 MHz.
- (3) All emanations from a class A/B digital device or system, including any network of conductors and apparatus connected thereto, shall not exceed the level of field strengths specified above.

4.1.2 TEST INSTRUMENTS

DESCRIPTION & MANUFACTURER	MODEL NO.	SERIAL NO.	CALIBRATED UNTIL
ROHDE & SCHWARZ Test Receiver	ESCS 30	847124/029	Dec. 07, 2005
ROHDE & SCHWARZ LISN (for EUT)	ESHS-Z5	848773/004	Nov. 08, 2005
KYORITSU LISN (for peripheral)	KNW-407	8/1395/12	Jul. 23, 2005
RF Cable (JETBAO)	RG233/U	Cable_CA_01	Jul. 02, 2005
Terminator(for KYORITSU)	50	3	May 10, 2005
Software	Cond-V2e	NA	NA

- NOTE:** 1. The calibration interval of the above test instruments is 12 months and the calibrations are traceable to NML/ROC and NIST/USA.
2. The test was performed in ADT Shielded Room No. A.
3. The VCCI Con A Registration No. is C-817.

4.1.3 TEST PROCEDURE

- a. The EUT was placed 0.4 meters from the conducting wall of the shielded room with EUT being connected to the power mains through a line impedance stabilization network (LISN). Other support units were connected to the power mains through another LISN. The two LISNs provide 50 Ohm/ 50uH of coupling impedance for the measuring instrument.
- b. Both lines of the power mains connected to the EUT were checked for maximum conducted interference.
- c. The frequency range from 150 kHz to 30 MHz was searched. Emission levels over 20dB under the prescribed limits could not be reported.

4.1.4 DEVIATION FROM TEST STANDARD

No deviation

4.1.5 TEST SETUP

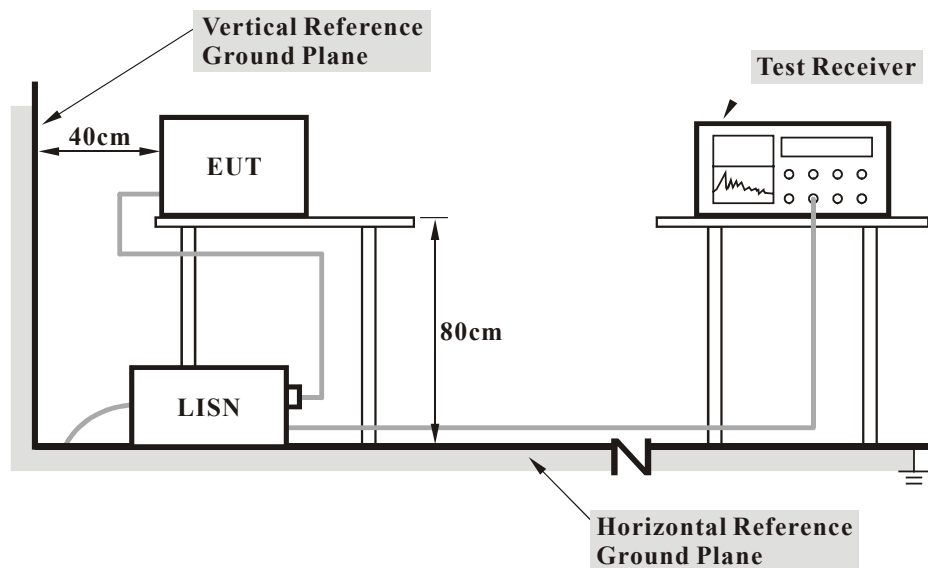

- Note:**
1. Support units were connected to second LISN.
 2. Both of LISNs (AMN) are 80 cm from EUT and at least 80 cm from other units and other metal planes support units.

For the actual test configuration, please refer to the related Item - Photographs of the Test Configuration.



4.1.6 EUT OPERATING CONDITIONS

1. Turn on the power of all equipment.
2. Enable wireless Tablet function.
3. PC sends "H" messages to monitor. Monitor scrolling "H" patterns on its screen.
4. PC sends "H" messages to modem.
5. PC sends "H" messages to printer, and the printer prints them on paper.
6. Repeat steps 2-5.

4.1.7 TEST RESULTS

EUT	Graphire 3 wireless Tablet		
MODEL	CTE - 630BT	PHASE	Line (L)
INPUT POWER (SYSTEM)	120Vac, 60Hz	6dB BANDWIDTH	9 kHz
ENVIRONMENTAL CONDITIONS	17 deg. C, 68% RH, 984 hPa TESTED BY : Hank Chung		

No	Freq. [MHz]	Corr. Factor (dB)	Reading Value		Emission Level		Limit		Margin	
			[dB (uV)]		[dB (uV)]		[dB (uV)]		(dB)	
			Q.P.	AV.	Q.P.	AV.	Q.P.	AV.	Q.P.	AV.
1	0.177	0.14	44.74	-	44.88	-	64.61	54.61	-19.73	-
2	0.236	0.15	41.01	-	41.16	-	62.24	52.24	-21.07	-
3	0.529	0.18	30.07	-	30.25	-	56.00	46.00	-25.75	-
4	2.248	0.27	28.71	-	28.98	-	56.00	46.00	-27.02	-
5	12.750	0.88	37.99	-	38.87	-	60.00	50.00	-21.13	-
6	22.434	1.40	34.06	-	35.46	-	60.00	50.00	-24.54	-

- REMARKS:**
1. Q.P. and AV. are abbreviations of quasi-peak and average individually.
 2. "-": The Quasi-peak reading value also meets average limit and measurement with the average detector is unnecessary.
 3. The emission levels of other frequencies were very low against the limit.
 4. Margin value = Emission level - Limit value
 5. Correction factor = Insertion loss + Cable loss
 6. Emission Level = Correction Factor + Reading Value.

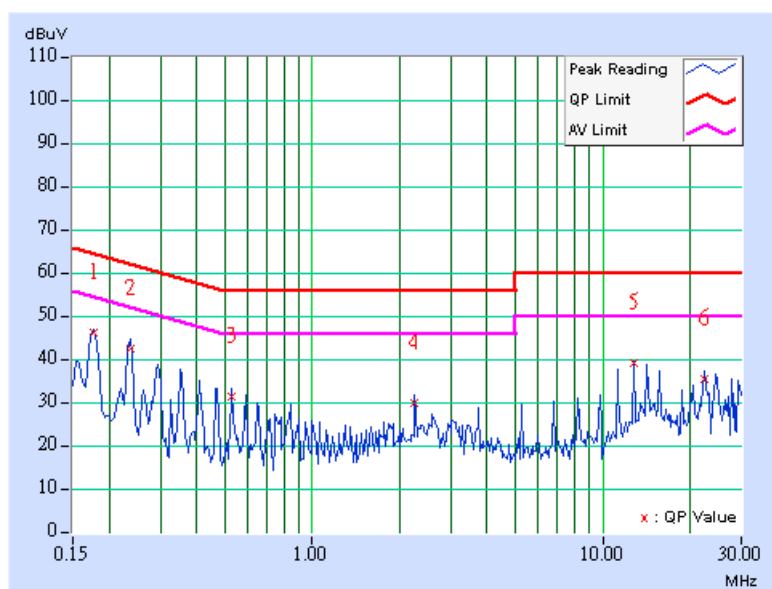

EUT	Graphire 3 wireless Tablet		
MODEL	CTE - 630BT	6dB BANDWIDTH	9 kHz
INPUT POWER (SYSTEM)	120Vac, 60Hz	PHASE	Neutral (N)
ENVIRONMENTAL CONDITIONS	17 deg. C, 68% RH, 984 hPa		TESTED BY : Hank Chung

No	Freq. [MHz]	Corr. Factor (dB)	Reading Value [dB (uV)]		Emission Level [dB (uV)]		Limit [dB (uV)]		Margin (dB)	
			Q.P.	AV.	Q.P.	AV.	Q.P.	AV.	Q.P.	AV.
			1	0.177	0.14	44.11	-	44.25	-	64.61
2	0.236	0.15	40.97	-	41.12	-	62.24	52.24	-21.11	-
3	0.591	0.18	35.54	-	35.72	-	56.00	46.00	-20.28	-
4	2.248	0.27	37.28	-	37.55	-	56.00	46.00	-18.45	-
5	6.750	0.54	40.13	-	40.67	-	60.00	50.00	-19.33	-
6	12.754	0.78	43.49	-	44.27	-	60.00	50.00	-15.73	-

- REMARKS:**
1. Q.P. and AV. are abbreviations of quasi-peak and average individually.
 2. "-": The Quasi-peak reading value also meets average limit and measurement with the average detector is unnecessary.
 3. The emission levels of other frequencies were very low against the limit.
 4. Margin value = Emission level - Limit value
 5. Correction factor = Insertion loss + Cable loss
 6. Emission Level = Correction Factor + Reading Value.

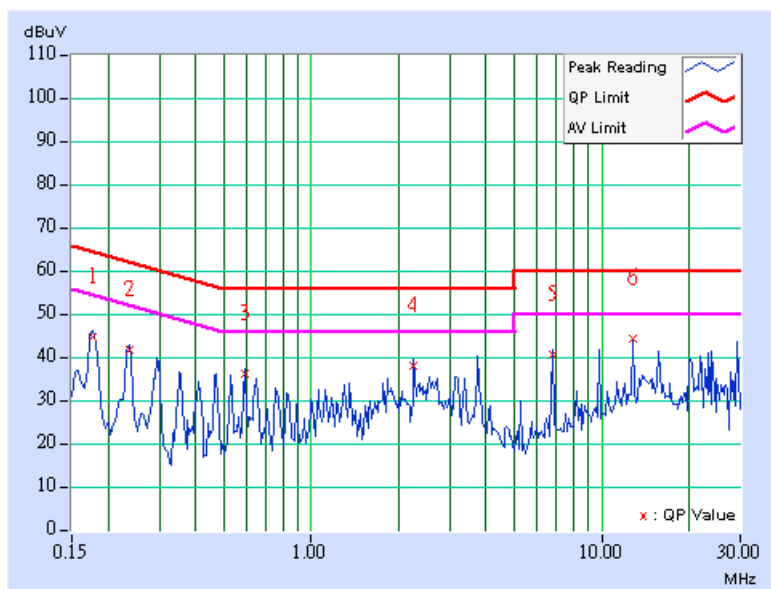



4.2 RADIATED EMISSION MEASUREMENT

4.2.1 LIMITS OF RADIATED EMISSION MEASUREMENT

FOR FREQUENCY BELOW 30 MHz

FREQUENCY (MHz)	Field Strength		Measurement Distance (meters)
	uV/m	dBuV/m	
0.009 – 0.490	2400 / F (kHz)	48.52-13.80	300
0.490 – 1.705	24000 / F (kHz)	33.80-22.97	30
1.705 – 30.0	30	29.54	30

BETWEEN 30-1000 MHz

FREQUENCY (MHz)	Class A (at 10m)		Class B (at 3m)	
	uV/m	dBuV/m	uV/m	dBuV/m
30 – 88	90	39.1	100	40.0
88 – 216	150	43.5	150	43.5
216 – 960	210	46.4	200	46.0
960 – 1000	300	49.5	500	54.0

FOR FREQUENCY ABOVE 1000 MHz

FREQUENCY (MHz)	Class A (dBuV/m) (at 3m)		Class B (dBuV/m) (at 3m)	
	PEAK	AVERAGE	PEAK	AVERAGE
Above 1000	80.0	60.0	74.0	54.0

Note: (1) The lower limit shall apply at the transition frequencies.

(2) Emission level (dBuV/m) = 20 log Emission level (uV/m).

(3) All emanation from a class A/B digital device or system, including any network of conductors and apparatus connected thereto, shall not exceed the level of field strengths specified above.



4.2.2 TEST INSTRUMENTS

DESCRIPTION & MANUFACTURER	MODEL NO.	SERIAL NO.	CALIBRATED UNTIL
HP Spectrum Analyzer	8594E	3710A04861	Sep. 23, 2005
ADVANTEST Spectrum Analyzer	R3271A	85060311	Jun. 29, 2005
CHASE RF Pre_Amplifier	CPA9232	1057	Aug 06, 2005
HP Pre_Amplifier	8449B	3008A01922	Oct. 13, 2005
ROHDE & SCHWARZ Test Receiver	ESCS30	100287	Dec. 08, 2005
CHASE Broadband Antenna	VULB9168	138	Dec. 21, 2005
Schwarzbeck Horn_Antenna	BBHA9120	D124	Jun. 16, 2005
Schwarzbeck Horn_Antenna	BBHA 9170	BBHA9170153	Jan. 30, 2006
SCHWARZBECK Tunable Dipole Antenna	UHAP	897	Mar. 07, 2005
SCHWARZBECK Tunable Dipole Antenna	VHAP	880	Mar. 07, 2005
R&S Loop Antenna	HFH2-Z2	881058/15	Nov. 03, 2005
RF Switches (ARNITSU)	CS-201	1565157	Jul. 15, 2005
RF CABLE (Chaintek) 1GHz-20GHz	SF102	22054-2	Nov. 15, 2005
RF Cable(RICHTEC)	9913-30M	STCCAB-30M-1GHz-021	Jul. 15, 2005
Software	ADT_Radiated_V 5.14	NA	NA
CHANCE MOST Antenna Tower	AT-100	0203	NA
CHANCE MOST Turn Table	TT-100	0203	NA

Note: 1. The calibration interval of the above test instruments is 12 months (36 months for Tunable Dipole Antenna) and the calibrations are traceable to NML/ROC and NIST/USA.

2. The horn antenna and HP preamplifier (model: 8449B) are used only for the measurement of emission frequency above 1GHz if tested.
3. The test was performed in ADT Open Site No. C.
4. The FCC Site Registration No. is 656396.
5. The VCCI Site Registration No. is R-1626.
6. The CANADA Site Registration No. is IC 4824-3.
7. All frequency less than 30MHz are tested by The R&S Loop Antenna



4.2.3 TEST PROCEDURE

- a. The EUT was placed on the top of a rotating table 0.8 meters above the ground at a 10-meter open field site. The table was rotated 360 degrees to determine the position of the highest radiation.
- b. The EUT was set 3 meters away from the interference-receiving antenna, which was mounted on the top of a variable-height antenna tower.
- c. The antenna is a broadband antenna, and its height is varied from one meter to four meters above the ground to determine the maximum value of the field strength. Both horizontal and vertical polarization's of the antenna are set to make the measurement.
- d. For each suspected emission, the EUT was arranged to its worst case and then the antenna was tuned to heights from 1 meter to 4 meters and the rotating table was turned from 0 degrees to 360 degrees to find the maximum reading.
- e. The test-receiver system was set to Peak Detect Function and Specified Bandwidth with Maximum Hold Mode.
- f. If the emission level of the EUT in peak mode was 10 dB lower than the limit specified, then testing could be stopped and the peak values of the EUT would be reported. Otherwise the emissions that did not have 10 dB margin would be re-tested one by one using the quasi- peak method or average method as specified and then reported in Data sheet peak mode and QP mode.
- g. For measurement of frequency above 1000 MHz, the EUT was set 3 meters away from the interference antenna and the detect function was set to Peak or Average.

4.2.4 DEVIATION FROM TEST STANDARD

No deviation

4.2.5 TEST SETUP

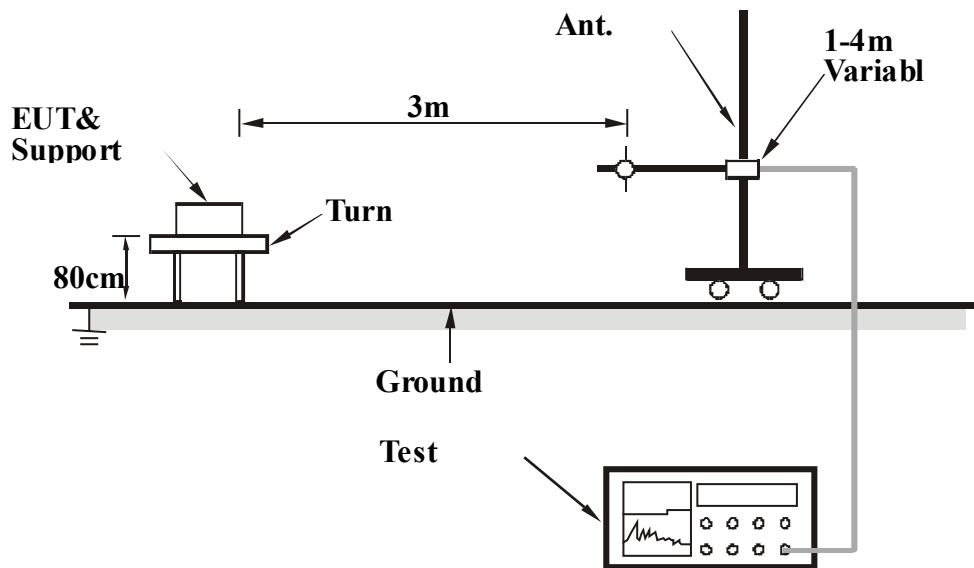

For the actual test configuration, please refer to the related Item - Photographs of the Test Configuration.

4.2.6 EUT OPERATING CONDITIONS

Same as 4.1.6

4.2.7 TEST RESULTS

EUT	Graphire 3 wireless Tablet		
MODEL	CTE - 630BT	FREQUENCY RANGE	9 kHz ~ 30 MHz
INPUT POWER	120Vac, 60 Hz	DETECTOR FUNCTION	Quasi-Peak, 120kHz
ENVIRONMENTAL CONDITIONS	20 deg. C, 90%RH, 984 hPa	TESTED BY	Eric Lee

ANTENNA POLARITY & TEST DISTANCE: 3 M								
No.	Freq. (MHz)	Emission Level (dBuV/m)	Limit (dBuV/m)	Margin (dB)	Antenna Height (m)	Table Angle (Degree)	Raw Value (dBuV)	Correction Factor (dB/m)
1	0.75	47.30 QP	70.10	-22.8	1.00 H	181	47.20	0.10
2	1.50	28.50 QP	56.00	-27.5	1.00 H	167	28.40	0.10
3	2.25	34.70 QP	69.54	-34.84	1.00 H	124	34.60	0.10
4	2.75	24.60 QP	69.54	-44.94	1.00 H	200	24.40	0.20
5	3.75	29.60 QP	69.54	-39.94	1.00 H	183	29.40	0.20
6	4.49	21.00 QP	69.54	-48.54	1.00 H	207	20.80	0.20
7	5.25	25.70 QP	69.54	-43.84	1.00 H	160	25.50	0.20
8	5.99	22.00 QP	69.54	-47.54	1.00 H	261	21.80	0.20
9	6.74	22.60 QP	69.54	-46.94	1.00 H	174	22.40	0.20
10	7.51	23.60 QP	69.54	-45.94	1.00 H	160	23.40	0.20

- REMARKS:**
1. Emission level(dBuV/m)=Raw Value(dBuV) + Correction Factor(dB)
 2. Correction Factor(dB/m) = Antenna Factor (dB/m) + Cable Factor (dB)
 3. The other emission levels were very low against the limit.
 4. Margin value = Emission level – Limit value.
 5. Above limits have been translated by the formula

The measured field strength was extrapolated to distance 30 meters, using the formula that the limit of field strength varies as the inverse distance square (40dB per decade of distance)

Example:

$$\begin{aligned}
 24000/750\text{KHz} &= 32 \text{ uV/m} && 30\text{m} \\
 &= 30.10 \text{ dBuV/m} && 30\text{m} \\
 &= 30.10 + 20\log(30/3)^2 && 3\text{m} \\
 &= 70.10 \text{ dBuV/m}
 \end{aligned}$$



EUT	Graphire 3 wireless Tablet		
MODEL	CTE - 630BT	FREQUENCY RANGE	30-1000 MHz
INPUT POWER (SYSTEM)	120Vac, 60Hz	DETECTOR FUNCTION & BANDWIDTH	Quasi-Peak, 120kHz
ENVIRONMENTAL CONDITIONS	20 deg. C, 60%RH, 984 hPa	TESTED BY	Sky Liao

ANTENNA POLARITY & TEST DISTANCE: HORIZONTAL AT 3 M

No.	Freq. (MHz)	Emission Level (dBuV/m)	Limit (dBuV/m)	Margin (dB)	Antenna Height (m)	Table Angle (Degree)	Raw Value (dBuV)	Correction Factor (dB/m)
1	120.00	20.50 QP	43.50	-23.00	1.35 H	325	9.10	11.50
2	200.00	23.60 QP	43.50	-19.90	1.08 H	35	12.50	11.20
3	240.00	32.80 QP	46.00	-13.20	1.47 H	230	19.90	12.90
4	419.53	26.50 QP	46.00	-19.50	1.17 H	1	7.60	18.90
5	600.00	27.50 QP	46.00	-18.50	1.40 H	55	4.00	23.50
6	733.34	32.60 QP	46.00	-13.40	1.84 H	155	6.70	25.90
7	800.01	28.00 QP	46.00	-18.00	1.63 H	351	1.30	26.60
8	866.67	30.80 QP	46.00	-15.20	1.90 H	66	3.20	27.60
9	933.33	32.50 QP	46.00	-13.50	1.42 H	165	4.00	28.50
10	1000.01	34.60 QP	54.00	-19.40	1.59 H	162	5.60	28.90

ANTENNA POLARITY & TEST DISTANCE: VERTICAL AT 3 M

No.	Freq. (MHz)	Emission Level (dBuV/m)	Limit (dBuV/m)	Margin (dB)	Antenna Height (m)	Table Angle (Degree)	Raw Value (dBuV)	Correction Factor (dB/m)
1	120.00	24.70 QP	43.50	-18.80	1.27 V	306	13.20	11.50
2	200.00	22.60 QP	43.50	-20.90	1.01 V	354	11.40	11.20
3	240.01	26.60 QP	46.00	-19.40	1.27 V	270	13.70	12.90
4	419.54	24.10 QP	46.00	-21.90	1.00 V	20	5.20	18.90
5	600.01	27.40 QP	46.00	-18.60	2.20 V	161	3.90	23.50
6	733.33	31.90 QP	46.00	-14.10	1.81 V	16	6.00	25.90
7	800.01	25.20 QP	46.00	-20.80	1.46 V	158	-1.40	26.60
8	866.66	31.20 QP	46.00	-14.80	1.12 V	178	3.60	27.60
9	933.33	32.60 QP	46.00	-13.40	1.55 V	234	4.00	28.50
10	1000.00	32.70 QP	54.00	-21.30	1.64 V	18	3.80	28.90

- REMARKS:**
1. Emission level(dBuV/m)=Raw Value(dBuV) + Correction Factor(dB)
 2. Correction Factor(dB/m) = Antenna Factor (dB/m) + Cable Factor (dB)
 3. The other emission levels were very low against the limit.
 4. Margin value = Emission level – Limit value.

4.2.8 TEST RESULTS (SPECTRUM BANDWIDTH)

750 KHz

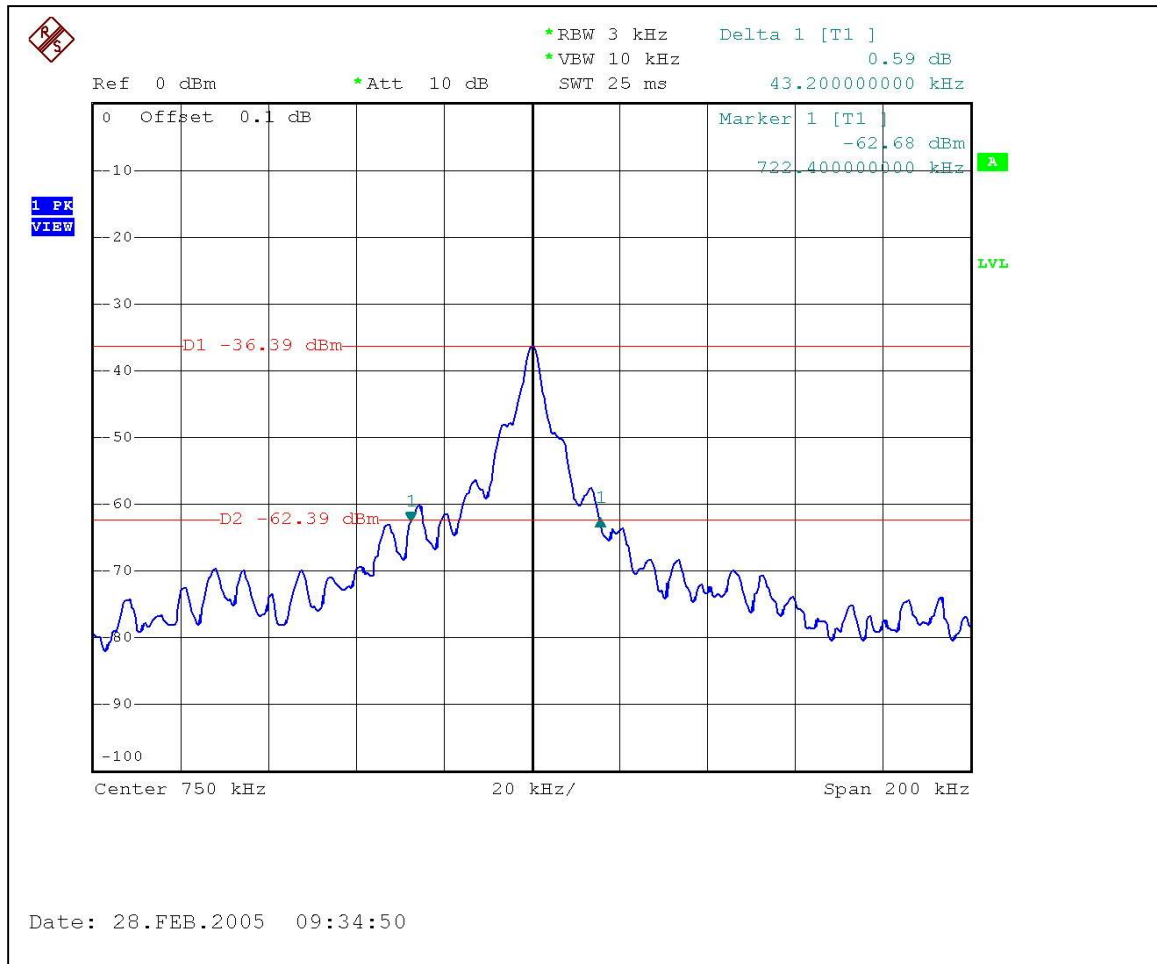

5 PHOTOGRAPHS OF THE TEST CONFIGURATION

CONDUCTED EMISSION TEST



RADIATED EMISSION TEST

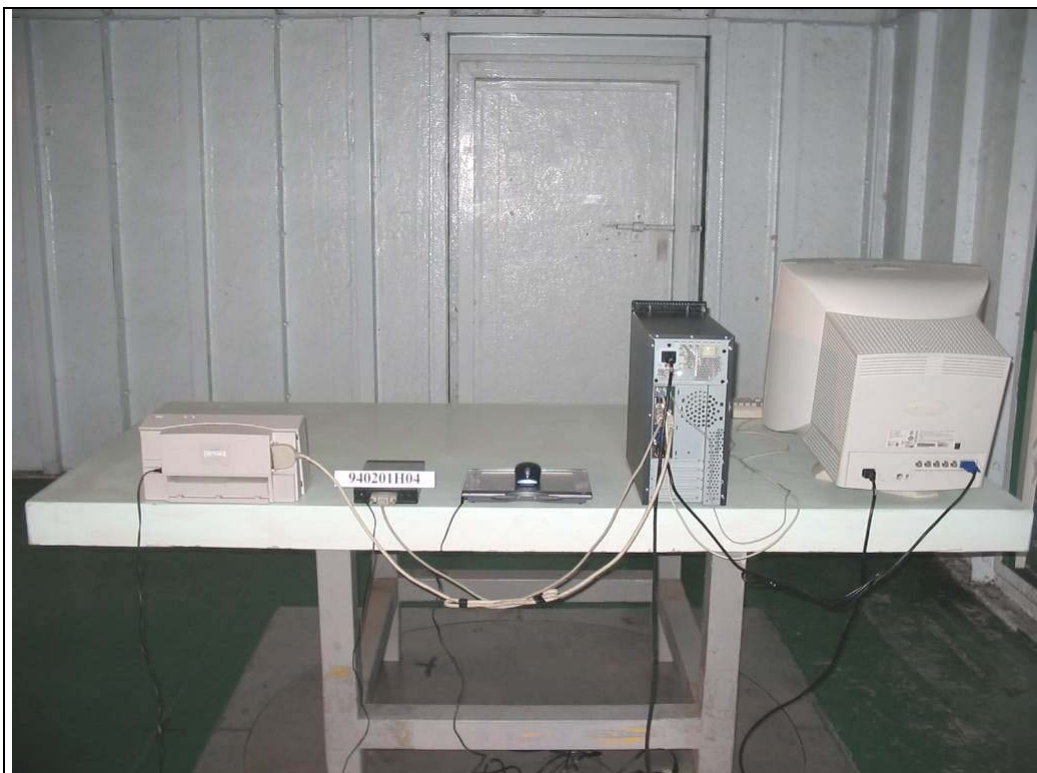



6 APPENDIX - INFORMATION ON THE TESTING LABORATORIES

We, ADT Corp., were founded in 1988 to provide our best service in EMC, Radio, Telecom and Safety consultation. Our laboratories are accredited and approved by the following approval agencies according to ISO/IEC 17025:

USA	FCC, NVLAP, UL, A2LA
Germany	TUV Rheinland
Japan	VCCI
Norway	NEMKO
Canada	INDUSTRY CANADA , CSA
R.O.C.	CNLA, BSMI, DGT
Netherlands	Telefication
Singapore	PSB , GOST-ASIA(MOU)
Russia	CERTIS(MOU)

Copies of accreditation certificates of our laboratories obtained from approval agencies can be downloaded from our web site: www.adt.com.tw/index.5/phtml.
If you have any comments, please feel free to contact us at the following:

Linko EMC/RF Lab:
Tel: 886-2-26052180
Fax: 886-2-26052943

Hsin Chu EMC/RF Lab:
Tel: 886-3-5935343
Fax: 886-3-5935342

Hwa Ya EMC/RF/Safety/Telecom Lab:
Tel: 886-3-3183232
Fax: 886-3-3185050

Email: service@adt.com.tw

Web Site: www.adt.com.tw

The address and road map of all our labs can be found in our web site also.