



**Spectrum Research
& Testing Lab., Inc.**

No. 101-10, Ling 8,
Shan-Tong Li, Chung-Li
City, Taoyuan, Taiwan,
R.O.C.

TEST REPORT

Reference No.:A03050604
Report No.:FCCA03050604
Page:1 of 24
Date:Jun. 16, 2003

Product Name: Graphire3 Tablet
Model No.: CTE-430
Applicant: Universal Scientific Industrial Co., Ltd.
141, Lane 351, Taiping Rd., Sec. 1, Sao Tuen, Nan-Tou,
Taiwan, R.O.C.
Date of Receipt: May 06, 2003
Finished date of Test: May 26, 2003
Applicable Standards: 47 CFR Part 15, Subpart C, Class B
ANSI C63.4:1992

We, **Spectrum Research & Testing Laboratory Inc.**, hereby certify that one sample of the above was tested in our laboratory with positive results according to the above-mentioned standards. The records in the report are an accurate account of the results. Details of the results are given in the subsequent pages of this report.

Checked By : Sunyou Chen , Date: 6/16/2003
(Sunyou Chen)

Approved By : Johnson Ho , Date: 6/16/2003
(Johnson Ho, Director)



Table of Contents

1.	DOCUMENT POLICY AND TEST STATEMENT	3
1.1	DOCUMENT POLICY	3
1.2	TEST STATEMENT	3
2.	DESCRIPTION OF EUT AND TEST MODE	4
2.1	GENERAL DESCRIPTION OF EUT	4
2.2	DESCRIPTION OF EUT INTERNAL DEVICE	4
2.3	DESCRIPTION OF TEST MODE	5
2.4	DESCRIPTION OF SUPPORT UNIT	5
3.	DESCRIPTION OF APPLIED STANDARDS	5
4.	CONDUCTED EMISSION TEST	6
4.1	CONDUCTED EMISSION LIMIT	6
4.2	TEST EQUIPMENT	6
4.3	TEST SETUP	7
4.4	TEST PROCEDURE	7
4.5	EUT OPERATING CONDITION	7
4.6	TEST RESULT	8
5.	RADIATED EMISSION TEST	10
5.1	RADIATED EMISSION LIMIT	10
5.2	TEST EQUIPMENT	11
5.3	TEST SET-UP	12
5.4	TEST PROCEDURE	13
5.5	EUT OPERATING CONDITION	13
5.6	RADIATED EMISSION TEST RESULT	14
6.	PHOTOS OF TESTING	18
7.	TERMS OF ABRIVATION	24



1. DOCUMENT POLICY AND TEST STATEMENT

1.1 DOCUMENT POLICY

- The report shall not be reproduced except in full, without the written approval of SRT Lab, Inc.
- The report must not be used by the applicant to claim that the product is endorsed by NVLAP, TÜV, NEMKO and SRT.
- The NVLAP logo applies only to the applicable standards specified in this report.

1.2 TEST STATEMENT

- The test results in the report apply only to the unit tested by SRT Lab.
- There was no deviation from the requirements of test standards during the test.
- AC power source, 120 Vac/60 Hz, was used during the test.



2. DESCRIPTION OF EUT AND TEST MODE

2.1 GENERAL DESCRIPTION OF EUT

PRODUCT	Graphire3 Tablet
MODEL NO.	CTE-430
POWER SUPPLY	DC 5V
CABLE	Shielded USB cable (1.5m)
I/O PORT	N/A
FREQUENCY BAND	490kHz ~ 1.705MHz
CARRIER FREQUENCY	750kHz \pm 10%
NUMBER OF CHANNEL	1
CHANNEL SPACING	0
ANTENNA TYPE	Integral

NOTE:

The EUT has two support units on market, Graphire3 Pen and Graphire3 Mouse.

Support Unit	Model No.	Physical size	Weight
Graphire3 Pen	EP-130	L x D : 145 x 12.5 mm (5.71 x 0.49 in)	11 g (0.02 lb), approximately
Graphire3 Mouse	EC-130	L x W x H : 115 x 60 x 38 mm (4.53 x 2.36 x 1.50 in)	90 g (0.2 lb), approximately

For more detailed information, please refer to the EUT' s specification or user' s manual provided by manufacturer.

2.2 DESCRIPTION OF EUT INTERNAL DEVICE

DEVICE	BRAND / MAKER	MODEL #	FCC ID/DOC	REMARK
N/A				

NOTE :

1. The highest clock : CTE-430 is 6MHz.
2. Frequency range to be measured.
Radiated emission is 30 MHz to 1 GHz.

**Spectrum Research & Testing Lab., Inc.**

No. 101-10, Ling 8,
Shan-Tong Li, Chung-Li
City, Taoyuan, Taiwan,
R.O.C.

TEST REPORT

Reference No.:A03050604
Report No.:FCCA03050604
Page:5 of 24
Date:Jun. 16, 2003

2.3 DESCRIPTION OF TEST MODE

The EUT was tested for emission measurement under the following situations:

Mode	Model No.	Support Units
Mode 1	CTE-430	Graphire3 Pen
Mode 2		Graphire3 Mouse

2.4 DESCRIPTION OF SUPPORT UNIT

The EUT was configured by the requirement of ANSI C63.4:1992 and CISRP22:1997. All interface ports were connected to the appropriate support units via specific cables. The support units and cables are listed below.

NO	DEVICE	BRAND	MODEL #	FCC ID / DOC	CABLE
1	NOTEBOOK	DELL	VDA9950	DOC	1.5m unshielded power cord
2	PRINTER	EPSON	STYLUS C20SX	DOC	1.5m unshielded power cord 1.2m shielded data cable
3	MODEM	ACEEX	DM-1414	DOC	1.5m unshielded power cord 1.2m shielded data cable

NOTE : For the actual test configuration, please refer to the photos of testing.

3. DESCRIPTION OF APPLIED STANDARDS

The EUT is a kind of ITE and according to the specifications provided by the applicant, it must comply with the requirements of the following standards:

47 CFR Part 15, Subpart C

ANSI C63.4:1992

All tests have been performed and recorded as per the above standards.



4. CONDUCTED EMISSION TEST

4.1 CONDUCTED EMISSION LIMIT

FREQUENCY (MHz)	Class A (dBmV)		Class B (dBmV)	
	Quasi-peak	Average	Quasi-peak	Average
0.15 - 0.5	79	66	66 - 56	56 - 46
0.5 - 5.0	73	60	56	46
5.0 - 30.0	73	60	60	50

NOTE:

1. The lower limit shall apply at the transition frequencies.
2. The limit decreases in line with the logarithm of the frequency in the range of 0.15 to 0.50 MHz.

4.2 TEST EQUIPMENT

The following test equipment was used for the test:

EQUIPMENT/ FACILITIES	SPECIFICATIONS	MANUFACTURER	MODEL#/ SERIAL#	DUE DATE OF CAL. & CAL. CENTER
EMI TEST RECEIVER	9 kHz TO 30 MHz	ROHDE & SCHWARZ	ESHS30/ 826003/008	JUL. 2003 R&S
LISN (for EUT)	50 μH, 50 ohm	SOLAR ELECTRONICS	8012-50-R-24-BNC / 924839	JUN. 2004 ETC
LISN (for Peripheral)	50μH, 50 ohm	SOLAR ELECTRONICS	9252-50-R-24-BNC / 951318	JUN. 2004 ETC
50 ohm TERMINATOR	50 ohm	HP	11593A/ 2	MAY 2004 ETC
COAXIAL CABLE	3m	SUNCITY	J400/ 3M	JUL. 2003 SRT
ISOLATION TRANSFORMER	N/A	APC	AFC-11015/ F102040016	N/A
FILTER	2 LINE, 30A	FIL.COIL	FC-943/ 771	N/A
GROUND PLANE	2.3M (H) x 2.4M (W)	SRT	N/A	APR. 2004 SRT
GROUND PLANE	2.4M (H) x 2.4M (W)	SRT	N/A	APR. 2004 SRT

NOTE: The calibration interval of the above test equipment is one year and the calibrations are traceable to NML/ROC and NIST/USA.



4.3 TEST SETUP

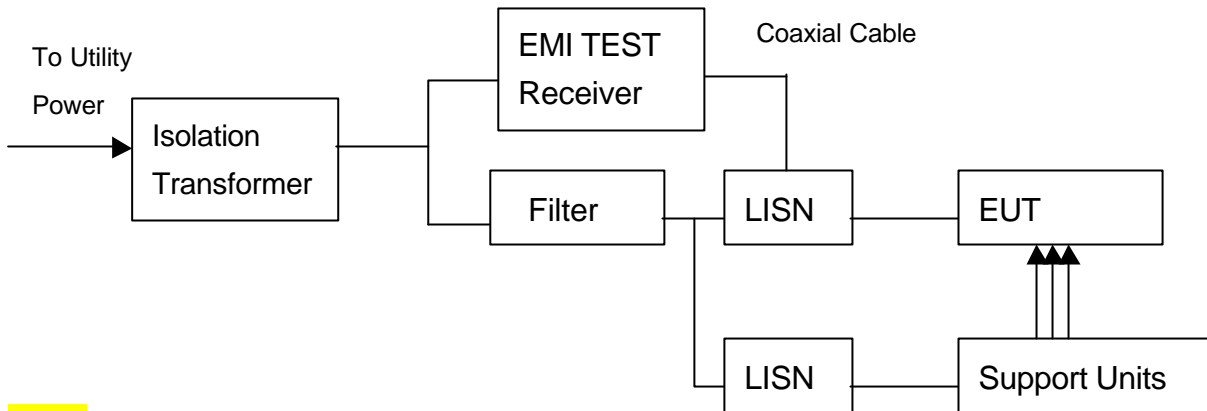

NOTE:

1. The EUT was put on a wooden table with 0.8m height above ground plane, and 0.4m away from reference ground plane (> 2mx2m).
2. For the actual test configuration, please refer to the photos of testing.
3. The serial no. of the LISN connected to EUT is 951318.
4. The serial no. of the LISN connected to support units is 924839.

4.4 TEST PROCEDURE

The EUT was tested according to the requirement of ANSI C63.4:1992 and CISRP22:1997. The frequency spectrum from 0.15 MHz to 30 MHz was investigated. The LISN used was 50 ohm/50 μ H as specified. All readings were quasi-peak and average values with 10 kHz resolution bandwidth of the test receiver. The EUT system was operated in all typical methods by users. Both lines of the power mains of EUT were measured and the cables connected to EUT and support units were moved to find the maximum emission levels for each frequency. First, Find the margin or higher points at least 6 points by software, then use manual to find the maximum data. The procedure is referred on the test procedure of SRT LAB.

4.5 EUT OPERATING CONDITION

1. Under Windows XP ran "EMI TEST" program.
2. Notebook PC sent "H" pattern or accessed the following peripherals directly or via EUT:
 - Color Monitor
 - RS232
 - Keyboard
 - Mouse
 - Printer
 - FDD
 - HDD



4.6 TEST RESULT

Temperature:	<u>25 °C</u>	Humidity:	<u>55 %RH</u>
Ferquency Range:	<u>0.15 – 30 MHz</u>	Test Mode:	<u>1</u>
Receiver Detector:	<u>Q.P. and AV.</u>	Tested By:	<u>Ken Su</u>
		Tested Date:	<u>May 22, 2003</u>

Power Line Measured : Line

Freq. (MHz)	Correct. Factor (dB)	Reading Value (dBmV)		Emission Level (dBmV)		Limit (dBmV)		Margin (dB)	
		Q.P.	AV.	Q.P.	AV.	Q.P.	AV.	Q.P.	AV.
0.244	0.20	34.5	-	34.7	-	62.0	52.0	-27.3	N/A
0.775	0.20	26.7	24.6	26.9	24.8	56.0	46.0	-29.1	-21.2
1.886	0.20	24.9	11.4	25.1	11.6	56.0	46.0	-30.9	-34.4
3.692	0.26	26.5	16.8	26.8	17.1	56.0	46.0	-29.2	-28.9
5.437	0.32	22.7	9.1	23.0	9.4	60.0	50.0	-37.0	-40.6
10.220	0.40	20.2	12.7	20.6	13.1	60.0	50.0	-39.4	-36.9

Power Line Measured : Neutral

Freq. (MHz)	Correct. Factor (dB)	Reading Value (dBmV)		Emission Level (dBmV)		Limit (dBmV)		Margin (dB)	
		Q.P.	AV.	Q.P.	AV.	Q.P.	AV.	Q.P.	AV.
0.232	0.20	39.9	31.1	40.1	31.3	62.4	52.4	-22.3	-21.1
0.304	0.20	36.1	31.8	36.3	32.0	60.0	50.1	-23.8	-18.1
2.100	0.20	12.2	7.5	12.4	7.7	56.0	46.0	-43.6	-38.3
3.759	0.27	26.0	15.9	26.3	16.2	56.0	46.0	-29.7	-29.8
10.060	0.40	30.4	27.4	30.8	27.8	60.0	50.0	-29.2	-22.2
18.751	0.57	30.5	23.4	31.1	24.0	60.0	50.0	-28.9	-26.0

NOTE :

1. Measurement uncertainty is +/-2dB
2. Emission level = Reading value + Correction factor
3. Correction Factor = Cable loss + Insertion loss of LISN
4. Margin value = Emission level - Limit
5. The emission of other frequencies were very low against the limit.
6. "-": The Quasi-peak reading value also meets average limit and measurement with the average detector is unnecessary.



TEST REPORT

Temperature:	<u>24 °C</u>	Humidity:	<u>58 %RH</u>
Ferquency Range:	<u>0.15 – 30 MHz</u>	Test Mode:	<u>2</u>
Receiver Detector:	<u>Q.P. and AV.</u>	Tested By:	<u>Tom Lin</u>
		Tested Date:	<u>May 08, 2003</u>

Power Line Measured : Line

Freq. (MHz)	Correct. Factor (dB)	Reading Value (dBmV)		Emission Level (dBmV)		Limit (dBmV)		Margin (dB)	
		Q.P.	AV.	Q.P.	AV.	Q.P.	AV.	Q.P.	AV.
0.228	0.20	37.6	32.8	37.8	33.0	62.5	52.5	-24.7	-19.5
0.298	0.20	25.3	31.8	25.5	32.0	60.3	50.3	-34.8	-18.3
1.845	0.20	19.1	16.6	19.3	16.8	56.0	46.0	-36.7	-29.2
3.521	0.25	24.4	17.3	24.7	17.6	56.0	46.0	-31.4	-28.5
4.966	0.31	19.1	-	19.4	-	56.0	46.0	-36.6	N/A
18.747	0.57	27.7	21.9	28.3	22.5	60.0	50.0	-31.7	-27.5

Power Line Measured : Neutral

Freq. (MHz)	Correct. Factor (dB)	Reading Value (dBmV)		Emission Level (dBmV)		Limit (dBmV)		Margin (dB)	
		Q.P.	AV.	Q.P.	AV.	Q.P.	AV.	Q.P.	AV.
0.173	0.20	46.8	36.6	47.0	36.8	64.8	54.8	-17.8	-18.0
0.302	0.20	36.3	32.2	36.5	32.4	60.2	50.2	-23.7	-17.8
1.857	0.20	18.0	-	18.2	-	56.0	46.0	-37.8	N/A
3.525	0.25	23.0	-	23.3	-	56.0	46.0	-32.8	N/A
15.271	0.50	20.9	-	21.4	-	60.0	50.0	-38.6	N/A
20.251	0.60	30.2	24.0	30.8	24.6	60.0	50.0	-29.2	-25.4

NOTE :

1. Measurement uncertainty is +/-2dB
2. Emission level = Reading value + Correction factor
3. Correction Factor = Cable loss + Insertion loss of LISN
4. Margin value = Emission level - Limit
5. The emission of other frequencies were very low against the limit.
6. "-": The Quasi-peak reading value also meets average limit and measurement with the average detector is unnecessary.



5. RADIATED EMISSION TEST

5.1 RADIATED EMISSION LIMIT

FCC Part 15, Subpart B Section 15.209.

FREQUENCY (MHz)	DISTANCE (m)	FIELD STRENGTH (mV/m)
0.009 - 0.490	300	2400/F(kHz)
0.490-1.705	300	24000/F(kHz)
1.705-30.0	30	30
30 - 88	3	100
88 - 216	3	150
216 - 960	3	200
ABOVE 960	3	500

NOTE :

1. In the emission tables above, the tighter limit applies at the band edges.
2. Distance refers to the distance between measuring instrument, antenna, and the closest point of any part of the device or system.

FCC Part 15, Subpart A Section 15.31(f)(2) Extrapolation factor of 40 dB/decade for measurement distances different than specified in with limits for frequencies below 30 MHz.

FCC Part15, Subpart C Section 15.209 limit of radiated emission for frequency below1000MHz. The emissions from an intentional radiator shall not exceed the field strength levels specified in the following table:

FREQUENCY (MHz)	DISTANCE (m)	FIELD STRENGTH (dBmV/m)
30 - 88	3	40.0
88 - 216	3	43.5
216 - 960	3	46.0
Above 960	3	54.0

NOTE :

1. In the emission tables above , the tighter limit applies at the band edges.
2. Distance refers to the distance between measuring instrument, antenna, and the closest point of any part of the device or system.

**Spectrum Research
& Testing Lab., Inc.**No. 101-10, Ling 8,
Shan-Tong Li, Chung-Li
City, Taoyuan, Taiwan,
R.O.C.**TEST REPORT**Reference No.:A03050604
Report No.:FCCA03050604
Page:11 of 24
Date:Jun. 16, 2003**5.2 TEST EQUIPMENT**

The following test equipment was used during the radiated emission test:

EQUIPMENT/ FACILITIES	SPECIFICATIONS	MANUFACTURER	MODEL#/ SERIAL#	DUE DATE OF CAL. & CAL. CENTER
EMI TEST RECEIVER	9 kHz TO 2750 MHz	ROHDE & SCHWARZ	ESCS30/ 830245/012	AUG. 2003 R&S
BI-LOG ANTENNA	25 MHz TO 2 GHz	EMCO	3142/ 9701-1124	APR. 2004 SRT
OATS	3 – 10 M MEASUREMENT	SRT	SRT-1	APR. 2004 SRT
COAXIAL CABLE	25M	SUNCITY	J400/ 25M	JUL. 2003 SRT
FILTER	2 LINE, 30A	FIL.COIL	FC-943/ 869	N/A
FREQUENCY CONVERTER	N/A	APC	AFC-1KW/ 860612	JUL. 2003 SRT
LOOP ANTENNA	9 kHz TO 30 MHz	SCHWARZ	FHF2-Z2/ 1162 1/2	AUG. 2003 R&S
ANECHOIC CHAMBER	733	SRT	A03/ SRT003	DEC. 2003 SRT

NOTE:

1. The calibration interval of the above test equipment is one year and the calibrations are traceable to NML/ROC and NIST/USA.
2. The Open Area Test Site (SRT-1) is registered by FCC with No. 90957 and VCCI with No. R-1081.
3. The Open Area Test Site (SRT-2) is registered by FCC with No. 98458 and VCCI with No. R-1168.



5.3 TEST SET-UP

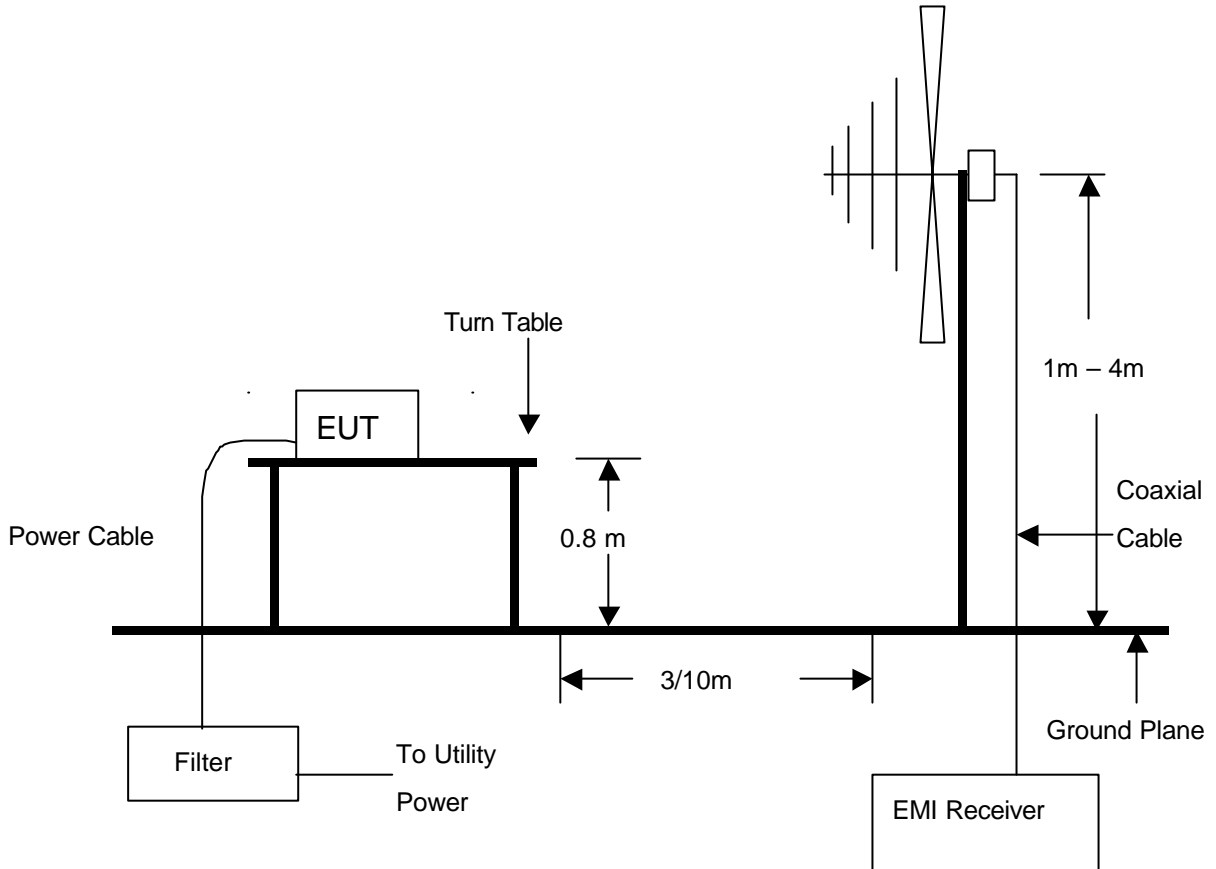

NOTE :

1. The EUT system was put on a wooden table with 0.8m heights above a ground plane.
2. For the actual test configuration, please refer to the photos of testing.



5.4 TEST PROCEDURE

The EUT was tested according to the requirement of ANSI C63.4:1992 and CISPR 22:1997. The measurements were made at an open area test site with 10 meter measurement distance under 1 GHz and with 3m distance above 1GHz. The frequency spectrum measured started from 30 MHz. Under 1 GHz, all readings were quasi-peak values with 120 kHz resolution bandwidth of the test receiver. Above 1 GHz, the measurements were made at an open area test site with 3 meter measurement distance and all readings were peak or average values with 1 MHz resolution bandwidth of the test receiver. The EUT system was operated in all typical methods by users. The cables connected to EUT and support units were moved to find the maximum emission levels for each frequency. First, Find the margin or higher points at least 6 points by software, then use manual to find the maximum data. The procedure is referred on the test procedure of SRT LAB.

5.5 EUT OPERATING CONDITION

Same as section 4.5 of this report.



5.6 RADIATED EMISSION TEST RESULT

Temperature:	<u>23 °C</u>	Humidity:	<u>40 %RH</u>
Ferquency Range:	<u>490 kHz – 30 MHz</u>	Measured Distance:	<u>1m</u>
Receiver Detector:	<u>Q.P.</u>	Tested Mode:	<u>1</u>
Tested By:	<u>Ken Su</u>	Tested Date:	<u>May 22, 2003</u>

Frequency (kHz)	Cable Loss (dB)	Antenna Factor (dB/m)	Reading Data (dBμV)	Emission Level (dBμV/m)	Limit (dBμV/m)	Margin (dB)
750.0000(F)	0.2	20.0	53.6	73.8	89.1	-15.6
1500.0000	0.2	20.0	46.8	67.0	89.1	-16.2
2250.0000	0.2	20.0	42.1	62.3	89.1	-26.8
3000.0000	0.2	20.0	39.2	59.4	89.1	-29.67
3753.0000	0.2	20.0	38.5	58.7	89.1	-30.4
4500.0000	0.2	20.0	44.6	64.8	89.1	-33.3
5250.0000	0.2	20.0	39.4	59.6	89.1	-29.5

- NOTE :**
1. Measurement uncertainty is less than +/- 4dB
 2. "": Measurement does not apply for this frequency.
 3. Emission Level = Reading Value + Ant. Factor + Cable Loss
 4. Limit(dBuV/m)=20log{24000/F(kHz)}(The measurement distance at 300m)
+40log(300/1)(The measurement distance at 1m)
 5. The field strength of other emission frequencies were very low against the limit.
 6. (F) : Fundamental frequency of transmitter.

**Spectrum Research & Testing Lab., Inc.**No. 101-10, Ling 8,
Shan-Tong Li, Chung-Li
City, Taoyuan, Taiwan,
R.O.C.**TEST REPORT**Reference No.:A03050604
Report No.:FCCA03050604
Page:15 of 24
Date:Jun. 16, 2003

Temperature:	<u>23 °C</u>	Humidity:	<u>40 %RH</u>
Ferquency Range:	<u>490 kHz – 30 MHz</u>	Measured Distance:	<u>1m</u>
Receiver Detector:	<u>Q.P.</u>	Tested Mode:	<u>2</u>
Tested By:	<u>Ken Su</u>	Tested Date:	<u>May 22, 2003</u>

Frequency (kHz)	Cable Loss (dB)	Antenna Factor (dB/m)	Reading Data (dBμV)	Emission Level (dBμV/m)	Limit (dBμV/m)	Margin (dB)
750.0000(F)	0.2	20.0	52.1	72.3	89.1	-17.1
1500.0000	0.2	20.0	45.6	66.8	89.1	-17.4
2250.0000	0.2	20.0	43.5	63.7	89.1	-25.4
3000.0000	0.2	20.0	40.3	60.5	89.1	-28.5
3753.0000	0.2	20.0	38.1	58.3	89.1	-30.0
4500.0000	0.2	20.0	43.2	63.4	89.1	-34.7
5250.0000	0.2	20.0	39.5	59.7	89.1	-29.4

- NOTE :**
1. Measurement uncertainty is less than +/- 4dB
 2. "": Measurement does not apply for this frequency.
 3. Emission Level = Reading Value + Ant. Factor + Cable Loss
 4. $Limit(dBuV/m)=20\log\{24000/F(kHz)\}$ (The measurement distance at 300m)
+40log(300/1)(The measurement distance at 1m)
 5. The field strength of other emission frequencies were very low against the limit.
 6. (F) : Fundamental frequency of transmitter.

**Spectrum Research & Testing Lab., Inc.**No. 101-10, Ling 8,
Shan-Tong Li, Chung-Li
City, Taoyuan, Taiwan,
R.O.C.**TEST REPORT**Reference No.:A03050604
Report No.:FCCA03050604
Page:16 of 24
Date:Jun. 16, 2003

Temperature:	<u>23 °C</u>	Humidity:	<u>40 %RH</u>
Ferquency Range:	<u>30 – 1000 MHz</u>	Measured Distance:	<u>3m</u>
Receiver Detector:	<u>Q.P.</u>	Tested Mode:	<u>1</u>
Tested By:	<u>Ken Su</u>	Tested Date:	<u>May 23, 2003</u>

Antenna Polarization:Horizontal

Frequency (MHz)	Cable Loss (dB)	Antenna Factor (dB/m)	Reading Data (dBμV)	Emission Level (dBμV/m)	Limit (dBμV/m)	Margin (dB)	AZ(°)	EL(m)
195.0750	1.61	10.35	25.3	37.3	43.5	-6.2	145.0	2.7
245.8790	1.98	12.48	24.1	38.6	46.0	-7.5	188.0	2.3
260.3210	1.94	13.00	24.3	39.2	46.0	-6.8	35.0	1.7
344.8720	2.26	15.20	21.3	38.8	46.0	-7.2	142.0	2.0
520.7500	3.30	18.50	16.2	38.0	46.0	-8.0	333.0	2.3
664.3750	2.57	21.00	18.2	41.8	46.0	-4.2	360.0	1.8

Antenna Polarization:Vertical

Frequency (MHz)	Cable Loss (dB)	Antenna Factor (dB/m)	Reading Data (dBμV)	Emission Level (dBμV/m)	Limit (dBμV/m)	Margin (dB)	AZ(°)	EL(m)
41.2470	1.32	14.04	22.4	37.8	40.0	-2.2	247.0	2.6
128.7570	1.61	10.35	28.8	38.4	43.5	-5.1	188.0	2.0
195.0750	1.61	10.35	25.1	37.1	43.5	-6.4	231.0	2.2
344.0820	2.26	15.20	26.1	43.6	46.0	-2.4	149.0	2.0
431.1500	2.66	16.67	17.5	36.8	46.0	-9.2	355.0	1.8
442.3660	2.32	16.85	19.7	38.9	46.0	-7.1	167.0	1.8

NOTE :

1. Measurement uncertainty is +/-4dB.
2. "*": Measurement does not apply for this frequency.
3. Emission Level = Reading Value + Ant. Factor + Cable Loss.
4. The field strength of other emission frequencies were very low against the limit.

**Spectrum Research & Testing Lab., Inc.**No. 101-10, Ling 8,
Shan-Tong Li, Chung-Li
City, Taoyuan, Taiwan,
R.O.C.**TEST REPORT**Reference No.:A03050604
Report No.:FCCA03050604
Page:17 of 24
Date:Jun. 16, 2003

Temperature:	<u>25 °C</u>	Humidity:	<u>55 %RH</u>
Ferquency Range:	<u>30 – 1000 MHz</u>	Measured Distance:	<u>3m</u>
Receiver Detector:	<u>Q.P.</u>	Tested Mode:	<u>2</u>
Tested By:	<u>Ken Su</u>	Tested Date:	<u>May 23, 2003</u>

Antenna Polarization:Horizontal

Frequency (MHz)	Cable Loss (dB)	Antenna Factor (dB/m)	Reading Data (dBμV)	Emission Level (dBμV/m)	Limit (dBμV/m)	Margin (dB)	AZ(°)	EL(m)
69.7300	1.04	8.07	24.3	33.4	40.0	-6.6	45.0	2.1
195.0330	1.61	10.35	25.1	37.1	43.5	-6.4	78.0	2.3
521.1320	3.29	18.53	18.7	40.5	46.0	-5.5	66.0	1.9
631.3300	2.71	20.79	17.5	41.0	46.0	-5.0	326.0	1.5
664.2110	2.57	21.00	18.2	41.8	46.0	-4.2	333.0	2.3

Antenna Polarization:Vertical

Frequency (MHz)	Cable Loss (dB)	Antenna Factor (dB/m)	Reading Data (dBμV)	Emission Level (dBμV/m)	Limit (dBμV/m)	Margin (dB)	AZ(°)	EL(m)
40.0230	1.35	14.40	22.1	37.9	40.0	-2.2	101.0	2.3
128.7500	1.36	8.22	29.8	39.4	43.5	-4.1	212.0	2.1
192.2010	1.60	10.26	27.8	39.7	43.5	-3.8	231.0	2.2
345.0240	2.27	15.23	26.3	43.8	46.0	-2.2	176.0	2.0
442.3600	2.32	16.85	20.6	39.8	46.0	-6.2	12.0	1.8
787.3500	2.47	22.17	15.3	39.9	46.0	-6.1	65.0	1.7

NOTE :

1. Measurement uncertainty is +/-4dB.
2. "**": Measurement does not apply for this frequency.
3. Emission Level = Reading Value + Ant. Factor + Cable Loss.
4. The field strength of other emission frequencies were very low against the limit.



6. PHOTOS OF TESTING

- Conducted test (Mode 1)

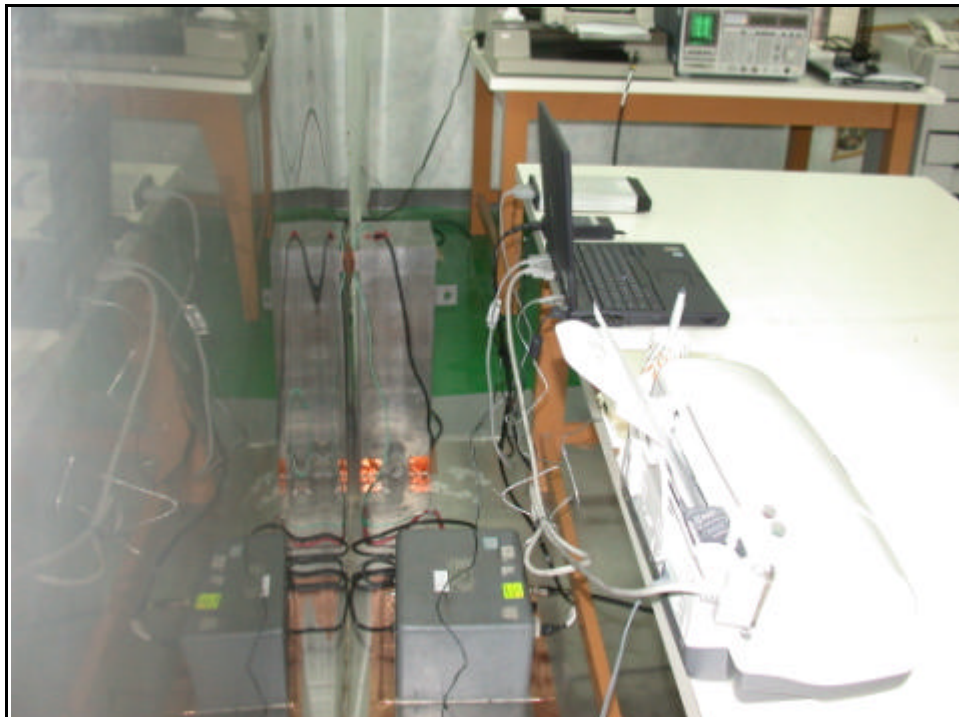



- Conducted test (Mode 2)

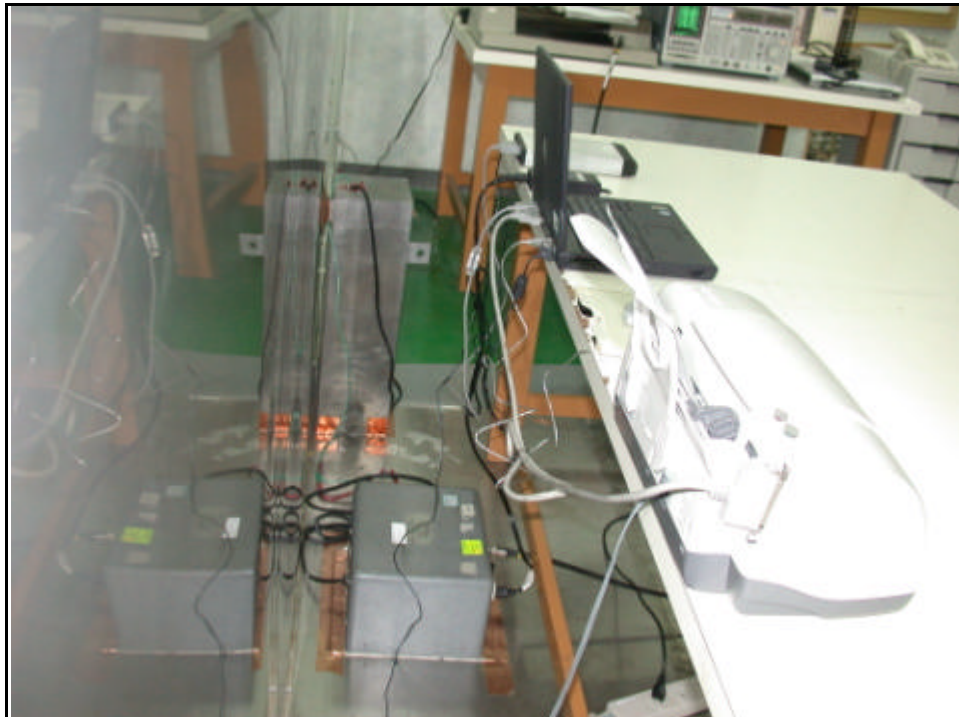



- Radiated test (Mode 1: 490kHz – 30MHz)





- Radiated test (Mode 2: 490kHz – 30MHz)

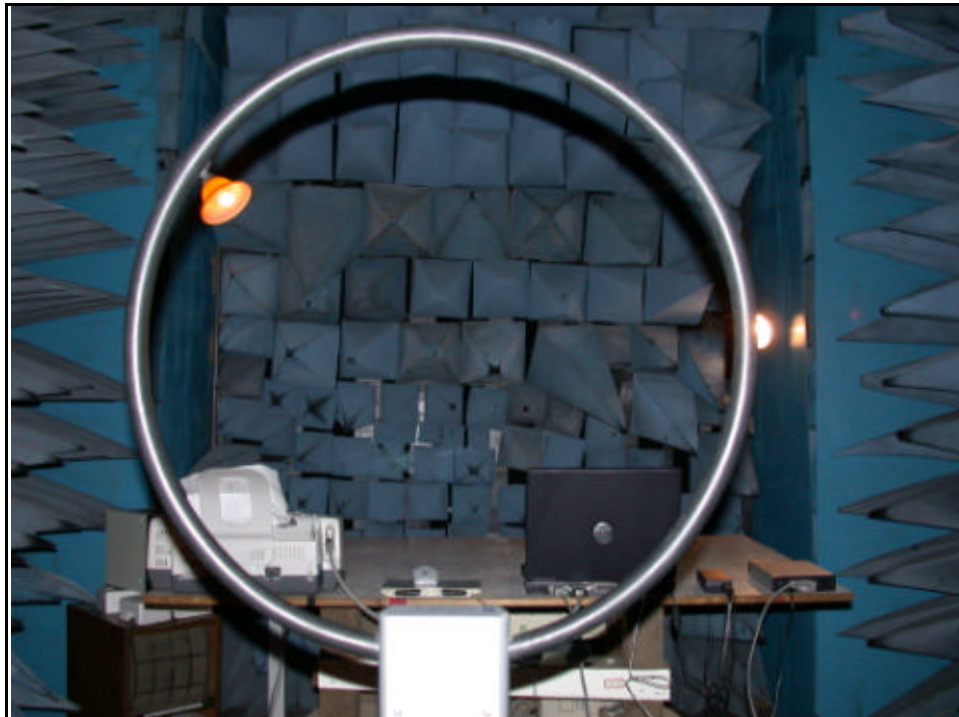
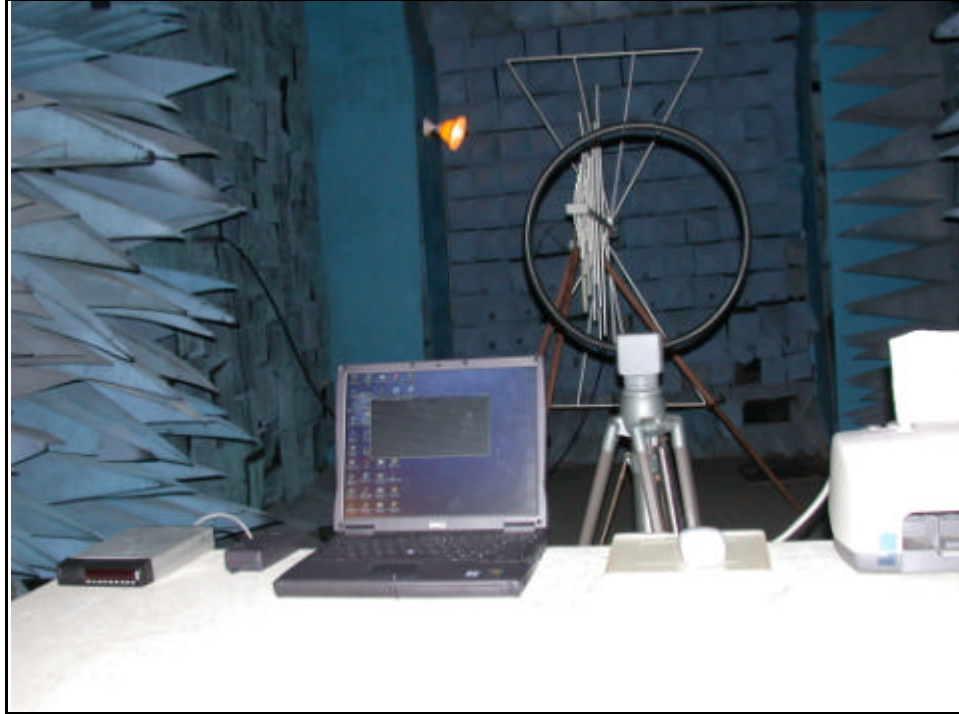



- Radiated test (Mode 1: 30MHz – 1000MHz)

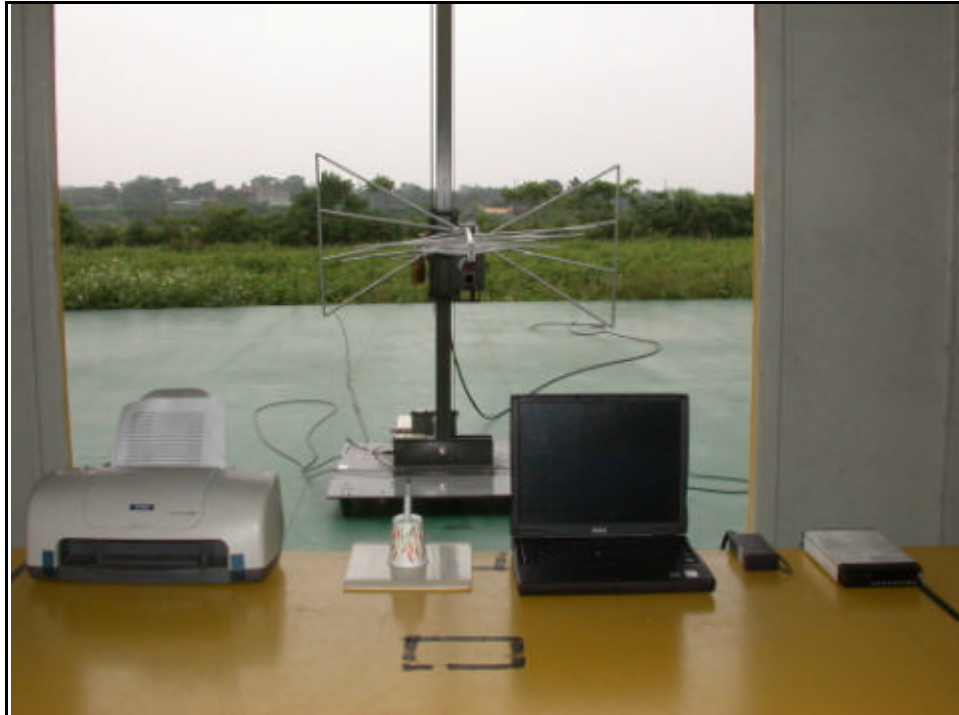



- Radiated test (Mode 2: 490kHz – 30MHz)

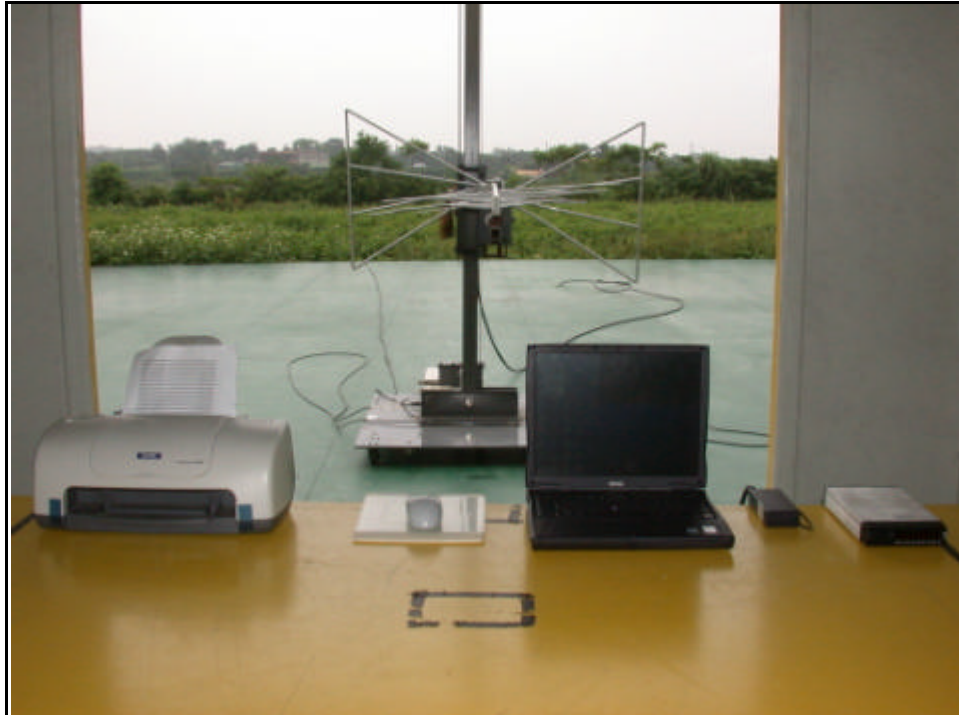

**Spectrum Research & Testing Lab., Inc.**

No. 101-10, Ling 8,
Shan-Tong Li, Chung-Li
City, Taoyuan, Taiwan,
R.O.C.

TEST REPORT

Reference No.:A03050604
Report No.:FCCA03050604
Page:24 of 24
Date:Jun. 16, 2003

7. TERMS OF ABRIVATION

AV.	Average detection
AZ(°)	Turn table azimuth
Correct.	Correction
EL(m)	Antenna height (meter)
EUT	Equipment Under Test
Horiz.	Horizontal direction
LISN	Line Impedance Stabilization Network
NSA	Normalized Site Attenuation
Q.P.	Quasi-peak detection
SRT Lab	Spectrum Research & Te sting Laboratory, Inc.
Vert.	Vertical direction