



FCC TEST REPORT

REPORT NO.: RF921107R02

MODEL NO.: AP-AG-AT-02, AP-AG-AT-04, RT-AG-AT-02

RECEIVED: Nov. 07, 2003

TESTED: Nov. 07, 2003 to Jan. 13, 2004

APPLICANT: UNIVERSAL SCIENTIFIC INDUSTRIAL CO., LTD.

ADDRESS: 141, Lane 351, Taiping Road, Sec. 1, Tsao Tuen,
Nan-Tou, Taiwan, R.O.C.

ISSUED BY: Advance Data Technology Corporation

LAB LOCATION: No. 81-1, Lu Liao Keng, 9 Ling, Wu Lung Tsuen,
Chiung Lin Hsiang, Hsin Chu Hsien,
Taiwan, R.O.C.

This test report consists of 487 pages in total. It may be duplicated completely for legal use with the approval of the applicant. It should not be reproduced except in full, without the written approval of our laboratory. The test results in the report only apply to the tested sample.



0536

ILAC MRA



Table of Contents

1.	CERTIFICATION	7
2.	SUMMARY OF TEST RESULTS.....	8
3.	GENERAL INFORMATION	11
3.1	GENERAL DESCRIPTION OF EUT.....	11
3.2	DESCRIPTION OF TEST MODES.....	15
3.3	GENERAL DESCRIPTION OF APPLIED STANDARDS	16
3.4	DESCRIPTION OF SUPPORT UNITS	17
4.	TEST TYPES AND RESULTS (For Part 802.11b).....	20
4.1	CONDUCTED EMISSION MEASUREMENT	20
4.1.1	LIMITS OF CONDUCTED EMISSION MEASUREMENT	20
4.1.2	TEST INSTRUMENTS	20
4.1.3	TEST PROCEDURES.....	21
4.1.4	DEVIATION FROM TEST STANDARD	21
4.1.5	TEST SETUP	22
4.1.6	EUT OPERATING CONDITIONS	22
4.1.7	TEST RESULTS (For 1 Ethernet port -Adapter 1)	23
4.1.8	TEST RESULTS (For 1 Ethernet port -Adapter 2)	25
4.1.9	TEST RESULTS (For 1 Ethernet port -POE).....	27
4.1.10	TEST RESULTS (For 3 Ethernet ports -Adapter 1).....	29
4.1.11	TEST RESULTS (For 3 Ethernet ports -Adapter 2).....	31
4.1.12	TEST RESULTS (For 3 Ethernet ports - POE)	33
4.2	Radiated Emission Measurement.....	35
4.2.1	LIMITS OF RADIATED EMISSION MEASUREMENT.....	35
4.2.2	TEST INSTRUMENTS	36
4.2.3	TEST PROCEDURES.....	37
4.2.4	DEVIATION FROM TEST STANDARD	37
4.2.5	TEST SETUP	38
4.2.6	EUT OPERATING CONDITIONS	38
4.2.7	TEST RESULTS	39
4.2.8	TEST RESULTS - DSSS (Antenna 1).....	81
4.2.9	TEST RESULTS - DSSS (Antenna 2).....	87
4.2.10	TEST RESULTS - DSSS (Antenna 3).....	93
4.2.11	TEST RESULTS - DSSS (Antenna 4).....	99
4.2.12	TEST RESULTS - DSSS (Antenna 5).....	105
4.2.13	TEST RESULTS - DSSS (Antenna 6).....	109
4.2.14	TEST RESULTS - DSSS (Antenna 7).....	112
4.2.15	TEST RESULTS - OFDM (Antenna 1).....	115
4.2.16	TEST RESULTS - OFDM (Antenna 2).....	121
4.2.17	TEST RESULTS - OFDM (Antenna 3).....	127
4.2.18	TEST RESULTS - OFDM (Antenna 4).....	133
4.2.19	TEST RESULTS - OFDM (Antenna 5).....	137



4.2.20	TEST RESULTS - OFDM (Antenna 6)	142
4.2.21	TEST RESULTS - OFDM (Antenna 7)	145
4.3	6dB BANDWIDTH MEASUREMENT	148
4.3.1	LIMITS OF 6dB BANDWIDTH MEASUREMENT	148
4.3.2	TEST INSTRUMENTS	148
4.3.3	TEST PROCEDURE	149
4.3.4	DEVIATION FROM TEST STANDARD	149
4.3.5	TEST SETUP	149
4.3.6	EUT OPERATING CONDITIONS	149
4.3.7	TEST RESULTS -DSSS	150
4.3.8	TEST RESULTS -OFDM	154
4.4	MAXIMUM PEAK OUTPUT POWER	158
4.4.1	LIMITS OF MAXIMUM PEAK OUTPUT POWER MEASUREMENT	158
4.4.2	INSTRUMENTS	158
4.4.3	TEST PROCEDURES	159
4.4.4	TEST SETUP	159
4.4.5	EUT OPERATING CONDITIONS	159
4.4.6	TEST RESULTS -DSSS	160
4.4.7	TEST RESULTS -OFDM	162
4.5	POWER SPECTRAL DENSITY MEASUREMENT	164
4.5.1	LIMITS OF POWER SPECTRAL DENSITY MEASUREMENT	164
4.5.2	TEST INSTRUMENTS	164
4.5.3	TEST PROCEDURE	165
4.5.4	DEVIATION FROM TEST STANDARD	165
4.5.5	TEST SETUP	165
4.5.6	EUT OPERATING CONDITION	165
4.5.7	TEST RESULTS-DSSS	166
4.5.8	TEST RESULTS-OFDM	170
4.6	BAND EDGES MEASUREMENT	174
4.6.1	LIMITS OF BAND EDGES MEASUREMENT	174
4.6.2	TEST INSTRUMENTS	174
4.6.3	TEST PROCEDURE	174
4.6.4	DEVIATION FROM TEST STANDARD	174
4.6.5	EUT OPERATING CONDITION	175
4.6.6	TEST RESULTS –DSSS (Antenna 1)	175
4.6.7	TEST RESULTS –DSSS (Antenna 2)	178
4.6.8	TEST RESULTS –DSSS (Antenna 3)	181
4.6.9	TEST RESULTS –DSSS (Antenna 4)	184
4.6.10	TEST RESULTS –DSSS (Antenna 5)	187
4.6.11	TEST RESULTS –DSSS (Antenna 6)	190
4.6.12	TEST RESULTS –DSSS (Antenna 7)	193
4.6.13	TEST RESULTS –OFDM (Antenna 1)	196
4.6.14	TEST RESULTS –OFDM (Antenna 2)	199
4.6.15	TEST RESULTS –OFDM (Antenna 3)	202



4.6.16	TEST RESULTS –OFDM (Antenna 4)	205
4.6.17	TEST RESULTS –OFDM (Antenna 5)	208
4.6.18	TEST RESULTS –OFDM (Antenna 6)	211
4.6.19	TEST RESULTS –OFDM (Antenna 7)	214
4.7	ANTENNA REQUIREMENT	217
4.7.1	STANDARD APPLICABLE	217
4.7.2	ANTENNA CONNECTED CONSTRUCTION	217
5.	TEST TYPES AND RESULTS (For part 802.11a)	218
5.1	CONDUCTED EMISSION MEASUREMENT	218
5.1.1	LIMITS OF CONDUCTED EMISSION MEASUREMENT	218
5.1.2	TEST INSTRUMENTS	218
5.1.3	TEST PROCEDURES	219
5.1.4	DEVIATION FROM TEST STANDARD	219
5.1.5	TEST SETUP	220
5.1.6	EUT OPERATING CONDITIONS	220
5.1.7	TEST RESULTS (For 1 Ethernet port -Adapter 1)	221
5.1.8	TEST RESULTS (For 1 Ethernet port -Adapter 2)	225
5.1.9	TEST RESULTS (For 1 Ethernet port -POE)	229
5.1.10	TEST RESULTS (For 3 Ethernet ports -Adapter 1)	233
5.1.11	TEST RESULTS (For 3 Ethernet ports -Adapter 2)	237
5.1.12	TEST RESULTS (For 3 Ethernet ports -POE)	241
5.2	Radiated Emission Measurement	245
5.2.1	LIMITS OF RADIATED EMISSION MEASUREMENT	245
5.2.2	LIMITS OF UNWANTED EMISSION OUT OF THE RESTRICTED BANDS	246
5.2.3	TEST INSTRUMENTS	247
5.2.4	TEST PROCEDURES	248
5.2.5	DEVIATION FROM TEST STANDARD	248
5.2.6	TEST SETUP	249
5.2.7	EUT OPERATING CONDITIONS	249
5.2.8	TEST RESULTS	250
5.2.9	TEST RESULTS (antenna 1)	298
5.2.10	TEST RESULTS (antenna 2)	306
5.2.11	TEST RESULTS (antenna 3)	318
5.2.12	TEST RESULTS (antenna 4)	330
5.2.13	TEST RESULTS (antenna 5)	333
5.2.14	TEST RESULTS (antenna 6)	341
5.2.15	TEST RESULTS (antenna 7)	349
5.2.16	TEST RESULTS (antenna 8)	357
	FOR FREQUENCY 5.15~5.35GHz	362
5.3	Peak transmit power MEASUREMENT	362
5.3.1	LIMITS OF PEAK TRANSMIT POWER MEASUREMENT	362
5.3.2	TEST INSTRUMENTS	362
5.3.3	TEST PROCEDURE	363
5.3.4	TEST SETUP	363



5.3.5	EUT OPERATING CONDITIONS	363
5.3.6	TEST RESULTS	364
5.4	Peak power EXCURSION MEASUREMENT	368
5.4.1	LIMITS OF PEAK POWER EXCURSION MEASUREMENT	368
5.4.2	TEST INSTRUMENTS	368
5.4.3	TEST PROCEDURE	369
5.4.4	DEVIATION FROM TEST STANDARD	369
5.4.5	TEST SETUP	369
5.4.6	EUT OPERATING CONDITIONS	369
5.4.7	TEST RESULTS	370
5.5	PEAK power spectral density measurement	379
5.5.1	LIMITS OF PEAK POWER SPECTRAL DENSITY MEASUREMENT	379
5.5.2	TEST INSTRUMENTS	379
5.5.3	TEST PROCEDURES	380
5.5.4	DEVIATION FROM TEST STANDARD	380
5.5.5	TEST SETUP	380
5.5.6	EUT OPERATING CONDITIONS	380
5.5.7	TEST RESULTS	381
5.6	FREQUENCY STABILITY	390
5.6.1	LIMITS OF FREQUENCY STABILITY MEASUREMENT	390
5.6.2	TEST INSTRUMENTS	390
5.6.3	TEST PROCEDURE	390
5.6.4	DEVIATION FROM TEST STANDARD	391
5.6.5	TEST SETUP	391
5.6.6	EUT OPERATING CONDITION	391
5.6.7	TEST RESULTS	392
5.7	BAND EDGES MEASUREMENT	393
5.7.1	TEST INSTRUMENTS	393
5.7.2	TEST PROCEDURE	393
5.7.3	EUT OPERATING CONDITION	393
5.7.4	TEST RESULTS (Antenna 1).....	394
5.7.5	TEST RESULTS (Antenna 2).....	397
5.7.6	TEST RESULTS (Antenna 3).....	402
5.7.7	TEST RESULTS (Antenna 4).....	407
5.7.8	TEST RESULTS (Antenna 5).....	410
5.7.9	TEST RESULTS (Antenna 6).....	413
5.7.10	TEST RESULTS (Antenna 7).....	416
5.8	6dB BANDWIDTH MEASUREMENT.....	419
5.8.1	LIMITS OF 6dB BANDWIDTH MEASUREMENT	419
5.8.2	TEST INSTRUMENTS	419
5.8.3	TEST PROCEDURE	420
5.8.4	DEVIATION FROM TEST STANDARD	420
5.8.5	TEST SETUP	420
5.8.6	EUT OPERATING CONDITIONS	420



5.8.7 TEST RESULTS 421

5.9 MAXIMUM PEAK OUTPUT POWER..... 428

5.9.1 LIMITS OF PEAK TRANSMIT POWER MEASUREMENT 428

5.9.2 TEST INSTRUMENTS 428

5.9.3 TEST PROCEDURE 429

5.9.4 TEST SETUP 429

5.9.5 EUT OPERATING CONDITIONS 429

5.9.6 TEST RESULTS 430

5.9.7 LIMITS OF POWER SPECTRAL DENSITY MEASUREMENT 434

5.9.8 TEST INSTRUMENTS 434

5.9.9 TEST PROCEDURE 435

5.9.10 DEVIATION FROM TEST STANDARD 435

5.9.11 TEST SETUP 435

5.9.12 EUT OPERATING CONDITION 435

5.9.13 TEST RESULTS 436

5.10 BAND EDGES MEASUREMENT..... 443

5.10.1 LIMITS OF BAND EDGES MEASUREMENT..... 443

5.10.2 TEST INSTRUMENTS 443

5.10.3 TEST PROCEDURE 443

5.10.4 DEVIATION FROM TEST STANDARD 443

5.10.5 EUT OPERATING CONDITION 444

5.10.6 TEST RESULTS 444

5.11 ANTENNA REQUIREMENT 473

5.11.1 STANDARD APPLICABLE 473

5.11.2 ANTENNA CONNECTED CONSTRUCTION 473

6. PHOTOGRAPHS OF THE TEST CONFIGURATION..... 474

7. INFORMATION ON THE TESTING LABORATORIES 487



1. CERTIFICATION

PRODUCT : Flanker Pro Dual Radio AP
BRAND NAME : USI, Proxim
MODEL NO. : AP-AG-AT-02, AP-AG-AT-04, RT-AG-AT-02
APPLICANT : UNIVERSAL SCIENTIFIC INDUSTRIAL CO., LTD.
STANDARDS : 47 CFR Part 15, Subpart C (Section 15.247),
Subpart E (Section 15.407), ANSI C63.4-1992

We, **Advance Data Technology Corporation**, hereby certify that two samples of the designation have been tested in our facility from Nov. 07, 2003 to Jan. 13, 2004. The test record data evaluation and Equipment under Test (EUT) configurations represented herein are true and accurate accounts of the measurements of the sample's EMC characteristics under the conditions herein specified.

PREPARED BY: Carol Liao, **DATE:** Jan. 13, 2004
(Carol Liao)

APPROVED BY: Eric Lin, **DATE:** Jan. 13, 2004
(Eric Lin, Manager)



2. SUMMARY OF TEST RESULTS

The EUT has been tested according to the following specifications:

APPLIED STANDARD: 47 CFR Part 15, Subpart C			
Standard Section	Test Type and Limit	Result	REMARK
15.207	AC Power Conducted Emission	PASS	Meet the requirement of limit Minimum passing margin is -1.58dBuV at 2.413MHz
15.247(a)(2)	Spectrum Bandwidth of a Direct Sequence Spread Spectrum System Limit: min. 500kHz	PASS	Meet the requirement of limit
15.247(b)	Maximum Peak Output Power Limit: max. 30dBm	PASS	Meet the requirement of limit
15.247(c)	Transmitter Radiated Emissions FCC Limit: Table 15.209	PASS	Meet the requirement of limit Minimum passing margin is -0.1dBuV at 2320.0MHz
15.247(d)	Power Spectral Density Limit: max. 8dBm	PASS	Meet the requirement of limit
15.247(c)	Band Edge Measurement Limit: 20 dB less than the peak value of fundamental frequency	PASS	Meet the requirement of limit



for freq. 5.15~5.35GHz :

APPLIED STANDARD: 47 CFR Part 15, Subpart E			
Standard Section	Test Type	Result	REMARK
15.407(b)(5)	AC Power Conducted Emission	PASS	Meet the requirement of limit Minimum passing margin is -1.71dBuVat 2.447MHz
15.407(b/1/2/3) (b)(5)	Electric Field Strength Spurious Emissions, 30MHz ~ 40000MHz	PASS	Meet the requirement of limit Minimum passing margin is -0.60dBuV at 5350.00MHz
15.407(a/1/2/3)	Peak Transmit Power	PASS	Meet the requirement of limit
15.407(a)(6)	Peak Power Excursion	PASS	Meet the requirement of limit
15.407(a/1/2/3)	Peak Power Spectral Density	PASS	Meet the requirement of limit
15.407(g)	Frequency Stability	PASS	Meet the requirement of limit

for freq. 5.725~5.850GHz :

APPLIED STANDARD: 47 CFR Part 15, Subpart C			
Standard Section	Test Type and Limit	Result	REMARK
15.207	AC Power Conducted Emission	PASS	Meet the requirement of limit Minimum passing margin is -1.71dBuVat 2.447MHz
15.247(a)(2)	Spectrum Bandwidth of a Direct Sequence Spread Spectrum System Limit: min. 500kHz	PASS	Meet the requirement of limit
15.247(b)	Maximum Peak Output Power Limit: max. 30dBm	PASS	Meet the requirement of limit
15.247(c)	Transmitter Radiated Emissions FCC Limit: Table 15.209	PASS	Meet the requirement of limit Minimum passing margin is -0.20dBuV at 11650.00MHz
15.247(d)	Power Spectral Density Limit: max. 8dBm	PASS	Meet the requirement of limit
15.247(c)	Band Edge Measurement Limit: 20 dB less than the peak value of fundamental frequency	PASS	Meet the requirement of limit



3. GENERAL INFORMATION

3.1 GENERAL DESCRIPTION OF EUT

PRODUCT	Flanker Pro Dual Radio AP
MODEL NO.	AP-AG-AT-02, AP-AG-AT-04, RT-AG-AT-02
POWER SUPPLY	5VDC from AC Adapter or from POE (Power Over Ethernet)
MODULATION	DSSS, OFDM
TRANSFER RATE	802.11b and draft 802.11g: 1/2/5.5/6/9/11/12/18/24/36/48/54Mbps 802.11a:6 to 54Mbps (Turbo mode: up to 108Mbps *see note 1)
FREQUENCY RANGE	802.11b and draft 802.11g: 2400MHz ~ 2483.5MHz 802.11a: 5.15~5.35GHz and 5.725~5.850GHz
NUMBER OF CHANNEL	802.11b and draft 802.11g: 11 802.11a: 13 for Normal mode / 5 for Turbo mode
CHANNEL SPACING	802.11b and draft 802.11g: 5MHz 802.11a: 20MHz for Normal mode / 40MHz for Turbo mode
Max. OUTPUT POWER	802.11b: 23.33dBm / draft 802.11g: 24.32dBm 802.11a: 23.90dBm(*see note 6)
DATA CABLE	NA
ANTENNA TYPE	See Note 3
I/O PORTS	RJ 45 (POE) Port x 1(AP-AG-AT-02) RJ 45 (POE) Port x 3(RT-AG-AT-02)
ASSOCIATED DEVICES	NA

NOTE:

1. This EUT is capable of providing data rates of up to 108Mbps in Turbo Mode depending upon reception quality.
2. The EUT has three model numbers, and it is included two brand names which are identical to each other in all aspects except for the followings:

Model Name	Brand	Flash Size (Byte)	RAM Size (Byte)	External Power	Ethernet Options	Temperature Range (°C)	Remark
AP-AG-AT-02	USI, Proxim	4M	32M	Yes	Single port	0 to +55	FP2
AP-AG-AT-04		512k	16M	No	Single port	0 to +40	LP2
RT-AG-AT-02		8M	64M	Yes	2+1 switch	0 to +55	HS2



3. This EUT with 54 antennas, please refer to the following table:

Item	antenna		technical parameters			identification		
	type	details	Band (GHz)	Gain (dBi)	G eff	Vendor	Vendor model	Proxim model
1	Omni	(1) diversity 20cm	2400-2500	?	3	PROXIM	(in development)	AIN24-ODD-3
2	Omni	vehicular	2400-2500	5	1.5	Telex	2449LT	AOU24-OD-55-B
3	Omni	(2) 30cm: 30cm	2400-2500	7	5	Smart Ant	EMW24-03005-BFL	AIN24-OD-5
4	Omni	(3) 30cm: 50cm	2400-2500	?	7	PROXIM	(not available)	AIN24-OD-8
5	Omni		2400-2500	7	7	Maxrad	MFB24008	AOU24-OD-77
6	Omni		2400-2500	10	10	Telex	2439LT	AOU24-OD-10
7	Panel	(4) patch diversity 10x10cm: 11.4x11.4x4 cm	2400-2500	6	4.1	Smart Ant	R0305-141	AIN24-PAD-6
8	Panel	(5) patch 12x12cm: 11.4x11.4x4 cm	2400-2500	8.5	8.5	Smart Ant	R0205-125	AIN24-PA-8.5
9	Panel	(6) patch 12x12cm: 11.4x11.4x4 cm	2400-2500	9.5	9.5	Smart Ant	R0305-142	AIN24-PA-10.5
10	Panel	wide angle	2400-2500	12	12	Telex	2443LT	AOU24-WA-12-B
11	Panel	window	2400-2500	12	11.7	Smart Ant	R0305-019	AOU24-WI-12-B
12	Panel		2400-2500	14	14	Smart Ant	R0205-064	AOU24-DI-14
13	Yagi		2400-2500	14	14	Telex	2415LT	AOU24-YA-1414
14	Parabol	grid reflector	2400-2500	24	24	Conifer	26WT-2400F	AOU24-DI-24
15	Omni	15 cm dual band	2400-2500 / 5150-5850	2.5 / 5.5	0.4 / 1.9	Smart Ant	R0322-083	AIN-WB-OD-B
16	Omni	(7) diversity 10x20cm	5150-5875	?	3	PROXIM	(in development)	AIN50-ODD-3
17	Omni		5250-5850	8	8	Smart Ant	R0320-101	5054-OA-8
18	Omni	wideband		10	9.9	Smart Ant	R0320-102	5054-OA-10
19	Omni		5250-5350	10	10	Stella Doradus	52 2360	5054-OA52-10
20	Omni		5470-5725	10	10	Stella Doradus	56 2360	5054-OA56-10
21	Omni		5725-5875	10	10	Stella Doradus	58 2360	5054-OA58-10
22	Omni	for US/Can & Europe	5250-5350	13	13	Stella Doradus	52 3360	5054-OA52-13
23	Omni	for Europe	5470-5725	13	13	Stella Doradus	56 3360	5054-OA56-13
24	Omni	for US./Can	5725-5875	13	13	Stella Doradus	58 3360	5054-OA58-13
25	Sector	120deg	5250-5850	14-15	13.6	Smart Ant	R0320-099	5054-SA120-14
26	Sector	60deg	5250-5850	17	17	Radio Waves	SEC-55X-60-17	
27	Sector	60deg	5250-5850	17	16.34	Smart Ant	R0320-100	5054-SA60-17
28	Sector		5150-5850	17	17	Mars	MA-WC50 -5X	
29	Panel	(8) patch 10x10cm: 8x7.6x1.7cm	5150-5875	10.5	7.3	Smart Ant	R0320-140	AIN50-PA-10.5
30	Panel	(8) patch 10x10cm: 11.4x11.4x4 cm	5150-5875	?	7	PROXIM	(not available)	AIN50-PA-13.5
31	Panel	theoretical one	5150-5850	7	7	Smart Ant	R0320-056	
32	Panel	window	5150-5850	15	13	Smart Ant	R0320-091	5054-WA-15-STN
33	Panel		5250-5875	18	18	Smart Ant	R0209-116	5054-PA-18
34	Panel		5725-5875	23	23	Smart Ant	R0209-149	5054-PA-23
35	Panel	1ft flat Panel	5250-5850	23	23	Mars	MA-WA-58-1X	
36	Panel	1ft flat Panel	5250-5850	23.9	23.5	Gabriel	DFPD1-52	
37	Panel	1ft flat Panel	5250-5850	23.6	23.6	Andrew	FPA5250D12-N	
38	Panel	2ft flat Panel	5250-5850	26.5	26.5	RSI	A57A24-U	
39	Panel	2ft flat Panel	5250-5850	28.2	28.2	Andrew	FPA5350D24-N	
40	Panel	2ft flat Panel	5250-5850	28.4	28	Gabriel	DFPD2-52	
41	Parabol	2ft	5250-5850	29	28.5	Gabriel	SSP2-52B	
42	Parabol	2ft	5250-5850	28.9	28.4	Gabriel	SSD2-52A	
43	Parabol	2ft	5250-5850	28.6	28.1	Gabriel	HSSP2-52	
44	Parabol	2ft	5250-5850	28.5	28.5	Radio Waves	SP2-5.X(X=2, 8)	
45	Parabol	2ft	5250-5850	28.1	28.1	Radio Waves	SPD2-5.X(X=2, 8)	
46	Parabol	2ft	2400-2500/ 5725-5825	21.1 / 28.3	21.1 / 28.3	Radio Waves	SP2-2/5	
47	Parabol	2ft	5250-5850	30.1	29.4	Andrew	P2F-52	
48	Parabol	2ft	5250-5850	30.1	29.4	Andrew	PX2F-52	
49	Parabol	2ft	5250-5850	29	29	RSI	P-57C24	
50	Parabol	3ft	5250-5850	31.4	31.4	Radio Waves	SP3-5.X(X=2, 8)	
51	Parabol	3ft	5250-5850	31.1	31.1	Radio Waves	SPD3-5.X(X=2, 8)	
52	Parabol	2ft	2400-2500/ 5725-5825	24.1 / 31.4	24.1 / 31.4	Radio Waves	SP3-2/5	
53	Parabol	3ft	5250-5850	33.5	33.4	Andrew	P3F-52 N7A	
54	Parabol	3ft	5250-5850	33.5	33.4	Andrew	P3X3F-52	



We provided twelve antennas with EUT (AP-AG-AT-02) for the worst case, were chosen for final test. The data was recorded in this report; please refer to the following table:

For 2.4GHz				
No.	Model No.	Gain (dBi)	Antenna Type	Antenna Connector
1	AIN-WB-OD-B	2.5dBi	Dual-Band Omni-Directional Antenna	Aliner 31-401A R/A plug
2	BlueChip	2.0dBi	Chip Antenna	NA
3	D-Puck	3.0dBi	Chip Antenna	NA
4	AOU24-OD-10	10 dBi	Omni	Female N-type connector
5	AOU24-DI-14	14 dBi	Panel	Female N-type connector
6	AOU24-YA-1414	14 dBi	Yagi	Female N-type connector
7	AOU24-DI-24	24 dBi	Parabol	Female N-type connector

For 5GHz				
No.	Model No.	Gain (dBi)	Antenna Type	Antenna Connector
1	AIN-WB-OD-B	3.5dBi	Dual-Band Omni-Directional Antenna	Aliner 31-401A R/A plug
2	BlueChip	3.0dBi	Chip Antenna	NA
3	D-Puck	4.0dBi	Chip Antenna	NA
4	5054-OA52-13	13 dBi	Omni	Female N-type connector
5	5054-SA60-17	17 dBi	Sector	Female N-type connector
6	FPA5350D24-N	28.2 dBi (With pad)	Panel	Female N-type connector
7	P3F-52N7A	33.4 dBi (With pad)	Parabol	Female N-type connector
8	5054-OA58-13	13 dBi	Omni	Female N-type connector

4. Frequency Range of each Antennas are as followings:

For 2.4GHz	
Antenna No.	Frequency Range
No. 1	2400MHz ~ 2483.5MHz, 5.25GHz ~ 5.35GHz, 5.725GHz ~ 5.850GHz
No. 2, 3	2400MHz ~ 2483.5MHz, 5.15GHz ~ 5.25GHz, 5.25GHz~5.35GHz, 5.725GHz ~ 5.850GHz
No. 4, 5, 6	2400MHz ~ 2500MHz
No. 7	2422MHz ~ 2452MHz

For 5GHz	
Antenna No.	Frequency Range
No. 1	2400MHz ~ 2483.5MHz, 5.25GHz ~ 5.35GHz, 5.725GHz ~ 5.850GHz
No. 2, 3	2400MHz ~ 2483.5MHz, 5.15GHz ~ 5.25GHz, 5.25GHz~5.35GHz, 5.725GHz ~ 5.850GHz
No. 4	5.25GHz ~ 5.35GHz
No. 5, 6, 7	5.25GHz~5.35GHz, 5.725GHz ~ 5.850GHz
No. 8	5.725GHz ~ 5.875GHz



5. The EUT was powered by AC adapters and POE (Power Over Ethernet) as follows,

AC Adapter 1:	
Brand:	DVE
Model No.:	DSA-0151F-05
Input power :	100-240VAC;50-60Hz;0.4A/ClassII
Output power :	5V;2.8A/Nonshielded;W/O Core;1.9m

AC Adapter 2:	
Brand:	HIPRO
Model No.:	HP-OJ015L6A
Input power :	100-240VAC;50-60Hz;1A/ClassII
Output power :	5V;3A/Nonshielded;With Core;1.8m

POE:					
No.	Brand Name	Model Name	No. of Ports	AC Input	DC Output
1	Symbol	BIAS-T	1	85-270Vac	24Vdc
2	PowerDsine	6001	1	90-264Vac 47-63Hz	48Vdc
3	orinoco	orinoco AE 1Port DC Injector	1	90-264Vac 47-63Hz	42-52Vdc
4	PowerDsine	3006	6	88-264Vac 47-63Hz	48Vdc
5	Lucent Technologies	orinoco AE 6Port DC Injector	6	90-264Vac 47-63Hz	42-52Vdc
6	Lucent Technologies	orinoco AE 12Port DC Injector	12	90-264Vac 47-63Hz	42-52Vdc
7	PowerDsine	6012	12	88-264Vac 47-63Hz	48Vdc

*The POE supplied power to EUT via POE port, only used on testing.

6. Peak output power (Unit : dBm) :

No.	Model No.	Operating Frequency (MHz)			
		2412~2462	5150~5250	5250~5350	5725~5850
1	AIN-WB-OD-B	23.04	NA	22.88	22.65
2	BlueChip	24.32	16.33	21.71	23.90
3	D-Puck	23.17	16.55	23.37	23.28
4	AOU24-OD-10	21.0	NA	NA	NA
5	AOU24-DI-14	12.86	NA	NA	NA
6	AOU24-YA-1414	17.92	NA	NA	NA
7	AOU24-DI-24	12.10	NA	NA	NA
8	5054-OA52-13	NA	NA	16.54	NA
9	5054-SA60-17	NA	NA	12.52	19.72
10	FPA5350D24-N	NA	NA	3.48	20.87
11	P3F-52N7A	NA	NA	3.12	20.74
12	5054-OA58-13	NA	NA	NA	21.32

7. For more detailed features description, please refer to the manufacturer's specifications or User's Manual.



3.2 DESCRIPTION OF TEST MODES

For 802.11b: Eleven channels are provided to this EUT.

Channel	Frequency	Channel	Frequency
1	2412 MHz	7	2442 MHz
2	2417 MHz	8	2447 MHz
3	2422 MHz	9	2452 MHz
4	2427 MHz	10	2457 MHz
5	2432 MHz	11	2462 MHz
6	2437 MHz		

NOTE:

1. Below 1 GHz, the channel 1, 6, and 11 were pre-tested in chamber. The channel 11, worst case one, was chosen for final test.
2. Above 1 GHz, the channel 1, 6, and 11 were tested individually.
3. Transfer rate, 11Mbps with CCK technique and 6Mbps with OFDM technique, the worst case, were chosen for final test.

For 802.11a: Thirteen channels are provided to this EUT for Normal mode.

Channel	Frequency	Channel	Frequency
1	5180 MHz	8	5320 MHz
2	5200 MHz	9	5745MHz
3	5220 MHz	10	5765MHz
4	5240 MHz	11	5785MHz
5	5260 MHz	12	5805MHz
6	5280 MHz	13	5825MHz
7	5300 MHz		

Five channels are provided to this EUT for Turbo Mode.

Channel	Frequency	Channel	Frequency
1	5210 MHz	4	5760MHz
2	5250 MHz	5	5800MHz
3	5290 MHz		

NOTE:

1. The EUT was tested in both normal mode (channel bandwidth of approximately 20MHz) and turbo mode (channel bandwidth of approximately 40MHz).
2. "Normal Mode" allows data rates of up to 54Mbps. The device was, therefore, tested in Normal mode at the data rate that produced the highest output power for normal mode (6Mbps).
3. "Turbo Mode" allows data rates of up to 108Mbps. At data rates higher than 12Mbps the PA gain is reduced to improve signal fidelity. The device was, therefore, tested in turbo mode at the data rate that produced the highest output power for turbo mode (12Mbps).
4. Channel 1, 4, 5, 8, 9, 11 and 13 are the closest frequencies to the band edge, were chosen for final test of Normal Mode.
5. Channel 1 ~ 5 were chosen for final test of turbo mode.



3.3 GENERAL DESCRIPTION OF APPLIED STANDARDS

The EUT is a Flanker Pro Dual Radio AP According to the specifications of the manufacturer; it must comply with the requirements of the following standards:

**47 CFR Part 15, Subpart C. (15.247),
Subpart E (15.407). ANSI C63.4 : 1992**

All tests have been performed and recorded as per the above standards.

NOTE: The EUT is also considered as a kind of computer peripheral, because the connection to computer is necessary for typical use. It has been verified to comply with the requirements of 47CFR Part 15, Subpart B, Class B (DoC). The test report has been issued separately.



3.4 DESCRIPTION OF SUPPORT UNITS

The EUT has been tested as an independent unit together with other necessary accessories or support units. The following support units or accessories were used to form a representative test configuration during the tests.

No.	Product	Brand	Model No.	Serial No.	FCC ID
1	NOTEBOOK	DELL	PP01L	TW-09C748-12800-1 A3-1999	DoC

No.	Signal cable description
1	NA

Note: 1. All power cords of the above support units are unshielded (1.8m).



For AC Adapter

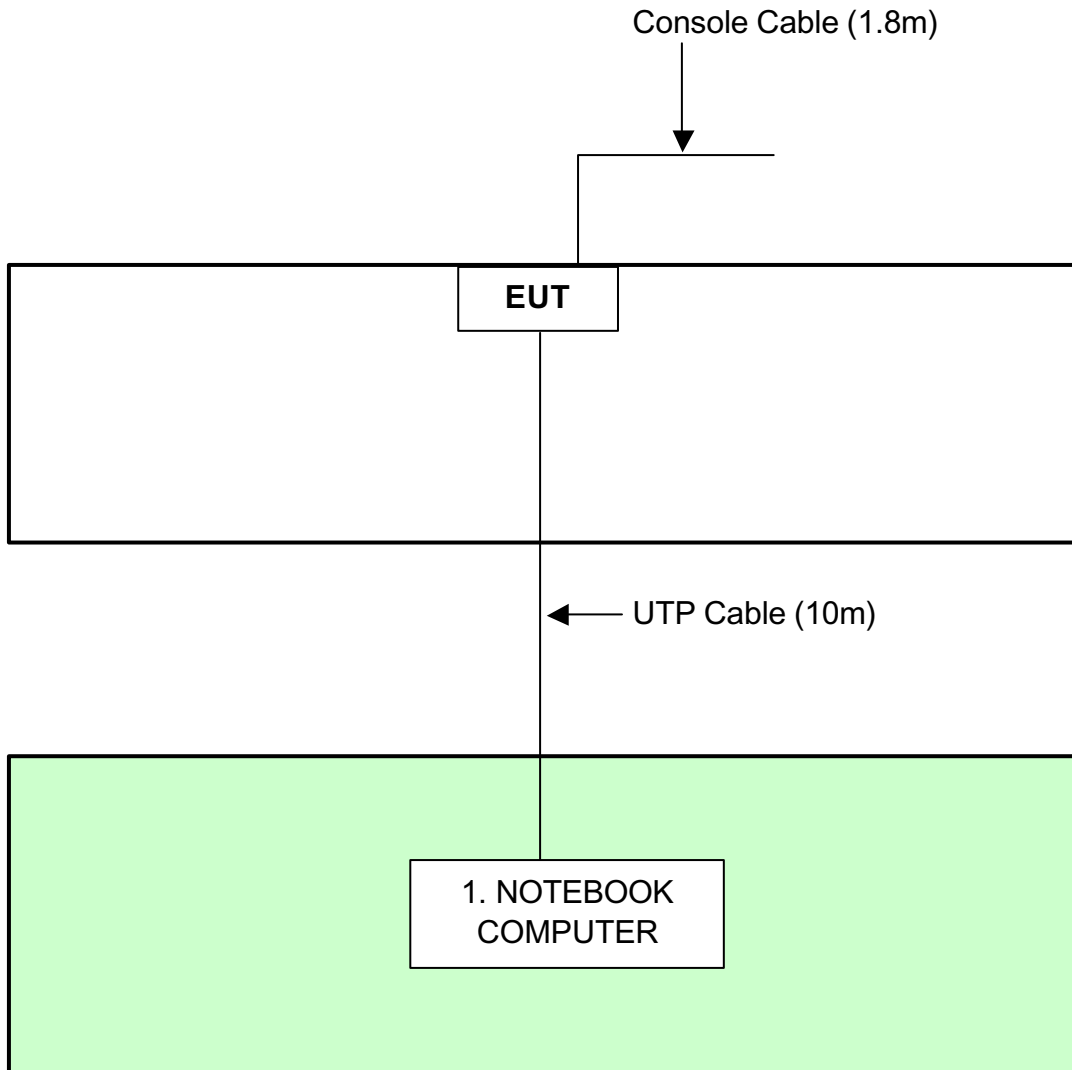

- NOTE:**
1. Support unit 1 was kept in the control room during the test.
 2. Please refer to the photos of test configuration in Item 6 also.



For POE

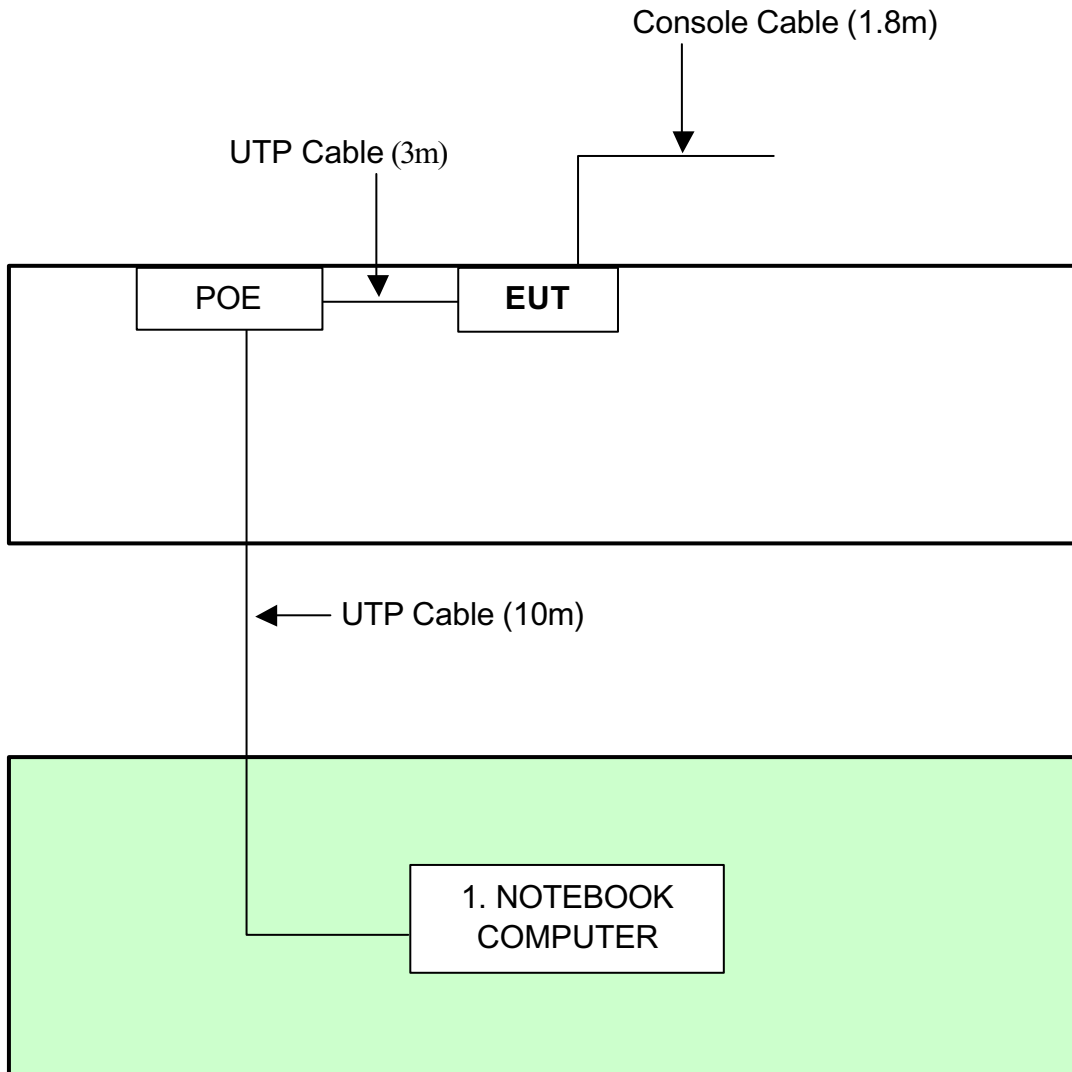

- NOTE:** 1. Support unit 1 was kept in the control room during the test.
2. Please refer to the photos of test configuration in Item 6 also.



4. TEST TYPES AND RESULTS (FOR PART 802.11b)

4.1 CONDUCTED EMISSION MEASUREMENT

4.1.1 LIMITS OF CONDUCTED EMISSION MEASUREMENT

FREQUENCY (MHz)	Class A (dBuV)		Class B (dBuV)	
	Quasi-peak	Average	Quasi-peak	Average
0.15 - 0.5	79	66	66 - 56	56 - 46
0.50 - 5.0	73	60	56	46
5.0 - 30.0	73	60	60	50

- NOTES:**
- (1) The lower limit shall apply at the transition frequencies.
 - (2) The limit decreases in line with the logarithm of the frequency in the range of 0.15 to 0.50 MHz.
 - (3) All emanations from a class A/B digital device or system, including any network of conductors and apparatus connected thereto, shall not exceed the level of field strengths specified above.

4.1.2 TEST INSTRUMENTS

DESCRIPTION & MANUFACTURER	MODEL NO.	SERIAL NO.	CALIBRATED UNTIL
ROHDE & SCHWARZ Test Receiver	ESCS 30	847124/029	Nov. 17, 2004
ROHDE & SCHWARZ LISN (for EUT)	ESHS-Z5	848773/004	Nov. 13, 2004
KYORITSU LISN (for peripheral)	KNW-407	8/1395/12	Jul. 23, 2004
RF Cable (JETBAO)	RG233/U	Cable_CA_01	Jul. 03, 2004
Terminator(for KYORITSU)	50	3	Apr. 11, 2004
Software	Cond-V2e	NA	NA

- NOTE:**
1. The calibration interval of the above test instruments is 12 months and the calibrations are traceable to NML/ROC and NIST/USA.
 2. The test was performed in ADT Shielded Room No. A.
 3. The VCCI Con A Registration No. is C-817.



4.1.3 TEST PROCEDURES

- a. The EUT was placed 0.4 meters from the conducting wall of the shielded room with EUT being connected to the power mains through a line impedance stabilization network (LISN). Other support units were connected to the power mains through another LISN. The two LISNs provide 50 ohm/ 50uH of coupling impedance for the measuring instrument.
- b. Both lines of the power mains connected to the EUT were checked for maximum conducted interference.
- c. The frequency range from 150 kHz to 30 MHz was searched. Emission levels over 10dB under the prescribed limits could not be reported

4.1.4 DEVIATION FROM TEST STANDARD

No deviation

4.1.5 TEST SETUP

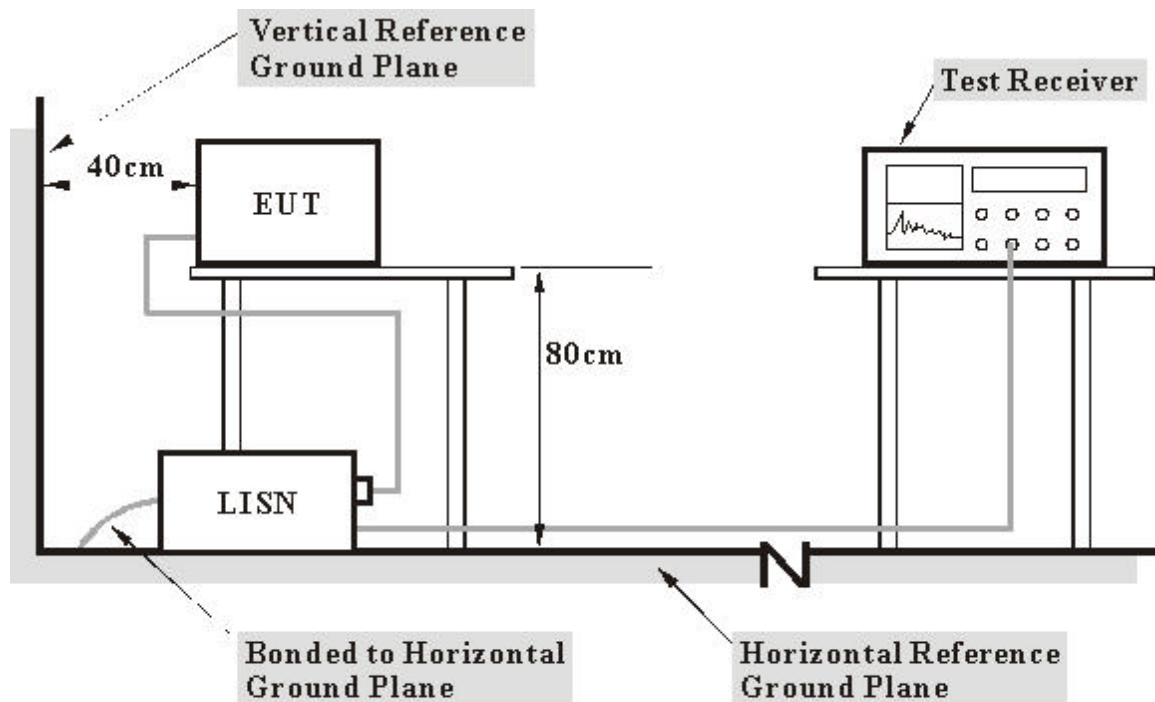

- Note:**
1. Support units were connected to second LISN.
 2. Both of LISNs (AMN) 80 cm from EUT and at the least 80 cm from other units and other metal planes support units.

For the actual test configuration, please refer to the related item – Photographs of the Test Configuration.

4.1.6 EUT OPERATING CONDITIONS

- a. Placed the EUT on the testing table.
- b. Prepared another computer system to act as a communication partner and placed it outside of testing area.
- c. The communication partner run a test program to enable EUT under transmission/receiving condition continuously at specific channel frequency via RJ 45 cable and wireless.
- d. The communication partner sent data to EUT by command "PING".



4.1.7 TEST RESULTS (For 1 Ethernet port-Adapter 1)

EUT	Flanker Pro Dual Radio AP		
MODEL	AP-AG-AT-02		
MODE	Channel 11	6dB BANDWIDTH	9 kHz
INPUT POWER (SYSTEM)	120Vac, 60Hz	PHASE	Line (L)
ENVIRONMENTAL CONDITIONS	27deg. C, 60%RH, 982 hPa	TESTED BY	Tony Chen

No	Freq. [MHz]	Corr. Factor (dB)	Reading Value [dB (uV)]		Emission Level [dB (uV)]		Limit [dB (uV)]		Margin (dB)	
			Q.P.	AV.	Q.P.	AV.	Q.P.	AV.	Q.P.	AV.
1	0.164	0.20	49.64	-	49.84	-	65.24	55.24	-15.40	-
2	0.673	0.25	39.04	-	39.29	-	56.00	46.00	-16.71	-
3	2.490	0.32	46.89	24.85	47.21	25.17	56.00	46.00	-8.79	-20.83
4	2.677	0.33	38.59	-	38.92	-	56.00	46.00	-17.08	-
5	2.951	0.35	40.76	-	41.11	-	56.00	46.00	-14.89	-
6	4.918	0.46	39.73	-	40.19	-	56.00	46.00	-15.81	-

- NOTES:** (1) "": Undetectable
 (2) Q.P. and AV. are abbreviations of quasi-peak and average.
 (3) "-": The Quasi-peak reading value also meets an average limit, thus measurement with the average detector is unnecessary.
 (4) The emission levels of other frequencies were very low against the limit.
 (5) Correction Factor = Insertion loss + Cable loss
 (6) Margin value = Emission level - Limit value

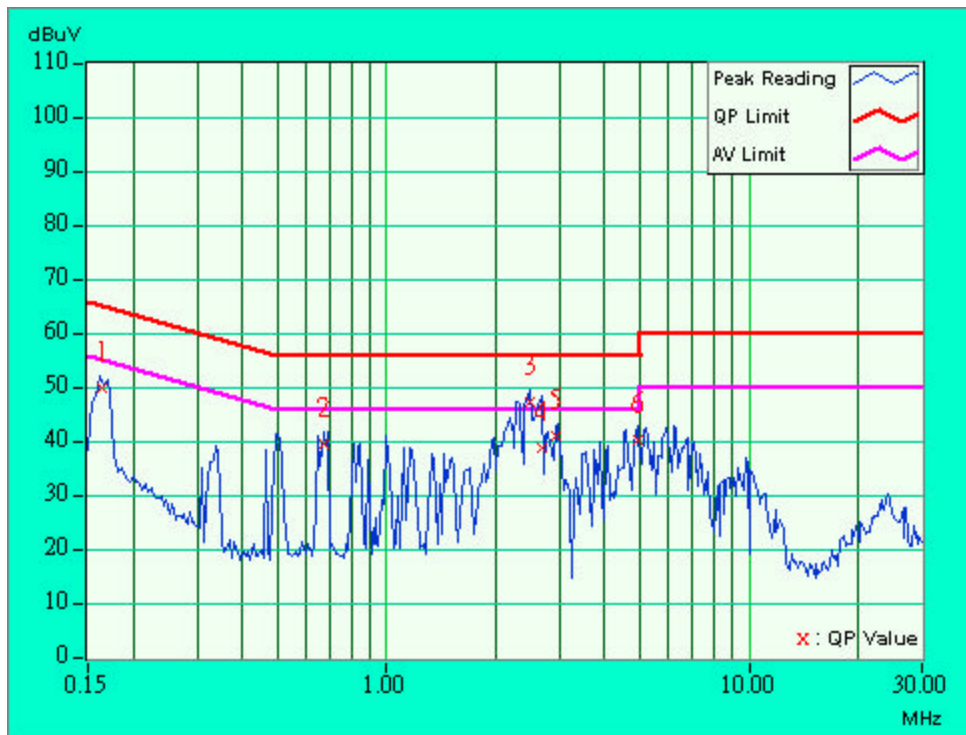



EUT	Flanker Pro Dual Radio AP		
MODEL	AP-AG-AT-02		
MODE	Channel 11	6dB BANDWIDTH	9 kHz
INPUT POWER (SYSTEM)	120Vac, 60Hz	PHASE	Neutral (N)
ENVIRONMENTAL CONDITIONS	27deg. C, 60%RH, 982 hPa	TESTED BY	Tony Chen

No	Freq. [MHz]	Corr. Factor (dB)	Reading Value [dB (uV)]		Emission Level [dB (uV)]		Limit [dB (uV)]		Margin (dB)	
			Q.P.	AV.	Q.P.	AV.	Q.P.	AV.	Q.P.	AV.
1	0.167	0.20	44.93	-	45.13	-	65.12	55.12	-19.99	-
2	0.834	0.27	36.13	-	36.40	-	56.00	46.00	-19.60	-
3	2.279	0.31	43.38	-	43.69	-	56.00	46.00	-12.31	-
4	2.478	0.32	47.47	27.56	47.79	27.88	56.00	46.00	-8.21	-18.12
5	3.082	0.35	41.19	-	41.54	-	56.00	46.00	-14.46	-
6	4.863	0.44	39.02	-	39.46	-	56.00	46.00	-16.54	-

- NOTES:** (1) "": Undetectable
 (2) Q.P. and AV. are abbreviations of quasi-peak and average.
 (3) "-": The Quasi-peak reading value also meets an average limit, thus measurement with the average detector is unnecessary.
 (4) The emission levels of other frequencies were very low against the limit.
 (5) Correction Factor = Insertion loss + Cable loss
 (6) Margin value = Emission level - Limit value

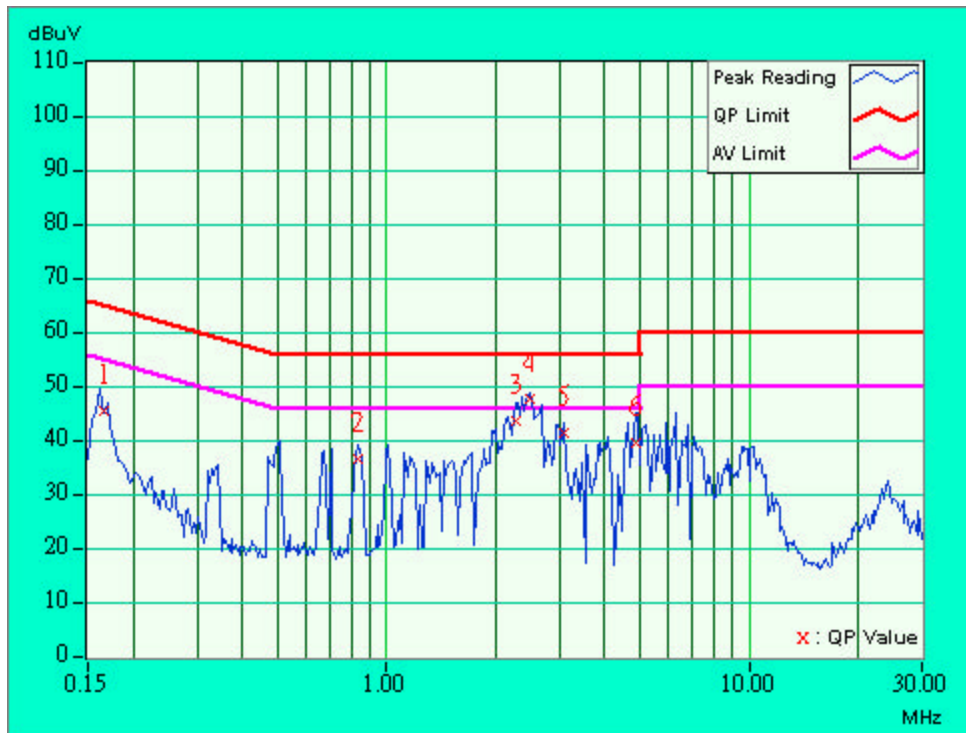



4.1.8 TEST RESULTS (For 1 Ethernet port -Adapter 2)

EUT	Flanker Pro Dual Radio AP		
MODEL	AP-AG-AT-02		
MODE	Channel 11	6dB BANDWIDTH	9 kHz
INPUT POWER (SYSTEM)	120Vac, 60Hz	PHASE	Line (L)
ENVIRONMENTAL CONDITIONS	27deg. C, 60%RH, 982 hPa	TESTED BY	Tony Chen

No	Freq. [MHz]	Corr. Factor (dB)	Reading Value [dB (uV)]		Emission Level [dB (uV)]		Limit [dB (uV)]		Margin (dB)	
			Q.P.	AV.	Q.P.	AV.	Q.P.	AV.	Q.P.	AV.
1	0.236	0.20	38.71	-	38.91	-	62.24	52.24	-23.33	-
2	0.354	0.20	36.17	-	36.37	-	58.86	48.86	-22.49	-
3	0.470	0.21	33.80	-	34.01	-	56.51	46.51	-22.50	-
4	0.681	0.25	29.83	-	30.08	-	56.00	46.00	-25.92	-
5	0.838	0.27	34.41	-	34.68	-	56.00	46.00	-21.32	-
6	1.423	0.30	33.49	-	33.79	-	56.00	46.00	-22.21	-

- NOTES:** (1) "***": Undetectable
 (2) Q.P. and AV. are abbreviations of quasi-peak and average.
 (3) "-": The Quasi-peak reading value also meets an average limit, thus measurement with the average detector is unnecessary.
 (4) The emission levels of other frequencies were very low against the limit.
 (5) Correction Factor = Insertion loss + Cable loss
 (6) Margin value = Emission level - Limit value

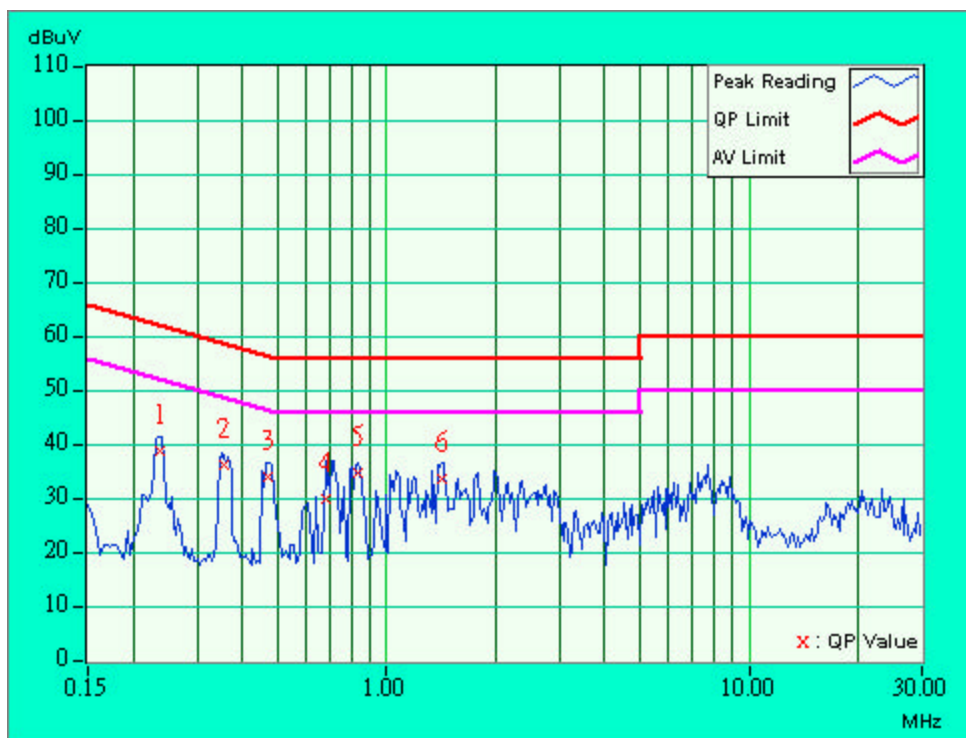



EUT	Flanker Pro Dual Radio AP		
MODEL	AP-AG-AT-02		
MODE	Channel 11	6dB BANDWIDTH	9 kHz
INPUT POWER (SYSTEM)	120Vac, 60Hz	PHASE	Neutral (N)
ENVIRONMENTAL CONDITIONS	27deg. C, 60%RH, 982 hPa	TESTED BY	Tony Chen

No	Freq. [MHz]	Corr. Factor (dB)	Reading Value [dB (uV)]		Emission Level [dB (uV)]		Limit [dB (uV)]		Margin (dB)	
			Q.P.	AV.	Q.P.	AV.	Q.P.	AV.	Q.P.	AV.
1	0.236	0.20	42.60	-	42.80	-	62.24	52.24	-19.44	-
2	0.361	0.20	35.60	-	35.80	-	58.71	48.71	-22.91	-
3	0.473	0.21	39.26	-	39.47	-	56.47	46.47	-16.99	-
4	0.709	0.25	34.17	-	34.42	-	56.00	46.00	-21.58	-
5	1.064	0.30	35.40	-	35.70	-	56.00	46.00	-20.30	-
6	1.638	0.30	32.20	-	32.50	-	56.00	46.00	-23.50	-

- NOTES:** (1) "***": Undetectable
 (2) Q.P. and AV. are abbreviations of quasi-peak and average.
 (3) "-": The Quasi-peak reading value also meets an average limit, thus measurement with the average detector is unnecessary.
 (4) The emission levels of other frequencies were very low against the limit.
 (5) Correction Factor = Insertion loss + Cable loss
 (6) Margin value = Emission level - Limit value

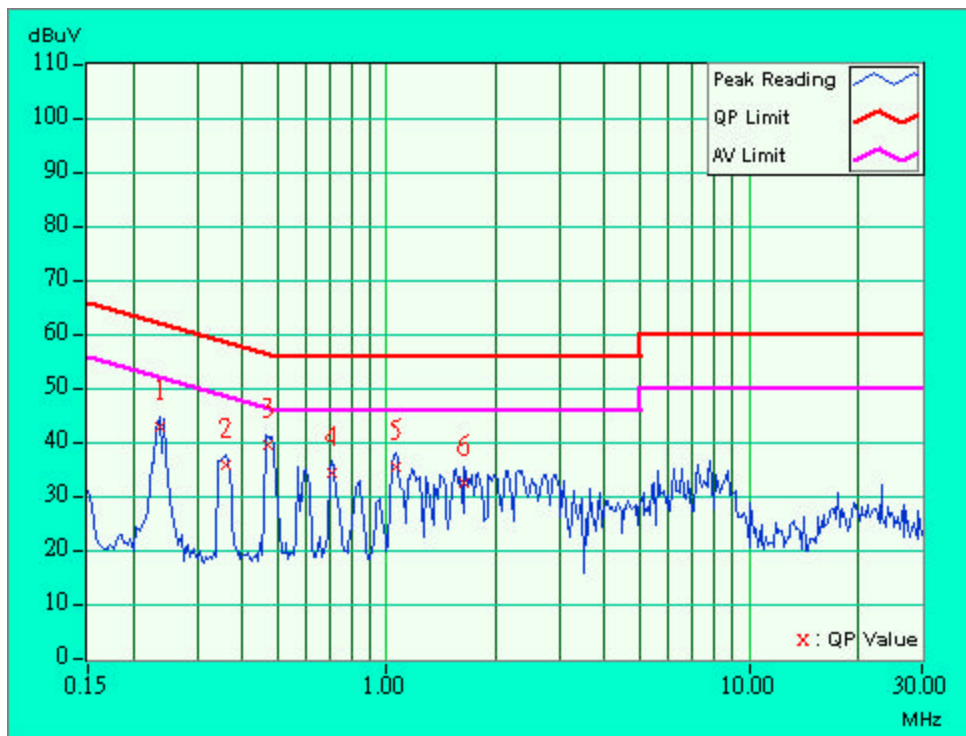



4.1.9 TEST RESULTS (For 1 Ethernet port -POE)

EUT	Flanker Pro Dual Radio AP		
MODEL	AP-AG-AT-02		
MODE	Channel 11	6dB BANDWIDTH	9 kHz
INPUT POWER (SYSTEM)	120Vac, 60Hz	PHASE	Line (L)
ENVIRONMENTAL CONDITIONS	27deg. C, 60%RH, 982 hPa	TESTED BY	Tony Chen

No	Freq. [MHz]	Corr. Factor (dB)	Reading Value [dB (uV)]		Emission Level [dB (uV)]		Limit [dB (uV)]		Margin (dB)	
			Q.P.	AV.	Q.P.	AV.	Q.P.	AV.	Q.P.	AV.
1	0.150	0.20	48.38	-	48.58	-	66.00	56.00	-17.42	-
2	0.224	0.20	43.65	-	43.85	-	62.66	52.66	-18.81	-
3	0.263	0.20	38.54	-	38.74	-	61.33	51.33	-22.59	-
4	0.297	0.20	37.68	-	37.88	-	60.32	50.32	-22.44	-
5	5.504	0.50	34.88	-	35.38	-	60.00	50.00	-24.62	-
6	14.396	1.06	38.81	-	39.87	-	60.00	50.00	-20.13	-

- NOTES:** (1) "***": Undetectable
 (2) Q.P. and AV. are abbreviations of quasi-peak and average.
 (3) "-": The Quasi-peak reading value also meets an average limit, thus measurement with the average detector is unnecessary.
 (4) The emission levels of other frequencies were very low against the limit.
 (5) Correction Factor = Insertion loss + Cable loss
 (6) Margin value = Emission level - Limit value

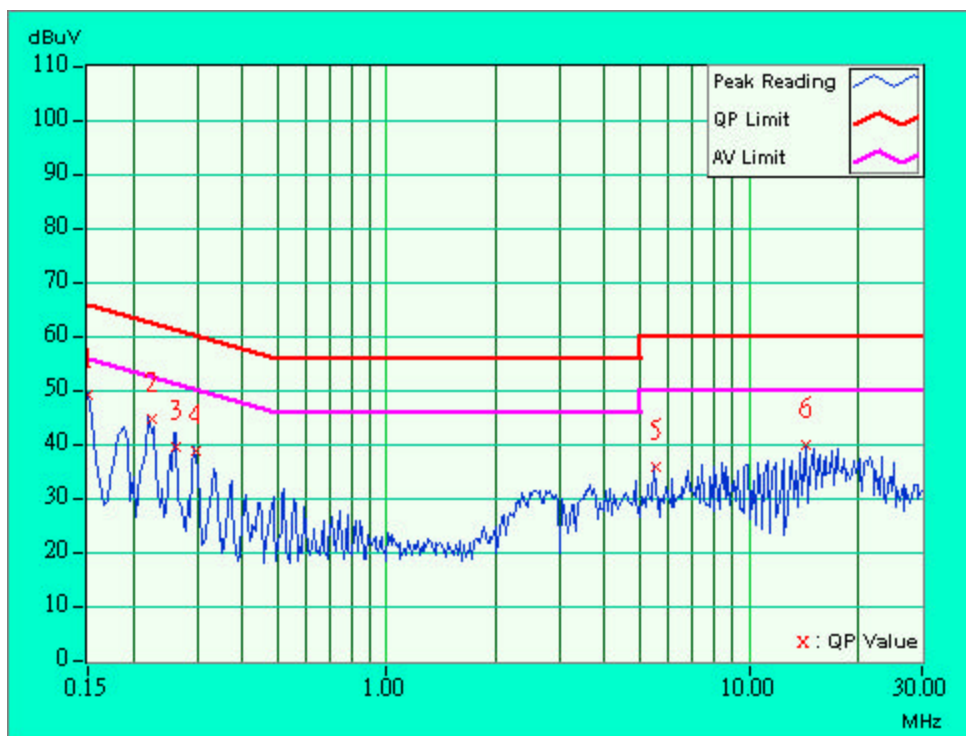



EUT	Flanker Pro Dual Radio AP		
MODEL	AP-AG-AT-02		
MODE	Channel 11	6dB BANDWIDTH	9 kHz
INPUT POWER (SYSTEM)	120Vac, 60Hz	PHASE	Neutral (N)
ENVIRONMENTAL CONDITIONS	27deg. C, 60%RH, 982 hPa	TESTED BY	Tony Chen

No	Freq. [MHz]	Corr. Factor (dB)	Reading Value [dB (uV)]		Emission Level [dB (uV)]		Limit [dB (uV)]		Margin (dB)	
			Q.P.	AV.	Q.P.	AV.	Q.P.	AV.	Q.P.	AV.
1	0.150	0.20	48.20	-	48.40	-	66.00	56.00	-17.60	-
2	0.224	0.20	43.99	-	44.19	-	62.66	52.66	-18.47	-
3	0.259	0.20	40.15	-	40.35	-	61.45	51.45	-21.10	-
4	0.298	0.20	37.29	-	37.49	-	60.29	50.29	-22.80	-
5	2.752	0.34	32.46	-	32.80	-	56.00	46.00	-23.20	-
6	16.298	1.00	38.56	-	39.56	-	60.00	50.00	-20.44	-

- NOTES:** (1) "***": Undetectable
 (2) Q.P. and AV. are abbreviations of quasi-peak and average.
 (3) "-": The Quasi-peak reading value also meets an average limit, thus measurement with the average detector is unnecessary.
 (4) The emission levels of other frequencies were very low against the limit.
 (5) Correction Factor = Insertion loss + Cable loss
 (6) Margin value = Emission level - Limit value

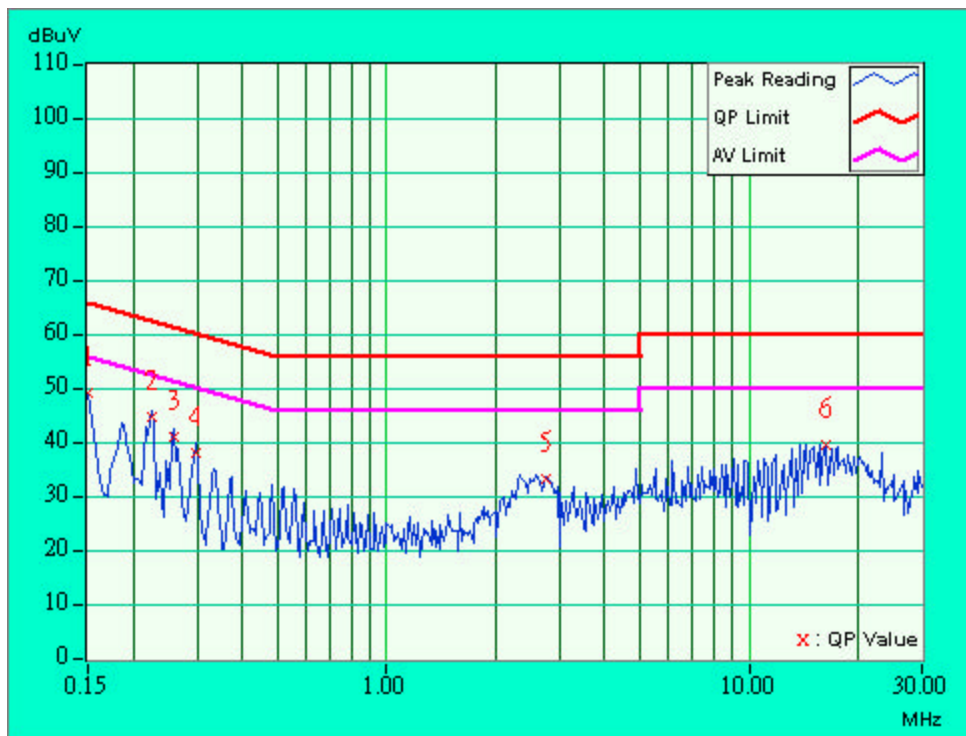



4.1.10 TEST RESULTS (For 3 Ethernet ports -Adapter 1)

EUT	Flanker Pro Dual Radio AP		
MODEL	AP-AG-AT-02		
MODE	Channel 11	6dB BANDWIDTH	9 kHz
INPUT POWER (SYSTEM)	120Vac, 60Hz	PHASE	Line (L)
ENVIRONMENTAL CONDITIONS	27deg. C, 60%RH, 982 hPa	TESTED BY	Tony Chen

No	Freq. [MHz]	Corr. Factor (dB)	Reading Value [dB (uV)]		Emission Level [dB (uV)]		Limit [dB (uV)]		Margin (dB)	
			Q.P.	AV.	Q.P.	AV.	Q.P.	AV.	Q.P.	AV.
1	0.404	0.20	37.96	-	38.16	-	57.77	47.77	-19.61	-
2	0.541	0.22	37.86	-	38.08	-	56.00	46.00	-17.92	-
3	0.814	0.27	37.78	-	38.05	-	56.00	46.00	-17.95	-
4	1.080	0.30	36.00	-	36.30	-	56.00	46.00	-19.70	-
5	2.478	0.32	44.72	-	45.04	-	56.00	46.00	-10.96	-
6	2.759	0.34	43.31	-	43.65	-	56.00	46.00	-12.35	-

- NOTES:** (1) "": Undetectable
 (2) Q.P. and AV. are abbreviations of quasi-peak and average.
 (3) "-": The Quasi-peak reading value also meets an average limit, thus measurement with the average detector is unnecessary.
 (4) The emission levels of other frequencies were very low against the limit.
 (5) Correction Factor = Insertion loss + Cable loss
 (6) Margin value = Emission level - Limit value

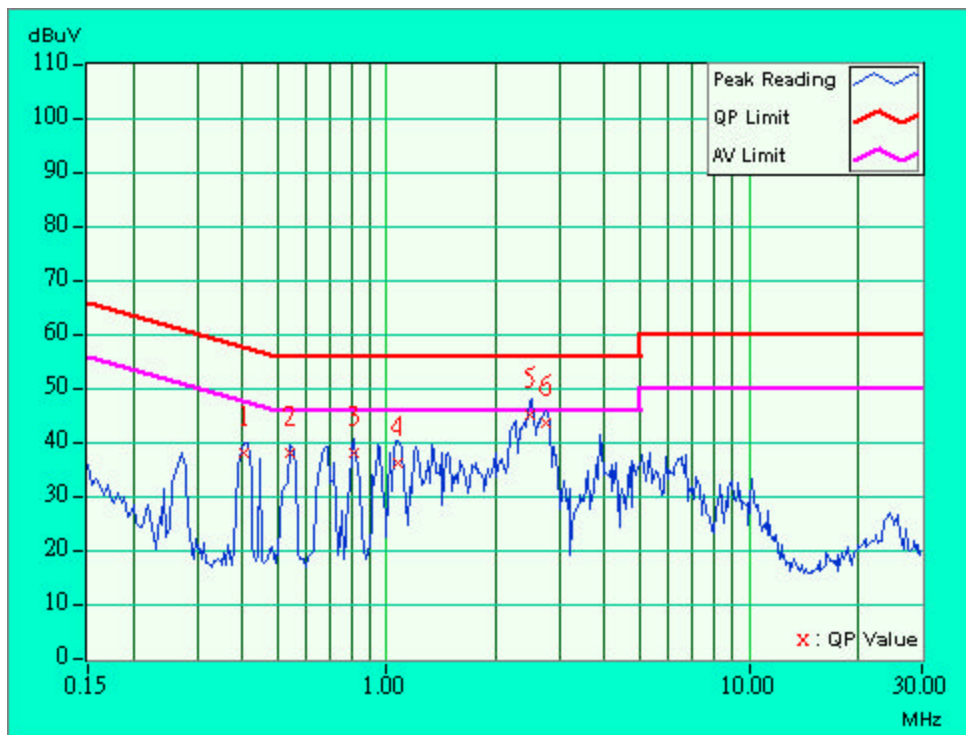



EUT	Flanker Pro Dual Radio AP		
MODEL	AP-AG-AT-02		
MODE	Channel 11	6dB BANDWIDTH	9 kHz
INPUT POWER (SYSTEM)	120Vac, 60Hz	PHASE	Neutral (N)
ENVIRONMENTAL CONDITIONS	27deg. C, 60%RH, 982 hPa	TESTED BY	Tony Chen

No	Freq. [MHz]	Corr. Factor (dB)	Reading Value [dB (uV)]		Emission Level [dB (uV)]		Limit [dB (uV)]		Margin (dB)	
			Q.P.	AV.	Q.P.	AV.	Q.P.	AV.	Q.P.	AV.
1	0.404	0.20	34.69	-	34.89	-	57.77	47.77	-22.88	-
2	0.677	0.25	36.59	-	36.84	-	56.00	46.00	-19.16	-
3	1.084	0.30	34.70	-	35.00	-	56.00	46.00	-21.00	-
4	2.287	0.31	36.82	-	37.13	-	56.00	46.00	-18.87	-
5	2.537	0.33	43.58	-	43.91	-	56.00	46.00	-12.09	-
6	2.779	0.34	41.04	-	41.38	-	56.00	46.00	-14.62	-

- NOTES:** (1) "***": Undetectable
 (2) Q.P. and AV. are abbreviations of quasi-peak and average.
 (3) "-": The Quasi-peak reading value also meets an average limit, thus measurement with the average detector is unnecessary.
 (4) The emission levels of other frequencies were very low against the limit.
 (5) Correction Factor = Insertion loss + Cable loss
 (6) Margin value = Emission level - Limit value

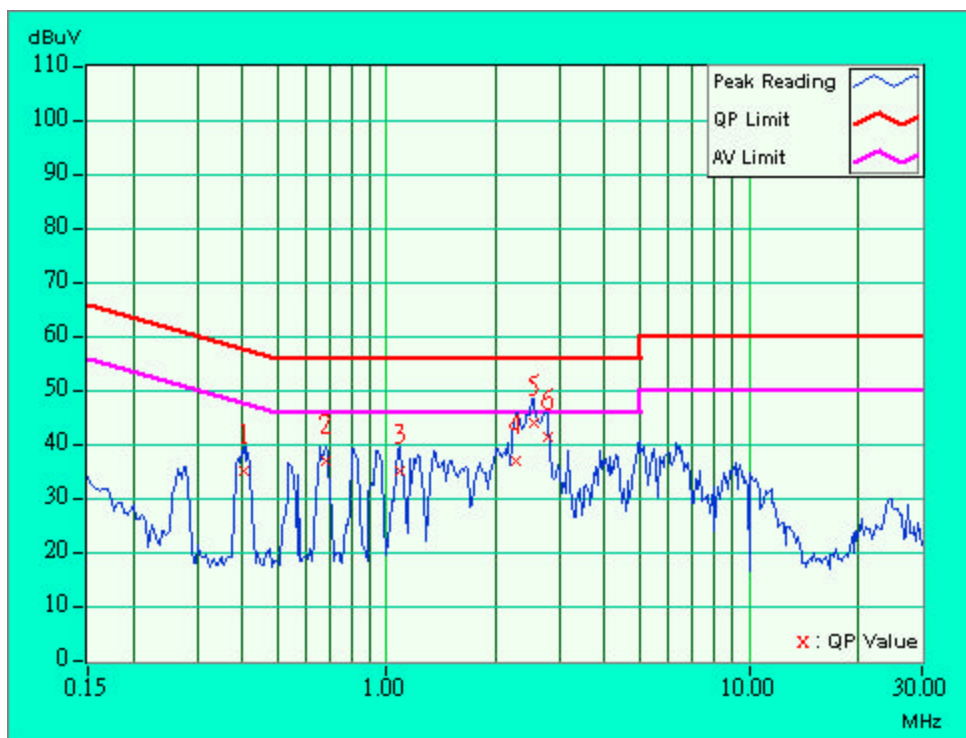



4.1.11 TEST RESULTS (For 3 Ethernet ports -Adapter 2)

EUT	Flanker Pro Dual Radio AP		
MODEL	AP-AG-AT-02		
MODE	Channel 11	6dB BANDWIDTH	9 kHz
INPUT POWER (SYSTEM)	120Vac, 60Hz	PHASE	Line (L)
ENVIRONMENTAL CONDITIONS	27deg. C, 60%RH, 982 hPa	TESTED BY	Tony Chen

No	Freq. [MHz]	Corr. Factor (dB)	Reading Value [dB (uV)]		Emission Level [dB (uV)]		Limit [dB (uV)]		Margin (dB)	
			Q.P.	AV.	Q.P.	AV.	Q.P.	AV.	Q.P.	AV.
1	0.197	0.20	43.28	-	43.48	-	63.74	53.74	-20.26	-
2	0.295	0.20	40.94	-	41.14	-	60.40	50.40	-19.26	-
3	0.396	0.20	31.81	-	32.01	-	57.94	47.94	-25.93	-
4	0.705	0.25	33.40	-	33.65	-	56.00	46.00	-22.35	-
5	0.900	0.28	35.70	-	35.98	-	56.00	46.00	-20.02	-
6	8.320	0.69	29.06	-	29.75	-	60.00	50.00	-30.25	-

- NOTES:** (1) "": Undetectable
 (2) Q.P. and AV. are abbreviations of quasi-peak and average.
 (3) "-": The Quasi-peak reading value also meets an average limit, thus measurement with the average detector is unnecessary.
 (4) The emission levels of other frequencies were very low against the limit.
 (5) Correction Factor = Insertion loss + Cable loss
 (6) Margin value = Emission level - Limit value

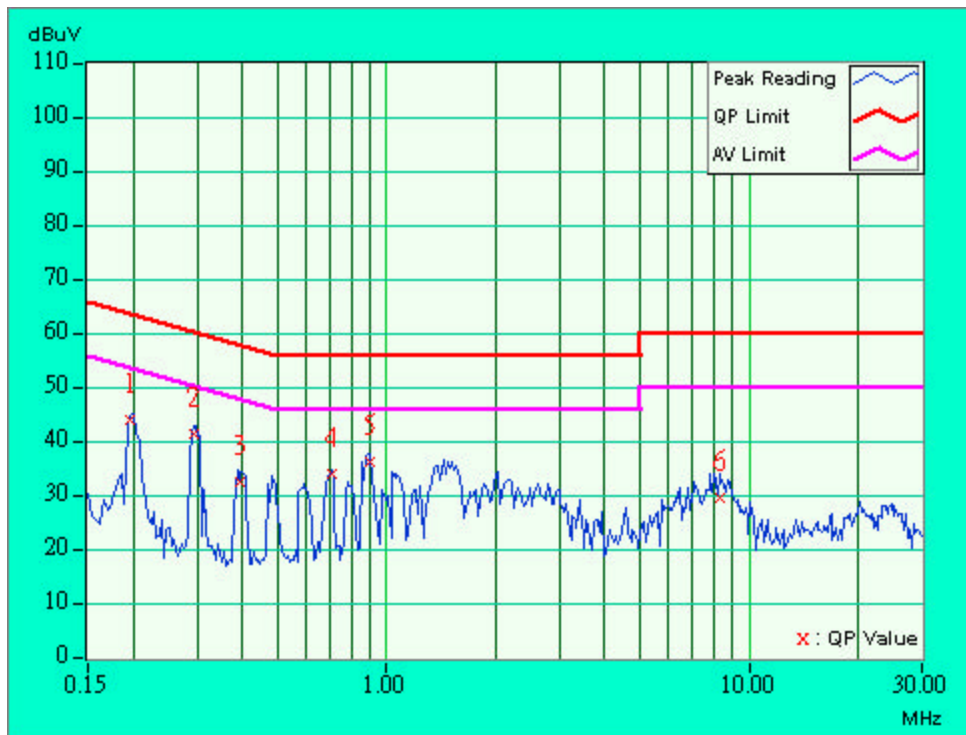



EUT	Flanker Pro Dual Radio AP		
MODEL	AP-AG-AT-02		
MODE	Channel 11	6dB BANDWIDTH	9 kHz
INPUT POWER (SYSTEM)	120Vac, 60Hz	PHASE	Neutral (N)
ENVIRONMENTAL CONDITIONS	27deg. C, 60%RH, 982 hPa	TESTED BY	Tony Chen

No	Freq. [MHz]	Corr. Factor (dB)	Reading Value [dB (uV)]		Emission Level [dB (uV)]		Limit [dB (uV)]		Margin (dB)	
			Q.P.	AV.	Q.P.	AV.	Q.P.	AV.	Q.P.	AV.
1	0.197	0.20	45.24	-	45.44	-	63.74	53.74	-18.30	-
2	0.295	0.20	37.44	-	37.64	-	60.40	50.40	-22.76	-
3	0.396	0.20	39.38	-	39.58	-	57.93	47.93	-18.35	-
4	0.494	0.22	36.63	-	36.85	-	56.10	46.10	-19.26	-
5	0.599	0.23	39.13	-	39.36	-	56.00	46.00	-16.64	-
6	1.201	0.30	35.66	-	35.96	-	56.00	46.00	-20.04	-

- NOTES:** (1) "***": Undetectable
 (2) Q.P. and AV. are abbreviations of quasi-peak and average.
 (3) "-": The Quasi-peak reading value also meets an average limit, thus measurement with the average detector is unnecessary.
 (4) The emission levels of other frequencies were very low against the limit.
 (5) Correction Factor = Insertion loss + Cable loss
 (6) Margin value = Emission level - Limit value

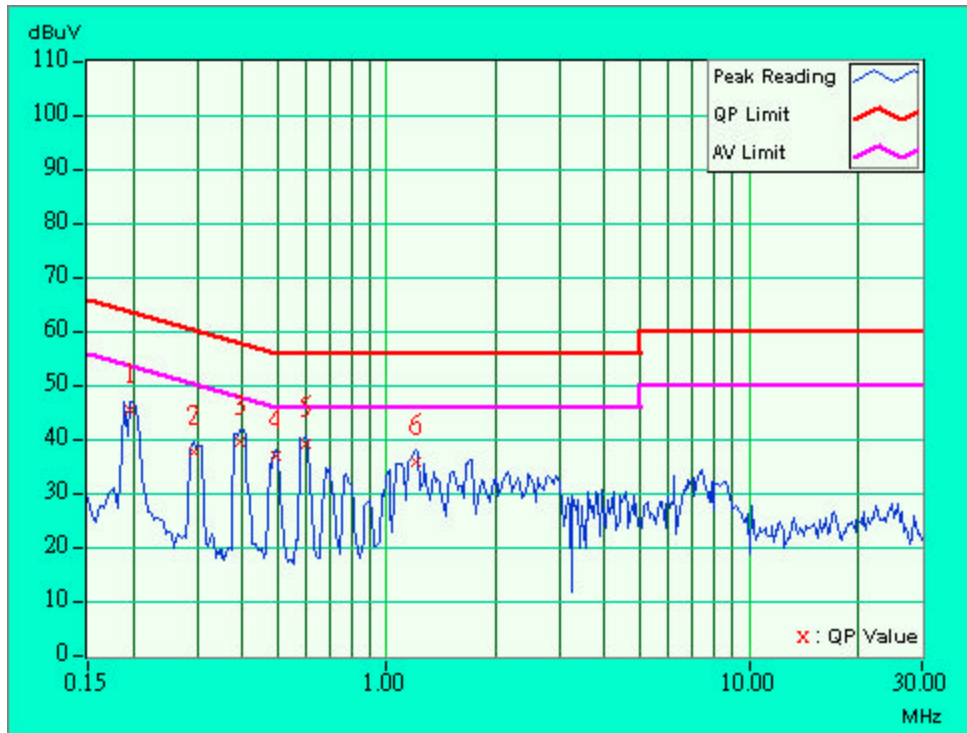



4.1.12 TEST RESULTS (For 3 Ethernet ports - POE)

EUT	Flanker Pro Dual Radio AP		
MODEL	AP-AG-AT-02		
MODE	Channel 11	6dB BANDWIDTH	9 kHz
INPUT POWER (SYSTEM)	120Vac, 60Hz	PHASE	Line (L)
ENVIRONMENTAL CONDITIONS	27deg. C, 60%RH, 982 hPa	TESTED BY	Tony Chen

No	Freq. [MHz]	Corr. Factor (dB)	Reading Value [dB (uV)]		Emission Level [dB (uV)]		Limit [dB (uV)]		Margin (dB)	
			Q.P.	AV.	Q.P.	AV.	Q.P.	AV.	Q.P.	AV.
1	0.150	0.20	53.22	-	53.42	-	66.00	56.00	-12.58	-
2	0.185	0.20	47.85	-	48.05	-	64.25	54.25	-16.20	-
3	0.220	0.20	45.40	-	45.60	-	62.81	52.81	-17.21	-
4	2.377	0.32	45.97	43.78	46.29	44.10	56.00	46.00	-9.71	-1.90
5	3.544	0.38	41.03	-	41.41	-	56.00	46.00	-14.59	-
6	4.207	0.41	41.06	-	41.47	-	56.00	46.00	-14.53	-

- NOTES:** (1) "***": Undetectable
 (2) Q.P. and AV. are abbreviations of quasi-peak and average.
 (3) "-": The Quasi-peak reading value also meets an average limit, thus measurement with the average detector is unnecessary.
 (4) The emission levels of other frequencies were very low against the limit.
 (5) Correction Factor = Insertion loss + Cable loss
 (6) Margin value = Emission level - Limit value

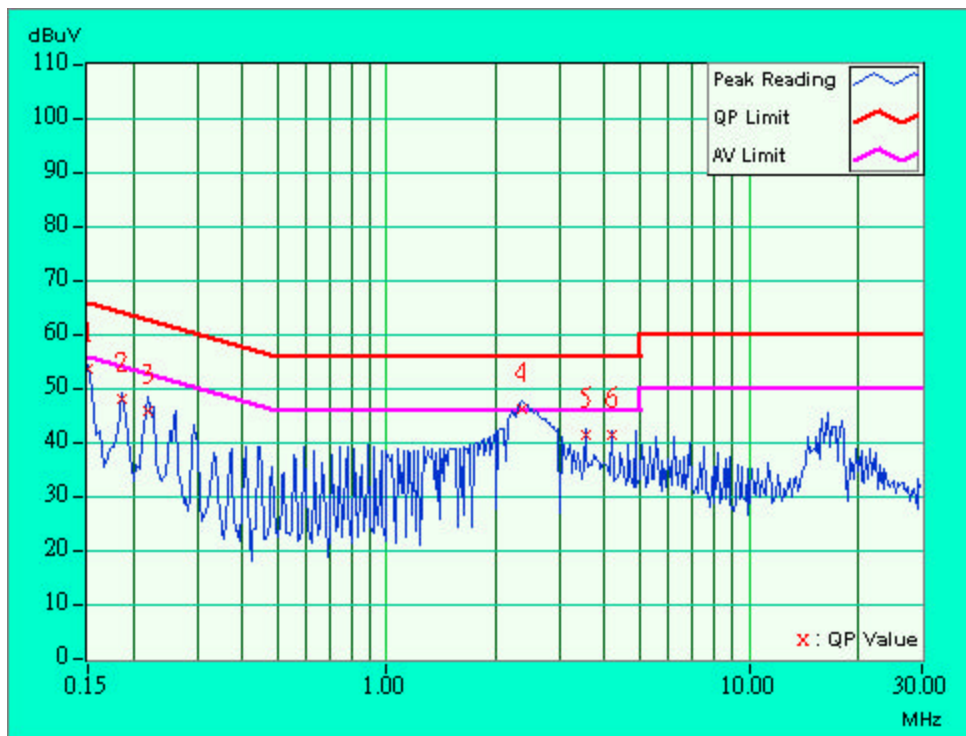



EUT	Flanker Pro Dual Radio AP		
MODEL	AP-AG-AT-02		
MODE	Channel 11	6dB BANDWIDTH	9 kHz
INPUT POWER (SYSTEM)	120Vac, 60Hz	PHASE	Neutral (N)
ENVIRONMENTAL CONDITIONS	27deg. C, 60%RH, 982 hPa	TESTED BY	Tony Chen

No	Freq. [MHz]	Corr. Factor (dB)	Reading Value [dB (uV)]		Emission Level [dB (uV)]		Limit [dB (uV)]		Margin (dB)	
			Q.P.	AV.	Q.P.	AV.	Q.P.	AV.	Q.P.	AV.
1	0.150	0.20	53.06	-	53.26	-	66.00	56.00	-12.74	-
2	0.224	0.20	46.85	-	47.05	-	62.66	52.66	-15.61	-
3	0.259	0.20	43.64	-	43.84	-	61.45	51.45	-17.61	-
4	2.413	0.32	46.21	44.10	46.53	44.42	56.00	46.00	-9.47	-1.58
5	3.543	0.38	39.50	-	39.88	-	56.00	46.00	-16.12	-
6	4.211	0.41	41.49	-	41.90	-	56.00	46.00	-14.10	-

- NOTES:** (1) "***": Undetectable
 (2) Q.P. and AV. are abbreviations of quasi-peak and average.
 (3) "-": The Quasi-peak reading value also meets an average limit, thus measurement with the average detector is unnecessary.
 (4) The emission levels of other frequencies were very low against the limit.
 (5) Correction Factor = Insertion loss + Cable loss
 (6) Margin value = Emission level - Limit value

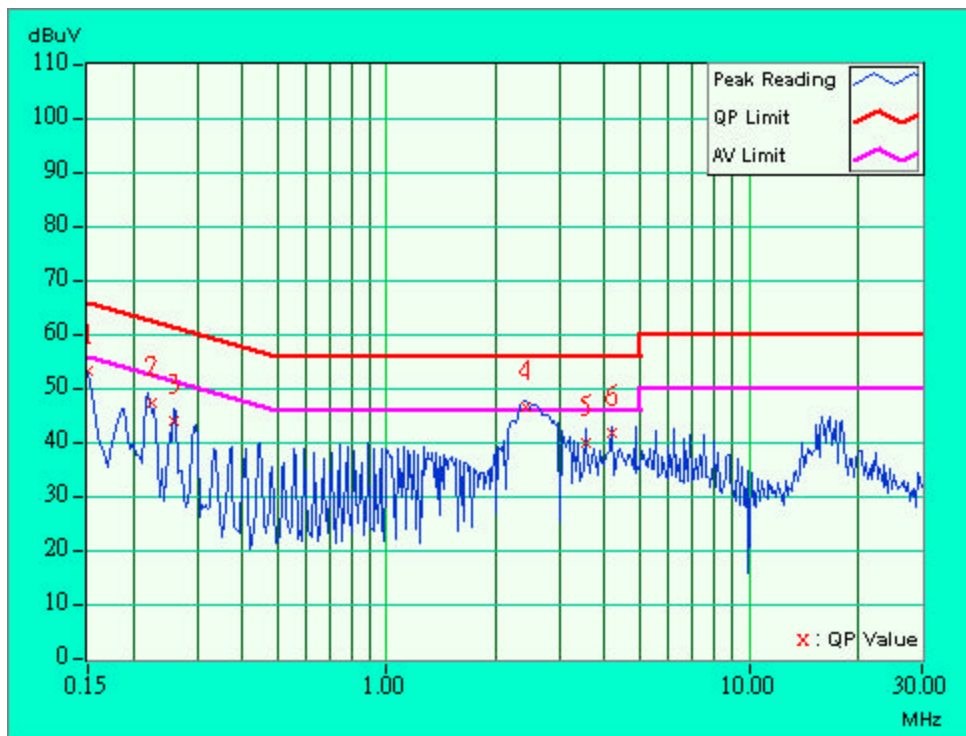



4.2 RADIATED EMISSION MEASUREMENT

4.2.1 LIMITS OF RADIATED EMISSION MEASUREMENT

Field strength limits are at the distance of 3 meters, emissions radiated outside of the specified bands, shall be according to the general radiated limits in 15.209 as following:

Frequencies (MHz)	Field strength (microvolts/meter)	Measurement distance (meters)
0.009-0.490	2400/F(kHz)	300
0.490-1.705	24000/F(kHz)	30
1.705-30.0	30	30
30-88	100	3
88-216	150	3
216-960	200	3
Above 960	500	3

NOTE:

1. The lower limit shall apply at the transition frequencies.
2. Emission level (dBuV/m) = 20 log Emission level (uV/m).
3. As shown in 15.35(b), for frequencies above 1000MHz, the field strength limits are based on average detector, however, the peak field strength of any emission shall not exceed the maximum permitted average limits, specified above by more than 20dB under any condition of modulation.



4.2.2 TEST INSTRUMENTS

DESCRIPTION & MANUFACTURER	MODEL NO.	SERIAL NO.	CALIBRATED UNTIL
HP Spectrum Analyzer	8594ER	3829U04676	Jul. 14, 2004
ADVANTEST Spectrum Analyzer	R3271A	85060311	May 21, 2004
CHASE RF Pre_Amplifier	CPA9232	1057	Apr. 24, 2004
HP Pre_Amplifier	8449B	3008A01281	June 27, 2004
ROHDE & SCHWARZ Test Receiver	ESVS 10	849231 /019	Nov. 03, 2004
CHASE Broadband Antenna	CBL6111c	2730	Jul 17, 2004
Schwarzbeck Horn_Antenna	3115	5619	Jul. 17, 2004
SCHWARZBECK Tunable Dipole Antenna	UHAP	897	Mar. 07, 2005
SCHWARZBECK Tunable Dipole Antenna	VHAP	880	Mar. 07, 2005
RF Switches (ARNITSU)	CS-201	1565157	Dec. 01, 2004
RF CABLE (Chaintek) 1GHz-20GHz	SF102	22054-2	Feb. 10. 2004
RF Cable(RICHTEC)	9913-30M	STCCAB-30M-1GH z-021	Nov. 5, 2004
Software	AS60P8	NA	NA
CHANCE MOST Antenna Tower	AT-100	0203	NA
CHANCE MOST Turn Table	TT-100	0203	NA

Note: 1. The calibration interval of the above test instruments is 12 months (36 months for Tunable Dipole Antenna) and the calibrations are traceable to NML/ROC and NIST/USA.

2. * = These equipment are used for the final measurement.
3. The horn antenna and HP preamplifier (model: 8449B) are used only for the measurement of emission frequency above 1GHz if tested.
4. The test was performed in ADT Open Site No. C.
5. The FCC Site Registration No. is 656396.
6. The VCCI Site Registration No. is R-1626.
7. The CANADA Site Registration No. is IC 3789-C.



4.2.3 TEST PROCEDURES

- a. The EUT was placed on the top of a rotating table 0.8 meters above the ground at a 10 meter open area test site. The table was rotated 360 degrees to determine the position of the highest radiation.
- b. The EUT was set 3 meters away from the interference-receiving antenna, which was mounted on the top of a variable-height antenna tower.
- c. The antenna is a broadband antenna, and its height is varied from one meter to four meters above the ground to determine the maximum value of the field strength. Both horizontal and vertical polarizations of the antenna are set to make the measurement.
- d. For each suspected emission, the EUT was arranged to its worst case and then the antenna was tuned to heights from 1 meter to 4 meters and the rotatable table was turned from 0 degrees to 360 degrees to find the maximum reading.
- e. The test-receiver system was set to Peak Detect Function and Specified Bandwidth with Maximum Hold Mode.
- f. If the emission level of the EUT in peak mode was 10 dB lower than the limit specified, then testing could be stopped and the peak values of the EUT would be reported. Otherwise the emissions that did not have 10 dB margin would be re-tested one by one using the quasi-peak method or average method as specified and then reported in Data sheet peak mode and QP mode.

NOTE:

1. The resolution bandwidth and video bandwidth of test receiver/spectrum analyzer is 120kHz for Quasi-peak detection at frequency below 1GHz.
2. The resolution bandwidth and video bandwidth of test receiver/spectrum analyzer is 1 MHz for Peak detection (PK) at frequency above 1GHz.
3. The resolution bandwidth of test receiver/spectrum analyzer is 1 MHz and the video bandwidth is 300 Hz for Average detection (AV) at frequency above 1GHz.

4.2.4 DEVIATION FROM TEST STANDARD

No deviation

4.2.5 TEST SETUP

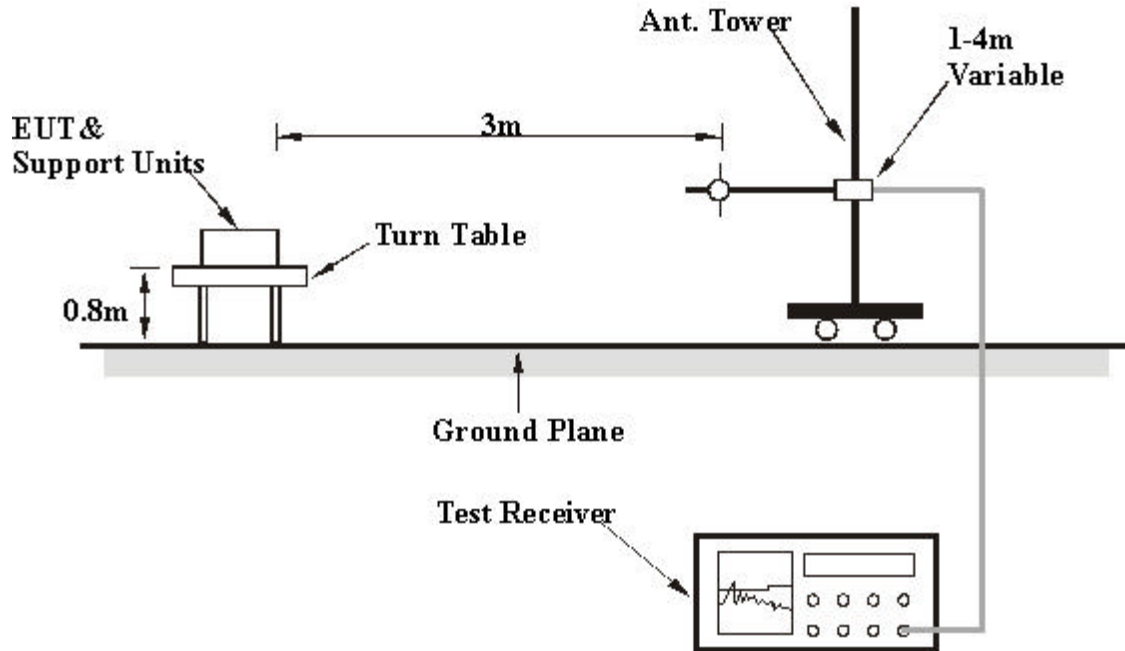

For the actual test configuration, please refer to the related item – Photographs of the Test Configuration.

4.2.6 EUT OPERATING CONDITIONS

Same as 4.1.6



4.2.7 TEST RESULTS

For 1 Ethernet port

EUT	Flanker Pro Dual Radio AP	MODEL	AP-AG-AT-02
MODE	Channel 11 (Antenna 1-Adapter 1)	FREQUENCY RANGE	Below 1000 MHz
INPUT POWER (SYSTEM)	120Vac, 60Hz	DETECTOR FUNCTION	Quasi-Peak
ENVIRONMENTAL CONDITIONS	29deg. C, 56%RH, 982 hPa	TESTED BY	Eric Lee

ANTENNA POLARITY & TEST DISTANCE: HORIZONTAL AT 3 M

No.	Freq. (MHz)	Emission Level (dBuV/m)	Limit (dBuV/m)	Margin (dB)	Antenna Height (m)	Table Angle (Degree)	Raw Value (dBuV)	Correction Factor (dB/m)
1	120.02	22.40 QP	43.50	-21.10	1.20 H	320	10.90	11.50
2	125.40	27.40 QP	43.50	-16.10	1.35 H	62	15.40	12.00
3	200.05	23.40 QP	43.50	-20.10	1.20 H	354	14.40	9.00
4	250.11	30.00 QP	46.00	-16.00	1.32 H	320	17.00	13.00
5	300.98	29.00 QP	46.00	-17.00	1.23 H	90	14.80	14.20
6	330.05	29.50 QP	46.00	-16.50	1.52 H	28	14.70	14.90
7	375.17	26.80 QP	46.00	-19.20	1.23 H	309	10.60	16.20
8	400.00	26.70 QP	46.00	-19.30	1.69 H	254	9.60	17.10
9	500.21	30.40 QP	46.00	-15.60	1.60 H	3	11.10	19.30
10	750.43	35.30 QP	46.00	-10.70	1.50 H	240	11.50	23.80

ANTENNA POLARITY & TEST DISTANCE: VERTICAL AT 3 M

No.	Freq. (MHz)	Emission Level (dBuV/m)	Limit (dBuV/m)	Margin (dB)	Antenna Height (m)	Table Angle (Degree)	Raw Value (dBuV)	Correction Factor (dB/m)
1	48.20	24.70 QP	40.00	-15.30	1.49 V	335	15.20	9.40
2	120.03	26.70 QP	43.50	-16.80	1.53 V	69	15.20	11.50
3	125.33	27.00 QP	43.50	-16.50	1.82 V	254	15.00	12.00
4	200.24	25.50 QP	43.50	-18.00	2.00 V	65	16.50	9.00
5	250.24	31.60 QP	46.00	-14.40	1.53 V	309	18.50	13.00
6	330.06	32.20 QP	46.00	-13.80	1.52 V	323	17.30	14.90
7	375.63	27.20 QP	46.00	-18.80	1.98 V	63	11.00	16.20
8	400.36	29.20 QP	46.00	-16.80	1.54 V	203	12.10	17.10
9	500.35	30.60 QP	46.00	-15.40	1.36 V	63	11.30	19.30
10	750.02	36.00 QP	46.00	-10.00	1.35 V	69	12.20	23.80

- REMARKS:**
1. Emission level(dBuV/m)=Raw Value(dBuV) + Correction Factor(dB)
 2. Correction Factor(dB/m) = Antenna Factor (dB/m) + Cable Factor (dB)
 3. The other emission levels were very low against the limit.
 4. Margin value = Emission level – Limit value.



EUT	Flanker Pro Dual Radio AP	MODEL	AP-AG-AT-02
MODE	Channel 11 (Antenna 1-Adapter 2)	FREQUENCY RANGE	Below 1000 MHz
INPUT POWER (SYSTEM)	120Vac, 60Hz	DETECTOR FUNCTION	Quasi-Peak
ENVIRONMENTAL CONDITIONS	29deg. C, 56%RH, 982 hPa	TESTED BY	Eric Lee

ANTENNA POLARITY & TEST DISTANCE: HORIZONTAL AT 3 M

No.	Freq. (MHz)	Emission Level (dBuV/m)	Limit (dBuV/m)	Margin (dB)	Antenna Height (m)	Table Angle (Degree)	Raw Value (dBuV)	Correction Factor (dB/m)
1	120.41	24.50 QP	43.50	-19.00	1.40 H	283	13.00	11.50
2	125.21	27.50 QP	43.50	-16.00	1.08 H	360	15.50	12.00
3	199.69	26.00 QP	43.50	-17.50	1.43 H	298	17.00	9.00
4	250.01	27.60 QP	46.00	-18.40	1.48 H	19	14.50	13.00
5	300.30	26.50 QP	46.00	-19.50	1.64 H	352	12.30	14.20
6	330.04	28.50 QP	46.00	-17.50	1.57 H	125	13.60	14.90
7	375.00	28.00 QP	46.00	-18.00	1.11 H	357	11.80	16.20
8	401.00	28.00 QP	46.00	-18.00	1.92 H	359	10.80	17.10
9	500.02	30.70 QP	46.00	-15.30	1.11 H	40	11.40	19.30
10	749.96	35.20 QP	46.00	-10.80	1.42 H	201	11.40	23.80

ANTENNA POLARITY & TEST DISTANCE: VERTICAL AT 3 M

No.	Freq. (MHz)	Emission Level (dBuV/m)	Limit (dBuV/m)	Margin (dB)	Antenna Height (m)	Table Angle (Degree)	Raw Value (dBuV)	Correction Factor (dB/m)
1	48.69	24.60 QP	40.00	-15.40	1.85 V	52	15.50	9.20
2	125.96	27.60 QP	43.50	-15.90	1.56 V	326	15.60	12.00
3	200.09	26.80 QP	43.50	-16.70	1.59 V	96	17.80	9.00
4	200.71	24.30 QP	43.50	-19.20	1.42 V	306	15.30	9.00
5	250.01	28.60 QP	46.00	-17.40	1.36 V	217	15.60	13.00
6	330.14	31.20 QP	46.00	-14.80	1.43 V	213	16.30	14.90
7	375.03	28.50 QP	46.00	-17.50	1.52 V	202	12.30	16.20
8	400.00	28.20 QP	46.00	-17.80	1.73 V	37	11.10	17.10
9	500.03	33.20 QP	46.00	-12.80	1.52 V	320	13.90	19.30
10	750.02	33.30 QP	46.00	-12.70	1.82 V	204	9.50	23.80

- REMARKS:**
1. Emission level(dBuV/m)=Raw Value(dBuV) + Correction Factor(dB)
 2. Correction Factor(dB/m) = Antenna Factor (dB/m) + Cable Factor (dB)
 3. The other emission levels were very low against the limit.
 4. Margin value = Emission level – Limit value.



EUT	Flanker Pro Dual Radio AP	MODEL	AP-AG-AT-02
MODE	Channel 11 (Antenna 1-POE)	FREQUENCY RANGE	Below 1000 MHz
INPUT POWER (SYSTEM)	120Vac, 60Hz	DETECTOR FUNCTION	Quasi-Peak
ENVIRONMENTAL CONDITIONS	29deg. C, 56%RH, 982 hPa	TESTED BY	Eric Lee

ANTENNA POLARITY & TEST DISTANCE: HORIZONTAL AT 3 M

No.	Freq. (MHz)	Emission Level (dBuV/m)	Limit (dBuV/m)	Margin (dB)	Antenna Height (m)	Table Angle (Degree)	Raw Value (dBuV)	Correction Factor (dB/m)
1	119.99	24.50 QP	43.50	-19.00	1.86 H	6	13.00	11.50
2	125.03	24.10 QP	43.50	-19.40	1.88 H	5	12.00	12.00
3	200.53	24.60 QP	43.50	-18.90	1.36 H	62	15.70	9.00
4	250.41	25.80 QP	46.00	-20.20	1.75 H	63	12.80	13.10
5	330.49	28.60 QP	46.00	-17.40	1.00 H	53	13.70	14.90
6	375.10	26.80 QP	46.00	-19.20	1.05 H	223	10.60	16.20
7	500.07	32.10 QP	46.00	-13.90	1.63 H	69	12.80	19.30
8	600.04	30.70 QP	46.00	-15.30	1.40 H	215	9.80	20.90
9	624.86	30.80 QP	46.00	-15.20	1.56 H	235	9.10	21.70
10	750.10	32.50 QP	46.00	-13.50	1.54 H	87	8.70	23.80

ANTENNA POLARITY & TEST DISTANCE: VERTICAL AT 3 M

No.	Freq. (MHz)	Emission Level (dBuV/m)	Limit (dBuV/m)	Margin (dB)	Antenna Height (m)	Table Angle (Degree)	Raw Value (dBuV)	Correction Factor (dB/m)
1	120.06	25.00 QP	43.50	-18.50	1.60 V	325	13.50	11.50
2	125.00	25.00 QP	43.50	-18.50	1.22 V	137	12.90	12.10
3	200.08	27.30 QP	43.50	-16.20	1.56 V	26	18.30	9.00
4	250.81	30.20 QP	46.00	-15.80	1.95 V	326	17.10	13.10
5	330.52	32.00 QP	46.00	-14.00	1.75 V	43	17.10	14.90
6	374.99	28.60 QP	46.00	-17.40	1.63 V	3	12.40	16.20
7	400.51	26.80 QP	46.00	-19.20	1.59 V	353	9.70	17.10
8	500.00	29.60 QP	46.00	-16.40	1.88 V	48	10.30	19.30
9	625.83	33.10 QP	46.00	-12.90	1.84 V	299	11.40	21.70
10	750.01	34.20 QP	46.00	-11.80	1.50 V	66	10.50	23.80

- REMARKS:**
1. Emission level(dBuV/m)=Raw Value(dBuV) + Correction Factor(dB)
 2. Correction Factor(dB/m) = Antenna Factor (dB/m) + Cable Factor (dB)
 3. The other emission levels were very low against the limit.
 4. Margin value = Emission level – Limit value.



EUT	Flanker Pro Dual Radio AP	MODEL	AP-AG-AT-02
MODE	Channel 11 (Antenna 2-Adapter 1)	FREQUENCY RANGE	Below 1000 MHz
INPUT POWER (SYSTEM)	120Vac, 60Hz	DETECTOR FUNCTION	Quasi-Peak
ENVIRONMENTAL CONDITIONS	29deg. C, 56%RH, 982 hPa	TESTED BY	Eric Lee

ANTENNA POLARITY & TEST DISTANCE: HORIZONTAL AT 3 M

No.	Freq. (MHz)	Emission Level (dBuV/m)	Limit (dBuV/m)	Margin (dB)	Antenna Height (m)	Table Angle (Degree)	Raw Value (dBuV)	Correction Factor (dB/m)
1	119.98	25.50 QP	43.50	-18.00	1.53 H	69	14.00	11.50
2	125.00	27.10 QP	43.50	-16.40	1.23 H	359	15.00	12.10
3	199.99	21.30 QP	43.50	-22.20	1.02 H	96	12.30	9.00
4	250.03	26.90 QP	46.00	-19.10	1.22 H	290	13.90	13.00
5	330.09	30.00 QP	46.00	-16.00	1.42 H	202	15.10	14.90
6	374.99	27.20 QP	46.00	-18.80	1.43 H	52	11.00	16.20
7	500.01	31.90 QP	46.00	-14.10	1.53 H	237	12.60	19.30
8	600.43	30.50 QP	46.00	-15.50	1.39 H	56	9.60	20.90
9	624.99	30.70 QP	46.00	-15.30	1.00 H	253	9.00	21.70
10	750.22	34.70 QP	46.00	-11.30	1.53 H	33	10.90	23.80

ANTENNA POLARITY & TEST DISTANCE: VERTICAL AT 3 M

No.	Freq. (MHz)	Emission Level (dBuV/m)	Limit (dBuV/m)	Margin (dB)	Antenna Height (m)	Table Angle (Degree)	Raw Value (dBuV)	Correction Factor (dB/m)
1	50.20	25.30 QP	40.00	-14.70	1.20 V	14	16.90	8.40
2	119.86	27.50 QP	43.50	-16.00	1.20 V	132	16.00	11.50
3	125.00	26.60 QP	43.50	-16.90	1.02 V	3	14.60	12.10
4	200.21	25.30 QP	43.50	-18.20	1.25 V	332	16.30	9.00
5	250.30	29.90 QP	46.00	-16.10	1.37 V	220	16.90	13.00
6	330.02	31.20 QP	46.00	-14.80	1.11 V	47	16.30	14.90
7	375.24	26.60 QP	46.00	-19.40	1.02 V	9	10.40	16.20
8	400.23	28.10 QP	46.00	-17.90	1.58 V	93	11.00	17.10
9	500.29	30.20 QP	46.00	-15.80	1.46 V	354	10.90	19.30
10	749.99	34.80 QP	46.00	-11.20	1.21 V	47	11.00	23.80

- REMARKS:**
1. Emission level(dBuV/m)=Raw Value(dBuV) + Correction Factor(dB)
 2. Correction Factor(dB/m) = Antenna Factor (dB/m) + Cable Factor (dB)
 3. The other emission levels were very low against the limit.
 4. Margin value = Emission level – Limit value.



EUT	Flanker Pro Dual Radio AP	MODEL	AP-AG-AT-02
MODE	Channel 11 (Antenna 2-Adapter 2)	FREQUENCY RANGE	Below 1000 MHz
INPUT POWER (SYSTEM)	120Vac, 60Hz	DETECTOR FUNCTION	Quasi-Peak
ENVIRONMENTAL CONDITIONS	29deg. C, 56%RH, 982 hPa	TESTED BY	Eric Lee

ANTENNA POLARITY & TEST DISTANCE: HORIZONTAL AT 3 M

No.	Freq. (MHz)	Emission Level (dBuV/m)	Limit (dBuV/m)	Margin (dB)	Antenna Height (m)	Table Angle (Degree)	Raw Value (dBuV)	Correction Factor (dB/m)
1	119.93	22.70 QP	43.50	-20.80	1.40 H	253	11.20	11.50
2	125.40	27.70 QP	43.50	-15.80	1.40 H	309	15.70	12.00
3	199.99	24.00 QP	43.50	-19.50	1.56 H	202	15.00	9.00
4	250.11	29.30 QP	46.00	-16.70	1.43 H	62	16.30	13.00
5	300.61	27.70 QP	46.00	-18.30	1.27 H	85	13.50	14.20
6	330.02	29.10 QP	46.00	-16.90	1.86 H	3	14.20	14.90
7	375.08	27.00 QP	46.00	-19.00	1.02 H	321	10.80	16.20
8	400.00	26.70 QP	46.00	-19.30	1.69 H	253	9.60	17.10
9	500.09	30.80 QP	46.00	-15.20	1.54 H	7	11.50	19.30
10	750.32	36.00 QP	46.00	-10.00	1.11 H	96	12.20	23.80

ANTENNA POLARITY & TEST DISTANCE: VERTICAL AT 3 M

No.	Freq. (MHz)	Emission Level (dBuV/m)	Limit (dBuV/m)	Margin (dB)	Antenna Height (m)	Table Angle (Degree)	Raw Value (dBuV)	Correction Factor (dB/m)
1	48.62	24.00 QP	40.00	-16.00	1.11 V	160	14.80	9.20
2	119.93	28.50 QP	43.50	-15.00	1.53 V	262	17.00	11.50
3	125.02	26.60 QP	43.50	-16.90	1.12 V	32	14.60	12.00
4	199.91	24.10 QP	43.50	-19.40	1.36 V	330	15.10	9.00
5	250.00	30.00 QP	46.00	-16.00	1.63 V	115	17.00	13.00
6	330.00	29.20 QP	46.00	-16.80	1.35 V	6	14.30	14.90
7	375.42	29.00 QP	46.00	-17.00	1.85 V	22	12.80	16.20
8	400.11	27.40 QP	46.00	-18.60	1.08 V	252	10.30	17.10
9	499.99	31.60 QP	46.00	-14.40	1.70 V	21	12.30	19.30
10	750.00	31.70 QP	46.00	-14.30	1.25 V	20	7.90	23.80

- REMARKS:**
1. Emission level(dBuV/m)=Raw Value(dBuV) + Correction Factor(dB)
 2. Correction Factor(dB/m) = Antenna Factor (dB/m) + Cable Factor (dB)
 3. The other emission levels were very low against the limit.
 4. Margin value = Emission level – Limit value.



EUT	Flanker Pro Dual Radio AP	MODEL	AP-AG-AT-02
MODE	Channel 11 (Antenna 2-POE)	FREQUENCY RANGE	Below 1000 MHz
INPUT POWER (SYSTEM)	120Vac, 60Hz	DETECTOR FUNCTION	Quasi-Peak
ENVIRONMENTAL CONDITIONS	29deg. C, 56%RH, 982 hPa	TESTED BY	Eric Lee

ANTENNA POLARITY & TEST DISTANCE: HORIZONTAL AT 3 M

No.	Freq. (MHz)	Emission Level (dBuV/m)	Limit (dBuV/m)	Margin (dB)	Antenna Height (m)	Table Angle (Degree)	Raw Value (dBuV)	Correction Factor (dB/m)
1	119.93	26.20 QP	43.50	-17.30	1.24 H	39	14.70	11.50
2	125.10	25.90 QP	43.50	-17.60	1.80 H	123	13.90	12.00
3	200.24	24.20 QP	43.50	-19.30	1.90 H	210	15.20	9.00
4	249.99	27.70 QP	46.00	-18.30	1.82 H	52	14.70	13.00
5	330.40	30.90 QP	46.00	-15.10	1.54 H	20	16.00	14.90
6	375.69	25.20 QP	46.00	-20.80	1.28 H	88	9.00	16.20
7	500.00	33.50 QP	46.00	-12.50	1.28 H	9	14.20	19.30
8	600.11	29.80 QP	46.00	-16.20	1.80 H	243	8.90	20.90
9	624.73	32.70 QP	46.00	-13.30	1.59 H	357	11.00	21.70
10	750.05	34.10 QP	46.00	-11.90	1.39 H	168	10.30	23.80

ANTENNA POLARITY & TEST DISTANCE: VERTICAL AT 3 M

No.	Freq. (MHz)	Emission Level (dBuV/m)	Limit (dBuV/m)	Margin (dB)	Antenna Height (m)	Table Angle (Degree)	Raw Value (dBuV)	Correction Factor (dB/m)
1	50.24	26.80 QP	40.00	-13.20	1.16 V	243	18.40	8.40
2	120.03	30.40 QP	43.50	-13.10	1.11 V	47	18.90	11.50
3	125.39	25.60 QP	43.50	-17.90	1.07 V	345	13.60	12.00
4	200.34	21.30 QP	43.50	-22.20	1.45 V	231	12.30	9.00
5	250.30	28.20 QP	46.00	-17.80	1.42 V	360	15.20	13.00
6	330.24	31.20 QP	46.00	-14.80	1.11 V	201	16.30	14.90
7	374.99	27.00 QP	46.00	-19.00	1.87 V	347	10.80	16.20
8	399.86	28.00 QP	46.00	-18.00	1.15 V	243	10.90	17.10
9	500.20	30.60 QP	46.00	-15.40	1.99 V	23	11.20	19.30
10	700.13	30.30 QP	46.00	-15.70	1.37 V	47	7.90	22.40

- REMARKS:**
1. Emission level(dBuV/m)=Raw Value(dBuV) + Correction Factor(dB)
 2. Correction Factor(dB/m) = Antenna Factor (dB/m) + Cable Factor (dB)
 3. The other emission levels were very low against the limit.
 4. Margin value = Emission level – Limit value.



EUT	Flanker Pro Dual Radio AP	MODEL	AP-AG-AT-02
MODE	Channel 11 (Antenna 3-Adapter 1)	FREQUENCY RANGE	Below 1000 MHz
INPUT POWER (SYSTEM)	120Vac, 60Hz	DETECTOR FUNCTION	Quasi-Peak
ENVIRONMENTAL CONDITIONS	29deg. C, 56%RH, 982 hPa	TESTED BY	Eric Lee

ANTENNA POLARITY & TEST DISTANCE: HORIZONTAL AT 3 M

No.	Freq. (MHz)	Emission Level (dBuV/m)	Limit (dBuV/m)	Margin (dB)	Antenna Height (m)	Table Angle (Degree)	Raw Value (dBuV)	Correction Factor (dB/m)
1	120.23	26.90 QP	43.50	-16.60	1.02 H	24	14.30	12.60
2	125.01	28.30 QP	43.50	-15.20	1.78 H	54	15.20	13.10
3	200.73	25.30 QP	43.50	-18.20	1.63 H	69	15.30	10.00
4	250.01	30.60 QP	46.00	-15.40	1.47 H	163	16.20	14.40
5	300.10	28.40 QP	46.00	-17.60	1.55 H	23	13.00	15.40
6	330.12	31.50 QP	46.00	-14.50	1.52 H	52	15.20	16.30
7	375.00	27.80 QP	46.00	-18.20	1.54 H	2	10.00	17.80
8	399.99	32.50 QP	46.00	-13.50	1.87 H	3	13.80	18.70
9	500.02	34.20 QP	46.00	-11.80	1.55 H	65	12.60	21.60
10	750.43	42.00 QP	46.00	-4.00	1.36 H	62	15.90	26.10

ANTENNA POLARITY & TEST DISTANCE: VERTICAL AT 3 M

No.	Freq. (MHz)	Emission Level (dBuV/m)	Limit (dBuV/m)	Margin (dB)	Antenna Height (m)	Table Angle (Degree)	Raw Value (dBuV)	Correction Factor (dB/m)
1	48.25	25.50 QP	40.00	-14.50	1.65 V	8	15.50	10.00
2	120.01	29.80 QP	43.50	-13.70	1.87 V	56	17.20	12.60
3	125.05	28.90 QP	43.50	-14.60	1.66 V	333	15.90	13.10
4	200.00	26.10 QP	43.50	-17.40	1.11 V	2	16.00	10.10
5	250.03	30.30 QP	46.00	-15.70	1.47 V	56	15.90	14.40
6	330.19	33.10 QP	46.00	-12.90	1.75 V	62	16.80	16.30
7	375.24	28.20 QP	46.00	-17.80	1.70 V	213	10.40	17.80
8	400.05	29.30 QP	46.00	-16.70	1.69 V	3	10.60	18.70
9	500.00	32.20 QP	46.00	-13.80	1.54 V	74	10.60	21.60
10	750.01	38.70 QP	46.00	-7.30	1.65 V	35	12.60	26.10

- REMARKS:**
1. Emission level(dBuV/m)=Raw Value(dBuV) + Correction Factor(dB)
 2. Correction Factor(dB/m) = Antenna Factor (dB/m) + Cable Factor (dB)
 3. The other emission levels were very low against the limit.
 4. Margin value = Emission level – Limit value.



EUT	Flanker Pro Dual Radio AP	MODEL	AP-AG-AT-02
MODE	Channel 11 (Antenna 3-Adapter 2)	FREQUENCY RANGE	Below 1000 MHz
INPUT POWER (SYSTEM)	120Vac, 60Hz	DETECTOR FUNCTION	Quasi-Peak
ENVIRONMENTAL CONDITIONS	29deg. C, 56%RH, 982 hPa	TESTED BY	Eric Lee

ANTENNA POLARITY & TEST DISTANCE: HORIZONTAL AT 3 M

No.	Freq. (MHz)	Emission Level (dBuV/m)	Limit (dBuV/m)	Margin (dB)	Antenna Height (m)	Table Angle (Degree)	Raw Value (dBuV)	Correction Factor (dB/m)
1	120.01	26.90 QP	43.50	-16.60	1.49 H	162	14.30	12.60
2	125.02	28.50 QP	43.50	-15.00	1.45 H	21	15.50	13.10
3	250.33	30.20 QP	46.00	-15.80	1.33 H	9	15.80	14.40
4	300.00	28.90 QP	46.00	-17.10	1.44 H	47	13.50	15.40
5	330.24	30.60 QP	46.00	-15.40	1.69 H	8	14.30	16.30
6	375.24	30.60 QP	46.00	-15.40	1.11 H	9	12.80	17.80
7	400.21	31.90 QP	46.00	-14.10	1.47 H	45	13.20	18.70
8	600.00	33.50 QP	46.00	-12.50	1.36 H	54	10.60	22.90
9	625.35	33.70 QP	46.00	-12.30	1.35 H	62	9.90	23.80
10	750.03	36.70 QP	46.00	-9.30	1.23 H	69	10.60	26.10

ANTENNA POLARITY & TEST DISTANCE: VERTICAL AT 3 M

No.	Freq. (MHz)	Emission Level (dBuV/m)	Limit (dBuV/m)	Margin (dB)	Antenna Height (m)	Table Angle (Degree)	Raw Value (dBuV)	Correction Factor (dB/m)
1	47.63	27.30 QP	40.00	-12.70	1.10 V	192	17.00	10.30
2	120.00	27.80 QP	43.50	-15.70	1.11 V	4	15.30	12.60
3	125.24	26.60 QP	43.50	-16.90	1.25 V	46	13.60	13.00
4	200.00	26.60 QP	43.50	-16.90	1.65 V	360	16.50	10.10
5	250.17	30.30 QP	46.00	-15.70	1.65 V	254	15.90	14.40
6	330.26	32.90 QP	46.00	-13.10	1.45 V	62	16.60	16.30
7	375.01	28.30 QP	46.00	-17.70	1.50 V	255	10.50	17.80
8	399.98	29.70 QP	46.00	-16.30	1.86 V	9	11.00	18.70
9	500.02	32.50 QP	46.00	-13.50	1.87 V	54	10.90	21.60
10	750.26	36.60 QP	46.00	-9.40	1.56 V	32	10.50	26.10

- REMARKS:**
1. Emission level(dBuV/m)=Raw Value(dBuV) + Correction Factor(dB)
 2. Correction Factor(dB/m) = Antenna Factor (dB/m) + Cable Factor (dB)
 3. The other emission levels were very low against the limit.
 4. Margin value = Emission level – Limit value.



EUT	Flanker Pro Dual Radio AP	MODEL	AP-AG-AT-02
MODE	Channel 11 (Antenna 3-POE)	FREQUENCY RANGE	Below 1000 MHz
INPUT POWER (SYSTEM)	120Vac, 60Hz	DETECTOR FUNCTION	Quasi-Peak
ENVIRONMENTAL CONDITIONS	29deg. C, 56%RH, 982 hPa	TESTED BY	Eric Lee

ANTENNA POLARITY & TEST DISTANCE: HORIZONTAL AT 3 M

No.	Freq. (MHz)	Emission Level (dBuV/m)	Limit (dBuV/m)	Margin (dB)	Antenna Height (m)	Table Angle (Degree)	Raw Value (dBuV)	Correction Factor (dB/m)
1	120.10	26.10 QP	43.50	-17.40	1.11 H	9	13.50	12.60
2	125.24	28.90 QP	43.50	-14.60	1.11 H	98	15.80	13.00
3	200.00	25.40 QP	43.50	-18.10	1.12 H	5	15.30	10.10
4	250.60	29.70 QP	46.00	-16.30	1.25 H	7	15.20	14.50
5	300.20	28.00 QP	46.00	-18.00	1.11 H	47	12.60	15.40
6	330.21	28.80 QP	46.00	-17.20	1.28 H	87	12.50	16.30
7	375.23	29.80 QP	46.00	-16.20	1.02 H	5	12.10	17.80
8	400.00	31.60 QP	46.00	-14.40	1.45 H	63	12.90	18.70
9	500.00	34.50 QP	46.00	-11.50	1.40 H	302	12.90	21.60
10	750.02	39.40 QP	46.00	-6.60	1.52 H	201	13.20	26.10

ANTENNA POLARITY & TEST DISTANCE: VERTICAL AT 3 M

No.	Freq. (MHz)	Emission Level (dBuV/m)	Limit (dBuV/m)	Margin (dB)	Antenna Height (m)	Table Angle (Degree)	Raw Value (dBuV)	Correction Factor (dB/m)
1	48.25	26.50 QP	40.00	-13.50	1.54 V	7	16.50	10.00
2	120.24	29.50 QP	43.50	-14.00	1.03 V	6	16.90	12.60
3	125.03	28.60 QP	43.50	-14.90	1.59 V	357	15.60	13.10
4	200.00	26.40 QP	43.50	-17.10	1.14 V	202	16.30	10.10
5	250.24	31.70 QP	46.00	-14.30	1.54 V	26	17.20	14.40
6	330.12	32.50 QP	46.00	-13.50	1.65 V	4	16.20	16.30
7	375.24	28.10 QP	46.00	-17.90	1.54 V	360	10.30	17.80
8	399.99	29.40 QP	46.00	-16.60	1.56 V	36	10.80	18.70
9	500.21	31.90 QP	46.00	-14.10	1.25 V	24	10.20	21.60
10	750.01	36.50 QP	46.00	-9.50	1.25 V	21	10.40	26.10

- REMARKS:**
1. Emission level(dBuV/m)=Raw Value(dBuV) + Correction Factor(dB)
 2. Correction Factor(dB/m) = Antenna Factor (dB/m) + Cable Factor (dB)
 3. The other emission levels were very low against the limit.
 4. Margin value = Emission level – Limit value.



EUT	Flanker Pro Dual Radio AP	MODEL	AP-AG-AT-02
MODE	Channel 11 (Antenna 4-Adapter 1)	FREQUENCY RANGE	Below 1000 MHz
INPUT POWER (SYSTEM)	120Vac, 60Hz	DETECTOR FUNCTION	Quasi-Peak
ENVIRONMENTAL CONDITIONS	29deg. C, 56%RH, 982 hPa	TESTED BY	Eric Lee

ANTENNA POLARITY & TEST DISTANCE: HORIZONTAL AT 3 M

No.	Freq. (MHz)	Emission Level (dBuV/m)	Limit (dBuV/m)	Margin (dB)	Antenna Height (m)	Table Angle (Degree)	Raw Value (dBuV)	Correction Factor (dB/m)
1	119.96	24.00 QP	43.50	-19.50	1.02 H	76	12.50	11.50
2	125.00	24.80 QP	43.50	-18.80	1.24 H	87	12.70	12.10
3	200.01	24.60 QP	43.50	-18.90	1.73 H	200	15.60	9.00
4	250.00	25.30 QP	46.00	-20.70	1.05 H	74	12.30	13.00
5	329.99	30.10 QP	46.00	-15.90	1.55 H	23	15.20	14.90
6	375.01	26.10 QP	46.00	-19.90	1.52 H	90	9.90	16.20
7	500.03	32.90 QP	46.00	-13.10	1.37 H	84	13.60	19.30
8	600.00	28.90 QP	46.00	-17.10	1.65 H	107	8.00	20.90
9	625.32	33.40 QP	46.00	-12.60	1.53 H	55	11.70	21.70
10	749.99	34.80 QP	46.00	-11.20	1.52 H	20	11.00	23.80

ANTENNA POLARITY & TEST DISTANCE: VERTICAL AT 3 M

No.	Freq. (MHz)	Emission Level (dBuV/m)	Limit (dBuV/m)	Margin (dB)	Antenna Height (m)	Table Angle (Degree)	Raw Value (dBuV)	Correction Factor (dB/m)
1	50.00	22.90 QP	40.00	-17.10	1.65 V	32	14.40	8.50
2	120.03	26.70 QP	43.50	-16.80	1.27 V	90	15.20	11.50
3	124.99	28.00 QP	43.50	-15.50	1.10 V	296	16.00	12.00
4	200.08	23.90 QP	43.50	-19.60	1.47 V	333	14.90	9.00
5	249.68	29.30 QP	46.00	-16.70	1.86 V	54	16.30	13.00
6	330.01	31.70 QP	46.00	-14.30	1.45 V	1	16.80	14.90
7	375.05	27.40 QP	46.00	-18.60	1.02 V	7	11.10	16.20
8	400.00	29.10 QP	46.00	-16.90	1.35 V	285	12.00	17.10
9	500.25	30.90 QP	46.00	-15.10	1.66 V	168	11.60	19.30
10	750.06	33.70 QP	46.00	-12.30	1.86 V	29	9.90	23.80

- REMARKS:**
1. Emission level(dBuV/m)=Raw Value(dBuV) + Correction Factor(dB)
 2. Correction Factor(dB/m) = Antenna Factor (dB/m) + Cable Factor (dB)
 3. The other emission levels were very low against the limit.
 4. Margin value = Emission level – Limit value.



EUT	Flanker Pro Dual Radio AP	MODEL	AP-AG-AT-02
MODE	Channel 11 (Antenna 4-Adapter 2)	FREQUENCY RANGE	Below 1000 MHz
INPUT POWER (SYSTEM)	120Vac, 60Hz	DETECTOR FUNCTION	Quasi-Peak
ENVIRONMENTAL CONDITIONS	29deg. C, 56%RH, 982 hPa	TESTED BY	Eric Lee

ANTENNA POLARITY & TEST DISTANCE: HORIZONTAL AT 3 M

No.	Freq. (MHz)	Emission Level (dBuV/m)	Limit (dBuV/m)	Margin (dB)	Antenna Height (m)	Table Angle (Degree)	Raw Value (dBuV)	Correction Factor (dB/m)
1	120.00	22.80 QP	43.50	-20.70	1.69 H	87	11.30	11.50
2	125.32	26.00 QP	43.50	-17.50	1.55 H	180	14.00	12.00
3	249.99	30.50 QP	46.00	-15.50	1.53 H	62	17.50	13.00
4	300.02	28.50 QP	46.00	-17.50	1.05 H	296	14.30	14.20
5	330.00	27.00 QP	46.00	-19.00	1.20 H	52	12.10	14.90
6	375.15	25.60 QP	46.00	-20.40	1.37 H	357	9.40	16.20
7	500.00	29.00 QP	46.00	-17.00	1.74 H	345	9.70	19.30
8	600.20	31.50 QP	46.00	-14.50	1.28 H	274	10.60	20.90
9	625.03	31.60 QP	46.00	-14.40	1.51 H	42	9.90	21.70
10	750.05	33.30 QP	46.00	-12.70	1.21 H	119	9.50	23.80

ANTENNA POLARITY & TEST DISTANCE: VERTICAL AT 3 M

No.	Freq. (MHz)	Emission Level (dBuV/m)	Limit (dBuV/m)	Margin (dB)	Antenna Height (m)	Table Angle (Degree)	Raw Value (dBuV)	Correction Factor (dB/m)
1	49.20	27.10 QP	40.00	-12.90	1.02 V	36	18.20	8.90
2	124.99	28.30 QP	43.50	-15.20	1.75 V	218	16.20	12.00
3	200.00	26.30 QP	43.50	-17.20	1.07 V	85	17.30	9.00
4	250.10	31.90 QP	46.00	-14.10	1.53 V	9	18.90	13.00
5	300.08	29.20 QP	46.00	-16.80	1.45 V	210	15.00	14.20
6	330.00	30.70 QP	46.00	-15.30	1.16 V	1	15.80	14.90
7	375.00	32.70 QP	46.00	-13.30	1.08 V	10	16.50	16.20
8	400.05	30.10 QP	46.00	-15.90	2.00 V	257	13.00	17.10
9	499.99	31.40 QP	46.00	-14.60	1.70 V	110	12.10	19.30
10	750.11	34.70 QP	46.00	-11.30	1.25 V	55	10.90	23.80

- REMARKS:**
1. Emission level(dBuV/m)=Raw Value(dBuV) + Correction Factor(dB)
 2. Correction Factor(dB/m) = Antenna Factor (dB/m) + Cable Factor (dB)
 3. The other emission levels were very low against the limit.
 4. Margin value = Emission level – Limit value.



EUT	Flanker Pro Dual Radio AP	MODEL	AP-AG-AT-02
MODE	Channel 11 (Antenna 4-POE)	FREQUENCY RANGE	Below 1000 MHz
INPUT POWER (SYSTEM)	120Vac, 60Hz	DETECTOR FUNCTION	Quasi-Peak
ENVIRONMENTAL CONDITIONS	29deg. C, 56%RH, 982 hPa	TESTED BY	Eric Lee

ANTENNA POLARITY & TEST DISTANCE: HORIZONTAL AT 3 M

No.	Freq. (MHz)	Emission Level (dBuV/m)	Limit (dBuV/m)	Margin (dB)	Antenna Height (m)	Table Angle (Degree)	Raw Value (dBuV)	Correction Factor (dB/m)
1	120.00	25.70 QP	43.50	-17.80	1.14 H	21	14.20	11.50
2	125.03	25.20 QP	43.50	-18.30	1.47 H	54	13.20	12.00
3	200.03	24.20 QP	43.50	-19.30	1.75 H	84	15.20	9.00
4	250.11	26.60 QP	46.00	-19.40	1.47 H	77	13.50	13.00
5	330.21	30.80 QP	46.00	-15.20	1.02 H	47	15.90	14.90
6	375.30	26.10 QP	46.00	-19.90	1.55 H	250	9.90	16.20
7	500.02	32.50 QP	46.00	-13.50	1.54 H	236	13.20	19.30
8	600.00	30.10 QP	46.00	-15.90	1.38 H	74	9.20	20.90
9	624.94	32.30 QP	46.00	-13.70	1.47 H	24	10.60	21.70
10	750.21	34.00 QP	46.00	-12.00	1.45 H	74	10.20	23.80

ANTENNA POLARITY & TEST DISTANCE: VERTICAL AT 3 M

No.	Freq. (MHz)	Emission Level (dBuV/m)	Limit (dBuV/m)	Margin (dB)	Antenna Height (m)	Table Angle (Degree)	Raw Value (dBuV)	Correction Factor (dB/m)
1	119.98	23.10 QP	43.50	-20.40	1.54 V	20	11.60	11.50
2	125.00	25.00 QP	43.50	-18.50	1.39 V	154	12.90	12.10
3	200.00	26.50 QP	43.50	-17.00	1.25 V	87	17.50	9.00
4	250.03	33.00 QP	46.00	-13.00	1.20 V	153	20.00	13.00
5	330.00	30.10 QP	46.00	-15.90	1.11 V	70	15.20	14.90
6	375.02	27.50 QP	46.00	-18.50	1.52 V	69	11.30	16.20
7	399.99	29.30 QP	46.00	-16.70	1.54 V	174	12.20	17.10
8	500.05	30.30 QP	46.00	-15.70	1.57 V	74	11.00	19.30
9	625.09	31.70 QP	46.00	-14.30	1.09 V	152	10.00	21.70
10	750.10	33.80 QP	46.00	-12.20	1.69 V	280	10.00	23.80

- REMARKS:**
1. Emission level(dBuV/m)=Raw Value(dBuV) + Correction Factor(dB)
 2. Correction Factor(dB/m) = Antenna Factor (dB/m) + Cable Factor (dB)
 3. The other emission levels were very low against the limit.
 4. Margin value = Emission level – Limit value.



EUT	Flanker Pro Dual Radio AP	MODEL	AP-AG-AT-02
MODE	Channel 11 (Antenna 5-Adapter 1)	FREQUENCY RANGE	Below 1000 MHz
INPUT POWER (SYSTEM)	120Vac, 60Hz	DETECTOR FUNCTION	Quasi-Peak
ENVIRONMENTAL CONDITIONS	29deg. C, 56%RH, 982 hPa	TESTED BY	Eric Lee

ANTENNA POLARITY & TEST DISTANCE: HORIZONTAL AT 3 M								
No.	Freq. (MHz)	Emission Level (dBuV/m)	Limit (dBuV/m)	Margin (dB)	Antenna Height (m)	Table Angle (Degree)	Raw Value (dBuV)	Correction Factor (dB/m)
2	120.20	21.40 QP	43.50	-22.10	1.54 H	241	9.90	11.50
3	125.30	28.90 QP	43.50	-14.60	1.11 H	75	16.90	12.00
4	250.19	29.40 QP	46.00	-16.60	1.37 H	80	16.30	13.00
5	300.21	27.70 QP	46.00	-18.30	1.45 H	231	13.50	14.20
6	330.21	28.40 QP	46.00	-17.60	1.20 H	202	13.50	14.90
7	375.25	27.00 QP	46.00	-19.00	1.75 H	32	10.80	16.20
8	400.07	27.10 QP	46.00	-18.90	1.35 H	326	10.00	17.10
9	500.22	29.20 QP	46.00	-16.80	1.02 H	45	9.90	19.30
10	750.00	35.20 QP	46.00	-10.80	1.52 H	102	11.40	23.80

ANTENNA POLARITY & TEST DISTANCE: VERTICAL AT 3 M								
No.	Freq. (MHz)	Emission Level (dBuV/m)	Limit (dBuV/m)	Margin (dB)	Antenna Height (m)	Table Angle (Degree)	Raw Value (dBuV)	Correction Factor (dB/m)
1	49.54	24.00 QP	40.00	-16.00	1.11 V	254	15.20	8.70
2	125.03	28.30 QP	43.50	-15.20	1.85 V	210	16.20	12.00
3	200.00	25.20 QP	43.50	-18.30	1.74 V	204	16.20	9.00
4	250.22	30.60 QP	46.00	-15.40	1.08 V	63	17.60	13.00
5	300.14	29.20 QP	46.00	-16.80	1.36 V	353	15.00	14.20
6	329.99	31.10 QP	46.00	-14.90	1.38 V	215	16.20	14.90
7	375.00	29.40 QP	46.00	-16.60	1.57 V	5	13.20	16.20
8	400.21	30.70 QP	46.00	-15.30	1.11 V	85	13.60	17.10
9	500.06	30.50 QP	46.00	-15.50	1.31 V	205	11.20	19.30
10	750.30	33.30 QP	46.00	-12.70	1.38 V	160	9.50	23.80

- REMARKS:**
1. Emission level(dBuV/m)=Raw Value(dBuV) + Correction Factor(dB)
 2. Correction Factor(dB/m) = Antenna Factor (dB/m) + Cable Factor (dB)
 3. The other emission levels were very low against the limit.
 4. Margin value = Emission level – Limit value.



EUT	Flanker Pro Dual Radio AP	MODEL	AP-AG-AT-02
MODE	Channel 11 (Antenna 5-Adapter 2)	FREQUENCY RANGE	Below 1000 MHz
INPUT POWER (SYSTEM)	120Vac, 60Hz	DETECTOR FUNCTION	Quasi-Peak
ENVIRONMENTAL CONDITIONS	29deg. C, 56%RH, 982 hPa	TESTED BY	Eric Lee

ANTENNA POLARITY & TEST DISTANCE: HORIZONTAL AT 3 M

No.	Freq. (MHz)	Emission Level (dBuV/m)	Limit (dBuV/m)	Margin (dB)	Antenna Height (m)	Table Angle (Degree)	Raw Value (dBuV)	Correction Factor (dB/m)
1	120.03	22.80 QP	43.50	-20.70	1.52 H	65	11.30	11.50
2	125.02	28.20 QP	43.50	-15.30	1.54 H	202	16.20	12.00
3	200.00	24.20 QP	43.50	-19.30	1.54 H	23	15.20	9.00
4	250.21	28.90 QP	46.00	-17.10	1.53 H	326	15.90	13.00
5	300.08	28.50 QP	46.00	-17.50	1.54 H	326	14.20	14.20
6	330.00	29.20 QP	46.00	-16.80	1.54 H	74	14.30	14.90
7	375.32	27.20 QP	46.00	-18.80	1.75 H	54	11.00	16.20
8	400.08	27.10 QP	46.00	-18.90	1.11 H	3	10.00	17.10
9	500.04	29.80 QP	46.00	-16.20	1.54 H	78	10.50	19.30
10	750.03	36.30 QP	46.00	-9.70	1.45 H	74	12.50	23.80

ANTENNA POLARITY & TEST DISTANCE: VERTICAL AT 3 M

No.	Freq. (MHz)	Emission Level (dBuV/m)	Limit (dBuV/m)	Margin (dB)	Antenna Height (m)	Table Angle (Degree)	Raw Value (dBuV)	Correction Factor (dB/m)
1	48.23	25.70 QP	40.00	-14.30	1.54 V	241	16.20	9.40
2	120.01	26.90 QP	43.50	-16.60	1.34 V	120	15.40	11.50
3	125.00	27.80 QP	43.50	-15.80	1.07 V	42	15.70	12.10
4	200.16	27.50 QP	43.50	-16.00	1.93 V	86	18.50	9.00
5	250.29	28.40 QP	46.00	-17.60	1.70 V	203	15.40	13.00
6	330.21	30.80 QP	46.00	-15.20	1.11 V	41	15.90	14.90
7	375.14	27.10 QP	46.00	-18.90	1.35 V	52	10.90	16.20
8	400.20	29.70 QP	46.00	-16.30	1.52 V	17	12.60	17.10
9	500.23	30.00 QP	46.00	-16.00	1.57 V	108	10.70	19.30
10	750.03	34.00 QP	46.00	-12.00	1.96 V	320	10.20	23.80

- REMARKS:**
1. Emission level(dBuV/m)=Raw Value(dBuV) + Correction Factor(dB)
 2. Correction Factor(dB/m) = Antenna Factor (dB/m) + Cable Factor (dB)
 3. The other emission levels were very low against the limit.
 4. Margin value = Emission level – Limit value.



EUT	Flanker Pro Dual Radio AP	MODEL	AP-AG-AT-02
MODE	Channel 11 (Antenna 5-POE)	FREQUENCY RANGE	Below 1000 MHz
INPUT POWER (SYSTEM)	120Vac, 60Hz	DETECTOR FUNCTION	Quasi-Peak
ENVIRONMENTAL CONDITIONS	29deg. C, 56%RH, 982 hPa	TESTED BY	Eric Lee

ANTENNA POLARITY & TEST DISTANCE: HORIZONTAL AT 3 M

No.	Freq. (MHz)	Emission Level (dBuV/m)	Limit (dBuV/m)	Margin (dB)	Antenna Height (m)	Table Angle (Degree)	Raw Value (dBuV)	Correction Factor (dB/m)
1	120.02	26.80 QP	43.50	-16.70	1.54 H	241	15.30	11.50
2	125.63	26.60 QP	43.50	-16.90	1.11 H	75	14.60	12.00
3	200.10	24.60 QP	43.50	-18.90	1.45 H	230	15.60	9.00
4	250.32	28.00 QP	46.00	-18.00	1.99 H	68	15.00	13.00
5	329.98	29.20 QP	46.00	-16.80	1.00 H	3	14.30	14.90
6	375.13	25.60 QP	46.00	-20.40	1.53 H	32	9.40	16.20
7	500.24	33.30 QP	46.00	-12.70	1.32 H	9	14.00	19.30
8	600.00	30.20 QP	46.00	-15.80	1.65 H	241	9.30	20.90
9	625.31	32.70 QP	46.00	-13.30	1.86 H	62	11.00	21.70
10	750.09	34.70 QP	46.00	-11.30	1.45 H	58	10.90	23.80

ANTENNA POLARITY & TEST DISTANCE: VERTICAL AT 3 M

No.	Freq. (MHz)	Emission Level (dBuV/m)	Limit (dBuV/m)	Margin (dB)	Antenna Height (m)	Table Angle (Degree)	Raw Value (dBuV)	Correction Factor (dB/m)
1	48.24	26.70 QP	40.00	-13.30	1.44 V	53	17.20	9.40
2	120.32	24.80 QP	43.50	-18.70	1.33 V	5	13.30	11.50
3	125.30	25.50 QP	43.50	-18.00	1.58 V	96	13.50	12.00
4	200.00	24.70 QP	43.50	-18.80	1.45 V	55	15.70	9.00
5	250.03	31.60 QP	46.00	-14.40	1.54 V	43	18.60	13.00
6	330.11	30.80 QP	46.00	-15.20	1.32 V	203	15.90	14.90
7	375.01	28.70 QP	46.00	-17.30	1.57 V	201	12.50	16.20
8	399.86	28.10 QP	46.00	-17.90	1.66 V	63	11.00	17.10
9	500.03	31.50 QP	46.00	-14.50	1.42 V	52	12.20	19.30
10	750.00	34.40 QP	46.00	-11.60	1.54 V	78	10.60	23.80

- REMARKS:**
1. Emission level(dBuV/m)=Raw Value(dBuV) + Correction Factor(dB)
 2. Correction Factor(dB/m) = Antenna Factor (dB/m) + Cable Factor (dB)
 3. The other emission levels were very low against the limit.
 4. Margin value = Emission level – Limit value.



EUT	Flanker Pro Dual Radio AP	MODEL	AP-AG-AT-02
MODE	Channel 11 (Antenna 6-Adapter 1)	FREQUENCY RANGE	Below 1000 MHz
INPUT POWER (SYSTEM)	120Vac, 60Hz	DETECTOR FUNCTION	Quasi-Peak
ENVIRONMENTAL CONDITIONS	29deg. C, 56%RH, 982 hPa	TESTED BY	Eric Lee

ANTENNA POLARITY & TEST DISTANCE: HORIZONTAL AT 3 M

No.	Freq. (MHz)	Emission Level (dBuV/m)	Limit (dBuV/m)	Margin (dB)	Antenna Height (m)	Table Angle (Degree)	Raw Value (dBuV)	Correction Factor (dB/m)
1	119.00	21.70 QP	43.50	-21.80	1.57 H	52	10.20	11.50
2	125.12	25.60 QP	43.50	-17.90	1.59 H	356	13.60	12.00
3	200.00	23.60 QP	43.50	-19.90	2.00 H	354	14.60	9.00
4	250.03	28.50 QP	46.00	-17.50	1.01 H	65	15.50	13.00
5	300.04	25.10 QP	46.00	-20.90	1.13 H	33	10.90	14.20
6	330.07	29.60 QP	46.00	-16.40	1.11 H	28	14.70	14.90
7	375.11	27.00 QP	46.00	-19.00	1.82 H	342	10.80	16.20
8	399.99	26.70 QP	46.00	-19.30	1.43 H	309	9.60	17.10
9	500.01	29.20 QP	46.00	-16.80	1.46 H	205	9.90	19.30
10	750.00	35.20 QP	46.00	-10.80	1.85 H	224	11.40	23.80

ANTENNA POLARITY & TEST DISTANCE: VERTICAL AT 3 M

No.	Freq. (MHz)	Emission Level (dBuV/m)	Limit (dBuV/m)	Margin (dB)	Antenna Height (m)	Table Angle (Degree)	Raw Value (dBuV)	Correction Factor (dB/m)
1	50.24	24.30 QP	40.00	-15.70	1.54 V	241	15.20	9.00
2	120.03	23.50 QP	43.50	-20.00	1.02 V	102	10.90	12.60
3	125.00	30.60 QP	43.50	-12.90	1.98 V	54	17.60	13.10
4	200.00	26.60 QP	43.50	-16.90	1.83 V	321	16.60	10.10
5	250.11	33.10 QP	46.00	-12.90	1.11 V	323	18.70	14.40
6	300.13	31.70 QP	46.00	-14.30	1.36 V	63	16.30	15.40
7	330.00	31.50 QP	46.00	-14.50	1.90 V	9	15.20	16.30
8	375.41	30.20 QP	46.00	-15.80	1.40 V	207	12.40	17.80
9	500.01	34.80 QP	46.00	-11.20	1.65 V	309	13.20	21.60
10	750.00	36.10 QP	46.00	-9.90	1.54 V	245	10.00	26.10

- REMARKS:**
1. Emission level(dBuV/m)=Raw Value(dBuV) + Correction Factor(dB)
 2. Correction Factor(dB/m) = Antenna Factor (dB/m) + Cable Factor (dB)
 3. The other emission levels were very low against the limit.
 4. Margin value = Emission level – Limit value.



EUT	Flanker Pro Dual Radio AP	MODEL	AP-AG-AT-02
MODE	Channel 11 (Antenna 6-Adapter 2)	FREQUENCY RANGE	Below 1000 MHz
INPUT POWER (SYSTEM)	120Vac, 60Hz	DETECTOR FUNCTION	Quasi-Peak
ENVIRONMENTAL CONDITIONS	29deg. C, 56%RH, 982 hPa	TESTED BY	Eric Lee

ANTENNA POLARITY & TEST DISTANCE: HORIZONTAL AT 3 M

No.	Freq. (MHz)	Emission Level (dBuV/m)	Limit (dBuV/m)	Margin (dB)	Antenna Height (m)	Table Angle (Degree)	Raw Value (dBuV)	Correction Factor (dB/m)
1	120.18	23.10 QP	43.50	-20.40	1.68 H	354	10.50	12.60
2	125.30	27.60 QP	43.50	-15.90	1.82 H	353	14.60	13.00
3	200.00	26.40 QP	43.50	-17.10	1.63 H	323	16.30	10.10
4	250.70	31.30 QP	46.00	-14.70	2.00 H	3	16.80	14.50
5	300.31	26.40 QP	46.00	-19.60	1.58 H	87	11.00	15.40
6	329.98	32.20 QP	46.00	-13.80	1.01 H	2	15.90	16.30
7	375.24	28.80 QP	46.00	-17.20	1.33 H	66	11.00	17.80
8	400.00	29.00 QP	46.00	-17.00	1.65 H	326	10.30	18.70
9	500.01	31.50 QP	46.00	-14.50	1.41 H	201	9.90	21.60
10	750.00	35.40 QP	46.00	-10.60	1.56 H	32	9.20	26.10

ANTENNA POLARITY & TEST DISTANCE: VERTICAL AT 3 M

No.	Freq. (MHz)	Emission Level (dBuV/m)	Limit (dBuV/m)	Margin (dB)	Antenna Height (m)	Table Angle (Degree)	Raw Value (dBuV)	Correction Factor (dB/m)
1	49.24	25.80 QP	40.00	-14.20	1.55 V	250	16.20	9.50
2	120.01	25.80 QP	43.50	-17.70	1.02 V	302	13.20	12.60
3	125.22	29.20 QP	43.50	-14.30	1.40 V	246	16.20	13.00
4	200.00	25.90 QP	43.50	-17.60	1.07 V	240	15.80	10.10
5	250.09	33.70 QP	46.00	-12.30	1.73 V	333	19.30	14.40
6	300.00	32.40 QP	46.00	-13.60	1.37 V	96	17.00	15.40
7	330.00	32.00 QP	46.00	-14.00	1.21 V	311	15.70	16.30
8	375.10	29.80 QP	46.00	-16.20	1.40 V	111	12.00	17.80
9	500.21	35.90 QP	46.00	-10.10	1.65 V	3	14.30	21.60
10	750.03	37.40 QP	46.00	-8.60	1.04 V	71	11.20	26.10

- REMARKS:**
1. Emission level(dBuV/m)=Raw Value(dBuV) + Correction Factor(dB)
 2. Correction Factor(dB/m) = Antenna Factor (dB/m) + Cable Factor (dB)
 3. The other emission levels were very low against the limit.
 4. Margin value = Emission level – Limit value.



EUT	Flanker Pro Dual Radio AP	MODEL	AP-AG-AT-02
MODE	Channel 11 (Antenna 6-POE)	FREQUENCY RANGE	Below 1000 MHz
INPUT POWER (SYSTEM)	120Vac, 60Hz	DETECTOR FUNCTION	Quasi-Peak
ENVIRONMENTAL CONDITIONS	29deg. C, 56%RH, 982 hPa	TESTED BY	Eric Lee

ANTENNA POLARITY & TEST DISTANCE: HORIZONTAL AT 3 M

No.	Freq. (MHz)	Emission Level (dBuV/m)	Limit (dBuV/m)	Margin (dB)	Antenna Height (m)	Table Angle (Degree)	Raw Value (dBuV)	Correction Factor (dB/m)
1	120.02	22.80 QP	43.50	-20.70	1.54 H	24	10.20	12.60
2	125.03	25.10 QP	43.50	-18.40	1.47 H	59	12.00	13.10
3	200.00	23.30 QP	43.50	-20.20	1.87 H	47	13.20	10.10
4	250.32	30.70 QP	46.00	-15.30	1.06 H	98	16.30	14.40
5	299.99	26.20 QP	46.00	-19.80	1.40 H	256	10.80	15.40
6	330.00	29.50 QP	46.00	-16.50	1.58 H	78	13.20	16.30
7	375.31	27.00 QP	46.00	-19.00	1.20 H	201	9.20	17.80
8	400.32	28.90 QP	46.00	-17.10	1.98 H	353	10.20	18.70
9	500.24	31.90 QP	46.00	-14.10	1.33 H	62	10.30	21.60
10	750.00	36.90 QP	46.00	-9.10	1.53 H	333	10.80	26.10

ANTENNA POLARITY & TEST DISTANCE: VERTICAL AT 3 M

No.	Freq. (MHz)	Emission Level (dBuV/m)	Limit (dBuV/m)	Margin (dB)	Antenna Height (m)	Table Angle (Degree)	Raw Value (dBuV)	Correction Factor (dB/m)
1	48.37	26.20 QP	40.00	-13.80	1.82 V	47	16.20	9.90
2	120.01	23.80 QP	43.50	-19.70	1.53 V	69	11.20	12.60
3	125.00	27.30 QP	43.50	-16.20	1.58 V	88	14.30	13.10
4	200.04	26.40 QP	43.50	-17.10	1.63 V	333	16.40	10.10
5	250.00	32.90 QP	46.00	-13.10	1.00 V	356	18.50	14.40
6	300.09	30.70 QP	46.00	-15.30	1.07 V	2	15.30	15.40
7	330.15	30.60 QP	46.00	-15.40	1.53 V	62	14.30	16.30
8	375.36	31.50 QP	46.00	-14.50	1.75 V	249	13.70	17.80
9	500.11	36.20 QP	46.00	-9.80	1.63 V	65	14.60	21.60
10	750.01	37.40 QP	46.00	-8.60	1.53 V	62	11.20	26.10

- REMARKS:**
1. Emission level(dBuV/m)=Raw Value(dBuV) + Correction Factor(dB)
 2. Correction Factor(dB/m) = Antenna Factor (dB/m) + Cable Factor (dB)
 3. The other emission levels were very low against the limit.
 4. Margin value = Emission level – Limit value.



EUT	Flanker Pro Dual Radio AP	MODEL	AP-AG-AT-02
MODE	Channel 11 (Antenna 7-Adapter 1)	FREQUENCY RANGE	Below 1000 MHz
INPUT POWER (SYSTEM)	120Vac, 60Hz	DETECTOR FUNCTION	Quasi-Peak
ENVIRONMENTAL CONDITIONS	29deg. C, 56%RH, 982 hPa	TESTED BY	Eric Lee

ANTENNA POLARITY & TEST DISTANCE: HORIZONTAL AT 3 M

No.	Freq. (MHz)	Emission Level (dBuV/m)	Limit (dBuV/m)	Margin (dB)	Antenna Height (m)	Table Angle (Degree)	Raw Value (dBuV)	Correction Factor (dB/m)
1	120.01	21.20 QP	43.50	-22.30	1.47 H	54	8.70	12.60
2	125.01	26.30 QP	43.50	-17.20	1.87 H	3	13.30	13.10
3	200.00	25.10 QP	43.50	-18.40	1.40 H	219	15.00	10.10
4	250.11	30.00 QP	46.00	-16.00	1.30 H	9	15.60	14.40
5	300.04	29.80 QP	46.00	-16.20	1.05 H	329	14.40	15.40
6	330.00	29.60 QP	46.00	-16.40	1.32 H	63	13.40	16.30
7	375.13	26.20 QP	46.00	-19.80	2.00 H	326	8.40	17.80
8	499.99	33.70 QP	46.00	-12.30	1.45 H	62	12.00	21.60
9	625.01	33.20 QP	46.00	-12.80	1.56 H	3	9.50	23.80
10	749.99	37.50 QP	46.00	-8.50	1.15 H	62	11.40	26.10

ANTENNA POLARITY & TEST DISTANCE: VERTICAL AT 3 M

No.	Freq. (MHz)	Emission Level (dBuV/m)	Limit (dBuV/m)	Margin (dB)	Antenna Height (m)	Table Angle (Degree)	Raw Value (dBuV)	Correction Factor (dB/m)
1	48.85	23.20 QP	40.00	-16.80	1.26 V	95	13.50	9.70
2	120.00	26.00 QP	43.50	-17.50	1.25 V	130	13.50	12.60
3	124.99	30.50 QP	43.50	-13.00	1.00 V	301	17.50	13.10
4	200.00	24.20 QP	43.50	-19.30	1.16 V	103	14.10	10.10
5	250.02	33.10 QP	46.00	-12.90	1.00 V	188	18.70	14.40
6	300.02	26.80 QP	46.00	-19.20	1.36 V	118	11.40	15.40
7	330.00	33.20 QP	46.00	-12.80	1.30 V	80	16.90	16.30
8	375.06	32.10 QP	46.00	-13.90	1.63 V	318	14.40	17.80
9	500.03	32.90 QP	46.00	-13.10	1.26 V	302	11.20	21.60
10	750.03	36.90 QP	46.00	-9.10	1.01 V	78	10.70	26.10

- REMARKS:**
1. Emission level(dBuV/m)=Raw Value(dBuV) + Correction Factor(dB)
 2. Correction Factor(dB/m) = Antenna Factor (dB/m) + Cable Factor (dB)
 3. The other emission levels were very low against the limit.
 4. Margin value = Emission level – Limit value.



EUT	Flanker Pro Dual Radio AP	MODEL	AP-AG-AT-02
MODE	Channel 11 (Antenna 7-Adapter 2)	FREQUENCY RANGE	Below 1000 MHz
INPUT POWER (SYSTEM)	120Vac, 60Hz	DETECTOR FUNCTION	Quasi-Peak
ENVIRONMENTAL CONDITIONS	29deg. C, 56%RH, 982 hPa	TESTED BY	Eric Lee

ANTENNA POLARITY & TEST DISTANCE: HORIZONTAL AT 3 M

No.	Freq. (MHz)	Emission Level (dBuV/m)	Limit (dBuV/m)	Margin (dB)	Antenna Height (m)	Table Angle (Degree)	Raw Value (dBuV)	Correction Factor (dB/m)
1	119.99	22.20 QP	43.50	-21.30	1.32 H	356	9.70	12.60
2	125.01	26.30 QP	43.50	-17.20	1.87 H	3	13.30	13.10
3	200.00	25.10 QP	43.50	-18.40	1.40 H	219	15.00	10.10
4	250.01	29.70 QP	46.00	-16.30	1.20 H	321	15.30	14.40
5	300.00	28.30 QP	46.00	-17.70	1.60 H	359	12.90	15.40
6	330.11	30.30 QP	46.00	-15.70	1.72 H	353	14.00	16.30
7	375.01	27.10 QP	46.00	-18.90	1.09 H	111	9.30	17.80
8	500.02	34.00 QP	46.00	-12.00	1.00 H	75	12.40	21.60
9	625.00	32.90 QP	46.00	-13.10	1.28 H	40	9.10	23.80
10	750.03	38.20 QP	46.00	-7.80	1.04 H	34	12.10	26.10

ANTENNA POLARITY & TEST DISTANCE: VERTICAL AT 3 M

No.	Freq. (MHz)	Emission Level (dBuV/m)	Limit (dBuV/m)	Margin (dB)	Antenna Height (m)	Table Angle (Degree)	Raw Value (dBuV)	Correction Factor (dB/m)
1	50.00	26.60 QP	40.00	-13.40	1.65 V	9	17.40	9.10
2	119.99	25.90 QP	43.50	-17.60	1.37 V	63	13.30	12.60
3	125.01	31.00 QP	43.50	-12.50	1.01 V	309	18.00	13.10
4	200.01	25.00 QP	43.50	-18.50	1.24 V	296	14.90	10.10
5	250.43	35.00 QP	46.00	-11.00	1.54 V	2	20.50	14.40
6	300.02	27.00 QP	46.00	-19.00	1.36 V	118	11.60	15.40
7	330.01	34.50 QP	46.00	-11.50	1.02 V	4	18.20	16.30
8	375.01	33.00 QP	46.00	-13.00	1.54 V	246	15.20	17.80
9	500.03	33.00 QP	46.00	-13.00	1.26 V	333	11.40	21.60
10	750.03	35.20 QP	46.00	-10.80	1.09 V	326	9.10	26.10

- REMARKS:**
1. Emission level(dBuV/m)=Raw Value(dBuV) + Correction Factor(dB)
 2. Correction Factor(dB/m) = Antenna Factor (dB/m) + Cable Factor (dB)
 3. The other emission levels were very low against the limit.
 4. Margin value = Emission level – Limit value.



EUT	Flanker Pro Dual Radio AP	MODEL	AP-AG-AT-02
MODE	Channel 11 (Antenna 7-POE)	FREQUENCY RANGE	Below 1000 MHz
INPUT POWER (SYSTEM)	120Vac, 60Hz	DETECTOR FUNCTION	Quasi-Peak
ENVIRONMENTAL CONDITIONS	29deg. C, 56%RH, 982 hPa	TESTED BY	Eric Lee

ANTENNA POLARITY & TEST DISTANCE: HORIZONTAL AT 3 M

No.	Freq. (MHz)	Emission Level (dBuV/m)	Limit (dBuV/m)	Margin (dB)	Antenna Height (m)	Table Angle (Degree)	Raw Value (dBuV)	Correction Factor (dB/m)
1	120.00	21.90 QP	43.50	-21.60	1.25 H	23	9.30	12.60
2	125.00	27.00 QP	43.50	-16.50	1.17 H	307	14.00	13.10
3	200.01	25.20 QP	43.50	-18.30	1.36 H	275	15.20	10.10
4	250.02	30.90 QP	46.00	-15.10	1.15 H	29	16.50	14.40
5	300.01	27.50 QP	46.00	-18.50	1.57 H	2	12.10	15.40
6	330.00	29.90 QP	46.00	-16.10	1.69 H	53	13.60	16.30
7	375.14	28.10 QP	46.00	-17.90	1.03 H	169	10.30	17.80
8	500.02	36.70 QP	46.00	-9.30	1.00 H	75	15.00	21.60
9	625.00	32.90 QP	46.00	-13.10	1.28 H	40	9.10	23.80
10	750.03	38.20 QP	46.00	-7.80	1.04 H	34	12.10	26.10

ANTENNA POLARITY & TEST DISTANCE: VERTICAL AT 3 M

No.	Freq. (MHz)	Emission Level (dBuV/m)	Limit (dBuV/m)	Margin (dB)	Antenna Height (m)	Table Angle (Degree)	Raw Value (dBuV)	Correction Factor (dB/m)
1	48.25	23.20 QP	40.00	-16.80	1.02 V	1	13.20	10.00
2	120.02	27.80 QP	43.50	-15.70	1.10 V	1	15.20	12.60
3	125.02	30.20 QP	43.50	-13.30	1.00 V	331	17.10	13.10
4	200.00	24.30 QP	43.50	-19.20	1.10 V	10	14.20	10.10
5	250.20	31.60 QP	46.00	-14.40	1.53 V	62	17.20	14.40
6	300.10	26.30 QP	46.00	-19.70	1.11 V	42	10.90	15.40
7	330.00	31.60 QP	46.00	-14.40	1.87 V	96	15.30	16.30
8	375.24	31.90 QP	46.00	-14.10	1.07 V	42	14.10	17.80
9	500.00	34.00 QP	46.00	-12.00	1.25 V	4	12.30	21.60
10	750.04	36.90 QP	46.00	-9.10	1.11 V	5	10.80	26.10

- REMARKS:**
1. Emission level(dBuV/m)=Raw Value(dBuV) + Correction Factor(dB)
 2. Correction Factor(dB/m) = Antenna Factor (dB/m) + Cable Factor (dB)
 3. The other emission levels were very low against the limit.
 4. Margin value = Emission level – Limit value.



For 3 Ethernet ports

EUT	Flanker Pro Dual Radio AP	MODEL	AP-AG-AT-02
MODE	Channel 11 (Antenna 1-Adapter 1)	FREQUENCY RANGE	Below 1000 MHz
INPUT POWER (SYSTEM)	120Vac, 60Hz	DETECTOR FUNCTION	Quasi-Peak
ENVIRONMENTAL CONDITIONS	29deg. C, 56%RH, 982 hPa	TESTED BY	Eric Lee

ANTENNA POLARITY & TEST DISTANCE: HORIZONTAL AT 3 M								
No.	Freq. (MHz)	Emission Level (dBuV/m)	Limit (dBuV/m)	Margin (dB)	Antenna Height (m)	Table Angle (Degree)	Raw Value (dBuV)	Correction Factor (dB/m)
2	120.20	21.40 QP	43.50	-22.10	1.54 H	241	9.90	11.50
3	125.30	28.90 QP	43.50	-14.60	1.11 H	75	16.90	12.00
4	250.19	29.40 QP	46.00	-16.60	1.37 H	80	16.30	13.00
5	300.21	27.70 QP	46.00	-18.30	1.45 H	231	13.50	14.20
6	330.21	28.40 QP	46.00	-17.60	1.20 H	202	13.50	14.90
7	375.25	27.00 QP	46.00	-19.00	1.75 H	32	10.80	16.20
8	400.07	27.10 QP	46.00	-18.90	1.35 H	326	10.00	17.10
9	500.22	29.20 QP	46.00	-16.80	1.02 H	45	9.90	19.30
10	750.00	35.20 QP	46.00	-10.80	1.52 H	102	11.40	23.80

ANTENNA POLARITY & TEST DISTANCE: VERTICAL AT 3 M								
No.	Freq. (MHz)	Emission Level (dBuV/m)	Limit (dBuV/m)	Margin (dB)	Antenna Height (m)	Table Angle (Degree)	Raw Value (dBuV)	Correction Factor (dB/m)
1	49.54	24.00 QP	40.00	-16.00	1.11 V	254	15.20	8.70
2	125.03	28.30 QP	43.50	-15.20	1.85 V	210	16.20	12.00
3	200.00	25.20 QP	43.50	-18.30	1.74 V	204	16.20	9.00
4	250.22	30.60 QP	46.00	-15.40	1.08 V	63	17.60	13.00
5	300.14	29.20 QP	46.00	-16.80	1.36 V	353	15.00	14.20
6	329.99	31.10 QP	46.00	-14.90	1.38 V	215	16.20	14.90
7	375.00	29.40 QP	46.00	-16.60	1.57 V	5	13.20	16.20
8	400.21	30.70 QP	46.00	-15.30	1.11 V	85	13.60	17.10
9	500.06	30.50 QP	46.00	-15.50	1.31 V	205	11.20	19.30
10	750.30	33.30 QP	46.00	-12.70	1.38 V	160	9.50	23.80

- REMARKS:**
1. Emission level(dBuV/m)=Raw Value(dBuV) + Correction Factor(dB)
 2. Correction Factor(dB/m) = Antenna Factor (dB/m) + Cable Factor (dB)
 3. The other emission levels were very low against the limit.
 4. Margin value = Emission level – Limit value.



EUT	Flanker Pro Dual Radio AP	MODEL	AP-AG-AT-02
MODE	Channel 11 (Antenna 1-Adapter 2)	FREQUENCY RANGE	Below 1000 MHz
INPUT POWER (SYSTEM)	120Vac, 60Hz	DETECTOR FUNCTION	Quasi-Peak
ENVIRONMENTAL CONDITIONS	29deg. C, 56%RH, 982 hPa	TESTED BY	Eric Lee

ANTENNA POLARITY & TEST DISTANCE: HORIZONTAL AT 3 M

No.	Freq. (MHz)	Emission Level (dBuV/m)	Limit (dBuV/m)	Margin (dB)	Antenna Height (m)	Table Angle (Degree)	Raw Value (dBuV)	Correction Factor (dB/m)
1	120.03	22.80 QP	43.50	-20.70	1.52 H	65	11.30	11.50
2	125.02	28.20 QP	43.50	-15.30	1.54 H	202	16.20	12.00
3	200.00	24.20 QP	43.50	-19.30	1.54 H	23	15.20	9.00
4	250.21	28.90 QP	46.00	-17.10	1.53 H	326	15.90	13.00
5	300.08	28.50 QP	46.00	-17.50	1.54 H	326	14.20	14.20
6	330.00	29.20 QP	46.00	-16.80	1.54 H	74	14.30	14.90
7	375.32	27.20 QP	46.00	-18.80	1.75 H	54	11.00	16.20
8	400.08	27.10 QP	46.00	-18.90	1.11 H	3	10.00	17.10
9	500.04	29.80 QP	46.00	-16.20	1.54 H	78	10.50	19.30
10	750.03	36.30 QP	46.00	-9.70	1.45 H	74	12.50	23.80

ANTENNA POLARITY & TEST DISTANCE: VERTICAL AT 3 M

No.	Freq. (MHz)	Emission Level (dBuV/m)	Limit (dBuV/m)	Margin (dB)	Antenna Height (m)	Table Angle (Degree)	Raw Value (dBuV)	Correction Factor (dB/m)
1	48.23	25.70 QP	40.00	-14.30	1.54 V	241	16.20	9.40
2	120.01	26.90 QP	43.50	-16.60	1.34 V	120	15.40	11.50
3	125.00	27.80 QP	43.50	-15.80	1.07 V	42	15.70	12.10
4	200.16	27.50 QP	43.50	-16.00	1.93 V	86	18.50	9.00
5	250.29	28.40 QP	46.00	-17.60	1.70 V	203	15.40	13.00
6	330.21	30.80 QP	46.00	-15.20	1.11 V	41	15.90	14.90
7	375.14	27.10 QP	46.00	-18.90	1.35 V	52	10.90	16.20
8	400.20	29.70 QP	46.00	-16.30	1.52 V	17	12.60	17.10
9	500.23	30.00 QP	46.00	-16.00	1.57 V	108	10.70	19.30
10	750.03	34.00 QP	46.00	-12.00	1.96 V	320	10.20	23.80

- REMARKS:**
1. Emission level(dBuV/m)=Raw Value(dBuV) + Correction Factor(dB)
 2. Correction Factor(dB/m) = Antenna Factor (dB/m) + Cable Factor (dB)
 3. The other emission levels were very low against the limit.
 4. Margin value = Emission level – Limit value.



EUT	Flanker Pro Dual Radio AP	MODEL	AP-AG-AT-02
MODE	Channel 11 (Antenna 1-POE)	FREQUENCY RANGE	Below 1000 MHz
INPUT POWER (SYSTEM)	120Vac, 60Hz	DETECTOR FUNCTION	Quasi-Peak
ENVIRONMENTAL CONDITIONS	29deg. C, 56%RH, 982 hPa	TESTED BY	Eric Lee

ANTENNA POLARITY & TEST DISTANCE: HORIZONTAL AT 3 M

No.	Freq. (MHz)	Emission Level (dBuV/m)	Limit (dBuV/m)	Margin (dB)	Antenna Height (m)	Table Angle (Degree)	Raw Value (dBuV)	Correction Factor (dB/m)
1	120.02	26.80 QP	43.50	-16.70	1.54 H	241	15.30	11.50
2	125.63	26.60 QP	43.50	-16.90	1.11 H	75	14.60	12.00
3	200.10	24.60 QP	43.50	-18.90	1.45 H	230	15.60	9.00
4	250.32	28.00 QP	46.00	-18.00	1.99 H	68	15.00	13.00
5	329.98	29.20 QP	46.00	-16.80	1.00 H	3	14.30	14.90
6	375.13	25.60 QP	46.00	-20.40	1.53 H	32	9.40	16.20
7	500.24	33.30 QP	46.00	-12.70	1.32 H	9	14.00	19.30
8	600.00	30.20 QP	46.00	-15.80	1.65 H	241	9.30	20.90
9	625.31	32.70 QP	46.00	-13.30	1.86 H	62	11.00	21.70
10	750.09	34.70 QP	46.00	-11.30	1.45 H	58	10.90	23.80

ANTENNA POLARITY & TEST DISTANCE: VERTICAL AT 3 M

No.	Freq. (MHz)	Emission Level (dBuV/m)	Limit (dBuV/m)	Margin (dB)	Antenna Height (m)	Table Angle (Degree)	Raw Value (dBuV)	Correction Factor (dB/m)
1	48.24	26.70 QP	40.00	-13.30	1.44 V	53	17.20	9.40
2	120.32	24.80 QP	43.50	-18.70	1.33 V	5	13.30	11.50
3	125.30	25.50 QP	43.50	-18.00	1.58 V	96	13.50	12.00
4	200.00	24.70 QP	43.50	-18.80	1.45 V	55	15.70	9.00
5	250.03	31.60 QP	46.00	-14.40	1.54 V	43	18.60	13.00
6	330.11	30.80 QP	46.00	-15.20	1.32 V	203	15.90	14.90
7	375.01	28.70 QP	46.00	-17.30	1.57 V	201	12.50	16.20
8	399.86	28.10 QP	46.00	-17.90	1.66 V	63	11.00	17.10
9	500.03	31.50 QP	46.00	-14.50	1.42 V	52	12.20	19.30
10	750.00	34.40 QP	46.00	-11.60	1.54 V	78	10.60	23.80

- REMARKS:**
1. Emission level(dBuV/m)=Raw Value(dBuV) + Correction Factor(dB)
 2. Correction Factor(dB/m) = Antenna Factor (dB/m) + Cable Factor (dB)
 3. The other emission levels were very low against the limit.
 4. Margin value = Emission level – Limit value.



EUT	Flanker Pro Dual Radio AP	MODEL	AP-AG-AT-02
MODE	Channel 11 (Antenna 2-Adapter 1)	FREQUENCY RANGE	Below 1000 MHz
INPUT POWER (SYSTEM)	120Vac, 60Hz	DETECTOR FUNCTION	Quasi-Peak
ENVIRONMENTAL CONDITIONS	29deg. C, 56%RH, 982 hPa	TESTED BY	Eric Lee

ANTENNA POLARITY & TEST DISTANCE: HORIZONTAL AT 3 M

No.	Freq. (MHz)	Emission Level (dBuV/m)	Limit (dBuV/m)	Margin (dB)	Antenna Height (m)	Table Angle (Degree)	Raw Value (dBuV)	Correction Factor (dB/m)
1	119.81	22.00 QP	43.50	-21.50	1.50 H	350	10.50	11.50
2	125.34	28.30 QP	43.50	-15.20	1.02 H	78	16.30	12.00
3	200.36	23.20 QP	43.50	-20.30	1.02 H	321	14.20	9.00
4	250.21	29.90 QP	46.00	-16.10	1.24 H	78	16.90	13.00
5	300.20	27.10 QP	46.00	-18.90	1.57 H	78	12.90	14.20
6	330.03	28.50 QP	46.00	-17.50	1.25 H	52	13.60	14.90
7	375.03	27.20 QP	46.00	-18.80	1.53 H	26	11.00	16.20
8	400.10	27.10 QP	46.00	-18.90	1.00 H	93	10.00	17.10
9	500.24	29.30 QP	46.00	-16.70	1.47 H	78	10.00	19.30
10	750.02	36.30 QP	46.00	-9.70	1.28 H	60	12.50	23.80

ANTENNA POLARITY & TEST DISTANCE: VERTICAL AT 3 M

No.	Freq. (MHz)	Emission Level (dBuV/m)	Limit (dBuV/m)	Margin (dB)	Antenna Height (m)	Table Angle (Degree)	Raw Value (dBuV)	Correction Factor (dB/m)
1	48.20	24.80 QP	40.00	-15.20	1.54 V	24	15.30	9.40
2	120.01	26.70 QP	43.50	-16.80	1.53 V	69	15.20	11.50
3	125.30	27.00 QP	43.50	-16.50	1.11 V	74	15.00	12.00
4	200.13	25.30 QP	43.50	-18.20	1.08 V	356	16.30	9.00
5	250.41	31.10 QP	46.00	-14.90	1.01 V	225	18.00	13.10
6	330.00	31.80 QP	46.00	-14.20	2.00 V	5	16.90	14.90
7	375.61	27.10 QP	46.00	-18.90	1.82 V	246	10.90	16.20
8	400.35	29.00 QP	46.00	-17.00	1.52 V	333	11.90	17.10
9	500.53	30.30 QP	46.00	-15.70	1.35 V	69	11.00	19.30
10	750.03	35.80 QP	46.00	-10.20	1.49 V	335	12.00	23.80

- REMARKS:**
1. Emission level(dBuV/m)=Raw Value(dBuV) + Correction Factor(dB)
 2. Correction Factor(dB/m) = Antenna Factor (dB/m) + Cable Factor (dB)
 3. The other emission levels were very low against the limit.
 4. Margin value = Emission level – Limit value.



EUT	Flanker Pro Dual Radio AP	MODEL	AP-AG-AT-02
MODE	Channel 11 (Antenna 2-Adapter 2)	FREQUENCY RANGE	Below 1000 MHz
INPUT POWER (SYSTEM)	120Vac, 60Hz	DETECTOR FUNCTION	Quasi-Peak
ENVIRONMENTAL CONDITIONS	29deg. C, 56%RH, 982 hPa	TESTED BY	Eric Lee

ANTENNA POLARITY & TEST DISTANCE: HORIZONTAL AT 3 M

No.	Freq. (MHz)	Emission Level (dBuV/m)	Limit (dBuV/m)	Margin (dB)	Antenna Height (m)	Table Angle (Degree)	Raw Value (dBuV)	Correction Factor (dB/m)
1	119.89	22.50 QP	43.50	-21.00	1.59 H	265	11.00	11.50
2	125.33	29.00 QP	43.50	-14.50	1.02 H	36	17.00	12.00
3	200.00	23.50 QP	43.50	-20.00	1.24 H	75	14.50	9.00
4	250.04	29.30 QP	46.00	-16.70	1.28 H	1	16.30	13.00
5	300.10	27.60 QP	46.00	-18.40	1.43 H	62	13.40	14.20
6	330.00	29.20 QP	46.00	-16.80	1.72 H	40	14.30	14.90
7	375.21	26.20 QP	46.00	-19.80	1.11 H	75	10.00	16.20
8	400.18	26.60 QP	46.00	-19.40	1.24 H	78	9.50	17.10
9	500.09	30.30 QP	46.00	-15.70	1.50 H	323	11.00	19.30
10	750.06	36.00 QP	46.00	-10.00	1.04 H	26	12.20	23.80

ANTENNA POLARITY & TEST DISTANCE: VERTICAL AT 3 M

No.	Freq. (MHz)	Emission Level (dBuV/m)	Limit (dBuV/m)	Margin (dB)	Antenna Height (m)	Table Angle (Degree)	Raw Value (dBuV)	Correction Factor (dB/m)
1	119.86	26.00 QP	43.50	-17.50	1.52 V	96	14.50	11.50
2	125.11	26.40 QP	43.50	-17.10	1.02 V	36	14.30	12.00
3	250.00	25.60 QP	46.00	-20.40	1.67 V	326	12.60	13.00
4	250.30	29.30 QP	46.00	-16.70	1.50 V	32	16.30	13.00
5	299.99	27.50 QP	46.00	-18.50	1.37 V	82	13.30	14.20
6	330.00	32.00 QP	46.00	-14.00	1.30 V	1	17.10	14.90
7	375.46	27.90 QP	46.00	-18.10	1.52 V	326	11.70	16.20
8	400.62	27.20 QP	46.00	-18.80	1.68 V	96	10.10	17.10
9	500.09	31.00 QP	46.00	-15.00	1.82 V	55	11.70	19.30
10	750.00	35.00 QP	46.00	-11.00	1.54 V	45	11.20	23.80

- REMARKS:**
1. Emission level(dBuV/m)=Raw Value(dBuV) + Correction Factor(dB)
 2. Correction Factor(dB/m) = Antenna Factor (dB/m) + Cable Factor (dB)
 3. The other emission levels were very low against the limit.
 4. Margin value = Emission level – Limit value.



EUT	Flanker Pro Dual Radio AP	MODEL	AP-AG-AT-02
MODE	Channel 11 (Antenna 2-POE)	FREQUENCY RANGE	Below 1000 MHz
INPUT POWER (SYSTEM)	120Vac, 60Hz	DETECTOR FUNCTION	Quasi-Peak
ENVIRONMENTAL CONDITIONS	29deg. C, 56%RH, 982 hPa	TESTED BY	Eric Lee

ANTENNA POLARITY & TEST DISTANCE: HORIZONTAL AT 3 M

No.	Freq. (MHz)	Emission Level (dBuV/m)	Limit (dBuV/m)	Margin (dB)	Antenna Height (m)	Table Angle (Degree)	Raw Value (dBuV)	Correction Factor (dB/m)
1	120.02	24.70 QP	43.50	-18.80	1.75 H	82	13.20	11.50
2	125.10	26.20 QP	43.50	-17.30	1.06 H	63	14.20	12.00
3	200.23	18.30 QP	43.50	-25.20	1.22 H	53	9.30	9.00
4	250.00	27.10 QP	46.00	-18.90	1.82 H	194	14.10	13.00
5	330.01	29.90 QP	46.00	-16.10	1.29 H	1	15.00	14.90
6	375.04	19.80 QP	46.00	-26.20	1.04 H	58	3.60	16.20
7	500.21	32.90 QP	46.00	-13.10	1.28 H	352	13.60	19.30
8	600.12	29.50 QP	46.00	-16.50	1.47 H	78	8.60	20.90
9	624.99	32.30 QP	46.00	-13.70	1.43 H	6	10.60	21.70
10	750.10	34.10 QP	46.00	-11.90	1.52 H	47	10.30	23.80

ANTENNA POLARITY & TEST DISTANCE: VERTICAL AT 3 M

No.	Freq. (MHz)	Emission Level (dBuV/m)	Limit (dBuV/m)	Margin (dB)	Antenna Height (m)	Table Angle (Degree)	Raw Value (dBuV)	Correction Factor (dB/m)
1	49.50	27.40 QP	40.00	-12.60	1.64 V	72	18.60	8.80
2	120.22	25.50 QP	43.50	-18.00	1.34 V	58	14.00	11.50
3	124.81	24.20 QP	43.50	-19.30	1.56 V	9	12.10	12.00
4	199.99	23.30 QP	43.50	-20.20	1.86 V	250	14.30	9.00
5	250.02	31.00 QP	46.00	-15.00	1.29 V	45	18.00	13.00
6	330.01	29.60 QP	46.00	-16.40	1.62 V	11	14.70	14.90
7	375.02	27.30 QP	46.00	-18.70	1.14 V	50	11.10	16.20
8	399.96	27.50 QP	46.00	-18.50	1.41 V	1	10.40	17.10
9	500.03	32.60 QP	46.00	-13.40	1.61 V	52	13.30	19.30
10	699.75	32.90 QP	46.00	-13.10	1.20 V	79	10.50	22.40

- REMARKS:**
1. Emission level(dBuV/m)=Raw Value(dBuV) + Correction Factor(dB)
 2. Correction Factor(dB/m) = Antenna Factor (dB/m) + Cable Factor (dB)
 3. The other emission levels were very low against the limit.
 4. Margin value = Emission level – Limit value.



EUT	Flanker Pro Dual Radio AP	MODEL	AP-AG-AT-02
MODE	Channel 11 (Antenna 3-Adapter 1)	FREQUENCY RANGE	Below 1000 MHz
INPUT POWER (SYSTEM)	120Vac, 60Hz	DETECTOR FUNCTION	Quasi-Peak
ENVIRONMENTAL CONDITIONS	29deg. C, 56%RH, 982 hPa	TESTED BY	Eric Lee

ANTENNA POLARITY & TEST DISTANCE: HORIZONTAL AT 3 M

No.	Freq. (MHz)	Emission Level (dBuV/m)	Limit (dBuV/m)	Margin (dB)	Antenna Height (m)	Table Angle (Degree)	Raw Value (dBuV)	Correction Factor (dB/m)
1	120.23	27.10 QP	43.50	-16.40	1.27 H	25	15.60	11.50
2	125.01	28.30 QP	43.50	-15.20	2.36 H	254	16.30	12.00
3	200.73	24.30 QP	43.50	-19.20	1.20 H	236	15.30	9.00
4	250.01	29.60 QP	46.00	-16.40	1.36 H	256	16.60	13.00
5	300.10	29.30 QP	46.00	-16.70	1.47 H	20	15.10	14.20
6	330.12	32.30 QP	46.00	-13.70	1.02 H	236	17.40	14.90
7	375.00	28.30 QP	46.00	-17.70	1.42 H	234	12.10	16.20
8	399.99	31.90 QP	46.00	-14.10	1.02 H	236	14.80	17.10
9	500.02	34.10 QP	46.00	-11.90	1.78 H	360	14.80	19.30
10	750.43	43.00 QP	46.00	-3.00	1.27 H	256	19.20	23.80

ANTENNA POLARITY & TEST DISTANCE: VERTICAL AT 3 M

No.	Freq. (MHz)	Emission Level (dBuV/m)	Limit (dBuV/m)	Margin (dB)	Antenna Height (m)	Table Angle (Degree)	Raw Value (dBuV)	Correction Factor (dB/m)
1	48.25	26.30 QP	40.00	-13.70	1.29 V	254	16.90	9.40
2	120.01	30.10 QP	43.50	-13.40	1.24 V	124	18.60	11.50
3	125.05	29.30 QP	43.50	-14.20	1.47 V	255	17.30	12.00
4	200.00	26.60 QP	43.50	-16.90	1.24 V	201	17.60	9.00
5	330.19	33.40 QP	46.00	-12.60	1.24 V	22	18.50	14.90
6	375.24	29.40 QP	46.00	-16.60	1.03 V	268	13.20	16.20
7	400.05	29.80 QP	46.00	-16.20	1.02 V	236	12.70	17.10
8	500.00	31.20 QP	46.00	-14.80	1.24 V	241	11.90	19.30
9	750.01	39.70 QP	46.00	-6.30	1.03 V	247	15.90	23.80

- REMARKS:**
1. Emission level(dBuV/m)=Raw Value(dBuV) + Correction Factor(dB)
 2. Correction Factor(dB/m) = Antenna Factor (dB/m) + Cable Factor (dB)
 3. The other emission levels were very low against the limit.
 4. Margin value = Emission level – Limit value.



EUT	Flanker Pro Dual Radio AP	MODEL	AP-AG-AT-02
MODE	Channel 11 (Antenna 3-Adapter 2)	FREQUENCY RANGE	Below 1000 MHz
INPUT POWER (SYSTEM)	120Vac, 60Hz	DETECTOR FUNCTION	Quasi-Peak
ENVIRONMENTAL CONDITIONS	29deg. C, 56%RH, 982 hPa	TESTED BY	Eric Lee

ANTENNA POLARITY & TEST DISTANCE: HORIZONTAL AT 3 M

No.	Freq. (MHz)	Emission Level (dBuV/m)	Limit (dBuV/m)	Margin (dB)	Antenna Height (m)	Table Angle (Degree)	Raw Value (dBuV)	Correction Factor (dB/m)
1	120.24	27.80 QP	43.50	-15.70	1.36 H	201	16.30	11.50
2	125.02	28.60 QP	43.50	-14.90	1.24 H	36	16.60	12.00
3	250.33	31.20 QP	46.00	-14.80	1.02 H	360	18.20	13.00
4	300.00	28.60 QP	46.00	-17.40	1.24 H	241	14.40	14.20
5	330.24	31.60 QP	46.00	-14.40	1.20 H	253	16.70	14.90
6	375.24	29.30 QP	46.00	-16.70	1.24 H	23	13.10	16.20
7	400.21	31.90 QP	46.00	-14.10	1.30 H	245	14.80	17.10
8	600.00	33.40 QP	46.00	-12.60	1.24 H	57	12.50	20.90
9	625.35	33.90 QP	46.00	-12.10	1.24 H	25	12.20	21.70
10	750.03	37.10 QP	46.00	-8.90	1.00 H	23	13.30	23.80

ANTENNA POLARITY & TEST DISTANCE: VERTICAL AT 3 M

No.	Freq. (MHz)	Emission Level (dBuV/m)	Limit (dBuV/m)	Margin (dB)	Antenna Height (m)	Table Angle (Degree)	Raw Value (dBuV)	Correction Factor (dB/m)
1	47.63	28.30 QP	40.00	-11.70	1.42 V	235	18.50	9.80
2	120.00	27.90 QP	43.50	-15.60	1.03 V	231	16.40	11.50
3	125.24	26.40 QP	43.50	-17.10	1.03 V	235	14.40	12.00
4	200.00	26.30 QP	43.50	-17.20	1.47 V	142	17.30	9.00
5	250.14	30.60 QP	46.00	-15.40	1.35 V	203	17.60	13.00
6	330.26	32.80 QP	46.00	-13.20	1.00 V	232	17.90	14.90
7	375.01	29.10 QP	46.00	-16.90	1.24 V	220	12.90	16.20
8	399.98	29.30 QP	46.00	-16.70	2.03 V	201	12.20	17.10
9	500.02	31.50 QP	46.00	-14.50	1.02 V	320	12.20	19.30
10	750.26	37.10 QP	46.00	-8.90	1.02 V	220	13.30	23.80

- REMARKS:**
1. Emission level(dBuV/m)=Raw Value(dBuV) + Correction Factor(dB)
 2. Correction Factor(dB/m) = Antenna Factor (dB/m) + Cable Factor (dB)
 3. The other emission levels were very low against the limit.
 4. Margin value = Emission level – Limit value.



EUT	Flanker Pro Dual Radio AP	MODEL	AP-AG-AT-02
MODE	Channel 11 (Antenna 3-POE)	FREQUENCY RANGE	Below 1000 MHz
INPUT POWER (SYSTEM)	120Vac, 60Hz	DETECTOR FUNCTION	Quasi-Peak
ENVIRONMENTAL CONDITIONS	29deg. C, 56%RH, 982 hPa	TESTED BY	Eric Lee

ANTENNA POLARITY & TEST DISTANCE: HORIZONTAL AT 3 M

No.	Freq. (MHz)	Emission Level (dBuV/m)	Limit (dBuV/m)	Margin (dB)	Antenna Height (m)	Table Angle (Degree)	Raw Value (dBuV)	Correction Factor (dB/m)
1	120.10	27.10 QP	43.50	-16.40	1.24 H	247	15.60	11.50
2	125.24	29.30 QP	43.50	-14.20	1.24 H	256	17.30	12.00
3	200.00	25.10 QP	43.50	-18.40	2.35 H	243	16.10	9.00
4	250.60	27.30 QP	46.00	-18.70	2.31 H	210	14.20	13.10
5	300.20	27.30 QP	46.00	-18.70	1.24 H	111	13.10	14.20
6	330.21	29.40 QP	46.00	-16.60	1.24 H	231	14.60	14.90
7	375.23	28.90 QP	46.00	-17.10	1.20 H	127	12.70	16.20
8	400.00	32.30 QP	46.00	-13.70	1.07 H	256	15.20	17.10
9	500.00	35.10 QP	46.00	-10.90	1.27 H	233	15.80	19.30
10	750.02	40.10 QP	46.00	-5.90	2.40 H	230	16.30	23.80

ANTENNA POLARITY & TEST DISTANCE: VERTICAL AT 3 M

No.	Freq. (MHz)	Emission Level (dBuV/m)	Limit (dBuV/m)	Margin (dB)	Antenna Height (m)	Table Angle (Degree)	Raw Value (dBuV)	Correction Factor (dB/m)
1	48.25	27.30 QP	40.00	-12.70	1.02 V	214	17.90	9.40
2	120.24	29.30 QP	43.50	-14.20	1.02 V	230	17.80	11.50
3	125.03	29.60 QP	43.50	-13.90	4.00 V	210	17.60	12.00
4	200.00	27.40 QP	43.50	-16.10	1.02 V	231	18.40	9.00
5	250.24	32.10 QP	46.00	-13.90	1.04 V	231	19.10	13.00
6	330.12	31.90 QP	46.00	-14.10	1.04 V	201	17.00	14.90
7	375.24	29.30 QP	46.00	-16.70	1.07 V	205	13.10	16.20
8	399.99	29.70 QP	46.00	-16.30	1.24 V	203	12.60	17.10
9	500.21	31.70 QP	46.00	-14.30	1.03 V	278	12.40	19.30
10	750.02	36.40 QP	46.00	-9.60	1.71 V	239	12.60	23.80

- REMARKS:**
1. Emission level(dBuV/m)=Raw Value(dBuV) + Correction Factor(dB)
 2. Correction Factor(dB/m) = Antenna Factor (dB/m) + Cable Factor (dB)
 3. The other emission levels were very low against the limit.
 4. Margin value = Emission level – Limit value.



EUT	Flanker Pro Dual Radio AP	MODEL	AP-AG-AT-02
MODE	Channel 11 (Antenna 4-Adapter 1)	FREQUENCY RANGE	Below 1000 MHz
INPUT POWER (SYSTEM)	120Vac, 60Hz	DETECTOR FUNCTION	Quasi-Peak
ENVIRONMENTAL CONDITIONS	29deg. C, 56%RH, 982 hPa	TESTED BY	Eric Lee

ANTENNA POLARITY & TEST DISTANCE: HORIZONTAL AT 3 M

No.	Freq. (MHz)	Emission Level (dBuV/m)	Limit (dBuV/m)	Margin (dB)	Antenna Height (m)	Table Angle (Degree)	Raw Value (dBuV)	Correction Factor (dB/m)
1	120.25	23.50 QP	43.50	-20.00	1.20 H	2	12.00	11.50
2	125.40	27.70 QP	43.50	-15.80	1.40 H	309	15.70	12.00
3	199.99	24.00 QP	43.50	-19.50	1.56 H	202	15.00	9.00
4	250.11	29.30 QP	46.00	-16.70	1.43 H	62	16.30	13.00
5	300.00	27.70 QP	46.00	-18.30	1.27 H	85	13.50	14.20
6	330.02	29.10 QP	46.00	-16.90	1.86 H	3	14.20	14.90
7	375.21	27.20 QP	46.00	-18.80	1.58 H	120	11.00	16.20
8	400.00	26.70 QP	46.00	-19.30	1.69 H	253	9.60	17.10
9	500.09	30.80 QP	46.00	-15.20	1.54 H	7	11.50	19.30
10	749.25	37.00 QP	46.00	-9.00	1.52 H	32	13.20	23.80

ANTENNA POLARITY & TEST DISTANCE: VERTICAL AT 3 M

No.	Freq. (MHz)	Emission Level (dBuV/m)	Limit (dBuV/m)	Margin (dB)	Antenna Height (m)	Table Angle (Degree)	Raw Value (dBuV)	Correction Factor (dB/m)
1	49.68	24.00 QP	40.00	-16.00	1.13 V	50	15.40	8.70
2	120.03	27.70 QP	43.50	-15.80	1.38 V	70	16.20	11.50
3	125.00	28.10 QP	43.50	-15.40	1.37 V	40	16.00	12.10
4	200.07	25.00 QP	43.50	-18.50	1.40 V	299	16.00	9.00
5	249.91	29.20 QP	46.00	-16.80	1.04 V	22	16.20	13.00
6	330.01	31.10 QP	46.00	-14.90	1.14 V	0	16.20	14.90
7	375.42	29.00 QP	46.00	-17.00	1.85 V	22	12.80	16.20
8	400.11	27.40 QP	46.00	-18.60	1.08 V	252	10.30	17.10
9	499.99	31.60 QP	46.00	-14.40	1.70 V	21	12.30	19.30
10	749.96	33.30 QP	46.00	-12.70	1.68 V	74	9.50	23.80

- REMARKS:**
1. Emission level(dBuV/m)=Raw Value(dBuV) + Correction Factor(dB)
 2. Correction Factor(dB/m) = Antenna Factor (dB/m) + Cable Factor (dB)
 3. The other emission levels were very low against the limit.
 4. Margin value = Emission level – Limit value.



EUT	Flanker Pro Dual Radio AP	MODEL	AP-AG-AT-02
MODE	Channel 11 (Antenna 4-Adapter 2)	FREQUENCY RANGE	Below 1000 MHz
INPUT POWER (SYSTEM)	120Vac, 60Hz	DETECTOR FUNCTION	Quasi-Peak
ENVIRONMENTAL CONDITIONS	29deg. C, 56%RH, 982 hPa	TESTED BY	Eric Lee

ANTENNA POLARITY & TEST DISTANCE: HORIZONTAL AT 3 M

No.	Freq. (MHz)	Emission Level (dBuV/m)	Limit (dBuV/m)	Margin (dB)	Antenna Height (m)	Table Angle (Degree)	Raw Value (dBuV)	Correction Factor (dB/m)
1	120.03	23.50 QP	43.50	-20.00	1.36 H	98	12.00	11.50
2	124.77	24.90 QP	43.50	-18.60	1.28 H	3	12.90	12.00
3	200.05	21.90 QP	43.50	-21.60	1.23 H	210	12.90	9.00
4	250.03	31.10 QP	46.00	-14.90	1.23 H	275	18.10	13.00
5	300.02	28.50 QP	46.00	-17.50	1.05 H	296	14.30	14.20
6	330.00	27.00 QP	46.00	-19.00	1.20 H	52	12.10	14.90
7	375.15	25.60 QP	46.00	-20.40	1.37 H	357	9.40	16.20
8	499.98	27.80 QP	46.00	-18.20	1.37 H	59	8.50	19.30
9	600.20	31.50 QP	46.00	-14.50	1.28 H	274	10.60	20.90
10	625.03	30.30 QP	46.00	-15.70	1.07 H	266	8.60	21.70

ANTENNA POLARITY & TEST DISTANCE: VERTICAL AT 3 M

No.	Freq. (MHz)	Emission Level (dBuV/m)	Limit (dBuV/m)	Margin (dB)	Antenna Height (m)	Table Angle (Degree)	Raw Value (dBuV)	Correction Factor (dB/m)
1	48.63	28.30 QP	40.00	-11.70	1.34 V	168	19.10	9.20
2	125.01	29.20 QP	43.50	-14.30	1.46 V	1	17.10	12.00
3	200.07	26.50 QP	43.50	-17.00	1.09 V	163	17.50	9.00
4	250.02	33.00 QP	46.00	-13.00	1.02 V	139	20.00	13.00
5	300.02	29.10 QP	46.00	-16.90	1.28 V	275	14.90	14.20
6	330.00	30.70 QP	46.00	-15.30	1.16 V	1	15.80	14.90
7	375.01	28.60 QP	46.00	-17.40	1.19 V	320	12.40	16.20
8	400.05	29.40 QP	46.00	-16.60	1.37 V	38	12.30	17.10
9	500.04	31.90 QP	46.00	-14.10	1.06 V	49	12.60	19.30
10	750.17	33.40 QP	46.00	-12.60	1.27 V	105	9.60	23.80

- REMARKS:**
1. Emission level(dBuV/m)=Raw Value(dBuV) + Correction Factor(dB)
 2. Correction Factor(dB/m) = Antenna Factor (dB/m) + Cable Factor (dB)
 3. The other emission levels were very low against the limit.
 4. Margin value = Emission level – Limit value.



EUT	Flanker Pro Dual Radio AP	MODEL	AP-AG-AT-02
MODE	Channel 11 (Antenna 4-POE)	FREQUENCY RANGE	Below 1000 MHz
INPUT POWER (SYSTEM)	120Vac, 60Hz	DETECTOR FUNCTION	Quasi-Peak
ENVIRONMENTAL CONDITIONS	29deg. C, 56%RH, 982 hPa	TESTED BY	Eric Lee

ANTENNA POLARITY & TEST DISTANCE: HORIZONTAL AT 3 M

No.	Freq. (MHz)	Emission Level (dBuV/m)	Limit (dBuV/m)	Margin (dB)	Antenna Height (m)	Table Angle (Degree)	Raw Value (dBuV)	Correction Factor (dB/m)
1	119.98	22.90 QP	43.50	-20.60	1.03 H	137	11.50	11.50
2	124.83	22.60 QP	43.50	-20.90	1.37 H	172	10.50	12.00
3	199.82	22.30 QP	43.50	-21.20	1.62 H	2	13.30	9.00
4	250.02	30.90 QP	46.00	-15.10	1.04 H	74	17.90	13.00
5	300.03	25.10 QP	46.00	-20.90	1.28 H	13	10.90	14.20
6	330.00	29.70 QP	46.00	-16.30	1.02 H	205	14.80	14.90
7	375.04	27.40 QP	46.00	-18.60	1.46 H	24	11.20	16.20
8	500.10	32.50 QP	46.00	-13.50	1.09 H	160	13.20	19.30
9	624.76	31.10 QP	46.00	-14.90	1.59 H	156	9.40	21.70
10	750.18	34.70 QP	46.00	-11.30	1.08 H	270	10.90	23.80

ANTENNA POLARITY & TEST DISTANCE: VERTICAL AT 3 M

No.	Freq. (MHz)	Emission Level (dBuV/m)	Limit (dBuV/m)	Margin (dB)	Antenna Height (m)	Table Angle (Degree)	Raw Value (dBuV)	Correction Factor (dB/m)
1	120.00	24.40 QP	43.50	-19.10	1.02 V	55	12.90	11.50
2	125.02	23.10 QP	43.50	-20.40	1.33 V	160	11.10	12.00
3	200.00	27.30 QP	43.50	-16.20	1.13 V	200	18.30	9.00
4	250.03	32.70 QP	46.00	-13.30	1.19 V	134	19.70	13.00
5	330.00	31.90 QP	46.00	-14.10	1.57 V	93	17.00	14.90
6	375.02	27.50 QP	46.00	-18.50	1.52 V	69	11.30	16.20
7	400.07	27.30 QP	46.00	-18.70	1.21 V	77	10.20	17.10
8	500.05	30.10 QP	46.00	-15.90	1.36 V	30	10.80	19.30
9	625.09	31.90 QP	46.00	-14.10	1.10 V	108	10.10	21.70
10	750.10	33.00 QP	46.00	-13.00	1.50 V	231	9.20	23.80

- REMARKS:**
1. Emission level(dBuV/m)=Raw Value(dBuV) + Correction Factor(dB)
 2. Correction Factor(dB/m) = Antenna Factor (dB/m) + Cable Factor (dB)
 3. The other emission levels were very low against the limit.
 4. Margin value = Emission level – Limit value.



EUT	Flanker Pro Dual Radio AP	MODEL	AP-AG-AT-02
MODE	Channel 11 (Antenna 5-Adapter 1)	FREQUENCY RANGE	Below 1000 MHz
INPUT POWER (SYSTEM)	120Vac, 60Hz	DETECTOR FUNCTION	Quasi-Peak
ENVIRONMENTAL CONDITIONS	29deg. C, 56%RH, 982 hPa	TESTED BY	Eric Lee

ANTENNA POLARITY & TEST DISTANCE: HORIZONTAL AT 3 M

No.	Freq. (MHz)	Emission Level (dBuV/m)	Limit (dBuV/m)	Margin (dB)	Antenna Height (m)	Table Angle (Degree)	Raw Value (dBuV)	Correction Factor (dB/m)
1	120.02	26.70 QP	43.50	-16.80	1.50 H	201	15.20	11.50
2	125.20	27.00 QP	43.50	-16.50	1.11 H	47	15.00	12.00
3	200.00	23.60 QP	43.50	-19.90	1.68 H	63	14.60	9.00
4	250.04	28.40 QP	46.00	-17.60	1.53 H	62	15.40	13.00
5	330.24	29.10 QP	46.00	-16.90	1.82 H	203	14.20	14.90
6	375.32	27.20 QP	46.00	-18.80	1.19 H	129	11.00	16.20
7	500.24	31.80 QP	46.00	-14.20	1.11 H	54	12.50	19.30
8	600.50	30.20 QP	46.00	-15.80	1.62 H	309	9.30	20.90
9	625.21	31.60 QP	46.00	-14.40	1.35 H	62	9.90	21.70
10	750.01	34.10 QP	46.00	-11.90	1.54 H	74	10.30	23.80

ANTENNA POLARITY & TEST DISTANCE: VERTICAL AT 3 M

No.	Freq. (MHz)	Emission Level (dBuV/m)	Limit (dBuV/m)	Margin (dB)	Antenna Height (m)	Table Angle (Degree)	Raw Value (dBuV)	Correction Factor (dB/m)
1	48.24	24.90 QP	40.00	-15.10	1.25 V	41	15.50	9.40
2	119.99	27.70 QP	43.50	-15.80	1.20 V	241	16.20	11.50
3	125.03	27.30 QP	43.50	-16.20	1.45 V	87	15.20	12.00
4	200.00	26.00 QP	43.50	-17.50	1.11 V	352	17.00	9.00
5	250.41	29.00 QP	46.00	-17.00	1.35 V	80	15.90	13.10
6	330.22	30.80 QP	46.00	-15.20	1.08 V	93	15.90	14.90
7	375.21	26.90 QP	46.00	-19.10	1.57 V	1	10.70	16.20
8	400.24	29.80 QP	46.00	-16.20	1.96 V	320	12.60	17.10
9	500.00	30.20 QP	46.00	-15.80	1.45 V	55	10.90	19.30
10	750.04	34.00 QP	46.00	-12.00	1.45 V	154	10.20	23.80

- REMARKS:**
1. Emission level(dBuV/m)=Raw Value(dBuV) + Correction Factor(dB)
 2. Correction Factor(dB/m) = Antenna Factor (dB/m) + Cable Factor (dB)
 3. The other emission levels were very low against the limit.
 4. Margin value = Emission level – Limit value.



EUT	Flanker Pro Dual Radio AP	MODEL	AP-AG-AT-02
MODE	Channel 11 (Antenna 5-Adapter 2)	FREQUENCY RANGE	Below 1000 MHz
INPUT POWER (SYSTEM)	120Vac, 60Hz	DETECTOR FUNCTION	Quasi-Peak
ENVIRONMENTAL CONDITIONS	29deg. C, 56%RH, 982 hPa	TESTED BY	Eric Lee

ANTENNA POLARITY & TEST DISTANCE: HORIZONTAL AT 3 M

No.	Freq. (MHz)	Emission Level (dBuV/m)	Limit (dBuV/m)	Margin (dB)	Antenna Height (m)	Table Angle (Degree)	Raw Value (dBuV)	Correction Factor (dB/m)
1	120.00	24.10 QP	43.50	-19.40	1.74 H	8	12.60	11.50
2	125.32	23.70 QP	43.50	-19.80	1.74 H	265	11.70	12.00
3	200.00	23.00 QP	43.50	-20.50	1.52 H	208	14.00	9.00
4	250.09	31.30 QP	46.00	-14.70	1.65 H	326	18.30	13.00
5	300.76	25.20 QP	46.00	-20.80	1.58 H	85	11.00	14.20
6	330.00	30.10 QP	46.00	-15.90	1.46 H	24	15.20	14.90
7	375.28	28.10 QP	46.00	-17.90	1.57 H	93	11.90	16.20
8	500.00	33.20 QP	46.00	-12.80	1.05 H	78	13.90	19.30
9	625.11	31.30 QP	46.00	-14.70	1.54 H	74	9.60	21.70
10	750.23	35.40 QP	46.00	-10.60	1.59 H	241	11.60	23.80

ANTENNA POLARITY & TEST DISTANCE: VERTICAL AT 3 M

No.	Freq. (MHz)	Emission Level (dBuV/m)	Limit (dBuV/m)	Margin (dB)	Antenna Height (m)	Table Angle (Degree)	Raw Value (dBuV)	Correction Factor (dB/m)
1	50.23	24.60 QP	40.00	-15.40	1.54 V	241	16.20	8.40
2	120.41	22.40 QP	43.50	-21.10	1.56 V	168	10.90	11.50
3	125.50	28.50 QP	43.50	-15.00	1.55 V	52	16.50	12.00
4	200.00	24.80 QP	43.50	-18.70	1.11 V	5	15.80	9.00
5	250.30	27.30 QP	46.00	-18.70	1.73 V	208	14.20	13.00
6	300.40	31.20 QP	46.00	-14.80	1.73 V	327	17.00	14.20
7	330.11	31.40 QP	46.00	-14.60	1.02 V	319	16.50	14.90
8	375.01	29.20 QP	46.00	-16.80	1.11 V	85	13.00	16.20
9	500.23	31.70 QP	46.00	-14.30	1.47 V	360	12.40	19.30
10	750.03	34.00 QP	46.00	-12.00	1.36 V	122	10.20	23.80

- REMARKS:**
1. Emission level(dBuV/m)=Raw Value(dBuV) + Correction Factor(dB)
 2. Correction Factor(dB/m) = Antenna Factor (dB/m) + Cable Factor (dB)
 3. The other emission levels were very low against the limit.
 4. Margin value = Emission level – Limit value.



EUT	Flanker Pro Dual Radio AP	MODEL	AP-AG-AT-02
MODE	Channel 11 (Antenna 5-POE)	FREQUENCY RANGE	Below 1000 MHz
INPUT POWER (SYSTEM)	120Vac, 60Hz	DETECTOR FUNCTION	Quasi-Peak
ENVIRONMENTAL CONDITIONS	29deg. C, 56%RH, 982 hPa	TESTED BY	Eric Lee

ANTENNA POLARITY & TEST DISTANCE: HORIZONTAL AT 3 M

No.	Freq. (MHz)	Emission Level (dBuV/m)	Limit (dBuV/m)	Margin (dB)	Antenna Height (m)	Table Angle (Degree)	Raw Value (dBuV)	Correction Factor (dB/m)
1	120.03	26.70 QP	43.50	-16.80	1.65 H	20	15.20	11.50
2	125.23	26.90 QP	43.50	-16.60	1.22 H	194	14.90	12.00
3	200.03	19.90 QP	43.50	-23.60	1.74 H	352	10.90	9.00
4	250.00	27.50 QP	46.00	-18.50	1.11 H	203	14.50	13.00
5	330.80	31.20 QP	46.00	-14.80	1.29 H	119	16.30	14.90
6	375.42	26.10 QP	46.00	-19.90	1.65 H	75	9.90	16.20
7	500.38	33.30 QP	46.00	-12.70	1.56 H	59	14.00	19.30
8	600.00	29.80 QP	46.00	-16.20	1.57 H	186	8.90	20.90
9	625.41	31.50 QP	46.00	-14.50	1.52 H	306	9.80	21.70
10	750.12	34.00 QP	46.00	-12.00	1.54 H	222	10.20	23.80

ANTENNA POLARITY & TEST DISTANCE: VERTICAL AT 3 M

No.	Freq. (MHz)	Emission Level (dBuV/m)	Limit (dBuV/m)	Margin (dB)	Antenna Height (m)	Table Angle (Degree)	Raw Value (dBuV)	Correction Factor (dB/m)
1	48.69	24.40 QP	40.00	-15.60	1.54 V	74	15.30	9.20
2	120.00	26.70 QP	43.50	-16.80	1.47 V	78	15.20	11.50
3	125.99	27.90 QP	43.50	-15.60	1.62 V	32	15.90	12.00
4	200.00	24.40 QP	43.50	-19.10	1.08 V	53	15.40	9.00
5	250.06	29.90 QP	46.00	-16.10	1.78 V	52	16.90	13.00
6	330.01	31.90 QP	46.00	-14.10	1.39 V	32	17.00	14.90
7	375.09	33.10 QP	46.00	-12.90	1.20 V	55	16.90	16.20
8	400.00	29.60 QP	46.00	-16.40	1.27 V	53	12.50	17.10
9	500.30	31.50 QP	46.00	-14.50	1.57 V	96	12.20	19.30
10	750.04	34.00 QP	46.00	-12.00	1.43 V	62	10.20	23.80

- REMARKS:**
1. Emission level(dBuV/m)=Raw Value(dBuV) + Correction Factor(dB)
 2. Correction Factor(dB/m) = Antenna Factor (dB/m) + Cable Factor (dB)
 3. The other emission levels were very low against the limit.
 4. Margin value = Emission level – Limit value.



EUT	Flanker Pro Dual Radio AP	MODEL	AP-AG-AT-02
MODE	Channel 11 (Antenna 6-Adapter 1)	FREQUENCY RANGE	Below 1000 MHz
INPUT POWER (SYSTEM)	120Vac, 60Hz	DETECTOR FUNCTION	Quasi-Peak
ENVIRONMENTAL CONDITIONS	29deg. C, 56%RH, 982 hPa	TESTED BY	Eric Lee

ANTENNA POLARITY & TEST DISTANCE: HORIZONTAL AT 3 M

No.	Freq. (MHz)	Emission Level (dBuV/m)	Limit (dBuV/m)	Margin (dB)	Antenna Height (m)	Table Angle (Degree)	Raw Value (dBuV)	Correction Factor (dB/m)
1	120.01	19.60 QP	43.50	-23.90	1.18 H	9	8.00	11.50
2	125.01	28.60 QP	43.50	-14.90	1.88 H	106	16.50	12.00
3	200.01	22.40 QP	43.50	-21.10	1.86 H	159	13.40	9.00
4	250.03	29.60 QP	46.00	-16.40	1.01 H	65	16.60	13.00
5	300.04	26.70 QP	46.00	-19.30	1.13 H	33	12.50	14.20
6	330.03	28.30 QP	46.00	-17.70	1.04 H	28	13.40	14.90
7	375.01	26.80 QP	46.00	-19.20	1.35 H	12	10.60	16.20
8	400.06	26.80 QP	46.00	-19.20	1.02 H	40	9.70	17.10
9	500.05	29.00 QP	46.00	-17.00	1.35 H	192	9.70	19.30
10	750.10	35.20 QP	46.00	-10.80	1.28 H	45	11.40	23.80

ANTENNA POLARITY & TEST DISTANCE: VERTICAL AT 3 M

No.	Freq. (MHz)	Emission Level (dBuV/m)	Limit (dBuV/m)	Margin (dB)	Antenna Height (m)	Table Angle (Degree)	Raw Value (dBuV)	Correction Factor (dB/m)
1	50.24	24.60 QP	40.00	-15.40	1.11 V	25	16.20	8.40
2	120.00	22.00 QP	43.50	-21.50	1.52 V	168	10.50	11.50
3	125.03	28.40 QP	43.50	-15.10	1.42 V	131	16.40	12.00
4	200.01	24.20 QP	43.50	-19.30	1.02 V	8	15.20	9.00
5	250.03	30.50 QP	46.00	-15.50	1.02 V	141	17.50	13.00
6	300.04	29.20 QP	46.00	-16.80	1.36 V	350	15.00	14.20
7	330.00	31.30 QP	46.00	-14.70	1.22 V	1	16.40	14.90
8	375.01	29.00 QP	46.00	-17.00	1.16 V	40	12.80	16.20
9	500.05	31.50 QP	46.00	-14.50	1.31 V	221	12.20	19.30
10	750.13	34.60 QP	46.00	-11.40	1.38 V	151	10.80	23.80

- REMARKS:**
1. Emission level(dBuV/m)=Raw Value(dBuV) + Correction Factor(dB)
 2. Correction Factor(dB/m) = Antenna Factor (dB/m) + Cable Factor (dB)
 3. The other emission levels were very low against the limit.
 4. Margin value = Emission level – Limit value.



EUT	Flanker Pro Dual Radio AP	MODEL	AP-AG-AT-02
MODE	Channel 11 (Antenna 6-Adapter 2)	FREQUENCY RANGE	Below 1000 MHz
INPUT POWER (SYSTEM)	120Vac, 60Hz	DETECTOR FUNCTION	Quasi-Peak
ENVIRONMENTAL CONDITIONS	29deg. C, 56%RH, 982 hPa	TESTED BY	Eric Lee

ANTENNA POLARITY & TEST DISTANCE: HORIZONTAL AT 3 M

No.	Freq. (MHz)	Emission Level (dBuV/m)	Limit (dBuV/m)	Margin (dB)	Antenna Height (m)	Table Angle (Degree)	Raw Value (dBuV)	Correction Factor (dB/m)
1	120.02	22.40 QP	43.50	-21.10	1.23 H	65	10.90	11.50
2	125.09	28.30 QP	43.50	-15.20	1.02 H	54	16.20	12.00
3	200.00	23.20 QP	43.50	-20.30	1.14 H	21	14.20	9.00
4	250.31	28.30 QP	46.00	-17.70	1.47 H	77	15.20	13.00
5	300.22	27.40 QP	46.00	-18.60	1.32 H	52	13.20	14.20
6	330.00	27.90 QP	46.00	-18.10	1.08 H	139	13.00	14.90
7	375.31	26.20 QP	46.00	-19.80	1.72 H	75	10.00	16.20
8	400.42	27.00 QP	46.00	-19.00	1.08 H	71	9.90	17.10
9	501.00	29.50 QP	46.00	-16.50	1.56 H	3	10.20	19.30
10	750.03	35.10 QP	46.00	-10.90	1.25 H	42	11.30	23.80

ANTENNA POLARITY & TEST DISTANCE: VERTICAL AT 3 M

No.	Freq. (MHz)	Emission Level (dBuV/m)	Limit (dBuV/m)	Margin (dB)	Antenna Height (m)	Table Angle (Degree)	Raw Value (dBuV)	Correction Factor (dB/m)
1	120.00	25.50 QP	43.50	-18.00	1.53 V	69	14.00	11.50
2	125.02	27.60 QP	43.50	-15.90	1.00 V	103	15.60	12.00
3	200.11	24.90 QP	43.50	-18.60	1.39 V	68	15.90	9.00
4	250.32	30.30 QP	46.00	-15.70	1.47 V	96	17.30	13.00
5	300.01	26.70 QP	46.00	-19.30	1.28 V	51	12.50	14.20
6	330.00	32.00 QP	46.00	-14.00	1.30 V	1	17.10	14.90
7	375.46	27.90 QP	46.00	-18.10	1.52 V	326	11.70	16.20
8	400.62	27.20 QP	46.00	-18.80	1.68 V	96	10.10	17.10
9	500.30	31.90 QP	46.00	-14.10	1.55 V	54	12.60	19.30
10	750.07	34.60 QP	46.00	-11.40	1.54 V	45	10.80	23.80

- REMARKS:**
1. Emission level(dBuV/m)=Raw Value(dBuV) + Correction Factor(dB)
 2. Correction Factor(dB/m) = Antenna Factor (dB/m) + Cable Factor (dB)
 3. The other emission levels were very low against the limit.
 4. Margin value = Emission level – Limit value.



EUT	Flanker Pro Dual Radio AP	MODEL	AP-AG-AT-02
MODE	Channel 11 (Antenna 6-POE)	FREQUENCY RANGE	Below 1000 MHz
INPUT POWER (SYSTEM)	120Vac, 60Hz	DETECTOR FUNCTION	Quasi-Peak
ENVIRONMENTAL CONDITIONS	29deg. C, 56%RH, 982 hPa	TESTED BY	Eric Lee

ANTENNA POLARITY & TEST DISTANCE: HORIZONTAL AT 3 M

No.	Freq. (MHz)	Emission Level (dBuV/m)	Limit (dBuV/m)	Margin (dB)	Antenna Height (m)	Table Angle (Degree)	Raw Value (dBuV)	Correction Factor (dB/m)
1	120.02	24.70 QP	43.50	-18.80	1.75 H	82	13.20	11.50
2	125.10	26.20 QP	43.50	-17.30	1.06 H	63	14.20	12.00
3	200.23	18.30 QP	43.50	-25.20	1.22 H	53	9.30	9.00
4	250.00	27.10 QP	46.00	-18.90	1.82 H	194	14.10	13.00
5	330.01	29.90 QP	46.00	-16.10	1.29 H	1	15.00	14.90
6	375.04	19.80 QP	46.00	-26.20	1.04 H	58	3.60	16.20
7	500.21	32.90 QP	46.00	-13.10	1.28 H	352	13.60	19.30
8	600.12	29.50 QP	46.00	-16.50	1.47 H	78	8.60	20.90
9	624.99	32.30 QP	46.00	-13.70	1.43 H	6	10.60	21.70
10	750.10	34.10 QP	46.00	-11.90	1.52 H	47	10.30	23.80

ANTENNA POLARITY & TEST DISTANCE: VERTICAL AT 3 M

No.	Freq. (MHz)	Emission Level (dBuV/m)	Limit (dBuV/m)	Margin (dB)	Antenna Height (m)	Table Angle (Degree)	Raw Value (dBuV)	Correction Factor (dB/m)
1	48.33	18.40 QP	40.00	-21.60	1.29 V	63	9.00	9.40
2	120.01	28.80 QP	43.50	-14.70	1.14 V	52	17.30	11.50
3	125.61	25.60 QP	43.50	-17.90	1.73 V	309	13.60	12.00
4	250.00	29.30 QP	46.00	-16.70	1.25 V	0	16.30	13.00
5	300.00	28.40 QP	46.00	-17.60	1.56 V	69	14.20	14.20
6	330.40	31.40 QP	46.00	-14.60	1.87 V	45	16.50	14.90
7	375.36	26.00 QP	46.00	-20.00	1.65 V	74	9.80	16.20
8	400.00	27.10 QP	46.00	-18.90	1.45 V	24	10.00	17.10
9	500.08	29.40 QP	46.00	-16.60	1.65 V	41	10.10	19.30
10	750.21	32.70 QP	46.00	-13.30	1.02 V	337	8.90	23.80

- REMARKS:**
1. Emission level(dBuV/m)=Raw Value(dBuV) + Correction Factor(dB)
 2. Correction Factor(dB/m) = Antenna Factor (dB/m) + Cable Factor (dB)
 3. The other emission levels were very low against the limit.
 4. Margin value = Emission level – Limit value.



EUT	Flanker Pro Dual Radio AP	MODEL	AP-AG-AT-02
MODE	Channel 11 (Antenna 7-Adapter 1)	FREQUENCY RANGE	Below 1000 MHz
INPUT POWER (SYSTEM)	120Vac, 60Hz	DETECTOR FUNCTION	Quasi-Peak
ENVIRONMENTAL CONDITIONS	29deg. C, 56%RH, 982 hPa	TESTED BY	Eric Lee

ANTENNA POLARITY & TEST DISTANCE: HORIZONTAL AT 3 M

No.	Freq. (MHz)	Emission Level (dBuV/m)	Limit (dBuV/m)	Margin (dB)	Antenna Height (m)	Table Angle (Degree)	Raw Value (dBuV)	Correction Factor (dB/m)
1	120.04	21.60 QP	43.50	-21.90	1.83 H	62	10.10	11.50
2	125.04	25.30 QP	43.50	-18.20	1.63 H	33	13.30	12.00
3	250.08	29.70 QP	46.00	-16.30	1.47 H	8	16.70	13.00
4	300.11	27.90 QP	46.00	-18.10	1.02 H	6	13.70	14.20
5	330.00	27.00 QP	46.00	-19.00	1.20 H	52	12.10	14.90
6	375.15	25.60 QP	46.00	-20.40	1.37 H	357	9.40	16.20
7	500.04	28.40 QP	46.00	-17.60	1.02 H	3	9.10	19.30
8	600.24	30.00 QP	46.00	-16.00	1.40 H	208	9.10	20.90
9	625.11	30.80 QP	46.00	-15.20	1.69 H	336	9.10	21.70
10	750.03	31.20 QP	46.00	-14.80	1.05 H	2	7.40	23.80

ANTENNA POLARITY & TEST DISTANCE: VERTICAL AT 3 M

No.	Freq. (MHz)	Emission Level (dBuV/m)	Limit (dBuV/m)	Margin (dB)	Antenna Height (m)	Table Angle (Degree)	Raw Value (dBuV)	Correction Factor (dB/m)
1	49.00	23.50 QP	40.00	-16.50	1.08 V	99	13.90	9.60
2	120.09	25.20 QP	43.50	-18.30	1.45 V	3	12.60	12.60
3	125.07	25.40 QP	43.50	-18.10	1.60 V	309	12.40	13.10
4	200.01	25.20 QP	43.50	-18.30	1.25 V	36	15.20	10.10
5	250.14	27.10 QP	46.00	-18.90	1.11 V	45	12.70	14.40
6	330.20	29.30 QP	46.00	-16.70	1.65 V	3	13.00	16.30
7	375.21	26.90 QP	46.00	-19.10	1.57 V	1	9.20	17.80
8	400.24	29.80 QP	46.00	-16.20	1.96 V	320	11.10	18.70
9	500.00	30.20 QP	46.00	-15.80	1.45 V	55	8.60	21.60
10	750.04	32.50 QP	46.00	-13.50	1.54 V	24	6.30	26.10

- REMARKS:**
1. Emission level(dBuV/m)=Raw Value(dBuV) + Correction Factor(dB)
 2. Correction Factor(dB/m) = Antenna Factor (dB/m) + Cable Factor (dB)
 3. The other emission levels were very low against the limit.
 4. Margin value = Emission level – Limit value.



EUT	Flanker Pro Dual Radio AP	MODEL	AP-AG-AT-02
MODE	Channel 11 (Antenna 7-Adapter 2)	FREQUENCY RANGE	Below 1000 MHz
INPUT POWER (SYSTEM)	120Vac, 60Hz	DETECTOR FUNCTION	Quasi-Peak
ENVIRONMENTAL CONDITIONS	29deg. C, 56%RH, 982 hPa	TESTED BY	Eric Lee

ANTENNA POLARITY & TEST DISTANCE: HORIZONTAL AT 3 M

No.	Freq. (MHz)	Emission Level (dBuV/m)	Limit (dBuV/m)	Margin (dB)	Antenna Height (m)	Table Angle (Degree)	Raw Value (dBuV)	Correction Factor (dB/m)
1	120.53	22.20 QP	43.50	-21.20	1.58 H	6	10.70	11.60
2	125.34	24.60 QP	43.50	-18.90	1.02 H	35	12.60	12.00
3	250.86	29.00 QP	46.00	-17.00	1.57 H	89	15.90	13.10
4	300.24	26.40 QP	46.00	-19.60	1.58 H	96	12.10	14.20
5	330.00	27.00 QP	46.00	-19.00	1.20 H	52	12.10	14.90
6	375.00	26.80 QP	46.00	-19.20	1.73 H	60	10.60	16.20
7	500.73	29.70 QP	46.00	-16.30	1.00 H	359	10.40	19.30
8	600.24	30.00 QP	46.00	-16.00	1.40 H	208	9.10	20.90
9	624.86	31.70 QP	46.00	-14.30	1.85 H	55	10.00	21.70
10	750.03	31.00 QP	46.00	-15.00	1.54 H	213	7.20	23.80

ANTENNA POLARITY & TEST DISTANCE: VERTICAL AT 3 M

No.	Freq. (MHz)	Emission Level (dBuV/m)	Limit (dBuV/m)	Margin (dB)	Antenna Height (m)	Table Angle (Degree)	Raw Value (dBuV)	Correction Factor (dB/m)
1	48.20	23.60 QP	40.00	-16.40	1.68 V	354	13.60	10.00
2	120.00	24.40 QP	43.50	-19.10	1.66 V	333	11.80	12.60
3	125.07	24.30 QP	43.50	-19.20	1.65 V	79	11.20	13.10
4	200.11	24.10 QP	43.50	-19.40	1.06 V	37	14.00	10.10
5	250.13	26.30 QP	46.00	-19.70	1.11 V	20	11.90	14.40
6	330.43	27.60 QP	46.00	-18.40	2.00 V	222	11.30	16.30
7	375.43	25.80 QP	46.00	-20.20	1.85 V	7	8.10	17.80
8	400.24	28.00 QP	46.00	-18.00	1.96 V	320	9.30	18.70
9	500.16	29.60 QP	46.00	-16.40	1.53 V	62	8.00	21.60
10	749.99	31.20 QP	46.00	-14.80	1.15 V	240	5.10	26.10

- REMARKS:**
1. Emission level(dBuV/m)=Raw Value(dBuV) + Correction Factor(dB)
 2. Correction Factor(dB/m) = Antenna Factor (dB/m) + Cable Factor (dB)
 3. The other emission levels were very low against the limit.
 4. Margin value = Emission level – Limit value.



EUT	Flanker Pro Dual Radio AP	MODEL	AP-AG-AT-02
MODE	Channel 11 (Antenna 7-POE)	FREQUENCY RANGE	Below 1000 MHz
INPUT POWER (SYSTEM)	120Vac, 60Hz	DETECTOR FUNCTION	Quasi-Peak
ENVIRONMENTAL CONDITIONS	29deg. C, 56%RH, 982 hPa	TESTED BY	Eric Lee

ANTENNA POLARITY & TEST DISTANCE: HORIZONTAL AT 3 M

No.	Freq. (MHz)	Emission Level (dBuV/m)	Limit (dBuV/m)	Margin (dB)	Antenna Height (m)	Table Angle (Degree)	Raw Value (dBuV)	Correction Factor (dB/m)
1	120.34	23.50 QP	43.50	-20.00	1.60 H	201	12.00	11.50
2	125.37	25.60 QP	43.50	-17.90	1.96 H	93	13.60	12.00
3	250.40	28.60 QP	46.00	-17.40	1.65 H	3	15.60	13.10
4	300.57	27.50 QP	46.00	-18.50	2.01 H	356	13.30	14.20
5	330.00	25.90 QP	46.00	-20.10	1.40 H	354	11.00	14.90
6	375.07	27.50 QP	46.00	-18.50	1.18 H	352	11.30	16.20
7	500.34	30.60 QP	46.00	-15.40	1.64 H	246	11.30	19.30
8	600.14	30.00 QP	46.00	-16.00	1.80 H	254	9.10	20.90
9	625.01	32.60 QP	46.00	-13.40	1.59 H	353	10.90	21.70
10	750.11	32.20 QP	46.00	-13.80	1.58 H	9	8.40	23.80

ANTENNA POLARITY & TEST DISTANCE: VERTICAL AT 3 M

No.	Freq. (MHz)	Emission Level (dBuV/m)	Limit (dBuV/m)	Margin (dB)	Antenna Height (m)	Table Angle (Degree)	Raw Value (dBuV)	Correction Factor (dB/m)
1	48.67	22.50 QP	40.00	-17.50	1.05 V	241	12.70	9.80
2	119.99	25.20 QP	43.50	-18.30	1.66 V	326	12.70	12.60
3	125.01	23.70 QP	43.50	-19.80	1.96 V	357	10.60	13.10
4	200.00	24.70 QP	43.50	-18.80	1.86 V	54	14.60	10.10
5	250.52	25.20 QP	46.00	-20.80	1.66 V	333	10.80	14.50
6	375.43	25.80 QP	46.00	-20.20	1.85 V	7	8.10	17.80
7	400.15	27.40 QP	46.00	-18.60	1.68 V	96	8.80	18.70
8	500.00	28.50 QP	46.00	-17.50	1.32 V	209	6.90	21.60
9	625.21	24.10 QP	46.00	-21.90	1.68 V	9	0.30	23.80
10	750.01	32.10 QP	46.00	-13.90	1.21 V	5	6.00	26.10

- REMARKS:**
1. Emission level(dBuV/m)=Raw Value(dBuV) + Correction Factor(dB)
 2. Correction Factor(dB/m) = Antenna Factor (dB/m) + Cable Factor (dB)
 3. The other emission levels were very low against the limit.
 4. Margin value = Emission level – Limit value.



4.2.8 TEST RESULTS - DSSS (ANTENNA 1)

EUT	Flanker Pro Dual Radio AP	MODEL	AP-AG-AT-02
MODE	Channel 1	FREQUENCY RANGE	1000MHz~25000MHz
INPUT POWER (SYSTEM)	120Vac, 60Hz	DETECTOR FUNCTION	Peak(PK) Average (AV)
ENVIRONMENTAL CONDITIONS	23deg. C, 55%RH, 982 hPa	TESTED BY	Eric Lee

ANTENNA POLARITY & TEST DISTANCE: HORIZONTAL AT 3 M

No.	Freq. (MHz)	Emission Level (dBuV/m)	Limit (dBuV/m)	Margin (dB)	Antenna Height (m)	Table Angle (Degree)	Raw Value (dBuV)	Correction Factor (dB/m)
1	2016.00	47.30 PK	74.00	-26.70	1.22 H	212	18.10	29.20
2	2320.00	54.00 PK	74.00	-20.00	1.64 H	216	23.80	30.20
2	2320.00	47.30 AV	54.00	-6.70	1.64 H	216	17.10	30.20
3	2360.00	42.00 PK	74.00	-32.00	1.23 H	90	11.70	30.30
4	2387.00	52.70 PK	74.00	-21.30	1.35 H	250	22.30	30.40
4	2387.00	44.60 AV	54.00	-9.40	1.35 H	250	14.20	30.40
5	2390.00	56.20 PK	74.00	-17.80	1.52 H	360	25.80	30.40
5	2390.00	46.60 AV	54.00	-7.40	1.52 H	360	16.20	30.40
6	*2412.00	110.00 PK			1.01 H	20	79.50	30.50
6	*2412.00	101.20 AV			1.01 H	20	70.60	30.50
7	2496.00	45.40 PK	74.00	-28.60	1.29 H	154	14.60	30.80
8	4824.00	50.40 PK	74.00	-23.60	1.02 H	25	14.20	36.20
9	7236.00	45.40 PK	74.00	-28.60	1.01 H	26	3.80	41.70
10	9648.00	52.70 PK	74.00	-21.30	1.85 H	243	7.80	44.90
10	9648.00	40.80 AV	54.00	-13.20	1.85 H	243	-4.10	44.90

- NOTE:**
1. Emission level(dBuV/m)=Raw Value(dBuV) + Correction Factor(dB)
 2. Correction Factor(dB/m) = Antenna Factor (dB/m) + Cable Factor (dB)
 3. The other emission levels were very low against the limit.
 4. Margin value = Emission level – Limit value.
 5. The limit value is defined as per 15.247
 6. “ * “ : Fundamental frequency



EUT	Flanker Pro Dual Radio AP	MODEL	AP-AG-AT-02
MODE	Channel 1	FREQUENCY RANGE	1000MHz~25000MHz
INPUT POWER (SYSTEM)	120Vac, 60Hz	DETECTOR FUNCTION	Peak(PK) Average (AV)
ENVIRONMENTAL CONDITIONS	23deg. C, 55%RH, 982 hPa	TESTED BY	Eric Lee

ANTENNA POLARITY & TEST DISTANCE: VERTICAL AT 3 M

No.	Freq. (MHz)	Emission Level (dBuV/m)	Limit (dBuV/m)	Margin (dB)	Antenna Height (m)	Table Angle (Degree)	Raw Value (dBuV)	Correction Factor (dB/m)
1	2016.00	51.40 PK	74.00	-22.60	1.45 V	74	22.10	29.20
1	2016.00	49.00 AV	54.00	-5.00	1.45 V	74	19.80	29.20
2	2320.00	58.10 PK	74.00	-15.90	1.80 V	67	27.90	30.20
2	2320.00	52.50 AV	54.00	-1.50	1.80 V	67	22.30	30.20
3	2360.00	51.10 PK	74.00	-22.90	1.11 V	23	20.70	30.30
3	2360.00	42.80 AV	54.00	-11.20	1.11 V	23	12.50	30.30
4	2387.00	61.20 PK	74.00	-12.80	1.02 V	7	30.80	30.40
4	2387.00	51.00 AV	54.00	-3.00	1.02 V	7	20.60	30.40
5	2390.00	62.90 PK	74.00	-11.10	1.23 V	6	32.50	30.40
5	2390.00	53.50 AV	54.00	-0.50	1.23 V	6	23.10	30.40
6	*2412.00	114.10 PK			1.16 V	321	83.60	30.50
6	*2412.00	107.00 AV			1.16 V	321	76.50	30.50
7	2496.00	54.60 PK	74.00	-19.40	1.54 V	74	23.80	30.80
7	2496.00	42.30 AV	54.00	-11.70	1.54 V	74	11.60	30.80
8	4824.00	58.40 PK	74.00	-15.60	1.23 V	30	22.20	36.20
8	4824.00	49.40 AV	54.00	-4.60	1.23 V	30	13.20	36.20
9	7236.00	49.40 PK	74.00	-24.60	1.24 V	24	7.80	41.70
10	9648.00	53.40 PK	74.00	-20.60	1.45 V	2	8.50	44.90
10	9648.00	45.80 AV	54.00	-8.20	1.45 V	2	0.90	44.90

- NOTE:**
1. Emission level(dBuV/m)=Raw Value(dBuV) + Correction Factor(dB)
 2. Correction Factor(dB/m) = Antenna Factor (dB/m) + Cable Factor (dB)
 3. The other emission levels were very low against the limit.
 4. Margin value = Emission level – Limit value.
 5. The limit value is defined as per 15.247
 6. “ * “ : Fundamental frequency



EUT	Flanker Pro Dual Radio AP	MODEL	AP-AG-AT-02
MODE	Channel 6	FREQUENCY RANGE	1000MHz~25000MHz
INPUT POWER (SYSTEM)	120Vac, 60Hz	DETECTOR FUNCTION	Peak(PK) Average (AV)
ENVIRONMENTAL CONDITIONS	23deg. C, 55%RH, 982 hPa	TESTED BY	Eric Lee

ANTENNA POLARITY & TEST DISTANCE: HORIZONTAL AT 3 M

No.	Freq. (MHz)	Emission Level (dBuV/m)	Limit (dBuV/m)	Margin (dB)	Antenna Height (m)	Table Angle (Degree)	Raw Value (dBuV)	Correction Factor (dB/m)
1	2016.00	47.50 PK	74.00	-26.50	1.23 H	205	18.20	29.20
2	2320.00	58.00 PK	74.00	-16.00	1.11 H	25	27.80	30.20
2	2320.00	47.90 AV	54.00	-6.10	1.11 H	25	17.70	30.20
3	2360.00	42.10 PK	74.00	-31.90	1.25 H	24	11.80	30.30
4	2390.00	51.10 PK	74.00	-22.90	1.02 H	24	20.70	30.40
4	2390.00	39.10 AV	54.00	-14.90	1.02 H	24	8.70	30.40
5	*2437.00	110.90 PK			1.25 H	241	80.20	30.70
5	*2437.00	100.90 AV			1.25 H	241	70.20	30.70
6	2483.50	50.60 PK	74.00	-23.40	1.42 H	321	19.60	31.00
7	2496.00	45.30 PK	74.00	-28.70	1.25 H	47	14.60	30.80
8	4874.00	51.70 PK	74.00	-22.30	1.47 H	32	15.20	36.50
8	4874.00	40.70 AV	54.00	-13.30	1.47 H	32	4.20	36.50
9	7311.00	49.80 PK	74.00	-24.20	1.57 H	6	8.00	41.80
10	9748.00	49.20 PK	74.00	-24.80	1.45 H	24	4.60	44.60

- NOTE:**
1. Emission level(dBuV/m)=Raw Value(dBuV) + Correction Factor(dB)
 2. Correction Factor(dB/m) = Antenna Factor (dB/m) + Cable Factor (dB)
 3. The other emission levels were very low against the limit.
 4. Margin value = Emission level – Limit value.
 5. The limit value is defined as per 15.247
 6. “ * “ : Fundamental frequency



EUT	Flanker Pro Dual Radio AP	MODEL	AP-AG-AT-02
MODE	Channel 6	FREQUENCY RANGE	1000MHz~25000MHz
INPUT POWER (SYSTEM)	120Vac, 60Hz	DETECTOR FUNCTION	Peak(PK) Average (AV)
ENVIRONMENTAL CONDITIONS	23deg. C, 55%RH, 982 hPa	TESTED BY	Eric Lee

ANTENNA POLARITY & TEST DISTANCE: VERTICAL AT 3 M

No.	Freq. (MHz)	Emission Level (dBuV/m)	Limit (dBuV/m)	Margin (dB)	Antenna Height (m)	Table Angle (Degree)	Raw Value (dBuV)	Correction Factor (dB/m)
1	2016.00	51.10 PK	74.00	-22.90	1.02 V	307	21.90	29.20
1	2016.00	49.00 AV	54.00	-5.00	1.02 V	307	19.70	29.20
2	2320.00	64.20 PK	74.00	-9.80	1.29 V	154	34.00	30.20
2	2320.00	52.80 AV	54.00	-1.20	1.29 V	154	22.60	30.20
3	2360.00	49.40 PK	74.00	-24.60	1.52 V	20	19.00	30.30
4	2390.00	59.20 PK	74.00	-14.80	1.11 V	24	28.80	30.40
4	2390.00	47.20 AV	54.00	-6.80	1.11 V	24	16.80	30.40
5	*2437.00	114.70 PK			1.17 V	85	84.00	30.70
5	*2437.00	107.30 AV			1.17 V	85	76.60	30.70
6	2483.50	56.40 PK	74.00	-17.60	1.28 V	44	25.50	31.00
6	2483.50	46.30 AV	54.00	-7.70	1.28 V	44	15.30	31.00
7	2496.00	51.40 PK	74.00	-22.60	1.52 V	36	20.60	30.80
7	2496.00	40.70 AV	54.00	-13.30	1.52 V	36	9.90	30.80
8	4874.00	57.60 PK	74.00	-16.40	1.54 V	245	21.10	36.50
8	4874.00	49.30 AV	54.00	-4.70	1.54 V	245	12.90	36.50
9	7311.00	49.70 PK	74.00	-24.30	1.63 V	65	7.90	41.80
10	9748.00	53.40 PK	74.00	-20.60	1.63 V	52	8.70	44.60
10	9748.00	46.60 AV	54.00	-7.40	1.63 V	52	2.00	44.60

- NOTE:**
1. Emission level(dBuV/m)=Raw Value(dBuV) + Correction Factor(dB)
 2. Correction Factor(dB/m) = Antenna Factor (dB/m) + Cable Factor (dB)
 3. The other emission levels were very low against the limit.
 4. Margin value = Emission level – Limit value.
 5. The limit value is defined as per 15.247
 6. “ * “ : Fundamental frequency



EUT	Flanker Pro Dual Radio AP	MODEL	AP-AG-AT-02
MODE	Channel 11	FREQUENCY RANGE	1000MHz~25000MHz
INPUT POWER (SYSTEM)	120Vac, 60Hz	DETECTOR FUNCTION	Peak(PK) Average (AV)
ENVIRONMENTAL CONDITIONS	23deg. C, 55%RH, 982 hPa	TESTED BY	Eric Lee

ANTENNA POLARITY & TEST DISTANCE: HORIZONTAL AT 3M

No.	Freq. (MHz)	Emission Level (dBuV/m)	Limit (dBuV/m)	Margin (dB)	Antenna Height (m)	Table Angle (Degree)	Raw Value (dBuV)	Correction Factor (dB/m)
1	2016.00	48.40 PK	74.00	-25.60	1.45 H	201	19.10	29.20
2	2320.00	57.90 PK	74.00	-16.10	1.40 H	354	27.70	30.20
2	2320.00	52.90 AV	54.00	-1.10	1.40 H	354	22.70	30.20
3	2360.00	52.50 PK	74.00	-21.50	1.11 H	253	22.20	30.30
3	2360.00	44.10 AV	54.00	-9.90	1.11 H	253	13.70	30.30
4	*2462.00	111.20 PK			1.23 H	9	80.40	30.80
4	*2462.00	103.20 AV			1.23 H	9	72.30	30.80
5	2483.50	56.20 PK	74.00	-17.80	1.12 H	36	25.20	31.00
5	2483.50	46.30 AV	54.00	-7.70	1.12 H	36	15.40	31.00
6	2496.00	51.40 PK	74.00	-22.60	1.23 H	201	20.60	30.80
6	2496.00	42.40 AV	54.00	-11.60	1.23 H	201	11.60	30.80
7	4924.00	52.10 PK	74.00	-21.90	1.74 H	54	15.50	36.70
7	4924.00	43.20 AV	54.00	-10.80	1.74 H	54	6.50	36.70
8	7386.00	50.50 PK	74.00	-23.50	1.54 H	214	8.60	41.80
9	9848.00	52.40 PK	74.00	-21.60	1.54 H	24	8.00	44.40
9	9848.00	40.00 AV	54.00	-14.00	1.54 H	24	-4.30	44.40

- NOTE:**
1. Emission level(dBuV/m)=Raw Value(dBuV) + Correction Factor(dB)
 2. Correction Factor(dB/m) = Antenna Factor (dB/m) + Cable Factor (dB)
 3. The other emission levels were very low against the limit.
 4. Margin value = Emission level – Limit value.
 5. The limit value is defined as per 15.247
 6. “ * “ : Fundamental frequency



EUT	Flanker Pro Dual Radio AP	MODEL	AP-AG-AT-02
MODE	Channel 11	FREQUENCY RANGE	1000MHz~25000MHz
INPUT POWER (SYSTEM)	120Vac, 60Hz	DETECTOR FUNCTION	Peak(PK) Average (AV)
ENVIRONMENTAL CONDITIONS	23deg. C, 55%RH, 982 hPa	TESTED BY	Eric Lee

ANTENNA POLARITY & TEST DISTANCE: VERTICAL AT 3M

No.	Freq. (MHz)	Emission Level (dBuV/m)	Limit (dBuV/m)	Margin (dB)	Antenna Height (m)	Table Angle (Degree)	Raw Value (dBuV)	Correction Factor (dB/m)
1	2016.00	52.30 PK	74.00	-21.70	1.02 V	47	23.00	29.20
1	2016.00	50.60 AV	54.00	-3.40	1.02 V	47	21.30	29.20
2	2320.00	64.30 PK	74.00	-9.70	1.13 V	12	34.10	30.20
2	2320.00	53.90 AV	54.00	-0.10	1.13 V	12	23.70	30.20
3	2360.00	60.30 PK	74.00	-13.70	1.24 V	54	30.00	30.30
3	2360.00	52.10 AV	54.00	-1.90	1.24 V	54	21.80	30.30
4	*2462.00	118.40 PK			1.25 V	47	87.50	30.80
4	*2462.00	109.40 AV			1.25 V	47	78.60	30.80
5	2483.50	64.20 PK	74.00	-9.80	1.40 V	29	33.30	31.00
5	2483.50	53.20 AV	54.00	-0.80	1.40 V	29	22.20	31.00
6	2496.00	61.30 PK	74.00	-12.70	1.23 V	6	30.50	30.80
6	2496.00	50.70 AV	54.00	-3.30	1.23 V	6	20.00	30.80
7	4924.00	59.60 PK	74.00	-14.40	1.16 V	321	22.90	36.70
7	4924.00	49.80 AV	54.00	-4.20	1.16 V	321	13.10	36.70
8	7386.00	49.90 PK	74.00	-24.10	1.36 V	65	8.00	41.80
9	9848.00	52.00 PK	74.00	-22.00	1.52 V	320	7.60	44.40
9	9848.00	45.30 AV	54.00	-8.70	1.52 V	320	1.00	44.40

- NOTE:**
1. Emission level(dBuV/m)=Raw Value(dBuV) + Correction Factor(dB)
 2. Correction Factor(dB/m) = Antenna Factor (dB/m) + Cable Factor (dB)
 3. The other emission levels were very low against the limit.
 4. Margin value = Emission level – Limit value.
 5. The limit value is defined as per 15.247
 6. “ * “ : Fundamental frequency



4.2.9 TEST RESULTS - DSSS (ANTENNA 2)

EUT	Flanker Pro Dual Radio AP	MODEL	AP-AG-AT-02
MODE	Channel 1	FREQUENCY RANGE	1000MHz~25000MHz
INPUT POWER (SYSTEM)	120Vac, 60Hz	DETECTOR FUNCTION	Peak(PK) Average (AV)
ENVIRONMENTAL CONDITIONS	24deg. C, 60%RH, 982 hPa	TESTED BY	Eric Lee

ANTENNA POLARITY & TEST DISTANCE: HORIZONTAL AT 3 M

No.	Freq. (MHz)	Emission Level (dBuV/m)	Limit (dBuV/m)	Margin (dB)	Antenna Height (m)	Table Angle (Degree)	Raw Value (dBuV)	Correction Factor (dB/m)
1	2016.00	50.40 PK	74.00	-23.60	1.02 H	47	21.20	29.20
2	2320.00	55.30 PK	74.00	-18.70	1.68 H	96	25.10	30.20
2	2320.00	44.80 AV	54.00	-9.20	1.68 H	96	14.60	30.20
3	2360.00	50.00 PK	74.00	-24.00	1.53 H	62	19.60	30.30
4	2387.00	55.20 PK	74.00	-18.80	1.09 H	73	24.80	30.40
4	2387.00	44.10 AV	54.00	-9.90	1.09 H	73	13.70	30.40
5	2390.00	56.80 PK	74.00	-17.20	1.11 H	54	26.40	30.40
5	2390.00	47.00 AV	54.00	-7.00	1.11 H	54	16.60	30.40
6	*2412.00	110.10 PK			1.14 H	54	79.60	30.50
6	*2412.00	101.70 AV			1.14 H	54	71.20	30.50
7	2490.00	48.60 PK	74.00	-25.40	1.56 H	202	17.70	30.90
8	4824.00	50.80 PK	74.00	-23.20	1.65 H	24	14.60	36.20
9	7236.00	46.40 PK	74.00	-27.60	1.59 H	353	4.70	41.70
10	9648.00	49.70 PK	74.00	-24.30	1.36 H	87	4.80	44.90

- NOTE:**
1. Emission level(dBuV/m)=Raw Value(dBuV) + Correction Factor(dB)
 2. Correction Factor(dB/m) = Antenna Factor (dB/m) + Cable Factor (dB)
 3. The other emission levels were very low against the limit.
 4. Margin value = Emission level – Limit value.
 5. The limit value is defined as per 15.247
 6. “ * “ : Fundamental frequency



EUT	Flanker Pro Dual Radio AP	MODEL	AP-AG-AT-02
MODE	Channel 1	FREQUENCY RANGE	1000MHz~25000MHz
INPUT POWER (SYSTEM)	120Vac, 60Hz	DETECTOR FUNCTION	Peak(PK) Average (AV)
ENVIRONMENTAL CONDITIONS	24deg. C, 60%RH, 982 hPa	TESTED BY	Eric Lee

ANTENNA POLARITY & TEST DISTANCE: VERTICAL AT 3 M

No.	Freq. (MHz)	Emission Level (dBuV/m)	Limit (dBuV/m)	Margin (dB)	Antenna Height (m)	Table Angle (Degree)	Raw Value (dBuV)	Correction Factor (dB/m)
1	2016.00	54.70 PK	74.00	-19.30	1.47 V	54	25.50	29.20
1	2016.00	52.30 AV	54.00	-1.70	1.47 V	54	23.10	29.20
2	2320.00	59.00 PK	74.00	-15.00	1.10 V	316	28.80	30.20
2	2320.00	47.70 AV	54.00	-6.30	1.10 V	316	17.50	30.20
3	2360.00	54.80 PK	74.00	-19.20	1.35 V	24	24.50	30.30
3	2360.00	44.60 AV	54.00	-9.40	1.35 V	24	14.30	30.30
4	2387.00	57.60 PK	74.00	-16.40	1.36 V	54	27.20	30.40
4	2387.00	48.30 AV	54.00	-5.70	1.36 V	54	17.90	30.40
5	2390.00	60.00 PK	74.00	-14.00	1.02 V	35	29.60	30.40
5	2390.00	49.20 AV	54.00	-4.80	1.02 V	35	18.80	30.40
6	*2412.00	112.70 PK			1.42 V	14	82.10	30.50
6	*2412.00	105.50 AV			1.42 V	14	74.90	30.50
7	2490.00	55.20 PK	74.00	-18.80	1.01 V	347	24.40	30.90
7	2490.00	44.00 AV	54.00	-10.00	1.01 V	347	13.20	30.90
8	4824.00	57.40 PK	74.00	-16.60	1.01 V	35	21.20	36.20
8	4824.00	47.20 AV	54.00	-6.80	1.01 V	35	11.00	36.20
9	7236.00	49.40 PK	74.00	-24.60	1.45 V	24	7.80	41.70
10	9648.00	52.30 PK	74.00	-21.70	1.57 V	54	7.40	44.90
10	9648.00	44.60 AV	54.00	-9.40	1.57 V	54	-0.30	44.90

- NOTE:**
1. Emission level(dBuV/m)=Raw Value(dBuV) + Correction Factor(dB)
 2. Correction Factor(dB/m) = Antenna Factor (dB/m) + Cable Factor (dB)
 3. The other emission levels were very low against the limit.
 4. Margin value = Emission level – Limit value.
 5. The limit value is defined as per 15.247
 6. “ * “ : Fundamental frequency



EUT	Flanker Pro Dual Radio AP	MODEL	AP-AG-AT-02
MODE	Channel 6	FREQUENCY RANGE	1000MHz~25000MHz
INPUT POWER (SYSTEM)	120Vac, 60Hz	DETECTOR FUNCTION	Peak(PK) Average (AV)
ENVIRONMENTAL CONDITIONS	24deg. C, 60%RH, 982 hPa	TESTED BY	Eric Lee

ANTENNA POLARITY & TEST DISTANCE: HORIZONTAL AT 3 M

No.	Freq. (MHz)	Emission Level (dBuV/m)	Limit (dBuV/m)	Margin (dB)	Antenna Height (m)	Table Angle (Degree)	Raw Value (dBuV)	Correction Factor (dB/m)
1	2016.00	51.80 PK	74.00	-22.20	1.32 H	52	22.50	29.20
1	2016.00	49.50 AV	54.00	-4.50	1.32 H	52	20.20	29.20
2	2320.00	56.40 PK	74.00	-17.60	1.11 H	24	26.20	30.20
2	2320.00	43.90 AV	54.00	-10.10	1.11 H	24	13.70	30.20
3	2360.00	51.20 PK	74.00	-22.80	1.54 H	74	20.90	30.30
3	2360.00	39.40 AV	54.00	-14.60	1.54 H	74	9.10	30.30
4	2390.00	60.90 PK	74.00	-13.10	1.03 H	9	30.50	30.40
4	2390.00	40.90 AV	54.00	-13.10	1.03 H	9	10.50	30.40
5	*2437.00	109.70 PK			1.11 H	52	79.00	30.70
5	*2437.00	101.70 AV			1.11 H	52	71.00	30.70
6	2483.50	61.60 PK	74.00	-12.40	1.52 H	52	30.60	31.00
6	2483.50	39.60 AV	54.00	-14.40	1.52 H	52	8.60	31.00
7	2496.00	47.40 PK	74.00	-26.60	1.46 H	63	16.60	30.80
8	4874.00	50.70 PK	74.00	-23.30	1.33 H	62	14.20	36.50
9	7311.00	47.00 PK	74.00	-27.00	1.63 H	54	5.20	41.80
10	9748.00	50.30 PK	74.00	-23.70	1.63 H	32	5.70	44.60

- NOTE:**
1. Emission level(dBuV/m)=Raw Value(dBuV) + Correction Factor(dB)
 2. Correction Factor(dB/m) = Antenna Factor (dB/m) + Cable Factor (dB)
 3. The other emission levels were very low against the limit.
 4. Margin value = Emission level – Limit value.
 5. The limit value is defined as per 15.247
 6. “ * “ : Fundamental frequency



EUT	Flanker Pro Dual Radio AP	MODEL	AP-AG-AT-02
MODE	Channel 6	FREQUENCY RANGE	1000MHz~25000MHz
INPUT POWER (SYSTEM)	120Vac, 60Hz	DETECTOR FUNCTION	Peak(PK) Average (AV)
ENVIRONMENTAL CONDITIONS	24deg. C, 60%RH, 982 hPa	TESTED BY	Eric Lee

ANTENNA POLARITY & TEST DISTANCE: VERTICAL AT 3 M

No.	Freq. (MHz)	Emission Level (dBuV/m)	Limit (dBuV/m)	Margin (dB)	Antenna Height (m)	Table Angle (Degree)	Raw Value (dBuV)	Correction Factor (dB/m)
1	2016.00	54.50 PK	74.00	-19.50	1.65 V	32	25.20	29.20
1	2016.00	51.40 AV	54.00	-2.60	1.65 V	32	22.10	29.20
2	2320.00	58.50 PK	74.00	-15.50	1.54 V	74	28.30	30.20
2	2320.00	46.90 AV	54.00	-7.10	1.54 V	74	16.70	30.20
3	2360.00	57.10 PK	74.00	-16.90	1.66 V	35	26.80	30.30
3	2360.00	43.10 AV	54.00	-10.90	1.66 V	35	12.80	30.30
4	2390.00	63.20 PK	74.00	-10.80	1.02 V	47	32.80	30.40
4	2390.00	49.00 AV	54.00	-5.00	1.02 V	47	18.60	30.40
5	*2437.00	112.80 PK			1.41 V	24	82.10	30.70
5	*2437.00	105.30 AV			1.41 V	24	74.60	30.70
6	2483.50	62.30 PK	74.00	-11.70	1.14 V	63	31.30	31.00
6	2483.50	49.90 AV	54.00	-4.10	1.14 V	63	18.90	31.00
7	2496.00	56.80 PK	74.00	-17.20	1.25 V	85	26.00	30.80
7	2496.00	44.40 AV	54.00	-9.60	1.25 V	85	13.60	30.80
8	4874.00	59.30 PK	74.00	-14.70	1.53 V	6	22.90	36.50
8	4874.00	47.70 AV	54.00	-6.30	1.53 V	6	11.20	36.50
9	7311.00	51.00 PK	74.00	-23.00	1.55 V	55	9.30	41.80
9	7311.00	41.00 AV	54.00	-13.00	1.55 V	55	-0.80	41.80
10	9748.00	54.00 PK	74.00	-20.00	1.02 V	301	9.40	44.60
10	9748.00	45.70 AV	54.00	-8.30	1.02 V	301	1.10	44.60

- NOTE:**
1. Emission level(dBuV/m)=Raw Value(dBuV) + Correction Factor(dB)
 2. Correction Factor(dB/m) = Antenna Factor (dB/m) + Cable Factor (dB)
 3. The other emission levels were very low against the limit.
 4. Margin value = Emission level – Limit value.
 5. The limit value is defined as per 15.247
 6. “ * “ : Fundamental frequency



EUT	Flanker Pro Dual Radio AP	MODEL	AP-AG-AT-02
MODE	Channel 11	FREQUENCY RANGE	1000MHz~25000MHz
INPUT POWER (SYSTEM)	120Vac, 60Hz	DETECTOR FUNCTION	Peak(PK) Average (AV)
ENVIRONMENTAL CONDITIONS	24deg. C, 60%RH, 982 hPa	TESTED BY	Eric Lee

ANTENNA POLARITY & TEST DISTANCE: HORIZONTAL AT 3M

No.	Freq. (MHz)	Emission Level (dBuV/m)	Limit (dBuV/m)	Margin (dB)	Antenna Height (m)	Table Angle (Degree)	Raw Value (dBuV)	Correction Factor (dB/m)
1	2016.00	52.10 PK	74.00	-21.90	1.00 H	333	22.90	29.20
1	2016.00	49.50 AV	54.00	-4.50	1.00 H	333	20.20	29.20
2	2320.00	55.90 PK	74.00	-18.10	1.42 H	301	25.70	30.20
2	2320.00	45.00 AV	54.00	-9.00	1.42 H	301	14.80	30.20
3	2360.00	51.50 PK	74.00	-22.50	1.76 H	62	21.10	30.30
3	2360.00	42.80 AV	54.00	-11.20	1.76 H	62	12.50	30.30
4	*2462.00	109.20 PK			1.25 H	35	78.30	30.80
4	*2462.00	101.10 AV			1.25 H	35	70.30	30.80
5	2483.50	55.20 PK	74.00	-18.80	1.02 H	47	24.30	31.00
5	2483.50	46.30 AV	54.00	-7.70	1.02 H	47	15.30	31.00
6	2496.00	50.10 PK	74.00	-23.90	1.47 H	56	19.30	30.80
7	4924.00	50.80 PK	74.00	-23.20	1.53 H	62	14.10	36.70
8	7386.00	46.80 PK	74.00	-27.20	1.02 H	47	4.90	41.80
9	9848.00	50.00 PK	74.00	-24.00	1.02 H	47	5.60	44.40

- NOTE:**
1. Emission level(dBuV/m)=Raw Value(dBuV) + Correction Factor(dB)
 2. Correction Factor(dB/m) = Antenna Factor (dB/m) + Cable Factor (dB)
 3. The other emission levels were very low against the limit.
 4. Margin value = Emission level – Limit value.
 5. The limit value is defined as per 15.247
 6. “ * “ : Fundamental frequency



EUT	Flanker Pro Dual Radio AP	MODEL	AP-AG-AT-02
MODE	Channel 11	FREQUENCY RANGE	1000MHz~25000MHz
INPUT POWER (SYSTEM)	120Vac, 60Hz	DETECTOR FUNCTION	Peak(PK) Average (AV)
ENVIRONMENTAL CONDITIONS	24deg. C, 60%RH, 982 hPa	TESTED BY	Eric Lee

ANTENNA POLARITY & TEST DISTANCE: VERTICAL AT 3M

No.	Freq. (MHz)	Emission Level (dBuV/m)	Limit (dBuV/m)	Margin (dB)	Antenna Height (m)	Table Angle (Degree)	Raw Value (dBuV)	Correction Factor (dB/m)
1	2016.00	56.20 PK	74.00	-17.80	1.01 V	325	26.90	29.20
2	2320.00	60.10 PK	74.00	-13.90	1.54 V	74	29.90	30.20
2	2320.00	49.70 AV	54.00	-4.30	1.54 V	74	19.50	30.20
3	2360.00	55.40 PK	74.00	-18.60	1.72 V	28	25.10	30.30
3	2360.00	46.30 AV	54.00	-7.70	1.72 V	28	15.90	30.30
4	*2462.00	112.80 PK			1.02 V	268	82.00	30.80
4	*2462.00	104.80 AV			1.02 V	268	74.00	30.80
5	2483.50	60.20 PK	74.00	-13.80	1.60 V	24	29.30	31.00
5	2483.50	50.60 AV	54.00	-3.40	1.60 V	24	19.60	31.00
6	2496.00	58.80 PK	74.00	-15.20	1.11 V	47	28.00	30.80
6	2496.00	45.80 AV	54.00	-8.20	1.11 V	47	15.00	30.80
7	4924.00	57.90 PK	74.00	-16.10	1.36 V	52	21.20	36.70
7	4924.00	48.80 AV	54.00	-5.20	1.36 V	52	12.10	36.70
8	7386.00	50.90 PK	74.00	-23.10	1.02 V	14	9.00	41.80
9	9848.00	53.00 PK	74.00	-21.00	1.36 V	9	8.60	44.40
9	9848.00	43.10 AV	54.00	-10.90	1.36 V	9	-1.30	44.40

- NOTE:**
1. Emission level(dBuV/m)=Raw Value(dBuV) + Correction Factor(dB)
 2. Correction Factor(dB/m) = Antenna Factor (dB/m) + Cable Factor (dB)
 3. The other emission levels were very low against the limit.
 4. Margin value = Emission level – Limit value.
 5. The limit value is defined as per 15.247
 6. “ * “ : Fundamental frequency



4.2.10 TEST RESULTS - DSSS (ANTENNA 3)

EUT	Flanker Pro Dual Radio AP	MODEL	AP-AG-AT-02
MODE	Channel 1	FREQUENCY RANGE	1000MHz~25000MHz
INPUT POWER (SYSTEM)	120Vac, 60Hz	DETECTOR FUNCTION	Peak(PK) Average (AV)
ENVIRONMENTAL CONDITIONS	23deg. C, 55%RH, 982 hPa	TESTED BY	Eric Lee

ANTENNA POLARITY & TEST DISTANCE: HORIZONTAL AT 3 M

No.	Freq. (MHz)	Emission Level (dBuV/m)	Limit (dBuV/m)	Margin (dB)	Antenna Height (m)	Table Angle (Degree)	Raw Value (dBuV)	Correction Factor (dB/m)
1	2016.00	43.70 PK	74.00	-30.30	1.43 H	60	14.50	29.20
2	2360.00	50.30 PK	74.00	-23.70	1.02 H	201	20.00	30.30
3	2387.00	53.30 PK	74.00	-20.70	1.00 H	258	22.90	30.40
3	2387.00	42.00 AV	54.00	-12.00	1.00 H	258	11.60	30.40
4	2390.00	55.20 PK	74.00	-18.80	1.02 H	2	24.80	30.40
4	2390.00	44.00 AV	54.00	-10.00	1.02 H	2	13.60	30.40
5	*2412.00	108.00 PK			1.50 H	111	77.50	30.50
5	*2412.00	99.40 AV			1.50 H	111	68.90	30.50
6	4824.00	54.00 PK	74.00	-20.00	1.07 H	85	17.80	36.20
6	4824.00	43.00 AV	54.00	-11.00	1.07 H	85	6.80	36.20
7	7236.00	46.80 PK	74.00	-27.20	1.55 H	52	5.20	41.70
8	9648.00	45.60 PK	74.00	-28.40	1.02 H	20	0.70	44.90

- NOTE:**
1. Emission level(dBuV/m)=Raw Value(dBuV) + Correction Factor(dB)
 2. Correction Factor(dB/m) = Antenna Factor (dB/m) + Cable Factor (dB)
 3. The other emission levels were very low against the limit.
 4. Margin value = Emission level – Limit value.
 5. The limit value is defined as per 15.247
 6. “ * “ : Fundamental frequency



EUT	Flanker Pro Dual Radio AP	MODEL	AP-AG-AT-02
MODE	Channel 1	FREQUENCY RANGE	1000MHz~25000MHz
INPUT POWER (SYSTEM)	120Vac, 60Hz	DETECTOR FUNCTION	Peak(PK) Average (AV)
ENVIRONMENTAL CONDITIONS	23deg. C, 55%RH, 982 hPa	TESTED BY	Eric Lee

ANTENNA POLARITY & TEST DISTANCE: VERTICAL AT 3 M

No.	Freq. (MHz)	Emission Level (dBuV/m)	Limit (dBuV/m)	Margin (dB)	Antenna Height (m)	Table Angle (Degree)	Raw Value (dBuV)	Correction Factor (dB/m)
1	2016.00	45.70 PK	74.00	-28.30	1.23 V	32	16.40	29.20
2	2360.00	54.10 PK	74.00	-19.90	1.23 V	302	23.80	30.30
2	2360.00	43.30 AV	54.00	-10.70	1.23 V	302	12.90	30.30
3	2387.00	52.20 PK	74.00	-21.80	1.28 V	9	21.80	30.40
3	2387.00	42.60 AV	54.00	-11.40	1.28 V	9	12.20	30.40
4	2390.00	55.20 PK	74.00	-18.80	1.02 V	74	24.80	30.40
4	2390.00	45.60 AV	54.00	-8.40	1.02 V	74	15.20	30.40
5	*2412.00	106.60 PK			1.52 V	201	76.10	30.50
5	*2412.00	99.30 AV			1.52 V	201	68.70	30.50
6	4824.00	59.40 PK	74.00	-14.60	1.02 V	326	23.20	36.20
6	4824.00	48.50 AV	54.00	-5.50	1.02 V	326	12.20	36.20
7	7236.00	49.20 PK	74.00	-24.80	1.02 V	5	7.60	41.70
8	9648.00	53.30 PK	74.00	-20.70	1.23 V	333	8.40	44.90
8	9648.00	47.40 AV	54.00	-6.60	1.23 V	333	2.50	44.90

- NOTE:**
1. Emission level(dBuV/m)=Raw Value(dBuV) + Correction Factor(dB)
 2. Correction Factor(dB/m) = Antenna Factor (dB/m) + Cable Factor (dB)
 3. The other emission levels were very low against the limit.
 4. Margin value = Emission level – Limit value.
 5. The limit value is defined as per 15.247
 6. “ * “ : Fundamental frequency



EUT	Flanker Pro Dual Radio AP	MODEL	AP-AG-AT-02
MODE	Channel 6	FREQUENCY RANGE	1000MHz~25000MHz
INPUT POWER (SYSTEM)	120Vac, 60Hz	DETECTOR FUNCTION	Peak(PK) Average (AV)
ENVIRONMENTAL CONDITIONS	23deg. C, 55%RH, 982 hPa	TESTED BY	Eric Lee

ANTENNA POLARITY & TEST DISTANCE: HORIZONTAL AT 3 M

No.	Freq. (MHz)	Emission Level (dBuV/m)	Limit (dBuV/m)	Margin (dB)	Antenna Height (m)	Table Angle (Degree)	Raw Value (dBuV)	Correction Factor (dB/m)
1	2016.00	44.10 PK	74.00	-29.90	1.11 H	236	14.90	29.20
2	2320.00	48.40 PK	74.00	-25.60	1.32 H	62	18.20	30.20
3	2390.00	52.20 PK	74.00	-21.80	1.15 H	11	21.80	30.40
3	2390.00	39.90 AV	54.00	-14.10	1.15 H	11	9.50	30.40
4	*2437.00	107.30 PK			1.54 H	245	76.60	30.70
4	*2437.00	98.60 AV			1.54 H	245	67.90	30.70
5	2483.50	52.60 PK	74.00	-21.40	1.76 H	3	21.60	31.00
5	2483.50	41.60 AV	54.00	-12.40	1.76 H	3	10.60	31.00
6	4874.00	53.60 PK	74.00	-20.40	1.68 H	9	17.10	36.50
6	4874.00	44.50 AV	54.00	-9.50	1.68 H	9	8.10	36.50
7	7311.00	47.60 PK	74.00	-26.40	1.02 H	302	5.90	41.80
8	9748.00	46.60 PK	74.00	-27.40	1.11 H	47	2.00	44.60

- NOTE:**
1. Emission level(dBuV/m)=Raw Value(dBuV) + Correction Factor(dB)
 2. Correction Factor(dB/m) = Antenna Factor (dB/m) + Cable Factor (dB)
 3. The other emission levels were very low against the limit.
 4. Margin value = Emission level – Limit value.
 5. The limit value is defined as per 15.247
 6. “ * “ : Fundamental frequency



EUT	Flanker Pro Dual Radio AP	MODEL	AP-AG-AT-02
MODE	Channel 6	FREQUENCY RANGE	1000MHz~25000MHz
INPUT POWER (SYSTEM)	120Vac, 60Hz	DETECTOR FUNCTION	Peak(PK) Average (AV)
ENVIRONMENTAL CONDITIONS	23deg. C, 55%RH, 982 hPa	TESTED BY	Eric Lee

ANTENNA POLARITY & TEST DISTANCE: VERTICAL AT 3 M

No.	Freq. (MHz)	Emission Level (dBuV/m)	Limit (dBuV/m)	Margin (dB)	Antenna Height (m)	Table Angle (Degree)	Raw Value (dBuV)	Correction Factor (dB/m)
1	2016.00	46.40 PK	74.00	-27.60	1.69 V	65	17.10	29.20
2	2320.00	56.80 PK	74.00	-17.20	1.45 V	20	26.60	30.20
2	2320.00	40.40 AV	54.00	-13.60	1.45 V	20	10.20	30.20
3	2360.00	57.60 PK	74.00	-16.40	1.02 V	54	27.30	30.30
3	2360.00	41.60 AV	54.00	-12.40	1.02 V	54	11.20	30.30
4	2390.00	61.10 PK	74.00	-12.90	1.57 V	216	30.70	30.40
4	2390.00	47.40 AV	54.00	-6.60	1.57 V	216	17.00	30.40
5	*2437.00	109.30 PK			1.02 V	241	78.60	30.70
5	*2437.00	100.20 AV			1.02 V	241	69.60	30.70
6	2483.50	62.30 PK	74.00	-11.70	1.54 V	247	31.30	31.00
6	2483.50	49.90 AV	54.00	-4.10	1.54 V	247	18.90	31.00
7	4874.00	59.30 PK	74.00	-14.70	1.25 V	326	22.90	36.50
7	4874.00	49.60 AV	54.00	-4.40	1.25 V	326	13.10	36.50
8	7311.00	50.70 PK	74.00	-23.30	1.20 V	201	8.90	41.80
9	9748.00	54.60 PK	74.00	-19.40	1.63 V	320	10.00	44.60
9	9748.00	47.30 AV	54.00	-6.70	1.63 V	320	2.70	44.60

- NOTE:**
1. Emission level(dBuV/m)=Raw Value(dBuV) + Correction Factor(dB)
 2. Correction Factor(dB/m) = Antenna Factor (dB/m) + Cable Factor (dB)
 3. The other emission levels were very low against the limit.
 4. Margin value = Emission level – Limit value.
 5. The limit value is defined as per 15.247
 6. " * " : Fundamental frequency



EUT	Flanker Pro Dual Radio AP	MODEL	AP-AG-AT-02
MODE	Channel 11	FREQUENCY RANGE	1000MHz~25000MHz
INPUT POWER (SYSTEM)	120Vac, 60Hz	DETECTOR FUNCTION	Peak(PK) Average (AV)
ENVIRONMENTAL CONDITIONS	23deg. C, 55%RH, 982 hPa	TESTED BY	Eric Lee

ANTENNA POLARITY & TEST DISTANCE: HORIZONTAL AT 3M

No.	Freq. (MHz)	Emission Level (dBuV/m)	Limit (dBuV/m)	Margin (dB)	Antenna Height (m)	Table Angle (Degree)	Raw Value (dBuV)	Correction Factor (dB/m)
1	2016.00	46.40 PK	74.00	-27.60	1.65 H	85	17.20	29.20
2	2320.00	49.90 PK	74.00	-24.10	1.02 H	306	19.70	30.20
3	2360.00	49.90 PK	74.00	-24.10	1.44 H	12	19.50	30.30
4	*2462.00	106.50 PK			1.40 H	203	75.70	30.80
4	*2462.00	99.00 AV			1.40 H	203	68.20	30.80
5	2483.50	51.20 PK	74.00	-22.80	1.52 H	62	20.30	31.00
5	2483.50	43.20 AV	54.00	-10.80	1.52 H	62	12.30	31.00
6	4924.00	50.60 PK	74.00	-23.40	1.10 H	200	13.90	36.70
7	7386.00	48.20 PK	74.00	-25.80	1.11 H	222	6.40	41.80
8	9848.00	45.30 PK	74.00	-28.70	1.00 H	354	1.00	44.40

- NOTE:**
1. Emission level(dBuV/m)=Raw Value(dBuV) + Correction Factor(dB)
 2. Correction Factor(dB/m) = Antenna Factor (dB/m) + Cable Factor (dB)
 3. The other emission levels were very low against the limit.
 4. Margin value = Emission level – Limit value.
 5. The limit value is defined as per 15.247
 6. “ * “ : Fundamental frequency



EUT	Flanker Pro Dual Radio AP	MODEL	AP-AG-AT-02
MODE	Channel 11	FREQUENCY RANGE	1000MHz~25000MHz
INPUT POWER (SYSTEM)	120Vac, 60Hz	DETECTOR FUNCTION	Peak(PK) Average (AV)
ENVIRONMENTAL CONDITIONS	23deg. C, 55%RH, 982 hPa	TESTED BY	Eric Lee

ANTENNA POLARITY & TEST DISTANCE: VERTICAL AT 3M

No.	Freq. (MHz)	Emission Level (dBuV/m)	Limit (dBuV/m)	Margin (dB)	Antenna Height (m)	Table Angle (Degree)	Raw Value (dBuV)	Correction Factor (dB/m)
1	2016.00	48.80 PK	74.00	-25.20	1.20 V	20	19.60	29.20
2	2320.00	55.40 PK	74.00	-18.60	1.11 V	2	25.20	30.20
2	2320.00	41.40 AV	54.00	-12.60	1.11 V	2	11.20	30.20
3	2360.00	57.80 PK	74.00	-16.20	1.53 V	6	27.50	30.30
3	2360.00	42.90 AV	54.00	-11.10	1.53 V	6	12.50	30.30
4	*2462.00	109.00 PK			1.20 V	24	78.20	30.80
4	*2462.00	100.80 AV			1.20 V	24	70.00	30.80
5	2483.50	53.70 PK	74.00	-20.30	1.52 V	2	22.70	31.00
5	2483.50	45.20 AV	54.00	-8.80	1.52 V	2	14.20	31.00
6	4924.00	58.90 PK	74.00	-15.10	1.37 V	85	22.20	36.70
6	4924.00	48.90 AV	54.00	-5.10	1.37 V	85	12.20	36.70
7	7386.00	51.20 PK	74.00	-22.80	1.54 V	243	9.30	41.80
7	7386.00	38.90 AV	54.00	-15.10	1.54 V	243	-3.00	41.80
8	9848.00	53.40 PK	74.00	-20.60	1.40 V	201	9.00	44.40
8	9848.00	46.40 AV	54.00	-7.60	1.40 V	201	2.00	44.40

- NOTE:**
1. Emission level(dBuV/m)=Raw Value(dBuV) + Correction Factor(dB)
 2. Correction Factor(dB/m) = Antenna Factor (dB/m) + Cable Factor (dB)
 3. The other emission levels were very low against the limit.
 4. Margin value = Emission level – Limit value.
 5. The limit value is defined as per 15.247
 6. “ * “ : Fundamental frequency



4.2.11 TEST RESULTS - DSSS (ANTENNA 4)

EUT	Flanker Pro Dual Radio AP	MODEL	AP-AG-AT-02
MODE	Channel 1	FREQUENCY RANGE	1000MHz~25000MHz
INPUT POWER (SYSTEM)	120Vac, 60Hz	DETECTOR FUNCTION	Peak(PK) Average (AV)
ENVIRONMENTAL CONDITIONS	23deg. C, 55%RH, 982 hPa	TESTED BY	Eric Lee

ANTENNA POLARITY & TEST DISTANCE: HORIZONTAL AT 3 M

No.	Freq. (MHz)	Emission Level (dBuV/m)	Limit (dBuV/m)	Margin (dB)	Antenna Height (m)	Table Angle (Degree)	Raw Value (dBuV)	Correction Factor (dB/m)
1	2016.00	54.80 PK	74.00	-19.20	1.65 H	326	25.50	29.20
1	2016.00	50.10 AV	54.00	-3.90	1.65 H	326	20.90	29.20
2	2292.00	50.80 PK	74.00	-23.20	1.36 H	35	20.70	30.10
3	2360.00	50.40 PK	74.00	-23.60	1.02 H	54	20.10	30.30
4	2387.00	49.50 PK	74.00	-24.50	1.11 H	3	19.10	30.40
5	2390.00	52.30 PK	74.00	-21.70	1.43 H	62	21.90	30.40
5	2390.00	42.30 AV	54.00	-11.70	1.43 H	62	11.90	30.40
6	*2412.00	105.10 PK			1.54 H	24	74.60	30.50
6	*2412.00	97.10 AV			1.54 H	24	66.50	30.50
7	4824.00	47.50 PK	74.00	-26.50	1.02 H	306	11.30	36.20
8	7236.00	47.80 PK	74.00	-26.20	1.02 H	33	6.20	41.70
9	9648.00	47.10 PK	74.00	-26.90	1.12 H	325	2.20	44.90

- NOTE:**
1. Emission level(dBuV/m)=Raw Value(dBuV) + Correction Factor(dB)
 2. Correction Factor(dB/m) = Antenna Factor (dB/m) + Cable Factor (dB)
 3. The other emission levels were very low against the limit.
 4. Margin value = Emission level – Limit value.
 5. The limit value is defined as per 15.247
 6. “ * “ : Fundamental frequency



EUT	Flanker Pro Dual Radio AP	MODEL	AP-AG-AT-02
MODE	Channel 1	FREQUENCY RANGE	1000MHz~25000MHz
INPUT POWER (SYSTEM)	120Vac, 60Hz	DETECTOR FUNCTION	Peak(PK) Average (AV)
ENVIRONMENTAL CONDITIONS	23deg. C, 55%RH, 982 hPa	TESTED BY	Eric Lee

ANTENNA POLARITY & TEST DISTANCE: VERTICAL AT 3 M

No.	Freq. (MHz)	Emission Level (dBuV/m)	Limit (dBuV/m)	Margin (dB)	Antenna Height (m)	Table Angle (Degree)	Raw Value (dBuV)	Correction Factor (dB/m)
1	2016.00	55.30 PK	74.00	-18.70	1.64 V	4	26.10	29.20
1	2016.00	52.10 AV	54.00	-1.90	1.64 V	4	22.90	29.20
2	2292.00	59.90 PK	74.00	-14.10	1.31 V	1	29.80	30.10
2	2292.00	51.90 AV	54.00	-2.10	1.31 V	1	21.80	30.10
3	2360.00	56.10 PK	74.00	-17.90	1.36 V	26	25.70	30.30
3	2360.00	45.50 AV	54.00	-8.50	1.36 V	26	15.20	30.30
4	2387.00	58.60 PK	74.00	-15.40	1.78 V	62	28.20	30.40
4	2387.00	48.00 AV	54.00	-6.00	1.78 V	62	17.60	30.40
5	2390.00	64.20 PK	74.00	-9.80	1.02 V	32	33.80	30.40
5	2390.00	52.60 AV	54.00	-1.40	1.02 V	32	22.20	30.40
6	*2412.00	115.80 PK			1.32 V	340	85.30	30.50
6	*2412.00	107.80 AV			1.32 V	340	77.20	30.50
7	4824.00	55.50 PK	74.00	-18.50	1.32 V	65	19.30	36.20
7	4824.00	47.50 AV	54.00	-6.50	1.32 V	65	11.30	36.20
8	7236.00	49.60 PK	74.00	-24.40	1.87 V	52	7.90	41.70
9	9648.00	51.30 PK	74.00	-22.70	1.02 V	123	6.40	44.90
9	9648.00	43.00 AV	54.00	-11.00	1.02 V	123	-1.90	44.90

- NOTE:**
1. Emission level(dBuV/m)=Raw Value(dBuV) + Correction Factor(dB)
 2. Correction Factor(dB/m) = Antenna Factor (dB/m) + Cable Factor (dB)
 3. The other emission levels were very low against the limit.
 4. Margin value = Emission level – Limit value.
 5. The limit value is defined as per 15.247
 6. “ * “ : Fundamental frequency



EUT	Flanker Pro Dual Radio AP	MODEL	AP-AG-AT-02
MODE	Channel 6	FREQUENCY RANGE	1000MHz~25000MHz
INPUT POWER (SYSTEM)	120Vac, 60Hz	DETECTOR FUNCTION	Peak(PK) Average (AV)
ENVIRONMENTAL CONDITIONS	23deg. C, 55%RH, 982 hPa	TESTED BY	Eric Lee

ANTENNA POLARITY & TEST DISTANCE: HORIZONTAL AT 3 M

No.	Freq. (MHz)	Emission Level (dBuV/m)	Limit (dBuV/m)	Margin (dB)	Antenna Height (m)	Table Angle (Degree)	Raw Value (dBuV)	Correction Factor (dB/m)
1	2016.00	52.10 PK	74.00	-21.90	1.35 H	62	22.90	29.20
1	2016.00	50.40 AV	54.00	-3.60	1.35 H	62	21.10	29.20
2	2267.00	55.70 PK	74.00	-18.30	1.63 H	54	25.70	30.00
2	2267.00	46.80 AV	54.00	-7.20	1.63 H	54	16.70	30.00
3	2390.00	54.60 PK	74.00	-19.40	1.52 H	205	24.20	30.40
3	2390.00	42.30 AV	54.00	-11.70	1.52 H	205	11.90	30.40
4	*2437.00	110.70 PK			1.23 H	32	80.00	30.70
4	*2437.00	102.90 AV			1.23 H	32	72.20	30.70
5	2483.50	56.20 PK	74.00	-17.80	1.02 H	3	25.30	31.00
5	2483.50	41.30 AV	54.00	-12.70	1.02 H	3	10.30	31.00
6	4874.00	48.70 PK	74.00	-25.30	1.32 H	65	12.20	36.50
7	7311.00	50.10 PK	74.00	-23.90	1.55 H	231	8.30	41.80
8	9748.00	49.60 PK	74.00	-24.40	1.08 H	4	4.90	44.60

- NOTE:**
1. Emission level(dBuV/m)=Raw Value(dBuV) + Correction Factor(dB)
 2. Correction Factor(dB/m) = Antenna Factor (dB/m) + Cable Factor (dB)
 3. The other emission levels were very low against the limit.
 4. Margin value = Emission level – Limit value.
 5. The limit value is defined as per 15.247
 6. “ * “ : Fundamental frequency



EUT	Flanker Pro Dual Radio AP	MODEL	AP-AG-AT-02
MODE	Channel 6	FREQUENCY RANGE	1000MHz~25000MHz
INPUT POWER (SYSTEM)	120Vac, 60Hz	DETECTOR FUNCTION	Peak(PK) Average (AV)
ENVIRONMENTAL CONDITIONS	23deg. C, 55%RH, 982 hPa	TESTED BY	Eric Lee

ANTENNA POLARITY & TEST DISTANCE: VERTICAL AT 3 M

No.	Freq. (MHz)	Emission Level (dBuV/m)	Limit (dBuV/m)	Margin (dB)	Antenna Height (m)	Table Angle (Degree)	Raw Value (dBuV)	Correction Factor (dB/m)
1	2016.00	56.40 PK	74.00	-17.60	1.42 V	309	27.10	29.20
2	2267.00	60.40 PK	74.00	-13.60	1.40 V	22	30.40	30.00
2	2267.00	51.10 AV	54.00	-2.90	1.40 V	22	21.10	30.00
3	2390.00	65.20 PK	74.00	-8.80	1.08 V	258	34.80	30.40
3	2390.00	52.40 AV	54.00	-1.60	1.08 V	258	22.00	30.40
4	*2437.00	113.70 PK			1.36 V	66	83.00	30.70
4	*2437.00	111.90 AV			1.36 V	66	81.20	30.70
5	2483.50	66.30 PK	74.00	-7.70	1.60 V	209	35.40	31.00
5	2483.50	52.60 AV	54.00	-1.40	1.60 V	209	21.60	31.00
6	4874.00	58.00 PK	74.00	-16.00	1.35 V	62	21.50	36.50
6	4874.00	49.60 AV	54.00	-4.40	1.35 V	62	13.10	36.50
7	7311.00	47.70 PK	74.00	-26.30	1.23 V	63	5.90	41.80
8	9748.00	52.90 PK	74.00	-21.10	1.36 V	323	8.20	44.60
8	9748.00	41.60 AV	54.00	-12.40	1.36 V	323	-3.00	44.60

- NOTE:**
1. Emission level(dBuV/m)=Raw Value(dBuV) + Correction Factor(dB)
 2. Correction Factor(dB/m) = Antenna Factor (dB/m) + Cable Factor (dB)
 3. The other emission levels were very low against the limit.
 4. Margin value = Emission level – Limit value.
 5. The limit value is defined as per 15.247
 6. " * " : Fundamental frequency



EUT	Flanker Pro Dual Radio AP	MODEL	AP-AG-AT-02
MODE	Channel 11	FREQUENCY RANGE	1000MHz~25000MHz
INPUT POWER (SYSTEM)	120Vac, 60Hz	DETECTOR FUNCTION	Peak(PK) Average (AV)
ENVIRONMENTAL CONDITIONS	23deg. C, 55%RH, 982 hPa	TESTED BY	Eric Lee

ANTENNA POLARITY & TEST DISTANCE: HORIZONTAL AT 3M

No.	Freq. (MHz)	Emission Level (dBuV/m)	Limit (dBuV/m)	Margin (dB)	Antenna Height (m)	Table Angle (Degree)	Raw Value (dBuV)	Correction Factor (dB/m)
1	2016.00	47.80 PK	74.00	-26.20	1.35 H	24	18.60	29.20
2	2360.00	42.80 PK	74.00	-31.20	1.24 H	74	12.50	30.30
3	*2462.00	106.40 PK			1.53 H	62	75.60	30.80
3	*2462.00	98.80 AV			1.53 H	62	68.00	30.80
4	2483.50	52.30 PK	74.00	-21.70	1.65 H	333	21.40	31.00
4	2483.50	42.30 AV	54.00	-11.70	1.65 H	333	11.30	31.00
5	2496.00	46.30 PK	74.00	-27.70	1.32 H	62	15.50	30.80
6	4924.00	48.90 PK	74.00	-25.10	1.65 H	24	12.20	36.70
7	7386.00	48.30 PK	74.00	-25.70	1.54 H	74	6.40	41.80
8	9848.00	50.10 PK	74.00	-23.90	1.82 H	204	5.70	44.40

- NOTE:**
1. Emission level(dBuV/m)=Raw Value(dBuV) + Correction Factor(dB)
 2. Correction Factor(dB/m) = Antenna Factor (dB/m) + Cable Factor (dB)
 3. The other emission levels were very low against the limit.
 4. Margin value = Emission level – Limit value.
 5. The limit value is defined as per 15.247
 6. “ * “ : Fundamental frequency



EUT	Flanker Pro Dual Radio AP	MODEL	AP-AG-AT-02
MODE	Channel 11	FREQUENCY RANGE	1000MHz~25000MHz
INPUT POWER (SYSTEM)	120Vac, 60Hz	DETECTOR FUNCTION	Peak(PK) Average (AV)
ENVIRONMENTAL CONDITIONS	23deg. C, 55%RH, 982 hPa	TESTED BY	Eric Lee

ANTENNA POLARITY & TEST DISTANCE: VERTICAL AT 3M

No.	Freq. (MHz)	Emission Level (dBuV/m)	Limit (dBuV/m)	Margin (dB)	Antenna Height (m)	Table Angle (Degree)	Raw Value (dBuV)	Correction Factor (dB/m)
1	2016.00	52.50 PK	74.00	-21.50	1.62 V	5	23.30	29.20
1	2016.00	50.80 AV	54.00	-3.20	1.62 V	5	21.60	29.20
2	2360.00	52.00 PK	74.00	-22.00	1.36 V	321	21.70	30.30
2	2360.00	41.10 AV	54.00	-12.90	1.36 V	321	10.70	30.30
3	*2462.00	117.00 PK			1.22 V	202	86.20	30.80
3	*2462.00	109.70 AV			1.22 V	202	78.90	30.80
4	2483.50	64.20 PK	74.00	-9.80	1.60 V	303	33.30	31.00
4	2483.50	52.30 AV	54.00	-1.70	1.60 V	303	21.30	31.00
5	2496.00	59.40 PK	74.00	-14.60	1.54 V	215	28.70	30.80
5	2496.00	50.00 AV	54.00	-4.00	1.54 V	215	19.20	30.80
6	4924.00	56.90 PK	74.00	-17.10	1.55 V	222	20.20	36.70
6	4924.00	49.20 AV	54.00	-4.80	1.55 V	222	12.60	36.70
7	7386.00	49.90 PK	74.00	-24.10	1.45 V	24	8.00	41.80
8	9848.00	52.80 PK	74.00	-21.20	1.45 V	24	8.40	44.40
8	9848.00	42.40 AV	54.00	-11.60	1.45 V	24	-1.90	44.40

- NOTE:**
1. Emission level(dBuV/m)=Raw Value(dBuV) + Correction Factor(dB)
 2. Correction Factor(dB/m) = Antenna Factor (dB/m) + Cable Factor (dB)
 3. The other emission levels were very low against the limit.
 4. Margin value = Emission level – Limit value.
 5. The limit value is defined as per 15.247
 6. “ * “ : Fundamental frequency



4.2.12 TEST RESULTS - DSSS (ANTENNA 5)

EUT	Flanker Pro Dual Radio AP	MODEL	AP-AG-AT-02
MODE	Channel 1	FREQUENCY RANGE	1000MHz~25000MHz
INPUT POWER (SYSTEM)	120Vac, 60Hz	DETECTOR FUNCTION	Peak(PK) Average (AV)
ENVIRONMENTAL CONDITIONS	23deg. C, 55%RH, 982 hPa	TESTED BY	Eric Lee

ANTENNA POLARITY & TEST DISTANCE: HORIZONTAL AT 3 M

No.	Freq. (MHz)	Emission Level (dBuV/m)	Limit (dBuV/m)	Margin (dB)	Antenna Height (m)	Table Angle (Degree)	Raw Value (dBuV)	Correction Factor (dB/m)
1	2016.00	34.40 PK	74.00	-39.60	1.02 H	32	5.20	29.20
2	2280.00	46.80 PK	74.00	-27.20	1.65 H	24	16.70	30.10
3	2360.00	42.90 PK	74.00	-31.10	1.47 H	54	12.60	30.30
4	2387.00	45.60 PK	74.00	-28.40	1.08 H	93	15.20	30.40
5	2390.00	46.70 PK	74.00	-27.30	1.11 H	4	16.30	30.40
6	*2412.00	84.80 PK			1.02 H	47	54.20	30.50
6	*2412.00	77.40 AV			1.02 H	47	46.90	30.50
7	4824.00	41.30 PK	74.00	-32.70	1.54 H	24	5.10	36.20
8	7236.00	44.20 PK	74.00	-29.80	1.02 H	213	2.60	41.70
9	9648.00	47.10 PK	74.00	-26.90	1.50 H	2	2.20	44.90

- NOTE:**
1. Emission level(dBuV/m)=Raw Value(dBuV) + Correction Factor(dB)
 2. Correction Factor(dB/m) = Antenna Factor (dB/m) + Cable Factor (dB)
 3. The other emission levels were very low against the limit.
 4. Margin value = Emission level – Limit value.
 5. The limit value is defined as per 15.247
 6. “ * “ : Fundamental frequency



EUT	Flanker Pro Dual Radio AP	MODEL	AP-AG-AT-02
MODE	Channel 1	FREQUENCY RANGE	1000MHz~25000MHz
INPUT POWER (SYSTEM)	120Vac, 60Hz	DETECTOR FUNCTION	Peak(PK) Average (AV)
ENVIRONMENTAL CONDITIONS	23deg. C, 55%RH, 982 hPa	TESTED BY	Eric Lee

ANTENNA POLARITY & TEST DISTANCE: VERTICAL AT 3 M

No.	Freq. (MHz)	Emission Level (dBuV/m)	Limit (dBuV/m)	Margin (dB)	Antenna Height (m)	Table Angle (Degree)	Raw Value (dBuV)	Correction Factor (dB/m)
1	2016.00	56.40 PK	74.00	-17.60	1.25 V	2	27.10	29.20
1	2016.00	43.30 AV	54.00	-10.70	1.25 V	2	14.00	29.20
2	2280.00	62.40 PK	74.00	-11.60	1.14 V	0	32.30	30.10
2	2280.00	51.70 AV	54.00	-2.30	1.14 V	0	21.60	30.10
3	2360.00	54.90 PK	74.00	-19.10	1.11 V	32	24.60	30.30
3	2360.00	46.50 AV	54.00	-7.50	1.11 V	32	16.20	30.30
4	2387.00	55.60 PK	74.00	-18.40	1.02 V	8	25.20	30.40
4	2387.00	47.20 AV	54.00	-6.80	1.02 V	8	16.80	30.40
5	2390.00	60.20 PK	74.00	-13.80	1.32 V	20	29.80	30.40
5	2390.00	49.30 AV	54.00	-4.70	1.32 V	20	18.90	30.40
6	*2412.00	110.00 PK			1.14 V	1	79.40	30.50
6	*2412.00	102.90 AV			1.14 V	1	72.40	30.50
7	4824.00	44.40 PK	74.00	-29.60	1.56 V	32	8.20	36.20
8	7236.00	48.60 PK	74.00	-25.40	1.20 V	2	6.90	41.70
9	9648.00	49.80 PK	74.00	-24.20	1.15 V	12	4.90	44.90

- NOTE:**
1. Emission level(dBuV/m)=Raw Value(dBuV) + Correction Factor(dB)
 2. Correction Factor(dB/m) = Antenna Factor (dB/m) + Cable Factor (dB)
 3. The other emission levels were very low against the limit.
 4. Margin value = Emission level – Limit value.
 5. The limit value is defined as per 15.247
 6. “ * “ : Fundamental frequency



EUT	Flanker Pro Dual Radio AP	MODEL	AP-AG-AT-02
MODE	Channel 6	FREQUENCY RANGE	1000MHz~25000MHz
INPUT POWER (SYSTEM)	120Vac, 60Hz	DETECTOR FUNCTION	Peak(PK) Average (AV)
ENVIRONMENTAL CONDITIONS	23deg. C, 55%RH, 982 hPa	TESTED BY	Eric Lee

ANTENNA POLARITY & TEST DISTANCE: HORIZONTAL AT 3 M

No.	Freq. (MHz)	Emission Level (dBuV/m)	Limit (dBuV/m)	Margin (dB)	Antenna Height (m)	Table Angle (Degree)	Raw Value (dBuV)	Correction Factor (dB/m)
1	2016.00	42.50 PK	74.00	-31.50	1.42 H	20	13.20	29.20
2	2280.00	49.10 PK	74.00	-24.90	1.00 H	346	19.00	30.10
3	2360.00	49.60 PK	74.00	-24.40	1.54 H	24	19.30	30.30
4	2390.00	49.00 PK	74.00	-25.00	1.32 H	6	18.60	30.40
5	*2437.00	90.00 PK			1.11 H	10	59.40	30.70
5	*2437.00	81.90 AV			1.11 H	10	51.20	30.70
6	2483.50	47.30 PK	74.00	-26.70	1.28 H	24	16.40	31.00
7	4874.00	40.30 PK	74.00	-33.70	1.08 H	7	3.80	36.50
8	7311.00	44.40 PK	74.00	-29.60	1.02 H	4	2.70	41.80
9	9748.00	46.70 PK	74.00	-27.30	1.55 H	25	2.10	44.60

ANTENNA POLARITY & TEST DISTANCE: VERTICAL AT 3 M

No.	Freq. (MHz)	Emission Level (dBuV/m)	Limit (dBuV/m)	Margin (dB)	Antenna Height (m)	Table Angle (Degree)	Raw Value (dBuV)	Correction Factor (dB/m)
1	2016.00	46.70 PK	74.00	-27.30	1.11 V	2	17.50	29.20
2	2280.00	60.90 PK	74.00	-13.10	1.02 V	4	30.80	30.10
2	2280.00	51.20 AV	54.00	-2.80	1.02 V	4	21.20	30.10
3	2360.00	54.80 PK	74.00	-19.20	1.60 V	3	24.50	30.30
3	2360.00	43.60 AV	54.00	-10.40	1.60 V	3	13.20	30.30
4	2390.00	61.20 PK	74.00	-12.80	1.20 V	20	30.80	30.40
4	2390.00	49.50 AV	54.00	-4.50	1.20 V	20	19.10	30.40
5	*2437.00	115.00 PK			1.65 V	32	84.30	30.70
5	*2437.00	108.20 AV			1.65 V	32	77.50	30.70
6	2483.50	60.60 PK	74.00	-13.40	1.54 V	1	29.60	31.00
6	2483.50	47.60 AV	54.00	-6.40	1.54 V	1	16.60	31.00
7	4874.00	44.90 PK	74.00	-29.10	1.47 V	5	8.50	36.50
8	7311.00	50.80 PK	74.00	-23.20	1.35 V	62	9.00	41.80
9	9748.00	49.60 PK	74.00	-24.40	1.59 V	357	4.90	44.60

- NOTE:**
1. Emission level(dBuV/m)=Raw Value(dBuV) + Correction Factor(dB)
 2. Correction Factor(dB/m) = Antenna Factor (dB/m) + Cable Factor (dB)
 3. The other emission levels were very low against the limit.
 4. Margin value = Emission level – Limit value.
 5. The limit value is defined as per 15.247
 6. " * " : Fundamental frequency



EUT	Flanker Pro Dual Radio AP	MODEL	AP-AG-AT-02
MODE	Channel 11	FREQUENCY RANGE	1000MHz~25000MHz
INPUT POWER (SYSTEM)	120Vac, 60Hz	DETECTOR FUNCTION	Peak(PK) Average (AV)
ENVIRONMENTAL CONDITIONS	23deg. C, 55%RH, 982 hPa	TESTED BY	Eric Lee

ANTENNA POLARITY & TEST DISTANCE: HORIZONTAL AT 3M

No.	Freq. (MHz)	Emission Level (dBuV/m)	Limit (dBuV/m)	Margin (dB)	Antenna Height (m)	Table Angle (Degree)	Raw Value (dBuV)	Correction Factor (dB/m)
1	2016.00	33.10 PK	74.00	-40.90	1.11 H	5	3.90	29.20
2	2280.00	46.80 PK	74.00	-27.20	1.36 H	360	16.70	30.10
3	2360.00	41.30 PK	74.00	-32.70	1.82 H	20	11.00	30.30
4	*2462.00	88.00 PK			1.12 H	32	57.20	30.80
4	*2462.00	79.50 AV			1.12 H	32	48.60	30.80
5	2483.50	47.70 PK	74.00	-26.30	1.40 H	7	16.80	31.00
6	4924.00	42.40 PK	74.00	-31.60	1.11 H	9	5.70	36.70
7	7386.00	46.70 PK	74.00	-27.30	1.02 H	306	4.80	41.80
8	9848.00	46.40 PK	74.00	-27.60	1.64 H	2	2.10	44.40

ANTENNA POLARITY & TEST DISTANCE: VERTICAL AT 3M

No.	Freq. (MHz)	Emission Level (dBuV/m)	Limit (dBuV/m)	Margin (dB)	Antenna Height (m)	Table Angle (Degree)	Raw Value (dBuV)	Correction Factor (dB/m)
1	2016.00	46.10 PK	74.00	-27.90	1.56 V	32	16.90	29.20
2	2280.00	62.60 PK	74.00	-11.40	1.14 V	1	32.50	30.10
2	2280.00	51.60 AV	54.00	-2.40	1.14 V	1	21.50	30.10
3	2360.00	54.50 PK	74.00	-19.50	1.02 V	6	24.20	30.30
3	2360.00	43.60 AV	54.00	-10.40	1.02 V	6	13.20	30.30
4	*2462.00	112.10 PK			1.54 V	2	81.20	30.80
4	*2462.00	105.30 AV			1.54 V	2	74.40	30.80
5	2483.50	60.90 PK	74.00	-13.10	1.02 V	3	30.00	31.00
5	2483.50	49.50 AV	54.00	-4.50	1.02 V	3	18.60	31.00
6	4924.00	42.20 PK	74.00	-31.80	1.02 V	4	5.50	36.70
7	7386.00	49.70 PK	74.00	-24.30	1.87 V	9	7.80	41.80
8	9848.00	49.30 PK	74.00	-24.70	1.06 V	2	4.90	44.40

- NOTE:**
1. Emission level(dBuV/m)=Raw Value(dBuV) + Correction Factor(dB)
 2. Correction Factor(dB/m) = Antenna Factor (dB/m) + Cable Factor (dB)
 3. The other emission levels were very low against the limit.
 4. Margin value = Emission level – Limit value.
 5. The limit value is defined as per 15.247
 6. “ * “ : Fundamental frequency



4.2.13 TEST RESULTS - DSSS (ANTENNA 6)

EUT	Flanker Pro Dual Radio AP	MODEL	AP-AG-AT-02
MODE	Channel 1	FREQUENCY RANGE	1000MHz~25000MHz
INPUT POWER (SYSTEM)	120Vac, 60Hz	DETECTOR FUNCTION	Peak(PK) Average (AV)
ENVIRONMENTAL CONDITIONS	23deg. C, 55%RH, 982 hPa	TESTED BY	Eric Lee

ANTENNA POLARITY & TEST DISTANCE: HORIZONTAL AT 3 M

No.	Freq. (MHz)	Emission Level (dBuV/m)	Limit (dBuV/m)	Margin (dB)	Antenna Height (m)	Table Angle (Degree)	Raw Value (dBuV)	Correction Factor (dB/m)
1	2016.00	27.10 PK	74.00	-46.90	1.11 H	8	-2.10	29.20
2	2292.00	46.40 PK	74.00	-27.60	1.43 H	309	16.30	30.10
3	2387.00	41.40 PK	74.00	-32.60	1.47 H	8	11.00	30.40
4	2390.00	45.70 PK	74.00	-28.30	1.54 H	24	15.30	30.40
5	*2412.00	90.50 PK			1.52 H	3	60.00	30.50
5	*2412.00	82.80 AV			1.52 H	3	52.20	30.50
6	4824.00	40.40 PK	74.00	-33.60	1.58 H	2	4.20	36.20
7	7236.00	46.20 PK	74.00	-27.80	1.65 H	3	4.60	41.70
8	9648.00	46.80 PK	74.00	-27.20	1.14 H	357	1.90	44.90

ANTENNA POLARITY & TEST DISTANCE: VERTICAL AT 3 M

No.	Freq. (MHz)	Emission Level (dBuV/m)	Limit (dBuV/m)	Margin (dB)	Antenna Height (m)	Table Angle (Degree)	Raw Value (dBuV)	Correction Factor (dB/m)
1	2016.00	40.50 PK	74.00	-33.50	1.14 V	2	11.20	29.20
2	2292.00	59.60 PK	74.00	-14.40	1.01 V	5	29.50	30.10
2	2292.00	51.90 AV	54.00	-2.10	1.01 V	5	21.80	30.10
3	2387.00	57.40 PK	74.00	-16.60	1.23 V	32	27.00	30.40
3	2387.00	45.60 AV	54.00	-8.40	1.23 V	32	15.20	30.40
4	2390.00	59.70 PK	74.00	-14.30	1.65 V	2	29.30	30.40
4	2390.00	48.00 AV	54.00	-6.00	1.65 V	2	17.60	30.40
5	*2412.00	110.00 PK			1.15 V	24	79.40	30.50
5	*2412.00	101.90 AV			1.15 V	24	71.40	30.50
6	4824.00	43.00 PK	74.00	-31.00	1.16 V	3	6.80	36.20
7	7236.00	48.20 PK	74.00	-25.80	1.45 V	2	6.60	41.70
8	9648.00	50.40 PK	74.00	-23.60	1.15 V	24	5.50	44.90

- NOTE:**
1. Emission level(dBuV/m)=Raw Value(dBuV) + Correction Factor(dB)
 2. Correction Factor(dB/m) = Antenna Factor (dB/m) + Cable Factor (dB)
 3. The other emission levels were very low against the limit.
 4. Margin value = Emission level – Limit value.
 5. The limit value is defined as per 15.247
 6. “ * “ : Fundamental frequency



EUT	Flanker Pro Dual Radio AP	MODEL	AP-AG-AT-02
MODE	Channel 6	FREQUENCY RANGE	1000MHz~25000MHz
INPUT POWER (SYSTEM)	120Vac, 60Hz	DETECTOR FUNCTION	Peak(PK) Average (AV)
ENVIRONMENTAL CONDITIONS	23deg. C, 55%RH, 982 hPa	TESTED BY	Eric Lee

ANTENNA POLARITY & TEST DISTANCE: HORIZONTAL AT 3 M

No.	Freq. (MHz)	Emission Level (dBuV/m)	Limit (dBuV/m)	Margin (dB)	Antenna Height (m)	Table Angle (Degree)	Raw Value (dBuV)	Correction Factor (dB/m)
1	2016.00	30.10 PK	74.00	-43.90	1.47 H	56	0.90	29.20
2	2292.00	46.60 PK	74.00	-27.40	1.11 H	10	16.50	30.10
3	2390.00	47.50 PK	74.00	-26.50	1.54 H	24	17.10	30.40
4	*2437.00	97.70 PK			1.02 H	356	67.00	30.70
4	*2437.00	90.20 AV			1.02 H	356	59.50	30.70
5	2483.50	45.50 PK	74.00	-28.50	1.01 H	359	14.60	31.00
6	4874.00	41.90 PK	74.00	-32.10	1.43 H	6	5.40	36.50
7	7311.00	47.60 PK	74.00	-26.40	1.63 H	32	5.90	41.80
8	9748.00	49.30 PK	74.00	-24.70	1.08 H	24	4.60	44.60

ANTENNA POLARITY & TEST DISTANCE: VERTICAL AT 3 M

No.	Freq. (MHz)	Emission Level (dBuV/m)	Limit (dBuV/m)	Margin (dB)	Antenna Height (m)	Table Angle (Degree)	Raw Value (dBuV)	Correction Factor (dB/m)
1	2016.00	42.10 PK	74.00	-31.90	1.02 V	4	12.90	29.20
2	2292.00	59.90 PK	74.00	-14.10	1.65 V	24	29.80	30.10
2	2292.00	51.50 AV	54.00	-2.50	1.65 V	24	21.40	30.10
3	2390.00	61.20 PK	74.00	-12.80	1.09 V	3	30.80	30.40
3	2390.00	49.20 AV	54.00	-4.80	1.09 V	3	18.70	30.40
4	*2437.00	118.90 PK			1.45 V	21	88.20	30.70
4	*2437.00	109.70 AV			1.45 V	21	79.00	30.70
5	2483.50	63.30 PK	74.00	-10.70	1.11 V	6	32.40	31.00
5	2483.50	51.00 AV	54.00	-3.00	1.11 V	6	20.00	31.00
6	4874.00	46.20 PK	74.00	-27.80	1.70 V	1	9.70	36.50
7	7311.00	48.00 PK	74.00	-26.00	1.03 V	39	6.30	41.80
8	9748.00	49.90 PK	74.00	-24.10	1.54 V	2	5.20	44.60

- NOTE:**
1. Emission level(dBuV/m)=Raw Value(dBuV) + Correction Factor(dB)
 2. Correction Factor(dB/m) = Antenna Factor (dB/m) + Cable Factor (dB)
 3. The other emission levels were very low against the limit.
 4. Margin value = Emission level – Limit value.
 5. The limit value is defined as per 15.247
 6. “ * “ : Fundamental frequency



EUT	Flanker Pro Dual Radio AP	MODEL	AP-AG-AT-02
MODE	Channel 11	FREQUENCY RANGE	1000MHz~25000MHz
INPUT POWER (SYSTEM)	120Vac, 60Hz	DETECTOR FUNCTION	Peak(PK) Average (AV)
ENVIRONMENTAL CONDITIONS	23deg. C, 55%RH, 982 hPa	TESTED BY	Eric Lee

ANTENNA POLARITY & TEST DISTANCE: HORIZONTAL AT 3M

No.	Freq. (MHz)	Emission Level (dBuV/m)	Limit (dBuV/m)	Margin (dB)	Antenna Height (m)	Table Angle (Degree)	Raw Value (dBuV)	Correction Factor (dB/m)
1	2016.00	29.10 PK	74.00	-44.90	1.52 H	20	-0.10	29.20
2	2280.00	43.80 PK	74.00	-30.20	1.87 H	9	13.70	30.10
3	*2462.00	97.20 PK			1.33 H	3	66.30	30.80
3	*2462.00	89.10 AV			1.33 H	3	58.20	30.80
4	2483.50	49.20 PK	74.00	-24.80	1.53 H	6	18.20	31.00
5	4924.00	40.80 PK	74.00	-33.20	1.54 H	24	4.10	36.70
6	7386.00	46.30 PK	74.00	-27.70	1.22 H	20	4.50	41.80
7	9848.00	45.80 PK	74.00	-28.20	1.14 H	7	1.40	44.40

ANTENNA POLARITY & TEST DISTANCE: VERTICAL AT 3M

No.	Freq. (MHz)	Emission Level (dBuV/m)	Limit (dBuV/m)	Margin (dB)	Antenna Height (m)	Table Angle (Degree)	Raw Value (dBuV)	Correction Factor (dB/m)
1	2016.00	43.40 PK	74.00	-30.60	1.02 V	3	14.10	29.20
2	2280.00	60.80 PK	74.00	-13.20	1.22 V	32	30.70	30.10
2	2280.00	51.50 AV	54.00	-2.50	1.22 V	32	21.50	30.10
3	*2462.00	116.10 PK			1.42 V	2	85.20	30.80
3	*2462.00	108.80 AV			1.42 V	2	78.00	30.80
4	2483.50	64.60 PK	74.00	-9.40	1.30 V	3	33.60	31.00
4	2483.50	52.80 AV	54.00	-1.20	1.30 V	3	21.80	31.00
5	4924.00	43.30 PK	74.00	-30.70	1.00 V	2	6.60	36.70
6	7386.00	49.90 PK	74.00	-24.10	1.02 V	4	8.00	41.80
7	9848.00	50.50 PK	74.00	-23.50	1.42 V	9	6.10	44.40

- NOTE:**
1. Emission level(dBuV/m)=Raw Value(dBuV) + Correction Factor(dB)
 2. Correction Factor(dB/m) = Antenna Factor (dB/m) + Cable Factor (dB)
 3. The other emission levels were very low against the limit.
 4. Margin value = Emission level – Limit value.
 5. The limit value is defined as per 15.247
 6. “ * “ : Fundamental frequency



4.2.14 TEST RESULTS - DSSS (ANTENNA 7)

EUT	Flanker Pro Dual Radio AP	MODEL	AP-AG-AT-02
MODE	Channel 3	FREQUENCY RANGE	1000MHz~25000MHz
INPUT POWER (SYSTEM)	120Vac, 60Hz	DETECTOR FUNCTION	Peak(PK) Average (AV)
ENVIRONMENTAL CONDITIONS	23deg. C, 55%RH, 982 hPa	TESTED BY	Eric Lee

ANTENNA POLARITY & TEST DISTANCE: HORIZONTAL AT 3 M

No.	Freq. (MHz)	Emission Level (dBuV/m)	Limit (dBuV/m)	Margin (dB)	Antenna Height (m)	Table Angle (Degree)	Raw Value (dBuV)	Correction Factor (dB/m)
1	2016.00	34.90 PK	74.00	-39.10	1.10 H	318	5.70	29.20
2	2280.00	36.40 PK	74.00	-37.60	1.07 H	191	6.30	30.10
3	2360.00	33.60 PK	74.00	-40.40	1.11 H	67	3.30	30.30
4	2390.00	44.60 PK	74.00	-29.40	1.24 H	168	14.10	30.40
5	*2422.00	85.90 PK			1.37 H	360	55.30	30.60
5	*2422.00	78.90 AV			1.37 H	360	48.30	30.60
6	4844.00	42.20 PK	74.00	-31.80	1.12 H	180	5.90	36.30
7	7266.00	47.20 PK	74.00	-26.80	1.17 H	189	5.50	41.70
8	9688.00	47.60 PK	74.00	-26.40	1.20 H	180	2.80	44.80

ANTENNA POLARITY & TEST DISTANCE: VERTICAL AT 3 M

No.	Freq. (MHz)	Emission Level (dBuV/m)	Limit (dBuV/m)	Margin (dB)	Antenna Height (m)	Table Angle (Degree)	Raw Value (dBuV)	Correction Factor (dB/m)
1	2016.00	51.20 PK	74.00	-22.80	1.12 V	178	21.90	29.20
1	2016.00	49.60 AV	54.00	-4.40	1.12 V	178	20.30	29.20
2	2280.00	62.40 PK	74.00	-11.60	1.14 V	180	32.30	30.10
2	2280.00	52.70 AV	54.00	-1.30	1.14 V	180	22.60	30.10
3	2360.00	52.70 PK	74.00	-21.30	1.11 V	179	22.30	30.30
3	2360.00	43.30 AV	54.00	-10.70	1.11 V	179	13.00	30.30
4	2390.00	57.70 PK	74.00	-16.30	1.12 V	182	27.30	30.40
4	2390.00	48.50 AV	54.00	-5.50	1.12 V	182	18.10	30.40
5	*2422.00	108.40 PK			1.13 V	179	77.80	30.60
5	*2422.00	102.90 AV			1.13 V	179	72.30	30.60
6	4844.00	42.00 PK	74.00	-32.00	1.14 V	169	5.70	36.30
7	7266.00	48.00 PK	74.00	-26.00	1.20 V	178	6.30	41.70
8	9688.00	45.40 PK	74.00	-28.60	1.14 V	183	0.60	44.80

- NOTE:**
1. Emission level(dBuV/m)=Raw Value(dBuV) + Correction Factor(dB)
 2. Correction Factor(dB/m) = Antenna Factor (dB/m) + Cable Factor (dB)
 3. The other emission levels were very low against the limit.
 4. Margin value = Emission level – Limit value.
 5. The limit value is defined as per 15.247
 6. " * " : Fundamental frequency



EUT	Flanker Pro Dual Radio AP	MODEL	AP-AG-AT-02
MODE	Channel 6	FREQUENCY RANGE	1000MHz~25000MHz
INPUT POWER (SYSTEM)	120Vac, 60Hz	DETECTOR FUNCTION	Peak(PK) Average (AV)
ENVIRONMENTAL CONDITIONS	23deg. C, 55%RH, 982 hPa	TESTED BY	Eric Lee

ANTENNA POLARITY & TEST DISTANCE: HORIZONTAL AT 3 M

No.	Freq. (MHz)	Emission Level (dBuV/m)	Limit (dBuV/m)	Margin (dB)	Antenna Height (m)	Table Angle (Degree)	Raw Value (dBuV)	Correction Factor (dB/m)
1	2016.00	35.40 PK	74.00	-38.60	1.10 H	159	6.10	29.20
2	2280.00	36.20 PK	74.00	-37.80	1.10 H	177	6.20	30.10
3	2360.00	39.10 PK	74.00	-34.90	1.20 H	189	8.80	30.30
4	*2437.00	89.40 PK			1.00 H	179	58.80	30.70
4	*2437.00	83.00 AV			1.00 H	179	52.30	30.70
5	2495.00	36.60 PK	74.00	-37.40	1.04 H	178	5.80	30.80
6	4874.00	40.70 PK	74.00	-33.30	1.04 H	201	4.30	36.50
7	7311.00	45.80 PK	74.00	-28.20	1.10 H	177	4.00	41.80
8	9748.00	48.40 PK	74.00	-25.60	1.08 H	188	3.80	44.60

ANTENNA POLARITY & TEST DISTANCE: VERTICAL AT 3 M

No.	Freq. (MHz)	Emission Level (dBuV/m)	Limit (dBuV/m)	Margin (dB)	Antenna Height (m)	Table Angle (Degree)	Raw Value (dBuV)	Correction Factor (dB/m)
1	2016.00	51.40 PK	74.00	-22.60	1.15 V	178	22.10	29.20
1	2016.00	49.80 AV	54.00	-4.20	1.15 V	178	20.50	29.20
2	2280.00	59.20 PK	74.00	-14.80	1.14 V	179	29.10	30.10
2	2280.00	52.50 AV	54.00	-1.50	1.14 V	179	22.40	30.10
3	2360.00	54.00 PK	74.00	-20.00	1.33 V	179	23.70	30.30
3	2360.00	43.60 AV	54.00	-10.40	1.33 V	179	13.30	30.30
4	*2437.00	110.60 PK			1.31 V	179	79.90	30.70
4	*2437.00	104.50 AV			1.31 V	179	73.80	30.70
5	2493.00	51.60 PK	74.00	-22.40	1.16 V	178	20.80	30.80
5	2493.00	41.30 AV	54.00	-12.70	1.16 V	178	10.50	30.80
6	4874.00	41.70 PK	74.00	-32.30	1.17 V	183	5.30	36.50
7	7311.00	45.70 PK	74.00	-28.30	1.24 V	178	3.90	41.80
8	9748.00	48.40 PK	74.00	-25.60	1.15 V	180	3.80	44.60

- NOTE:**
1. Emission level(dBuV/m)=Raw Value(dBuV) + Correction Factor(dB)
 2. Correction Factor(dB/m) = Antenna Factor (dB/m) + Cable Factor (dB)
 3. The other emission levels were very low against the limit.
 4. Margin value = Emission level – Limit value.
 5. The limit value is defined as per 15.247
 6. “ * “ : Fundamental frequency



EUT	Flanker Pro Dual Radio AP	MODEL	AP-AG-AT-02
MODE	Channel 9	FREQUENCY RANGE	1000MHz~25000MHz
INPUT POWER (SYSTEM)	120Vac, 60Hz	DETECTOR FUNCTION	Peak(PK) Average (AV)
ENVIRONMENTAL CONDITIONS	23deg. C, 55%RH, 982 hPa	TESTED BY	Eric Lee

ANTENNA POLARITY & TEST DISTANCE: HORIZONTAL AT 3M

No.	Freq. (MHz)	Emission Level (dBuV/m)	Limit (dBuV/m)	Margin (dB)	Antenna Height (m)	Table Angle (Degree)	Raw Value (dBuV)	Correction Factor (dB/m)
1	2016.00	36.10 PK	74.00	-37.90	1.46 H	180	6.90	29.20
2	2280.00	36.10 PK	74.00	-37.90	1.34 H	177	6.00	30.10
3	2360.00	36.30 PK	74.00	-37.70	1.26 H	186	5.90	30.30
4	*2452.00	90.10 PK			1.00 H	178	59.30	30.80
4	*2452.00	83.40 AV			1.00 H	178	52.60	30.80
5	2483.50	47.20 PK	74.00	-26.80	1.07 H	190	16.30	31.00
6	4904.00	43.00 PK	74.00	-31.00	1.07 H	189	6.40	36.60
7	7356.00	46.90 PK	74.00	-27.10	1.01 H	180	5.10	41.80
8	9808.00	48.20 PK	74.00	-25.80	1.04 H	176	3.70	44.50

ANTENNA POLARITY & TEST DISTANCE: VERTICAL AT 3M

No.	Freq. (MHz)	Emission Level (dBuV/m)	Limit (dBuV/m)	Margin (dB)	Antenna Height (m)	Table Angle (Degree)	Raw Value (dBuV)	Correction Factor (dB/m)
1	2016.00	49.70 PK	74.00	-24.30	1.13 V	180	20.50	29.20
2	2280.00	60.10 PK	74.00	-13.90	1.16 V	178	30.10	30.10
2	2280.00	52.50 AV	54.00	-1.50	1.16 V	178	22.40	30.10
3	2360.00	53.60 PK	74.00	-20.40	1.16 V	180	23.30	30.30
3	2360.00	44.20 AV	54.00	-9.80	1.16 V	180	13.80	30.30
4	*2452.00	111.20 PK			1.08 V	183	80.50	30.80
4	*2452.00	104.40 AV			1.08 V	183	73.70	30.80
5	2483.50	57.70 PK	74.00	-16.30	1.08 V	180	26.70	31.00
5	2483.50	48.80 AV	54.00	-5.20	1.08 V	180	17.90	31.00
6	4904.00	51.10 PK	74.00	-22.90	1.16 V	177	14.50	36.60
6	4904.00	39.00 AV	54.00	-15.00	1.16 V	177	2.40	36.60
7	7356.00	47.50 PK	74.00	-26.50	1.15 V	189	5.60	41.80
8	9808.00	48.70 PK	74.00	-25.30	1.16 V	173	4.20	44.50

- NOTE:**
1. Emission level(dBuV/m)=Raw Value(dBuV) + Correction Factor(dB)
 2. Correction Factor(dB/m) = Antenna Factor (dB/m) + Cable Factor (dB)
 3. The other emission levels were very low against the limit.
 4. Margin value = Emission level – Limit value.
 5. The limit value is defined as per 15.247
 6. " * " : Fundamental frequency



4.2.15 TEST RESULTS - OFDM (ANTENNA 1)

EUT	Flanker Pro Dual Radio AP	MODEL	AP-AG-AT-02
MODE	Channel 1	FREQUENCY RANGE	1000MHz~25000MHz
INPUT POWER (SYSTEM)	120Vac, 60Hz	DETECTOR FUNCTION	Peak(PK) Average (AV)
ENVIRONMENTAL CONDITIONS	23deg. C, 55%RH, 982 hPa	TESTED BY	Eric Lee

ANTENNA POLARITY & TEST DISTANCE: HORIZONTAL AT 3 M

No.	Freq. (MHz)	Emission Level (dBuV/m)	Limit (dBuV/m)	Margin (dB)	Antenna Height (m)	Table Angle (Degree)	Raw Value (dBuV)	Correction Factor (dB/m)
1	2016.00	47.40 PK	74.00	-26.60	1.58 H	74	18.10	29.20
2	2320.00	52.70 PK	74.00	-21.30	1.57 H	47	22.50	30.20
2	2320.00	45.20 AV	54.00	-8.80	1.57 H	47	15.00	30.20
3	2360.00	41.50 PK	74.00	-32.50	1.36 H	62	11.20	30.30
4	2390.00	53.20 PK	74.00	-20.80	1.11 H	201	22.80	30.40
4	2390.00	45.40 AV	54.00	-8.60	1.11 H	201	14.90	30.40
5	*2412.00	101.80 PK			1.54 H	24	71.30	30.50
5	*2412.00	93.80 AV			1.54 H	24	63.20	30.50
6	2496.00	45.20 PK	74.00	-28.80	1.11 H	47	14.50	30.80
7	4824.00	45.00 PK	74.00	-29.00	1.57 H	4	8.80	36.20
8	7236.00	46.80 PK	74.00	-27.20	1.02 H	87	5.10	41.70
9	9648.00	50.80 PK	74.00	-23.20	1.66 H	35	5.90	44.90

- NOTE:**
1. Emission level(dBuV/m)=Raw Value(dBuV) + Correction Factor(dB)
 2. Correction Factor(dB/m) = Antenna Factor (dB/m) + Cable Factor (dB)
 3. The other emission levels were very low against the limit.
 4. Margin value = Emission level – Limit value.
 5. The limit value is defined as per 15.247
 6. “ * “ : Fundamental frequency



EUT	Flanker Pro Dual Radio AP	MODEL	AP-AG-AT-02
MODE	Channel 1	FREQUENCY RANGE	1000MHz~25000MHz
INPUT POWER (SYSTEM)	120Vac, 60Hz	DETECTOR FUNCTION	Peak(PK) Average (AV)
ENVIRONMENTAL CONDITIONS	23deg. C, 55%RH, 982 hPa	TESTED BY	Eric Lee

ANTENNA POLARITY & TEST DISTANCE: VERTICAL AT 3 M

No.	Freq. (MHz)	Emission Level (dBuV/m)	Limit (dBuV/m)	Margin (dB)	Antenna Height (m)	Table Angle (Degree)	Raw Value (dBuV)	Correction Factor (dB/m)
1	2016.00	52.10 PK	74.00	-21.90	1.15 V	24	22.80	29.20
1	2016.00	51.00 AV	54.00	-3.00	1.15 V	24	21.80	29.20
2	2320.00	59.60 PK	74.00	-14.40	1.15 V	1	29.40	30.20
2	2320.00	52.60 AV	54.00	-1.40	1.15 V	1	22.40	30.20
3	2360.00	49.40 PK	74.00	-24.60	1.31 V	50	19.00	30.30
4	2390.00	60.80 PK	74.00	-13.20	1.65 V	32	30.40	30.40
4	2390.00	52.90 AV	54.00	-1.10	1.65 V	32	22.50	30.40
5	*2412.00	110.50 PK			1.23 V	321	80.00	30.50
5	*2412.00	101.50 AV			1.23 V	321	71.00	30.50
6	2496.00	56.80 PK	74.00	-17.20	4.00 V	21	26.00	30.80
6	2496.00	44.60 AV	54.00	-9.40	4.00 V	21	13.90	30.80
7	4824.00	48.40 PK	74.00	-25.60	1.45 V	24	12.20	36.20
8	7236.00	47.50 PK	74.00	-26.50	1.54 V	24	5.80	41.70
9	9648.00	48.40 PK	74.00	-25.60	1.55 V	232	3.50	44.90

- NOTE:**
1. Emission level(dBuV/m)=Raw Value(dBuV) + Correction Factor(dB)
 2. Correction Factor(dB/m) = Antenna Factor (dB/m) + Cable Factor (dB)
 3. The other emission levels were very low against the limit.
 4. Margin value = Emission level – Limit value.
 5. The limit value is defined as per 15.247
 6. “ * “ : Fundamental frequency



EUT	Flanker Pro Dual Radio AP	MODEL	AP-AG-AT-02
MODE	Channel 6	FREQUENCY RANGE	1000MHz~25000MHz
INPUT POWER (SYSTEM)	120Vac, 60Hz	DETECTOR FUNCTION	Peak(PK) Average (AV)
ENVIRONMENTAL CONDITIONS	23deg. C, 55%RH, 982 hPa	TESTED BY	Eric Lee

ANTENNA POLARITY & TEST DISTANCE: HORIZONTAL AT 3 M

No.	Freq. (MHz)	Emission Level (dBuV/m)	Limit (dBuV/m)	Margin (dB)	Antenna Height (m)	Table Angle (Degree)	Raw Value (dBuV)	Correction Factor (dB/m)
1	2016.00	49.40 PK	74.00	-24.60	1.15 H	32	20.10	29.20
2	2320.00	53.00 PK	74.00	-21.00	1.63 H	326	22.80	30.20
2	2320.00	43.90 AV	54.00	-10.10	1.63 H	326	13.70	30.20
3	2360.00	52.80 PK	74.00	-21.20	1.11 H	36	22.50	30.30
3	2360.00	44.10 AV	54.00	-9.90	1.11 H	36	13.80	30.30
4	2390.00	52.50 PK	74.00	-21.50	1.02 H	68	22.10	30.40
4	2390.00	40.20 AV	54.00	-13.80	1.02 H	68	9.80	30.40
5	*2437.00	106.70 PK			1.11 H	5	76.00	30.70
5	*2437.00	99.20 AV			1.11 H	5	68.50	30.70
6	2483.50	49.90 PK	74.00	-24.10	1.45 H	35	18.90	31.00
7	2496.00	51.40 PK	74.00	-22.60	1.53 H	62	20.60	30.80
7	2496.00	39.70 AV	54.00	-14.30	1.53 H	62	8.90	30.80
8	4874.00	41.80 PK	74.00	-32.20	1.02 H	47	5.40	36.50
9	7311.00	46.60 PK	74.00	-27.40	1.08 H	52	4.80	41.80
10	9748.00	49.30 PK	74.00	-24.70	1.11 H	2	4.60	44.60

- NOTE:**
1. Emission level(dBuV/m)=Raw Value(dBuV) + Correction Factor(dB)
 2. Correction Factor(dB/m) = Antenna Factor (dB/m) + Cable Factor (dB)
 3. The other emission levels were very low against the limit.
 4. Margin value = Emission level – Limit value.
 5. The limit value is defined as per 15.247
 6. “ * “ : Fundamental frequency



EUT	Flanker Pro Dual Radio AP	MODEL	AP-AG-AT-02
MODE	Channel 6	FREQUENCY RANGE	1000MHz~25000MHz
INPUT POWER (SYSTEM)	120Vac, 60Hz	DETECTOR FUNCTION	Peak(PK) Average (AV)
ENVIRONMENTAL CONDITIONS	23deg. C, 55%RH, 982 hPa	TESTED BY	Eric Lee

ANTENNA POLARITY & TEST DISTANCE: VERTICAL AT 3 M

No.	Freq. (MHz)	Emission Level (dBuV/m)	Limit (dBuV/m)	Margin (dB)	Antenna Height (m)	Table Angle (Degree)	Raw Value (dBuV)	Correction Factor (dB/m)
1	2016.00	53.30 PK	74.00	-20.70	1.11 V	41	24.00	29.20
1	2016.00	51.10 AV	54.00	-2.90	1.11 V	41	21.80	29.20
2	2320.00	60.90 PK	74.00	-13.10	1.58 V	64	30.70	30.20
2	2320.00	52.80 AV	54.00	-1.20	1.58 V	64	22.60	30.20
3	2360.00	60.30 PK	74.00	-13.70	1.28 V	45	30.00	30.30
3	2360.00	52.40 AV	54.00	-1.60	1.28 V	45	22.10	30.30
4	2390.00	56.50 PK	74.00	-17.50	1.55 V	22	26.10	30.40
4	2390.00	47.20 AV	54.00	-6.80	1.55 V	22	16.80	30.40
5	*2437.00	115.90 PK			1.11 V	2	85.20	30.70
5	*2437.00	106.90 AV			1.11 V	2	76.20	30.70
6	2483.50	60.80 PK	74.00	-13.20	1.54 V	74	29.80	31.00
6	2483.50	49.00 AV	54.00	-5.00	1.54 V	74	18.00	31.00
7	2496.00	59.80 PK	74.00	-14.20	1.28 V	54	29.00	30.80
7	2496.00	47.00 AV	54.00	-7.00	1.28 V	54	16.20	30.80
8	4874.00	48.60 PK	74.00	-25.40	1.04 V	201	12.10	36.50
9	7311.00	47.00 PK	74.00	-27.00	1.54 V	7	5.20	41.80
10	9748.00	49.70 PK	74.00	-24.30	1.02 V	35	5.10	44.60

- NOTE:**
1. Emission level(dBuV/m)=Raw Value(dBuV) + Correction Factor(dB)
 2. Correction Factor(dB/m) = Antenna Factor (dB/m) + Cable Factor (dB)
 3. The other emission levels were very low against the limit.
 4. Margin value = Emission level – Limit value.
 5. The limit value is defined as per 15.247
 6. “ * “ : Fundamental frequency



EUT	Flanker Pro Dual Radio AP	MODEL	AP-AG-AT-02
MODE	Channel 11	FREQUENCY RANGE	1000MHz~25000MHz
INPUT POWER (SYSTEM)	120Vac, 60Hz	DETECTOR FUNCTION	Peak(PK) Average (AV)
ENVIRONMENTAL CONDITIONS	23deg. C, 55%RH, 982 hPa	TESTED BY	Eric Lee

ANTENNA POLARITY & TEST DISTANCE: HORIZONTAL AT 3M

No.	Freq. (MHz)	Emission Level (dBuV/m)	Limit (dBuV/m)	Margin (dB)	Antenna Height (m)	Table Angle (Degree)	Raw Value (dBuV)	Correction Factor (dB/m)
1	2016.00	49.70 PK	74.00	-24.30	1.36 H	62	20.50	29.20
2	2320.00	50.90 PK	74.00	-23.10	1.02 H	65	20.70	30.20
3	2360.00	53.50 PK	74.00	-20.50	1.70 H	306	23.20	30.30
3	2360.00	45.00 AV	54.00	-9.00	1.70 H	306	14.60	30.30
4	*2462.00	102.10 PK			1.00 H	12	71.20	30.80
4	*2462.00	93.10 AV			1.00 H	12	62.20	30.80
5	2483.50	52.20 PK	74.00	-21.80	1.36 H	62	21.30	31.00
5	2483.50	46.20 AV	54.00	-7.80	1.36 H	62	15.30	31.00
6	2496.00	50.70 PK	74.00	-23.30	1.32 H	62	19.90	30.80
7	4924.00	41.90 PK	74.00	-32.10	1.54 H	241	5.20	36.70
8	7386.00	45.90 PK	74.00	-28.10	1.02 H	214	4.00	41.80
9	9848.00	48.00 PK	74.00	-26.00	1.54 H	23	3.70	44.40

- NOTE:**
1. Emission level(dBuV/m)=Raw Value(dBuV) + Correction Factor(dB)
 2. Correction Factor(dB/m) = Antenna Factor (dB/m) + Cable Factor (dB)
 3. The other emission levels were very low against the limit.
 4. Margin value = Emission level – Limit value.
 5. The limit value is defined as per 15.247
 6. “ * “ : Fundamental frequency



EUT	Flanker Pro Dual Radio AP	Model	AP-AG-AT-02
MODE	Channel 11	FREQUENCY RANGE	1000MHz~25000MHz
INPUT POWER (SYSTEM)	120Vac, 60Hz	DETECTOR FUNCTION	Peak(PK) Average (AV)
ENVIRONMENTAL CONDITIONS	23deg. C, 55%RH, 982 hPa	TESTED BY	Eric Lee

ANTENNA POLARITY & TEST DISTANCE: VERTICAL AT 3M

No.	Freq. (MHz)	Emission Level (dBuV/m)	Limit (dBuV/m)	Margin (dB)	Antenna Height (m)	Table Angle (Degree)	Raw Value (dBuV)	Correction Factor (dB/m)
1	2016.00	55.40 PK	74.00	-18.60	1.25 V	54	26.10	29.20
1	2016.00	53.10 AV	54.00	-0.90	1.25 V	54	23.80	29.20
2	2320.00	57.30 PK	74.00	-16.70	1.40 V	200	27.10	30.20
2	2320.00	49.30 AV	54.00	-4.70	1.40 V	200	19.10	30.20
3	2360.00	59.30 PK	74.00	-14.70	1.02 V	21	28.90	30.30
3	2360.00	51.50 AV	54.00	-2.50	1.02 V	21	21.10	30.30
4	*2462.00	110.00 PK			1.00 V	11	79.20	30.80
4	*2462.00	101.00 AV			1.00 V	11	70.20	30.80
5	2483.50	63.50 PK	74.00	-10.50	1.70 V	206	32.50	31.00
5	2483.50	53.10 AV	54.00	-0.90	1.70 V	206	22.10	31.00
6	2496.00	58.00 PK	74.00	-16.00	1.23 V	65	27.20	30.80
6	2496.00	45.70 AV	54.00	-8.30	1.23 V	65	15.00	30.80
7	4924.00	49.60 PK	74.00	-24.40	1.11 V	54	12.90	36.70
8	7386.00	50.60 PK	74.00	-23.40	1.68 V	9	8.70	41.80
9	9848.00	49.40 PK	74.00	-24.60	1.00 V	214	5.00	44.40

- NOTE:**
1. Emission level(dBuV/m)=Raw Value(dBuV) + Correction Factor(dB)
 2. Correction Factor(dB/m) = Antenna Factor (dB/m) + Cable Factor (dB)
 3. The other emission levels were very low against the limit.
 4. Margin value = Emission level – Limit value.
 5. The limit value is defined as per 15.247
 6. “ * “ : Fundamental frequency



4.2.16 TEST RESULTS - OFDM (ANTENNA 2)

EUT	Flanker Pro Dual Radio AP	MODEL	AP-AG-AT-02
MODE	Channel 1	FREQUENCY RANGE	1000MHz~25000MHz
INPUT POWER (SYSTEM)	120Vac, 60Hz	DETECTOR FUNCTION	Peak(PK) Average (AV)
ENVIRONMENTAL CONDITIONS	24deg. C, 60%RH, 982 hPa	TESTED BY	Eric Lee

ANTENNA POLARITY & TEST DISTANCE: HORIZONTAL AT 3 M

No.	Freq. (MHz)	Emission Level (dBuV/m)	Limit (dBuV/m)	Margin (dB)	Antenna Height (m)	Table Angle (Degree)	Raw Value (dBuV)	Correction Factor (dB/m)
1	2016.00	50.40 PK	74.00	-23.60	1.13 H	65	21.20	29.20
2	2320.00	49.00 PK	74.00	-25.00	1.55 H	247	18.90	30.20
3	2345.00	55.30 PK	74.00	-18.70	1.16 H	54	25.00	30.30
3	2345.00	46.10 AV	54.00	-7.90	1.16 H	54	15.80	30.30
4	2390.00	60.70 PK	74.00	-13.30	1.11 H	24	30.30	30.40
4	2390.00	50.70 AV	54.00	-3.30	1.11 H	24	20.20	30.40
5	*2412.00	105.60 PK			1.00 H	24	75.10	30.50
5	*2412.00	98.40 AV			1.00 H	24	67.80	30.50
6	2496.00	45.50 PK	74.00	-28.50	1.54 H	241	14.70	30.80
7	4824.00	52.80 PK	74.00	-21.20	1.54 H	74	16.60	36.20
7	4824.00	40.40 AV	54.00	-13.60	1.54 H	74	4.20	36.20
8	7236.00	47.50 PK	74.00	-26.50	1.42 H	20	5.80	41.70
9	9648.00	46.80 PK	74.00	-27.20	1.45 H	54	1.90	44.90

- NOTE:**
1. Emission level(dBuV/m)=Raw Value(dBuV) + Correction Factor(dB)
 2. Correction Factor(dB/m) = Antenna Factor (dB/m) + Cable Factor (dB)
 3. The other emission levels were very low against the limit.
 4. Margin value = Emission level – Limit value.
 5. The limit value is defined as per 15.247
 6. “ * “ : Fundamental frequency



EUT	Flanker Pro Dual Radio AP	MODEL	AP-AG-AT-02
MODE	Channel 1	FREQUENCY RANGE	1000MHz~25000MHz
INPUT POWER (SYSTEM)	120Vac, 60Hz	DETECTOR FUNCTION	Peak(PK) Average (AV)
ENVIRONMENTAL CONDITIONS	24deg. C, 60%RH, 982 hPa	TESTED BY	Eric Lee

ANTENNA POLARITY & TEST DISTANCE: VERTICAL AT 3 M

No.	Freq. (MHz)	Emission Level (dBuV/m)	Limit (dBuV/m)	Margin (dB)	Antenna Height (m)	Table Angle (Degree)	Raw Value (dBuV)	Correction Factor (dB/m)
1	2016.00	56.70 PK	74.00	-17.30	1.30 V	353	27.50	29.20
1	2016.00	50.00 AV	54.00	-4.00	1.30 V	353	20.80	29.20
2	2320.00	53.10 PK	74.00	-20.90	1.36 V	35	22.90	30.20
2	2320.00	42.90 AV	54.00	-11.10	1.36 V	35	12.70	30.20
3	2345.00	60.00 PK	74.00	-14.00	1.11 V	54	29.70	30.30
3	2345.00	48.60 AV	54.00	-5.40	1.11 V	54	18.30	30.30
4	2390.00	62.20 PK	74.00	-11.80	1.01 V	358	31.80	30.40
4	2390.00	52.90 AV	54.00	-1.10	1.01 V	358	22.50	30.40
5	*2412.00	107.40 PK			1.40 V	333	76.90	30.50
5	*2412.00	99.70 AV			1.40 V	333	69.10	30.50
6	2496.00	51.40 PK	74.00	-22.60	1.25 V	13	20.70	30.80
6	2496.00	45.50 AV	54.00	-8.50	1.25 V	13	14.70	30.80
7	4824.00	57.60 PK	74.00	-16.40	1.34 V	104	21.40	36.20
7	4824.00	46.20 AV	54.00	-7.80	1.34 V	104	9.90	36.20
8	7236.00	46.80 PK	74.00	-27.20	1.51 V	77	5.10	41.70
9	9648.00	46.90 PK	74.00	-27.10	1.63 V	54	2.00	44.90

- NOTE:**
1. Emission level(dBuV/m)=Raw Value(dBuV) + Correction Factor(dB)
 2. Correction Factor(dB/m) = Antenna Factor (dB/m) + Cable Factor (dB)
 3. The other emission levels were very low against the limit.
 4. Margin value = Emission level – Limit value.
 5. The limit value is defined as per 15.247
 6. “ * “ : Fundamental frequency



EUT	Flanker Pro Dual Radio AP	MODEL	AP-AG-AT-02
MODE	Channel 6	FREQUENCY RANGE	1000MHz~25000MHz
INPUT POWER (SYSTEM)	120Vac, 60Hz	DETECTOR FUNCTION	Peak(PK) Average (AV)
ENVIRONMENTAL CONDITIONS	24deg. C, 60%RH, 982 hPa	TESTED BY	Eric Lee

ANTENNA POLARITY & TEST DISTANCE: HORIZONTAL AT 3 M

No.	Freq. (MHz)	Emission Level (dBuV/m)	Limit (dBuV/m)	Margin (dB)	Antenna Height (m)	Table Angle (Degree)	Raw Value (dBuV)	Correction Factor (dB/m)
1	2016.00	52.50 PK	74.00	-21.50	1.11 H	2	23.30	29.20
1	2016.00	50.80 AV	54.00	-3.20	1.11 H	2	21.60	29.20
2	2320.00	49.90 PK	74.00	-24.10	1.54 H	325	19.70	30.20
3	2360.00	46.50 PK	74.00	-27.50	1.35 H	24	16.20	30.30
4	2390.00	53.20 PK	74.00	-20.80	1.00 H	345	22.70	30.40
4	2390.00	42.40 AV	54.00	-11.60	1.00 H	345	12.00	30.40
5	*2437.00	109.70 PK			1.23 H	6	79.00	30.70
5	*2437.00	101.70 AV			1.23 H	6	71.00	30.70
6	2483.50	52.00 PK	74.00	-22.00	1.11 H	23	21.00	31.00
6	2483.50	40.60 AV	54.00	-13.40	1.11 H	23	9.60	31.00
7	2496.00	47.30 PK	74.00	-26.70	1.33 H	62	16.60	30.80
8	4874.00	53.00 PK	74.00	-21.00	1.87 H	87	16.50	36.50
8	4874.00	42.30 AV	54.00	-11.70	1.87 H	87	5.90	36.50
9	7311.00	46.60 PK	74.00	-27.40	1.01 H	24	4.90	41.80
10	9748.00	47.10 PK	74.00	-26.90	1.53 H	62	2.40	44.60

- NOTE:**
1. Emission level(dBuV/m)=Raw Value(dBuV) + Correction Factor(dB)
 2. Correction Factor(dB/m) = Antenna Factor (dB/m) + Cable Factor (dB)
 3. The other emission levels were very low against the limit.
 4. Margin value = Emission level – Limit value.
 5. The limit value is defined as per 15.247
 6. “ * “ : Fundamental frequency



EUT	Flanker Pro Dual Radio AP	MODEL	AP-AG-AT-02
MODE	Channel 6	FREQUENCY RANGE	1000MHz~25000MHz
INPUT POWER (SYSTEM)	120Vac, 60Hz	DETECTOR FUNCTION	Peak(PK) Average (AV)
ENVIRONMENTAL CONDITIONS	24deg. C, 60%RH, 982 hPa	TESTED BY	Eric Lee

ANTENNA POLARITY & TEST DISTANCE: VERTICAL AT 3 M

No.	Freq. (MHz)	Emission Level (dBuV/m)	Limit (dBuV/m)	Margin (dB)	Antenna Height (m)	Table Angle (Degree)	Raw Value (dBuV)	Correction Factor (dB/m)
1	2016.00	57.40 PK	74.00	-16.60	1.45 V	24	28.10	29.20
2	2320.00	53.80 PK	74.00	-20.20	1.01 V	201	23.60	30.20
2	2320.00	44.90 AV	54.00	-9.10	1.01 V	201	14.70	30.20
3	2360.00	53.10 PK	74.00	-20.90	1.51 V	77	22.80	30.30
3	2360.00	43.40 AV	54.00	-10.60	1.51 V	77	13.10	30.30
4	2390.00	62.90 PK	74.00	-11.10	1.53 V	65	32.50	30.40
4	2390.00	49.50 AV	54.00	-4.50	1.53 V	65	19.10	30.40
5	*2437.00	110.90 PK			1.54 V	24	80.30	30.70
5	*2437.00	104.40 AV			1.54 V	24	73.70	30.70
6	2483.50	59.30 PK	74.00	-14.70	1.47 V	54	28.30	31.00
6	2483.50	48.90 AV	54.00	-5.10	1.47 V	54	18.00	31.00
7	2496.00	54.40 PK	74.00	-19.60	1.65 V	36	23.60	30.80
7	2496.00	47.40 AV	54.00	-6.60	1.65 V	36	16.60	30.80
8	4874.00	58.00 PK	74.00	-16.00	1.02 V	35	21.50	36.50
8	4874.00	46.90 AV	54.00	-7.10	1.02 V	35	10.50	36.50
9	7311.00	48.00 PK	74.00	-26.00	1.54 V	24	6.30	41.80
10	9748.00	48.10 PK	74.00	-25.90	1.11 V	25	3.40	44.60

- NOTE:**
1. Emission level(dBuV/m)=Raw Value(dBuV) + Correction Factor(dB)
 2. Correction Factor(dB/m) = Antenna Factor (dB/m) + Cable Factor (dB)
 3. The other emission levels were very low against the limit.
 4. Margin value = Emission level – Limit value.
 5. The limit value is defined as per 15.247
 6. “ * “ : Fundamental frequency



EUT	Flanker Pro Dual Radio AP	MODEL	AP-AG-AT-02
MODE	Channel 11	FREQUENCY RANGE	1000MHz~25000MHz
INPUT POWER (SYSTEM)	120Vac, 60Hz	DETECTOR FUNCTION	Peak(PK) Average (AV)
ENVIRONMENTAL CONDITIONS	24deg. C, 60%RH, 982 hPa	TESTED BY	Eric Lee

ANTENNA POLARITY & TEST DISTANCE: HORIZONTAL AT 3M

No.	Freq. (MHz)	Emission Level (dBuV/m)	Limit (dBuV/m)	Margin (dB)	Antenna Height (m)	Table Angle (Degree)	Raw Value (dBuV)	Correction Factor (dB/m)
1	2016.00	47.00 PK	74.00	-27.00	1.69 H	68	17.80	29.20
2	2320.00	47.00 PK	74.00	-27.00	1.11 H	54	16.80	30.20
3	2360.00	54.10 PK	74.00	-19.90	1.69 H	65	23.80	30.30
3	2360.00	41.10 AV	54.00	-12.90	1.69 H	65	10.80	30.30
4	*2462.00	105.00 PK			1.58 H	57	74.20	30.80
4	*2462.00	97.80 AV			1.58 H	57	67.00	30.80
5	2483.50	57.60 PK	74.00	-16.40	1.11 H	25	26.60	31.00
5	2483.50	48.30 AV	54.00	-5.70	1.11 H	25	17.40	31.00
6	2496.00	49.80 PK	74.00	-24.20	1.23 H	65	19.00	30.80
7	4924.00	51.80 PK	74.00	-22.20	1.01 H	47	15.10	36.70
7	4924.00	40.80 AV	54.00	-13.20	1.01 H	47	4.10	36.70
8	7386.00	47.30 PK	74.00	-26.70	1.54 H	74	5.50	41.80
9	9848.00	47.00 PK	74.00	-27.00	1.11 H	25	2.70	44.40

- NOTE:**
1. Emission level(dBuV/m)=Raw Value(dBuV) + Correction Factor(dB)
 2. Correction Factor(dB/m) = Antenna Factor (dB/m) + Cable Factor (dB)
 3. The other emission levels were very low against the limit.
 4. Margin value = Emission level – Limit value.
 5. The limit value is defined as per 15.247
 6. “ * “ : Fundamental frequency



EUT	Flanker Pro Dual Radio AP	MODEL	AP-AG-AT-02
MODE	Channel 11	FREQUENCY RANGE	1000MHz~25000MHz
INPUT POWER (SYSTEM)	120Vac, 60Hz	DETECTOR FUNCTION	Peak(PK) Average (AV)
ENVIRONMENTAL CONDITIONS	24deg. C, 60%RH, 982 hPa	TESTED BY	Eric Lee

ANTENNA POLARITY & TEST DISTANCE: VERTICAL AT 3M

No.	Freq. (MHz)	Emission Level (dBuV/m)	Limit (dBuV/m)	Margin (dB)	Antenna Height (m)	Table Angle (Degree)	Raw Value (dBuV)	Correction Factor (dB/m)
1	2016.00	51.40 PK	74.00	-22.60	1.02 V	4	22.20	29.20
1	2016.00	48.80 AV	54.00	-5.20	1.02 V	4	19.60	29.20
2	2320.00	51.00 PK	74.00	-23.00	1.63 V	65	20.80	30.20
2	2320.00	42.70 AV	54.00	-11.30	1.63 V	65	12.50	30.20
3	2360.00	57.50 PK	74.00	-16.50	1.55 V	178	27.20	30.30
3	2360.00	46.40 AV	54.00	-7.60	1.55 V	178	16.10	30.30
4	*2462.00	108.10 PK			1.01 V	248	77.20	30.80
4	*2462.00	100.50 AV			1.01 V	248	69.70	30.80
5	2483.50	61.20 PK	74.00	-12.80	1.53 V	62	30.30	31.00
5	2483.50	51.90 AV	54.00	-2.10	1.53 V	62	20.90	31.00
6	2496.00	53.40 PK	74.00	-20.60	1.02 V	32	22.60	30.80
6	2496.00	46.40 AV	54.00	-7.60	1.02 V	32	15.60	30.80
7	4924.00	55.90 PK	74.00	-18.10	1.11 V	54	19.20	36.70
7	4924.00	44.80 AV	54.00	-9.20	1.11 V	54	8.10	36.70
8	7386.00	47.20 PK	74.00	-26.80	1.54 V	68	5.40	41.80
9	9848.00	47.80 PK	74.00	-26.20	1.45 V	24	3.40	44.40

- NOTE:**
1. Emission level(dBuV/m)=Raw Value(dBuV) + Correction Factor(dB)
 2. Correction Factor(dB/m) = Antenna Factor (dB/m) + Cable Factor (dB)
 3. The other emission levels were very low against the limit.
 4. Margin value = Emission level – Limit value.
 5. The limit value is defined as per 15.247
 6. “ * “ : Fundamental frequency



4.2.17 TEST RESULTS - OFDM (ANTENNA 3)

EUT	Flanker Pro Dual Radio AP	MODEL	AP-AG-AT-02
MODE	Channel 1	FREQUENCY RANGE	1000MHz~25000MHz
INPUT POWER (SYSTEM)	120Vac, 60Hz	DETECTOR FUNCTION	Peak(PK) Average (AV)
ENVIRONMENTAL CONDITIONS	23deg. C, 55%RH, 982 hPa	TESTED BY	Eric Lee

ANTENNA POLARITY & TEST DISTANCE: HORIZONTAL AT 3 M

No.	Freq. (MHz)	Emission Level (dBuV/m)	Limit (dBuV/m)	Margin (dB)	Antenna Height (m)	Table Angle (Degree)	Raw Value (dBuV)	Correction Factor (dB/m)
1	1911.00	57.20 PK	74.00	-16.80	1.83 H	64	28.20	29.00
1	1911.00	40.10 AV	54.00	-13.90	1.83 H	64	11.10	29.00
2	2016.00	43.10 PK	74.00	-30.90	1.52 H	20	13.90	29.20
3	2360.00	56.20 PK	74.00	-17.80	1.90 H	246	25.90	30.30
3	2360.00	47.00 AV	54.00	-7.00	1.90 H	246	16.70	30.30
4	2390.00	59.20 PK	74.00	-14.80	1.01 H	24	28.80	30.40
4	2390.00	49.70 AV	54.00	-4.30	1.01 H	24	19.30	30.40
5	*2412.00	102.70 PK			1.54 H	24	72.10	30.50
5	*2412.00	94.70 AV			1.54 H	24	64.20	30.50
6	2918.00	51.10 PK	74.00	-22.90	1.75 H	333	19.10	32.00
6	2918.00	34.80 AV	54.00	-19.20	1.75 H	333	2.90	32.00
7	4824.00	40.80 PK	74.00	-33.20	1.11 H	359	4.60	36.20
8	7236.00	46.40 PK	74.00	-27.60	1.11 H	24	4.70	41.70
9	9648.00	47.50 PK	74.00	-26.50	1.68 H	74	2.60	44.90

- NOTE:**
1. Emission level(dBuV/m)=Raw Value(dBuV) + Correction Factor(dB)
 2. Correction Factor(dB/m) = Antenna Factor (dB/m) + Cable Factor (dB)
 3. The other emission levels were very low against the limit.
 4. Margin value = Emission level – Limit value.
 5. The limit value is defined as per 15.247
 6. “ * “ : Fundamental frequency



EUT	Flanker Pro Dual Radio AP	MODEL	AP-AG-AT-02
MODE	Channel 1	FREQUENCY RANGE	1000MHz~25000MHz
INPUT POWER (SYSTEM)	120Vac, 60Hz	DETECTOR FUNCTION	Peak(PK) Average (AV)
ENVIRONMENTAL CONDITIONS	23deg. C, 55%RH, 982 hPa	TESTED BY	Eric Lee

ANTENNA POLARITY & TEST DISTANCE: VERTICAL AT 3 M

No.	Freq. (MHz)	Emission Level (dBuV/m)	Limit (dBuV/m)	Margin (dB)	Antenna Height (m)	Table Angle (Degree)	Raw Value (dBuV)	Correction Factor (dB/m)
1	1911.00	60.80 PK	74.00	-13.20	1.54 V	24	31.80	29.00
1	1911.00	42.00 AV	54.00	-12.00	1.54 V	24	13.00	29.00
2	2016.00	44.50 PK	74.00	-29.50	1.25 V	24	15.20	29.20
3	2360.00	60.40 PK	74.00	-13.60	1.47 V	54	30.00	30.30
3	2360.00	51.20 AV	54.00	-2.80	1.47 V	54	20.90	30.30
4	2390.00	63.50 PK	74.00	-10.50	1.11 V	20	33.10	30.40
4	2390.00	53.00 AV	54.00	-1.00	1.11 V	20	22.60	30.40
5	*2412.00	106.40 PK			1.26 V	35	75.80	30.50
5	*2412.00	98.30 AV			1.26 V	35	67.80	30.50
6	2918.00	60.10 PK	74.00	-13.90	1.02 V	35	28.20	32.00
6	2918.00	39.10 AV	54.00	-14.90	1.02 V	35	7.20	32.00
7	4824.00	49.20 PK	74.00	-24.80	1.40 V	20	13.00	36.20
8	7236.00	49.90 PK	74.00	-24.10	1.75 V	36	8.20	41.70
9	9648.00	50.80 PK	74.00	-23.20	1.11 V	25	5.90	44.90

- NOTE:**
1. Emission level(dBuV/m)=Raw Value(dBuV) + Correction Factor(dB)
 2. Correction Factor(dB/m) = Antenna Factor (dB/m) + Cable Factor (dB)
 3. The other emission levels were very low against the limit.
 4. Margin value = Emission level – Limit value.
 5. The limit value is defined as per 15.247
 6. “ * “ : Fundamental frequency



EUT	Flanker Pro Dual Radio AP	MODEL	AP-AG-AT-02
MODE	Channel 6	FREQUENCY RANGE	1000MHz~25000MHz
INPUT POWER (SYSTEM)	120Vac, 60Hz	DETECTOR FUNCTION	Peak(PK) Average (AV)
ENVIRONMENTAL CONDITIONS	23deg. C, 55%RH, 982 hPa	TESTED BY	Eric Lee

ANTENNA POLARITY & TEST DISTANCE: HORIZONTAL AT 3 M

No.	Freq. (MHz)	Emission Level (dBuV/m)	Limit (dBuV/m)	Margin (dB)	Antenna Height (m)	Table Angle (Degree)	Raw Value (dBuV)	Correction Factor (dB/m)
1	1954.00	58.30 PK	74.00	-15.70	1.36 H	95	29.20	29.10
1	1954.00	39.70 AV	54.00	-14.30	1.36 H	95	10.60	29.10
2	2016.00	42.40 PK	74.00	-31.60	1.11 H	20	13.10	29.20
3	2320.00	55.30 PK	74.00	-18.70	1.55 H	347	25.10	30.20
3	2320.00	45.30 AV	54.00	-8.70	1.55 H	347	15.10	30.20
4	2390.00	52.60 PK	74.00	-21.40	1.11 H	20	22.20	30.40
4	2390.00	41.50 AV	54.00	-12.50	1.11 H	20	11.10	30.40
5	*2437.00	65.30 PK			1.54 H	87	34.60	30.70
5	*2437.00	57.40 AV			1.54 H	87	26.70	30.70
6	2483.50	47.90 PK	74.00	-26.10	1.54 H	74	16.90	31.00
7	4874.00	44.60 PK	74.00	-29.40	1.65 H	24	8.10	36.50
8	7311.00	47.40 PK	74.00	-26.60	1.30 H	2	5.60	41.80
9	9748.00	49.60 PK	74.00	-24.40	1.02 H	7	4.90	44.60

- NOTE:**
1. Emission level(dBuV/m)=Raw Value(dBuV) + Correction Factor(dB)
 2. Correction Factor(dB/m) = Antenna Factor (dB/m) + Cable Factor (dB)
 3. The other emission levels were very low against the limit.
 4. Margin value = Emission level – Limit value.
 5. The limit value is defined as per 15.247
 6. “ * “ : Fundamental frequency



EUT	Flanker Pro Dual Radio AP	MODEL	AP-AG-AT-02
MODE	Channel 6	FREQUENCY RANGE	1000MHz~25000MHz
INPUT POWER (SYSTEM)	120Vac, 60Hz	DETECTOR FUNCTION	Peak(PK) Average (AV)
ENVIRONMENTAL CONDITIONS	23deg. C, 55%RH, 982 hPa	TESTED BY	Eric Lee

ANTENNA POLARITY & TEST DISTANCE: VERTICAL AT 3 M

No.	Freq. (MHz)	Emission Level (dBuV/m)	Limit (dBuV/m)	Margin (dB)	Antenna Height (m)	Table Angle (Degree)	Raw Value (dBuV)	Correction Factor (dB/m)
1	1911.00	59.80 PK	74.00	-14.20	1.11 V	6	30.80	29.00
1	1911.00	42.10 AV	54.00	-11.90	1.11 V	6	13.10	29.00
2	2016.00	53.40 PK	74.00	-20.60	1.02 V	3	24.10	29.20
2	2016.00	48.40 AV	54.00	-5.60	1.02 V	3	19.10	29.20
3	2320.00	52.90 PK	74.00	-21.10	1.54 V	25	22.70	30.20
3	2320.00	48.90 AV	54.00	-5.10	1.54 V	25	18.70	30.20
4	2390.00	62.50 PK	74.00	-11.50	1.47 V	54	32.10	30.40
4	2390.00	47.50 AV	54.00	-6.50	1.47 V	54	17.10	30.40
5	*2437.00	98.90 PK			1.01 V	154	68.20	30.70
5	*2437.00	82.90 AV			1.01 V	154	52.20	30.70
6	2483.50	63.30 PK	74.00	-10.70	1.23 V	30	32.40	31.00
6	2483.50	49.60 AV	54.00	-4.40	1.23 V	30	18.70	31.00
7	4874.00	48.60 PK	74.00	-25.40	1.47 V	5	12.10	36.50
8	7311.00	46.60 PK	74.00	-27.40	1.47 V	54	4.80	41.80
9	9748.00	49.60 PK	74.00	-24.40	1.54 V	24	5.00	44.60

- NOTE:**
1. Emission level(dBuV/m)=Raw Value(dBuV) + Correction Factor(dB)
 2. Correction Factor(dB/m) = Antenna Factor (dB/m) + Cable Factor (dB)
 3. The other emission levels were very low against the limit.
 4. Margin value = Emission level – Limit value.
 5. The limit value is defined as per 15.247
 6. “ * “ : Fundamental frequency



EUT	Flanker Pro Dual Radio AP	MODEL	AP-AG-AT-02
MODE	Channel 11	FREQUENCY RANGE	1000MHz~25000MHz
INPUT POWER (SYSTEM)	120Vac, 60Hz	DETECTOR FUNCTION	Peak(PK) Average (AV)
ENVIRONMENTAL CONDITIONS	23deg. C, 55%RH, 982 hPa	TESTED BY	Eric Lee

ANTENNA POLARITY & TEST DISTANCE: HORIZONTAL AT 3M

No.	Freq. (MHz)	Emission Level (dBuV/m)	Limit (dBuV/m)	Margin (dB)	Antenna Height (m)	Table Angle (Degree)	Raw Value (dBuV)	Correction Factor (dB/m)
1	2016.00	43.60 PK	74.00	-30.40	1.23 H	65	14.40	29.20
2	2320.00	58.00 PK	74.00	-16.00	1.36 H	95	27.80	30.20
2	2320.00	48.40 AV	54.00	-5.60	1.36 H	95	18.20	30.20
3	2360.00	50.20 PK	74.00	-23.80	1.35 H	62	19.90	30.30
4	*2462.00	102.10 PK			1.11 H	47	71.30	30.80
4	*2462.00	95.00 AV			1.11 H	47	64.20	30.80
5	2483.50	57.20 PK	74.00	-16.80	1.23 H	333	26.20	31.00
5	2483.50	48.30 AV	54.00	-5.70	1.23 H	333	17.40	31.00
6	4924.00	42.10 PK	74.00	-31.90	1.25 H	4	5.40	36.70
7	7386.00	48.30 PK	74.00	-25.70	1.30 H	206	6.40	41.80
8	9848.00	49.10 PK	74.00	-24.90	1.02 H	201	4.70	44.40

- NOTE:**
1. Emission level(dBuV/m)=Raw Value(dBuV) + Correction Factor(dB)
 2. Correction Factor(dB/m) = Antenna Factor (dB/m) + Cable Factor (dB)
 3. The other emission levels were very low against the limit.
 4. Margin value = Emission level – Limit value.
 5. The limit value is defined as per 15.247
 6. “ * “ : Fundamental frequency



EUT	Flanker Pro Dual Radio AP	MODEL	AP-AG-AT-02
MODE	Channel 11	FREQUENCY RANGE	1000MHz~25000MHz
INPUT POWER (SYSTEM)	120Vac, 60Hz	DETECTOR FUNCTION	Peak(PK) Average (AV)
ENVIRONMENTAL CONDITIONS	23deg. C, 55%RH, 982 hPa	TESTED BY	Eric Lee

ANTENNA POLARITY & TEST DISTANCE: VERTICAL AT 3M

No.	Freq. (MHz)	Emission Level (dBuV/m)	Limit (dBuV/m)	Margin (dB)	Antenna Height (m)	Table Angle (Degree)	Raw Value (dBuV)	Correction Factor (dB/m)
1	2016.00	45.40 PK	74.00	-28.60	1.45 V	77	16.10	29.20
2	2320.00	59.00 PK	74.00	-15.00	1.32 V	65	28.80	30.20
2	2320.00	51.30 AV	54.00	-2.70	1.32 V	65	21.20	30.20
3	2360.00	53.20 PK	74.00	-20.80	1.32 V	65	22.90	30.30
3	2360.00	43.10 AV	54.00	-10.90	1.32 V	65	12.70	30.30
4	*2462.00	105.40 PK			1.02 V	108	74.60	30.80
4	*2462.00	98.40 AV			1.02 V	108	67.50	30.80
5	2483.50	62.20 PK	74.00	-11.80	1.45 V	24	31.30	31.00
5	2483.50	52.00 AV	54.00	-2.00	1.45 V	24	21.10	31.00
6	4924.00	49.80 PK	74.00	-24.20	1.02 V	47	13.10	36.70
7	7386.00	49.70 PK	74.00	-24.30	1.21 V	4	7.80	41.80
8	9848.00	50.60 PK	74.00	-23.40	1.54 V	24	6.20	44.40

- NOTE:**
1. Emission level(dBuV/m)=Raw Value(dBuV) + Correction Factor(dB)
 2. Correction Factor(dB/m) = Antenna Factor (dB/m) + Cable Factor (dB)
 3. The other emission levels were very low against the limit.
 4. Margin value = Emission level – Limit value.
 5. The limit value is defined as per 15.247
 6. “ * “ : Fundamental frequency



4.2.18 TEST RESULTS - OFDM (ANTENNA 4)

EUT	Flanker Pro Dual Radio AP	MODEL	AP-AG-AT-02
MODE	Channel 1	FREQUENCY RANGE	1000MHz~25000MHz
INPUT POWER (SYSTEM)	120Vac, 60Hz	DETECTOR FUNCTION	Peak(PK) Average (AV)
ENVIRONMENTAL CONDITIONS	23deg. C, 55%RH, 982 hPa	TESTED BY	Eric Lee

ANTENNA POLARITY & TEST DISTANCE: HORIZONTAL AT 3 M

No.	Freq. (MHz)	Emission Level (dBuV/m)	Limit (dBuV/m)	Margin (dB)	Antenna Height (m)	Table Angle (Degree)	Raw Value (dBuV)	Correction Factor (dB/m)
1	2016.00	50.10 PK	74.00	-23.90	1.45 H	21	20.90	29.20
2	2292.00	56.20 PK	74.00	-17.80	1.42 H	302	26.10	30.10
2	2292.00	45.80 AV	54.00	-8.20	1.42 H	302	15.70	30.10
3	2360.00	48.60 PK	74.00	-25.40	1.32 H	65	18.30	30.30
4	2390.00	56.10 PK	74.00	-17.90	1.63 H	32	25.70	30.40
4	2390.00	45.70 AV	54.00	-8.30	1.63 H	32	15.20	30.40
5	*2412.00	102.60 PK			1.02 H	45	72.10	30.50
5	*2412.00	93.80 AV			1.02 H	45	63.20	30.50
6	4824.00	40.40 PK	74.00	-33.60	1.54 H	24	4.20	36.20
7	7236.00	47.50 PK	74.00	-26.50	1.02 H	302	5.80	41.70
8	9648.00	48.10 PK	74.00	-25.90	1.11 H	52	3.20	44.90

ANTENNA POLARITY & TEST DISTANCE: VERTICAL AT 3 M

No.	Freq. (MHz)	Emission Level (dBuV/m)	Limit (dBuV/m)	Margin (dB)	Antenna Height (m)	Table Angle (Degree)	Raw Value (dBuV)	Correction Factor (dB/m)
1	2016.00	55.10 PK	74.00	-18.90	1.41 V	359	25.90	29.20
2	2292.00	59.20 PK	74.00	-14.80	1.39 V	40	29.10	30.10
2	2292.00	49.00 AV	54.00	-5.00	1.39 V	40	18.90	30.10
3	2360.00	59.60 PK	74.00	-14.40	1.47 V	54	29.30	30.30
3	2360.00	48.60 AV	54.00	-5.40	1.47 V	54	18.20	30.30
4	2390.00	61.30 PK	74.00	-12.70	1.58 V	62	30.90	30.40
4	2390.00	51.90 AV	54.00	-2.10	1.58 V	62	21.50	30.40
5	*2412.00	109.10 PK			1.35 V	333	78.60	30.50
5	*2412.00	100.70 AV			1.35 V	333	70.20	30.50
6	4824.00	44.40 PK	74.00	-29.60	1.65 V	24	8.20	36.20
7	7236.00	50.10 PK	74.00	-23.90	1.20 V	24	8.40	41.70
8	9648.00	50.50 PK	74.00	-23.50	1.41 V	332	5.60	44.90

- NOTE:**
1. Emission level(dBuV/m)=Raw Value(dBuV) + Correction Factor(dB)
 2. Correction Factor(dB/m) = Antenna Factor (dB/m) + Cable Factor (dB)
 3. The other emission levels were very low against the limit.
 4. Margin value = Emission level – Limit value.
 5. The limit value is defined as per 15.247
 6. " * " : Fundamental frequency



EUT	Flanker Pro Dual Radio AP	MODEL	AP-AG-AT-02
MODE	Channel 6	FREQUENCY RANGE	1000MHz~25000MHz
INPUT POWER (SYSTEM)	120Vac, 60Hz	DETECTOR FUNCTION	Peak(PK) Average (AV)
ENVIRONMENTAL CONDITIONS	23deg. C, 55%RH, 982 hPa	TESTED BY	Eric Lee

ANTENNA POLARITY & TEST DISTANCE: HORIZONTAL AT 3 M

No.	Freq. (MHz)	Emission Level (dBuV/m)	Limit (dBuV/m)	Margin (dB)	Antenna Height (m)	Table Angle (Degree)	Raw Value (dBuV)	Correction Factor (dB/m)
1	2016.00	47.10 PK	74.00	-26.90	1.45 H	23	17.90	29.20
2	2263.00	47.60 PK	74.00	-26.40	1.45 H	25	17.60	30.00
3	2298.00	50.20 PK	74.00	-23.80	1.36 H	65	20.10	30.10
4	2390.00	53.20 PK	74.00	-20.80	1.35 H	63	22.80	30.40
4	2390.00	42.60 AV	54.00	-11.40	1.35 H	63	12.10	30.40
5	*2437.00	105.90 PK			1.40 H	63	75.20	30.70
5	*2437.00	98.20 AV			1.40 H	63	67.60	30.70
6	2483.50	52.60 PK	74.00	-21.40	1.22 H	45	21.70	31.00
6	2483.50	41.60 AV	54.00	-12.40	1.22 H	45	10.70	31.00
7	4874.00	45.60 PK	74.00	-28.40	1.32 H	65	9.10	36.50
8	7311.00	47.60 PK	74.00	-26.40	1.02 H	4	5.90	41.80
9	9748.00	51.10 PK	74.00	-22.90	1.02 H	69	6.40	44.60
9	9748.00	40.70 AV	54.00	-13.30	1.02 H	69	-3.90	44.60

- NOTE:**
1. Emission level(dBuV/m)=Raw Value(dBuV) + Correction Factor(dB)
 2. Correction Factor(dB/m) = Antenna Factor (dB/m) + Cable Factor (dB)
 3. The other emission levels were very low against the limit.
 4. Margin value = Emission level – Limit value.
 5. The limit value is defined as per 15.247
 6. “ * “ : Fundamental frequency



EUT	Flanker Pro Dual Radio AP	MODEL	AP-AG-AT-02
MODE	Channel 6	FREQUENCY RANGE	1000MHz~25000MHz
INPUT POWER (SYSTEM)	120Vac, 60Hz	DETECTOR FUNCTION	Peak(PK) Average (AV)
ENVIRONMENTAL CONDITIONS	23deg. C, 55%RH, 982 hPa	TESTED BY	Eric Lee

ANTENNA POLARITY & TEST DISTANCE: VERTICAL AT 3 M

No.	Freq. (MHz)	Emission Level (dBuV/m)	Limit (dBuV/m)	Margin (dB)	Antenna Height (m)	Table Angle (Degree)	Raw Value (dBuV)	Correction Factor (dB/m)
1	2016.00	51.50 PK	74.00	-22.50	1.55 V	24	22.30	29.20
1	2016.00	50.20 AV	54.00	-3.80	1.55 V	24	20.90	29.20
2	2263.00	55.80 PK	74.00	-18.20	1.08 V	75	25.80	30.00
2	2263.00	44.50 AV	54.00	-9.50	1.08 V	75	14.50	30.00
3	2298.00	53.10 PK	74.00	-20.90	1.28 V	14	22.90	30.10
3	2298.00	45.50 AV	54.00	-8.50	1.28 V	14	15.40	30.10
4	2390.00	62.90 PK	74.00	-11.10	1.02 V	3	32.50	30.40
4	2390.00	51.60 AV	54.00	-2.40	1.02 V	3	21.20	30.40
5	*2437.00	113.00 PK			1.25 V	24	82.30	30.70
5	*2437.00	104.90 AV			1.25 V	24	74.30	30.70
6	2483.50	62.30 PK	74.00	-11.70	1.54 V	24	31.30	31.00
6	2483.50	47.90 AV	54.00	-6.10	1.54 V	24	16.90	31.00
7	4874.00	45.90 PK	74.00	-28.10	1.57 V	84	9.50	36.50
8	7311.00	52.40 PK	74.00	-21.60	1.57 V	36	10.60	41.80
8	7311.00	41.40 AV	54.00	-12.60	1.57 V	36	-0.40	41.80
9	9748.00	54.00 PK	74.00	-20.00	1.45 V	321	9.30	44.60
9	9748.00	40.00 AV	54.00	-14.00	1.45 V	321	-4.60	44.60

- NOTE:**
1. Emission level(dBuV/m)=Raw Value(dBuV) + Correction Factor(dB)
 2. Correction Factor(dB/m) = Antenna Factor (dB/m) + Cable Factor (dB)
 3. The other emission levels were very low against the limit.
 4. Margin value = Emission level – Limit value.
 5. The limit value is defined as per 15.247
 6. “ * “ : Fundamental frequency



EUT	Flanker Pro Dual Radio AP	MODEL	AP-AG-AT-02
MODE	Channel 11	FREQUENCY RANGE	1000MHz~25000MHz
INPUT POWER (SYSTEM)	120Vac, 60Hz	DETECTOR FUNCTION	Peak(PK) Average (AV)
ENVIRONMENTAL CONDITIONS	23deg. C, 55%RH, 982 hPa	TESTED BY	Eric Lee

ANTENNA POLARITY & TEST DISTANCE: HORIZONTAL AT 3M

No.	Freq. (MHz)	Emission Level (dBuV/m)	Limit (dBuV/m)	Margin (dB)	Antenna Height (m)	Table Angle (Degree)	Raw Value (dBuV)	Correction Factor (dB/m)
1	2016.00	45.30 PK	74.00	-28.70	1.02 H	41	16.10	29.20
2	2294.00	50.80 PK	74.00	-23.20	1.24 H	24	20.70	30.10
3	*2462.00	102.90 PK			1.28 H	242	72.00	30.80
3	*2462.00	93.50 AV			1.28 H	242	62.70	30.80
4	2483.50	54.60 PK	74.00	-19.40	1.54 H	25	23.60	31.00
4	2483.50	43.20 AV	54.00	-10.80	1.54 H	25	12.20	31.00
5	4924.00	42.80 PK	74.00	-31.20	1.00 H	241	6.10	36.70
6	7386.00	49.90 PK	74.00	-24.10	1.24 H	25	8.00	41.80
7	9848.00	50.00 PK	74.00	-24.00	1.02 H	69	5.60	44.40

ANTENNA POLARITY & TEST DISTANCE: VERTICAL AT 3M

No.	Freq. (MHz)	Emission Level (dBuV/m)	Limit (dBuV/m)	Margin (dB)	Antenna Height (m)	Table Angle (Degree)	Raw Value (dBuV)	Correction Factor (dB/m)
1	2016.00	52.10 PK	74.00	-21.90	1.11 V	36	22.90	29.20
1	2016.00	50.40 AV	54.00	-3.60	1.11 V	36	21.20	29.20
2	2294.00	56.80 PK	74.00	-17.20	1.65 V	234	26.70	30.10
2	2294.00	46.20 AV	54.00	-7.80	1.65 V	234	16.10	30.10
3	*2462.00	111.00 PK			1.37 V	158	80.20	30.80
3	*2462.00	102.00 AV			1.37 V	158	71.20	30.80
4	2483.50	63.30 PK	74.00	-10.70	1.11 V	3	32.30	31.00
4	2483.50	53.00 AV	54.00	-1.00	1.11 V	3	22.00	31.00
5	4924.00	44.80 PK	74.00	-29.20	1.20 V	201	8.10	36.70
6	7386.00	51.20 PK	74.00	-22.80	1.54 V	241	9.40	41.80
6	7386.00	41.20 AV	54.00	-12.80	1.54 V	241	-0.60	41.80
7	9848.00	50.00 PK	74.00	-24.00	1.02 V	55	5.60	44.40

- NOTE:**
1. Emission level(dBuV/m)=Raw Value(dBuV) + Correction Factor(dB)
 2. Correction Factor(dB/m) = Antenna Factor (dB/m) + Cable Factor (dB)
 3. The other emission levels were very low against the limit.
 4. Margin value = Emission level – Limit value.
 5. The limit value is defined as per 15.247
 6. " * " : Fundamental frequency



4.2.19 TEST RESULTS - OFDM (ANTENNA 5)

EUT	Flanker Pro Dual Radio AP	MODEL	AP-AG-AT-02
MODE	Channel 1	FREQUENCY RANGE	1000MHz~25000MHz
INPUT POWER (SYSTEM)	120Vac, 60Hz	DETECTOR FUNCTION	Peak(PK) Average (AV)
ENVIRONMENTAL CONDITIONS	23deg. C, 55%RH, 982 hPa	TESTED BY	Eric Lee

ANTENNA POLARITY & TEST DISTANCE: HORIZONTAL AT 3 M

No.	Freq. (MHz)	Emission Level (dBuV/m)	Limit (dBuV/m)	Margin (dB)	Antenna Height (m)	Table Angle (Degree)	Raw Value (dBuV)	Correction Factor (dB/m)
1	2016.00	41.70 PK	74.00	-32.30	1.02 H	336	12.40	29.20
2	2292.00	41.90 PK	74.00	-32.10	1.47 H	230	11.80	30.10
3	2360.00	38.90 PK	74.00	-35.10	1.04 H	210	8.50	30.30
4	2390.00	36.90 PK	74.00	-37.10	1.00 H	239	6.40	30.40
5	*2412.00	86.20 PK			1.00 H	49	55.70	30.50
5	*2412.00	78.50 AV			1.00 H	49	47.90	30.50
6	4824.00	43.00 PK	74.00	-31.00	1.04 H	357	6.80	36.20
7	7236.00	48.30 PK	74.00	-25.70	1.00 H	3	6.60	41.70
8	9648.00	48.50 PK	74.00	-25.50	1.00 H	0	3.60	44.90

ANTENNA POLARITY & TEST DISTANCE: VERTICAL AT 3 M

No.	Freq. (MHz)	Emission Level (dBuV/m)	Limit (dBuV/m)	Margin (dB)	Antenna Height (m)	Table Angle (Degree)	Raw Value (dBuV)	Correction Factor (dB/m)
1	2016.00	52.40 PK	74.00	-21.60	1.04 V	231	23.10	29.20
1	2016.00	51.00 AV	54.00	-3.00	1.04 V	231	21.70	29.20
2	2280.00	61.50 PK	74.00	-12.50	1.00 V	14	31.40	30.10
2	2280.00	51.30 AV	54.00	-2.70	1.00 V	14	21.20	30.10
3	2292.00	59.80 PK	74.00	-14.20	1.24 V	102	29.70	30.10
3	2292.00	51.10 AV	54.00	-2.90	1.24 V	102	21.00	30.10
4	2360.00	60.10 PK	74.00	-13.90	1.02 V	210	29.80	30.30
4	2360.00	45.50 AV	54.00	-8.50	1.02 V	210	15.20	30.30
5	2390.00	61.10 PK	74.00	-12.90	1.04 V	201	30.70	30.40
5	2390.00	51.50 AV	54.00	-2.50	1.04 V	201	21.10	30.40
6	*2412.00	110.50 PK			1.04 V	203	79.90	30.50
6	*2412.00	100.90 AV			1.04 V	203	70.40	30.50
7	4824.00	42.10 PK	74.00	-31.90	1.02 V	210	5.90	36.20
8	7236.00	48.00 PK	74.00	-26.00	1.00 V	217	6.40	41.70
9	9648.00	49.00 PK	74.00	-25.00	1.04 V	30	4.10	44.90

- NOTE:**
1. Emission level(dBuV/m)=Raw Value(dBuV) + Correction Factor(dB)
 2. Correction Factor(dB/m) = Antenna Factor (dB/m) + Cable Factor (dB)
 3. The other emission levels were very low against the limit.
 4. Margin value = Emission level – Limit value.
 5. The limit value is defined as per 15.247
 6. “ * ” : Fundamental frequency



EUT	Flanker Pro Dual Radio AP	MODEL	AP-AG-AT-02
MODE	Channel 6	FREQUENCY RANGE	1000MHz~25000MHz
INPUT POWER (SYSTEM)	120Vac, 60Hz	DETECTOR FUNCTION	Peak(PK) Average (AV)
ENVIRONMENTAL CONDITIONS	23deg. C, 55%RH, 982 hPa	TESTED BY	Eric Lee

ANTENNA POLARITY & TEST DISTANCE: HORIZONTAL AT 3 M

No.	Freq. (MHz)	Emission Level (dBuV/m)	Limit (dBuV/m)	Margin (dB)	Antenna Height (m)	Table Angle (Degree)	Raw Value (dBuV)	Correction Factor (dB/m)
1	2016.00	40.00 PK	74.00	-34.00	1.00 H	339	10.70	29.20
2	2280.00	42.30 PK	74.00	-31.70	1.00 H	23	12.20	30.10
3	2292.00	39.30 PK	74.00	-34.70	1.02 H	21	9.20	30.10
4	2360.00	37.70 PK	74.00	-36.30	1.17 H	4	7.40	30.30
5	2390.00	41.60 PK	74.00	-32.40	1.00 H	3	11.20	30.40
6	*2437.00	89.80 PK			1.07 H	52	59.10	30.70
6	*2437.00	80.50 AV			1.07 H	52	49.80	30.70
7	2483.50	43.10 PK	74.00	-30.90	1.00 H	56	12.20	31.00
8	4874.00	42.10 PK	74.00	-31.90	1.00 H	1	5.60	36.50
9	7311.00	48.50 PK	74.00	-25.50	1.03 H	2	6.70	41.80
10	9748.00	49.90 PK	74.00	-24.10	1.03 H	2	5.30	44.60

- NOTE:**
1. Emission level(dBuV/m)=Raw Value(dBuV) + Correction Factor(dB)
 2. Correction Factor(dB/m) = Antenna Factor (dB/m) + Cable Factor (dB)
 3. The other emission levels were very low against the limit.
 4. Margin value = Emission level – Limit value.
 5. The limit value is defined as per 15.247
 6. “ * “ : Fundamental frequency



EUT	Flanker Pro Dual Radio AP	MODEL	AP-AG-AT-02
MODE	Channel 6	FREQUENCY RANGE	1000MHz~25000MHz
INPUT POWER (SYSTEM)	120Vac, 60Hz	DETECTOR FUNCTION	Peak(PK) Average (AV)
ENVIRONMENTAL CONDITIONS	23deg. C, 55%RH, 982 hPa	TESTED BY	Eric Lee

ANTENNA POLARITY & TEST DISTANCE: VERTICAL AT 3 M								
No.	Freq. (MHz)	Emission Level (dBuV/m)	Limit (dBuV/m)	Margin (dB)	Antenna Height (m)	Table Angle (Degree)	Raw Value (dBuV)	Correction Factor (dB/m)
1	2016.00	50.60 PK	74.00	-23.40	1.02 V	1	21.30	29.20
2	2280.00	61.40 PK	74.00	-12.60	1.00 V	3	31.30	30.10
2	2280.00	50.70 AV	54.00	-3.30	1.00 V	3	20.70	30.10
3	2292.00	59.10 PK	74.00	-14.90	1.00 V	0	29.00	30.10
3	2292.00	49.80 AV	54.00	-4.20	1.00 V	0	19.70	30.10
4	2360.00	57.40 PK	74.00	-16.60	1.01 V	2	27.00	30.30
4	2360.00	45.00 AV	54.00	-9.00	1.01 V	2	14.70	30.30
5	2390.00	53.00 PK	74.00	-21.00	1.04 V	23	22.60	30.40
5	2390.00	43.00 AV	54.00	-11.00	1.04 V	23	12.60	30.40
6	*2437.00	110.60 PK			1.03 V	3	79.90	30.70
6	*2437.00	102.20 AV			1.03 V	3	71.50	30.70
7	2483.50	56.10 PK	74.00	-17.90	1.00 V	23	25.10	31.00
7	2483.50	46.50 AV	54.00	-7.50	1.00 V	23	15.50	31.00
8	4874.00	42.50 PK	74.00	-31.50	1.03 V	2	6.10	36.50
9	7311.00	46.20 PK	74.00	-27.80	1.00 V	0	4.50	41.80
10	9748.00	47.90 PK	74.00	-26.10	1.02 V	3	3.30	44.60

- NOTE:**
1. Emission level(dBuV/m)=Raw Value(dBuV) + Correction Factor(dB)
 2. Correction Factor(dB/m) = Antenna Factor (dB/m) + Cable Factor (dB)
 3. The other emission levels were very low against the limit.
 4. Margin value = Emission level – Limit value.
 5. The limit value is defined as per 15.247
 6. “ * “ : Fundamental frequency



EUT	Flanker Pro Dual Radio AP	MODEL	AP-AG-AT-02
MODE	Channel 11	FREQUENCY RANGE	1000MHz~25000MHz
INPUT POWER (SYSTEM)	120Vac, 60Hz	DETECTOR FUNCTION	Peak(PK) Average (AV)
ENVIRONMENTAL CONDITIONS	23deg. C, 55%RH, 982 hPa	TESTED BY	Eric Lee

ANTENNA POLARITY & TEST DISTANCE: HORIZONTAL AT 3M

No.	Freq. (MHz)	Emission Level (dBuV/m)	Limit (dBuV/m)	Margin (dB)	Antenna Height (m)	Table Angle (Degree)	Raw Value (dBuV)	Correction Factor (dB/m)
1	2016.00	40.40 PK	74.00	-33.60	1.04 H	233	11.10	29.20
2	2280.00	41.20 PK	74.00	-32.80	1.00 H	17	11.10	30.10
3	2292.00	41.80 PK	74.00	-32.20	1.04 H	22	11.70	30.10
4	2360.00	38.00 PK	74.00	-36.00	1.16 H	6	7.70	30.30
5	*2462.00	89.30 PK			1.00 H	53	58.50	30.80
5	*2462.00	79.70 AV			1.00 H	53	48.90	30.80
6	2483.50	38.00 PK	74.00	-36.00	1.00 H	23	7.00	31.00
7	4924.00	42.90 PK	74.00	-31.10	1.04 H	239	6.20	36.70
8	7386.00	48.00 PK	74.00	-26.00	1.07 H	239	6.10	41.80
9	9848.00	49.30 PK	74.00	-24.70	1.04 H	1	4.90	44.40

- NOTE:**
1. Emission level(dBuV/m)=Raw Value(dBuV) + Correction Factor(dB)
 2. Correction Factor(dB/m) = Antenna Factor (dB/m) + Cable Factor (dB)
 3. The other emission levels were very low against the limit.
 4. Margin value = Emission level – Limit value.
 5. The limit value is defined as per 15.247
 6. “ * “ : Fundamental frequency



EUT	Flanker Pro Dual Radio AP	Model	AP-AG-AT-02
MODE	Channel 11	FREQUENCY RANGE	1000MHz~25000MHz
INPUT POWER (SYSTEM)	120Vac, 60Hz	DETECTOR FUNCTION	Peak(PK) Average (AV)
ENVIRONMENTAL CONDITIONS	23deg. C, 55%RH, 982 hPa	TESTED BY	Eric Lee

ANTENNA POLARITY & TEST DISTANCE: VERTICAL AT 3M

No.	Freq. (MHz)	Emission Level (dBuV/m)	Limit (dBuV/m)	Margin (dB)	Antenna Height (m)	Table Angle (Degree)	Raw Value (dBuV)	Correction Factor (dB/m)
1	2016.00	51.60 PK	74.00	-22.40	1.04 V	23	22.40	29.20
1	2016.00	49.30 AV	54.00	-4.70	1.04 V	23	20.10	29.20
2	2280.00	60.00 PK	74.00	-14.00	1.04 V	1	29.90	30.10
2	2280.00	50.90 AV	54.00	-3.10	1.04 V	1	20.80	30.10
3	2292.00	61.80 PK	74.00	-12.20	1.07 V	25	31.70	30.10
3	2292.00	50.50 AV	54.00	-3.50	1.07 V	25	20.40	30.10
4	2360.00	56.30 PK	74.00	-17.70	1.00 V	4	25.90	30.30
4	2360.00	45.80 AV	54.00	-8.20	1.00 V	4	15.50	30.30
5	*2462.00	111.80 PK			1.00 V	0	80.90	30.80
5	*2462.00	103.00 AV			1.00 V	0	72.10	30.80
6	2483.50	61.20 PK	74.00	-12.80	1.02 V	3	30.20	31.00
6	2483.50	52.40 AV	54.00	-1.60	1.02 V	3	21.40	31.00
7	4924.00	42.90 PK	74.00	-31.10	1.00 V	4	6.20	36.70
8	7386.00	47.40 PK	74.00	-26.60	1.03 V	6	5.50	41.80
9	9848.00	49.30 PK	74.00	-24.70	1.04 V	8	4.90	44.40

- NOTE:**
1. Emission level(dBuV/m)=Raw Value(dBuV) + Correction Factor(dB)
 2. Correction Factor(dB/m) = Antenna Factor (dB/m) + Cable Factor (dB)
 3. The other emission levels were very low against the limit.
 4. Margin value = Emission level – Limit value.
 5. The limit value is defined as per 15.247
 6. “ * “ : Fundamental frequency



4.2.20 TEST RESULTS - OFDM (ANTENNA 6)

EUT	Flanker Pro Dual Radio AP	MODEL	AP-AG-AT-02
MODE	Channel 1	FREQUENCY RANGE	1000MHz~25000MHz
INPUT POWER (SYSTEM)	120Vac, 60Hz	DETECTOR FUNCTION	Peak(PK) Average (AV)
ENVIRONMENTAL CONDITIONS	23deg. C, 55%RH, 982 hPa	TESTED BY	Eric Lee

ANTENNA POLARITY & TEST DISTANCE: HORIZONTAL AT 3 M

No.	Freq. (MHz)	Emission Level (dBuV/m)	Limit (dBuV/m)	Margin (dB)	Antenna Height (m)	Table Angle (Degree)	Raw Value (dBuV)	Correction Factor (dB/m)
1	2016.00	31.00 PK	74.00	-43.00	1.07 H	4	1.80	29.20
2	2292.00	43.80 PK	74.00	-30.20	1.60 H	2	13.70	30.10
3	2360.00	46.70 PK	74.00	-27.30	1.37 H	9	16.40	30.30
4	2390.00	48.70 PK	74.00	-25.30	1.00 H	358	18.30	30.40
5	*2412.00	85.80 PK			1.04 H	5	55.20	30.50
5	*2412.00	77.80 AV			1.04 H	5	47.20	30.50
6	4824.00	39.80 PK	74.00	-34.20	1.40 H	201	3.50	36.20
7	7236.00	46.80 PK	74.00	-27.20	1.62 H	3	5.10	41.70
8	9648.00	48.30 PK	74.00	-25.70	1.01 H	4	3.40	44.90

ANTENNA POLARITY & TEST DISTANCE: VERTICAL AT 3 M

No.	Freq. (MHz)	Emission Level (dBuV/m)	Limit (dBuV/m)	Margin (dB)	Antenna Height (m)	Table Angle (Degree)	Raw Value (dBuV)	Correction Factor (dB/m)
1	2016.00	41.40 PK	74.00	-32.60	1.58 V	2	12.20	29.20
2	2292.00	57.90 PK	74.00	-16.10	1.15 V	6	27.80	30.10
2	2292.00	48.30 AV	54.00	-5.70	1.15 V	6	18.20	30.10
3	2360.00	57.50 PK	74.00	-16.50	1.12 V	3	27.20	30.30
3	2360.00	48.60 AV	54.00	-5.40	1.12 V	3	18.20	30.30
4	2390.00	64.40 PK	74.00	-9.60	1.09 V	3	34.00	30.40
4	2390.00	52.70 AV	54.00	-1.30	1.09 V	3	22.30	30.40
5	*2412.00	110.60 PK			1.12 V	1	80.00	30.50
5	*2412.00	101.80 AV			1.12 V	1	71.20	30.50
6	4824.00	42.60 PK	74.00	-31.40	1.15 V	2	6.30	36.20
7	7236.00	46.80 PK	74.00	-27.20	1.54 V	9	5.10	41.70
8	9648.00	49.80 PK	74.00	-24.20	1.58 V	9	4.90	44.90

- NOTE:**
1. Emission level(dBuV/m)=Raw Value(dBuV) + Correction Factor(dB)
 2. Correction Factor(dB/m) = Antenna Factor (dB/m) + Cable Factor (dB)
 3. The other emission levels were very low against the limit.
 4. Margin value = Emission level – Limit value.
 5. The limit value is defined as per 15.247
 6. " * " : Fundamental frequency



EUT	Flanker Pro Dual Radio AP	MODEL	AP-AG-AT-02
MODE	Channel 6	FREQUENCY RANGE	1000MHz~25000MHz
INPUT POWER (SYSTEM)	120Vac, 60Hz	DETECTOR FUNCTION	Peak(PK) Average (AV)
ENVIRONMENTAL CONDITIONS	23deg. C, 55%RH, 982 hPa	TESTED BY	Eric Lee

ANTENNA POLARITY & TEST DISTANCE: HORIZONTAL AT 3 M

No.	Freq. (MHz)	Emission Level (dBuV/m)	Limit (dBuV/m)	Margin (dB)	Antenna Height (m)	Table Angle (Degree)	Raw Value (dBuV)	Correction Factor (dB/m)
1	2016.00	33.10 PK	74.00	-40.90	1.10 H	14	3.90	29.20
2	2290.00	47.90 PK	74.00	-26.10	1.76 H	32	17.80	30.10
3	2390.00	46.90 PK	74.00	-27.10	1.39 H	6	16.50	30.40
4	*2437.00	93.90 PK			1.02 H	42	63.20	30.70
4	*2437.00	86.40 AV			1.02 H	42	55.70	30.70
5	2483.50	48.60 PK	74.00	-25.40	1.53 H	63	17.60	31.00
6	4874.00	41.50 PK	74.00	-32.50	1.08 H	5	5.10	36.50
7	7311.00	47.00 PK	74.00	-27.00	1.69 H	357	5.30	41.80
8	9748.00	47.10 PK	74.00	-26.90	1.70 H	10	2.40	44.60

ANTENNA POLARITY & TEST DISTANCE: VERTICAL AT 3 M

No.	Freq. (MHz)	Emission Level (dBuV/m)	Limit (dBuV/m)	Margin (dB)	Antenna Height (m)	Table Angle (Degree)	Raw Value (dBuV)	Correction Factor (dB/m)
1	2016.00	46.40 PK	74.00	-27.60	1.12 V	32	17.10	29.20
2	2290.00	60.90 PK	74.00	-13.10	1.08 V	9	30.80	30.10
2	2290.00	50.20 AV	54.00	-3.80	1.08 V	9	20.10	30.10
3	2390.00	61.20 PK	74.00	-12.80	1.11 V	2	30.80	30.40
3	2390.00	49.50 AV	54.00	-4.50	1.11 V	2	19.00	30.40
4	*2437.00	115.00 PK			1.07 V	2	84.30	30.70
4	*2437.00	106.90 AV			1.07 V	2	76.20	30.70
5	2483.50	61.90 PK	74.00	-12.10	1.05 V	21	31.00	31.00
5	2483.50	50.50 AV	54.00	-3.50	1.05 V	21	19.60	31.00
6	4874.00	45.60 PK	74.00	-28.40	1.54 V	74	9.10	36.50
7	7311.00	47.70 PK	74.00	-26.30	1.50 V	29	5.90	41.80
8	9748.00	48.70 PK	74.00	-25.30	1.02 V	47	4.10	44.60

- NOTE:**
1. Emission level(dBuV/m)=Raw Value(dBuV) + Correction Factor(dB)
 2. Correction Factor(dB/m) = Antenna Factor (dB/m) + Cable Factor (dB)
 3. The other emission levels were very low against the limit.
 4. Margin value = Emission level – Limit value.
 5. The limit value is defined as per 15.247
 6. “ * “ : Fundamental frequency



EUT	Flanker Pro Dual Radio AP	MODEL	AP-AG-AT-02
MODE	Channel 11	FREQUENCY RANGE	1000MHz~25000MHz
INPUT POWER (SYSTEM)	120Vac, 60Hz	DETECTOR FUNCTION	Peak(PK) Average (AV)
ENVIRONMENTAL CONDITIONS	23deg. C, 55%RH, 982 hPa	TESTED BY	Eric Lee

ANTENNA POLARITY & TEST DISTANCE: HORIZONTAL AT 3M

No.	Freq. (MHz)	Emission Level (dBuV/m)	Limit (dBuV/m)	Margin (dB)	Antenna Height (m)	Table Angle (Degree)	Raw Value (dBuV)	Correction Factor (dB/m)
1	2016.00	30.10 PK	74.00	-43.90	1.00 H	359	0.90	29.20
2	2280.00	46.80 PK	74.00	-27.20	1.01 H	47	16.70	30.10
3	*2462.00	87.40 PK			1.24 H	20	56.60	30.80
3	*2462.00	80.50 AV			1.24 H	20	49.70	30.80
4	2483.50	49.30 PK	74.00	-24.70	1.11 H	6	18.30	31.00
5	4924.00	39.60 PK	74.00	-34.40	1.80 H	3	2.90	36.70
6	7386.00	46.20 PK	74.00	-27.80	1.17 H	4	4.40	41.80
7	9848.00	48.80 PK	74.00	-25.20	1.53 H	62	4.40	44.40

ANTENNA POLARITY & TEST DISTANCE: VERTICAL AT 3M

No.	Freq. (MHz)	Emission Level (dBuV/m)	Limit (dBuV/m)	Margin (dB)	Antenna Height (m)	Table Angle (Degree)	Raw Value (dBuV)	Correction Factor (dB/m)
1	2016.00	44.40 PK	74.00	-29.60	1.42 V	3	15.10	29.20
2	2280.00	60.00 PK	74.00	-14.00	1.14 V	7	29.90	30.10
2	2280.00	50.60 AV	54.00	-3.40	1.14 V	7	20.50	30.10
3	*2462.00	112.20 PK			1.14 V	1	81.40	30.80
3	*2462.00	103.60 AV			1.14 V	1	72.80	30.80
4	2483.50	65.60 PK	74.00	-8.40	1.09 V	11	34.60	31.00
4	2483.50	52.80 AV	54.00	-1.20	1.09 V	11	21.80	31.00
5	4924.00	44.80 PK	74.00	-29.20	1.45 V	24	8.10	36.70
6	7386.00	48.30 PK	74.00	-25.70	1.11 V	3	6.50	41.80
7	9848.00	50.40 PK	74.00	-23.60	1.14 V	1	6.00	44.40

- NOTE:**
1. Emission level(dBuV/m)=Raw Value(dBuV) + Correction Factor(dB)
 2. Correction Factor(dB/m) = Antenna Factor (dB/m) + Cable Factor (dB)
 3. The other emission levels were very low against the limit.
 4. Margin value = Emission level – Limit value.
 5. The limit value is defined as per 15.247
 6. “ * “ : Fundamental frequency



4.2.21 TEST RESULTS - OFDM (ANTENNA 7)

EUT	Flanker Pro Dual Radio AP	MODEL	AP-AG-AT-02
MODE	Channel 3	FREQUENCY RANGE	1000MHz~25000MHz
INPUT POWER (SYSTEM)	120Vac, 60Hz	DETECTOR FUNCTION	Peak(PK) Average (AV)
ENVIRONMENTAL CONDITIONS	23deg. C, 55%RH, 982 hPa	TESTED BY	Eric Lee

ANTENNA POLARITY & TEST DISTANCE: HORIZONTAL AT 3 M

No.	Freq. (MHz)	Emission Level (dBuV/m)	Limit (dBuV/m)	Margin (dB)	Antenna Height (m)	Table Angle (Degree)	Raw Value (dBuV)	Correction Factor (dB/m)
1	2016.00	36.90 PK	74.00	-37.10	1.11 H	97	7.60	29.20
2	2280.00	35.90 PK	74.00	-38.10	1.32 H	184	5.80	30.10
3	2360.00	35.40 PK	74.00	-38.60	1.28 H	187	5.10	30.30
4	2390.00	43.70 PK	74.00	-30.30	1.00 H	76	13.30	30.40
5	*2422.00	85.70 PK			1.14 H	74	55.10	30.60
5	*2422.00	78.50 AV			1.14 H	74	47.90	30.60
6	4844.00	42.80 PK	74.00	-31.20	1.20 H	170	6.50	36.30
7	7266.00	47.60 PK	74.00	-26.40	1.13 H	167	5.90	41.70
8	9688.00	48.60 PK	74.00	-25.40	1.07 H	168	3.80	44.80

ANTENNA POLARITY & TEST DISTANCE: VERTICAL AT 3 M

No.	Freq. (MHz)	Emission Level (dBuV/m)	Limit (dBuV/m)	Margin (dB)	Antenna Height (m)	Table Angle (Degree)	Raw Value (dBuV)	Correction Factor (dB/m)
1	2016.00	50.10 PK	74.00	-23.90	1.10 V	184	20.90	29.20
2	2280.00	62.90 PK	74.00	-11.10	1.09 V	180	32.80	30.10
2	2280.00	51.80 AV	54.00	-2.20	1.09 V	180	21.70	30.10
3	2292.00	61.90 PK	74.00	-12.10	1.16 V	184	31.80	30.10
3	2292.00	52.40 AV	54.00	-1.60	1.16 V	184	22.30	30.10
4	2360.00	56.70 PK	74.00	-17.30	1.11 V	183	26.40	30.30
4	2360.00	44.00 AV	54.00	-10.00	1.11 V	183	13.70	30.30
5	2390.00	58.70 PK	74.00	-15.30	1.14 V	187	28.30	30.40
5	2390.00	49.60 AV	54.00	-4.40	1.14 V	187	19.20	30.40
6	*2422.00	107.80 PK			1.13 V	183	77.20	30.60
6	*2422.00	101.00 AV			1.13 V	183	70.40	30.60
7	4844.00	42.90 PK	74.00	-31.10	1.16 V	184	6.60	36.30
8	7266.00	45.40 PK	74.00	-28.60	1.20 V	180	3.70	41.70
9	9688.00	46.10 PK	74.00	-27.90	1.17 V	152	1.30	44.80

- NOTE:**
1. Emission level(dBuV/m)=Raw Value(dBuV) + Correction Factor(dB)
 2. Correction Factor(dB/m) = Antenna Factor (dB/m) + Cable Factor (dB)
 3. The other emission levels were very low against the limit.
 4. Margin value = Emission level – Limit value.
 5. The limit value is defined as per 15.247
 6. “ * “ : Fundamental frequency



EUT	Flanker Pro Dual Radio AP	MODEL	AP-AG-AT-02
MODE	Channel 6	FREQUENCY RANGE	1000MHz~25000MHz
INPUT POWER (SYSTEM)	120Vac, 60Hz	DETECTOR FUNCTION	Peak(PK) Average (AV)
ENVIRONMENTAL CONDITIONS	23deg. C, 55%RH, 982 hPa	TESTED BY	Eric Lee

ANTENNA POLARITY & TEST DISTANCE: HORIZONTAL AT 3 M

No.	Freq. (MHz)	Emission Level (dBuV/m)	Limit (dBuV/m)	Margin (dB)	Antenna Height (m)	Table Angle (Degree)	Raw Value (dBuV)	Correction Factor (dB/m)
1	2016.00	36.20 PK	74.00	-37.80	1.25 H	158	7.00	29.20
2	2280.00	42.50 PK	74.00	-31.50	1.00 H	70	12.40	30.10
3	2360.00	38.10 PK	74.00	-35.90	1.22 H	66	7.80	30.30
4	*2437.00	86.50 PK			1.00 H	163	55.80	30.70
4	*2437.00	79.20 AV			1.00 H	163	48.50	30.70
5	2492.00	35.30 PK	74.00	-38.70	1.01 H	7	4.50	30.80
6	4874.00	40.70 PK	74.00	-33.30	1.04 H	24	4.20	36.50
7	7311.00	48.10 PK	74.00	-25.90	1.13 H	178	6.40	41.80
8	9748.00	47.40 PK	74.00	-26.60	1.03 H	187	2.70	44.60

ANTENNA POLARITY & TEST DISTANCE: VERTICAL AT 3 M

No.	Freq. (MHz)	Emission Level (dBuV/m)	Limit (dBuV/m)	Margin (dB)	Antenna Height (m)	Table Angle (Degree)	Raw Value (dBuV)	Correction Factor (dB/m)
1	2016.00	49.70 PK	74.00	-24.30	1.10 V	163	20.40	29.20
2	2280.00	60.90 PK	74.00	-13.10	1.13 V	180	30.80	30.10
2	2280.00	51.80 AV	54.00	-2.20	1.13 V	180	21.70	30.10
3	2292.00	61.20 PK	74.00	-12.80	1.16 V	180	31.10	30.10
3	2292.00	52.90 AV	54.00	-1.10	1.16 V	180	22.80	30.10
4	2360.00	54.30 PK	74.00	-19.70	1.12 V	181	23.90	30.30
4	2360.00	43.90 AV	54.00	-10.10	1.12 V	181	13.50	30.30
5	*2437.00	109.20 PK			1.12 V	177	78.60	30.70
5	*2437.00	101.70 AV			1.12 V	177	71.00	30.70
6	2483.50	55.60 PK	74.00	-18.40	1.13 V	188	24.70	31.00
6	2483.50	48.60 AV	54.00	-5.40	1.13 V	188	17.70	31.00
7	4874.00	45.20 PK	74.00	-28.80	1.14 V	169	8.80	36.50
8	7311.00	47.70 PK	74.00	-26.30	1.12 V	180	5.90	41.80
9	9748.00	47.40 PK	74.00	-26.60	1.13 V	177	2.70	44.60

- NOTE:**
1. Emission level(dBuV/m)=Raw Value(dBuV) + Correction Factor(dB)
 2. Correction Factor(dB/m) = Antenna Factor (dB/m) + Cable Factor (dB)
 3. The other emission levels were very low against the limit.
 4. Margin value = Emission level – Limit value.
 5. The limit value is defined as per 15.247
 6. “ * “ : Fundamental frequency



EUT	Flanker Pro Dual Radio AP	MODEL	AP-AG-AT-02
MODE	Channel 9	FREQUENCY RANGE	1000MHz~25000MHz
INPUT POWER (SYSTEM)	120Vac, 60Hz	DETECTOR FUNCTION	Peak(PK) Average (AV)
ENVIRONMENTAL CONDITIONS	23deg. C, 55%RH, 982 hPa	TESTED BY	Eric Lee

ANTENNA POLARITY & TEST DISTANCE: HORIZONTAL AT 3M

No.	Freq. (MHz)	Emission Level (dBuV/m)	Limit (dBuV/m)	Margin (dB)	Antenna Height (m)	Table Angle (Degree)	Raw Value (dBuV)	Correction Factor (dB/m)
1	2016.00	36.40 PK	74.00	-37.60	1.00 H	50	7.10	29.20
2	2280.00	42.40 PK	74.00	-31.60	1.28 H	59	12.30	30.10
3	2292.00	43.50 PK	74.00	-30.50	1.24 H	60	13.40	30.10
4	2360.00	36.00 PK	74.00	-38.00	1.00 H	75	5.60	30.30
5	*2452.00	88.40 PK			1.13 H	44	57.70	30.80
5	*2452.00	81.40 AV			1.13 H	44	50.60	30.80
6	2483.50	47.70 PK	74.00	-26.30	1.13 H	27	16.70	31.00
7	4904.00	41.80 PK	74.00	-32.20	1.04 H	180	5.20	36.60
8	7356.00	47.60 PK	74.00	-26.40	1.04 H	102	5.80	41.80
9	9808.00	48.20 PK	74.00	-25.80	1.00 H	187	3.70	44.50

ANTENNA POLARITY & TEST DISTANCE: VERTICAL AT 3M

No.	Freq. (MHz)	Emission Level (dBuV/m)	Limit (dBuV/m)	Margin (dB)	Antenna Height (m)	Table Angle (Degree)	Raw Value (dBuV)	Correction Factor (dB/m)
1	2016.00	50.80 PK	74.00	-23.20	1.08 V	171	21.60	29.20
2	2280.00	61.00 PK	74.00	-13.00	1.14 V	180	30.90	30.10
2	2280.00	52.10 AV	54.00	-1.90	1.14 V	180	22.00	30.10
3	2292.00	59.30 PK	74.00	-14.70	1.13 V	187	29.20	30.10
3	2292.00	50.90 AV	54.00	-3.10	1.13 V	187	20.80	30.10
4	2360.00	53.40 PK	74.00	-20.60	1.16 V	181	23.10	30.30
4	2360.00	43.60 AV	54.00	-10.40	1.16 V	181	13.30	30.30
5	*2452.00	109.40 PK			1.09 V	180	78.60	30.80
5	*2452.00	102.10 AV			1.09 V	180	71.30	30.80
6	2483.50	58.40 PK	74.00	-15.60	1.09 V	178	27.40	31.00
6	2483.50	49.90 AV	54.00	-4.10	1.09 V	178	19.00	31.00
7	4904.00	43.80 PK	74.00	-30.20	1.10 V	187	7.20	36.60
8	7356.00	48.30 PK	74.00	-25.70	1.07 V	126	6.50	41.80
9	9808.00	47.10 PK	74.00	-26.90	1.17 V	190	2.60	44.50

- NOTE:**
1. Emission level(dBuV/m)=Raw Value(dBuV) + Correction Factor(dB)
 2. Correction Factor(dB/m) = Antenna Factor (dB/m) + Cable Factor (dB)
 3. The other emission levels were very low against the limit.
 4. Margin value = Emission level – Limit value.
 5. The limit value is defined as per 15.247
 6. “ * ” : Fundamental frequency



4.3 6dB BANDWIDTH MEASUREMENT

4.3.1 LIMITS OF 6dB BANDWIDTH MEASUREMENT

The minimum of 6dB Bandwidth Measurement is 0.5 MHz.

4.3.2 TEST INSTRUMENTS

Description & Manufacturer	Model No.	Serial No.	Calibrated Until
R&S SPECTRUM ANALYZER	FSP	1093.4495.30	Dec. 19, 2004

NOTE:

- 1.The measurement uncertainty is less than +/- 2.6dB, which is calculated as per the NAMAS document NIS81.
- 2.The calibration interval of the above test instruments is 12 months and the calibrations are traceable to NML/ROC and NIST/USA.

4.3.3 TEST PROCEDURE

The transmitter output was connected to the spectrum analyzer through an attenuator. The bandwidth of the fundamental frequency was measured by spectrum analyzer with 100kHz RBW and 100kHz VBW. The 6dB bandwidth is defined as the total spectrum the power of which is higher than peak power minus 6 dB.

4.3.4 DEVIATION FROM TEST STANDARD

No deviation

4.3.5 TEST SETUP

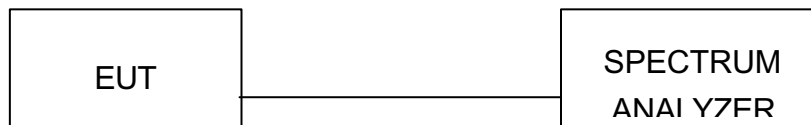

4.3.6 EUT OPERATING CONDITIONS

The software provided by client to enable the EUT under transmission condition continuously at lowest, middle and highest channel frequencies individually.



4.3.7 TEST RESULTS -DSSS

EUT	Flanker Pro Dual Radio AP	MODEL	AP-AG-AT-02
INPUT POWER (SYSTEM)	120Vac, 60Hz	ENVIRONMENTAL CONDITIONS	21deg. C, 58%RH, 982 hPa
TESTED BY	Eric Lee		

CHANNEL	CHANNEL FREQUENCY (MHz)	6dB BANDWIDTH (MHz)	MINIMUM LIMIT (MHz)	PASS/FAIL
1	2412	11.13	0.5	PASS
6	2437	10.71	0.5	PASS
11	2462	10.50	0.5	PASS



CH1

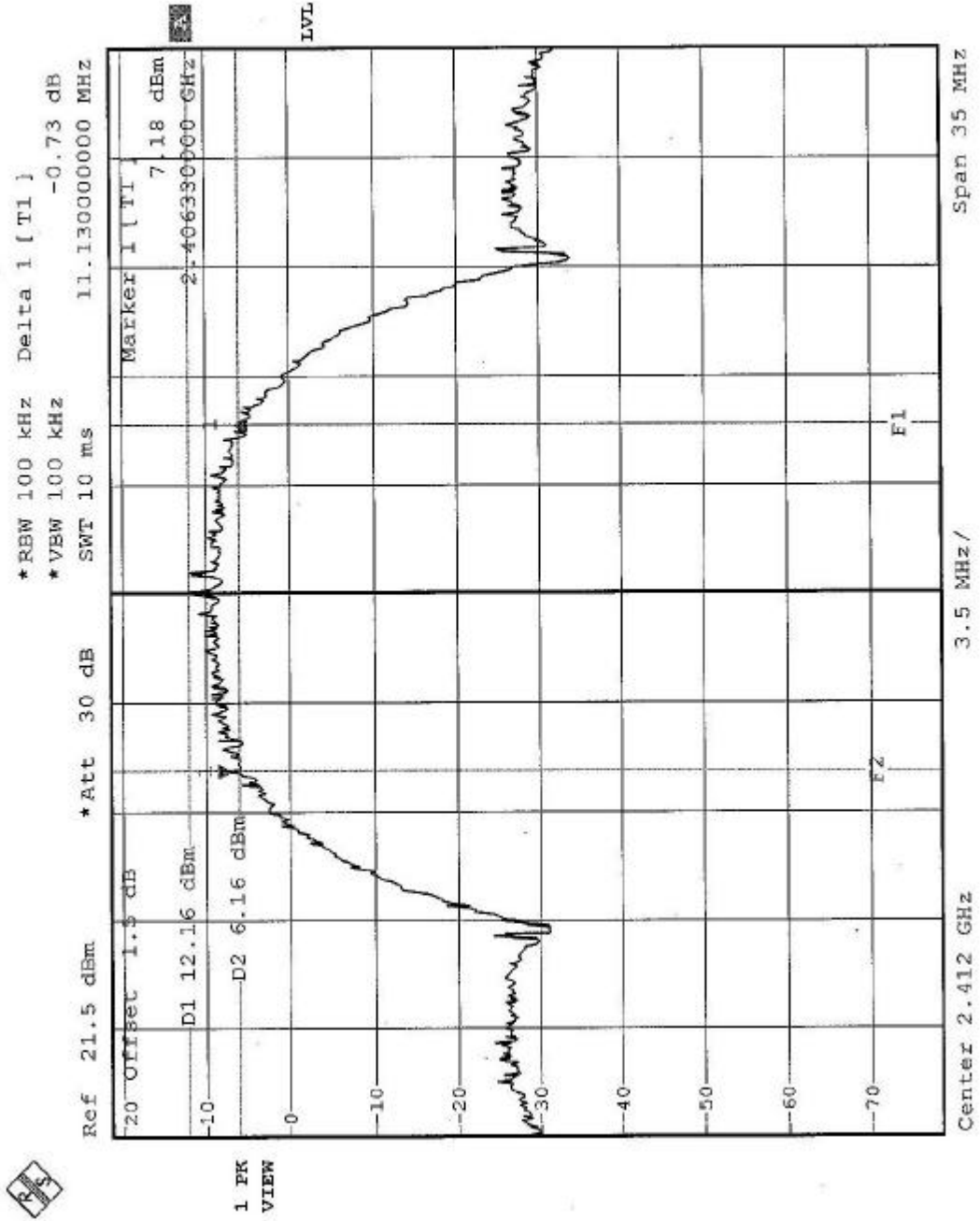



CH6

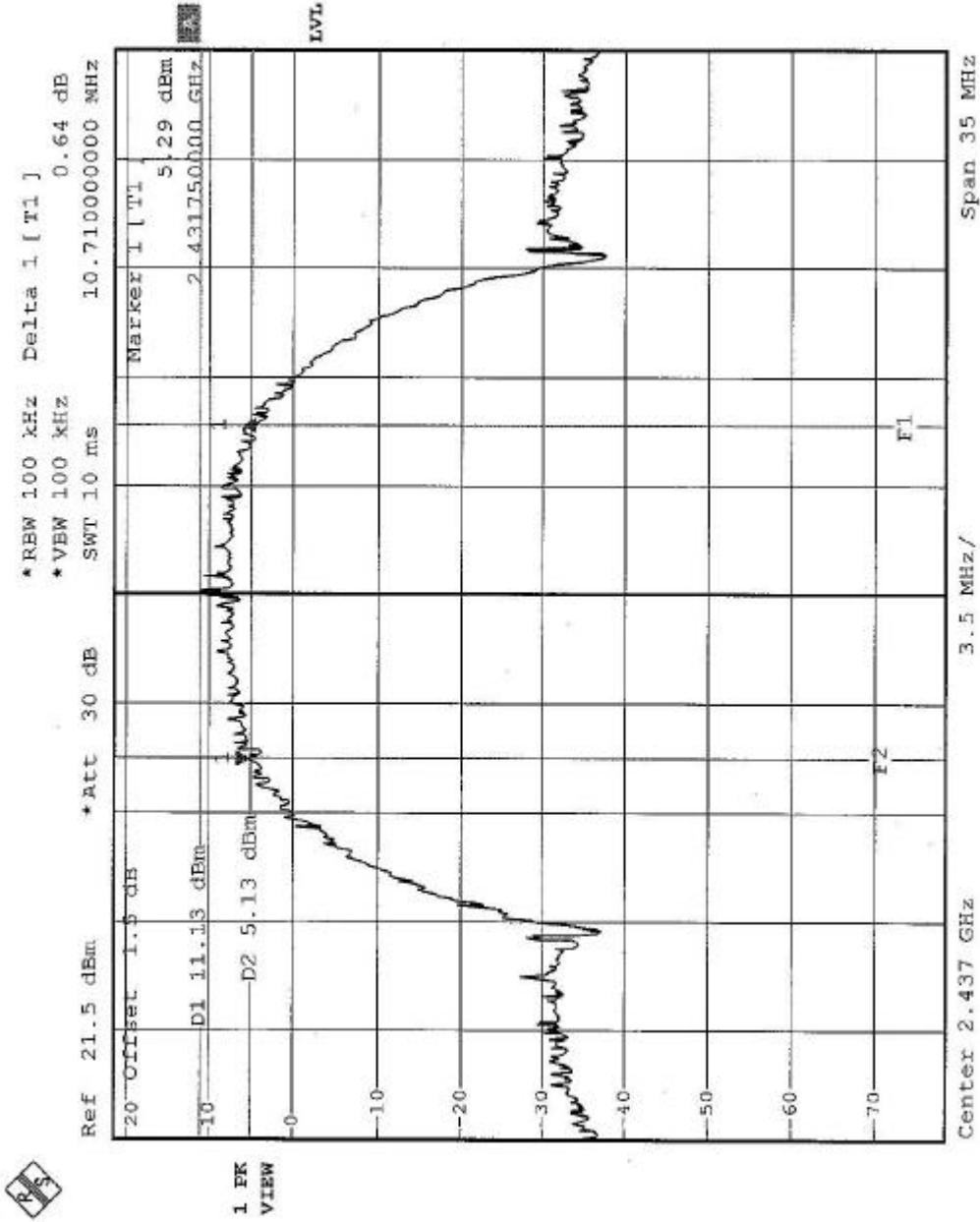



CH11

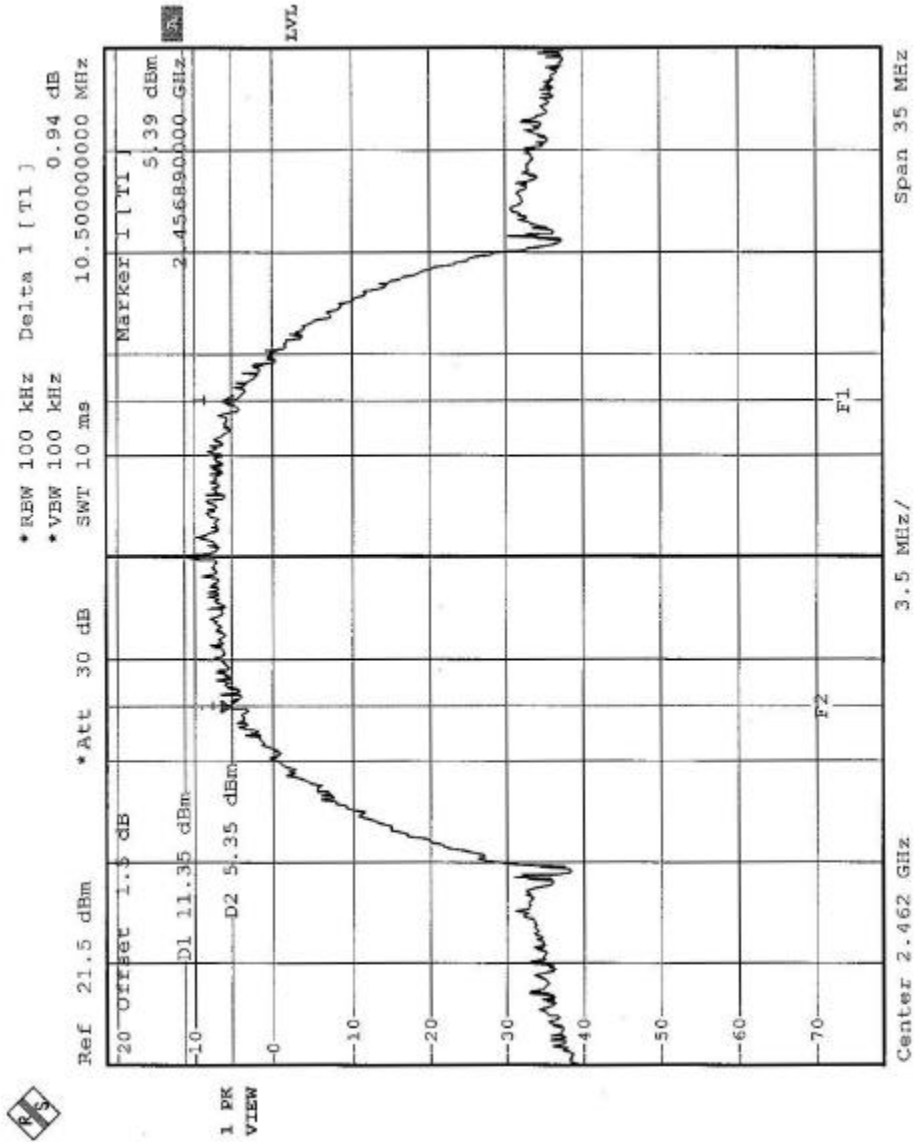



4.3.8 TEST RESULTS -OFDM

EUT	Flanker Pro Dual Radio AP	MODEL	AP-AG-AT-02
INPUT POWER (SYSTEM)	120Vac, 60Hz	ENVIRONMENTAL CONDITIONS	21deg. C, 58%RH, 982 hPa
TESTED BY	Eric Lee		

CHANNEL	CHANNEL FREQUENCY (MHz)	6dB BANDWIDTH (MHz)	MINIMUM LIMIT (MHz)	PASS/FAIL
1	2412	16.38	0.5	PASS
6	2437	16.38	0.5	PASS
11	2462	16.32	0.5	PASS



CH1

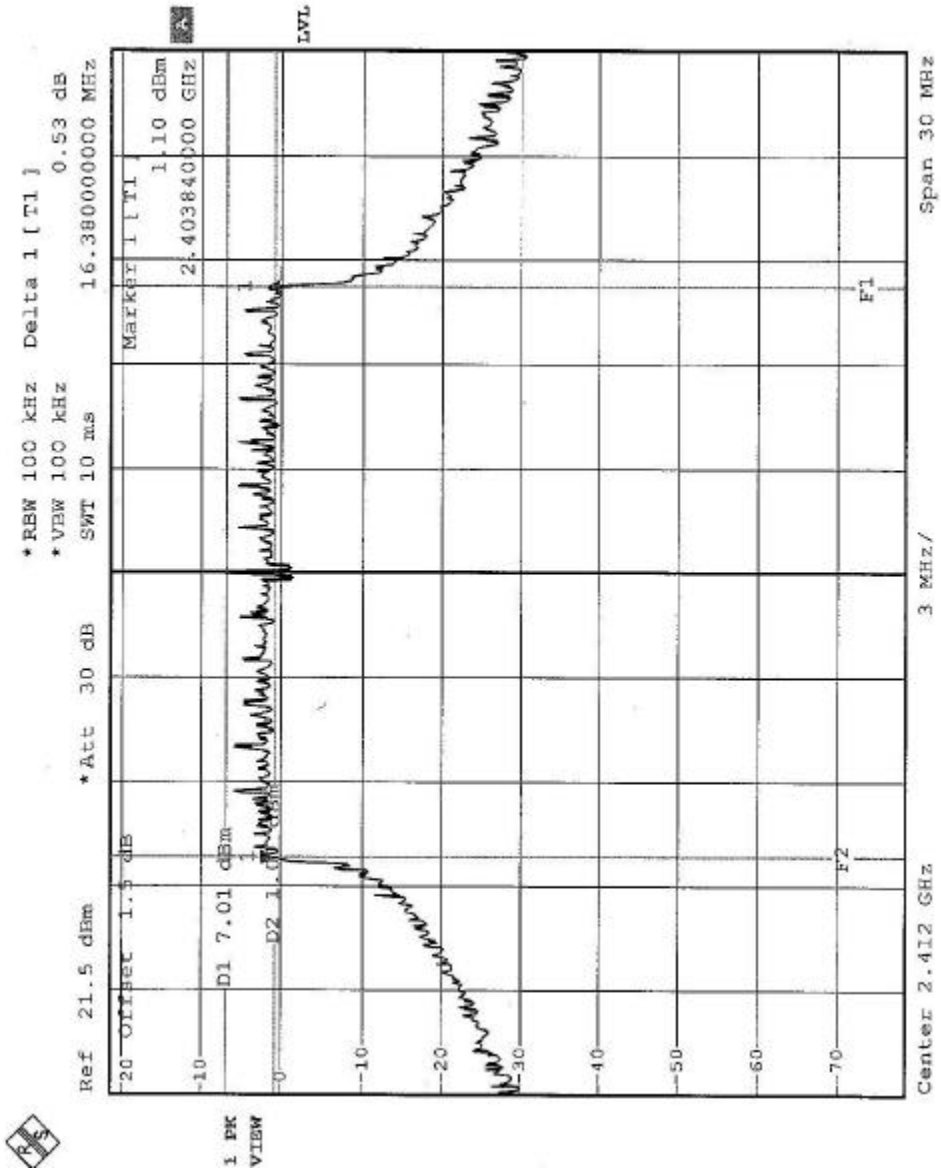



CH6

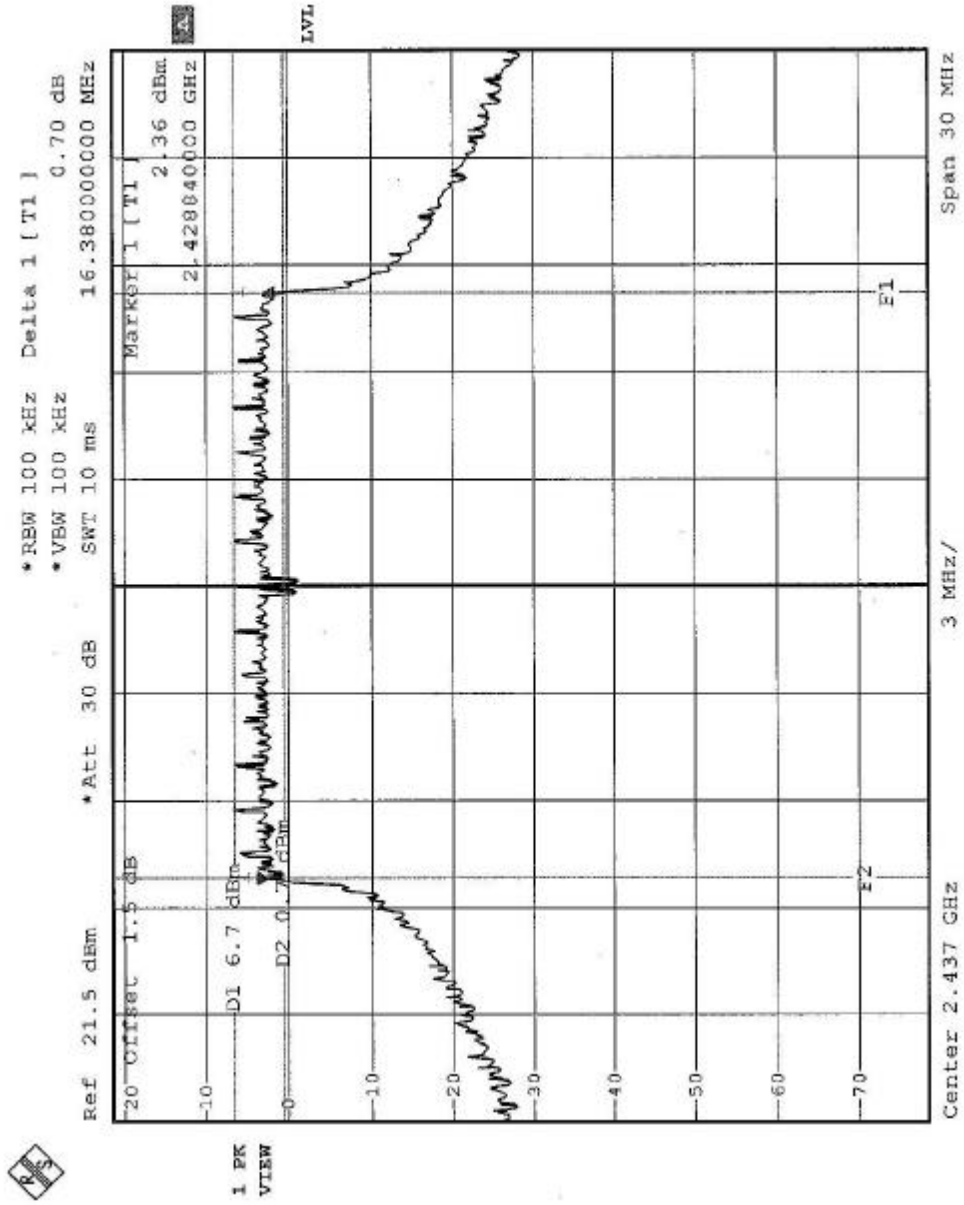



CH11

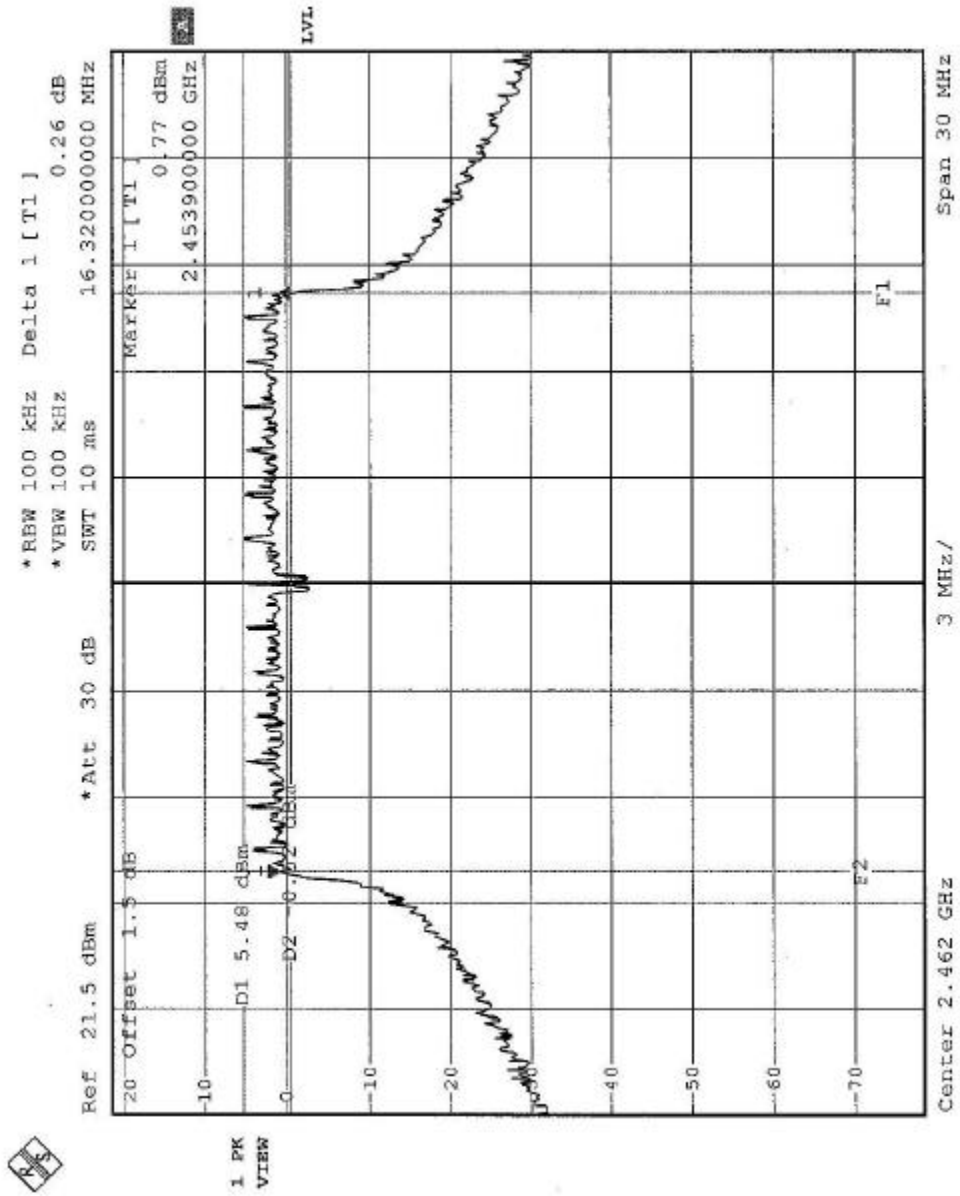



4.4 MAXIMUM PEAK OUTPUT POWER

4.4.1 LIMITS OF MAXIMUM PEAK OUTPUT POWER MEASUREMENT

The Maximum Peak Output Power Measurement is 30dBm.

Note:

1. If transmitting antennas of directional gain greater than 6 dBi are used, the peak output power from the intentional radiator shall be reduced below the stated values as appropriate, by the amount in dB that the directional gain of the antenna exceeds 6 dBi.
2. Systems operating in the 2400-2483.5 MHz band that are used exclusively for fixed, point-to-point operations may employ transmitting antennas with directional gain greater than 6 dBi provided the maximum peak output power of the intentional radiator is reduced by 1 dB for every 3 dB that the directional gain of the antenna exceeds 6 dBi.

4.4.2 INSTRUMENTS

Description & Manufacturer	Model No.	Serial No.	Calibrated Until
R&S SPECTRUM ANALYZER	FSP30	100019	Dec. 19, 2004
R&S SIGNAL GENERATOR	SMP04	100011	May 28, 2004
TEKTRONIX OSCILLOSCOPE	TDS 220	B048470	Mar. 05, 2004
NARDA DETECTOR	4503A	FSCM99899	NA

NOTE:

The calibration interval of the above test instruments is 12 months and the calibrations are traceable to NML/ROC and NIST/USA.



4.4.3 TEST PROCEDURES

1. A detector was used on the output port of the EUT. An oscilloscope was used to read the peak response of the detector.
2. Replaced the EUT by the signal generator. The center frequency of the S.G was adjusted to the center frequency of the measured channel.
3. Adjusted the power to have the same peak reading on oscilloscope.
Record the power level.

4.4.4 TEST SETUP



4.4.5 EUT OPERATING CONDITIONS

Same as Item 4.3.6



4.4.6 TEST RESULTS -DSSS

EUT	Flanker Pro Dual Radio AP	MODEL	AP-AG-AT-02
INPUT POWER (SYSTEM)	120Vac, 60Hz	ENVIRONMENTAL CONDITIONS	23deg. C, 58%RH, 982 hPa
TESTED BY	Eric Lee		

Antenna 1 (Gain 2.5 dBi)

CHANNEL	CHANNEL FREQUENCY (MHz)	PEAK POWER OUTPUT (dBm)	PEAK POWER LIMIT (dBm)	PASS/FAIL
1	2412	22.33	30	PASS
6	2437	21.46	30	PASS
11	2462	21.39	30	PASS

Antenna 2 (Gain 2 dBi)

CHANNEL	CHANNEL FREQUENCY (MHz)	PEAK POWER OUTPUT (dBm)	PEAK POWER LIMIT (dBm)	PASS/FAIL
1	2412	23.33	30	PASS
6	2437	21.46	30	PASS
11	2462	21.39	30	PASS

Antenna 3 (Gain 3 dBi)

CHANNEL	CHANNEL FREQUENCY (MHz)	PEAK POWER OUTPUT (dBm)	PEAK POWER LIMIT (dBm)	PASS/FAIL
1	2412	22.62	30	PASS
6	2437	22.34	30	PASS
11	2462	22.17	30	PASS

Antenna 4 (Gain 10 dBi)

CHANNEL	CHANNEL FREQUENCY (MHz)	PEAK POWER OUTPUT (dBm)	PEAK POWER LIMIT (dBm)	PASS/FAIL
1	2412	17.23	26	PASS
6	2437	21.00	26	PASS
11	2462	18.50	26	PASS



EUT	Flanker Pro Dual Radio AP	MODEL	AP-AG-AT-02
INPUT POWER (SYSTEM)	120Vac, 60Hz	ENVIRONMENTAL CONDITIONS	23deg. C, 58%RH, 982 hPa
TESTED BY	Eric Lee		

Antenna 5 (Gain 14 dBi)

CHANNEL	CHANNEL FREQUENCY (MHz)	PEAK POWER OUTPUT (dBm)	PEAK POWER LIMIT (dBm)	PASS/FAIL
1	2412	7.12	22	PASS
6	2437	12.86	22	PASS
11	2462	8.62	22	PASS

Antenna 6 (Gain 14 dBi)

CHANNEL	CHANNEL FREQUENCY (MHz)	PEAK POWER OUTPUT (dBm)	PEAK POWER LIMIT (dBm)	PASS/FAIL
1	2412	9.05	22	PASS
6	2437	17.92	22	PASS
11	2462	16.50	22	PASS

Antenna 7 (Gain 24 dBi)

CHANNEL	CHANNEL FREQUENCY (MHz)	PEAK POWER OUTPUT (dBm)	PEAK POWER LIMIT (dBm)	PASS/FAIL
3	2422	7.21	24	PASS
6	2437	9.24	24	PASS
9	2452	8.65	24	PASS



4.4.7 TEST RESULTS -OFDM

EUT	Flanker Pro Dual Radio AP	MODEL	AP-AG-AT-02
INPUT POWER (SYSTEM)	120Vac, 60Hz	ENVIRONMENTAL CONDITIONS	21deg. C, 58%RH, 982 hPa
TESTED BY	Eric Lee		

Antenna 1 (Gain 2.5 dBi)

CHANNEL	CHANNEL FREQUENCY (MHz)	PEAK POWER OUTPUT (dBm)	PEAK POWER LIMIT (dBm)	PASS/FAIL
1	2412	19.30	30	PASS
6	2437	23.04	30	PASS
11	2462	20.24	30	PASS

Antenna 2 (Gain 2 dBi)

CHANNEL	CHANNEL FREQUENCY (MHz)	PEAK POWER OUTPUT (dBm)	PEAK POWER LIMIT (dBm)	PASS/FAIL
1	2412	21.14	30	PASS
6	2437	24.32	30	PASS
11	2462	20.96	30	PASS

Antenna 3 (Gain 3 dBi)

CHANNEL	CHANNEL FREQUENCY (MHz)	PEAK POWER OUTPUT (dBm)	PEAK POWER LIMIT (dBm)	PASS/FAIL
1	2412	22.30	30	PASS
6	2437	23.17	30	PASS
11	2462	21.80	30	PASS

Antenna 4 (Gain 10 dBi)

CHANNEL	CHANNEL FREQUENCY (MHz)	PEAK POWER OUTPUT (dBm)	PEAK POWER LIMIT (dBm)	PASS/FAIL
1	2412	17.01	26	PASS
6	2437	20.84	26	PASS
11	2462	17.23	26	PASS



EUT	Flanker Pro Dual Radio AP	MODEL	AP-AG-AT-02
INPUT POWER (SYSTEM)	120Vac, 60Hz	ENVIRONMENTAL CONDITIONS	21deg. C, 58%RH, 982 hPa
TESTED BY	Eric Lee		

Antenna 5 (Gain 14 dBi)

CHANNEL	CHANNEL FREQUENCY (MHz)	PEAK POWER OUTPUT (dBm)	PEAK POWER LIMIT (dBm)	PASS/FAIL
1	2412	11.01	22	PASS
6	2437	12.02	22	PASS
11	2462	11.93	22	PASS

Antenna 6 (Gain 14 dBi)

CHANNEL	CHANNEL FREQUENCY (MHz)	PEAK POWER OUTPUT (dBm)	PEAK POWER LIMIT (dBm)	PASS/FAIL
1	2412	13.50	22	PASS
6	2437	17.74	22	PASS
11	2462	15.72	22	PASS

Antenna 7 (Gain 24 dBi)

CHANNEL	CHANNEL FREQUENCY (MHz)	PEAK POWER OUTPUT (dBm)	PEAK POWER LIMIT (dBm)	PASS/FAIL
3	2422	11.05	24	PASS
6	2437	12.06	24	PASS
9	2452	12.10	24	PASS



4.5 POWER SPECTRAL DENSITY MEASUREMENT

4.5.1 LIMITS OF POWER SPECTRAL DENSITY MEASUREMENT

The Maximum of Power Spectral Density Measurement is 8dBm.

4.5.2 TEST INSTRUMENTS

Description & Manufacturer	Model No.	Serial No.	Calibrated Until
R&S SPECTRUM ANALYZER	FSP	1093.4495.30	Dec. 19, 2004

NOTE:

- 1.The measurement uncertainty is less than +/- 2.6dB, which is calculated as per the NAMAS document NIS81.
- 2.The calibration interval of the above test instruments is 12 months and the calibrations are traceable to NML/ROC and NIST/USA.

4.5.3 TEST PROCEDURE

The transmitter output was connected to the spectrum analyzer through an attenuator, the bandwidth of the fundamental frequency was measured with the spectrum analyzer using 3 kHz RBW and 30 kHz VBW, set sweep time = span/3 kHz. The power spectral density was measured and recorded.

The sweep time is allowed to be longer than span/3 kHz for a full response of the mixer in the spectrum analyzer.

4.5.4 DEVIATION FROM TEST STANDARD

No deviation

4.5.5 TEST SETUP

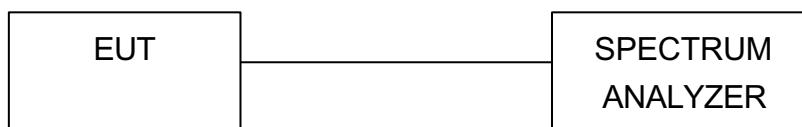

4.5.6 EUT OPERATING CONDITION

Same as Item 4.3.6



4.5.7 TEST RESULTS-DSSS

EUT	Flanker Pro Dual Radio AP	MODEL	AP-AG-AT-02
INPUT POWER (SYSTEM)	120Vac, 60Hz	ENVIRONMENTAL CONDITIONS	21deg. C, 58RH, 982 hPa
TESTED BY	Eric Lee		

CHANNEL NUMBER	CHANNEL FREQUENCY (MHz)	RF POWER LEVEL IN 3 kHz BW (dBm)	MAXIMUM LIMIT (dBm)	PASS/FAIL
1	2412	5.42	8	PASS
6	2437	5.15	8	PASS
11	2462	6.92	8	PASS



CH1

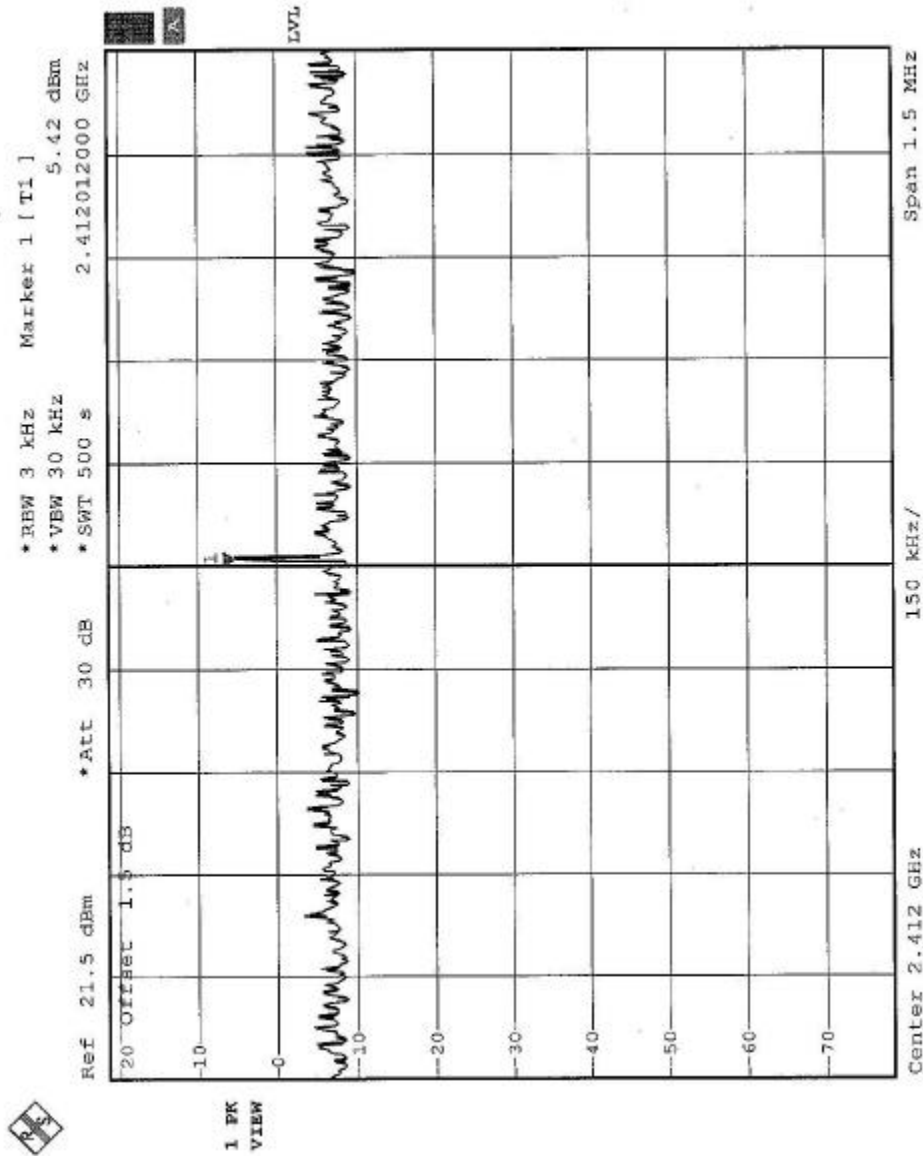



CH6

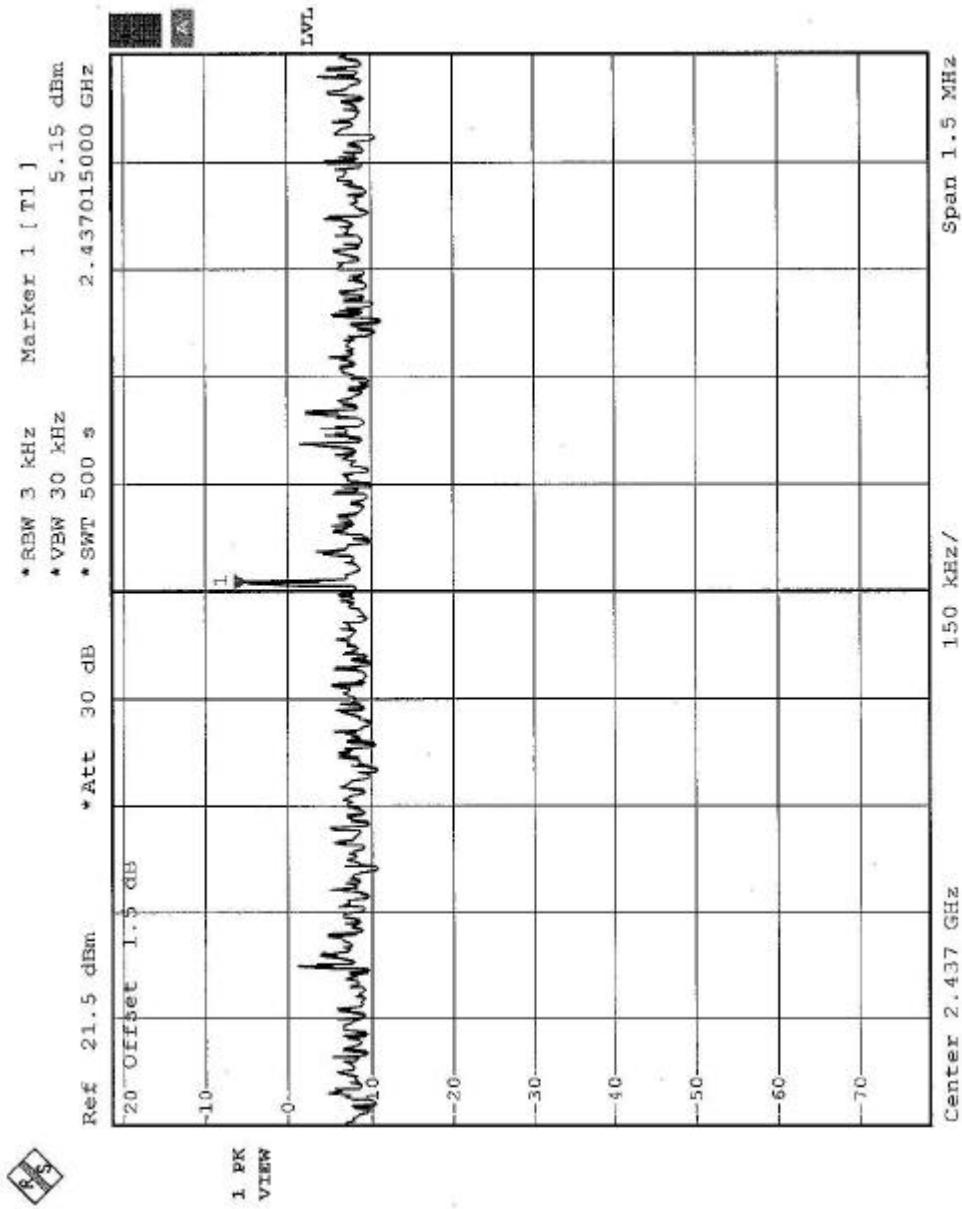



CH11

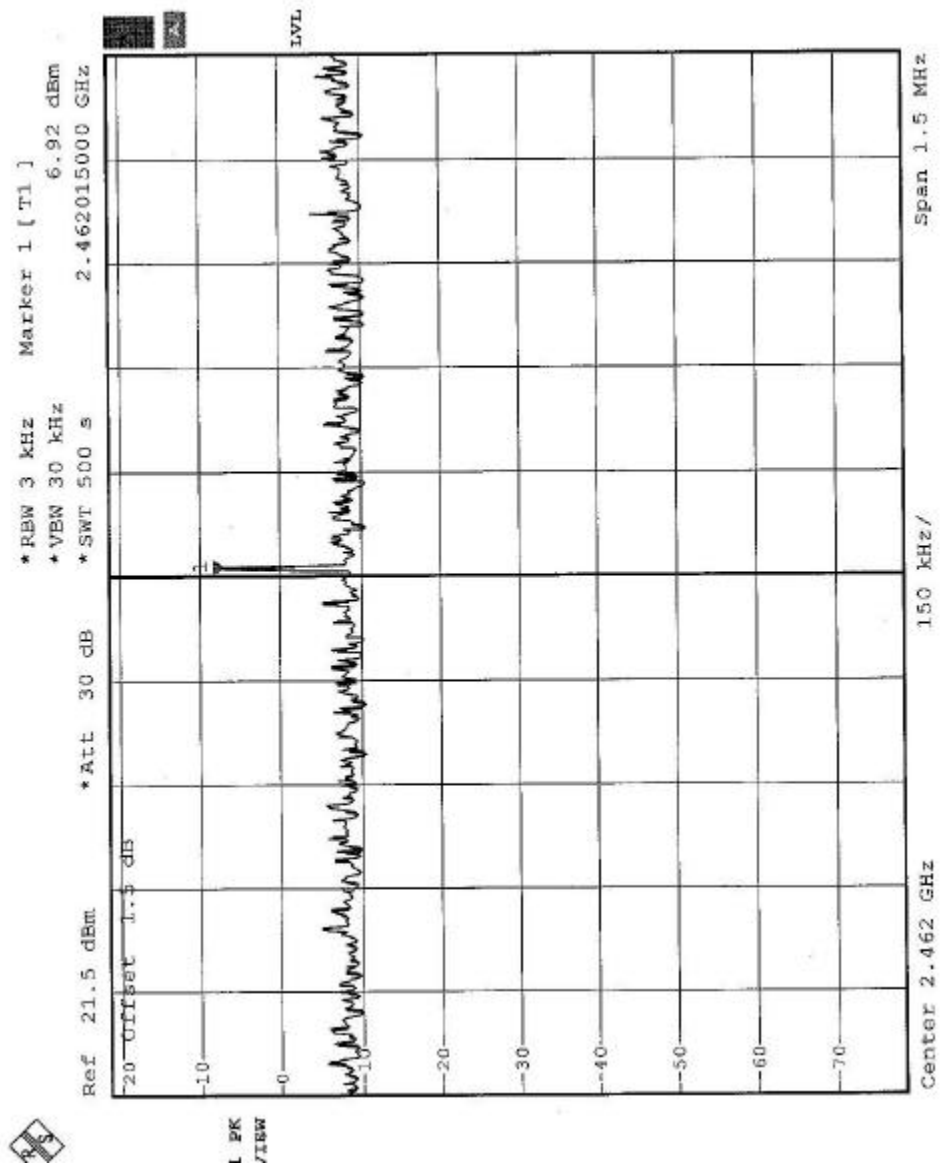



4.5.8 TEST RESULTS-OFDM

EUT	Flanker Pro Dual Radio AP	MODEL	AP-AG-AT-02
INPUT POWER (SYSTEM)	120Vac, 60Hz	ENVIRONMENTAL CONDITIONS	21deg. C, 58RH, 982 hPa
TESTED BY	Eric Lee		

CHANNEL NUMBER	CHANNEL FREQUENCY (MHz)	RF POWER LEVEL IN 3 kHz BW (dBm)	MAXIMUM LIMIT (dBm)	PASS/FAIL
1	2412	4.36	8	PASS
6	2437	3.75	8	PASS
11	2462	3.23	8	PASS



CH1

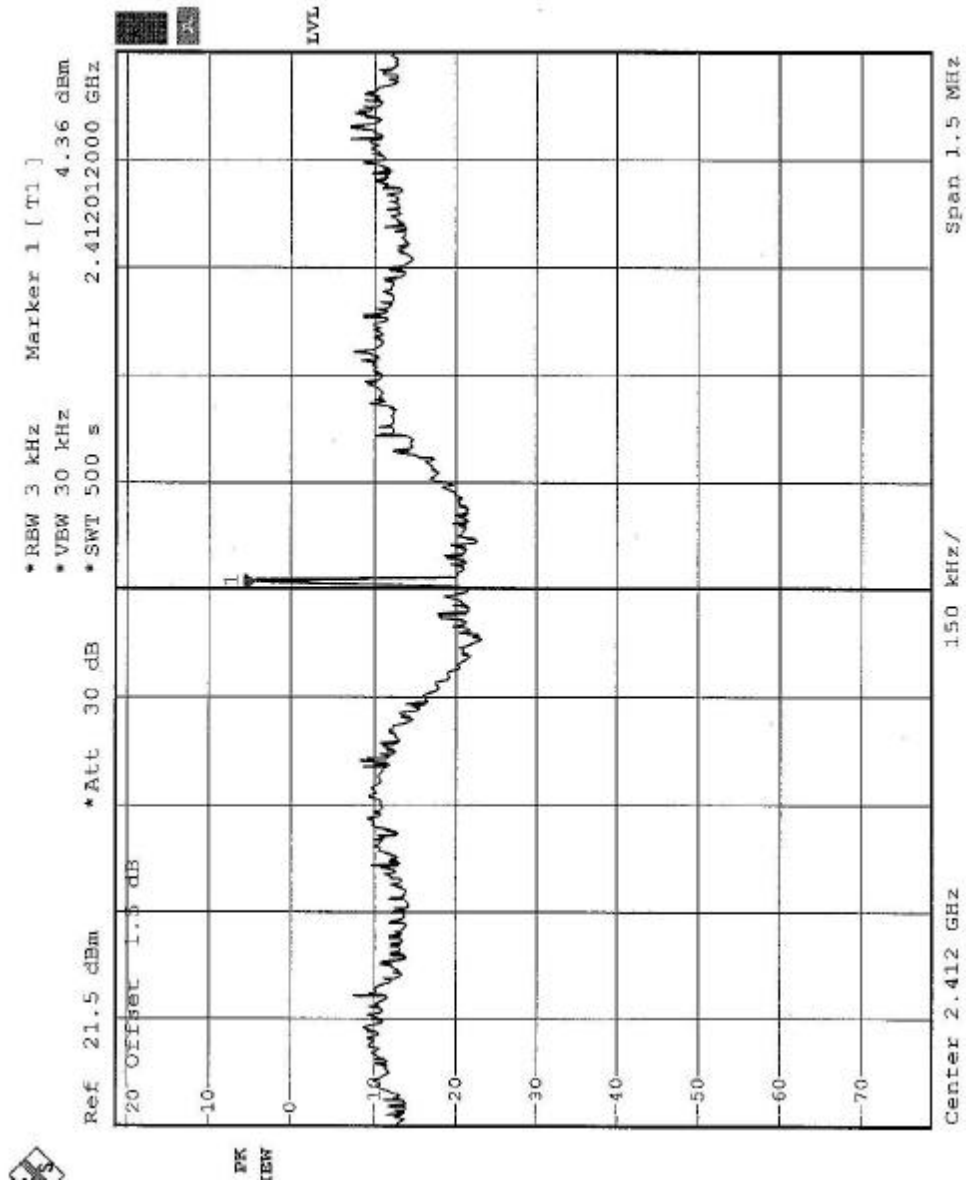



CH6

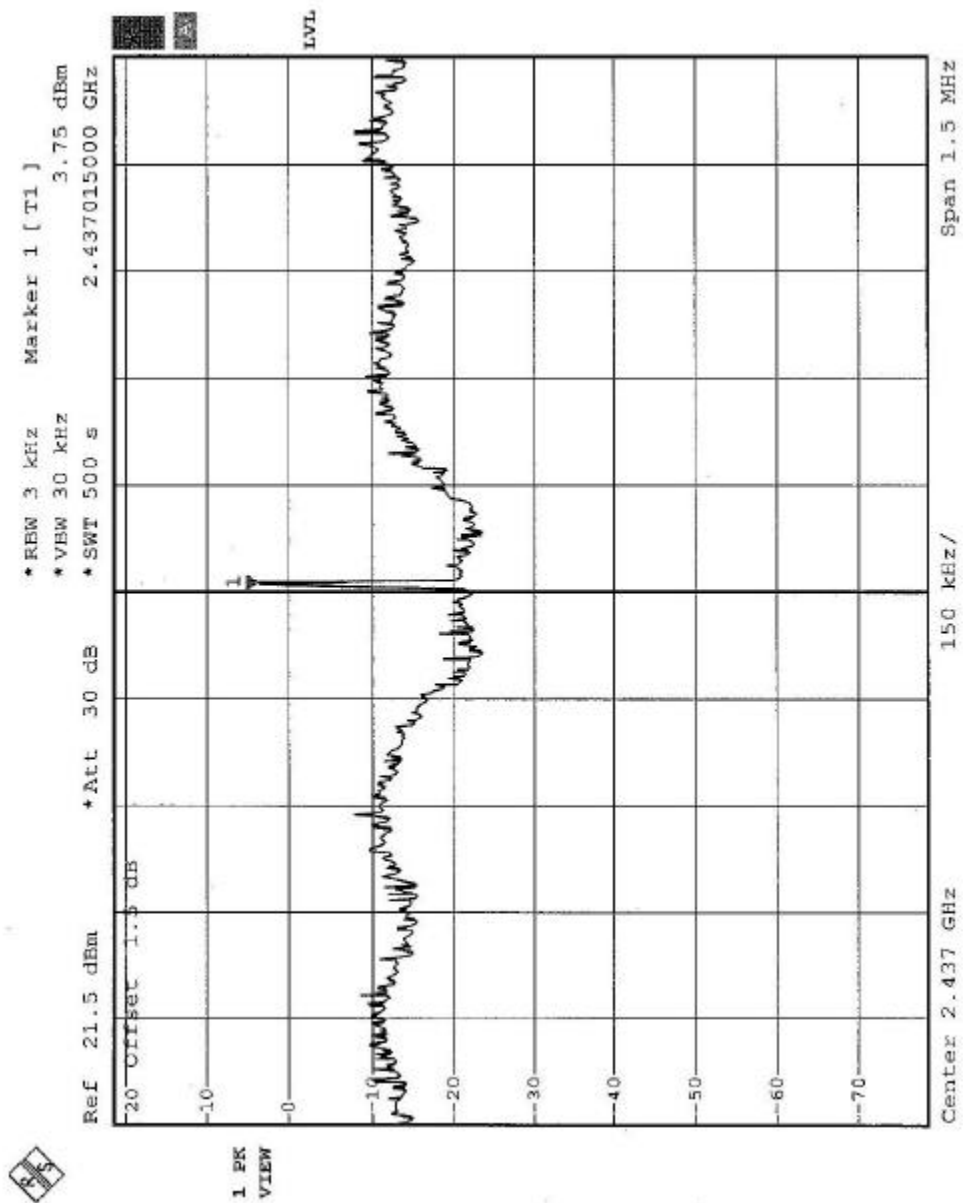



CH11

