



FCC TEST REPORT

REPORT NO.: RF921107R01

MODEL NO.: AP-AG-AT-01, AP-AG-AT-03, RT-AG-AT-01

RECEIVED: Nov. 07, 2003

TESTED: Nov. 07, 2003 to Jan. 13, 2004

APPLICANT: UNIVERSAL SCIENTIFIC INDUSTRIAL CO., LTD.

ADDRESS: 141, Lane 351, Taiping Road, Sec. 1, Tsao Tuen,
Nan-Tou, Taiwan, R.O.C.

ISSUED BY: Advance Data Technology Corporation

LAB LOCATION: No. 81-1, Lu Liao Keng, 9 Ling, Wu Lung Tsuen,
Chiung Lin Hsiang, Hsin Chu Hsien,
Taiwan, R.O.C.

This test report consists of 403 pages in total. It may be duplicated completely for legal use with the approval of the applicant. It should not be reproduced except in full, without the written approval of our laboratory. The test results in the report only apply to the tested sample.



0536

ILAC MRA



Table of Contents

1.	CERTIFICATION.....	7
2.	SUMMARY OF TEST RESULTS.....	8
3.	GENERAL INFORMATION	11
3.1	GENERAL DESCRIPTION OF EUT.....	11
3.2	DESCRIPTION OF TEST MODES.....	15
3.3	GENERAL DESCRIPTION OF APPLIED STANDARDS	16
3.4	DESCRIPTION OF SUPPORT UNITS.....	17
4.	TEST TYPES AND RESULTS (FOR PART 802.11B)	20
4.1	CONDUCTED EMISSION MEASUREMENT	20
4.1.1	LIMITS OF CONDUCTED EMISSION MEASUREMENT	20
4.1.2	TEST INSTRUMENTS.....	20
4.1.3	TEST PROCEDURES	21
4.1.4	DEVIATION FROM TEST STANDARD	21
4.1.5	TEST SETUP.....	22
4.1.6	EUT OPERATING CONDITIONS.....	22
4.1.7	TEST RESULTS (ADAPTER 1)	23
4.1.8	TEST RESULTS (ADAPTER 2)	25
4.1.9	TEST RESULTS (POE).....	27
4.2	RADIATED EMISSION MEASUREMENT	29
4.2.1	LIMITS OF RADIATED EMISSION MEASUREMENT	29
4.2.2	TEST INSTRUMENTS.....	30
4.2.3	TEST PROCEDURES	31
4.2.4	DEVIATION FROM TEST STANDARD	31
4.2.5	TEST SETUP.....	32
4.2.6	EUT OPERATING CONDITIONS.....	32
4.2.7	TEST RESULTS	33
4.2.8	TEST RESULTS - DSSS (ANTENNA 1).....	54
4.2.9	TEST RESULTS - DSSS (ANTENNA 2).....	57
4.2.10	TEST RESULTS - DSSS (ANTENNA 3).....	63
4.2.11	TEST RESULTS - DSSS (ANTENNA 4).....	66
4.2.12	TEST RESULTS - DSSS (ANTENNA 5).....	70
4.2.13	TEST RESULTS - DSSS (ANTENNA 6).....	73
4.2.14	TEST RESULTS - DSSS (ANTENNA 7).....	76
4.2.15	TEST RESULTS - OFDM (ANTENNA 1).....	79
4.2.16	TEST RESULTS - OFDM (ANTENNA 2).....	82
4.2.17	TEST RESULTS - OFDM (ANTENNA 3).....	88
4.2.18	TEST RESULTS - OFDM (ANTENNA 4).....	91
4.2.19	TEST RESULTS - OFDM (ANTENNA 5).....	95
4.2.20	TEST RESULTS - OFDM (ANTENNA 6).....	98



4.2.21 TEST RESULTS - OFDM (ANTENNA 7) 101

4.3 6DB BANDWIDTH MEASUREMENT..... 105

4.3.1 LIMITS OF 6DB BANDWIDTH MEASUREMENT 105

4.3.2 TEST INSTRUMENTS..... 105

4.3.3 TEST PROCEDURE..... 106

4.3.4 DEVIATION FROM TEST STANDARD 106

4.3.5 TEST SETUP..... 106

4.3.6 EUT OPERATING CONDITIONS..... 106

4.3.7 TEST RESULTS -DSSS..... 107

4.3.8 TEST RESULTS -OFDM..... 111

4.4 MAXIMUM PEAK OUTPUT POWER 115

4.4.1 LIMITS OF MAXIMUM PEAK OUTPUT POWER MEASUREMENT..... 115

4.4.2 INSTRUMENTS..... 115

4.4.3 TEST PROCEDURES 116

4.4.4 TEST SETUP..... 116

4.4.5 EUT OPERATING CONDITIONS..... 116

4.4.6 TEST RESULTS -DSSS..... 117

4.4.7 TEST RESULTS -OFDM..... 119

4.5 POWER SPECTRAL DENSITY MEASUREMENT 121

4.5.1 LIMITS OF POWER SPECTRAL DENSITY MEASUREMENT..... 121

4.5.2 TEST INSTRUMENTS..... 121

4.5.3 TEST PROCEDURE..... 122

4.5.4 DEVIATION FROM TEST STANDARD 122

4.5.5 TEST SETUP..... 122

4.5.6 EUT OPERATING CONDITION..... 122

4.5.7 TEST RESULTS-DSSS..... 123

4.5.8 TEST RESULTS-OFDM..... 127

4.6 BAND EDGES MEASUREMENT 131

4.6.1 LIMITS OF BAND EDGES MEASUREMENT 131

4.6.2 TEST INSTRUMENTS..... 131

4.6.3 TEST PROCEDURE..... 131

4.6.4 DEVIATION FROM TEST STANDARD 131

4.6.5 EUT OPERATING CONDITION..... 132

4.6.6 TEST RESULTS –DSSS (ANTENNA 1)..... 132

4.6.7 TEST RESULTS –DSSS (ANTENNA 2)..... 135

4.6.8 TEST RESULTS –DSSS (ANTENNA 3)..... 138

4.6.9 TEST RESULTS –DSSS (ANTENNA 4)..... 141

4.6.10 TEST RESULTS –DSSS (ANTENNA 5)..... 144

4.6.11 TEST RESULTS –DSSS (ANTENNA 6)..... 147

4.6.12 TEST RESULTS –DSSS (ANTENNA 7)..... 150

4.6.13 TEST RESULTS –OFDM (ANTENNA 1) 153

4.6.14 TEST RESULTS –OFDM (ANTENNA 2)..... 156



4.6.15	TEST RESULTS –OFDM (ANTENNA 3)	159
4.6.16	TEST RESULTS –OFDM (ANTENNA 4)	162
4.6.17	TEST RESULTS –OFDM (ANTENNA 5)	165
4.6.18	TEST RESULTS –OFDM (ANTENNA 6)	168
4.6.19	TEST RESULTS –OFDM (ANTENNA 7)	171
4.7	ANTENNA REQUIREMENT	174
4.7.1	STANDARD APPLICABLE	174
4.7.2	ANTENNA CONNECTED CONSTRUCTION	174
5.	TEST TYPES AND RESULTS (FOR PART 802.11A)	175
5.1	CONDUCTED EMISSION MEASUREMENT	175
5.1.1	LIMITS OF CONDUCTED EMISSION MEASUREMENT	175
5.1.2	TEST INSTRUMENTS	175
5.1.3	TEST PROCEDURES	176
5.1.4	DEVIATION FROM TEST STANDARD	176
5.1.5	TEST SETUP	177
5.1.6	EUT OPERATING CONDITIONS	177
5.1.7	TEST RESULTS (ADAPTER 1)	178
5.1.8	TEST RESULTS (ADAPTER 2)	180
5.1.9	TEST RESULTS (POE)	182
5.2	RADIATED EMISSION MEASUREMENT	184
5.2.1	LIMITS OF RADIATED EMISSION MEASUREMENT	184
5.2.2	LIMITS OF UNWANTED EMISSION OUT OF THE RESTRICTED BANDS	185
5.2.3	TEST INSTRUMENTS	186
5.2.4	TEST PROCEDURES	187
5.2.5	DEVIATION FROM TEST STANDARD	187
5.2.6	TEST SETUP	188
5.2.7	EUT OPERATING CONDITIONS	188
5.2.8	TEST RESULTS	189
5.2.9	TEST RESULTS (ANTENNA 1)	213
5.2.10	TEST RESULTS (ANTENNA 2)	221
5.2.11	TEST RESULTS (ANTENNA 3)	233
5.2.12	TEST RESULTS (ANTENNA 4)	245
5.2.13	TEST RESULTS (ANTENNA 5)	248
5.2.14	TEST RESULTS (ANTENNA 6)	256
5.2.15	TEST RESULTS (ANTENNA 7)	264
5.2.16	TEST RESULTS (ANTENNA 8)	272
	FOR FREQUENCY 5.15~5.35GHZ	277
5.3	PEAK TRANSMIT POWER MEASUREMENT	277
5.3.1	LIMITS OF PEAK TRANSMIT POWER MEASUREMENT	277
5.3.2	TEST INSTRUMENTS	277
5.3.3	TEST PROCEDURE	278
5.3.4	TEST SETUP	278



5.3.5 EUT OPERATING CONDITIONS.....278

5.3.6 TEST RESULTS279

5.4 PEAK POWER EXCURSION MEASUREMENT283

5.4.1 LIMITS OF PEAK POWER EXCURSION MEASUREMENT283

5.4.2 TEST INSTRUMENTS.....283

5.4.3 TEST PROCEDURE.....284

5.4.4 DEVIATION FROM TEST STANDARD284

5.4.5 TEST SETUP.....284

5.4.6 EUT OPERATING CONDITIONS.....284

5.4.7 TEST RESULTS285

5.5 PEAK POWER SPECTRAL DENSITY MEASUREMENT294

5.5.1 LIMITS OF PEAK POWER SPECTRAL DENSITY MEASUREMENT294

5.5.2 TEST INSTRUMENTS.....294

5.5.3 TEST PROCEDURES295

5.5.4 DEVIATION FROM TEST STANDARD295

5.5.5 TEST SETUP.....295

5.5.6 EUT OPERATING CONDITIONS.....295

5.5.7 TEST RESULTS296

5.6 FREQUENCY STABILITY305

5.6.1 LIMITS OF FREQUENCY STABILITY MEASUREMENT305

5.6.2 TEST INSTRUMENTS.....305

5.6.3 TEST PROCEDURE.....305

5.6.4 DEVIATION FROM TEST STANDARD305

5.6.5 TEST SETUP.....306

5.6.6 EUT OPERATING CONDITION.....306

5.6.7 TEST RESULTS307

5.7 BAND EDGES MEASUREMENT.....308

5.7.1 TEST INSTRUMENTS.....308

5.7.2 TEST PROCEDURE.....308

5.7.3 EUT OPERATING CONDITION.....308

5.7.4 TEST RESULTS (ANTENNA 1)309

5.7.5 TEST RESULTS (ANTENNA 2)312

5.7.6 TEST RESULTS (ANTENNA 3)317

5.7.7 TEST RESULTS (ANTENNA 4)323

5.7.8 TEST RESULTS (ANTENNA 5)326

5.7.9 TEST RESULTS (ANTENNA 6)329

5.7.10 TEST RESULTS (ANTENNA 7)332

5.8 6DB BANDWIDTH MEASUREMENT.....335

5.8.1 LIMITS OF 6DB BANDWIDTH MEASUREMENT335

5.8.2 TEST INSTRUMENTS.....335

5.8.3 TEST PROCEDURE.....336

5.8.4 DEVIATION FROM TEST STANDARD336



5.8.5 TEST SETUP.....336

5.8.6 EUT OPERATING CONDITIONS.....336

5.8.7 TEST RESULTS337

5.9 MAXIMUM PEAK OUTPUT POWER.....344

5.9.1 LIMITS OF PEAK TRANSMIT POWER MEASUREMENT344

5.9.2 TEST INSTRUMENTS.....344

5.9.3 TEST PROCEDURE.....345

5.9.4 TEST SETUP.....345

5.9.5 EUT OPERATING CONDITIONS.....345

5.9.6 TEST RESULTS346

5.10 POWER SPECTRAL DENSITY350

5.10.1 LIMITS OF POWER SPECTRAL DENSITY MEASUREMENT.....350

5.10.2 TEST INSTRUMENTS.....350

5.10.3 TEST PROCEDURE.....351

5.10.4 DEVIATION FROM TEST STANDARD351

5.10.5 TEST SETUP.....351

5.10.6 EUT OPERATING CONDITION.....351

5.10.7 TEST RESULTS352

5.11 BAND EDGES MEASUREMENT.....359

5.11.1 LIMITS OF BAND EDGES MEASUREMENT359

5.11.2 TEST INSTRUMENTS.....359

5.11.3 TEST PROCEDURE.....359

5.11.4 DEVIATION FROM TEST STANDARD359

5.11.5 EUT OPERATING CONDITION.....360

5.11.6 TEST RESULTS360

5.12 ANTENNA REQUIREMENT.....389

5.12.1 STANDARD APPLICABLE.....389

5.12.2 ANTENNA CONNECTED CONSTRUCTION.....389

6. PHOTOGRAPHS OF THE TEST CONFIGURATION.....390

7. INFORMATION ON THE TESTING LABORATORIES403



1. CERTIFICATION

PRODUCT : Flanker Pro Single Radio AP
BRAND NAME : USI, Proxim
MODEL NO. : AP-AG-AT-01, AP-AG-AT-03, RT-AG-AT-01
APPLICANT : UNIVERSAL SCIENTIFIC INDUSTRIAL CO., LTD.
STANDARDS : 47 CFR Part 15, Subpart C (Section 15.247),
Subpart E (Section 15.407), ANSI C63.4-1992

We, **Advance Data Technology Corporation**, hereby certify that one sample (AP-AG-AT-01) of the designation has been tested in our facility from Nov. 07, 2003 to Jan. 13, 2004. The test record data evaluation and Equipment under Test (EUT) configurations represented herein are true and accurate accounts of the measurements of the sample's EMC characteristics under the conditions herein specified.

PREPARED BY: Carol Liao, **DATE:** Jan. 13, 2004
(Carol Liao)

APPROVED BY: Eric Lin, **DATE:** Jan. 13, 2004
(Eric Lin, Manager)



2. SUMMARY OF TEST RESULTS

The EUT has been tested according to the following specifications:

APPLIED STANDARD: 47 CFR Part 15, Subpart C			
Standard Section	Test Type and Limit	Result	REMARK
15.207	AC Power Conducted Emission	PASS	Meet the requirement of limit Minimum passing margin is -9.27dBuV at 2.541MHz
15.247(a)(2)	Spectrum Bandwidth of a Direct Sequence Spread Spectrum System Limit: min. 500kHz	PASS	Meet the requirement of limit
15.247(b)	Maximum Peak Output Power Limit: max. 30dBm	PASS	Meet the requirement of limit
15.247(c)	Transmitter Radiated Emissions FCC Limit: Table 15.209	PASS	Meet the requirement of limit Minimum passing margin is -0.70dBuV at 2390.00MHz
15.247(d)	Power Spectral Density Limit: max. 8dBm	PASS	Meet the requirement of limit
15.247(c)	Band Edge Measurement Limit: 20 dB less than the peak value of fundamental frequency	PASS	Meet the requirement of limit



for freq. 5.15~5.35GHz :

APPLIED STANDARD: 47 CFR Part 15, Subpart E			
Standard Section	Test Type	Result	REMARK
15.407(b)(5)	AC Power Conducted Emission	PASS	Meet the requirement of limit Minimum passing margin is -10.09dBuVat 2.60312MHz
15.407(b/1/2/3) (b)(5)	Electric Field Strength Spurious Emissions, 30MHz ~ 40000MHz	PASS	Meet the requirement of limit Minimum passing margin is -2.60dBuV at 17475.00MHz
15.407(a/1/2/3)	Peak Transmit Power	PASS	Meet the requirement of limit
15.407(a)(6)	Peak Power Excursion	PASS	Meet the requirement of limit
15.407(a/1/2/3)	Peak Power Spectral Density	PASS	Meet the requirement of limit
15.407(g)	Frequency Stability	PASS	Meet the requirement of limit



for freq. 5.725~5.850GHz :

APPLIED STANDARD: 47 CFR Part 15, Subpart C			
Standard Section	Test Type and Limit	Result	REMARK
15.207	AC Power Conducted Emission	PASS	Meet the requirement of limit Minimum passing margin is -10.09dBuV at 2.60312MHz
15.247(a)(2)	Spectrum Bandwidth of a Direct Sequence Spread Spectrum System Limit: min. 500kHz	PASS	Meet the requirement of limit
15.247(b)	Maximum Peak Output Power Limit: max. 30dBm	PASS	Meet the requirement of limit
15.247(c)	Transmitter Radiated Emissions FCC Limit: Table 15.209	PASS	Meet the requirement of limit Minimum passing margin is -1.10dBuV at 5144.00.00MHz
15.247(d)	Power Spectral Density Limit: max. 8dBm	PASS	Meet the requirement of limit
15.247(c)	Band Edge Measurement Limit: 20 dB less than the peak value of fundamental frequency	PASS	Meet the requirement of limit



3. GENERAL INFORMATION

3.1 GENERAL DESCRIPTION OF EUT

PRODUCT	Flanker Pro Single Radio AP
MODEL NO.	AP-AG-AT-01, AP-AG-AT-03, RT-AG-AT-01
POWER SUPPLY	5VDC from POE (Power Over Ethernet)/ AC adapter
MODULATION	DSSS, OFDM
TRANSFER RATE	802.11b and draft 802.11g: 1/2/5.5/6/9/11/12/18/24/36/48/54Mbps 802.11a:6 to 54Mbps (Turbo mode: up to 108Mbps *see note 1)
FREQUENCY RANGE	802.11b and draft 802.11g: 2400MHz ~ 2483.5MHz 802.11a: 5.15~5.35GHz and 5.725~5.850GHz
NUMBER OF CHANNEL	802.11b and draft 802.11g: 11 802.11a: 13 for Normal mode / 5 for Turbo mode
CHANNEL SPACING	802.11b and draft 802.11g: 5MHz 802.11a: 20MHz for Normal mode / 40MHz for Turbo mode
MAX OUTPUT POWER	802.11b: 21.94dBm / draft 802.11g: 23.28dBm 802.11a: 23.38dBm
DATA CABLE	NA
ANTENNA TYPE	See Note 3
I/O PORTS	RJ 45 (POE) Port x 1
ASSOCIATED DEVICES	NA

NOTE:

1. This EUT is capable of providing data rates of up to 108Mbps in Turbo Mode depending upon reception quality.
2. The EUT has three model numbers, and it is included two brand names which are identical to each other in all aspects except for the followings:

Model Name	Brand	Flash Size (Byte)	RAM Size (Byte)	Exernal Power	Temperature Range ()	Remark
AP-AG-AT-01	USI,	4M	16M	Yes	0 to +55	FP1
AP-AG-AT-03	Proxim	512k	8M	No	0 to +40	Lite-AP
RT-AG-AT-01		8M	64M	Yes	0 to +55	HS1



3. This EUT with 54 antennas, please refer to the following table:

No	antenna		technical parameters			identification		
	type	details	Band (GHz)	Gain (dBi)	G _{eff}	Vendor	Vendor model (in development)	Proxim model
1	Omni	(1) diversity 20cm	2400~2500	3	3	PROXIM	(in development)	AIN24-ODD-3
2	Omni	vehicular	2400~2500	5	1.5	Telex	2449LT	AOU24-OD-55-B
3	Omni	(2) 30cm: 30cm	2400~2500	7	5	Smart Ant	EMW 24-03005-BFL	AIN24-OD-5
4	Omni	(3) 30cm: 50cm	2400~2500	7	7	PROXIM	(not available)	AIN24-OD-8
5	Omni		2400~2500	7	7	Maxrad	MFB24008	AOU24-OD-77
6	Omni		2400~2500	10	10	Telex	2439LT	AOU24-OD-10
7	Panel	(4) patch diversity 10x10cm: 11.4x11.4x4 cm	2400~2500	6	4.1	Smart Ant	R0305-141	AIN24-PAD-6
8	Panel	(5) patch 12x12cm: 11.4x11.4x4 cm	2400~2500	8.5	8.5	Smart Ant	R0205-125	AIN24-PA-8.5
9	Panel	(6) patch 12x12cm: 11.4x11.4x4 cm	2400~2500	9.5	9.5	Smart Ant	R0305-142	AIN24-PA-10.5
10	Panel	wide angle	2400~2500	12	12	Telex	2443LT	AOU24-WA-12-B
11	Panel	window	2400~2500	12	11.7	Smart Ant	R0305-019	AOU24-WI-12-B
12	Panel		2400~2500	14	14	Smart Ant	R0205-064	AOU24-DI-14
13	Yagi		2400~2500	14	14	Telex	2415LT	AOU24-YA-1414
14	Parabol	grid reflector	2400~2500	24	24	Conifer	26WT-2400F	AOU24-DI-24
15	Omni	15 cm dual band	2400~2500 / 5150~5850	2.5 / 5.5	0.4 / 1.9	Smart Ant	R0322-083	AIN-WB-OD-B
16	Omni	(7) diversity 10x20cm	5150~5875	3	3	PROXIM	(in development)	AIN50-ODD-3
17	Omni		5250~5850	8	8	Smart Ant	R0320-101	5054-OA-8
18	Omni	wideband		10	9.9	Smart Ant	R0320-102	5054-OA-10
19	Omni		5250~5350	10	10	Stella Doradus	52 2360	5054-OA52-10
20	Omni		5470~5725	10	10	Stella Doradus	56 2360	5054-OA56-10
21	Omni		5725~5875	10	10	Stella Doradus	58 2360	5054-OA58-10
22	Omni	for US/Can & Europe	5250~5350	13	13	Stella Doradus	52 3360	5054-OA52-13
23	Omni	for Europe	5470~5725	13	13	Stella Doradus	56 3360	5054-OA56-13
24	Omni	for US./Can	5725~5875	13	13	Stella Doradus	58 3360	5054-OA58-13
25	Sector	120deg	5250~5850	14~15	13.6	Smart Ant	R0320-099	5054-SA120-14
26	Sector	60deg	5250~5850	17	17	Radio Waves	SEC-55X-60-17	
27	Sector	60deg	5250~5850	17	16.34	Smart Ant	R0320-100	5054-SA60-17
28	Sector		5150~5850	17	17	Mars	MA-WC50-5X	
29	Panel	(8) patch 10x10cm: 8x7.6x1.7cm	5150~5875	10.5	7.3	Smart Ant	R0320-140	AIN50-PA-10.5
30	Panel	(8) patch 10x10cm: 11.4x11.4x4 cm	5150~5875	7	7	PROXIM	(not available)	AIN50-PA-13.5
31	Panel	theoretical one	5150~5850	7	7	Smart Ant	R0320-056	
32	Panel	window	5150~5850	15	13	Smart Ant	R0320-091	5054-WA-15-STN
33	Panel		5250~5875	18	18	Smart Ant	R0209-116	5054-PA-18
34	Panel		5725~5875	23	23	Smart Ant	R0209-149	5054-PA-23
35	Panel	1ft flat Panel	5250~5850	23	23	Mars	MA-WA-58-1X	
36	Panel	1ft flat Panel	5250~5850	23.9	23.5	Gabriel	DFPD1-52	
37	Panel	1ft flat Panel	5250~5850	23.6	23.6	Andrew	FPA5250D12-N	
38	Panel	2ft flat Panel	5250~5850	26.5	26.5	RSI	A57A24-U	
39	Panel	2ft flat Panel	5250~5850	28.2	28.2	Andrew	FPA5350D24-N	
40	Panel	2ft flat Panel	5250~5850	28.4	28	Gabriel	DFPD2-52	
41	Parabol	2ft	5250~5850	29	28.5	Gabriel	SSP2-52B	
42	Parabol	2ft	5250~5850	28.9	28.4	Gabriel	SSD2-52A	
43	Parabol	2ft	5250~5850	28.6	28.1	Gabriel	HSSP2-52	
44	Parabol	2ft	5250~5850	28.5	28.5	Radio Waves	SP2-5.X (X=2, 8)	
45	Parabol	2ft	5250~5850	28.1	28.1	Radio Waves	SPD2-5.X (X=2, 8)	
46	Parabol	2ft	2400~2500/5 725~5825	21.1 / 28.3	21.1 / 28.3	Radio Waves	SP2-2/5	
47	Parabol	2ft	5250~5850	30.1	29.4	Andrew	P2F-52	
48	Parabol	2ft	5250~5850	30.1	29.4	Andrew	PX2F-52	
49	Parabol	2ft	5250~5850	29	29	RSI	P-57C24	
50	Parabol	3ft	5250~5850	31.4	31.4	Radio Waves	SP3-5.X (X=2, 8)	
51	Parabol	3ft	5250~5850	31.1	31.1	Radio Waves	SPD3-5.X (X=2, 8)	
52	Parabol	2ft	2400~2500/5 725~5825	24.1 / 31.4	24.1 / 31.4	Radio Waves	SP3-2/5	
53	Parabol	3ft	5250~5850	33.5	33.4	Andrew	P3F-52 N7A	
54	Parabol	3ft	5250~5850	33.5	33.4	Andrew	P3X3F-52	



We provided twelve antennas with EUT (AP-AG-AT-01) for the worst case, were chosen for final test. The data was recorded in this report; please refer to the following table:

For 2.4GHz				
No.	Model No.	Gain (dBi)	Antenna Type	Antenna Connector
1	AIN-WB-OD-B	2.5dBi	Dual-Band Omni-Directional Antenna	Aliner 31-401A R/A plug
2	BlueChip	2.0dBi	Chip Antenna	NA
3	D-Puck	3.0dBi	Chip Antenna	NA
4	AOU24-OD-10	10 dBi	Omni	Female N-type connector
5	AOU24-DI-14	14 dBi	Panel	Female N-type connector
6	AOU24-YA-1414	14 dBi	Yagi	Female N-type connector
7	AOU24-DI-24	24 dBi	Parabol	Female N-type connector

For 5GHz				
No.	Model No.	Gain (dBi)	Antenna Type	Antenna Connector
1	AIN-WB-OD-B	3.5dBi	Dual-Band Omni-Directional Antenna	Aliner 31-401A R/A plug
2	BlueChip	3.0dBi	Chip Antenna	NA
3	D-Puck	4.0dBi	Chip Antenna	NA
4	5054-OA52-13	13 dBi	Omni	Female N-type connector
5	5054-SA60-17	17 dBi	Sector	Female N-type connector
6	FPA5350D24-N	28.2 dBi (With pad)	Panel	Female N-type connector
7	P3F-52N7A	33.4 dBi (With pad)	Parabol	Female N-type connector
8	5054-OA58-13	13 dBi	Omni	Female N-type connector

4. Frequency Range of each Antennas are as followings:

For 2.4GHz	
Antenna No.	Frequency Range
No. 1	2400MHz ~ 2483.5MHz, 5.25GHz ~ 5.35GHz, 5.725GHz ~ 5.850GHz
No. 2, 3	2400MHz ~ 2483.5MHz, 5.15GHz ~ 5.25GHz, 5.25GHz~5.35GHz, 5.725GHz ~ 5.850GHz
No. 4, 5, 6	2400MHz ~ 2500MHz
No. 7	2422MHz ~ 2452MHz

For 5GHz	
Antenna No.	Frequency Range
No. 1	2400MHz ~ 2483.5MHz, 5.25GHz ~ 5.35GHz, 5.725GHz ~ 5.850GHz
No. 2, 3	2400MHz ~ 2483.5MHz, 5.15GHz ~ 5.25GHz, 5.25GHz~5.35GHz, 5.725GHz ~ 5.850GHz
No. 4	5.25GHz ~ 5.35GHz
No. 5, 6, 7	5.25GHz~5.35GHz, 5.725GHz ~ 5.850GHz
No. 8	5.725GHz ~ 5.875GHz



5. The EUT was powered by AC adapters and POE (Power Over Ethernet) as bellows,

AC Adapter 1:	
Brand:	DVE
Model No.:	DSA-0151F-05
Input power :	100-240VAC;50-60Hz;0.4A/ClassII
Output power :	5V;2.8A/Nonshielded;W/O Core;1.9m

AC Adapter 2:	
Brand:	HIPRO
Model No.:	HP-OJ015L6A
Input power :	100-240VAC;50-60Hz;1A/ClassII
Output power :	5V;3A/Nonshielded;With Core;1.8m

POE:					
No.	Brand Name	Model Name	No. of Ports	AC Input	DC Output
1	Symbol	BIAS-T	1	85-270Vac	24VDC
2	PowerDsine	6001	1	90-264Vac 47-63Hz	48VDC
3	orinoco	orinoco AE 1Port DC Injector	1	90-264Vac 47-63Hz	42-52VDC
4	PowerDsine	3006	6	88-264Vac 47-63Hz	48VDC
5	Lucent Technologies	orinoco AE 6Port DC Injector	6	90-264Vac 47-63Hz	42-52VDC
6	Lucent Technologies	orinoco AE 12Port DC Injector	12	90-264Vac 47-63Hz	42-52VDC
7	PowerDsine	6012	12	88-264Vac 47-63Hz	48VDC

*The POE supplied power to EUT via POE port, only used on testing.

6. Peak output power (Unit : dBm) :

No.	Model No.	Operating Frequency (MHz)			
		2412~2462	5150~5250	5250~5350	5725~5850
1	AIN-WB-OD-B	22.09	NA	23.38	20.31
2	BlueChip	23.28	16.39	23.19	22.27
3	D-Puck	22.09	16.66	21.80	20.40
4	AOU24-OD-10	21.00	NA	NA	NA
5	AOU24-DI-14	18.05	NA	NA	NA
6	AOU24-YA-1414	18.01	NA	NA	NA
7	AOU24-DI-24	12.01	NA	NA	NA
8	5054-OA52-13	NA	NA	16.05	NA
9	5054-SA60-17	NA	NA	12.57	20.60
10	FPA5350D24-N	NA	NA	4.72	22.53
11	P3F-52N7A	NA	NA	4.39	20.25
12	5054-OA58-13	NA	NA	NA	21.04

7. For more detailed features description, please refer to the manufacturer's specifications or User's Manual.



3.2 DESCRIPTION OF TEST MODES

For 802.11b: Eleven channels are provided to this EUT.

Channel	Frequency	Channel	Frequency
1	2412 MHz	7	2442 MHz
2	2417 MHz	8	2447 MHz
3	2422 MHz	9	2452 MHz
4	2427 MHz	10	2457 MHz
5	2432 MHz	11	2462 MHz
6	2437 MHz		

NOTE:

1. Below 1 GHz, the channel 1, 6, and 11 were pre-tested in chamber. The channel 11, worst case one, was chosen for final test.
2. Above 1 GHz, the channel 1, 6, and 11 were tested individually.
3. Transfer rate, 11Mbps with CCK technique and 6Mbps with OFDM technique, the worst case, were chosen for final test.

For 802.11a: Thirteen channels are provided to this EUT for Normal mode.

Channel	Frequency	Channel	Frequency
1	5180 MHz	8	5320 MHz
2	5200 MHz	9	5745MHz
3	5220 MHz	10	5765MHz
4	5240 MHz	11	5785MHz
5	5260 MHz	12	5805MHz
6	5280 MHz	13	5825MHz
7	5300 MHz		

Five channels are provided to this EUT for Turbo Mode.

Channel	Frequency	Channel	Frequency
1	5210 MHz	4	5760MHz
2	5250 MHz	5	5800MHz
3	5290 MHz		

NOTE:

- 1..The EUT was tested in both normal mode (channel bandwidth of approximately 20MHz) and turbo mode (channel bandwidth of approximately 40MHz).
2. "Normal Mode" allows data rates of up to 54Mbps. The device was, therefore, tested in Normal mode at the data rate that produced the highest output power for normal mode (6Mbps).
3. "Turbo Mode" allows data rates of up to 108Mbps. At data rates higher than 12Mbps the PA gain is reduced to improve signal fidelity. The device was, therefore, tested in turbo mode at the data rate that produced the highest output power for turbo mode (12Mbps).
4. Channel 1, 4, 5, 8, 9, 11 and 13 are the closest frequencies to the band edge, were chosen for final test of Normal Mode.
5. Channel 1 ~ 5 were chosen for final test of turbo mode.



3.3 GENERAL DESCRIPTION OF APPLIED STANDARDS

The EUT is a Flanker Pro Single Radio AP According to the specifications of the manufacturer; it must comply with the requirements of the following standards:

**47 CFR Part 15, Subpart C. (15.247),
Subpart E (15.407). ANSI C63.4 : 1992**

All tests have been performed and recorded as per the above standards.

NOTE: The EUT is also considered as a kind of computer peripheral, because the connection to computer is necessary for typical use. It has been verified to comply with the requirements of 47CFR Part 15, Subpart B, Class B (DoC). The test report has been issued separately.



3.4 DESCRIPTION OF SUPPORT UNITS

The EUT has been tested as an independent unit together with other necessary accessories or support units. The following support units or accessories were used to form a representative test configuration during the tests.

No.	Product	Brand	Model No.	Serial No.	FCC ID
1	NOTEBOOK	DELL	PP01L	TW-09C748-12800-1 A3-1999	DoC

No.	Signal cable description
1	NA

Note: 1. All power cords of the above support units are unshielded (1.8m).



For AC Adapter

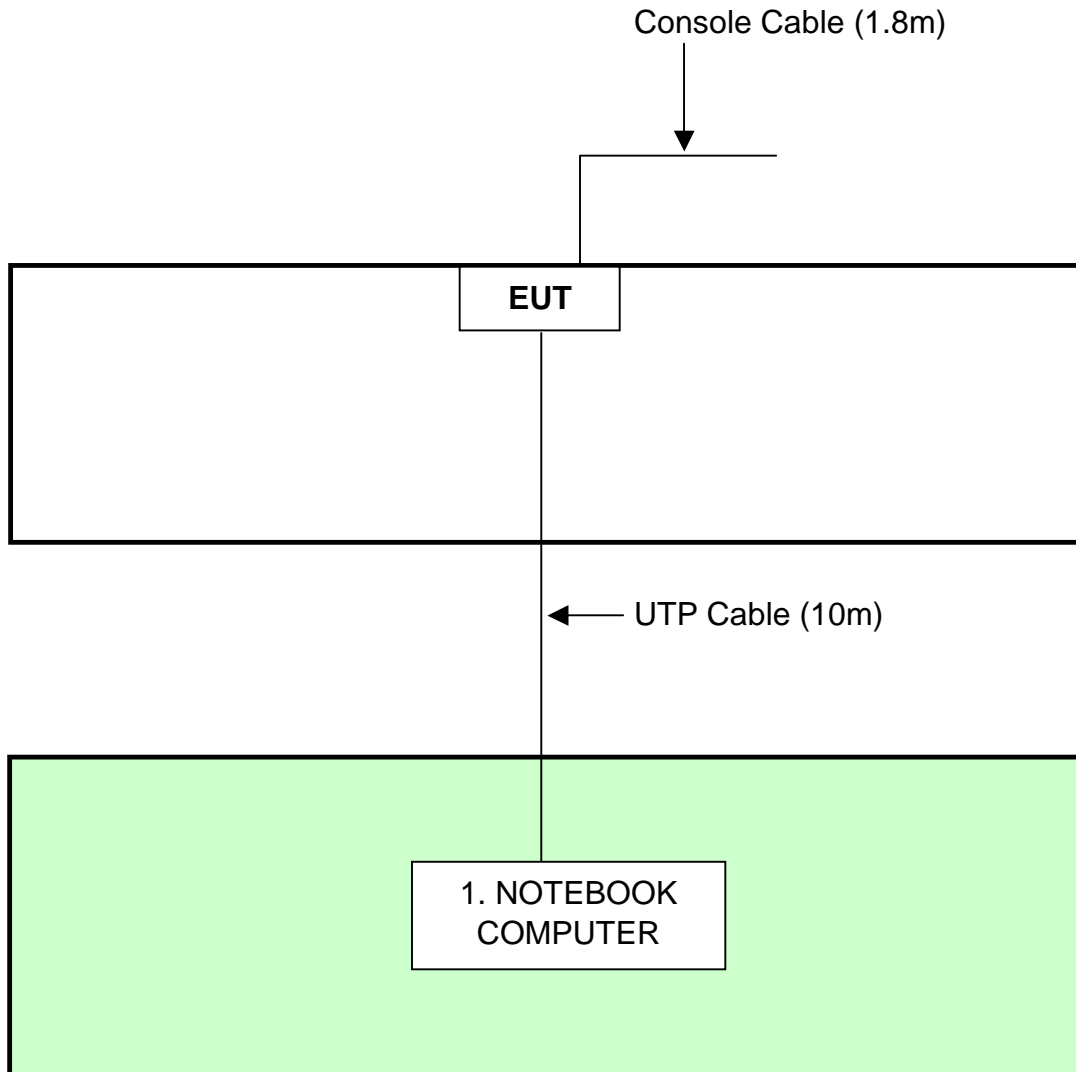

NOTE: 1. Support unit 1 was kept in the control room during the test.



For POE

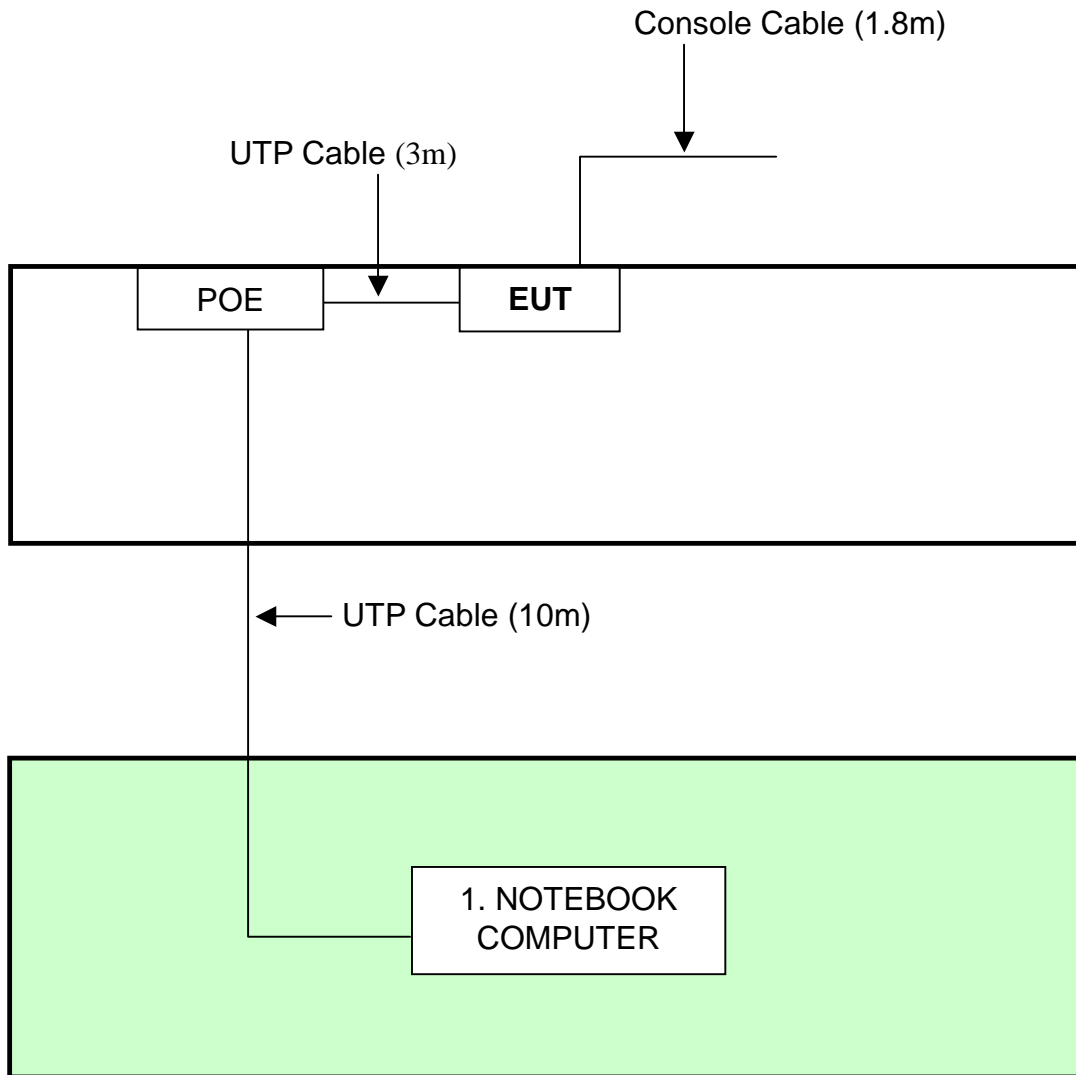

NOTE: 1. Support unit 1 was kept in the control room during the test.



4. TEST TYPES AND RESULTS (FOR PART 802.11b)

4.1 CONDUCTED EMISSION MEASUREMENT

4.1.1 LIMITS OF CONDUCTED EMISSION MEASUREMENT

FREQUENCY (MHz)	Class A (dBuV)		Class B (dBuV)	
	Quasi-peak	Average	Quasi-peak	Average
0.15 - 0.5	79	66	66 - 56	56 - 46
0.50 - 5.0	73	60	56	46
5.0 - 30.0	73	60	60	50

- NOTES:**
- (1) The lower limit shall apply at the transition frequencies.
 - (2) The limit decreases in line with the logarithm of the frequency in the range of 0.15 to 0.50 MHz.
 - (3) All emanations from a class A/B digital device or system, including any network of conductors and apparatus connected thereto, shall not exceed the level of field strengths specified above.

4.1.2 TEST INSTRUMENTS

DESCRIPTION & MANUFACTURER	MODEL NO.	SERIAL NO.	CALIBRATED UNTIL
ROHDE & SCHWARZ Test Receiver	ESCS 30	847124/029	Nov. 17, 2004
ROHDE & SCHWARZ LISN (for EUT)	ESHS-Z5	848773/004	Nov. 13, 2004
KYORITSU LISN (for peripheral)	KNW-407	8/1395/12	Jul. 23, 2004
RF Cable (JETBAO)	RG233/U	Cable_CA_01	Jul. 03, 2004
Terminator(for KYORITSU)	50	3	Apr. 11, 2004
Software	Cond-V2e	NA	NA

- NOTE:**
1. The calibration interval of the above test instruments is 12 months and the calibrations are traceable to NML/ROC and NIST/USA.
 2. The test was performed in ADT Shielded Room No. A.
 3. The VCCI Con A Registration No. is C-817.



4.1.3 TEST PROCEDURES

- a. The EUT was placed 0.4 meters from the conducting wall of the shielded room with EUT being connected to the power mains through a line impedance stabilization network (LISN). Other support units were connected to the power mains through another LISN. The two LISNs provide 50 ohm/ 50uH of coupling impedance for the measuring instrument.
- b. Both lines of the power mains connected to the EUT were checked for maximum conducted interference.
- c. The frequency range from 150 kHz to 30 MHz was searched. Emission levels over 10dB under the prescribed limits could not be reported

4.1.4 DEVIATION FROM TEST STANDARD

No deviation

4.1.5 TEST SETUP

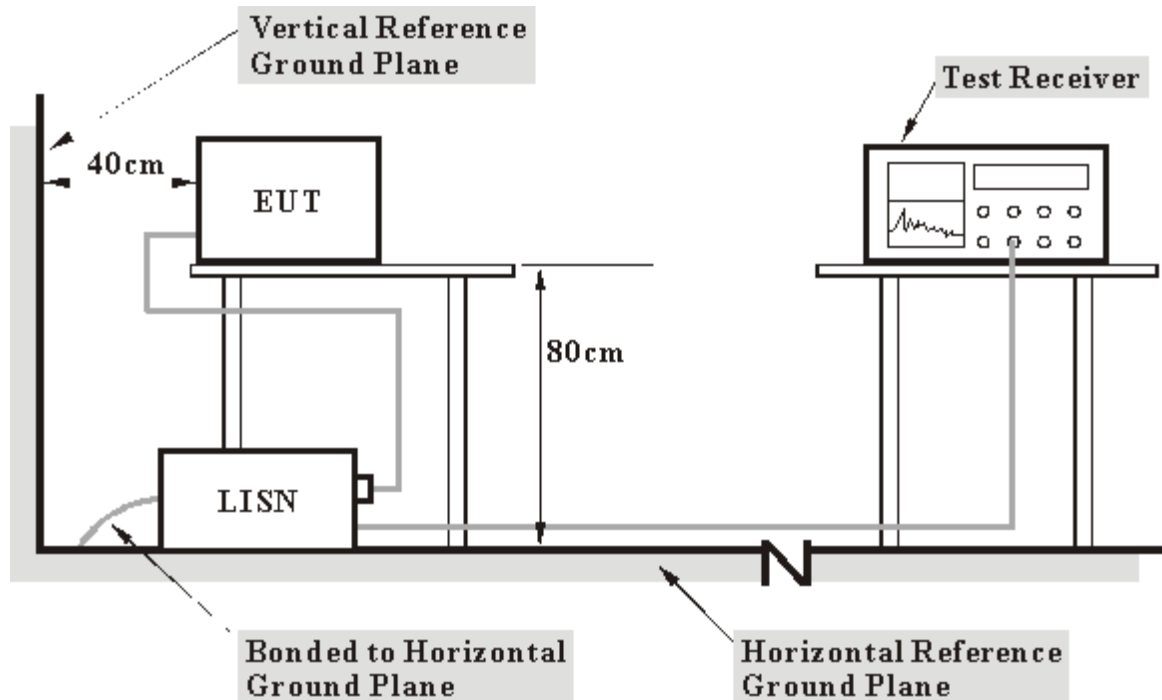

- Note:**
1. Support units were connected to second LISN.
 2. Both of LISNs (AMN) 80 cm from EUT and at the least 80 cm from other units and other metal planes support units.

For the actual test configuration, please refer to the related item – Photographs of the Test Configuration.

4.1.6 EUT OPERATING CONDITIONS

- a. Placed the EUT on the testing table.
- b. Prepared another computer system to act as a communication partner and placed it outside of testing area.
- c. The communication partner run a test program to enable EUT under transmission/receiving condition continuously at specific channel frequency via RJ 45 cable and wireless.
- d. The communication partner sent data to EUT by command "PING".



4.1.7 TEST RESULTS (ADAPTER 1)

EUT	Flanker Pro Single Radio AP		
MODEL	AP-AG-AT-01		
MODE	Channel 11	6dB BANDWIDTH	9 kHz
INPUT POWER (SYSTEM)	120Vac, 60Hz	PHASE	Line (L)
ENVIRONMENTAL CONDITIONS	27deg. C, 69%RH, 972 hPa	TESTED BY	Tony Chen

No	Freq. [MHz]	Corr. Factor (dB)	Reading Value [dB (uV)]		Emission Level [dB (uV)]		Limit [dB (uV)]		Margin (dB)	
			Q.P.	AV.	Q.P.	AV.	Q.P.	AV.	Q.P.	AV.
1	0.166	0.20	47.63	-	47.83	-	65.18	55.18	-17.35	-
2	0.685	0.25	38.40	-	38.65	-	56.00	46.00	-17.35	-
3	1.021	0.30	37.28	-	37.58	-	56.00	46.00	-18.42	-
4	2.322	0.32	40.77	-	41.09	-	56.00	46.00	-14.91	-
5	2.525	0.33	45.78	26.28	46.11	26.61	56.00	46.00	-9.89	-19.39
6	4.668	0.44	38.41	-	38.85	-	56.00	46.00	-17.15	-

- NOTES:** (1) "": Undetectable
 (2) Q.P. and AV. are abbreviations of quasi-peak and average.
 (3) "-": The Quasi-peak reading value also meets an average limit, thus measurement with the average detector is unnecessary.
 (4) The emission levels of other frequencies were very low against the limit.
 (5) Correction Factor = Insertion loss + Cable loss
 (6) Margin value = Emission level - Limit value

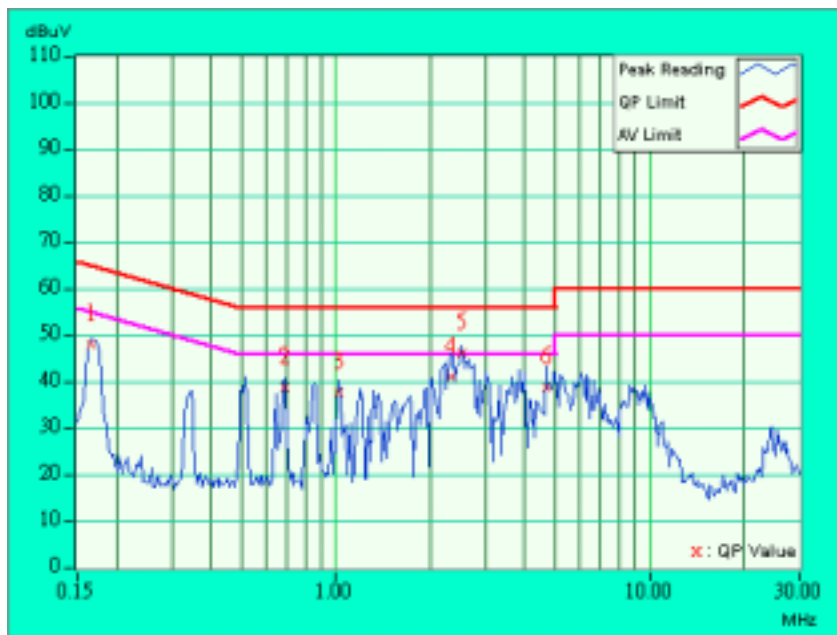



EUT	Flanker Pro Single Radio AP		
MODEL	AP-AG-AT-01		
MODE	Channel 11	6dB BANDWIDTH	9 kHz
INPUT POWER (SYSTEM)	120Vac, 60Hz	PHASE	Neutral (N)
ENVIRONMENTAL CONDITIONS	27deg. C, 69%RH, 972 hPa	TESTED BY	Tony Chen

No	Freq. [MHz]	Corr. Factor (dB)	Reading Value [dB (uV)]		Emission Level [dB (uV)]		Limit [dB (uV)]		Margin (dB)	
			Q.P.	AV.	Q.P.	AV.	Q.P.	AV.	Q.P.	AV.
1	0.166	0.20	48.65	-	48.85	-	65.18	55.18	-16.33	-
2	0.513	0.22	38.42	-	38.64	-	56.00	46.00	-17.36	-
3	2.341	0.32	44.50	-	44.82	-	56.00	46.00	-11.18	-
4	2.541	0.33	46.40	27.32	46.73	27.65	56.00	46.00	-9.27	-18.35
5	3.645	0.38	41.07	-	41.45	-	56.00	46.00	-14.55	-
6	4.934	0.45	37.63	-	38.08	-	56.00	46.00	-17.92	-

- NOTES:** (1) "**": Undetectable
 (2) Q.P. and AV. are abbreviations of quasi-peak and average.
 (3) "-": The Quasi-peak reading value also meets an average limit, thus measurement with the average detector is unnecessary.
 (4) The emission levels of other frequencies were very low against the limit.
 (5) Correction Factor = Insertion loss + Cable loss
 (6) Margin value = Emission level - Limit value

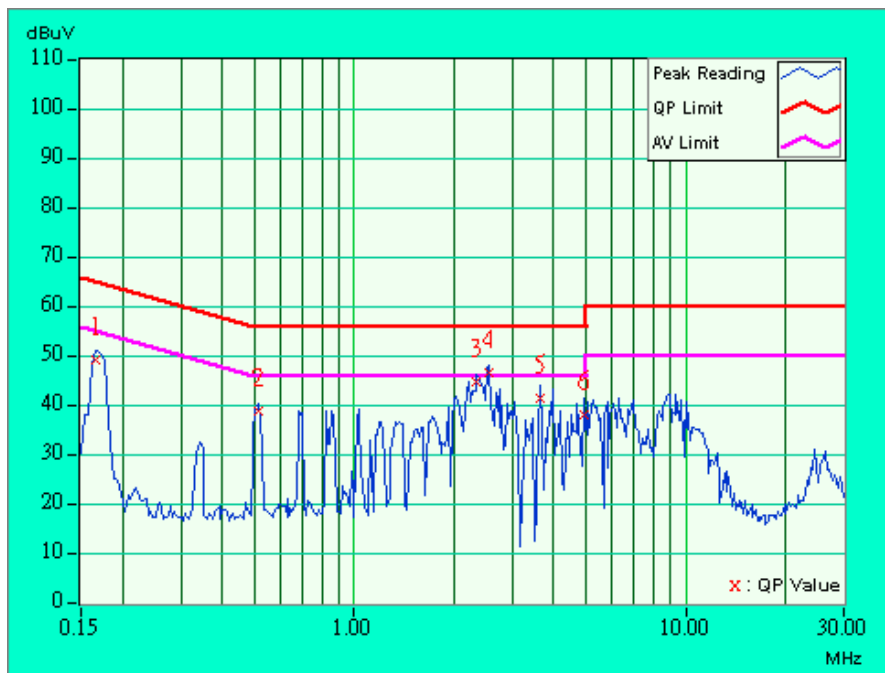



4.1.8 TEST RESULTS (ADAPTER 2)

EUT	Flanker Pro Single Radio AP		
MODEL	AP-AG-AT-01		
MODE	Channel 11	6dB BANDWIDTH	9 kHz
INPUT POWER (SYSTEM)	120Vac, 60Hz	PHASE	Line (L)
ENVIRONMENTAL CONDITIONS	27deg. C, 69%RH, 972 hPa	TESTED BY	Tony Chen

No	Freq. [MHz]	Corr. Factor (dB)	Reading Value [dB (uV)]		Emission Level [dB (uV)]		Limit [dB (uV)]		Margin (dB)	
			Q.P.	AV.	Q.P.	AV.	Q.P.	AV.	Q.P.	AV.
1	0.244	0.20	37.01	-	37.21	-	61.97	51.97	-24.76	-
2	0.373	0.20	36.99	-	37.19	-	58.44	48.44	-21.25	-
3	0.498	0.22	32.45	-	32.67	-	56.04	46.04	-23.37	-
4	0.742	0.26	34.02	-	34.28	-	56.00	46.00	-21.72	-
5	0.869	0.28	34.50	-	34.78	-	56.00	46.00	-21.22	-
6	1.478	0.30	33.84	-	34.14	-	56.00	46.00	-21.86	-

- NOTES:** (1) "-": Undetectable
 (2) Q.P. and AV. are abbreviations of quasi-peak and average.
 (3) "-": The Quasi-peak reading value also meets an average limit, thus measurement with the average detector is unnecessary.
 (4) The emission levels of other frequencies were very low against the limit.
 (5) Correction Factor = Insertion loss + Cable loss
 (6) Margin value = Emission level - Limit value

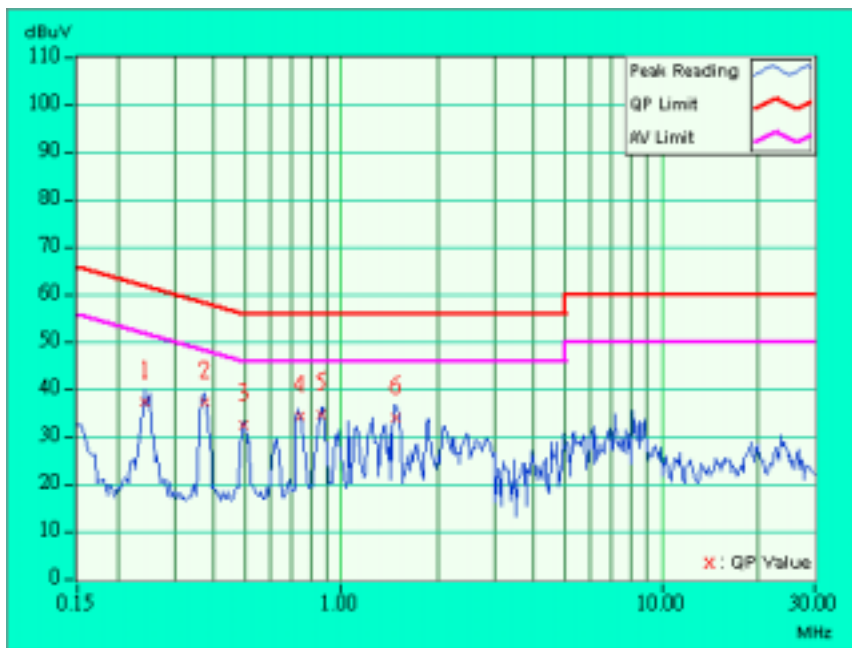



EUT	Flanker Pro Single Radio AP		
MODEL	AP-AG-AT-01		
MODE	Channel 11	6dB BANDWIDTH	9 kHz
INPUT POWER (SYSTEM)	120Vac, 60Hz	PHASE	Neutral (N)
ENVIRONMENTAL CONDITIONS	27deg. C, 69%RH, 972 hPa	TESTED BY	Tony Chen

No	Freq. [MHz]	Corr. Factor (dB)	Reading Value [dB (uV)]		Emission Level [dB (uV)]		Limit [dB (uV)]		Margin (dB)	
			Q.P.	AV.	Q.P.	AV.	Q.P.	AV.	Q.P.	AV.
1	0.244	0.20	41.15	-	41.35	-	61.97	51.97	-20.62	-
2	0.373	0.20	34.27	-	34.47	-	58.44	48.44	-23.97	-
3	0.492	0.22	38.86	-	39.08	-	56.13	46.13	-17.05	-
4	0.744	0.26	32.35	-	32.61	-	56.00	46.00	-23.39	-
5	1.111	0.30	35.00	-	35.30	-	56.00	46.00	-20.70	-
6	6.730	0.54	26.41	-	26.95	-	60.00	50.00	-33.05	-

- NOTES:** (1) "**": Undetectable
 (2) Q.P. and AV. are abbreviations of quasi-peak and average.
 (3) "-": The Quasi-peak reading value also meets an average limit, thus measurement with the average detector is unnecessary.
 (4) The emission levels of other frequencies were very low against the limit.
 (5) Correction Factor = Insertion loss + Cable loss
 (6) Margin value = Emission level - Limit value

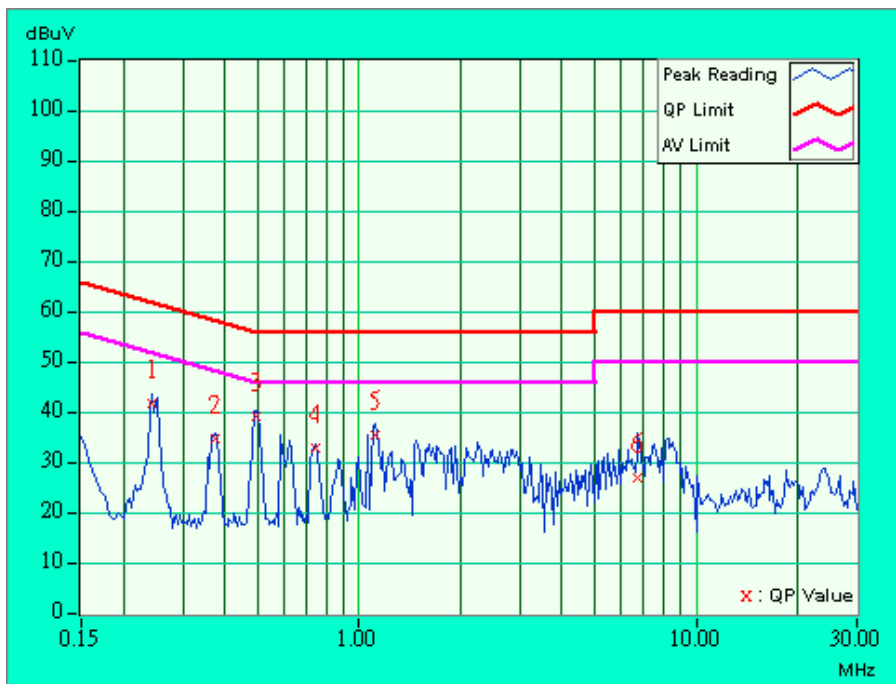



4.1.9 TEST RESULTS (POE)

EUT	Flanker Pro Single Radio AP		
MODEL	AP-AG-AT-01		
MODE	Channel 11	6dB BANDWIDTH	9 kHz
INPUT POWER (SYSTEM)	120Vac, 60Hz	PHASE	Line (L)
ENVIRONMENTAL CONDITIONS	27deg. C, 69%RH, 972 hPa	TESTED BY	Tony Chen

No	Freq. [MHz]	Corr. Factor (dB)	Reading Value [dB (uV)]		Emission Level [dB (uV)]		Limit [dB (uV)]		Margin (dB)	
			Q.P.	AV.	Q.P.	AV.	Q.P.	AV.	Q.P.	AV.
1	0.150	0.20	51.23	-	51.43	-	66.00	56.00	-14.57	-
2	0.185	0.20	44.98	-	45.18	-	64.25	54.25	-19.07	-
3	0.224	0.20	47.63	-	47.83	-	62.66	52.66	-14.83	-
4	0.259	0.20	43.91	-	44.11	-	61.45	51.45	-17.34	-
5	0.298	0.20	39.71	-	39.91	-	60.29	50.29	-20.38	-
6	14.425	1.07	40.81	-	41.88	-	60.00	50.00	-18.12	-

- NOTES:** (1) "-": Undetectable
 (2) Q.P. and AV. are abbreviations of quasi-peak and average.
 (3) "-": The Quasi-peak reading value also meets an average limit, thus measurement with the average detector is unnecessary.
 (4) The emission levels of other frequencies were very low against the limit.
 (5) Correction Factor = Insertion loss + Cable loss
 (6) Margin value = Emission level - Limit value

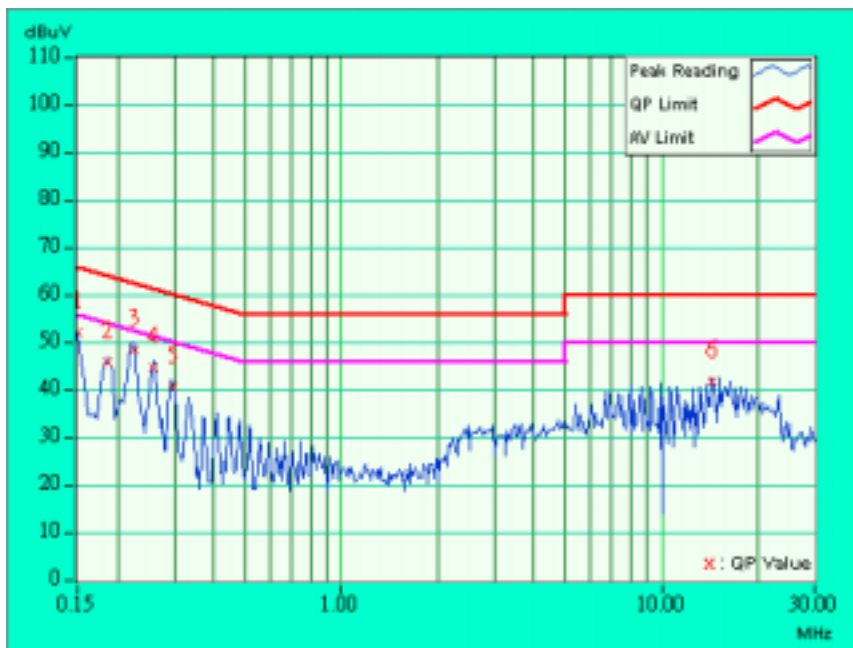



EUT	Flanker Pro Single Radio AP		
MODEL	AP-AG-AT-01		
MODE	Channel 11	6dB BANDWIDTH	9 kHz
INPUT POWER (SYSTEM)	120Vac, 60Hz	PHASE	Neutral (N)
ENVIRONMENTAL CONDITIONS	27deg. C, 69%RH, 972 hPa	TESTED BY	Tony Chen

No	Freq. [MHz]	Corr. Factor (dB)	Reading Value [dB (uV)]		Emission Level [dB (uV)]		Limit [dB (uV)]		Margin (dB)	
			Q.P.	AV.	Q.P.	AV.	Q.P.	AV.	Q.P.	AV.
1	0.150	0.20	51.37	-	51.57	-	66.00	56.00	-14.43	-
2	0.189	0.20	43.65	-	43.85	-	64.08	54.08	-20.23	-
3	0.224	0.20	48.42	-	48.62	-	62.66	52.66	-14.04	-
4	0.255	0.20	41.18	-	41.38	-	61.58	51.58	-20.20	-
5	0.295	0.20	40.55	-	40.75	-	60.40	50.40	-19.65	-
6	15.723	1.00	41.35	-	42.35	-	60.00	50.00	-17.65	-

- NOTES:** (1) "**": Undetectable
 (2) Q.P. and AV. are abbreviations of quasi-peak and average.
 (3) "-": The Quasi-peak reading value also meets an average limit, thus measurement with the average detector is unnecessary.
 (4) The emission levels of other frequencies were very low against the limit.
 (5) Correction Factor = Insertion loss + Cable loss
 (6) Margin value = Emission level - Limit value

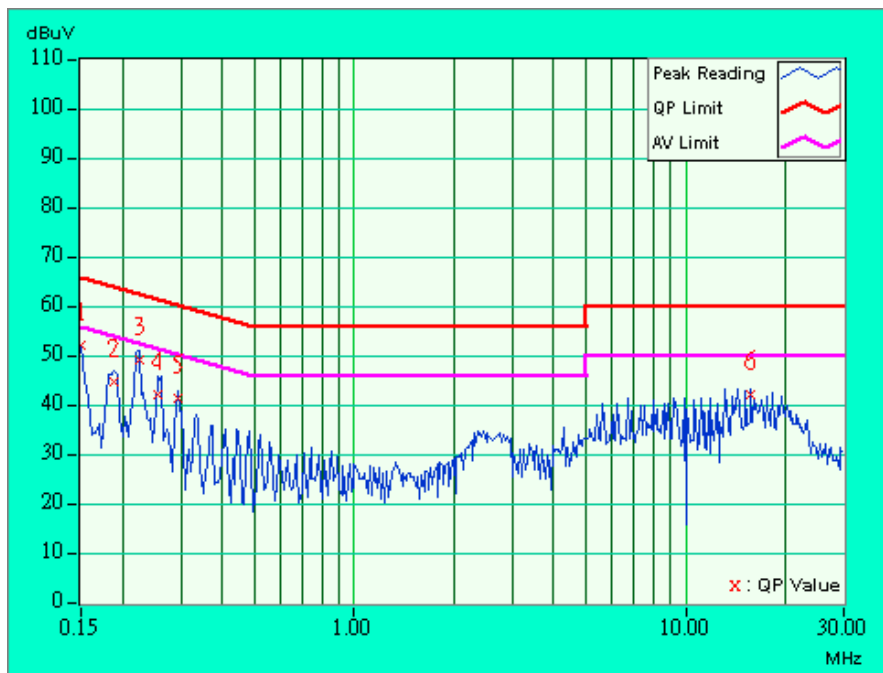



4.2 RADIATED EMISSION MEASUREMENT

4.2.1 LIMITS OF RADIATED EMISSION MEASUREMENT

Emissions radiated outside of the specified bands, shall be according to the general radiated limits in 15.209 as following:

Frequencies (MHz)	Field strength (microvolts/meter)	Measurement distance (meters)
0.009-0.490	2400/F(kHz)	300
0.490-1.705	24000/F(kHz)	30
1.705-30.0	30	30
30-88	100	3
88-216	150	3
216-960	200	3
Above 960	500	3

NOTE:

1. The lower limit shall apply at the transition frequencies.
2. Emission level (dBuV/m) = 20 log Emission level (uV/m).
3. As shown in 15.35(b), for frequencies above 1000MHz, the field strength limits are based on average detector, however, the peak field strength of any emission shall not exceed the maximum permitted average limits, specified above by more than 20dB under any condition of modulation.



4.2.2 TEST INSTRUMENTS

DESCRIPTION & MANUFACTURER	MODEL NO.	SERIAL NO.	CALIBRATED UNTIL
HP Spectrum Analyzer	8594ER	3829U04676	Jul. 14, 2004
ADVANTEST Spectrum Analyzer	R3271A	85060311	May 21, 2004
CHASE RF Pre_Amplifier	CPA9232	1057	Apr. 24, 2004
HP Pre_Amplifier	8449B	3008A01281	June 27, 2004
ROHDE & SCHWARZ Test Receiver	ESVS 10	849231 /019	Nov. 03, 2004
CHASE Broadband Antenna	CBL6111c	2730	Jul 17, 2004
Schwarzbeck Horn_Antenna	3115	5619	Jul. 17, 2004
SCHWARZBECK Tunable Dipole Antenna	UHAP	897	Mar. 07, 2005
SCHWARZBECK Tunable Dipole Antenna	VHAP	880	Mar. 07, 2005
RF Switches (ARNITSU)	CS-201	1565157	Dec. 01, 2004
RF CABLE (Chaintek) 1GHz-20GHz	SF102	22054-2	Feb. 10. 2004
RF Cable(RICHTEC)	9913-30M	STCCAB-30M-1GH z-021	Nov. 5, 2004
Software	AS60P8	NA	NA
CHANCE MOST Antenna Tower	AT-100	0203	NA
CHANCE MOST Turn Table	TT-100	0203	NA

Note: 1. The calibration interval of the above test instruments is 12 months (36 months for Tunable Dipole Antenna) and the calibrations are traceable to NML/ROC and NIST/USA.

2. * = These equipment are used for the final measurement.
3. The horn antenna and HP preamplifier (model: 8449B) are used only for the measurement of emission frequency above 1GHz if tested.
4. The test was performed in ADT Open Site No. C.
5. The FCC Site Registration No. is 656396.
6. The VCCI Site Registration No. is R-1626.
7. The CANADA Site Registration No. is IC 3789-C.



4.2.3 TEST PROCEDURES

- a. The EUT was placed on the top of a rotating table 0.8 meters above the ground at a 10 meter open area test site. The table was rotated 360 degrees to determine the position of the highest radiation.
- b. The EUT was set 3 meters away from the interference-receiving antenna, which was mounted on the top of a variable-height antenna tower.
- c. The antenna is a broadband antenna, and its height is varied from one meter to four meters above the ground to determine the maximum value of the field strength. Both horizontal and vertical polarizations of the antenna are set to make the measurement.
- d. For each suspected emission, the EUT was arranged to its worst case and then the antenna was tuned to heights from 1 meter to 4 meters and the rotatable table was turned from 0 degrees to 360 degrees to find the maximum reading.
- e. The test-receiver system was set to Peak Detect Function and Specified Bandwidth with Maximum Hold Mode.
- f. If the emission level of the EUT in peak mode was 10 dB lower than the limit specified, then testing could be stopped and the peak values of the EUT would be reported. Otherwise the emissions that did not have 10 dB margin would be re-tested one by one using the quasi-peak method or average method as specified and then reported in Data sheet peak mode and QP mode.

NOTE:

1. The resolution bandwidth and video bandwidth of test receiver/spectrum analyzer is 120kHz for Quasi-peak detection at frequency below 1GHz.
2. The resolution bandwidth and video bandwidth of test receiver/spectrum analyzer is 1 MHz for Peak detection (PK) at frequency above 1GHz.
3. The resolution bandwidth of test receiver/spectrum analyzer is 1 MHz and the video bandwidth is 300 Hz for Average detection (AV) at frequency above 1GHz.

4.2.4 DEVIATION FROM TEST STANDARD

No deviation

4.2.5 TEST SETUP

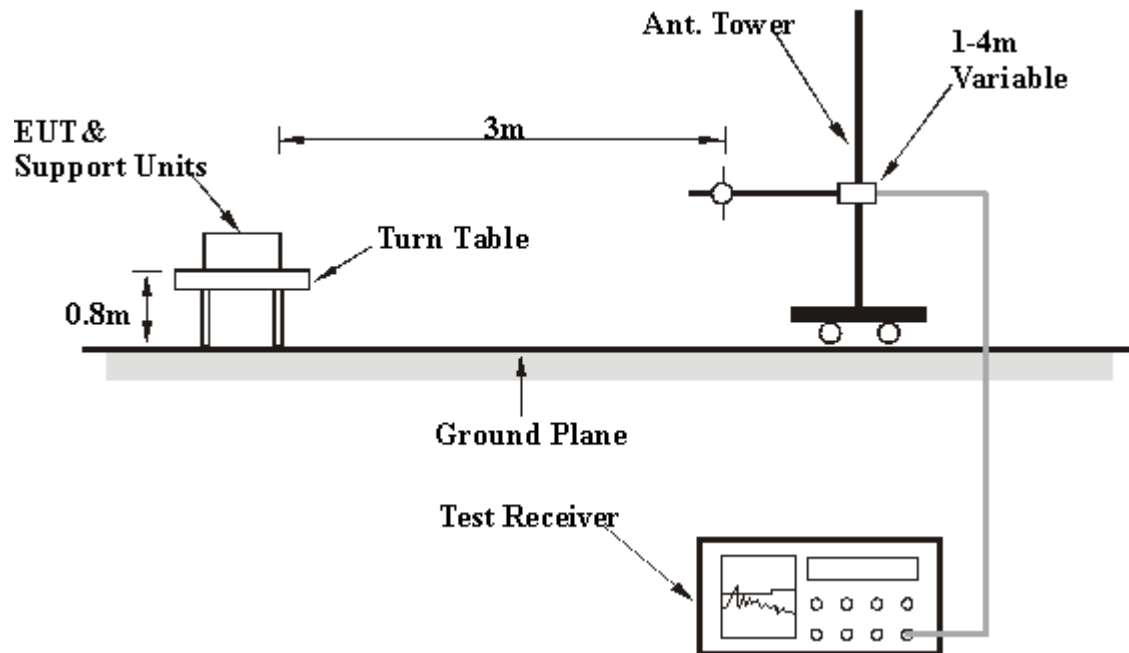

For the actual test configuration, please refer to the related item – Photographs of the Test Configuration.

4.2.6 EUT OPERATING CONDITIONS

Same as 4.1.6



4.2.7 TEST RESULTS

EUT	Flanker Pro Single Radio AP	MODEL	AP-AG-AT-01
MODE	Channel 11 (Antenna 1-Adapter 1)	FREQUENCY RANGE	Below 1000 MHz
INPUT POWER (SYSTEM)	120Vac, 60Hz	DETECTOR FUNCTION	Quasi-Peak
ENVIRONMENTAL CONDITIONS	29deg. C, 56%RH, 972 hPa	TESTED BY	Eric Lee

ANTENNA POLARITY & TEST DISTANCE: HORIZONTAL AT 3 M

No.	Freq. (MHz)	Emission Level (dBuV/m)	Limit (dBuV/m)	Margin (dB)	Antenna Height (m)	Table Angle (Degree)	Raw Value (dBuV)	Correction Factor (dB/m)
1	121.00	25.90 QP	43.50	-17.60	1.54 H	26	13.20	12.70
2	125.02	29.30 QP	43.50	-14.20	1.54 H	24	16.20	13.10
3	200.05	26.30 QP	43.50	-17.20	1.59 H	6	16.20	10.10
4	250.03	29.60 QP	46.00	-16.40	1.87 H	54	15.20	14.40
5	300.09	30.10 QP	46.00	-15.90	1.02 H	30	14.70	15.40
6	330.21	32.10 QP	46.00	-13.90	1.80 H	69	15.80	16.30
7	375.24	29.80 QP	46.00	-16.20	1.50 H	289	12.00	17.80
8	399.98	30.70 QP	46.00	-15.30	1.00 H	26	12.00	18.70
9	500.00	34.20 QP	46.00	-11.80	1.47 H	58	12.60	21.60
10	750.29	41.40 QP	46.00	-4.60	1.78 H	69	15.20	26.10

ANTENNA POLARITY & TEST DISTANCE: VERTICAL AT 3 M

No.	Freq. (MHz)	Emission Level (dBuV/m)	Limit (dBuV/m)	Margin (dB)	Antenna Height (m)	Table Angle (Degree)	Raw Value (dBuV)	Correction Factor (dB/m)
1	48.23	25.20 QP	40.00	-14.80	1.02 V	32	15.20	10.00
2	120.00	28.60 QP	43.50	-14.90	1.10 V	20	16.00	12.60
3	125.08	27.30 QP	43.50	-16.20	1.02 V	52	14.20	13.10
4	200.00	27.40 QP	43.50	-16.10	1.69 V	9	17.30	10.10
5	250.01	32.30 QP	46.00	-13.70	1.02 V	5	17.90	14.40
6	330.90	33.20 QP	46.00	-12.80	1.15 V	47	16.90	16.30
7	375.24	28.80 QP	46.00	-17.20	1.11 V	24	11.00	17.80
8	399.99	31.20 QP	46.00	-14.80	1.36 V	9	12.60	18.70
9	500.00	31.30 QP	46.00	-14.70	1.47 V	56	9.60	21.60
10	750.03	38.40 QP	46.00	-7.60	1.54 V	24	12.30	26.10

- REMARKS:**
1. Emission level(dBuV/m)=Raw Value(dBuV) + Correction Factor(dB)
 2. Correction Factor(dB/m) = Antenna Factor (dB/m) + Cable Factor (dB)
 3. The other emission levels were very low against the limit.
 4. Margin value = Emission level – Limit value.



EUT	Flanker Pro Single Radio AP	MODEL	AP-AG-AT-01
MODE	Channel 11 (Antenna 1-Adapter 2)	FREQUENCY RANGE	Below 1000 MHz
INPUT POWER (SYSTEM)	120Vac, 60Hz	DETECTOR FUNCTION	Quasi-Peak
ENVIRONMENTAL CONDITIONS	29deg. C, 56%RH, 972 hPa	TESTED BY	Eric Lee

ANTENNA POLARITY & TEST DISTANCE: HORIZONTAL AT 3 M

No.	Freq. (MHz)	Emission Level (dBuV/m)	Limit (dBuV/m)	Margin (dB)	Antenna Height (m)	Table Angle (Degree)	Raw Value (dBuV)	Correction Factor (dB/m)
1	120.00	27.80 QP	43.50	-15.70	1.33 H	336	15.20	12.60
2	125.03	29.20 QP	43.50	-14.30	1.85 H	297	16.10	13.10
3	199.99	27.30 QP	43.50	-16.20	1.54 H	7	17.20	10.10
4	250.02	30.60 QP	46.00	-15.40	1.54 H	26	16.20	14.40
5	300.00	29.60 QP	46.00	-16.40	1.02 H	35	14.20	15.40
6	330.09	32.30 QP	46.00	-13.70	1.66 H	3	16.00	16.30
7	375.20	29.80 QP	46.00	-16.20	1.45 H	246	12.00	17.80
8	400.11	31.90 QP	46.00	-14.10	1.59 H	357	13.30	18.70
9	500.02	32.60 QP	46.00	-13.40	1.01 H	63	11.00	21.60
10	750.00	40.40 QP	46.00	-5.60	1.01 H	75	14.20	26.10

ANTENNA POLARITY & TEST DISTANCE: VERTICAL AT 3 M

No.	Freq. (MHz)	Emission Level (dBuV/m)	Limit (dBuV/m)	Margin (dB)	Antenna Height (m)	Table Angle (Degree)	Raw Value (dBuV)	Correction Factor (dB/m)
1	48.65	24.10 QP	40.00	-15.90	1.10 V	132	14.30	9.80
2	120.09	28.50 QP	43.50	-15.00	1.17 V	87	15.90	12.60
3	125.21	28.40 QP	43.50	-15.10	1.02 V	36	15.40	13.00
4	200.00	27.90 QP	43.50	-15.60	1.47 V	54	17.80	10.10
5	250.03	30.90 QP	46.00	-15.10	1.54 V	246	16.50	14.40
6	330.30	32.20 QP	46.00	-13.80	1.65 V	326	15.90	16.30
7	375.24	28.90 QP	46.00	-17.10	1.15 V	9	11.10	17.80
8	400.01	29.60 QP	46.00	-16.40	1.01 V	47	10.90	18.70
9	500.00	31.90 QP	46.00	-14.10	1.69 V	356	10.20	21.60
10	750.02	39.40 QP	46.00	-6.60	1.58 V	258	13.20	26.10

- REMARKS:**
1. Emission level(dBuV/m)=Raw Value(dBuV) + Correction Factor(dB)
 2. Correction Factor(dB/m) = Antenna Factor (dB/m) + Cable Factor (dB)
 3. The other emission levels were very low against the limit.
 4. Margin value = Emission level – Limit value.



EUT	Flanker Pro Single Radio AP	MODEL	AP-AG-AT-01
MODE	Channel 11 (Antenna 1-POE)	FREQUENCY RANGE	Below 1000 MHz
INPUT POWER (SYSTEM)	120Vac, 60Hz	DETECTOR FUNCTION	Quasi-Peak
ENVIRONMENTAL CONDITIONS	29deg. C, 56%RH, 972 hPa	TESTED BY	Eric Lee

ANTENNA POLARITY & TEST DISTANCE: HORIZONTAL AT 3 M

No.	Freq. (MHz)	Emission Level (dBuV/m)	Limit (dBuV/m)	Margin (dB)	Antenna Height (m)	Table Angle (Degree)	Raw Value (dBuV)	Correction Factor (dB/m)
1	120.02	27.50 QP	43.50	-16.00	1.85 H	246	14.90	12.60
2	125.34	28.80 QP	43.50	-14.70	1.88 H	9	15.80	13.00
3	200.00	27.30 QP	43.50	-16.20	1.02 H	250	17.20	10.10
4	250.26	31.30 QP	46.00	-14.70	1.85 H	52	16.90	14.40
5	300.10	28.90 QP	46.00	-17.10	1.47 H	5	13.50	15.40
6	330.01	31.50 QP	46.00	-14.50	1.63 H	332	15.20	16.30
7	375.24	30.60 QP	46.00	-15.40	1.40 H	205	12.80	17.80
8	400.00	32.20 QP	46.00	-13.80	1.32 H	320	13.60	18.70
9	499.99	33.70 QP	46.00	-12.30	1.45 H	62	12.10	21.60
10	749.69	41.40 QP	46.00	-4.60	1.02 H	36	15.20	26.10

ANTENNA POLARITY & TEST DISTANCE: VERTICAL AT 3 M

No.	Freq. (MHz)	Emission Level (dBuV/m)	Limit (dBuV/m)	Margin (dB)	Antenna Height (m)	Table Angle (Degree)	Raw Value (dBuV)	Correction Factor (dB/m)
1	49.60	24.50 QP	40.00	-15.50	1.40 V	2	15.20	9.30
2	120.05	28.30 QP	43.50	-15.20	1.32 V	300	15.70	12.60
3	125.00	27.60 QP	43.50	-15.90	1.63 V	17	14.50	13.10
4	200.00	26.40 QP	43.50	-17.10	1.45 V	21	16.30	10.10
5	250.02	32.60 QP	46.00	-13.40	1.54 V	256	18.20	14.40
6	330.10	33.80 QP	46.00	-12.20	1.45 V	62	17.50	16.30
7	375.00	27.70 QP	46.00	-18.30	1.52 V	256	9.90	17.80
8	400.04	31.40 QP	46.00	-14.60	1.58 V	98	12.70	18.70
9	500.01	31.80 QP	46.00	-14.20	1.54 V	245	10.20	21.60
10	749.98	38.70 QP	46.00	-7.30	1.32 V	65	12.60	26.10

- REMARKS:**
1. Emission level(dBuV/m)=Raw Value(dBuV) + Correction Factor(dB)
 2. Correction Factor(dB/m) = Antenna Factor (dB/m) + Cable Factor (dB)
 3. The other emission levels were very low against the limit.
 4. Margin value = Emission level – Limit value.



EUT	Flanker Pro Single Radio AP	MODEL	AP-AG-AT-01
MODE	Channel 11 (Antenna 2-Adapter 1)	FREQUENCY RANGE	Below 1000 MHz
INPUT POWER (SYSTEM)	120Vac, 60Hz	DETECTOR FUNCTION	Quasi-Peak
ENVIRONMENTAL CONDITIONS	29deg. C, 56%RH, 972 hPa	TESTED BY	Eric Lee

ANTENNA POLARITY & TEST DISTANCE: HORIZONTAL AT 3 M

No.	Freq. (MHz)	Emission Level (dBuV/m)	Limit (dBuV/m)	Margin (dB)	Antenna Height (m)	Table Angle (Degree)	Raw Value (dBuV)	Correction Factor (dB/m)
1	121.54	26.90 QP	43.50	-16.60	1.02 H	356	14.20	12.70
2	125.00	29.80 QP	43.50	-13.80	2.02 H	32	16.70	13.10
3	200.75	27.00 QP	43.50	-16.50	1.42 H	305	17.00	10.00
4	250.06	30.70 QP	46.00	-15.30	1.11 H	253	16.30	14.40
5	300.22	28.60 QP	46.00	-17.40	1.65 H	212	13.20	15.40
6	330.30	32.00 QP	46.00	-14.00	1.63 H	333	15.70	16.30
7	376.00	29.50 QP	46.00	-16.50	1.02 H	326	11.70	17.80
8	401.00	31.70 QP	46.00	-14.30	1.44 H	222	13.00	18.70
9	500.00	33.60 QP	46.00	-12.40	1.87 H	96	12.00	21.60
10	750.21	41.80 QP	46.00	-4.20	1.47 H	54	15.70	26.10

ANTENNA POLARITY & TEST DISTANCE: VERTICAL AT 3 M

No.	Freq. (MHz)	Emission Level (dBuV/m)	Limit (dBuV/m)	Margin (dB)	Antenna Height (m)	Table Angle (Degree)	Raw Value (dBuV)	Correction Factor (dB/m)
1	54.26	21.80 QP	40.00	-18.20	1.02 V	41	14.30	7.60
2	120.22	27.80 QP	43.50	-15.70	1.47 V	212	15.20	12.60
3	125.24	28.90 QP	43.50	-14.60	1.00 V	326	15.80	13.00
4	200.71	23.30 QP	43.50	-20.20	1.19 V	58	13.20	10.00
5	250.05	31.00 QP	46.00	-15.00	1.59 V	357	16.60	14.40
6	330.30	31.50 QP	46.00	-14.50	1.11 V	9	15.20	16.30
7	375.41	29.80 QP	46.00	-16.20	1.85 V	245	12.00	17.80
8	400.00	30.10 QP	46.00	-15.90	1.54 V	42	11.40	18.70
9	499.91	31.90 QP	46.00	-14.10	1.46 V	21	10.20	21.60
10	749.96	37.10 QP	46.00	-8.90	1.42 V	30	11.00	26.10

- REMARKS:**
1. Emission level(dBuV/m)=Raw Value(dBuV) + Correction Factor(dB)
 2. Correction Factor(dB/m) = Antenna Factor (dB/m) + Cable Factor (dB)
 3. The other emission levels were very low against the limit.
 4. Margin value = Emission level – Limit value.



EUT	Flanker Pro Single Radio AP	MODEL	AP-AG-AT-01
MODE	Channel 11 (Antenna 2-Adapter 2)	FREQUENCY RANGE	Below 1000 MHz
INPUT POWER (SYSTEM)	120Vac, 60Hz	DETECTOR FUNCTION	Quasi-Peak
ENVIRONMENTAL CONDITIONS	29deg. C, 56%RH, 972 hPa	TESTED BY	Eric Lee

ANTENNA POLARITY & TEST DISTANCE: HORIZONTAL AT 3 M

No.	Freq. (MHz)	Emission Level (dBuV/m)	Limit (dBuV/m)	Margin (dB)	Antenna Height (m)	Table Angle (Degree)	Raw Value (dBuV)	Correction Factor (dB/m)
1	120.01	27.80 QP	43.50	-15.70	1.47 H	205	15.20	12.60
2	125.25	28.80 QP	43.50	-14.70	1.11 H	4	15.80	13.00
3	200.75	27.00 QP	43.50	-16.50	1.42 H	305	17.00	10.00
4	250.01	31.40 QP	46.00	-14.60	1.55 H	153	17.00	14.40
5	300.22	28.60 QP	46.00	-17.40	1.65 H	212	13.20	15.40
6	331.00	33.90 QP	46.00	-12.10	1.24 H	5	17.50	16.30
7	375.23	30.80 QP	46.00	-15.20	1.00 H	22	13.00	17.80
8	400.00	30.80 QP	46.00	-15.20	1.10 H	2	12.10	18.70
9	501.23	31.90 QP	46.00	-14.10	1.87 H	54	10.30	21.60
10	750.21	40.00 QP	46.00	-6.00	1.02 H	35	13.90	26.10

ANTENNA POLARITY & TEST DISTANCE: VERTICAL AT 3 M

No.	Freq. (MHz)	Emission Level (dBuV/m)	Limit (dBuV/m)	Margin (dB)	Antenna Height (m)	Table Angle (Degree)	Raw Value (dBuV)	Correction Factor (dB/m)
1	53.69	20.60 QP	40.00	-19.40	1.54 V	214	12.90	7.70
2	119.00	26.30 QP	43.50	-17.20	1.00 V	218	13.80	12.50
3	125.00	29.60 QP	43.50	-13.90	1.77 V	347	16.60	13.10
4	200.54	21.20 QP	43.50	-22.20	1.02 V	256	11.20	10.00
5	249.99	32.60 QP	46.00	-13.40	1.65 V	325	18.20	14.40
6	331.00	32.00 QP	46.00	-14.00	1.11 V	259	15.70	16.30
7	375.41	31.00 QP	46.00	-15.00	1.85 V	2	13.20	17.80
8	400.00	30.10 QP	46.00	-15.90	1.54 V	42	11.40	18.70
9	499.91	30.70 QP	46.00	-15.30	1.46 V	354	9.10	21.60
10	750.01	36.10 QP	46.00	-9.90	1.10 V	24	10.00	26.10

- REMARKS:**
1. Emission level(dBuV/m)=Raw Value(dBuV) + Correction Factor(dB)
 2. Correction Factor(dB/m) = Antenna Factor (dB/m) + Cable Factor (dB)
 3. The other emission levels were very low against the limit.
 4. Margin value = Emission level – Limit value.



EUT	Flanker Pro Single Radio AP	MODEL	AP-AG-AT-01
MODE	Channel 11 (Antenna 2-POE)	FREQUENCY RANGE	Below 1000 MHz
INPUT POWER (SYSTEM)	120Vac, 60Hz	DETECTOR FUNCTION	Quasi-Peak
ENVIRONMENTAL CONDITIONS	29deg. C, 56%RH, 972 hPa	TESTED BY	Eric Lee

ANTENNA POLARITY & TEST DISTANCE: HORIZONTAL AT 3 M

No.	Freq. (MHz)	Emission Level (dBuV/m)	Limit (dBuV/m)	Margin (dB)	Antenna Height (m)	Table Angle (Degree)	Raw Value (dBuV)	Correction Factor (dB/m)
1	119.76	25.80 QP	43.50	-17.70	1.45 H	24	13.20	12.60
2	125.24	28.80 QP	43.50	-14.70	1.11 H	4	15.80	13.00
3	200.68	27.00 QP	43.50	-16.50	1.42 H	305	17.00	10.00
4	249.99	31.40 QP	46.00	-14.60	1.55 H	153	17.00	14.40
5	300.10	29.30 QP	46.00	-16.70	1.68 H	312	13.90	15.40
6	330.21	32.50 QP	46.00	-13.50	1.24 H	5	16.20	16.30
7	375.00	30.80 QP	46.00	-15.20	2.00 H	356	13.00	17.80
8	400.36	30.80 QP	46.00	-15.20	1.10 H	2	12.10	18.70
9	500.36	33.00 QP	46.00	-13.00	1.69 H	68	11.30	21.60
10	749.11	38.70 QP	46.00	-7.30	1.20 H	54	12.50	26.10

ANTENNA POLARITY & TEST DISTANCE: VERTICAL AT 3 M

No.	Freq. (MHz)	Emission Level (dBuV/m)	Limit (dBuV/m)	Margin (dB)	Antenna Height (m)	Table Angle (Degree)	Raw Value (dBuV)	Correction Factor (dB/m)
1	42.00	23.20 QP	40.00	-16.80	1.11 V	360	10.00	13.30
2	120.20	28.00 QP	43.50	-15.50	1.07 V	360	15.40	12.60
3	125.07	28.80 QP	43.50	-14.70	1.58 V	65	15.70	13.10
4	200.14	23.50 QP	43.50	-20.00	4.00 V	94	13.50	10.10
5	249.99	32.60 QP	46.00	-13.40	1.65 V	325	18.20	14.40
6	330.10	34.30 QP	46.00	-11.70	1.65 V	356	18.00	16.30
7	375.00	32.60 QP	46.00	-13.40	1.67 V	63	14.80	17.80
8	399.99	29.60 QP	46.00	-16.40	1.12 V	222	10.90	18.70
9	499.91	30.70 QP	46.00	-15.30	1.46 V	354	9.10	21.60
10	749.93	35.20 QP	46.00	-10.80	1.80 V	341	9.10	26.10

- REMARKS:**
1. Emission level(dBuV/m)=Raw Value(dBuV) + Correction Factor(dB)
 2. Correction Factor(dB/m) = Antenna Factor (dB/m) + Cable Factor (dB)
 3. The other emission levels were very low against the limit.
 4. Margin value = Emission level – Limit value.



EUT	Flanker Pro Single Radio AP	MODEL	AP-AG-AT-01
MODE	Channel 11 (Antenna 3-Adapter 1)	FREQUENCY RANGE	Below 1000 MHz
INPUT POWER (SYSTEM)	120Vac, 60Hz	DETECTOR FUNCTION	Quasi-Peak
ENVIRONMENTAL CONDITIONS	29deg. C, 56%RH, 972 hPa	TESTED BY	Eric Lee

ANTENNA POLARITY & TEST DISTANCE: HORIZONTAL AT 3 M

No.	Freq. (MHz)	Emission Level (dBuV/m)	Limit (dBuV/m)	Margin (dB)	Antenna Height (m)	Table Angle (Degree)	Raw Value (dBuV)	Correction Factor (dB/m)
1	121.02	27.90 QP	43.50	-15.60	1.54 H	24	15.20	12.70
2	125.03	29.30 QP	43.50	-14.20	1.52 H	258	16.20	13.10
3	200.10	27.10 QP	43.50	-16.40	1.47 H	54	17.00	10.10
4	250.20	31.30 QP	46.00	-14.70	1.87 H	200	16.90	14.40
5	300.71	29.70 QP	46.00	-16.30	1.56 H	325	14.30	15.40
6	330.26	31.50 QP	46.00	-14.50	1.00 H	220	15.20	16.30
7	375.83	29.40 QP	46.00	-16.60	1.82 H	209	11.60	17.80
8	400.00	32.20 QP	46.00	-13.80	1.63 H	36	13.60	18.70
9	500.00	33.20 QP	46.00	-12.80	1.54 H	26	11.60	21.60
10	750.03	42.40 QP	46.00	-3.60	1.44 H	230	16.20	26.10

ANTENNA POLARITY & TEST DISTANCE: VERTICAL AT 3 M

No.	Freq. (MHz)	Emission Level (dBuV/m)	Limit (dBuV/m)	Margin (dB)	Antenna Height (m)	Table Angle (Degree)	Raw Value (dBuV)	Correction Factor (dB/m)
1	48.24	25.20 QP	40.00	-14.80	1.11 V	41	15.20	10.00
2	120.21	27.80 QP	43.50	-15.70	1.02 V	32	15.20	12.60
3	125.03	28.90 QP	43.50	-14.60	1.47 V	5	15.80	13.10
4	199.98	27.00 QP	43.50	-16.50	1.20 V	142	16.90	10.10
5	250.10	30.90 QP	46.00	-15.10	1.17 V	167	16.50	14.40
6	330.00	32.80 QP	46.00	-13.20	1.30 V	132	16.50	16.30
7	375.48	28.30 QP	46.00	-17.70	1.42 V	51	10.50	17.80
8	399.99	30.70 QP	46.00	-15.30	1.56 V	9	12.00	18.70
9	500.13	32.80 QP	46.00	-13.20	1.02 V	4	11.20	21.60
10	749.98	37.40 QP	46.00	-8.60	1.75 V	15	11.20	26.10

- REMARKS:**
1. Emission level(dBuV/m)=Raw Value(dBuV) + Correction Factor(dB)
 2. Correction Factor(dB/m) = Antenna Factor (dB/m) + Cable Factor (dB)
 3. The other emission levels were very low against the limit.
 4. Margin value = Emission level – Limit value.



EUT	Flanker Pro Single Radio AP	MODEL	AP-AG-AT-01
MODE	Channel 11 (Antenna 3-Adapter 2)	FREQUENCY RANGE	Below 1000 MHz
INPUT POWER (SYSTEM)	120Vac, 60Hz	DETECTOR FUNCTION	Quasi-Peak
ENVIRONMENTAL CONDITIONS	29deg. C, 56%RH, 972 hPa	TESTED BY	Eric Lee

ANTENNA POLARITY & TEST DISTANCE: HORIZONTAL AT 3 M

No.	Freq. (MHz)	Emission Level (dBuV/m)	Limit (dBuV/m)	Margin (dB)	Antenna Height (m)	Table Angle (Degree)	Raw Value (dBuV)	Correction Factor (dB/m)
1	120.00	26.70 QP	43.50	-16.80	1.20 H	125	14.10	12.60
2	125.09	28.50 QP	43.50	-15.00	1.99 H	52	15.40	13.10
3	199.99	28.30 QP	43.50	-15.20	1.36 H	62	18.20	10.10
4	250.06	30.20 QP	46.00	-15.80	1.02 H	52	15.80	14.40
5	300.00	29.30 QP	46.00	-16.70	1.94 H	56	13.90	15.40
6	331.00	34.20 QP	46.00	-11.80	1.02 H	35	17.90	16.30
7	375.24	30.50 QP	46.00	-15.50	1.47 H	47	12.70	17.80
8	399.99	32.60 QP	46.00	-13.40	1.58 H	65	13.90	18.70
9	500.10	35.20 QP	46.00	-10.80	1.54 H	23	13.60	21.60
10	749.68	40.40 QP	46.00	-5.60	1.53 H	62	14.20	26.10

ANTENNA POLARITY & TEST DISTANCE: VERTICAL AT 3 M

No.	Freq. (MHz)	Emission Level (dBuV/m)	Limit (dBuV/m)	Margin (dB)	Antenna Height (m)	Table Angle (Degree)	Raw Value (dBuV)	Correction Factor (dB/m)
1	49.24	25.20 QP	40.00	-14.80	1.62 V	352	15.70	9.50
2	121.00	28.10 QP	43.50	-15.40	1.85 V	256	15.50	12.70
3	125.38	30.90 QP	43.50	-12.60	1.02 V	5	17.90	13.00
4	200.00	25.30 QP	43.50	-18.20	1.42 V	62	15.20	10.10
5	251.01	31.70 QP	46.00	-14.30	2.00 V	213	17.20	14.50
6	330.26	31.70 QP	46.00	-14.30	1.69 V	3	15.40	16.30
7	375.02	28.70 QP	46.00	-17.30	1.47 V	147	10.90	17.80
8	400.00	30.90 QP	46.00	-15.10	1.02 V	3	12.20	18.70
9	499.99	31.30 QP	46.00	-14.70	1.20 V	25	9.70	21.60
10	750.02	38.40 QP	46.00	-7.60	1.54 V	74	12.20	26.10

- REMARKS:**
1. Emission level(dBuV/m)=Raw Value(dBuV) + Correction Factor(dB)
 2. Correction Factor(dB/m) = Antenna Factor (dB/m) + Cable Factor (dB)
 3. The other emission levels were very low against the limit.
 4. Margin value = Emission level – Limit value.



EUT	Flanker Pro Single Radio AP	MODEL	AP-AG-AT-01
MODE	Channel 11 (Antenna 3-POE)	FREQUENCY RANGE	Below 1000 MHz
INPUT POWER (SYSTEM)	120Vac, 60Hz	DETECTOR FUNCTION	Quasi-Peak
ENVIRONMENTAL CONDITIONS	29deg. C, 56%RH, 972 hPa	TESTED BY	Eric Lee

ANTENNA POLARITY & TEST DISTANCE: HORIZONTAL AT 3 M

No.	Freq. (MHz)	Emission Level (dBuV/m)	Limit (dBuV/m)	Margin (dB)	Antenna Height (m)	Table Angle (Degree)	Raw Value (dBuV)	Correction Factor (dB/m)
1	120.04	27.40 QP	43.50	-16.10	1.20 H	16	14.80	12.60
2	125.00	30.00 QP	43.50	-13.50	1.63 H	104	16.90	13.10
3	200.03	27.40 QP	43.50	-16.10	1.61 H	9	17.30	10.10
4	250.00	29.60 QP	46.00	-16.40	1.40 H	101	15.20	14.40
5	300.08	29.30 QP	46.00	-16.70	1.53 H	66	13.90	15.40
6	330.01	31.50 QP	46.00	-14.50	1.43 H	333	15.20	16.30
7	375.24	31.00 QP	46.00	-15.00	1.58 H	65	13.30	17.80
8	400.03	32.90 QP	46.00	-13.10	1.00 H	23	14.20	18.70
9	500.21	34.20 QP	46.00	-11.80	1.25 H	25	12.60	21.60
10	750.01	42.40 QP	46.00	-3.60	1.53 H	6	16.20	26.10

ANTENNA POLARITY & TEST DISTANCE: VERTICAL AT 3 M

No.	Freq. (MHz)	Emission Level (dBuV/m)	Limit (dBuV/m)	Margin (dB)	Antenna Height (m)	Table Angle (Degree)	Raw Value (dBuV)	Correction Factor (dB/m)
1	47.68	25.50 QP	40.00	-14.50	1.42 V	205	15.20	10.30
2	119.99	28.20 QP	43.50	-15.30	1.33 V	332	15.70	12.60
3	125.10	27.20 QP	43.50	-16.30	1.16 V	169	14.10	13.10
4	200.00	25.30 QP	43.50	-18.20	1.42 V	58	15.20	10.10
5	200.89	25.20 QP	43.50	-18.30	1.23 V	35	15.20	10.00
6	251.23	31.50 QP	46.00	-14.50	1.56 V	3	16.90	14.60
7	330.23	33.30 QP	46.00	-12.70	1.44 V	47	17.00	16.30
8	375.00	28.30 QP	46.00	-17.70	1.37 V	354	10.50	17.80
9	399.00	34.20 QP	46.00	-11.80	1.50 V	236	15.60	18.60
10	500.01	31.60 QP	46.00	-14.40	1.23 V	6	10.00	21.60
11	750.21	35.70 QP	46.00	-10.30	1.54 V	24	9.60	26.10

- REMARKS:**
1. Emission level(dBuV/m)=Raw Value(dBuV) + Correction Factor(dB)
 2. Correction Factor(dB/m) = Antenna Factor (dB/m) + Cable Factor (dB)
 3. The other emission levels were very low against the limit.
 4. Margin value = Emission level – Limit value.



EUT	Flanker Pro Single Radio AP	MODEL	AP-AG-AT-01
MODE	Channel 11 (Antenna 4-Adapter 1)	FREQUENCY RANGE	Below 1000 MHz
INPUT POWER (SYSTEM)	120Vac, 60Hz	DETECTOR FUNCTION	Quasi-Peak
ENVIRONMENTAL CONDITIONS	29deg. C, 56%RH, 972 hPa	TESTED BY	Eric Lee

ANTENNA POLARITY & TEST DISTANCE: HORIZONTAL AT 3 M

No.	Freq. (MHz)	Emission Level (dBuV/m)	Limit (dBuV/m)	Margin (dB)	Antenna Height (m)	Table Angle (Degree)	Raw Value (dBuV)	Correction Factor (dB/m)
1	120.01	23.50 QP	43.50	-20.00	1.98 H	74	10.90	12.60
2	125.32	28.50 QP	43.50	-15.00	1.52 H	65	15.40	13.00
3	200.32	24.30 QP	43.50	-19.20	1.55 H	241	14.20	10.10
4	250.04	29.00 QP	46.00	-17.00	1.53 H	264	14.60	14.40
5	300.11	27.90 QP	46.00	-18.10	1.55 H	132	12.50	15.40
6	330.50	30.20 QP	46.00	-15.80	1.85 H	124	13.90	16.30
7	375.06	28.80 QP	46.00	-17.20	1.28 H	60	11.00	17.80
8	400.03	28.70 QP	46.00	-17.30	1.21 H	2	10.00	18.70
9	500.21	31.90 QP	46.00	-14.10	1.52 H	254	10.20	21.60
10	749.98	37.70 QP	46.00	-8.30	1.42 H	205	11.50	26.10

ANTENNA POLARITY & TEST DISTANCE: VERTICAL AT 3 M

No.	Freq. (MHz)	Emission Level (dBuV/m)	Limit (dBuV/m)	Margin (dB)	Antenna Height (m)	Table Angle (Degree)	Raw Value (dBuV)	Correction Factor (dB/m)
1	50.23	24.40 QP	40.00	-15.60	1.23 V	65	15.40	9.00
2	120.12	27.40 QP	43.50	-16.10	1.02 V	4	14.90	12.60
3	125.00	30.00 QP	43.50	-13.50	1.68 V	222	16.90	13.10
4	200.13	25.50 QP	43.50	-18.00	1.51 V	242	15.50	10.10
5	250.01	31.90 QP	46.00	-14.10	1.44 V	54	17.50	14.40
6	330.03	32.10 QP	46.00	-13.90	1.65 V	246	15.80	16.30
7	375.13	28.30 QP	46.00	-17.70	1.47 V	54	10.50	17.80
8	400.02	31.20 QP	46.00	-14.80	1.65 V	214	12.50	18.70
9	500.00	33.30 QP	46.00	-12.70	1.98 V	63	11.60	21.60
10	749.99	37.40 QP	46.00	-8.60	1.47 V	56	11.20	26.10

- REMARKS:**
1. Emission level(dBuV/m)=Raw Value(dBuV) + Correction Factor(dB)
 2. Correction Factor(dB/m) = Antenna Factor (dB/m) + Cable Factor (dB)
 3. The other emission levels were very low against the limit.
 4. Margin value = Emission level – Limit value.



EUT	Flanker Pro Single Radio AP	MODEL	AP-AG-AT-01
MODE	Channel 11 (Antenna 4-Adapter 2)	FREQUENCY RANGE	Below 1000 MHz
INPUT POWER (SYSTEM)	120Vac, 60Hz	DETECTOR FUNCTION	Quasi-Peak
ENVIRONMENTAL CONDITIONS	29deg. C, 56%RH, 972 hPa	TESTED BY	Eric Lee

ANTENNA POLARITY & TEST DISTANCE: HORIZONTAL AT 3 M

No.	Freq. (MHz)	Emission Level (dBuV/m)	Limit (dBuV/m)	Margin (dB)	Antenna Height (m)	Table Angle (Degree)	Raw Value (dBuV)	Correction Factor (dB/m)
1	120.00	24.70 QP	43.50	-18.80	1.14 H	21	13.20	11.50
2	125.02	25.00 QP	43.50	-18.50	1.71 H	118	13.00	12.00
3	200.01	24.60 QP	43.50	-18.90	1.73 H	200	15.60	9.00
4	250.01	26.90 QP	46.00	-19.10	1.75 H	82	13.80	13.00
5	330.21	30.10 QP	46.00	-15.90	1.55 H	23	15.20	14.90
6	374.94	25.10 QP	46.00	-20.90	1.03 H	274	8.90	16.20
7	500.03	32.90 QP	46.00	-13.10	1.37 H	84	13.60	19.30
8	600.00	28.90 QP	46.00	-17.10	1.65 H	107	8.00	20.90
9	624.92	32.20 QP	46.00	-13.80	1.60 H	27	10.50	21.70
10	749.99	34.20 QP	46.00	-11.80	1.43 H	179	10.40	23.80

ANTENNA POLARITY & TEST DISTANCE: VERTICAL AT 3 M

No.	Freq. (MHz)	Emission Level (dBuV/m)	Limit (dBuV/m)	Margin (dB)	Antenna Height (m)	Table Angle (Degree)	Raw Value (dBuV)	Correction Factor (dB/m)
1	46.88	25.70 QP	40.00	-14.30	1.05 V	52	15.60	10.20
2	120.01	27.40 QP	43.50	-16.10	1.24 V	113	15.80	11.50
3	125.04	26.10 QP	43.50	-17.40	1.15 V	148	14.00	12.00
4	200.08	23.90 QP	43.50	-19.60	1.47 V	333	14.90	9.00
5	250.03	30.70 QP	46.00	-15.30	1.02 V	210	17.70	13.00
6	330.00	31.70 QP	46.00	-14.30	1.45 V	1	16.90	14.90
7	375.05	27.40 QP	46.00	-18.60	1.02 V	7	11.10	16.20
8	400.02	27.80 QP	46.00	-18.20	1.48 V	8	10.70	17.10
9	500.25	30.90 QP	46.00	-15.10	1.66 V	168	11.60	19.30
10	749.99	34.40 QP	46.00	-11.60	1.18 V	225	10.60	23.80

- REMARKS:**
1. Emission level(dBuV/m)=Raw Value(dBuV) + Correction Factor(dB)
 2. Correction Factor(dB/m) = Antenna Factor (dB/m) + Cable Factor (dB)
 3. The other emission levels were very low against the limit.
 4. Margin value = Emission level – Limit value.



EUT	Flanker Pro Single Radio AP	MODEL	AP-AG-AT-01
MODE	Channel 11 (Antenna 4-POE)	FREQUENCY RANGE	Below 1000 MHz
INPUT POWER (SYSTEM)	120Vac, 60Hz	DETECTOR FUNCTION	Quasi-Peak
ENVIRONMENTAL CONDITIONS	29deg. C, 56%RH, 972 hPa	TESTED BY	Eric Lee

ANTENNA POLARITY & TEST DISTANCE: HORIZONTAL AT 3 M

No.	Freq. (MHz)	Emission Level (dBuV/m)	Limit (dBuV/m)	Margin (dB)	Antenna Height (m)	Table Angle (Degree)	Raw Value (dBuV)	Correction Factor (dB/m)
1	119.00	21.50 QP	43.50	-22.00	1.57 H	52	10.10	11.50
2	125.12	27.50 QP	43.50	-16.00	1.59 H	356	15.50	12.00
3	200.00	23.60 QP	43.50	-19.90	2.00 H	354	14.60	9.00
4	250.03	29.60 QP	46.00	-16.40	1.01 H	65	16.60	13.00
5	300.04	26.70 QP	46.00	-19.30	1.13 H	33	12.50	14.20
6	330.07	29.60 QP	46.00	-16.40	1.11 H	28	14.70	14.90
7	375.11	27.00 QP	46.00	-19.00	1.82 H	342	10.80	16.20
8	399.99	27.90 QP	46.00	-18.10	1.43 H	309	10.80	17.10
9	500.01	29.20 QP	46.00	-16.80	1.46 H	205	9.90	19.30
10	750.00	36.20 QP	46.00	-9.80	1.85 H	224	12.40	23.80

ANTENNA POLARITY & TEST DISTANCE: VERTICAL AT 3 M

No.	Freq. (MHz)	Emission Level (dBuV/m)	Limit (dBuV/m)	Margin (dB)	Antenna Height (m)	Table Angle (Degree)	Raw Value (dBuV)	Correction Factor (dB/m)
1	49.52	23.50 QP	40.00	-16.50	1.36 V	222	14.80	8.70
2	119.99	23.50 QP	43.50	-20.00	1.40 V	57	12.00	11.50
3	124.21	21.60 QP	43.50	-21.90	1.82 V	333	9.60	12.00
4	200.01	24.20 QP	43.50	-19.30	1.02 V	8	15.20	9.00
5	249.98	31.50 QP	46.00	-14.50	1.08 V	286	18.50	13.00
6	300.00	30.00 QP	46.00	-16.00	1.42 V	350	15.80	14.20
7	330.00	31.30 QP	46.00	-14.70	1.22 V	1	16.40	14.90
8	375.01	29.00 QP	46.00	-17.00	1.16 V	40	12.80	16.20
9	500.05	31.50 QP	46.00	-14.50	1.31 V	221	12.20	19.30
10	749.21	34.60 QP	46.00	-11.40	1.38 V	151	10.80	23.80

- REMARKS:**
1. Emission level(dBuV/m)=Raw Value(dBuV) + Correction Factor(dB)
 2. Correction Factor(dB/m) = Antenna Factor (dB/m) + Cable Factor (dB)
 3. The other emission levels were very low against the limit.
 4. Margin value = Emission level – Limit value.



EUT	Flanker Pro Single Radio AP	MODEL	AP-AG-AT-01
MODE	Channel 11 (Antenna 5-Adapter 1)	FREQUENCY RANGE	Below 1000 MHz
INPUT POWER (SYSTEM)	120Vac, 60Hz	DETECTOR FUNCTION	Quasi-Peak
ENVIRONMENTAL CONDITIONS	29deg. C, 56%RH, 972 hPa	TESTED BY	Eric Lee

ANTENNA POLARITY & TEST DISTANCE: HORIZONTAL AT 3 M

No.	Freq. (MHz)	Emission Level (dBuV/m)	Limit (dBuV/m)	Margin (dB)	Antenna Height (m)	Table Angle (Degree)	Raw Value (dBuV)	Correction Factor (dB/m)
1	120.02	25.30 QP	43.50	-18.20	1.27 H	222	13.80	11.50
2	125.02	25.00 QP	43.50	-18.50	1.71 H	118	13.00	12.00
3	200.24	25.00 QP	43.50	-18.50	1.73 H	200	16.00	9.00
4	250.24	25.60 QP	46.00	-20.40	1.50 H	222	12.60	13.00
5	330.11	31.20 QP	46.00	-14.80	1.60 H	28	16.30	14.90
6	375.00	24.60 QP	46.00	-21.40	1.11 H	56	8.40	16.20
7	500.03	32.90 QP	46.00	-13.10	1.37 H	84	13.60	19.30
8	599.98	27.20 QP	46.00	-18.80	1.24 H	53	6.30	20.90
9	624.92	32.20 QP	46.00	-13.80	1.60 H	27	10.50	21.70
10	749.98	32.60 QP	46.00	-13.40	1.42 H	54	8.80	23.80

ANTENNA POLARITY & TEST DISTANCE: VERTICAL AT 3 M

No.	Freq. (MHz)	Emission Level (dBuV/m)	Limit (dBuV/m)	Margin (dB)	Antenna Height (m)	Table Angle (Degree)	Raw Value (dBuV)	Correction Factor (dB/m)
1	120.02	25.50 QP	43.50	-18.00	1.53 V	69	12.90	12.60
2	125.02	27.60 QP	43.50	-15.90	1.00 V	103	14.60	13.10
3	200.11	24.90 QP	43.50	-18.60	1.39 V	68	14.80	10.10
4	250.00	30.30 QP	46.00	-15.70	1.47 V	96	16.00	14.40
5	300.01	26.70 QP	46.00	-19.30	1.28 V	51	11.30	15.40
6	330.00	32.00 QP	46.00	-14.00	1.30 V	1	15.70	16.30
7	375.46	27.90 QP	46.00	-18.10	1.52 V	326	10.10	17.80
8	400.62	27.20 QP	46.00	-18.80	1.68 V	96	8.50	18.70
9	500.30	31.90 QP	46.00	-14.10	1.55 V	54	10.20	21.60
10	749.99	34.60 QP	46.00	-11.40	1.54 V	45	8.50	26.10

- REMARKS:**
1. Emission level(dBuV/m)=Raw Value(dBuV) + Correction Factor(dB)
 2. Correction Factor(dB/m) = Antenna Factor (dB/m) + Cable Factor (dB)
 3. The other emission levels were very low against the limit.
 4. Margin value = Emission level – Limit value.



EUT	Flanker Pro Single Radio AP	MODEL	AP-AG-AT-01
MODE	Channel 11 (Antenna 5-Adapter 2)	FREQUENCY RANGE	Below 1000 MHz
INPUT POWER (SYSTEM)	120Vac, 60Hz	DETECTOR FUNCTION	Quasi-Peak
ENVIRONMENTAL CONDITIONS	29deg. C, 56%RH, 972 hPa	TESTED BY	Eric Lee

ANTENNA POLARITY & TEST DISTANCE: HORIZONTAL AT 3 M

No.	Freq. (MHz)	Emission Level (dBuV/m)	Limit (dBuV/m)	Margin (dB)	Antenna Height (m)	Table Angle (Degree)	Raw Value (dBuV)	Correction Factor (dB/m)
1	119.98	24.70 QP	43.50	-18.80	1.52 H	41	13.30	11.50
2	125.00	25.30 QP	43.50	-18.20	1.02 H	35	13.20	12.10
3	200.12	22.50 QP	43.50	-21.00	1.56 H	324	13.50	9.00
4	250.00	26.00 QP	46.00	-20.00	1.59 H	3	13.00	13.00
5	330.00	28.60 QP	46.00	-17.40	1.28 H	295	13.70	14.90
6	375.10	26.20 QP	46.00	-19.80	1.30 H	36	10.00	16.20
7	500.23	31.90 QP	46.00	-14.10	1.87 H	66	12.60	19.30
8	600.00	30.80 QP	46.00	-15.20	1.11 H	23	9.90	20.90
9	625.40	31.60 QP	46.00	-14.40	1.53 H	63	9.90	21.70
10	750.21	34.70 QP	46.00	-11.30	1.86 H	325	10.90	23.80

ANTENNA POLARITY & TEST DISTANCE: VERTICAL AT 3 M

No.	Freq. (MHz)	Emission Level (dBuV/m)	Limit (dBuV/m)	Margin (dB)	Antenna Height (m)	Table Angle (Degree)	Raw Value (dBuV)	Correction Factor (dB/m)
1	49.21	23.10 QP	40.00	-16.90	1.24 V	10	14.20	8.90
2	120.00	26.40 QP	43.50	-17.10	1.50 V	58	14.90	11.50
3	125.07	23.90 QP	43.50	-19.60	1.57 V	351	11.90	12.00
4	200.05	24.20 QP	43.50	-19.30	1.64 V	352	15.20	9.00
5	250.11	31.00 QP	46.00	-15.00	1.24 V	342	18.00	13.00
6	330.01	29.60 QP	46.00	-16.40	1.62 V	11	14.70	14.90
7	375.02	27.30 QP	46.00	-18.70	1.14 V	50	11.10	16.20
8	400.00	26.50 QP	46.00	-19.50	1.45 V	251	9.40	17.10
9	499.00	32.00 QP	46.00	-14.00	1.61 V	52	12.70	19.30
10	750.00	33.00 QP	46.00	-13.00	1.95 V	2	9.20	23.80

- REMARKS:**
1. Emission level(dBuV/m)=Raw Value(dBuV) + Correction Factor(dB)
 2. Correction Factor(dB/m) = Antenna Factor (dB/m) + Cable Factor (dB)
 3. The other emission levels were very low against the limit.
 4. Margin value = Emission level – Limit value.



EUT	Flanker Pro Single Radio AP	MODEL	AP-AG-AT-01
MODE	Channel 11 (Antenna 5-POE)	FREQUENCY RANGE	Below 1000 MHz
INPUT POWER (SYSTEM)	120Vac, 60Hz	DETECTOR FUNCTION	Quasi-Peak
ENVIRONMENTAL CONDITIONS	29deg. C, 56%RH, 972 hPa	TESTED BY	Eric Lee

ANTENNA POLARITY & TEST DISTANCE: HORIZONTAL AT 3 M

No.	Freq. (MHz)	Emission Level (dBuV/m)	Limit (dBuV/m)	Margin (dB)	Antenna Height (m)	Table Angle (Degree)	Raw Value (dBuV)	Correction Factor (dB/m)
1	120.03	23.80 QP	43.50	-19.70	1.45 H	32	12.20	11.50
2	125.09	28.90 QP	43.50	-14.60	1.87 H	54	16.90	12.00
3	200.00	23.20 QP	43.50	-20.30	1.11 H	7	14.20	9.00
4	250.32	29.30 QP	46.00	-16.70	1.55 H	8	16.20	13.00
5	300.26	27.40 QP	46.00	-18.60	1.40 H	222	13.20	14.20
6	330.01	28.60 QP	46.00	-17.40	1.86 H	245	13.70	14.90
7	375.19	26.70 QP	46.00	-19.30	1.02 H	36	10.50	16.20
8	400.27	27.00 QP	46.00	-19.00	1.86 H	326	9.90	17.10
9	500.00	29.60 QP	46.00	-16.40	1.54 H	24	10.20	19.30
10	750.00	34.80 QP	46.00	-11.20	1.00 H	21	11.00	23.80

ANTENNA POLARITY & TEST DISTANCE: VERTICAL AT 3 M

No.	Freq. (MHz)	Emission Level (dBuV/m)	Limit (dBuV/m)	Margin (dB)	Antenna Height (m)	Table Angle (Degree)	Raw Value (dBuV)	Correction Factor (dB/m)
1	48.12	24.30 QP	40.00	-15.70	1.20 V	222	14.80	9.50
2	120.00	26.40 QP	43.50	-17.10	1.50 V	58	14.90	11.50
3	124.81	24.20 QP	43.50	-19.30	1.56 V	9	12.10	12.00
4	199.99	24.50 QP	43.50	-19.00	1.86 V	250	15.50	9.00
5	250.02	31.00 QP	46.00	-15.00	1.29 V	45	18.00	13.00
6	330.01	29.60 QP	46.00	-16.40	1.62 V	11	14.70	14.90
7	375.02	27.30 QP	46.00	-18.70	1.14 V	50	11.10	16.20
8	399.96	27.50 QP	46.00	-18.50	1.41 V	1	10.40	17.10
9	499.00	32.00 QP	46.00	-14.00	1.61 V	52	12.70	19.30
10	750.24	32.10 QP	46.00	-13.90	1.43 V	351	8.30	23.80

- REMARKS:**
1. Emission level(dBuV/m)=Raw Value(dBuV) + Correction Factor(dB)
 2. Correction Factor(dB/m) = Antenna Factor (dB/m) + Cable Factor (dB)
 3. The other emission levels were very low against the limit.
 4. Margin value = Emission level – Limit value.



EUT	Flanker Pro Single Radio AP	MODEL	AP-AG-AT-01
MODE	Channel 11 (Antenna 6-Adapter 1)	FREQUENCY RANGE	Below 1000 MHz
INPUT POWER (SYSTEM)	120Vac, 60Hz	DETECTOR FUNCTION	Quasi-Peak
ENVIRONMENTAL CONDITIONS	29deg. C, 56%RH, 972 hPa	TESTED BY	Eric Lee

ANTENNA POLARITY & TEST DISTANCE: HORIZONTAL AT 3 M

No.	Freq. (MHz)	Emission Level (dBuV/m)	Limit (dBuV/m)	Margin (dB)	Antenna Height (m)	Table Angle (Degree)	Raw Value (dBuV)	Correction Factor (dB/m)
1	119.81	22.00 QP	43.50	-21.50	1.50 H	350	10.50	11.50
2	125.34	28.30 QP	43.50	-15.20	1.02 H	78	16.30	12.00
3	200.36	23.20 QP	43.50	-20.30	1.02 H	321	14.20	9.00
4	250.21	29.90 QP	46.00	-16.10	1.24 H	78	16.90	13.00
5	300.20	27.10 QP	46.00	-18.90	1.57 H	78	12.90	14.20
6	330.03	28.50 QP	46.00	-17.50	1.25 H	52	13.60	14.90
7	375.03	27.20 QP	46.00	-18.80	1.53 H	26	11.00	16.20
8	400.10	27.10 QP	46.00	-18.90	1.00 H	93	10.00	17.10
9	500.24	29.30 QP	46.00	-16.70	1.47 H	78	10.00	19.30
10	750.02	36.30 QP	46.00	-9.70	1.28 H	60	12.50	23.80

ANTENNA POLARITY & TEST DISTANCE: VERTICAL AT 3 M

No.	Freq. (MHz)	Emission Level (dBuV/m)	Limit (dBuV/m)	Margin (dB)	Antenna Height (m)	Table Angle (Degree)	Raw Value (dBuV)	Correction Factor (dB/m)
1	48.20	24.80 QP	40.00	-15.20	1.54 V	24	15.30	9.40
2	120.01	26.70 QP	43.50	-16.80	1.53 V	69	15.20	11.50
3	125.30	27.00 QP	43.50	-16.50	1.11 V	74	15.00	12.00
4	200.13	25.30 QP	43.50	-18.20	1.08 V	356	16.30	9.00
5	250.41	31.10 QP	46.00	-14.90	1.01 V	225	18.00	13.10
6	330.00	31.80 QP	46.00	-14.20	2.00 V	5	16.90	14.90
7	375.61	27.10 QP	46.00	-18.90	1.82 V	246	10.90	16.20
8	400.35	29.00 QP	46.00	-17.00	1.52 V	333	11.90	17.10
9	500.53	30.30 QP	46.00	-15.70	1.35 V	69	11.00	19.30
10	750.03	35.80 QP	46.00	-10.20	1.49 V	335	12.00	23.80

- REMARKS:**
1. Emission level(dBuV/m)=Raw Value(dBuV) + Correction Factor(dB)
 2. Correction Factor(dB/m) = Antenna Factor (dB/m) + Cable Factor (dB)
 3. The other emission levels were very low against the limit.
 4. Margin value = Emission level – Limit value.



EUT	Flanker Pro Single Radio AP	MODEL	AP-AG-AT-01
MODE	Channel 11 (Antenna 6-Adapter 2)	FREQUENCY RANGE	Below 1000 MHz
INPUT POWER (SYSTEM)	120Vac, 60Hz	DETECTOR FUNCTION	Quasi-Peak
ENVIRONMENTAL CONDITIONS	29deg. C, 56%RH, 972 hPa	TESTED BY	Eric Lee

ANTENNA POLARITY & TEST DISTANCE: HORIZONTAL AT 3 M

No.	Freq. (MHz)	Emission Level (dBuV/m)	Limit (dBuV/m)	Margin (dB)	Antenna Height (m)	Table Angle (Degree)	Raw Value (dBuV)	Correction Factor (dB/m)
1	119.89	22.50 QP	43.50	-21.00	1.59 H	265	11.00	11.50
2	125.33	29.00 QP	43.50	-14.50	1.02 H	36	17.00	12.00
3	200.00	23.50 QP	43.50	-20.00	1.24 H	75	14.50	9.00
4	250.04	29.30 QP	46.00	-16.70	1.28 H	1	16.30	13.00
5	300.10	27.60 QP	46.00	-18.40	1.43 H	62	13.40	14.20
6	330.00	29.20 QP	46.00	-16.80	1.72 H	40	14.30	14.90
7	375.21	26.20 QP	46.00	-19.80	1.11 H	75	10.00	16.20
8	400.18	26.60 QP	46.00	-19.40	1.24 H	78	9.50	17.10
9	500.09	30.30 QP	46.00	-15.70	1.50 H	323	11.00	19.30
10	750.06	36.00 QP	46.00	-10.00	1.04 H	26	12.20	23.80

ANTENNA POLARITY & TEST DISTANCE: VERTICAL AT 3 M

No.	Freq. (MHz)	Emission Level (dBuV/m)	Limit (dBuV/m)	Margin (dB)	Antenna Height (m)	Table Angle (Degree)	Raw Value (dBuV)	Correction Factor (dB/m)
1	119.86	26.00 QP	43.50	-17.50	1.52 V	96	14.50	11.50
2	125.11	26.40 QP	43.50	-17.10	1.02 V	36	14.30	12.00
3	250.00	25.60 QP	46.00	-20.40	1.67 V	326	12.60	13.00
4	250.30	29.30 QP	46.00	-16.70	1.50 V	32	16.30	13.00
5	299.99	27.50 QP	46.00	-18.50	1.37 V	82	13.30	14.20
6	330.00	32.00 QP	46.00	-14.00	1.30 V	1	17.10	14.90
7	375.46	27.90 QP	46.00	-18.10	1.52 V	326	11.70	16.20
8	400.62	27.20 QP	46.00	-18.80	1.68 V	96	10.10	17.10
9	500.09	31.00 QP	46.00	-15.00	1.82 V	55	11.70	19.30
10	750.00	35.00 QP	46.00	-11.00	1.54 V	45	11.20	23.80

- REMARKS:**
1. Emission level(dBuV/m)=Raw Value(dBuV) + Correction Factor(dB)
 2. Correction Factor(dB/m) = Antenna Factor (dB/m) + Cable Factor (dB)
 3. The other emission levels were very low against the limit.
 4. Margin value = Emission level – Limit value.



EUT	Flanker Pro Single Radio AP	MODEL	AP-AG-AT-01
MODE	Channel 11 (Antenna 6-POE)	FREQUENCY RANGE	Below 1000 MHz
INPUT POWER (SYSTEM)	120Vac, 60Hz	DETECTOR FUNCTION	Quasi-Peak
ENVIRONMENTAL CONDITIONS	29deg. C, 56%RH, 972 hPa	TESTED BY	Eric Lee

ANTENNA POLARITY & TEST DISTANCE: HORIZONTAL AT 3 M

No.	Freq. (MHz)	Emission Level (dBuV/m)	Limit (dBuV/m)	Margin (dB)	Antenna Height (m)	Table Angle (Degree)	Raw Value (dBuV)	Correction Factor (dB/m)
1	120.02	24.70 QP	43.50	-18.80	1.75 H	82	13.20	11.50
2	125.10	26.20 QP	43.50	-17.30	1.06 H	63	14.20	12.00
3	200.23	18.30 QP	43.50	-25.20	1.22 H	53	9.30	9.00
4	250.00	27.10 QP	46.00	-18.90	1.82 H	194	14.10	13.00
5	330.01	29.90 QP	46.00	-16.10	1.29 H	1	15.00	14.90
6	375.04	19.80 QP	46.00	-26.20	1.04 H	58	3.60	16.20
7	500.21	32.90 QP	46.00	-13.10	1.28 H	352	13.60	19.30
8	600.12	29.50 QP	46.00	-16.50	1.47 H	78	8.60	20.90
9	624.99	32.30 QP	46.00	-13.70	1.43 H	6	10.60	21.70
10	750.10	34.10 QP	46.00	-11.90	1.52 H	47	10.30	23.80

ANTENNA POLARITY & TEST DISTANCE: VERTICAL AT 3 M

No.	Freq. (MHz)	Emission Level (dBuV/m)	Limit (dBuV/m)	Margin (dB)	Antenna Height (m)	Table Angle (Degree)	Raw Value (dBuV)	Correction Factor (dB/m)
1	49.50	27.40 QP	40.00	-12.60	1.64 V	72	18.60	8.80
2	120.22	25.50 QP	43.50	-18.00	1.34 V	58	14.00	11.50
3	124.81	24.20 QP	43.50	-19.30	1.56 V	9	12.10	12.00
4	199.99	23.30 QP	43.50	-20.20	1.86 V	250	14.30	9.00
5	250.02	31.00 QP	46.00	-15.00	1.29 V	45	18.00	13.00
6	330.01	29.60 QP	46.00	-16.40	1.62 V	11	14.70	14.90
7	375.02	27.30 QP	46.00	-18.70	1.14 V	50	11.10	16.20
8	399.96	27.50 QP	46.00	-18.50	1.41 V	1	10.40	17.10
9	500.03	32.60 QP	46.00	-13.40	1.61 V	52	13.30	19.30
10	699.75	32.90 QP	46.00	-13.10	1.20 V	79	10.50	22.40

- REMARKS:**
1. Emission level(dBuV/m)=Raw Value(dBuV) + Correction Factor(dB)
 2. Correction Factor(dB/m) = Antenna Factor (dB/m) + Cable Factor (dB)
 3. The other emission levels were very low against the limit.
 4. Margin value = Emission level – Limit value.



EUT	Flanker Pro Single Radio AP	MODEL	AP-AG-AT-01
MODE	Channel 11 (Antenna 7-Adapter 1)	FREQUENCY RANGE	Below 1000 MHz
INPUT POWER (SYSTEM)	120Vac, 60Hz	DETECTOR FUNCTION	Quasi-Peak
ENVIRONMENTAL CONDITIONS	29deg. C, 56%RH, 972 hPa	TESTED BY	Eric Lee

ANTENNA POLARITY & TEST DISTANCE: HORIZONTAL AT 3 M

No.	Freq. (MHz)	Emission Level (dBuV/m)	Limit (dBuV/m)	Margin (dB)	Antenna Height (m)	Table Angle (Degree)	Raw Value (dBuV)	Correction Factor (dB/m)
1	120.09	25.50 QP	43.50	-18.00	1.14 H	170	14.00	11.50
2	125.02	25.00 QP	43.50	-18.50	1.71 H	118	13.00	12.00
3	200.01	24.60 QP	43.50	-18.90	1.73 H	200	15.60	9.00
4	250.01	26.90 QP	46.00	-19.10	1.75 H	82	13.80	13.00
5	329.99	30.10 QP	46.00	-15.90	1.55 H	23	15.20	14.90
6	374.94	25.10 QP	46.00	-20.90	1.03 H	274	8.90	16.20
7	499.99	35.80 QP	46.00	-10.20	1.56 H	213	16.50	19.30
8	600.00	28.90 QP	46.00	-17.10	1.65 H	107	8.00	20.90
9	624.92	32.20 QP	46.00	-13.80	1.60 H	27	10.50	21.70
10	750.09	34.80 QP	46.00	-11.20	1.52 H	333	11.00	23.80

ANTENNA POLARITY & TEST DISTANCE: VERTICAL AT 3 M

No.	Freq. (MHz)	Emission Level (dBuV/m)	Limit (dBuV/m)	Margin (dB)	Antenna Height (m)	Table Angle (Degree)	Raw Value (dBuV)	Correction Factor (dB/m)
1	47.32	26.20 QP	40.00	-13.80	1.25 V	222	16.30	9.90
2	119.77	27.40 QP	43.50	-16.10	1.24 V	113	15.90	11.50
3	125.32	26.80 QP	43.50	-16.70	1.30 V	3	14.80	12.00
4	200.00	24.30 QP	43.50	-19.20	1.53 V	1	15.30	9.00
5	250.24	29.60 QP	46.00	-16.40	1.85 V	3	16.50	13.00
6	329.98	30.20 QP	46.00	-15.80	1.02 V	47	15.40	14.90
7	375.05	27.40 QP	46.00	-18.60	1.02 V	7	11.10	16.20
8	399.99	28.30 QP	46.00	-17.70	1.53 V	62	11.20	17.10
9	499.99	29.50 QP	46.00	-16.50	1.09 V	7	10.20	19.30
10	750.00	33.20 QP	46.00	-12.80	1.20 V	90	9.40	23.80

- REMARKS:**
1. Emission level(dBuV/m)=Raw Value(dBuV) + Correction Factor(dB)
 2. Correction Factor(dB/m) = Antenna Factor (dB/m) + Cable Factor (dB)
 3. The other emission levels were very low against the limit.
 4. Margin value = Emission level – Limit value.



EUT	Flanker Pro Single Radio AP	MODEL	AP-AG-AT-01
MODE	Channel 11 (Antenna 7-Adapter 2)	FREQUENCY RANGE	Below 1000 MHz
INPUT POWER (SYSTEM)	120Vac, 60Hz	DETECTOR FUNCTION	Quasi-Peak
ENVIRONMENTAL CONDITIONS	29deg. C, 56%RH, 972 hPa	TESTED BY	Eric Lee

ANTENNA POLARITY & TEST DISTANCE: HORIZONTAL AT 3 M

No.	Freq. (MHz)	Emission Level (dBuV/m)	Limit (dBuV/m)	Margin (dB)	Antenna Height (m)	Table Angle (Degree)	Raw Value (dBuV)	Correction Factor (dB/m)
1	120.09	25.30 QP	43.50	-18.20	1.23 H	3	13.80	11.50
2	125.02	25.00 QP	43.50	-18.50	1.24 H	5	13.00	12.00
3	200.01	24.60 QP	43.50	-18.90	1.73 H	200	15.60	9.00
4	250.00	26.50 QP	46.00	-19.50	1.52 H	25	13.50	13.00
5	329.99	29.30 QP	46.00	-16.70	1.81 H	1	14.40	14.90
6	375.12	26.10 QP	46.00	-19.90	1.13 H	63	9.90	16.20
7	500.00	34.30 QP	46.00	-11.70	1.70 H	222	15.00	19.30
8	600.02	30.70 QP	46.00	-15.30	1.73 H	59	9.80	20.90
9	625.00	32.70 QP	46.00	-13.30	1.11 H	12	11.00	21.70
10	749.98	34.80 QP	46.00	-11.20	1.24 H	4	11.00	23.80

ANTENNA POLARITY & TEST DISTANCE: VERTICAL AT 3 M

No.	Freq. (MHz)	Emission Level (dBuV/m)	Limit (dBuV/m)	Margin (dB)	Antenna Height (m)	Table Angle (Degree)	Raw Value (dBuV)	Correction Factor (dB/m)
1	49.00	25.80 QP	40.00	-14.20	1.11 V	2	16.80	9.00
2	120.08	28.50 QP	43.50	-15.00	1.04 V	77	17.00	11.50
3	125.01	28.30 QP	43.50	-15.20	1.68 V	256	16.30	12.00
4	201.21	25.30 QP	43.50	-18.20	1.62 V	326	16.40	8.90
5	250.92	27.40 QP	46.00	-18.60	1.34 V	3	14.20	13.10
6	330.09	31.00 QP	46.00	-15.00	1.12 V	323	16.10	14.90
7	375.12	28.50 QP	46.00	-17.50	1.60 V	333	12.30	16.20
8	400.02	26.40 QP	46.00	-19.60	1.54 V	254	9.20	17.10
9	499.99	27.90 QP	46.00	-18.10	1.53 V	162	8.60	19.30
10	750.01	32.90 QP	46.00	-13.10	1.33 V	123	9.10	23.80

- REMARKS:**
1. Emission level(dBuV/m)=Raw Value(dBuV) + Correction Factor(dB)
 2. Correction Factor(dB/m) = Antenna Factor (dB/m) + Cable Factor (dB)
 3. The other emission levels were very low against the limit.
 4. Margin value = Emission level – Limit value.



EUT	Flanker Pro Single Radio AP	MODEL	AP-AG-AT-01
MODE	Channel 11 (Antenna 7-POE)	FREQUENCY RANGE	Below 1000 MHz
INPUT POWER (SYSTEM)	120Vac, 60Hz	DETECTOR FUNCTION	Quasi-Peak
ENVIRONMENTAL CONDITIONS	29deg. C, 56%RH, 972 hPa	TESTED BY	Eric Lee

ANTENNA POLARITY & TEST DISTANCE: HORIZONTAL AT 3 M

No.	Freq. (MHz)	Emission Level (dBuV/m)	Limit (dBuV/m)	Margin (dB)	Antenna Height (m)	Table Angle (Degree)	Raw Value (dBuV)	Correction Factor (dB/m)
1	120.11	24.60 QP	43.50	-18.90	1.53 H	44	13.10	11.50
2	125.10	25.30 QP	43.50	-18.20	1.02 H	332	13.20	12.00
3	200.13	23.30 QP	43.50	-20.20	1.60 H	54	14.30	9.00
4	250.07	27.30 QP	46.00	-18.70	1.35 H	62	14.30	13.00
5	330.43	29.30 QP	46.00	-16.70	1.81 H	1	14.40	14.90
6	375.24	26.20 QP	46.00	-19.80	1.96 H	3	10.00	16.20
7	400.06	27.00 QP	46.00	-19.00	1.68 H	93	9.90	17.10
8	500.00	34.30 QP	46.00	-11.70	1.70 H	222	15.00	19.30
9	625.03	32.70 QP	46.00	-13.30	1.20 H	341	11.00	21.70
10	750.21	33.80 QP	46.00	-12.20	1.10 H	198	10.00	23.80

ANTENNA POLARITY & TEST DISTANCE: VERTICAL AT 3 M

No.	Freq. (MHz)	Emission Level (dBuV/m)	Limit (dBuV/m)	Margin (dB)	Antenna Height (m)	Table Angle (Degree)	Raw Value (dBuV)	Correction Factor (dB/m)
1	48.54	26.30 QP	40.00	-13.70	1.01 V	213	17.10	9.30
2	120.02	29.00 QP	43.50	-14.50	1.23 V	302	17.50	11.50
3	125.03	27.50 QP	43.50	-16.00	1.00 V	204	15.50	12.00
4	200.03	25.50 QP	43.50	-18.00	1.08 V	99	16.50	9.00
5	250.11	26.70 QP	46.00	-19.30	1.96 V	54	13.70	13.00
6	330.00	32.20 QP	46.00	-13.80	1.06 V	306	17.30	14.90
7	375.08	28.60 QP	46.00	-17.40	1.66 V	69	12.40	16.20
8	400.01	26.40 QP	46.00	-19.60	1.51 V	353	9.20	17.10
9	500.00	26.90 QP	46.00	-19.10	1.11 V	3	7.60	19.30
10	750.00	31.50 QP	46.00	-14.50	1.42 V	62	7.70	23.80

- REMARKS:**
1. Emission level(dBuV/m)=Raw Value(dBuV) + Correction Factor(dB)
 2. Correction Factor(dB/m) = Antenna Factor (dB/m) + Cable Factor (dB)
 3. The other emission levels were very low against the limit.
 4. Margin value = Emission level – Limit value.



4.2.8 TEST RESULTS - DSSS (ANTENNA 1)

EUT	Flanker Pro Single Radio AP	MODEL	AP-AG-AT-01
MODE	Channel 1	FREQUENCY RANGE	1000MHz~25000MHz
INPUT POWER (SYSTEM)	120Vac, 60Hz	DETECTOR FUNCTION	Peak(PK) Average (AV)
ENVIRONMENTAL CONDITIONS	17deg. C, 68%RH, 972 hPa	TESTED BY	Eric Lee

ANTENNA POLARITY & TEST DISTANCE: HORIZONTAL AT 3 M

No.	Freq. (MHz)	Emission Level (dBuV/m)	Limit (dBuV/m)	Margin (dB)	Antenna Height (m)	Table Angle (Degree)	Raw Value (dBuV)	Correction Factor (dB/m)
1	2016.00	48.80 PK	74.00	-25.20	1.18 H	10	19.60	29.20
2	2360.00	47.80 PK	74.00	-26.20	1.00 H	352	17.50	30.30
3	2390.00	55.00 PK	74.00	-19.00	2.00 H	324	24.60	30.40
3	2390.00	46.00 AV	54.00	-8.00	2.00 H	324	15.60	30.40
4	*2412.00	105.00 PK			1.00 H	31	74.50	30.50
4	*2412.00	97.80 AV			1.00 H	31	67.20	30.50
5	4824.00	56.50 PK	74.00	-17.50	1.58 H	28	20.20	36.20
5	4824.00	47.20 AV	54.00	-6.80	1.58 H	28	10.90	36.20
6	7236.00	48.00 PK	74.00	-26.00	1.39 H	311	6.30	41.70

ANTENNA POLARITY & TEST DISTANCE: VERTICAL AT 3 M

No.	Freq. (MHz)	Emission Level (dBuV/m)	Limit (dBuV/m)	Margin (dB)	Antenna Height (m)	Table Angle (Degree)	Raw Value (dBuV)	Correction Factor (dB/m)
1	2016.00	48.40 PK	74.00	-25.60	1.42 V	15	19.20	29.20
2	2360.00	58.60 PK	74.00	-15.40	1.00 V	360	28.30	30.30
2	2360.00	49.20 AV	54.00	-4.80	1.00 V	360	18.90	30.30
3	2390.00	59.70 PK	74.00	-14.30	1.24 V	347	29.30	30.40
3	2390.00	52.00 AV	54.00	-2.00	1.24 V	347	21.60	30.40
4	*2412.00	111.00 PK			1.00 V	36	80.50	30.50
4	*2412.00	103.80 AV			1.00 V	36	73.20	30.50
5	4824.00	60.90 PK	74.00	-13.10	1.51 V	252	24.70	36.20
5	4824.00	50.20 AV	54.00	-3.80	1.51 V	252	14.00	36.20
6	7236.00	47.30 PK	74.00	-26.70	1.40 V	254	5.70	41.70

- NOTE:**
1. Emission level = Raw Value - Correction Factor
 2. Correction Factor = External Preamp. Gain - Ant. Factor - Cable loss
(External Preamp. Gain = 0, when the test receiver is used for the test.)
 3. The other emission levels were very low against the limit.
 4. Margin value = Emission level - Limit value
 5. The limit value is defined as per 15.247
 6. " * " : Fundamental frequency



EUT	Flanker Pro Single Radio AP	MODEL	AP-AG-AT-01
MODE	Channel 6	FREQUENCY RANGE	1000MHz~25000MHz
INPUT POWER (SYSTEM)	120Vac, 60Hz	DETECTOR FUNCTION	Peak(PK) Average (AV)
ENVIRONMENTAL CONDITIONS	26deg. C, 67%RH, 972 hPa	TESTED BY	Eric Lee

ANTENNA POLARITY & TEST DISTANCE: HORIZONTAL AT 3 M

No.	Freq. (MHz)	Emission Level (dBuV/m)	Limit (dBuV/m)	Margin (dB)	Antenna Height (m)	Table Angle (Degree)	Raw Value (dBuV)	Correction Factor (dB/m)
1	2016.00	45.10 PK	74.00	-28.90	1.17 H	357	15.80	29.20
2	2360.00	51.20 PK	74.00	-22.80	1.00 H	35	20.90	30.30
2	2360.00	41.90 AV	54.00	-12.10	1.00 H	35	11.60	30.30
3	*2437.00	104.30 PK			1.64 H	199	73.60	30.70
3	*2437.00	97.60 AV			1.64 H	199	66.90	30.70
4	2496.00	42.80 PK	74.00	-31.20	1.68 H	34	12.00	30.80
5	4874.00	53.60 PK	74.00	-20.40	1.84 H	267	17.20	36.50
5	4874.00	42.20 AV	54.00	-11.80	1.84 H	267	5.70	36.50
6	7311.00	47.10 PK	74.00	-26.90	1.13 H	40	5.40	41.80

ANTENNA POLARITY & TEST DISTANCE: VERTICAL AT 3 M

No.	Freq. (MHz)	Emission Level (dBuV/m)	Limit (dBuV/m)	Margin (dB)	Antenna Height (m)	Table Angle (Degree)	Raw Value (dBuV)	Correction Factor (dB/m)
1	2016.00	57.50 PK	74.00	-16.50	1.45 V	23	28.30	29.20
1	2016.00	47.80 AV	54.00	-6.20	1.45 V	23	18.60	29.20
2	2360.00	59.10 PK	74.00	-14.90	1.00 V	17	28.70	30.30
2	2360.00	50.00 AV	54.00	-4.00	1.00 V	17	19.70	30.30
3	*2437.00	110.80 PK			1.00 V	278	80.20	30.70
3	*2437.00	103.70 AV			1.00 V	278	73.00	30.70
4	2496.00	48.90 PK	74.00	-25.10	1.00 V	94	18.10	30.80
5	4874.00	58.40 PK	74.00	-15.60	1.02 V	4	21.90	36.50
5	4874.00	48.50 AV	54.00	-5.50	1.02 V	4	12.10	36.50
6	7311.00	49.60 PK	74.00	-24.40	1.39 V	8	7.80	41.80

- NOTE:**
1. Emission level = Raw Value - Correction Factor
 2. Correction Factor = External Preamp. Gain - Ant. Factor - Cable loss
(External Preamp. Gain = 0, when the test receiver is used for the test.)
 3. The other emission levels were very low against the limit.
 4. Margin value = Emission level - Limit value
 5. The limit value is defined as per 15.247
 6. " * " : Fundamental frequency



EUT	Flanker Pro Single Radio AP	MODEL	AP-AG-AT-01
MODE	Channel 11	FREQUENCY RANGE	1000MHz~25000MHz
INPUT POWER (SYSTEM)	120Vac, 60Hz	DETECTOR FUNCTION	Peak(PK) Average (AV)
ENVIRONMENTAL CONDITIONS	17deg. C, 68%RH, 972 hPa	TESTED BY	Eric Lee

ANTENNA POLARITY & TEST DISTANCE: HORIZONTAL AT 3M

No.	Freq. (MHz)	Emission Level (dBuV/m)	Limit (dBuV/m)	Margin (dB)	Antenna Height (m)	Table Angle (Degree)	Raw Value (dBuV)	Correction Factor (dB/m)
1	2016.00	43.80 PK	74.00	-30.20	1.45 H	28	14.60	29.20
2	*2462.00	107.50 PK			1.45 H	178	76.70	30.80
2	*2462.00	100.10 AV			1.45 H	178	69.30	30.80
3	2483.50	54.60 PK	74.00	-19.40	1.27 H	27	23.60	31.00
3	2483.50	45.10 AV	54.00	-8.90	1.27 H	27	14.10	31.00
4	2496.00	50.60 PK	74.00	-23.40	1.55 H	22	19.90	30.80
5	4924.00	47.30 PK	74.00	-26.70	1.32 H	354	10.60	36.70
6	7386.00	47.40 PK	74.00	-26.60	1.01 H	107	5.60	41.80

ANTENNA POLARITY & TEST DISTANCE: VERTICAL AT 3M

No.	Freq. (MHz)	Emission Level (dBuV/m)	Limit (dBuV/m)	Margin (dB)	Antenna Height (m)	Table Angle (Degree)	Raw Value (dBuV)	Correction Factor (dB/m)
1	2016.00	50.40 PK	74.00	-23.60	1.24 V	72	21.20	29.20
2	*2462.00	113.20 PK			1.26 V	262	82.30	30.80
2	*2462.00	105.20 AV			1.26 V	262	74.30	30.80
3	2483.50	58.70 PK	74.00	-15.30	1.24 V	360	27.70	31.00
3	2483.50	50.20 AV	54.00	-3.80	1.24 V	360	19.20	31.00
4	2496.00	55.90 PK	74.00	-18.10	1.00 V	316	25.10	30.80
4	2496.00	39.60 AV	54.00	-14.40	1.00 V	316	8.80	30.80
5	4924.00	54.30 PK	74.00	-19.70	1.32 V	360	17.60	36.70
5	4924.00	44.10 AV	54.00	-9.90	1.32 V	360	7.40	36.70
6	7386.00	50.20 PK	74.00	-23.80	1.00 V	13	8.40	41.80

- NOTE:**
1. Emission level= Raw Value - Correction Factor
 2. Correction Factor = External Preamp. Gain - Ant. Factor - Cable loss
(External Preamp. Gain = 0, when the test receiver is used for the test.)
 3. The other emission levels were very low against the limit.
 4. Margin value = Emission level - Limit value
 5. The limit value is defined as per 15.247
 6. " * " : Fundamental frequency



4.2.9 TEST RESULTS - DSSS (ANTENNA 2)

EUT	Flanker Pro Single Radio AP	MODEL	AP-AG-AT-01
MODE	Channel 1	FREQUENCY RANGE	1000MHz~25000MHz
INPUT POWER (SYSTEM)	120Vac, 60Hz	DETECTOR FUNCTION	Peak(PK) Average (AV)
ENVIRONMENTAL CONDITIONS	17deg. C, 68%RH, 972 hPa	TESTED BY	Eric Lee

ANTENNA POLARITY & TEST DISTANCE: HORIZONTAL AT 3 M

No.	Freq. (MHz)	Emission Level (dBuV/m)	Limit (dBuV/m)	Margin (dB)	Antenna Height (m)	Table Angle (Degree)	Raw Value (dBuV)	Correction Factor (dB/m)
1	2016.00	49.70 PK	74.00	-24.30	1.23 H	65	20.50	29.20
2	2320.00	41.30 PK	74.00	-32.70	1.56 H	36	11.10	30.20
3	2360.00	54.10 PK	74.00	-19.90	1.76 H	65	23.70	30.30
3	2360.00	43.80 AV	54.00	-10.20	1.76 H	65	13.50	30.30
4	2387.00	54.90 PK	74.00	-19.10	1.36 H	65	24.50	30.40
4	2387.00	46.20 AV	54.00	-7.80	1.36 H	65	15.80	30.40
5	2390.00	55.20 PK	74.00	-18.80	1.36 H	9	24.80	30.40
5	2390.00	47.20 AV	54.00	-6.80	1.36 H	9	16.80	30.40
6	*2412.00	107.50 PK			1.44 H	47	77.00	30.50
6	*2412.00	101.70 AV			1.44 H	47	71.20	30.50
7	2688.00	35.90 PK	74.00	-38.10	1.54 H	24	4.70	31.30
8	4824.00	50.90 PK	74.00	-23.10	1.66 H	335	14.60	36.20
9	7236.00	47.20 PK	74.00	-26.80	1.48 H	78	5.60	41.70
10	9648.00	49.60 PK	74.00	-24.40	1.02 H	24	4.70	44.90

- NOTE:**
1. Emission level = Raw Value - Correction Factor
 2. Correction Factor = External Preamp. Gain - Ant. Factor - Cable loss
(External Preamp. Gain = 0, when the test receiver is used for the test.)
 3. The other emission levels were very low against the limit.
 4. Margin value = Emission level - Limit value
 5. The limit value is defined as per 15.247
 6. " * " : Fundamental frequency



EUT	Flanker Pro Single Radio AP	MODEL	AP-AG-AT-01
MODE	Channel 1	FREQUENCY RANGE	1000MHz~25000MHz
INPUT POWER (SYSTEM)	120Vac, 60Hz	DETECTOR FUNCTION	Peak(PK) Average (AV)
ENVIRONMENTAL CONDITIONS	17deg. C, 68%RH, 972 hPa	TESTED BY	Eric Lee

ANTENNA POLARITY & TEST DISTANCE: VERTICAL AT 3 M

No.	Freq. (MHz)	Emission Level (dBuV/m)	Limit (dBuV/m)	Margin (dB)	Antenna Height (m)	Table Angle (Degree)	Raw Value (dBuV)	Correction Factor (dB/m)
1	2016.00	51.20 PK	74.00	-22.80	1.34 V	325	21.90	29.20
1	2016.00	49.40 AV	54.00	-4.60	1.34 V	325	20.20	29.20
2	2320.00	61.30 PK	74.00	-12.70	1.80 V	64	31.10	30.20
2	2320.00	50.50 AV	54.00	-3.50	1.80 V	64	20.30	30.20
3	2360.00	61.40 PK	74.00	-12.60	1.45 V	24	31.00	30.30
3	2360.00	50.60 AV	54.00	-3.40	1.45 V	24	20.30	30.30
4	2387.00	58.00 PK	74.00	-16.00	1.13 V	326	27.60	30.40
4	2387.00	49.10 AV	54.00	-4.90	1.13 V	326	18.70	30.40
5	2390.00	58.50 PK	74.00	-15.50	1.02 V	25	28.10	30.40
5	2390.00	51.00 AV	54.00	-3.00	1.02 V	25	20.60	30.40
6	*2412.00	110.70 PK			1.37 V	16	80.10	30.50
6	*2412.00	103.60 AV			1.37 V	16	73.00	30.50
7	2688.00	41.60 PK	74.00	-32.40	1.54 V	24	10.30	31.30
8	4824.00	58.20 PK	74.00	-15.80	1.02 V	24	22.00	36.20
8	4824.00	47.00 AV	54.00	-7.00	1.02 V	24	10.80	36.20
9	7236.00	50.70 PK	74.00	-23.30	1.54 V	245	9.10	41.70
10	9648.00	52.40 PK	74.00	-21.60	1.30 V	24	7.50	44.90
10	9648.00	40.50 AV	54.00	-13.50	1.30 V	24	-4.40	44.90
10	9648.00	44.60 AV	54.00	-9.40	1.57 V	54	-0.30	44.90

- NOTE:**
1. Emission level = Raw Value - Correction Factor
 2. Correction Factor = External Preamp. Gain - Ant. Factor - Cable loss
(External Preamp. Gain = 0, when the test receiver is used for the test.)
 3. The other emission levels were very low against the limit.
 4. Margin value = Emission level - Limit value
 5. The limit value is defined as per 15.247
 6. " * " : Fundamental frequency



EUT	Flanker Pro Single Radio AP	MODEL	AP-AG-AT-01
MODE	Channel 6	FREQUENCY RANGE	1000MHz~25000MHz
INPUT POWER (SYSTEM)	120Vac, 60Hz	DETECTOR FUNCTION	Peak(PK) Average (AV)
ENVIRONMENTAL CONDITIONS	26deg. C, 67%RH, 972 hPa	TESTED BY	Eric Lee

ANTENNA POLARITY & TEST DISTANCE: HORIZONTAL AT 3 M

No.	Freq. (MHz)	Emission Level (dBuV/m)	Limit (dBuV/m)	Margin (dB)	Antenna Height (m)	Table Angle (Degree)	Raw Value (dBuV)	Correction Factor (dB/m)
1	2016.00	48.50 PK	74.00	-25.50	1.11 H	333	19.20	29.20
2	2320.00	41.00 PK	74.00	-33.00	1.53 H	62	10.80	30.20
3	2360.00	54.80 PK	74.00	-19.20	2.00 H	360	24.50	30.30
3	2360.00	44.00 AV	54.00	-10.00	2.00 H	360	13.70	30.30
4	2390.00	49.20 PK	74.00	-24.80	1.35 H	6	18.80	30.40
5	*2437.00	108.70 PK			1.54 H	36	78.00	30.70
5	*2437.00	101.90 AV			1.54 H	36	71.30	30.70
6	2483.50	51.60 PK	74.00	-22.40	1.11 H	25	20.60	31.00
6	2483.50	39.60 AV	54.00	-14.40	1.11 H	25	8.60	31.00
7	2688.00	35.90 PK	74.00	-38.10	1.23 H	360	4.70	31.30
8	4874.00	50.60 PK	74.00	-23.40	1.68 H	54	14.10	36.50
9	7311.00	47.00 PK	74.00	-27.00	1.10 H	256	5.20	41.80
10	9748.00	52.10 PK	74.00	-21.90	1.10 H	25	7.40	44.60
10	9748.00	41.30 AV	54.00	-12.70	1.10 H	25	-3.30	44.60

- NOTE:**
1. Emission level = Raw Value - Correction Factor
 2. Correction Factor = External Preamp. Gain - Ant. Factor - Cable loss
(External Preamp. Gain = 0, when the test receiver is used for the test.)
 3. The other emission levels were very low against the limit.
 4. Margin value = Emission level - Limit value
 5. The limit value is defined as per 15.247
 6. " * " : Fundamental frequency



EUT	Flanker Pro Single Radio AP	MODEL	AP-AG-AT-01
MODE	Channel 6	FREQUENCY RANGE	1000MHz~25000MHz
INPUT POWER (SYSTEM)	120Vac, 60Hz	DETECTOR FUNCTION	Peak(PK) Average (AV)
ENVIRONMENTAL CONDITIONS	26deg. C, 67%RH, 972 hPa	TESTED BY	Eric Lee

ANTENNA POLARITY & TEST DISTANCE: VERTICAL AT 3 M

No.	Freq. (MHz)	Emission Level (dBuV/m)	Limit (dBuV/m)	Margin (dB)	Antenna Height (m)	Table Angle (Degree)	Raw Value (dBuV)	Correction Factor (dB/m)
1	2016.00	52.50 PK	74.00	-21.50	1.02 V	4	23.30	29.20
1	2016.00	50.40 AV	54.00	-3.60	1.02 V	4	21.10	29.20
2	2320.00	47.10 PK	74.00	-26.90	1.70 V	25	16.90	30.20
3	2360.00	61.10 PK	74.00	-12.90	1.12 V	325	30.70	30.30
3	2360.00	49.10 AV	54.00	-4.90	1.12 V	325	18.70	30.30
4	2390.00	62.60 PK	74.00	-11.40	1.11 V	2	32.20	30.40
4	2390.00	47.20 AV	54.00	-6.80	1.11 V	2	16.80	30.40
5	*2437.00	110.80 PK			1.54 V	25	80.10	30.70
5	*2437.00	104.90 AV			1.54 V	25	74.20	30.70
6	2483.50	62.00 PK	74.00	-12.00	1.02 V	325	31.00	31.00
6	2483.50	47.60 AV	54.00	-6.40	1.02 V	325	16.60	31.00
7	2688.00	43.40 PK	74.00	-30.60	1.11 V	24	12.20	31.30
8	4874.00	58.60 PK	74.00	-15.40	1.52 V	35	22.10	36.50
8	4874.00	45.90 AV	54.00	-8.10	1.52 V	35	9.50	36.50
9	7311.00	51.30 PK	74.00	-22.70	1.80 V	30	9.50	41.80
9	7311.00	39.70 AV	54.00	-14.30	1.80 V	30	-2.10	41.80
10	9748.00	53.30 PK	74.00	-20.70	1.52 V	333	8.70	44.60
10	9748.00	41.60 AV	54.00	-12.40	1.52 V	333	-3.00	44.60

- NOTE:**
1. Emission level = Raw Value - Correction Factor
 2. Correction Factor = External Preamp. Gain - Ant. Factor - Cable loss
(External Preamp. Gain = 0, when the test receiver is used for the test.)
 3. The other emission levels were very low against the limit.
 4. Margin value = Emission level - Limit value
 5. The limit value is defined as per 15.247
 6. " * " : Fundamental frequency



EUT	Flanker Pro Single Radio AP	MODEL	AP-AG-AT-01
MODE	Channel 11	FREQUENCY RANGE	1000MHz~25000MHz
INPUT POWER (SYSTEM)	120Vac, 60Hz	DETECTOR FUNCTION	Peak(PK) Average (AV)
ENVIRONMENTAL CONDITIONS	17deg. C, 68%RH, 972 hPa	TESTED BY	Eric Lee

ANTENNA POLARITY & TEST DISTANCE: HORIZONTAL AT 3M

No.	Freq. (MHz)	Emission Level (dBuV/m)	Limit (dBuV/m)	Margin (dB)	Antenna Height (m)	Table Angle (Degree)	Raw Value (dBuV)	Correction Factor (dB/m)
1	2016.00	46.40 PK	74.00	-27.60	1.67 H	52	17.20	29.20
2	2320.00	36.70 PK	74.00	-37.30	1.11 H	5	6.50	30.20
3	2360.00	53.80 PK	74.00	-20.20	1.70 H	346	23.50	30.30
3	2360.00	43.20 AV	54.00	-10.80	1.70 H	346	12.80	30.30
4	*2462.00	72.50 PK			1.54 H	24	41.70	30.80
4	*2462.00	64.40 AV			1.54 H	24	33.60	30.80
5	2483.50	54.30 PK	74.00	-19.70	1.58 H	258	23.30	31.00
5	2483.50	45.30 AV	54.00	-8.70	1.58 H	258	14.30	31.00
6	2688.00	36.40 PK	74.00	-37.60	1.44 H	247	5.10	31.30
7	4924.00	50.90 PK	74.00	-23.10	1.92 H	345	14.20	36.70
8	7386.00	46.80 PK	74.00	-27.20	1.54 H	256	5.00	41.80
9	9848.00	48.90 PK	74.00	-25.10	1.59 H	55	4.60	44.40

- NOTE:**
1. Emission level= Raw Value - Correction Factor
 2. Correction Factor = External Preamp. Gain - Ant. Factor - Cable loss
(External Preamp. Gain = 0, when the test receiver is used for the test.)
 3. The other emission levels were very low against the limit.
 4. Margin value = Emission level - Limit value
 5. The limit value is defined as per 15.247
 6. " * " : Fundamental frequency



EUT	Flanker Pro Single Radio AP	MODEL	AP-AG-AT-01
MODE	Channel 11	FREQUENCY RANGE	1000MHz~25000MHz
INPUT POWER (SYSTEM)	120Vac, 60Hz	DETECTOR FUNCTION	Peak(PK) Average (AV)
ENVIRONMENTAL CONDITIONS	17deg. C, 68%RH, 972 hPa	TESTED BY	Eric Lee

ANTENNA POLARITY & TEST DISTANCE: VERTICAL AT 3M

No.	Freq. (MHz)	Emission Level (dBuV/m)	Limit (dBuV/m)	Margin (dB)	Antenna Height (m)	Table Angle (Degree)	Raw Value (dBuV)	Correction Factor (dB/m)
1	2016.00	50.20 PK	74.00	-23.80	1.02 V	24	20.90	29.20
2	2320.00	43.00 PK	74.00	-31.00	1.11 V	47	12.80	30.20
3	2360.00	43.20 PK	74.00	-30.80	1.86 V	324	12.90	30.30
4	*2462.00	112.10 PK			1.45 V	24	81.20	30.80
4	*2462.00	105.70 AV			1.45 V	24	74.90	30.80
5	2483.50	60.50 PK	74.00	-13.50	1.27 V	45	29.50	31.00
5	2483.50	49.90 AV	54.00	-4.10	1.27 V	45	19.00	31.00
6	2688.00	42.40 PK	74.00	-31.60	1.00 V	201	11.20	31.30
7	4924.00	58.80 PK	74.00	-15.20	1.45 V	23	22.10	36.70
7	4924.00	48.10 AV	54.00	-5.90	1.45 V	23	11.40	36.70
8	7386.00	51.20 PK	74.00	-22.80	1.87 V	241	9.40	41.80
8	7386.00	37.90 AV	54.00	-16.10	1.87 V	241	-3.90	41.80
9	9848.00	52.00 PK	74.00	-22.00	1.99 V	68	7.60	44.40
9	9848.00	40.00 AV	54.00	-14.00	1.99 V	68	-4.30	44.40

- NOTE:**
1. Emission level= Raw Value - Correction Factor
 2. Correction Factor = External Preamp. Gain - Ant. Factor - Cable loss
(External Preamp. Gain = 0, when the test receiver is used for the test.)
 3. The other emission levels were very low against the limit.
 4. Margin value = Emission level - Limit value
 5. The limit value is defined as per 15.247
 6. " * " : Fundamental frequency



4.2.10 TEST RESULTS - DSSS (ANTENNA 3)

EUT	Flanker Pro Single Radio AP	MODEL	AP-AG-AT-01
MODE	Channel 1	FREQUENCY RANGE	1000MHz~25000MHz
INPUT POWER (SYSTEM)	120Vac, 60Hz	DETECTOR FUNCTION	Peak(PK) Average (AV)
ENVIRONMENTAL CONDITIONS	17deg. C, 68%RH, 972 hPa	TESTED BY	Eric Lee

ANTENNA POLARITY & TEST DISTANCE: HORIZONTAL AT 3 M

No.	Freq. (MHz)	Emission Level (dBuV/m)	Limit (dBuV/m)	Margin (dB)	Antenna Height (m)	Table Angle (Degree)	Raw Value (dBuV)	Correction Factor (dB/m)
1	2016.00	42.10 PK	74.00	-31.90	1.02 H	24	12.90	29.20
2	2320.00	39.30 PK	74.00	-34.70	1.76 H	36	9.10	30.20
3	2360.00	34.20 PK	74.00	-39.80	1.32 H	65	3.80	30.30
4	2387.00	49.70 PK	74.00	-24.30	1.92 H	356	19.30	30.40
5	2390.00	49.00 PK	74.00	-25.00	1.07 H	44	18.50	30.40
6	*2412.00	104.70 PK			1.32 H	241	74.20	30.50
6	*2412.00	97.10 AV			1.32 H	241	66.50	30.50
7	2688.00	37.00 PK	74.00	-37.00	1.23 H	65	5.70	31.30
8	4824.00	44.40 PK	74.00	-29.60	1.33 H	6	8.20	36.20
9	7236.00	46.10 PK	74.00	-27.90	1.47 H	5	4.50	41.70
10	9648.00	47.50 PK	74.00	-26.50	1.11 H	6	2.60	44.90

ANTENNA POLARITY & TEST DISTANCE: VERTICAL AT 3 M

No.	Freq. (MHz)	Emission Level (dBuV/m)	Limit (dBuV/m)	Margin (dB)	Antenna Height (m)	Table Angle (Degree)	Raw Value (dBuV)	Correction Factor (dB/m)
1	2016.00	47.20 PK	74.00	-26.80	1.00 V	104	17.90	29.20
2	2320.00	46.30 PK	74.00	-27.70	1.08 V	54	16.10	30.20
3	2360.00	49.00 PK	74.00	-25.00	1.29 V	314	18.60	30.30
4	2387.00	48.00 PK	74.00	-26.00	1.11 V	4	17.60	30.40
5	*2412.00	107.60 PK			1.09 V	270	77.10	30.50
5	*2412.00	100.30 AV			1.09 V	270	69.80	30.50
6	2688.00	43.50 PK	74.00	-30.50	1.65 V	36	12.20	31.30
7	4824.00	48.30 PK	74.00	-25.70	1.54 V	74	12.10	36.20
8	7236.00	47.70 PK	74.00	-26.30	1.43 V	65	6.10	41.70
9	9648.00	49.30 PK	74.00	-24.70	1.42 V	24	4.40	44.90

- NOTE:**
1. Emission level = Raw Value - Correction Factor
 2. Correction Factor = External Preamp. Gain - Ant. Factor - Cable loss
(External Preamp. Gain = 0, when the test receiver is used for the test.)
 3. The other emission levels were very low against the limit.
 4. Margin value = Emission level - Limit value
 5. The limit value is defined as per 15.247
 6. " * " : Fundamental frequency



EUT	Flanker Pro Single Radio AP	MODEL	AP-AG-AT-01
MODE	Channel 6	FREQUENCY RANGE	1000MHz~25000MHz
INPUT POWER (SYSTEM)	120Vac, 60Hz	DETECTOR FUNCTION	Peak(PK) Average (AV)
ENVIRONMENTAL CONDITIONS	26deg. C, 67%RH, 972 hPa	TESTED BY	Eric Lee

ANTENNA POLARITY & TEST DISTANCE: HORIZONTAL AT 3 M

No.	Freq. (MHz)	Emission Level (dBuV/m)	Limit (dBuV/m)	Margin (dB)	Antenna Height (m)	Table Angle (Degree)	Raw Value (dBuV)	Correction Factor (dB/m)
1	2016.00	41.10 PK	74.00	-32.90	1.88 H	336	11.90	29.20
2	2320.00	40.70 PK	74.00	-33.30	1.10 H	2	10.50	30.20
3	2360.00	34.10 PK	74.00	-39.90	1.65 H	35	3.80	30.30
4	2390.00	51.70 PK	74.00	-22.30	1.02 H	39	21.20	30.40
4	2390.00	39.50 AV	54.00	-14.50	1.02 H	39	9.10	30.40
5	*2437.00	107.70 PK			1.47 H	5	77.00	30.70
5	*2437.00	99.30 AV			1.47 H	5	68.60	30.70
6	2483.50	46.60 PK	74.00	-27.40	1.54 H	24	15.60	31.00
7	2688.00	37.80 PK	74.00	-36.20	1.01 H	7	6.50	31.30
8	4874.00	41.90 PK	74.00	-32.10	1.54 H	74	5.50	36.50
9	7311.00	46.50 PK	74.00	-27.50	1.01 H	211	4.80	41.80
10	9748.00	48.10 PK	74.00	-25.90	1.12 H	54	3.40	44.60

ANTENNA POLARITY & TEST DISTANCE: VERTICAL AT 3 M

No.	Freq. (MHz)	Emission Level (dBuV/m)	Limit (dBuV/m)	Margin (dB)	Antenna Height (m)	Table Angle (Degree)	Raw Value (dBuV)	Correction Factor (dB/m)
1	2016.00	48.90 PK	74.00	-25.10	1.14 V	45	19.70	29.20
2	2320.00	47.30 PK	74.00	-26.70	1.25 V	32	17.10	30.20
3	2360.00	47.10 PK	74.00	-26.90	1.54 V	7	16.70	30.30
4	2390.00	61.20 PK	74.00	-12.80	1.23 V	30	30.80	30.40
4	2390.00	47.20 AV	54.00	-6.80	1.23 V	30	16.80	30.40
5	*2437.00	110.70 PK			1.10 V	265	80.00	30.70
5	*2437.00	101.90 AV			1.10 V	265	71.30	30.70
6	2483.50	57.40 PK	74.00	-16.60	1.54 V	7	26.50	31.00
6	2483.50	45.50 AV	54.00	-8.50	1.54 V	7	14.60	31.00
7	2688.00	44.10 PK	74.00	-29.90	1.13 V	7	12.90	31.30
8	4874.00	43.10 PK	74.00	-30.90	1.00 V	2	6.60	36.50
9	7311.00	48.20 PK	74.00	-25.80	1.40 V	35	6.40	41.80
10	9748.00	49.60 PK	74.00	-24.40	1.23 V	6	5.00	44.60

- NOTE:**
1. Emission level = Raw Value - Correction Factor
 2. Correction Factor = External Preamp. Gain - Ant. Factor - Cable loss
(External Preamp. Gain = 0, when the test receiver is used for the test.)
 3. The other emission levels were very low against the limit.
 4. Margin value = Emission level - Limit value
 5. The limit value is defined as per 15.247
 6. “ * “ : Fundamental frequency



EUT	Flanker Pro Single Radio AP	MODEL	AP-AG-AT-01
MODE	Channel 11	FREQUENCY RANGE	1000MHz~25000MHz
INPUT POWER (SYSTEM)	120Vac, 60Hz	DETECTOR FUNCTION	Peak(PK) Average (AV)
ENVIRONMENTAL CONDITIONS	17deg. C, 68%RH, 972 hPa	TESTED BY	Eric Lee

ANTENNA POLARITY & TEST DISTANCE: HORIZONTAL AT 3M

No.	Freq. (MHz)	Emission Level (dBuV/m)	Limit (dBuV/m)	Margin (dB)	Antenna Height (m)	Table Angle (Degree)	Raw Value (dBuV)	Correction Factor (dB/m)
1	2320.00	38.90 PK	74.00	-35.10	1.02 H	4	8.70	30.20
2	2360.00	42.60 PK	74.00	-31.40	1.40 H	2	12.30	30.30
3	*2462.00	107.90 PK			1.40 H	258	77.10	30.80
3	*2462.00	100.10 AV			1.40 H	258	69.20	30.80
4	2483.50	49.60 PK	74.00	-24.40	1.59 H	353	18.60	31.00
5	2688.00	37.50 PK	74.00	-36.50	1.36 H	69	6.20	31.30
6	4924.00	44.60 PK	74.00	-29.40	1.01 H	213	7.90	36.70
7	7386.00	48.30 PK	74.00	-25.70	1.36 H	69	6.50	41.80
8	9848.00	47.80 PK	74.00	-26.20	1.18 H	52	3.40	44.40

ANTENNA POLARITY & TEST DISTANCE: VERTICAL AT 3M

No.	Freq. (MHz)	Emission Level (dBuV/m)	Limit (dBuV/m)	Margin (dB)	Antenna Height (m)	Table Angle (Degree)	Raw Value (dBuV)	Correction Factor (dB/m)
1	2016.00	51.10 PK	74.00	-22.90	1.46 V	3	21.90	29.20
1	2016.00	45.40 AV	54.00	-8.60	1.46 V	3	16.20	29.20
2	2360.00	49.20 PK	74.00	-24.80	1.11 V	2	18.80	30.30
3	2462.00	110.20 PK	74.00	36.20	1.65 V	254	79.40	30.80
3	2462.00	102.10 AV	54.00	48.10	1.65 V	254	71.20	30.80
4	2483.50	54.20 PK	74.00	-19.80	1.21 V	24	23.30	31.00
4	2483.50	44.20 AV	54.00	-9.80	1.21 V	24	13.30	31.00
5	2688.00	43.80 PK	74.00	-30.20	1.12 V	3	12.50	31.30
6	4924.00	49.60 PK	74.00	-24.40	1.76 V	323	12.90	36.70
7	7386.00	48.60 PK	74.00	-25.40	1.10 V	20	6.80	41.80
8	9848.00	52.00 PK	74.00	-22.00	1.32 V	32	7.60	44.40
8	9848.00	40.00 AV	54.00	-14.00	1.32 V	32	-4.40	44.40

- NOTE:**
1. Emission level= Raw Value - Correction Factor
 2. Correction Factor = External Preamp. Gain - Ant. Factor - Cable loss
(External Preamp. Gain = 0, when the test receiver is used for the test.)
 3. The other emission levels were very low against the limit.
 4. Margin value = Emission level - Limit value
 5. The limit value is defined as per 15.247
 6. " * " : Fundamental frequency



4.2.11 TEST RESULTS - DSSS (ANTENNA 4)

EUT	Flanker Pro Single Radio AP	MODEL	AP-AG-AT-01
MODE	Channel 1	FREQUENCY RANGE	1000MHz~25000MHz
INPUT POWER (SYSTEM)	120Vac, 60Hz	DETECTOR FUNCTION	Peak(PK) Average (AV)
ENVIRONMENTAL CONDITIONS	17deg. C, 68%RH, 972 hPa	TESTED BY	Eric Lee

ANTENNA POLARITY & TEST DISTANCE: HORIZONTAL AT 3 M

No.	Freq. (MHz)	Emission Level (dBuV/m)	Limit (dBuV/m)	Margin (dB)	Antenna Height (m)	Table Angle (Degree)	Raw Value (dBuV)	Correction Factor (dB/m)
1	2016.00	42.30 PK	74.00	-31.70	1.85 H	25	13.10	29.20
2	2292.00	40.20 PK	74.00	-33.80	1.06 H	32	10.10	30.10
3	2360.00	47.00 PK	74.00	-27.00	1.02 H	21	16.70	30.30
4	2390.00	56.70 PK	74.00	-17.30	1.26 H	9	26.30	30.40
4	2390.00	45.70 AV	54.00	-8.30	1.26 H	9	15.30	30.40
5	*2412.00	108.80 PK			1.32 H	205	78.20	30.50
5	*2412.00	100.70 AV			1.32 H	205	70.20	30.50
6	4824.00	44.50 PK	74.00	-29.50	1.02 H	56	8.30	36.20
7	7236.00	46.80 PK	74.00	-27.20	1.05 H	25	5.20	41.70
8	9648.00	47.10 PK	74.00	-26.90	1.02 H	333	2.20	44.90

ANTENNA POLARITY & TEST DISTANCE: VERTICAL AT 3 M

No.	Freq. (MHz)	Emission Level (dBuV/m)	Limit (dBuV/m)	Margin (dB)	Antenna Height (m)	Table Angle (Degree)	Raw Value (dBuV)	Correction Factor (dB/m)
1	2016.00	46.50 PK	74.00	-27.50	1.53 V	154	17.30	29.20
2	2292.00	45.80 PK	74.00	-28.20	1.21 V	23	15.70	30.10
3	2360.00	58.10 PK	74.00	-15.90	1.32 V	10	27.70	30.30
3	2360.00	45.40 AV	54.00	-8.60	1.32 V	10	15.10	30.30
4	2390.00	63.70 PK	74.00	-10.30	1.54 V	24	33.20	30.40
4	2390.00	52.40 AV	54.00	-1.60	1.54 V	24	22.00	30.40
5	*2412.00	114.00 PK			1.22 V	30	83.50	30.50
5	*2412.00	107.80 AV			1.22 V	30	77.20	30.50
6	4824.00	53.20 PK	74.00	-20.80	1.12 V	1	17.00	36.20
6	4824.00	43.00 AV	54.00	-11.00	1.12 V	1	6.80	36.20
7	7236.00	46.80 PK	74.00	-27.20	1.42 V	32	5.10	41.70
8	9648.00	49.70 PK	74.00	-24.30	1.13 V	1	4.80	44.90

- NOTE:**
1. Emission level = Raw Value - Correction Factor
 2. Correction Factor = External Preamp. Gain - Ant. Factor - Cable loss
(External Preamp. Gain = 0, when the test receiver is used for the test.)
 3. The other emission levels were very low against the limit.
 4. Margin value = Emission level - Limit value
 5. The limit value is defined as per 15.247
 6. " * " : Fundamental frequency



EUT	Flanker Pro Single Radio AP	MODEL	AP-AG-AT-01
MODE	Channel 6	FREQUENCY RANGE	1000MHz~25000MHz
INPUT POWER (SYSTEM)	120Vac, 60Hz	DETECTOR FUNCTION	Peak(PK) Average (AV)
ENVIRONMENTAL CONDITIONS	26deg. C, 67%RH, 972 hPa	TESTED BY	Eric Lee

ANTENNA POLARITY & TEST DISTANCE: HORIZONTAL AT 3 M

No.	Freq. (MHz)	Emission Level (dBuV/m)	Limit (dBuV/m)	Margin (dB)	Antenna Height (m)	Table Angle (Degree)	Raw Value (dBuV)	Correction Factor (dB/m)
1	2016.00	46.10 PK	74.00	-27.90	1.22 H	202	16.90	29.20
2	2356.00	48.20 PK	74.00	-25.80	1.11 H	231	17.90	30.30
3	2360.00	50.10 PK	74.00	-23.90	1.09 H	3	19.80	30.30
4	2390.00	51.20 PK	74.00	-22.80	1.32 H	6	20.80	30.40
4	2390.00	40.50 AV	54.00	-13.50	1.32 H	6	10.10	30.40
5	*2437.00	111.90 PK			1.54 H	2	81.20	30.70
5	*2437.00	102.80 AV			1.54 H	2	72.10	30.70
6	2483.50	51.60 PK	74.00	-22.40	1.47 H	24	20.60	31.00
6	2483.50	42.90 AV	54.00	-11.10	1.47 H	24	11.90	31.00
7	4874.00	43.00 PK	74.00	-31.00	1.63 H	326	6.60	36.50
8	7311.00	48.10 PK	74.00	-25.90	1.80 H	205	6.40	41.80
9	9748.00	49.20 PK	74.00	-24.80	1.23 H	36	4.60	44.60

- NOTE:**
1. Emission level = Raw Value - Correction Factor
 2. Correction Factor = External Preamp. Gain - Ant. Factor - Cable loss
(External Preamp. Gain = 0, when the test receiver is used for the test.)
 3. The other emission levels were very low against the limit.
 4. Margin value = Emission level - Limit value
 5. The limit value is defined as per 15.247
 6. " * " : Fundamental frequency



EUT	Flanker Pro Single Radio AP	MODEL	AP-AG-AT-01
MODE	Channel 6	FREQUENCY RANGE	1000MHz~25000MHz
INPUT POWER (SYSTEM)	120Vac, 60Hz	DETECTOR FUNCTION	Peak(PK) Average (AV)
ENVIRONMENTAL CONDITIONS	26deg. C, 67%RH, 972 hPa	TESTED BY	Eric Lee

ANTENNA POLARITY & TEST DISTANCE: VERTICAL AT 3 M

No.	Freq. (MHz)	Emission Level (dBuV/m)	Limit (dBuV/m)	Margin (dB)	Antenna Height (m)	Table Angle (Degree)	Raw Value (dBuV)	Correction Factor (dB/m)
1	2016.00	49.60 PK	74.00	-24.40	1.21 V	3	20.40	29.20
2	2356.00	55.60 PK	74.00	-18.40	1.14 V	54	25.20	30.30
2	2356.00	47.40 AV	54.00	-6.60	1.14 V	54	17.10	30.30
3	2360.00	62.40 PK	74.00	-11.60	1.85 V	25	32.10	30.30
3	2360.00	49.20 AV	54.00	-4.80	1.85 V	25	18.80	30.30
4	2390.00	62.90 PK	74.00	-11.10	1.02 V	24	32.50	30.40
4	2390.00	51.10 AV	54.00	-2.90	1.02 V	24	20.70	30.40
5	*2437.00	117.90 PK			1.54 V	74	87.20	30.70
5	*2437.00	109.90 AV			1.54 V	74	79.20	30.70
6	2483.50	58.60 PK	74.00	-15.40	1.65 V	3	27.70	31.00
6	2483.50	49.50 AV	54.00	-4.50	1.65 V	3	18.60	31.00
7	4874.00	60.30 PK	74.00	-13.70	1.24 V	1	23.80	36.50
7	4874.00	48.20 AV	54.00	-5.80	1.24 V	1	11.80	36.50
8	7311.00	49.60 PK	74.00	-24.40	1.14 V	0	7.90	41.80
9	9748.00	51.60 PK	74.00	-22.40	1.18 V	128	7.00	44.60
9	9748.00	43.60 AV	54.00	-10.40	1.18 V	128	-1.00	44.60

- NOTE:**
1. Emission level = Raw Value - Correction Factor
 2. Correction Factor = External Preamp. Gain - Ant. Factor - Cable loss
(External Preamp. Gain = 0, when the test receiver is used for the test.)
 3. The other emission levels were very low against the limit.
 4. Margin value = Emission level - Limit value
 5. The limit value is defined as per 15.247
 6. “ * “ : Fundamental frequency



EUT	Flanker Pro Single Radio AP	MODEL	AP-AG-AT-01
MODE	Channel 11	FREQUENCY RANGE	1000MHz~25000MHz
INPUT POWER (SYSTEM)	120Vac, 60Hz	DETECTOR FUNCTION	Peak(PK) Average (AV)
ENVIRONMENTAL CONDITIONS	17deg. C, 68%RH, 972 hPa	TESTED BY	Eric Lee

ANTENNA POLARITY & TEST DISTANCE: HORIZONTAL AT 3M

No.	Freq. (MHz)	Emission Level (dBuV/m)	Limit (dBuV/m)	Margin (dB)	Antenna Height (m)	Table Angle (Degree)	Raw Value (dBuV)	Correction Factor (dB/m)
1	2016.00	42.40 PK	74.00	-31.60	1.54 H	258	13.10	29.20
2	2360.00	46.10 PK	74.00	-27.90	1.54 H	241	15.70	30.30
3	*2462.00	108.50 PK			1.65 H	241	77.60	30.80
3	*2462.00	102.90 AV			1.65 H	241	72.10	30.80
4	2483.50	52.20 PK	74.00	-21.80	1.65 H	36	21.30	31.00
4	2483.50	46.30 AV	54.00	-7.70	1.65 H	36	15.40	31.00
5	4924.00	44.70 PK	74.00	-29.30	1.02 H	2	8.00	36.70
6	7386.00	47.30 PK	74.00	-26.70	1.87 H	5	5.50	41.80
7	9848.00	49.30 PK	74.00	-24.70	1.02 H	326	4.90	44.40

ANTENNA POLARITY & TEST DISTANCE: VERTICAL AT 3M

No.	Freq. (MHz)	Emission Level (dBuV/m)	Limit (dBuV/m)	Margin (dB)	Antenna Height (m)	Table Angle (Degree)	Raw Value (dBuV)	Correction Factor (dB/m)
1	2016.00	49.30 PK	74.00	-24.70	1.54 V	22	20.10	29.20
2	2360.00	52.30 PK	74.00	-21.70	1.54 V	204	21.90	30.30
2	2360.00	43.40 AV	54.00	-10.60	1.54 V	204	13.00	30.30
3	*2462.00	114.90 PK			1.25 V	23	84.10	30.80
3	*2462.00	109.00 AV			1.25 V	23	78.20	30.80
4	2483.50	60.20 PK	74.00	-13.80	1.35 V	33	29.30	31.00
4	2483.50	52.50 AV	54.00	-1.50	1.35 V	33	21.50	31.00
5	4924.00	49.60 PK	74.00	-24.40	1.54 V	359	12.90	36.70
6	7386.00	51.00 PK	74.00	-23.00	1.66 V	33	9.10	41.80
6	7386.00	39.20 AV	54.00	-14.80	1.66 V	33	-2.70	41.80
7	9848.00	50.00 PK	74.00	-24.00	1.40 V	21	5.60	44.40

- NOTE:**
1. Emission level= Raw Value - Correction Factor
 2. Correction Factor = External Preamp. Gain - Ant. Factor - Cable loss
(External Preamp. Gain = 0, when the test receiver is used for the test.)
 3. The other emission levels were very low against the limit.
 4. Margin value = Emission level - Limit value
 5. The limit value is defined as per 15.247
 6. " * " : Fundamental frequency



4.2.12 TEST RESULTS - DSSS (ANTENNA 5)

EUT	Flanker Pro Single Radio AP	MODEL	AP-AG-AT-01
MODE	Channel 1	FREQUENCY RANGE	1000MHz~25000MHz
INPUT POWER (SYSTEM)	120Vac, 60Hz	DETECTOR FUNCTION	Peak(PK) Average (AV)
ENVIRONMENTAL CONDITIONS	17deg. C, 68%RH, 972 hPa	TESTED BY	Eric Lee

ANTENNA POLARITY & TEST DISTANCE: HORIZONTAL AT 3 M

No.	Freq. (MHz)	Emission Level (dBuV/m)	Limit (dBuV/m)	Margin (dB)	Antenna Height (m)	Table Angle (Degree)	Raw Value (dBuV)	Correction Factor (dB/m)
1	2016.00	35.20 PK	74.00	-38.80	1.25 H	342	6.00	29.20
2	2280.00	34.80 PK	74.00	-39.20	1.18 H	344	4.70	30.10
3	2360.00	37.70 PK	74.00	-36.30	1.16 H	346	7.30	30.30
4	2390.00	39.90 PK	74.00	-34.10	1.30 H	214	9.50	30.40
5	*2412.00	83.40 PK			1.36 H	320	52.90	30.50
5	*2412.00	77.10 AV			1.36 H	320	46.50	30.50
6	4824.00	40.90 PK	74.00	-33.10	1.02 H	4	4.70	36.20
7	7236.00	46.00 PK	74.00	-28.00	1.21 H	360	4.30	41.70
8	9648.00	48.60 PK	74.00	-25.40	1.19 H	350	3.70	44.90

ANTENNA POLARITY & TEST DISTANCE: VERTICAL AT 3 M

No.	Freq. (MHz)	Emission Level (dBuV/m)	Limit (dBuV/m)	Margin (dB)	Antenna Height (m)	Table Angle (Degree)	Raw Value (dBuV)	Correction Factor (dB/m)
1	2016.00	42.50 PK	74.00	-31.50	1.00 V	356	13.30	29.20
2	2280.00	44.80 PK	74.00	-29.20	1.00 V	2	14.70	30.10
3	2360.00	57.90 PK	74.00	-16.10	1.16 V	360	27.60	30.30
3	2360.00	49.00 AV	54.00	-5.00	1.16 V	360	18.70	30.30
4	2390.00	60.40 PK	74.00	-13.60	1.00 V	239	30.00	30.40
4	2390.00	51.40 AV	54.00	-2.60	1.00 V	239	20.90	30.40
5	*2412.00	111.00 PK			1.00 V	360	80.40	30.50
5	*2412.00	104.30 AV			1.00 V	360	73.80	30.50
6	4824.00	43.70 PK	74.00	-30.30	1.00 V	360	7.50	36.20
7	7236.00	46.40 PK	74.00	-27.60	1.00 V	351	4.80	41.70
8	9236.00	47.70 PK	74.00	-26.30	1.00 V	329	2.90	44.90

- NOTE:**
1. Emission level = Raw Value - Correction Factor
 2. Correction Factor = External Preamp. Gain - Ant. Factor - Cable loss
(External Preamp. Gain = 0, when the test receiver is used for the test.)
 3. The other emission levels were very low against the limit.
 4. Margin value = Emission level - Limit value
 5. The limit value is defined as per 15.247
 6. " * " : Fundamental frequency



EUT	Flanker Pro Single Radio AP	MODEL	AP-AG-AT-01
MODE	Channel 6	FREQUENCY RANGE	1000MHz~25000MHz
INPUT POWER (SYSTEM)	120Vac, 60Hz	DETECTOR FUNCTION	Peak(PK) Average (AV)
ENVIRONMENTAL CONDITIONS	26deg. C, 67%RH, 972 hPa	TESTED BY	Eric Lee

ANTENNA POLARITY & TEST DISTANCE: HORIZONTAL AT 3 M

No.	Freq. (MHz)	Emission Level (dBuV/m)	Limit (dBuV/m)	Margin (dB)	Antenna Height (m)	Table Angle (Degree)	Raw Value (dBuV)	Correction Factor (dB/m)
1	2016.00	36.70 PK	74.00	-37.30	1.36 H	335	7.50	29.20
2	2280.00	35.10 PK	74.00	-38.90	1.00 H	360	5.10	30.10
3	2375.00	45.50 PK	74.00	-28.50	1.13 H	349	15.10	30.40
4	*2437.00	90.70 PK			1.17 H	353	60.00	30.70
4	*2437.00	83.80 AV			1.17 H	353	53.20	30.70
5	2494.00	38.80 PK	74.00	-35.20	1.17 H	357	8.00	30.80
6	4874.00	44.30 PK	74.00	-29.70	1.21 H	360	7.90	36.50
7	7311.00	47.50 PK	74.00	-26.50	1.16 H	350	5.70	41.80
8	9748.00	46.70 PK	74.00	-27.30	1.00 H	358	2.10	44.60

ANTENNA POLARITY & TEST DISTANCE: VERTICAL AT 3 M

No.	Freq. (MHz)	Emission Level (dBuV/m)	Limit (dBuV/m)	Margin (dB)	Antenna Height (m)	Table Angle (Degree)	Raw Value (dBuV)	Correction Factor (dB/m)
1	2016.00	42.70 PK	74.00	-31.30	1.00 V	360	13.50	29.20
2	2292.00	48.80 PK	74.00	-25.20	1.00 V	360	18.70	30.10
3	2360.00	61.40 PK	74.00	-12.60	1.00 V	360	31.00	30.30
3	2360.00	51.30 AV	54.00	-2.70	1.00 V	360	21.00	30.30
4	2390.00	63.30 PK	74.00	-10.70	1.00 V	360	32.80	30.40
4	2390.00	52.30 AV	54.00	-1.70	1.00 V	360	21.80	30.40
5	*2437.00	115.70 PK			1.00 V	3	85.10	30.70
5	*2437.00	108.60 AV			1.00 V	3	77.90	30.70
6	2494.00	52.10 PK	74.00	-21.90	1.12 V	3	21.30	30.80
6	2494.00	43.90 AV	54.00	-10.10	1.12 V	3	13.20	30.80
7	4874.00	52.50 PK	74.00	-21.50	1.00 V	2	16.00	36.50
7	4874.00	41.40 AV	54.00	-12.60	1.00 V	2	5.00	36.50
8	7311.00	48.00 PK	74.00	-26.00	1.02 V	6	6.20	41.80
9	9748.00	49.10 PK	74.00	-24.90	1.15 V	18	4.50	44.60

- NOTE:**
1. Emission level = Raw Value - Correction Factor
 2. Correction Factor = External Preamp. Gain - Ant. Factor - Cable loss
(External Preamp. Gain = 0, when the test receiver is used for the test.)
 3. The other emission levels were very low against the limit.
 4. Margin value = Emission level - Limit value
 5. The limit value is defined as per 15.247
 6. " * " : Fundamental frequency



EUT	Flanker Pro Single Radio AP	MODEL	AP-AG-AT-01
MODE	Channel 11	FREQUENCY RANGE	1000MHz~25000MHz
INPUT POWER (SYSTEM)	120Vac, 60Hz	DETECTOR FUNCTION	Peak(PK) Average (AV)
ENVIRONMENTAL CONDITIONS	17deg. C, 68%RH, 972 hPa	TESTED BY	Eric Lee

ANTENNA POLARITY & TEST DISTANCE: HORIZONTAL AT 3M

No.	Freq. (MHz)	Emission Level (dBuV/m)	Limit (dBuV/m)	Margin (dB)	Antenna Height (m)	Table Angle (Degree)	Raw Value (dBuV)	Correction Factor (dB/m)
1	2016.00	33.80 PK	74.00	-40.20	1.10 H	342	4.60	29.20
2	2280.00	34.10 PK	74.00	-39.90	1.18 H	338	4.10	30.10
3	2360.00	38.20 PK	74.00	-35.80	1.15 H	345	7.80	30.30
4	*2462.00	92.60 PK			1.25 H	35	61.70	30.80
4	*2462.00	86.40 AV			1.25 H	35	55.60	30.80
5	2483.50	48.30 PK	74.00	-25.70	1.20 H	20	17.30	31.00
6	4924.00	42.70 PK	74.00	-31.30	1.17 H	87	6.00	36.70
7	7386.00	47.90 PK	74.00	-26.10	1.11 H	27	6.10	41.80
8	9848.00	48.70 PK	74.00	-25.30	1.11 H	24	4.30	44.40

ANTENNA POLARITY & TEST DISTANCE: VERTICAL AT 3M

No.	Freq. (MHz)	Emission Level (dBuV/m)	Limit (dBuV/m)	Margin (dB)	Antenna Height (m)	Table Angle (Degree)	Raw Value (dBuV)	Correction Factor (dB/m)
1	2016.00	44.90 PK	74.00	-29.10	1.02 V	2	15.70	29.20
2	2280.00	47.80 PK	74.00	-26.20	1.04 V	6	17.70	30.10
3	2360.00	63.10 PK	74.00	-10.90	1.06 V	0	32.80	30.30
3	2360.00	52.80 AV	54.00	-1.20	1.06 V	0	22.50	30.30
4	2378.00	64.20 PK	74.00	-9.80	1.15 V	3	33.80	30.40
4	2378.00	53.20 AV	54.00	-0.80	1.15 V	3	22.80	30.40
5	*2462.00	116.70 PK			1.06 V	360	85.80	30.80
5	*2462.00	109.60 AV			1.06 V	360	78.70	30.80
6	2483.50	61.40 PK	74.00	-12.60	1.06 V	354	30.40	31.00
6	2483.50	52.80 AV	54.00	-1.20	1.06 V	354	21.80	31.00
7	4924.00	53.20 PK	74.00	-20.80	1.00 V	0	16.60	36.70
7	4924.00	41.40 AV	54.00	-12.60	1.00 V	0	4.80	36.70
8	7386.00	46.80 PK	74.00	-27.20	1.04 V	9	5.00	41.80
9	9848.00	48.20 PK	74.00	-25.80	1.02 V	24	3.90	44.40

- NOTE:**
1. Emission level= Raw Value - Correction Factor
 2. Correction Factor = External Preamp. Gain - Ant. Factor - Cable loss
(External Preamp. Gain = 0, when the test receiver is used for the test.)
 3. The other emission levels were very low against the limit.
 4. Margin value = Emission level - Limit value
 5. The limit value is defined as per 15.247
 6. " * " : Fundamental frequency



4.2.13 TEST RESULTS - DSSS (ANTENNA 6)

EUT	Flanker Pro Single Radio AP	MODEL	AP-AG-AT-01
MODE	Channel 1	FREQUENCY RANGE	1000MHz~25000MHz
INPUT POWER (SYSTEM)	120Vac, 60Hz	DETECTOR FUNCTION	Peak(PK) Average (AV)
ENVIRONMENTAL CONDITIONS	17deg. C, 68%RH, 972 hPa	TESTED BY	Eric Lee

ANTENNA POLARITY & TEST DISTANCE: HORIZONTAL AT 3 M

No.	Freq. (MHz)	Emission Level (dBuV/m)	Limit (dBuV/m)	Margin (dB)	Antenna Height (m)	Table Angle (Degree)	Raw Value (dBuV)	Correction Factor (dB/m)
1	2016.00	33.10 PK	74.00	-40.90	1.11 H	52	3.90	29.20
2	2292.00	35.20 PK	74.00	-38.80	1.52 H	201	5.00	30.10
3	2360.00	43.50 PK	74.00	-30.50	1.10 H	0	13.20	30.30
4	2387.00	43.60 PK	74.00	-30.40	1.30 H	2	13.20	30.40
5	2390.00	46.70 PK	74.00	-27.30	1.42 H	1	16.30	30.40
6	*2412.00	92.70 PK			1.54 H	24	62.10	30.50
6	*2412.00	84.80 AV			1.54 H	24	54.20	30.50
7	4824.00	37.80 PK	74.00	-36.20	1.32 H	241	1.50	36.20
8	7236.00	47.10 PK	74.00	-26.90	1.12 H	36	5.50	41.70
9	9648.00	47.10 PK	74.00	-26.90	1.40 H	357	2.20	44.90

ANTENNA POLARITY & TEST DISTANCE: VERTICAL AT 3 M

No.	Freq. (MHz)	Emission Level (dBuV/m)	Limit (dBuV/m)	Margin (dB)	Antenna Height (m)	Table Angle (Degree)	Raw Value (dBuV)	Correction Factor (dB/m)
1	2016.00	37.50 PK	74.00	-36.50	1.13 V	4	8.20	29.20
2	2292.00	47.80 PK	74.00	-26.20	1.04 V	6	17.70	30.10
3	2360.00	54.80 PK	74.00	-19.20	1.13 V	2	24.50	30.30
3	2360.00	47.10 AV	54.00	-6.90	1.13 V	2	16.80	30.30
4	2387.00	58.90 PK	74.00	-15.10	1.02 V	1	28.50	30.40
4	2387.00	49.70 AV	54.00	-4.30	1.02 V	1	19.30	30.40
5	2390.00	63.00 PK	74.00	-11.00	1.54 V	74	32.60	30.40
5	2390.00	52.00 AV	54.00	-2.00	1.54 V	74	21.60	30.40
6	*2412.00	112.50 PK			1.20 V	1	82.00	30.50
6	*2412.00	105.50 AV			1.20 V	1	74.90	30.50
7	4824.00	46.80 PK	74.00	-27.20	1.59 V	3	10.60	36.20
8	7236.00	50.10 PK	74.00	-23.90	1.04 V	54	8.40	41.70
9	9648.00	49.20 PK	74.00	-24.80	1.00 V	29	4.30	44.90

- NOTE:**
1. Emission level = Raw Value - Correction Factor
 2. Correction Factor = External Preamp. Gain - Ant. Factor - Cable loss
(External Preamp. Gain = 0, when the test receiver is used for the test.)
 3. The other emission levels were very low against the limit.
 4. Margin value = Emission level - Limit value
 5. The limit value is defined as per 15.247
 6. " * " : Fundamental frequency



EUT	Flanker Pro Single Radio AP	MODEL	AP-AG-AT-01
MODE	Channel 6	FREQUENCY RANGE	1000MHz~25000MHz
INPUT POWER (SYSTEM)	120Vac, 60Hz	DETECTOR FUNCTION	Peak(PK) Average (AV)
ENVIRONMENTAL CONDITIONS	26deg. C, 67%RH, 972 hPa	TESTED BY	Eric Lee

ANTENNA POLARITY & TEST DISTANCE: HORIZONTAL AT 3 M

No.	Freq. (MHz)	Emission Level (dBuV/m)	Limit (dBuV/m)	Margin (dB)	Antenna Height (m)	Table Angle (Degree)	Raw Value (dBuV)	Correction Factor (dB/m)
1	2016.00	34.60 PK	74.00	-39.40	1.47 H	5	5.40	29.20
2	2292.00	35.20 PK	74.00	-38.80	1.17 H	354	5.10	30.10
3	2360.00	46.40 PK	74.00	-27.60	1.44 H	14	16.10	30.30
4	2390.00	42.80 PK	74.00	-31.20	1.02 H	3	12.40	30.40
5	*2437.00	98.70 PK			1.01 H	1	68.00	30.70
5	*2437.00	90.90 AV			1.01 H	1	60.20	30.70
6	2483.50	43.30 PK	74.00	-30.70	1.01 H	359	12.40	31.00
7	4874.00	42.00 PK	74.00	-32.00	1.52 H	32	5.50	36.50
8	7311.00	44.10 PK	74.00	-29.90	1.11 H	10	2.40	41.80
9	9748.00	48.60 PK	74.00	-25.40	1.54 H	2	4.00	44.60

ANTENNA POLARITY & TEST DISTANCE: VERTICAL AT 3 M

No.	Freq. (MHz)	Emission Level (dBuV/m)	Limit (dBuV/m)	Margin (dB)	Antenna Height (m)	Table Angle (Degree)	Raw Value (dBuV)	Correction Factor (dB/m)
1	2016.00	35.70 PK	74.00	-38.30	1.11 V	2	6.40	29.20
2	2292.00	47.60 PK	74.00	-26.40	1.10 V	360	17.50	30.10
3	2360.00	61.30 PK	74.00	-12.70	1.01 V	20	30.90	30.30
3	2360.00	50.80 AV	54.00	-3.20	1.01 V	20	20.50	30.30
4	2390.00	57.10 PK	74.00	-16.90	1.60 V	20	26.70	30.40
4	2390.00	48.20 AV	54.00	-5.80	1.60 V	20	17.80	30.40
5	*2437.00	118.80 PK			1.62 V	3	88.20	30.70
5	*2437.00	110.70 AV			1.62 V	3	80.00	30.70
6	2483.50	57.90 PK	74.00	-16.10	1.63 V	1	26.90	31.00
6	2483.50	48.60 AV	54.00	-5.40	1.63 V	1	17.60	31.00
7	4874.00	52.80 PK	74.00	-21.20	1.20 V	4	16.40	36.50
7	4874.00	40.40 AV	54.00	-13.60	1.20 V	4	4.00	36.50
8	7311.00	48.80 PK	74.00	-25.20	1.52 V	4	7.00	41.80
9	9748.00	48.60 PK	74.00	-25.40	1.38 V	54	4.00	44.60

- NOTE:**
1. Emission level = Raw Value - Correction Factor
 2. Correction Factor = External Preamp. Gain - Ant. Factor - Cable loss
(External Preamp. Gain = 0, when the test receiver is used for the test.)
 3. The other emission levels were very low against the limit.
 4. Margin value = Emission level - Limit value
 5. The limit value is defined as per 15.247
 6. " * " : Fundamental frequency



EUT	Flanker Pro Single Radio AP	MODEL	AP-AG-AT-01
MODE	Channel 11	FREQUENCY RANGE	1000MHz~25000MHz
INPUT POWER (SYSTEM)	120Vac, 60Hz	DETECTOR FUNCTION	Peak(PK) Average (AV)
ENVIRONMENTAL CONDITIONS	17deg. C, 68%RH, 972 hPa	TESTED BY	Eric Lee

ANTENNA POLARITY & TEST DISTANCE: HORIZONTAL AT 3M

No.	Freq. (MHz)	Emission Level (dBuV/m)	Limit (dBuV/m)	Margin (dB)	Antenna Height (m)	Table Angle (Degree)	Raw Value (dBuV)	Correction Factor (dB/m)
1	2016.00	29.10 PK	74.00	-44.90	1.02 H	8	-0.10	29.20
2	2292.00	37.20 PK	74.00	-36.80	1.02 H	3	7.10	30.10
3	2360.00	42.80 PK	74.00	-31.20	1.11 H	356	12.50	30.30
4	*2462.00	96.10 PK			1.14 H	74	65.30	30.80
4	*2462.00	88.10 AV			1.14 H	74	57.20	30.80
5	2483.50	49.50 PK	74.00	-24.50	1.54 H	24	18.50	31.00
6	4924.00	42.20 PK	74.00	-31.80	1.10 H	20	5.50	36.70
7	7386.00	44.30 PK	74.00	-29.70	1.20 H	208	2.50	41.80
8	9848.00	49.50 PK	74.00	-24.50	1.54 H	20	5.10	44.40

ANTENNA POLARITY & TEST DISTANCE: VERTICAL AT 3M

No.	Freq. (MHz)	Emission Level (dBuV/m)	Limit (dBuV/m)	Margin (dB)	Antenna Height (m)	Table Angle (Degree)	Raw Value (dBuV)	Correction Factor (dB/m)
1	2016.00	40.10 PK	74.00	-33.90	1.02 V	17	10.90	29.20
2	2292.00	47.80 PK	74.00	-26.20	1.07 V	2	17.70	30.10
3	2360.00	61.30 PK	74.00	-12.70	1.18 V	1	31.00	30.30
3	2360.00	50.60 AV	54.00	-3.40	1.18 V	1	20.30	30.30
4	*2462.00	115.10 PK			1.02 V	3	84.30	30.80
4	*2462.00	108.10 AV			1.02 V	3	77.30	30.80
5	2483.50	63.40 PK	74.00	-10.60	1.02 V	4	32.50	31.00
5	2483.50	52.80 AV	54.00	-1.20	1.02 V	4	21.80	31.00
6	4924.00	48.80 PK	74.00	-25.20	1.47 V	52	12.10	36.70
7	7386.00	49.20 PK	74.00	-24.80	1.32 V	6	7.40	41.80
8	9848.00	48.40 PK	74.00	-25.60	1.54 V	24	4.00	44.40

- NOTE:**
1. Emission level= Raw Value - Correction Factor
 2. Correction Factor = External Preamp. Gain - Ant. Factor - Cable loss
(External Preamp. Gain = 0, when the test receiver is used for the test.)
 3. The other emission levels were very low against the limit.
 4. Margin value = Emission level - Limit value
 5. The limit value is defined as per 15.247
 6. " * " : Fundamental frequency



4.2.14 TEST RESULTS - DSSS (ANTENNA 7)

EUT	Flanker Pro Single Radio AP	MODEL	AP-AG-AT-01
MODE	Channel 3	FREQUENCY RANGE	1000MHz~25000MHz
INPUT POWER (SYSTEM)	120Vac, 60Hz	DETECTOR FUNCTION	Peak(PK) Average (AV)
ENVIRONMENTAL CONDITIONS	17deg. C, 68%RH, 972 hPa	TESTED BY	Eric Lee

ANTENNA POLARITY & TEST DISTANCE: HORIZONTAL AT 3 M

No.	Freq. (MHz)	Emission Level (dBuV/m)	Limit (dBuV/m)	Margin (dB)	Antenna Height (m)	Table Angle (Degree)	Raw Value (dBuV)	Correction Factor (dB/m)
1	2016.00	34.00 PK	74.00	-40.00	1.10 H	57	4.80	29.20
2	2282.00	37.10 PK	74.00	-36.90	1.27 H	127	7.00	30.10
3	2292.00	36.20 PK	74.00	-37.80	1.27 H	179	6.10	30.10
4	2360.00	43.00 PK	74.00	-31.00	1.30 H	312	12.70	30.30
5	2390.00	37.80 PK	74.00	-36.20	1.14 H	37	7.40	30.40
6	*2422.00	93.40 PK			1.14 H	53	62.80	30.60
6	*2422.00	86.30 AV			1.14 H	53	55.80	30.60
7	4844.00	42.60 PK	74.00	-31.40	1.18 H	128	6.20	36.30
8	7266.00	48.00 PK	74.00	-26.00	1.15 H	149	6.30	41.70
9	9688.00	47.60 PK	74.00	-26.40	1.23 H	171	2.80	44.80

ANTENNA POLARITY & TEST DISTANCE: VERTICAL AT 3 M

No.	Freq. (MHz)	Emission Level (dBuV/m)	Limit (dBuV/m)	Margin (dB)	Antenna Height (m)	Table Angle (Degree)	Raw Value (dBuV)	Correction Factor (dB/m)
1	2016.00	47.40 PK	74.00	-26.60	1.10 V	174	18.10	29.20
2	2282.00	49.90 PK	74.00	-24.10	1.14 V	175	19.80	30.10
3	2292.00	49.40 PK	74.00	-24.60	1.14 V	145	19.30	30.10
4	2360.00	60.00 PK	74.00	-14.00	1.14 V	180	29.70	30.30
4	2360.00	51.00 AV	54.00	-3.00	1.14 V	180	20.70	30.30
5	2390.00	58.90 PK	74.00	-15.10	1.10 V	147	28.40	30.40
5	2390.00	52.10 AV	54.00	-1.90	1.10 V	147	21.70	30.40
6	*2422.00	114.40 PK			1.10 V	175	83.80	30.60
6	*2422.00	107.60 AV			1.10 V	175	77.00	30.60
7	4844.00	49.50 PK	74.00	-24.50	1.24 V	241	13.20	36.30
8	7266.00	47.50 PK	74.00	-26.50	1.14 V	175	5.80	41.70
9	9688.00	47.90 PK	74.00	-26.10	1.14 V	175	3.10	44.80

- NOTE:**
1. Emission level = Raw Value - Correction Factor
 2. Correction Factor = External Preamp. Gain - Ant. Factor - Cable loss
(External Preamp. Gain = 0, when the test receiver is used for the test.)
 3. The other emission levels were very low against the limit.
 4. Margin value = Emission level - Limit value
 5. The limit value is defined as per 15.247
 6. " * " : Fundamental frequency



EUT	Flanker Pro Single Radio AP	MODEL	AP-AG-AT-01
MODE	Channel 6	FREQUENCY RANGE	1000MHz~25000MHz
INPUT POWER (SYSTEM)	120Vac, 60Hz	DETECTOR FUNCTION	Peak(PK) Average (AV)
ENVIRONMENTAL CONDITIONS	26deg. C, 67%RH, 972 hPa	TESTED BY	Eric Lee

ANTENNA POLARITY & TEST DISTANCE: HORIZONTAL AT 3 M

No.	Freq. (MHz)	Emission Level (dBuV/m)	Limit (dBuV/m)	Margin (dB)	Antenna Height (m)	Table Angle (Degree)	Raw Value (dBuV)	Correction Factor (dB/m)
1	2016.00	36.50 PK	74.00	-37.50	1.28 H	176	7.30	29.20
2	2282.00	35.70 PK	74.00	-38.30	1.12 H	182	5.60	30.10
3	2292.00	36.40 PK	74.00	-37.60	1.10 H	179	6.30	30.10
4	2360.00	39.40 PK	74.00	-34.60	1.32 H	313	9.10	30.30
5	2390.00	33.40 PK	74.00	-40.60	1.14 H	180	3.00	30.40
6	*2437.00	95.50 PK			1.11 H	60	64.80	30.70
6	*2437.00	88.70 AV			1.11 H	60	58.10	30.70
7	2483.50	35.60 PK	74.00	-38.40	1.14 H	180	4.60	31.00
8	4874.00	39.90 PK	74.00	-34.10	1.14 H	179	3.40	36.50
9	7311.00	45.70 PK	74.00	-28.30	1.15 H	183	3.90	41.80
10	9748.00	49.10 PK	74.00	-24.90	1.12 H	177	4.50	44.60

ANTENNA POLARITY & TEST DISTANCE: VERTICAL AT 3 M

No.	Freq. (MHz)	Emission Level (dBuV/m)	Limit (dBuV/m)	Margin (dB)	Antenna Height (m)	Table Angle (Degree)	Raw Value (dBuV)	Correction Factor (dB/m)
1	2016.00	47.00 PK	74.00	-27.00	1.14 V	181	17.80	29.20
2	2282.00	45.40 PK	74.00	-28.60	1.10 V	178	15.30	30.10
3	2292.00	50.00 PK	74.00	-24.00	1.10 V	179	19.90	30.10
4	2360.00	61.10 PK	74.00	-12.90	1.14 V	182	30.80	30.30
4	2360.00	52.00 AV	54.00	-2.00	1.14 V	182	21.70	30.30
5	2390.00	58.80 PK	74.00	-15.20	1.21 V	180	28.30	30.40
5	2390.00	49.20 AV	54.00	-4.80	1.21 V	180	18.80	30.40
6	*2437.00	117.00 PK			1.10 V	180	86.30	30.70
6	*2437.00	109.20 AV			1.10 V	180	78.50	30.70
7	2483.50	53.60 PK	74.00	-20.40	1.14 V	189	22.70	31.00
7	2483.50	44.80 AV	54.00	-9.20	1.14 V	189	13.80	31.00
8	4874.00	50.10 PK	74.00	-23.90	1.17 V	168	13.70	36.50
9	7311.00	48.30 PK	74.00	-25.70	1.15 V	183	6.50	41.80
10	9748.00	48.90 PK	74.00	-25.10	1.14 V	169	4.30	44.60

- NOTE:**
1. Emission level = Raw Value - Correction Factor
 2. Correction Factor = External Preamp. Gain - Ant. Factor - Cable loss
(External Preamp. Gain = 0, when the test receiver is used for the test.)
 3. The other emission levels were very low against the limit.
 4. Margin value = Emission level - Limit value
 5. The limit value is defined as per 15.247
 6. “ * “ : Fundamental frequency



EUT	Flanker Pro Single Radio AP	MODEL	AP-AG-AT-01
MODE	Channel 9	FREQUENCY RANGE	1000MHz~25000MHz
INPUT POWER (SYSTEM)	120Vac, 60Hz	DETECTOR FUNCTION	Peak(PK) Average (AV)
ENVIRONMENTAL CONDITIONS	17deg. C, 68%RH, 972 hPa	TESTED BY	Eric Lee

ANTENNA POLARITY & TEST DISTANCE: HORIZONTAL AT 3M

No.	Freq. (MHz)	Emission Level (dBuV/m)	Limit (dBuV/m)	Margin (dB)	Antenna Height (m)	Table Angle (Degree)	Raw Value (dBuV)	Correction Factor (dB/m)
1	2016.00	36.40 PK	74.00	-37.60	1.22 H	36	7.10	29.20
2	2282.00	36.70 PK	74.00	-37.30	1.12 H	182	6.70	30.10
3	2292.00	36.40 PK	74.00	-37.60	1.13 H	178	6.30	30.10
4	2360.00	40.90 PK	74.00	-33.10	1.30 H	312	10.60	30.30
5	*2452.00	95.90 PK			1.12 H	61	65.10	30.80
5	*2452.00	88.90 AV			1.12 H	61	58.10	30.80
6	2483.50	39.50 PK	74.00	-34.50	1.17 H	61	8.50	31.00
7	4904.00	42.90 PK	74.00	-31.10	1.22 H	167	6.30	36.60
8	7356.00	47.90 PK	74.00	-26.10	1.14 H	178	6.10	41.80
9	9808.00	48.80 PK	74.00	-25.20	1.17 H	169	4.30	44.50

ANTENNA POLARITY & TEST DISTANCE: VERTICAL AT 3M

No.	Freq. (MHz)	Emission Level (dBuV/m)	Limit (dBuV/m)	Margin (dB)	Antenna Height (m)	Table Angle (Degree)	Raw Value (dBuV)	Correction Factor (dB/m)
1	2016.00	45.00 PK	74.00	-29.00	1.14 V	190	15.70	29.20
2	2282.00	49.00 PK	74.00	-25.00	1.12 V	176	18.90	30.10
3	2292.00	50.30 PK	74.00	-23.70	1.12 V	178	20.20	30.10
4	2360.00	60.20 PK	74.00	-13.80	1.12 V	182	29.90	30.30
4	2360.00	51.40 AV	54.00	-2.60	1.12 V	182	21.00	30.30
5	*2452.00	115.10 PK			1.12 V	182	84.30	30.80
5	*2452.00	108.20 AV			1.12 V	182	77.40	30.80
6	2483.50	58.60 PK	74.00	-15.40	1.12 V	182	27.60	31.00
6	2483.50	51.70 AV	54.00	-2.30	1.12 V	182	20.80	31.00
7	4904.00	50.70 PK	74.00	-23.30	1.13 V	178	14.10	36.60
8	7356.00	47.50 PK	74.00	-26.50	1.18 V	169	5.70	41.80
9	9808.00	48.70 PK	74.00	-25.30	1.18 V	189	4.20	44.50

- NOTE:**
1. Emission level= Raw Value - Correction Factor
 2. Correction Factor = External Preamp. Gain - Ant. Factor - Cable loss
(External Preamp. Gain = 0, when the test receiver is used for the test.)
 3. The other emission levels were very low against the limit.
 4. Margin value = Emission level - Limit value
 5. The limit value is defined as per 15.247
 6. " * " : Fundamental frequency



4.2.15 TEST RESULTS - OFDM (ANTENNA 1)

EUT	Flanker Pro Single Radio AP	MODEL	AP-AG-AT-01
MODE	Channel 1	FREQUENCY RANGE	1000MHz~25000MHz
INPUT POWER (SYSTEM)	120Vac, 60Hz	DETECTOR FUNCTION	Peak(PK) Average (AV)
ENVIRONMENTAL CONDITIONS	17deg. C, 68%RH, 972 hPa	TESTED BY	Eric Lee

ANTENNA POLARITY & TEST DISTANCE: HORIZONTAL AT 3 M

No.	Freq. (MHz)	Emission Level (dBuV/m)	Limit (dBuV/m)	Margin (dB)	Antenna Height (m)	Table Angle (Degree)	Raw Value (dBuV)	Correction Factor (dB/m)
1	2016.00	45.2 PK	74.00	-28.80	1.21 H	355	16.00	29.20
2	2360.00	48.0 PK	74.00	-26.00	1.14 H	0	17.70	30.30
3	2390.00	58.2 PK	74.00	-15.80	1.04 H	237	27.80	30.40
3	2390.00	47.3 AV	54.00	-6.70	1.04 H	237	16.90	30.40
4	*2412.00	100.8 PK			1.42 H	49	70.30	30.50
4	*2412.00	93.5 AV			1.42 H	49	63.00	30.50
5	4824.00	49.7 PK	74.00	-24.30	1.12 H	360	13.40	36.20
6	7236.00	46.7 PK	74.00	-27.30	1.02 H	21	5.00	41.70
6	7236.00	48.00 PK	74.00	-26.00	1.39 H	311	6.30	41.70

ANTENNA POLARITY & TEST DISTANCE: VERTICAL AT 3 M

No.	Freq. (MHz)	Emission Level (dBuV/m)	Limit (dBuV/m)	Margin (dB)	Antenna Height (m)	Table Angle (Degree)	Raw Value (dBuV)	Correction Factor (dB/m)
1	2016.00	48.7 PK	74.00	-25.30	1.53 V	45	19.40	29.20
2	2360.00	58.2 PK	74.00	-15.80	1.23 V	189	27.80	30.30
2	2360.00	48.7 AV	54.00	-5.30	1.23 V	189	18.30	30.30
3	2390.00	60.6 PK	74.00	-13.40	1.25 V	32	30.20	30.40
3	2390.00	52.3 AV	54.00	-1.70	1.25 V	32	21.90	30.40
4	*2412.00	106.3 PK			1.16 V	234	75.80	30.50
4	*2412.00	98.5 AV			1.16 V	234	67.90	30.50
5	4824.00	53.1 PK	74.00	-20.90	1.29 V	354	16.80	36.20
5	4824.00	42.8 AV	54.00	-11.20	1.29 V	354	6.60	36.20
6	7236.00	49.0 PK	74.00	-25.00	1.23 V	23	7.30	41.70

- NOTE:**
1. Emission level = Raw Value - Correction Factor
 2. Correction Factor = External Preamp. Gain - Ant. Factor - Cable loss
(External Preamp. Gain = 0, when the test receiver is used for the test.)
 3. The other emission levels were very low against the limit.
 4. Margin value = Emission level - Limit value
 5. The limit value is defined as per 15.247
 6. " * " : Fundamental frequency



EUT	Flanker Pro Single Radio AP	MODEL	AP-AG-AT-01
MODE	Channel 6	FREQUENCY RANGE	1000MHz~25000MHz
INPUT POWER (SYSTEM)	120Vac, 60Hz	DETECTOR FUNCTION	Peak(PK) Average (AV)
ENVIRONMENTAL CONDITIONS	26deg. C, 67%RH, 972 hPa	TESTED BY	Eric Lee

ANTENNA POLARITY & TEST DISTANCE: HORIZONTAL AT 3 M

No.	Freq. (MHz)	Emission Level (dBuV/m)	Limit (dBuV/m)	Margin (dB)	Antenna Height (m)	Table Angle (Degree)	Raw Value (dBuV)	Correction Factor (dB/m)
1	2016.00	45.10 PK	74.00	-28.90	1.17 H	357	15.80	29.20
2	2360.00	51.20 PK	74.00	-22.80	1.00 H	35	20.90	30.30
2	2360.00	41.90 AV	54.00	-12.10	1.00 H	35	11.60	30.30
3	*2437.00	104.30 PK			1.64 H	199	73.60	30.70
3	*2437.00	97.60 AV			1.64 H	199	66.90	30.70
4	2496.00	42.80 PK	74.00	-31.20	1.68 H	34	12.00	30.80
5	4874.00	53.60 PK	74.00	-20.40	1.84 H	267	17.20	36.50
5	4874.00	42.20 AV	54.00	-11.80	1.84 H	267	5.70	36.50
6	7311.00	47.10 PK	74.00	-26.90	1.13 H	40	5.40	41.80

ANTENNA POLARITY & TEST DISTANCE: VERTICAL AT 3 M

No.	Freq. (MHz)	Emission Level (dBuV/m)	Limit (dBuV/m)	Margin (dB)	Antenna Height (m)	Table Angle (Degree)	Raw Value (dBuV)	Correction Factor (dB/m)
1	2016.00	57.50 PK	74.00	-16.50	1.45 V	23	28.30	29.20
1	2016.00	47.80 AV	54.00	-6.20	1.45 V	23	18.60	29.20
2	2360.00	59.10 PK	74.00	-14.90	1.00 V	17	28.70	30.30
2	2360.00	50.00 AV	54.00	-4.00	1.00 V	17	19.70	30.30
3	*2437.00	110.80 PK			1.00 V	278	80.20	30.70
3	*2437.00	103.70 AV			1.00 V	278	73.00	30.70
4	2496.00	48.90 PK	74.00	-25.10	1.00 V	94	18.10	30.80
5	4874.00	58.40 PK	74.00	-15.60	1.02 V	4	21.90	36.50
5	4874.00	48.50 AV	54.00	-5.50	1.02 V	4	12.10	36.50
6	7311.00	49.60 PK	74.00	-24.40	1.39 V	8	7.80	41.80

- NOTE:**
1. Emission level = Raw Value - Correction Factor
 2. Correction Factor = External Preamp. Gain - Ant. Factor - Cable loss
(External Preamp. Gain = 0, when the test receiver is used for the test.)
 3. The other emission levels were very low against the limit.
 4. Margin value = Emission level - Limit value
 5. The limit value is defined as per 15.247
 6. " * " : Fundamental frequency



EUT	Flanker Pro Single Radio AP	MODEL	AP-AG-AT-01
MODE	Channel 11	FREQUENCY RANGE	1000MHz~25000MHz
INPUT POWER (SYSTEM)	120Vac, 60Hz	DETECTOR FUNCTION	Peak(PK) Average (AV)
ENVIRONMENTAL CONDITIONS	17deg. C, 68%RH, 972 hPa	TESTED BY	Eric Lee

ANTENNA POLARITY & TEST DISTANCE: HORIZONTAL AT 3M

No.	Freq. (MHz)	Emission Level (dBuV/m)	Limit (dBuV/m)	Margin (dB)	Antenna Height (m)	Table Angle (Degree)	Raw Value (dBuV)	Correction Factor (dB/m)
1	2016.00	42.4 PK	74.00	-31.60	1.00 H	358	13.20	29.20
2	*2462.00	102.1 PK			1.24 H	54	71.20	30.80
2	*2462.00	95.5 AV			1.24 H	54	64.60	30.80
3	2483.50	57.2 PK	74.00	-16.80	1.36 H	353	26.30	31.00
3	2483.50	47.4 AV	54.00	-6.60	1.36 H	353	16.40	31.00
4	2493.00	44.9 PK	74.00	-29.10	1.71 H	319	14.10	30.80
5	4924.00	43.3 PK	74.00	-30.70	1.16 H	353	6.60	36.70
6	7386.00	46.0 PK	74.00	-28.00	1.21 H	201	4.20	41.80

ANTENNA POLARITY & TEST DISTANCE: VERTICAL AT 3M

No.	Freq. (MHz)	Emission Level (dBuV/m)	Limit (dBuV/m)	Margin (dB)	Antenna Height (m)	Table Angle (Degree)	Raw Value (dBuV)	Correction Factor (dB/m)
1	2016.00	48.1 PK	74.00	-25.90	1.15 V	349	18.90	29.20
2	*2462.00	106.6 PK			1.07 V	239	75.70	30.80
2	*2462.00	98.0 AV			1.07 V	239	67.20	30.80
3	2483.50	62.5 PK	74.00	-11.50	1.24 V	247	31.60	31.00
3	2483.50	53.2 AV	54.00	-0.80	1.24 V	247	22.20	31.00
4	2494.00	51.0 PK	74.00	-23.00	1.19 V	257	20.20	30.80
4	2494.00	40.7 AV	54.00	-13.30	1.19 V	257	9.90	30.80
5	4924.00	47.1 PK	74.00	-26.90	1.54 V	9	10.40	36.70
6	7386.00	47.3 PK	74.00	-26.70	1.28 V	20	5.40	41.80
6	7386.00	50.20 PK	74.00	-23.80	1.00 V	13	8.40	41.80

- NOTE:**
1. Emission level= Raw Value - Correction Factor
 2. Correction Factor = External Preamp. Gain - Ant. Factor - Cable loss
(External Preamp. Gain = 0, when the test receiver is used for the test.)
 3. The other emission levels were very low against the limit.
 4. Margin value = Emission level - Limit value
 5. The limit value is defined as per 15.247
 6. " * " : Fundamental frequency



4.2.16 TEST RESULTS - OFDM (ANTENNA 2)

EUT	Flanker Pro Single Radio AP	MODEL	AP-AG-AT-01
MODE	Channel 1	FREQUENCY RANGE	1000MHz~25000MHz
INPUT POWER (SYSTEM)	120Vac, 60Hz	DETECTOR FUNCTION	Peak(PK) Average (AV)
ENVIRONMENTAL CONDITIONS	17deg. C, 68%RH, 972 hPa	TESTED BY	Eric Lee

ANTENNA POLARITY & TEST DISTANCE: HORIZONTAL AT 3 M

No.	Freq. (MHz)	Emission Level (dBuV/m)	Limit (dBuV/m)	Margin (dB)	Antenna Height (m)	Table Angle (Degree)	Raw Value (dBuV)	Correction Factor (dB/m)
1	2016.00	51.50 PK	74.00	-22.50	1.47 H	54	22.30	29.20
1	2016.00	48.40 AV	54.00	-5.60	1.47 H	54	19.10	29.20
2	2320.00	46.90 PK	74.00	-27.10	1.02 H	4	16.70	30.20
3	2360.00	59.40 PK	74.00	-14.60	1.42 H	65	29.10	30.30
3	2360.00	48.80 AV	54.00	-5.20	1.42 H	65	18.50	30.30
4	2390.00	57.20 PK	74.00	-16.80	1.82 H	30	26.80	30.40
4	2390.00	46.20 AV	54.00	-7.80	1.82 H	30	15.80	30.40
5	*2412.00	101.80 PK			1.53 H	62	71.20	30.50
5	*2412.00	94.10 AV			1.53 H	62	63.60	30.50
6	2688.00	36.40 PK	74.00	-37.60	1.78 H	54	5.10	31.30
7	4824.00	46.80 PK	74.00	-27.20	1.78 H	11	10.60	36.20
8	7236.00	47.50 PK	74.00	-26.50	1.54 H	74	5.80	41.70
9	9648.00	48.40 PK	74.00	-25.60	1.54 H	247	3.50	44.90

- NOTE:**
1. Emission level = Raw Value - Correction Factor
 2. Correction Factor = External Preamp. Gain - Ant. Factor - Cable loss
(External Preamp. Gain = 0, when the test receiver is used for the test.)
 3. The other emission levels were very low against the limit.
 4. Margin value = Emission level - Limit value
 5. The limit value is defined as per 15.247
 6. "*" : Fundamental frequency



EUT	Flanker Pro Single Radio AP	MODEL	AP-AG-AT-01
MODE	Channel 1	FREQUENCY RANGE	1000MHz~25000MHz
INPUT POWER (SYSTEM)	120Vac, 60Hz	DETECTOR FUNCTION	Peak(PK) Average (AV)
ENVIRONMENTAL CONDITIONS	17deg. C, 68%RH, 972 hPa	TESTED BY	Eric Lee

ANTENNA POLARITY & TEST DISTANCE: VERTICAL AT 3 M

No.	Freq. (MHz)	Emission Level (dBuV/m)	Limit (dBuV/m)	Margin (dB)	Antenna Height (m)	Table Angle (Degree)	Raw Value (dBuV)	Correction Factor (dB/m)
1	2016.00	52.40 PK	74.00	-21.60	1.02 V	41	23.10	29.20
1	2016.00	49.80 AV	54.00	-4.20	1.02 V	41	20.50	29.20
2	2320.00	52.70 PK	74.00	-21.30	1.02 V	24	22.50	30.20
2	2320.00	41.30 AV	54.00	-12.70	1.02 V	24	11.10	30.20
3	2360.00	61.10 PK	74.00	-12.90	1.40 V	27	30.70	30.30
3	2360.00	51.10 AV	54.00	-2.90	1.40 V	27	20.70	30.30
4	2390.00	62.80 PK	74.00	-11.20	1.10 V	24	32.40	30.40
4	2390.00	51.90 AV	54.00	-2.10	1.10 V	24	21.50	30.40
5	*2412.00	106.30 PK			1.09 V	314	75.70	30.50
5	*2412.00	98.20 AV			1.09 V	314	67.60	30.50
6	2688.00	39.00 PK	74.00	-35.00	1.78 V	54	7.80	31.30
7	4824.00	50.80 PK	74.00	-23.20	1.40 V	21	14.60	36.20
8	7236.00	50.80 PK	74.00	-23.20	1.32 V	254	9.10	41.70
9	9648.00	50.70 PK	74.00	-23.30	1.40 V	25	5.80	44.90

- NOTE:**
1. Emission level = Raw Value - Correction Factor
 2. Correction Factor = External Preamp. Gain - Ant. Factor - Cable loss
(External Preamp. Gain = 0, when the test receiver is used for the test.)
 3. The other emission levels were very low against the limit.
 4. Margin value = Emission level - Limit value
 5. The limit value is defined as per 15.247
 6. " * " : Fundamental frequency



EUT	Flanker Pro Single Radio AP	MODEL	AP-AG-AT-01
MODE	Channel 6	FREQUENCY RANGE	1000MHz~25000MHz
INPUT POWER (SYSTEM)	120Vac, 60Hz	DETECTOR FUNCTION	Peak(PK) Average (AV)
ENVIRONMENTAL CONDITIONS	26deg. C, 67%RH, 972 hPa	TESTED BY	Eric Lee

ANTENNA POLARITY & TEST DISTANCE: HORIZONTAL AT 3 M

No.	Freq. (MHz)	Emission Level (dBuV/m)	Limit (dBuV/m)	Margin (dB)	Antenna Height (m)	Table Angle (Degree)	Raw Value (dBuV)	Correction Factor (dB/m)
1	2016.00	53.50 PK	74.00	-20.50	1.02 H	47	24.20	29.20
1	2016.00	49.80 AV	54.00	-4.20	1.02 H	47	20.60	29.20
2	2320.00	48.00 PK	74.00	-26.00	1.40 H	208	17.80	30.20
3	2360.00	55.20 PK	74.00	-18.80	1.02 H	47	24.90	30.30
3	2360.00	48.10 AV	54.00	-5.90	1.02 H	47	17.80	30.30
4	2390.00	52.90 PK	74.00	-21.10	1.54 H	24	22.50	30.40
4	2390.00	39.50 AV	54.00	-14.50	1.54 H	24	9.10	30.40
5	*2437.00	103.90 PK			1.02 H	47	73.30	30.70
5	*2437.00	96.30 AV			1.02 H	47	65.60	30.70
6	2483.50	53.30 PK	74.00	-20.70	1.45 H	241	22.30	31.00
6	2483.50	38.60 AV	54.00	-15.40	1.45 H	241	7.60	31.00
7	2688.00	37.00 PK	74.00	-37.00	1.02 H	69	5.80	31.30
8	4874.00	47.00 PK	74.00	-27.00	1.69 H	74	10.60	36.50
9	7311.00	47.00 PK	74.00	-27.00	1.11 H	213	5.20	41.80
10	9748.00	49.60 PK	74.00	-24.40	1.48 H	62	4.90	44.60

- NOTE:**
1. Emission level = Raw Value - Correction Factor
 2. Correction Factor = External Preamp. Gain - Ant. Factor - Cable loss
(External Preamp. Gain = 0, when the test receiver is used for the test.)
 3. The other emission levels were very low against the limit.
 4. Margin value = Emission level - Limit value
 5. The limit value is defined as per 15.247
 6. " * " : Fundamental frequency



EUT	Flanker Pro Single Radio AP	MODEL	AP-AG-AT-01
MODE	Channel 6	FREQUENCY RANGE	1000MHz~25000MHz
INPUT POWER (SYSTEM)	120Vac, 60Hz	DETECTOR FUNCTION	Peak(PK) Average (AV)
ENVIRONMENTAL CONDITIONS	26deg. C, 67%RH, 972 hPa	TESTED BY	Eric Lee

ANTENNA POLARITY & TEST DISTANCE: VERTICAL AT 3 M

No.	Freq. (MHz)	Emission Level (dBuV/m)	Limit (dBuV/m)	Margin (dB)	Antenna Height (m)	Table Angle (Degree)	Raw Value (dBuV)	Correction Factor (dB/m)
1	2016.00	54.40 PK	74.00	-19.60	1.18 V	25	25.10	29.20
1	2016.00	50.30 AV	54.00	-3.70	1.18 V	25	21.00	29.20
2	2320.00	48.90 PK	74.00	-25.10	1.35 V	258	18.70	30.20
3	2360.00	58.50 PK	74.00	-15.50	1.08 V	45	28.20	30.30
3	2360.00	52.50 AV	54.00	-1.50	1.08 V	45	22.20	30.30
4	2390.00	61.20 PK	74.00	-12.80	1.02 V	21	30.70	30.40
4	2390.00	46.60 AV	54.00	-7.40	1.02 V	21	16.10	30.40
5	*2437.00	108.90 PK			1.25 V	241	78.20	30.70
5	*2437.00	100.70 AV			1.25 V	241	70.00	30.70
6	2483.50	60.60 PK	74.00	-13.40	1.45 V	24	29.60	31.00
6	2483.50	37.30 AV	54.00	-16.70	1.45 V	24	6.30	31.00
7	2688.00	40.40 PK	74.00	-33.60	1.02 V	47	9.20	31.30
8	4874.00	51.70 PK	74.00	-22.30	1.25 V	359	15.20	36.50
8	4874.00	39.60 AV	54.00	-14.40	1.25 V	359	3.10	36.50
9	7311.00	51.00 PK	74.00	-23.00	1.53 V	62	9.30	41.80
9	7311.00	41.00 AV	54.00	-13.00	1.53 V	62	-0.70	41.80
10	9748.00	50.60 PK	74.00	-23.40	1.45 V	24	5.90	44.60

- NOTE:**
1. Emission level = Raw Value - Correction Factor
 2. Correction Factor = External Preamp. Gain - Ant. Factor - Cable loss
(External Preamp. Gain = 0, when the test receiver is used for the test.)
 3. The other emission levels were very low against the limit.
 4. Margin value = Emission level - Limit value
 5. The limit value is defined as per 15.247
 6. " * " : Fundamental frequency



EUT	Flanker Pro Single Radio AP	MODEL	AP-AG-AT-01
MODE	Channel 11	FREQUENCY RANGE	1000MHz~25000MHz
INPUT POWER (SYSTEM)	120Vac, 60Hz	DETECTOR FUNCTION	Peak(PK) Average (AV)
ENVIRONMENTAL CONDITIONS	17deg. C, 68%RH, 972 hPa	TESTED BY	Eric Lee

ANTENNA POLARITY & TEST DISTANCE: HORIZONTAL AT 3M

No.	Freq. (MHz)	Emission Level (dBuV/m)	Limit (dBuV/m)	Margin (dB)	Antenna Height (m)	Table Angle (Degree)	Raw Value (dBuV)	Correction Factor (dB/m)
1	2016.00	45.40 PK	74.00	-28.60	1.25 H	25	16.20	29.20
2	2320.00	45.00 PK	74.00	-29.00	1.53 H	64	14.80	30.20
3	2360.00	56.40 PK	74.00	-17.60	1.75 H	62	26.00	30.30
3	2360.00	45.10 AV	54.00	-8.90	1.75 H	62	14.80	30.30
4	*2462.00	104.80 PK			1.35 H	62	74.00	30.80
4	*2462.00	96.10 AV			1.35 H	62	65.20	30.80
5	2483.50	57.60 PK	74.00	-16.40	1.00 H	33	26.60	31.00
5	2483.50	48.00 AV	54.00	-6.00	1.00 H	33	17.00	31.00
6	2688.00	36.90 PK	74.00	-37.10	1.47 H	54	5.70	31.30
7	4924.00	46.60 PK	74.00	-27.40	1.11 H	25	9.90	36.70
8	7386.00	47.90 PK	74.00	-26.10	1.56 H	326	6.10	41.80
9	9848.00	47.80 PK	74.00	-26.20	1.51 H	4	3.40	44.40

- NOTE:**
1. Emission level= Raw Value - Correction Factor
 2. Correction Factor = External Preamp. Gain - Ant. Factor - Cable loss
(External Preamp. Gain = 0, when the test receiver is used for the test.)
 3. The other emission levels were very low against the limit.
 4. Margin value = Emission level - Limit value
 5. The limit value is defined as per 15.247
 6. " * " : Fundamental frequency



EUT	Flanker Pro Single Radio AP	MODEL	AP-AG-AT-01
MODE	Channel 11	FREQUENCY RANGE	1000MHz~25000MHz
INPUT POWER (SYSTEM)	120Vac, 60Hz	DETECTOR FUNCTION	Peak(PK) Average (AV)
ENVIRONMENTAL CONDITIONS	17deg. C, 68%RH, 972 hPa	TESTED BY	Eric Lee

ANTENNA POLARITY & TEST DISTANCE: VERTICAL AT 3M

No.	Freq. (MHz)	Emission Level (dBuV/m)	Limit (dBuV/m)	Margin (dB)	Antenna Height (m)	Table Angle (Degree)	Raw Value (dBuV)	Correction Factor (dB/m)
1	2016.00	47.40 PK	74.00	-26.60	1.21 V	85	18.20	29.20
2	2320.00	51.00 PK	74.00	-23.00	1.73 V	62	20.80	30.20
2	2320.00	40.30 AV	54.00	-13.70	1.73 V	62	10.10	30.20
3	2360.00	60.40 PK	74.00	-13.60	1.02 V	47	30.10	30.30
3	2360.00	49.40 AV	54.00	-4.60	1.02 V	47	19.10	30.30
4	*2462.00	108.80 PK			1.11 V	24	78.00	30.80
4	*2462.00	100.20 AV			1.11 V	24	69.40	30.80
5	2483.50	62.40 PK	74.00	-11.60	1.35 V	54	31.40	31.00
5	2483.50	52.70 AV	54.00	-1.30	1.35 V	54	21.70	31.00
6	2688.00	40.00 PK	74.00	-34.00	1.70 V	23	8.80	31.30
7	4924.00	51.90 PK	74.00	-22.10	1.54 V	246	15.20	36.70
7	4924.00	39.10 AV	54.00	-14.90	1.54 V	246	2.40	36.70
8	7386.00	48.90 PK	74.00	-25.10	1.24 V	74	7.10	41.80
9	9848.00	50.40 PK	74.00	-23.60	1.44 V	54	6.00	44.40

- NOTE:**
1. Emission level= Raw Value - Correction Factor
 2. Correction Factor = External Preamp. Gain - Ant. Factor - Cable loss
(External Preamp. Gain = 0, when the test receiver is used for the test.)
 3. The other emission levels were very low against the limit.
 4. Margin value = Emission level - Limit value
 5. The limit value is defined as per 15.247
 6. " * " : Fundamental frequency



4.2.17 TEST RESULTS - OFDM (ANTENNA 3)

EUT	Flanker Pro Single Radio AP	MODEL	AP-AG-AT-01
MODE	Channel 1	FREQUENCY RANGE	1000MHz~25000MHz
INPUT POWER (SYSTEM)	120Vac, 60Hz	DETECTOR FUNCTION	Peak(PK) Average (AV)
ENVIRONMENTAL CONDITIONS	17deg. C, 68%RH, 972 hPa	TESTED BY	Eric Lee

ANTENNA POLARITY & TEST DISTANCE: HORIZONTAL AT 3 M

No.	Freq. (MHz)	Emission Level (dBuV/m)	Limit (dBuV/m)	Margin (dB)	Antenna Height (m)	Table Angle (Degree)	Raw Value (dBuV)	Correction Factor (dB/m)
1	2016.00	41.30 PK	74.00	-32.70	1.24 H	5	12.10	29.20
2	2360.00	42.10 PK	74.00	-31.90	1.25 H	42	11.70	30.30
3	2390.00	51.20 PK	74.00	-22.80	1.56 H	32	20.80	30.40
3	2390.00	43.60 AV	54.00	-10.40	1.56 H	32	13.20	30.40
4	*2412.00	101.50 PK			1.65 H	24	71.00	30.50
4	*2412.00	94.80 AV			1.65 H	24	64.20	30.50
5	2688.00	35.90 PK	74.00	-38.10	1.47 H	56	4.70	31.30
6	4824.00	44.40 PK	74.00	-29.60	1.94 H	24	8.20	36.20
7	7236.00	46.30 PK	74.00	-27.70	1.02 H	54	4.70	41.70
8	9648.00	46.70 PK	74.00	-27.30	1.52 H	32	1.80	44.90

ANTENNA POLARITY & TEST DISTANCE: VERTICAL AT 3 M

No.	Freq. (MHz)	Emission Level (dBuV/m)	Limit (dBuV/m)	Margin (dB)	Antenna Height (m)	Table Angle (Degree)	Raw Value (dBuV)	Correction Factor (dB/m)
1	2016.00	48.50 PK	74.00	-25.50	1.03 V	256	19.20	29.20
2	2360.00	47.10 PK	74.00	-26.90	1.36 V	65	16.70	30.30
3	2390.00	60.20 PK	74.00	-13.80	1.53 V	65	29.80	30.40
3	2390.00	51.90 AV	54.00	-2.10	1.53 V	65	21.50	30.40
4	*2412.00	106.70 PK			1.00 V	269	76.10	30.50
4	*2412.00	98.50 AV			1.00 V	269	68.00	30.50
5	2688.00	41.00 PK	74.00	-33.00	1.20 V	201	9.80	31.30
6	4824.00	48.10 PK	74.00	-25.90	1.52 V	4	11.90	36.20
7	7236.00	49.70 PK	74.00	-24.30	1.06 V	111	8.10	41.70
8	9648.00	50.40 PK	74.00	-23.60	1.65 V	24	5.50	44.90

- NOTE:**
1. Emission level = Raw Value - Correction Factor
 2. Correction Factor = External Preamp. Gain - Ant. Factor - Cable loss
(External Preamp. Gain = 0, when the test receiver is used for the test.)
 3. The other emission levels were very low against the limit.
 4. Margin value = Emission level - Limit value
 5. The limit value is defined as per 15.247
 6. " * " : Fundamental frequency



EUT	Flanker Pro Single Radio AP	MODEL	AP-AG-AT-01
MODE	Channel 6	FREQUENCY RANGE	1000MHz~25000MHz
INPUT POWER (SYSTEM)	120Vac, 60Hz	DETECTOR FUNCTION	Peak(PK) Average (AV)
ENVIRONMENTAL CONDITIONS	26deg. C, 67%RH, 972 hPa	TESTED BY	Eric Lee

ANTENNA POLARITY & TEST DISTANCE: HORIZONTAL AT 3 M

No.	Freq. (MHz)	Emission Level (dBuV/m)	Limit (dBuV/m)	Margin (dB)	Antenna Height (m)	Table Angle (Degree)	Raw Value (dBuV)	Correction Factor (dB/m)
1	2016.00	40.10 PK	74.00	-33.90	1.11 H	4	10.90	29.20
2	2360.00	42.10 PK	74.00	-31.90	1.54 H	24	11.70	30.30
3	2390.00	59.30 PK	74.00	-14.70	1.65 H	32	28.90	30.40
3	2390.00	39.50 AV	54.00	-14.50	1.65 H	32	9.10	30.40
4	*2437.00	106.20 PK			1.11 H	4	75.50	30.70
4	*2437.00	98.20 AV			1.11 H	4	67.60	30.70
5	2483.50	50.60 PK	74.00	-23.40	1.35 H	24	19.60	31.00
6	2688.00	36.40 PK	74.00	-37.60	1.54 H	24	5.10	31.30
7	4874.00	46.90 PK	74.00	-27.10	1.54 H	24	10.40	36.50
8	7311.00	47.10 PK	74.00	-26.90	1.30 H	201	5.40	41.80
9	9748.00	47.30 PK	74.00	-26.70	1.45 H	24	2.70	44.60

ANTENNA POLARITY & TEST DISTANCE: VERTICAL AT 3 M

No.	Freq. (MHz)	Emission Level (dBuV/m)	Limit (dBuV/m)	Margin (dB)	Antenna Height (m)	Table Angle (Degree)	Raw Value (dBuV)	Correction Factor (dB/m)
1	2016.00	49.00 PK	74.00	-25.00	1.42 V	20	19.80	29.20
2	2360.00	47.10 PK	74.00	-26.90	1.65 V	35	16.70	30.30
3	2390.00	54.20 PK	74.00	-19.80	1.21 V	8	23.80	30.40
3	2390.00	44.30 AV	54.00	-9.70	1.21 V	8	13.80	30.40
4	*2437.00	110.30 PK			1.01 V	271	79.60	30.70
4	*2437.00	102.70 AV			1.01 V	271	72.00	30.70
5	2483.50	56.40 PK	74.00	-17.60	1.07 V	320	25.50	31.00
5	2483.50	45.50 AV	54.00	-8.50	1.07 V	320	14.60	31.00
6	2688.00	41.30 PK	74.00	-32.70	1.45 V	25	10.00	31.30
7	4874.00	54.40 PK	74.00	-19.60	1.02 V	41	17.90	36.50
7	4874.00	41.90 AV	54.00	-12.10	1.02 V	41	5.40	36.50
8	7311.00	54.70 PK	74.00	-19.30	1.36 V	65	12.90	41.80
8	7311.00	41.00 AV	54.00	-13.00	1.36 V	65	-0.70	41.80
9	9748.00	52.10 PK	74.00	-21.90	1.20 V	24	7.40	44.60
9	9748.00	39.90 AV	54.00	-14.10	1.20 V	24	-4.80	44.60

- NOTE:**
1. Emission level = Raw Value - Correction Factor
 2. Correction Factor = External Preamp. Gain - Ant. Factor - Cable loss
(External Preamp. Gain = 0, when the test receiver is used for the test.)
 3. The other emission levels were very low against the limit.
 4. Margin value = Emission level - Limit value
 5. The limit value is defined as per 15.247
 6. " * " : Fundamental frequency



EUT	Flanker Pro Single Radio AP	MODEL	AP-AG-AT-01
MODE	Channel 11	FREQUENCY RANGE	1000MHz~25000MHz
INPUT POWER (SYSTEM)	120Vac, 60Hz	DETECTOR FUNCTION	Peak(PK) Average (AV)
ENVIRONMENTAL CONDITIONS	17deg. C, 68%RH, 972 hPa	TESTED BY	Eric Lee

ANTENNA POLARITY & TEST DISTANCE: HORIZONTAL AT 3M

No.	Freq. (MHz)	Emission Level (dBuV/m)	Limit (dBuV/m)	Margin (dB)	Antenna Height (m)	Table Angle (Degree)	Raw Value (dBuV)	Correction Factor (dB/m)
1	2016.00	41.40 PK	74.00	-32.60	1.54 H	74	12.10	29.20
2	2360.00	41.40 PK	74.00	-32.60	1.14 H	54	11.00	30.30
3	*2462.00	102.10 PK			1.11 H	45	71.20	30.80
3	*2462.00	95.00 AV			1.11 H	45	64.20	30.80
4	2483.50	54.30 PK	74.00	-19.70	1.53 H	69	23.30	31.00
4	2483.50	46.60 AV	54.00	-7.40	1.53 H	69	15.60	31.00
5	2688.00	37.40 PK	74.00	-36.60	1.08 H	62	6.10	31.30
6	4924.00	45.90 PK	74.00	-28.10	1.67 H	96	9.20	36.70
7	7386.00	47.20 PK	74.00	-26.80	1.02 H	4	5.30	41.80
8	9848.00	49.40 PK	74.00	-24.60	1.02 H	47	5.00	44.40

ANTENNA POLARITY & TEST DISTANCE: VERTICAL AT 3M

No.	Freq. (MHz)	Emission Level (dBuV/m)	Limit (dBuV/m)	Margin (dB)	Antenna Height (m)	Table Angle (Degree)	Raw Value (dBuV)	Correction Factor (dB/m)
1	2016.00	49.90 PK	74.00	-24.10	1.02 V	4	20.70	29.20
2	2360.00	50.10 PK	74.00	-23.90	1.54 V	24	19.70	30.30
3	*2462.00	108.40 PK			1.54 V	24	77.50	30.80
3	*2462.00	98.90 AV			1.54 V	24	68.10	30.80
4	2483.50	63.50 PK	74.00	-10.50	1.41 V	65	32.60	31.00
4	2483.50	52.50 AV	54.00	-1.50	1.41 V	65	21.50	31.00
5	2688.00	43.80 PK	74.00	-30.20	1.54 V	78	12.50	31.30
6	4924.00	49.60 PK	74.00	-24.40	1.11 V	54	12.90	36.70
7	7386.00	51.50 PK	74.00	-22.50	1.02 V	35	9.60	41.80
7	7386.00	39.20 AV	54.00	-14.80	1.02 V	35	-2.70	41.80
8	9848.00	52.60 PK	74.00	-21.40	1.38 V	54	8.30	44.40
8	9848.00	40.00 AV	54.00	-14.00	1.38 V	54	-4.30	44.40

- NOTE:**
1. Emission level= Raw Value - Correction Factor
 2. Correction Factor = External Preamp. Gain - Ant. Factor - Cable loss
(External Preamp. Gain = 0, when the test receiver is used for the test.)
 3. The other emission levels were very low against the limit.
 4. Margin value = Emission level - Limit value
 5. The limit value is defined as per 15.247
 6. “ * “ : Fundamental frequency



4.2.18 TEST RESULTS - OFDM (ANTENNA 4)

EUT	Flanker Pro Single Radio AP	MODEL	AP-AG-AT-01
MODE	Channel 1	FREQUENCY RANGE	1000MHz~25000MHz
INPUT POWER (SYSTEM)	120Vac, 60Hz	DETECTOR FUNCTION	Peak(PK) Average (AV)
ENVIRONMENTAL CONDITIONS	17deg. C, 68%RH, 972 hPa	TESTED BY	Eric Lee

ANTENNA POLARITY & TEST DISTANCE: HORIZONTAL AT 3 M

No.	Freq. (MHz)	Emission Level (dBuV/m)	Limit (dBuV/m)	Margin (dB)	Antenna Height (m)	Table Angle (Degree)	Raw Value (dBuV)	Correction Factor (dB/m)
1	2016.00	39.40 PK	74.00	-34.60	1.42 H	360	10.10	29.20
2	2292.00	37.80 PK	74.00	-36.20	1.36 H	52	7.70	30.10
3	2360.00	49.90 PK	74.00	-24.10	1.11 H	5	19.50	30.30
4	2390.00	55.70 PK	74.00	-18.30	1.68 H	65	25.30	30.40
4	2390.00	44.70 AV	54.00	-9.30	1.68 H	65	14.30	30.40
5	*2412.00	102.70 PK			1.54 H	247	72.20	30.50
5	*2412.00	93.80 AV			1.54 H	247	63.20	30.50
6	4824.00	41.80 PK	74.00	-32.20	1.63 H	62	5.60	36.20
7	7236.00	46.80 PK	74.00	-27.20	1.54 H	3	5.20	41.70
8	9648.00	49.30 PK	74.00	-24.70	1.54 H	24	4.40	44.90

ANTENNA POLARITY & TEST DISTANCE: VERTICAL AT 3 M

No.	Freq. (MHz)	Emission Level (dBuV/m)	Limit (dBuV/m)	Margin (dB)	Antenna Height (m)	Table Angle (Degree)	Raw Value (dBuV)	Correction Factor (dB/m)
1	2016.00	44.30 PK	74.00	-29.70	1.47 V	52	15.00	29.20
2	2280.00	42.90 PK	74.00	-31.10	1.14 V	245	12.90	30.10
3	2292.00	43.80 PK	74.00	-30.20	1.14 V	350	13.70	30.10
4	2360.00	56.30 PK	74.00	-17.70	1.11 V	242	26.00	30.30
4	2360.00	47.00 AV	54.00	-7.00	1.11 V	242	16.60	30.30
5	2390.00	61.40 PK	74.00	-12.60	1.13 V	325	31.00	30.40
5	2390.00	52.70 AV	54.00	-1.30	1.13 V	325	22.30	30.40
6	*2412.00	109.00 PK			1.17 V	225	78.40	30.50
6	*2412.00	100.20 AV			1.17 V	225	69.70	30.50
7	4824.00	45.50 PK	74.00	-28.50	1.32 V	65	9.30	36.20
8	7236.00	49.10 PK	74.00	-24.90	1.20 V	20	7.50	41.70
9	9648.00	49.30 PK	74.00	-24.70	1.24 V	52	4.40	44.90

- NOTE:**
1. Emission level = Raw Value - Correction Factor
 2. Correction Factor = External Preamp. Gain - Ant. Factor - Cable loss
(External Preamp. Gain = 0, when the test receiver is used for the test.)
 3. The other emission levels were very low against the limit.
 4. Margin value = Emission level - Limit value
 5. The limit value is defined as per 15.247
 6. " * " : Fundamental frequency



EUT	Flanker Pro Single Radio AP	MODEL	AP-AG-AT-01
MODE	Channel 6	FREQUENCY RANGE	1000MHz~25000MHz
INPUT POWER (SYSTEM)	120Vac, 60Hz	DETECTOR FUNCTION	Peak(PK) Average (AV)
ENVIRONMENTAL CONDITIONS	26deg. C, 67%RH, 972 hPa	TESTED BY	Eric Lee

ANTENNA POLARITY & TEST DISTANCE: HORIZONTAL AT 3 M								
No.	Freq. (MHz)	Emission Level (dBuV/m)	Limit (dBuV/m)	Margin (dB)	Antenna Height (m)	Table Angle (Degree)	Raw Value (dBuV)	Correction Factor (dB/m)
1	2016.00	44.50 PK	74.00	-29.50	1.57 H	74	15.30	29.20
2	2267.00	41.50 PK	74.00	-32.50	1.54 H	357	11.50	30.00
3	2356.00	53.80 PK	74.00	-20.20	1.00 H	359	23.50	30.30
3	2356.00	45.20 AV	54.00	-8.80	1.00 H	359	14.90	30.30
4	2360.00	52.10 PK	74.00	-21.90	1.65 H	24	21.70	30.30
4	2360.00	44.50 AV	54.00	-9.50	1.65 H	24	14.20	30.30
5	2390.00	56.50 PK	74.00	-17.50	1.62 H	302	26.00	30.40
5	2390.00	43.90 AV	54.00	-10.10	1.62 H	302	13.50	30.40
6	*2437.00	110.70 PK			1.00 H	356	80.00	30.70
6	*2437.00	102.10 AV			1.00 H	356	71.50	30.70
7	2483.50	57.50 PK	74.00	-16.50	1.65 H	244	26.60	31.00
7	2483.50	45.00 AV	54.00	-9.00	1.65 H	244	14.10	31.00
8	4874.00	53.30 PK	74.00	-20.70	1.67 H	95	16.90	36.50
8	4874.00	40.90 AV	54.00	-13.10	1.67 H	95	4.40	36.50
9	7311.00	46.80 PK	74.00	-27.20	1.65 H	349	5.00	41.80
10	9748.00	49.20 PK	74.00	-24.80	1.02 H	4	4.50	44.60

- NOTE:**
1. Emission level = Raw Value - Correction Factor
 2. Correction Factor = External Preamp. Gain - Ant. Factor - Cable loss
(External Preamp. Gain = 0, when the test receiver is used for the test.)
 3. The other emission levels were very low against the limit.
 4. Margin value = Emission level - Limit value
 5. The limit value is defined as per 15.247
 6. "*" : Fundamental frequency



EUT	Flanker Pro Single Radio AP	MODEL	AP-AG-AT-01
MODE	Channel 6	FREQUENCY RANGE	1000MHz~25000MHz
INPUT POWER (SYSTEM)	120Vac, 60Hz	DETECTOR FUNCTION	Peak(PK) Average (AV)
ENVIRONMENTAL CONDITIONS	26deg. C, 67%RH, 972 hPa	TESTED BY	Eric Lee

ANTENNA POLARITY & TEST DISTANCE: VERTICAL AT 3 M

No.	Freq. (MHz)	Emission Level (dBuV/m)	Limit (dBuV/m)	Margin (dB)	Antenna Height (m)	Table Angle (Degree)	Raw Value (dBuV)	Correction Factor (dB/m)
1	2016.00	51.10 PK	74.00	-22.90	1.16 V	187	21.90	29.20
1	2016.00	48.00 AV	54.00	-6.00	1.16 V	187	18.80	29.20
2	2267.00	48.70 PK	74.00	-25.30	1.16 V	349	18.70	30.00
3	2356.00	60.60 PK	74.00	-13.40	1.20 V	2	30.30	30.30
3	2356.00	51.00 AV	54.00	-3.00	1.20 V	2	20.70	30.30
4	2360.00	60.60 PK	74.00	-13.40	1.20 V	4	30.30	30.30
4	2360.00	51.40 AV	54.00	-2.60	1.20 V	4	21.00	30.30
5	2390.00	67.10 PK	74.00	-6.90	1.32 V	56	36.70	30.40
5	2390.00	51.60 AV	54.00	-2.40	1.32 V	56	21.10	30.40
6	*2437.00	117.50 PK			1.22 V	29	86.80	30.70
6	*2437.00	108.50 AV			1.22 V	29	77.80	30.70
7	2483.50	68.00 PK	74.00	-6.00	1.14 V	6	37.00	31.00
7	2483.50	50.90 AV	54.00	-3.10	1.14 V	6	19.90	31.00
8	4874.00	60.30 PK	74.00	-13.70	1.11 V	2	23.90	36.50
8	4874.00	47.90 AV	54.00	-6.10	1.11 V	2	11.40	36.50
9	7311.00	48.00 PK	74.00	-26.00	1.11 V	0	6.20	41.80
10	10000.00	49.90 PK	74.00	-24.10	1.24 V	3	5.90	44.00

- NOTE:**
1. Emission level = Raw Value - Correction Factor
 2. Correction Factor = External Preamp. Gain - Ant. Factor - Cable loss
(External Preamp. Gain = 0, when the test receiver is used for the test.)
 3. The other emission levels were very low against the limit.
 4. Margin value = Emission level - Limit value
 5. The limit value is defined as per 15.247
 6. “ * ” : Fundamental frequency



EUT	Flanker Pro Single Radio AP	MODEL	AP-AG-AT-01
MODE	Channel 11	FREQUENCY RANGE	1000MHz~25000MHz
INPUT POWER (SYSTEM)	120Vac, 60Hz	DETECTOR FUNCTION	Peak(PK) Average (AV)
ENVIRONMENTAL CONDITIONS	17deg. C, 68%RH, 972 hPa	TESTED BY	Eric Lee

ANTENNA POLARITY & TEST DISTANCE: HORIZONTAL AT 3M

No.	Freq. (MHz)	Emission Level (dBuV/m)	Limit (dBuV/m)	Margin (dB)	Antenna Height (m)	Table Angle (Degree)	Raw Value (dBuV)	Correction Factor (dB/m)
1	2016.00	37.40 PK	74.00	-36.60	1.15 H	246	8.10	29.20
2	2360.00	48.50 PK	74.00	-25.50	1.65 H	326	18.20	30.30
3	*2462.00	102.10 PK			1.54 H	354	71.20	30.80
3	*2462.00	94.10 AV			1.54 H	354	63.20	30.80
4	2483.50	52.20 PK	74.00	-21.80	1.54 H	248	21.30	31.00
4	2483.50	43.30 AV	54.00	-10.70	1.54 H	248	12.30	31.00
5	4924.00	43.20 PK	74.00	-30.80	1.65 H	325	6.50	36.70
6	7386.00	47.70 PK	74.00	-26.30	1.02 H	258	5.80	41.80
7	9848.00	50.40 PK	74.00	-23.60	1.11 H	95	6.00	44.40

ANTENNA POLARITY & TEST DISTANCE: VERTICAL AT 3M

No.	Freq. (MHz)	Emission Level (dBuV/m)	Limit (dBuV/m)	Margin (dB)	Antenna Height (m)	Table Angle (Degree)	Raw Value (dBuV)	Correction Factor (dB/m)
1	2016.00	45.40 PK	74.00	-28.60	1.36 V	62	16.10	29.20
2	2360.00	56.40 PK	74.00	-17.60	1.72 V	35	26.10	30.30
2	2360.00	48.20 AV	54.00	-5.80	1.72 V	35	17.90	30.30
3	*2462.00	109.50 PK			1.20 V	11	78.70	30.80
3	*2462.00	101.50 AV			1.20 V	11	70.70	30.80
4	2483.50	60.20 PK	74.00	-13.80	1.32 V	65	29.30	31.00
4	2483.50	51.90 AV	54.00	-2.10	1.32 V	65	20.90	31.00
5	4924.00	45.40 PK	74.00	-28.60	1.53 V	62	8.70	36.70
6	7386.00	50.50 PK	74.00	-23.50	1.32 V	254	8.70	41.80
7	9848.00	49.90 PK	74.00	-24.10	1.20 V	2	5.60	44.40

- NOTE:**
1. Emission level= Raw Value - Correction Factor
 2. Correction Factor = External Preamp. Gain - Ant. Factor - Cable loss
(External Preamp. Gain = 0, when the test receiver is used for the test.)
 3. The other emission levels were very low against the limit.
 4. Margin value = Emission level - Limit value
 5. The limit value is defined as per 15.247
 6. " * " : Fundamental frequency



4.2.19 TEST RESULTS - OFDM (ANTENNA 5)

EUT	Flanker Pro Single Radio AP	MODEL	AP-AG-AT-01
MODE	Channel 1	FREQUENCY RANGE	1000MHz~25000MHz
INPUT POWER (SYSTEM)	120Vac, 60Hz	DETECTOR FUNCTION	Peak(PK) Average (AV)
ENVIRONMENTAL CONDITIONS	17deg. C, 68%RH, 972 hPa	TESTED BY	Eric Lee

ANTENNA POLARITY & TEST DISTANCE: HORIZONTAL AT 3 M

No.	Freq. (MHz)	Emission Level (dBuV/m)	Limit (dBuV/m)	Margin (dB)	Antenna Height (m)	Table Angle (Degree)	Raw Value (dBuV)	Correction Factor (dB/m)
1	2016.00	37.50 PK	74.00	-36.50	1.20 H	20	8.20	29.20
2	2290.00	34.70 PK	74.00	-39.30	1.02 H	4	4.60	30.10
3	2360.00	47.10 PK	74.00	-26.90	1.11 H	2	16.80	30.30
4	2390.00	45.20 PK	74.00	-28.80	1.11 H	24	14.80	30.40
5	*2412.00	83.80 PK			1.02 H	34	53.30	30.50
5	*2412.00	76.00 AV			1.02 H	34	45.50	30.50
6	4824.00	41.70 PK	74.00	-32.30	1.54 H	2	5.50	36.20
7	7236.00	46.90 PK	74.00	-27.10	1.11 H	326	5.20	41.70
8	9648.00	47.10 PK	74.00	-26.90	1.18 H	52	2.20	44.90

ANTENNA POLARITY & TEST DISTANCE: VERTICAL AT 3 M

No.	Freq. (MHz)	Emission Level (dBuV/m)	Limit (dBuV/m)	Margin (dB)	Antenna Height (m)	Table Angle (Degree)	Raw Value (dBuV)	Correction Factor (dB/m)
1	2016.00	41.90 PK	74.00	-32.10	1.01 V	4	12.60	29.20
2	2292.00	42.80 PK	74.00	-31.20	1.01 V	12	12.70	30.10
3	2360.00	58.00 PK	74.00	-16.00	1.45 V	321	27.70	30.30
3	2360.00	48.10 AV	54.00	-5.90	1.45 V	321	17.70	30.30
4	2390.00	63.90 PK	74.00	-10.10	1.02 V	4	33.50	30.40
4	2390.00	52.80 AV	54.00	-1.20	1.02 V	4	22.40	30.40
5	*2412.00	108.90 PK			1.00 V	8	78.40	30.50
5	*2412.00	100.00 AV			1.00 V	8	69.50	30.50
6	4824.00	42.40 PK	74.00	-31.60	1.54 V	22	6.20	36.20
7	7236.00	47.50 PK	74.00	-26.50	1.54 V	21	5.80	41.70
8	9648.00	48.70 PK	74.00	-25.30	1.11 V	2	3.80	44.90

- NOTE:**
1. Emission level = Raw Value - Correction Factor
 2. Correction Factor = External Preamp. Gain - Ant. Factor - Cable loss
(External Preamp. Gain = 0, when the test receiver is used for the test.)
 3. The other emission levels were very low against the limit.
 4. Margin value = Emission level - Limit value
 5. The limit value is defined as per 15.247
 6. " * " : Fundamental frequency



EUT	Flanker Pro Single Radio AP	MODEL	AP-AG-AT-01
MODE	Channel 6	FREQUENCY RANGE	1000MHz~25000MHz
INPUT POWER (SYSTEM)	120Vac, 60Hz	DETECTOR FUNCTION	Peak(PK) Average (AV)
ENVIRONMENTAL CONDITIONS	26deg. C, 67%RH, 972 hPa	TESTED BY	Eric Lee

ANTENNA POLARITY & TEST DISTANCE: HORIZONTAL AT 3 M

No.	Freq. (MHz)	Emission Level (dBuV/m)	Limit (dBuV/m)	Margin (dB)	Antenna Height (m)	Table Angle (Degree)	Raw Value (dBuV)	Correction Factor (dB/m)
1	2016.00	46.50 PK	74.00	-27.50	1.23 H	359	17.20	29.20
2	2290.00	38.40 PK	74.00	-35.60	1.45 H	65	8.30	30.10
3	2360.00	51.10 PK	74.00	-22.90	1.14 H	23	20.70	30.30
3	2360.00	42.10 AV	54.00	-11.90	1.14 H	23	11.70	30.30
4	2390.00	45.60 PK	74.00	-28.40	1.54 H	8	15.20	30.40
5	*2437.00	91.00 PK			1.65 H	2	60.30	30.70
5	*2437.00	82.90 AV			1.65 H	2	52.20	30.70
6	2483.50	47.60 PK	74.00	-26.40	1.63 H	321	16.70	31.00
7	4874.00	40.90 PK	74.00	-33.10	1.45 H	26	4.40	36.50
8	7311.00	48.10 PK	74.00	-25.90	1.25 H	65	6.30	41.80
9	9748.00	49.30 PK	74.00	-24.70	1.08 H	9	4.60	44.60

ANTENNA POLARITY & TEST DISTANCE: VERTICAL AT 3 M

No.	Freq. (MHz)	Emission Level (dBuV/m)	Limit (dBuV/m)	Margin (dB)	Antenna Height (m)	Table Angle (Degree)	Raw Value (dBuV)	Correction Factor (dB/m)
1	2016.00	48.00 PK	74.00	-26.00	1.21 V	4	18.80	29.20
2	2290.00	47.90 PK	74.00	-26.10	1.47 V	54	17.80	30.10
3	2360.00	62.00 PK	74.00	-12.00	1.25 V	9	31.70	30.30
3	2360.00	52.70 AV	54.00	-1.30	1.25 V	9	22.40	30.30
4	2390.00	59.10 PK	74.00	-14.90	1.23 V	3	28.70	30.40
4	2390.00	50.50 AV	54.00	-3.50	1.23 V	3	20.10	30.40
5	*2437.00	115.20 PK			1.01 V	6	84.50	30.70
5	*2437.00	107.40 AV			1.01 V	6	76.70	30.70
6	2483.50	58.80 PK	74.00	-15.20	1.42 V	1	27.80	31.00
6	2483.50	49.90 AV	54.00	-4.10	1.42 V	1	18.90	31.00
7	4874.00	49.60 PK	74.00	-24.40	1.04 V	25	13.10	36.50
8	7311.00	48.50 PK	74.00	-25.50	1.00 V	0	6.80	41.80
9	9748.00	50.30 PK	74.00	-23.70	1.54 V	21	5.60	44.60

- NOTE:**
1. Emission level = Raw Value - Correction Factor
 2. Correction Factor = External Preamp. Gain - Ant. Factor - Cable loss
(External Preamp. Gain = 0, when the test receiver is used for the test.)
 3. The other emission levels were very low against the limit.
 4. Margin value = Emission level - Limit value
 5. The limit value is defined as per 15.247
 6. " * " : Fundamental frequency



EUT	Flanker Pro Single Radio AP	MODEL	AP-AG-AT-01
MODE	Channel 11	FREQUENCY RANGE	1000MHz~25000MHz
INPUT POWER (SYSTEM)	120Vac, 60Hz	DETECTOR FUNCTION	Peak(PK) Average (AV)
ENVIRONMENTAL CONDITIONS	17deg. C, 68%RH, 972 hPa	TESTED BY	Eric Lee

ANTENNA POLARITY & TEST DISTANCE: HORIZONTAL AT 3M

No.	Freq. (MHz)	Emission Level (dBuV/m)	Limit (dBuV/m)	Margin (dB)	Antenna Height (m)	Table Angle (Degree)	Raw Value (dBuV)	Correction Factor (dB/m)
1	2016.00	33.10 PK	74.00	-40.90	1.10 H	2	3.90	29.20
2	2290.00	36.30 PK	74.00	-37.70	1.54 H	9	6.20	30.10
3	2360.00	45.10 PK	74.00	-28.90	1.32 H	63	14.80	30.30
4	*2462.00	86.20 PK			1.65 H	2	55.30	30.80
4	*2462.00	77.70 AV			1.65 H	2	46.90	30.80
5	2483.50	48.30 PK	74.00	-25.70	1.63 H	32	17.30	31.00
6	4924.00	41.70 PK	74.00	-32.30	1.54 H	20	5.00	36.70
7	7386.00	46.30 PK	74.00	-27.70	1.11 H	23	4.50	41.80
8	9848.00	49.40 PK	74.00	-24.60	1.13 H	65	5.10	44.40

ANTENNA POLARITY & TEST DISTANCE: VERTICAL AT 3M

No.	Freq. (MHz)	Emission Level (dBuV/m)	Limit (dBuV/m)	Margin (dB)	Antenna Height (m)	Table Angle (Degree)	Raw Value (dBuV)	Correction Factor (dB/m)
1	2016.00	43.10 PK	74.00	-30.90	1.45 V	2	13.90	29.20
2	2290.00	46.80 PK	74.00	-27.20	1.54 V	354	16.70	30.10
3	2360.00	59.20 PK	74.00	-14.80	1.01 V	2	28.90	30.30
3	2360.00	48.70 AV	54.00	-5.30	1.01 V	2	18.40	30.30
4	*2462.00	110.00 PK			1.01 V	8	79.20	30.80
4	*2462.00	101.70 AV			1.01 V	8	70.90	30.80
5	2483.50	64.50 PK	74.00	-9.50	1.23 V	3	33.50	31.00
5	2483.50	52.30 AV	54.00	-1.70	1.23 V	3	21.30	31.00
6	4924.00	46.90 PK	74.00	-27.10	1.67 V	91	10.20	36.70
7	7386.00	49.90 PK	74.00	-24.10	1.42 V	208	8.00	41.80
8	9848.00	52.20 PK	74.00	-21.80	1.01 V	8	7.80	44.40
8	9848.00	39.00 AV	54.00	-15.00	1.01 V	8	-5.30	44.40

- NOTE:**
1. Emission level= Raw Value - Correction Factor
 2. Correction Factor = External Preamp. Gain - Ant. Factor - Cable loss
(External Preamp. Gain = 0, when the test receiver is used for the test.)
 3. The other emission levels were very low against the limit.
 4. Margin value = Emission level - Limit value
 5. The limit value is defined as per 15.247
 6. " * " : Fundamental frequency



4.2.20 TEST RESULTS - OFDM (ANTENNA 6)

EUT	Flanker Pro Single Radio AP	MODEL	AP-AG-AT-01
MODE	Channel 1	FREQUENCY RANGE	1000MHz~25000MHz
INPUT POWER (SYSTEM)	120Vac, 60Hz	DETECTOR FUNCTION	Peak(PK) Average (AV)
ENVIRONMENTAL CONDITIONS	17deg. C, 68%RH, 972 hPa	TESTED BY	Eric Lee

ANTENNA POLARITY & TEST DISTANCE: HORIZONTAL AT 3 M

No.	Freq. (MHz)	Emission Level (dBuV/m)	Limit (dBuV/m)	Margin (dB)	Antenna Height (m)	Table Angle (Degree)	Raw Value (dBuV)	Correction Factor (dB/m)
1	2016.00	34.60 PK	74.00	-39.40	1.52 H	20	5.40	29.20
2	2292.00	35.20 PK	74.00	-38.80	1.36 H	5	5.10	30.10
3	2360.00	42.50 PK	74.00	-31.50	1.32 H	54	12.10	30.30
4	2390.00	46.70 PK	74.00	-27.30	1.32 H	6	16.30	30.40
5	*2412.00	84.40 PK			1.20 H	12	53.80	30.50
5	*2412.00	76.20 AV			1.20 H	12	45.70	30.50
6	4824.00	40.20 PK	74.00	-33.80	1.54 H	11	4.00	36.20
7	7236.00	46.50 PK	74.00	-27.50	1.12 H	31	4.90	41.70
8	9648.00	46.10 PK	74.00	-27.90	1.10 H	359	1.20	44.90

ANTENNA POLARITY & TEST DISTANCE: VERTICAL AT 3 M

No.	Freq. (MHz)	Emission Level (dBuV/m)	Limit (dBuV/m)	Margin (dB)	Antenna Height (m)	Table Angle (Degree)	Raw Value (dBuV)	Correction Factor (dB/m)
1	2016.00	36.60 PK	74.00	-37.40	1.02 V	2	7.40	29.20
2	2292.00	44.30 PK	74.00	-29.70	1.18 V	9	14.20	30.10
3	2360.00	56.50 PK	74.00	-17.50	1.19 V	5	26.20	30.30
3	2360.00	46.00 AV	54.00	-8.00	1.19 V	5	15.70	30.30
4	2390.00	64.00 PK	74.00	-10.00	1.54 V	24	33.60	30.40
4	2390.00	52.50 AV	54.00	-1.50	1.54 V	24	22.10	30.40
5	*2412.00	108.40 PK			1.13 V	9	77.80	30.50
5	*2412.00	99.60 AV			1.13 V	9	69.00	30.50
6	4824.00	43.80 PK	74.00	-30.20	1.25 V	24	7.50	36.20
7	7236.00	47.40 PK	74.00	-26.60	1.02 V	54	5.80	41.70
8	9648.00	50.70 PK	74.00	-23.30	1.11 V	2	5.80	44.90

- NOTE:**
1. Emission level = Raw Value - Correction Factor
 2. Correction Factor = External Preamp. Gain - Ant. Factor - Cable loss
(External Preamp. Gain = 0, when the test receiver is used for the test.)
 3. The other emission levels were very low against the limit.
 4. Margin value = Emission level - Limit value
 5. The limit value is defined as per 15.247
 6. " * " : Fundamental frequency



EUT	Flanker Pro Single Radio AP	MODEL	AP-AG-AT-01
MODE	Channel 6	FREQUENCY RANGE	1000MHz~25000MHz
INPUT POWER (SYSTEM)	120Vac, 60Hz	DETECTOR FUNCTION	Peak(PK) Average (AV)
ENVIRONMENTAL CONDITIONS	26deg. C, 67%RH, 972 hPa	TESTED BY	Eric Lee

ANTENNA POLARITY & TEST DISTANCE: HORIZONTAL AT 3 M								
No.	Freq. (MHz)	Emission Level (dBuV/m)	Limit (dBuV/m)	Margin (dB)	Antenna Height (m)	Table Angle (Degree)	Raw Value (dBuV)	Correction Factor (dB/m)
1	2016.00	27.00 PK	74.00	-47.00	1.68 H	7	-2.20	29.20
2	2290.00	35.00 PK	74.00	-39.00	1.54 H	24	4.90	30.10
3	2360.00	42.40 PK	74.00	-31.60	1.54 H	17	12.10	30.30
4	2390.00	47.50 PK	74.00	-26.50	1.32 H	54	17.10	30.40
5	*2437.00	90.00 PK			1.32 H	356	59.30	30.70
5	*2437.00	81.90 AV			1.32 H	356	51.20	30.70
6	2483.50	44.30 PK	74.00	-29.70	1.11 H	44	13.30	31.00
7	4874.00	41.90 PK	74.00	-32.10	1.21 H	41	5.40	36.50
8	7311.00	45.70 PK	74.00	-28.30	1.02 H	1	3.90	41.80
9	9748.00	49.70 PK	74.00	-24.30	1.02 H	3	5.10	44.60

ANTENNA POLARITY & TEST DISTANCE: VERTICAL AT 3 M								
No.	Freq. (MHz)	Emission Level (dBuV/m)	Limit (dBuV/m)	Margin (dB)	Antenna Height (m)	Table Angle (Degree)	Raw Value (dBuV)	Correction Factor (dB/m)
1	2016.00	37.60 PK	74.00	-36.40	1.12 V	32	8.40	29.20
2	2290.00	47.10 PK	74.00	-26.90	1.01 V	7	17.00	30.10
3	2360.00	59.50 PK	74.00	-14.50	1.15 V	0	29.20	30.30
3	2360.00	49.60 AV	54.00	-4.40	1.15 V	0	19.30	30.30
4	2390.00	60.10 PK	74.00	-13.90	1.12 V	5	29.70	30.40
4	2390.00	48.60 AV	54.00	-5.40	1.12 V	5	18.20	30.40
5	*2437.00	113.90 PK			1.10 V	14	83.20	30.70
5	*2437.00	105.10 AV			1.10 V	14	74.40	30.70
6	2483.50	57.60 PK	74.00	-16.40	1.12 V	3	26.70	31.00
6	2483.50	47.50 AV	54.00	-6.50	1.12 V	3	16.60	31.00
7	4874.00	46.50 PK	74.00	-27.50	1.53 V	6	10.00	36.50
8	7311.00	50.00 PK	74.00	-24.00	1.52 V	32	8.30	41.80
9	9748.00	51.00 PK	74.00	-23.00	1.21 V	1	6.30	44.60
9	9748.00	39.30 AV	54.00	-14.70	1.21 V	1	-5.30	44.60

- NOTE:**
1. Emission level = Raw Value - Correction Factor
 2. Correction Factor = External Preamp. Gain - Ant. Factor - Cable loss
(External Preamp. Gain = 0, when the test receiver is used for the test.)
 3. The other emission levels were very low against the limit.
 4. Margin value = Emission level - Limit value
 5. The limit value is defined as per 15.247
 6. " * " : Fundamental frequency



EUT	Flanker Pro Single Radio AP	MODEL	AP-AG-AT-01
MODE	Channel 11	FREQUENCY RANGE	1000MHz~25000MHz
INPUT POWER (SYSTEM)	120Vac, 60Hz	DETECTOR FUNCTION	Peak(PK) Average (AV)
ENVIRONMENTAL CONDITIONS	17deg. C, 68%RH, 972 hPa	TESTED BY	Eric Lee

ANTENNA POLARITY & TEST DISTANCE: HORIZONTAL AT 3M

No.	Freq. (MHz)	Emission Level (dBuV/m)	Limit (dBuV/m)	Margin (dB)	Antenna Height (m)	Table Angle (Degree)	Raw Value (dBuV)	Correction Factor (dB/m)
1	2016.00	25.10 PK	74.00	-48.90	1.02 H	1	-4.10	29.20
2	2290.00	36.10 PK	74.00	-37.90	1.02 H	22	6.00	30.10
3	2360.00	42.50 PK	74.00	-31.50	1.52 H	333	12.10	30.30
4	*2462.00	85.10 PK			1.32 H	9	54.20	30.80
4	*2462.00	77.40 AV			1.32 H	9	46.50	30.80
5	2483.50	49.20 PK	74.00	-24.80	1.14 H	2	18.20	31.00
6	4924.00	43.20 PK	74.00	-30.80	1.02 H	32	6.50	36.70
7	7386.00	44.60 PK	74.00	-29.40	1.87 H	52	2.80	41.80
8	9848.00	46.10 PK	74.00	-27.90	1.11 H	20	1.80	44.40

ANTENNA POLARITY & TEST DISTANCE: VERTICAL AT 3M

No.	Freq. (MHz)	Emission Level (dBuV/m)	Limit (dBuV/m)	Margin (dB)	Antenna Height (m)	Table Angle (Degree)	Raw Value (dBuV)	Correction Factor (dB/m)
1	2016.00	31.10 PK	74.00	-42.90	1.02 V	24	1.90	29.20
2	2290.00	42.70 PK	74.00	-31.30	1.68 V	9	12.60	30.10
3	2360.00	54.60 PK	74.00	-19.40	1.14 V	1	24.20	30.30
3	2360.00	45.90 AV	54.00	-8.10	1.14 V	1	15.60	30.30
4	*2462.00	110.30 PK			1.08 V	1	79.50	30.80
4	*2462.00	102.00 AV			1.08 V	1	71.20	30.80
5	2483.50	63.20 PK	74.00	-10.80	1.42 V	350	32.20	31.00
5	2483.50	52.90 AV	54.00	-1.10	1.42 V	350	21.90	31.00
6	4924.00	43.10 PK	74.00	-30.90	1.24 V	2	6.40	36.70
7	7386.00	48.70 PK	74.00	-25.30	1.01 V	0	6.80	41.80
8	9848.00	50.10 PK	74.00	-23.90	1.01 V	25	5.80	44.40

- NOTE:**
1. Emission level= Raw Value - Correction Factor
 2. Correction Factor = External Preamp. Gain - Ant. Factor - Cable loss
(External Preamp. Gain = 0, when the test receiver is used for the test.)
 3. The other emission levels were very low against the limit.
 4. Margin value = Emission level - Limit value
 5. The limit value is defined as per 15.247
 6. " * " : Fundamental frequency



4.2.21 TEST RESULTS - OFDM (ANTENNA 7)

EUT	Flanker Pro Single Radio AP	MODEL	AP-AG-AT-01
MODE	Channel 3	FREQUENCY RANGE	1000MHz~25000MHz
INPUT POWER (SYSTEM)	120Vac, 60Hz	DETECTOR FUNCTION	Peak(PK) Average (AV)
ENVIRONMENTAL CONDITIONS	17deg. C, 68%RH, 972 hPa	TESTED BY	Eric Lee

ANTENNA POLARITY & TEST DISTANCE: HORIZONTAL AT 3 M

No.	Freq. (MHz)	Emission Level (dBuV/m)	Limit (dBuV/m)	Margin (dB)	Antenna Height (m)	Table Angle (Degree)	Raw Value (dBuV)	Correction Factor (dB/m)
1	2016.00	36.20 PK	74.00	-37.80	1.10 H	69	6.90	29.20
2	2282.00	36.20 PK	74.00	-37.80	1.15 H	189	6.10	30.10
3	2292.00	33.80 PK	74.00	-40.20	1.16 H	187	3.70	30.10
4	2360.00	43.70 PK	74.00	-30.30	1.18 H	65	13.40	30.30
5	2390.00	39.40 PK	74.00	-34.60	1.14 H	63	9.00	30.40
6	*2422.00	92.80 PK			1.15 H	63	62.20	30.60
6	*2422.00	82.90 AV			1.15 H	63	52.30	30.60
7	4844.00	42.20 PK	74.00	-31.80	1.15 H	188	5.90	36.30
8	7266.00	47.20 PK	74.00	-26.80	1.14 H	189	5.50	41.70
9	9688.00	47.50 PK	74.00	-26.50	1.14 H	189	2.80	44.80

ANTENNA POLARITY & TEST DISTANCE: VERTICAL AT 3 M

No.	Freq. (MHz)	Emission Level (dBuV/m)	Limit (dBuV/m)	Margin (dB)	Antenna Height (m)	Table Angle (Degree)	Raw Value (dBuV)	Correction Factor (dB/m)
1	2016.00	45.10 PK	74.00	-28.90	1.09 V	182	15.80	29.20
2	2282.00	43.30 PK	74.00	-30.70	1.14 V	193	13.20	30.10
3	2292.00	48.50 PK	74.00	-25.50	1.14 V	189	18.40	30.10
4	2360.00	60.60 PK	74.00	-13.40	1.13 V	187	30.20	30.30
4	2360.00	51.00 AV	54.00	-3.00	1.13 V	187	20.70	30.30
5	2390.00	60.20 PK	74.00	-13.80	1.16 V	178	29.80	30.40
5	2390.00	52.00 AV	54.00	-2.00	1.16 V	178	21.60	30.40
6	*2422.00	113.60 PK			1.13 V	187	83.00	30.60
6	*2422.00	105.40 AV			1.13 V	187	74.80	30.60
7	4844.00	42.00 PK	74.00	-32.00	1.09 V	167	5.70	36.30
8	7266.00	47.90 PK	74.00	-26.10	1.13 V	187	6.20	41.70
9	9688.00	47.80 PK	74.00	-26.20	1.12 V	188	3.00	44.80

- NOTE:**
1. Emission level = Raw Value - Correction Factor
 2. Correction Factor = External Preamp. Gain - Ant. Factor - Cable loss
(External Preamp. Gain = 0, when the test receiver is used for the test.)
 3. The other emission levels were very low against the limit.
 4. Margin value = Emission level - Limit value
 5. The limit value is defined as per 15.247
 6. " * " : Fundamental frequency



EUT	Flanker Pro Single Radio AP	MODEL	AP-AG-AT-01
MODE	Channel 6	FREQUENCY RANGE	1000MHz~25000MHz
INPUT POWER (SYSTEM)	120Vac, 60Hz	DETECTOR FUNCTION	Peak(PK) Average (AV)
ENVIRONMENTAL CONDITIONS	26deg. C, 67%RH, 972 hPa	TESTED BY	Eric Lee

ANTENNA POLARITY & TEST DISTANCE: HORIZONTAL AT 3 M								
No.	Freq. (MHz)	Emission Level (dBuV/m)	Limit (dBuV/m)	Margin (dB)	Antenna Height (m)	Table Angle (Degree)	Raw Value (dBuV)	Correction Factor (dB/m)
1	2016.00	36.00 PK	74.00	-38.00	1.13 H	184	6.70	29.20
2	2282.00	36.40 PK	74.00	-37.60	1.14 H	189	6.30	30.10
3	2292.00	36.60 PK	74.00	-37.40	1.16 H	180	6.50	30.10
4	2360.00	47.50 PK	74.00	-26.50	1.17 H	59	17.10	30.30
5	2390.00	38.10 PK	74.00	-35.90	1.13 H	187	7.70	30.40
6	*2437.00	93.50 PK			1.15 H	184	62.80	30.70
6	*2437.00	85.70 AV			1.15 H	184	55.10	30.70
7	2483.50	39.10 PK	74.00	-34.90	1.14 H	187	8.10	31.00
8	4874.00	40.50 PK	74.00	-33.50	1.17 H	183	4.00	36.50
9	7311.00	48.20 PK	74.00	-25.80	1.15 H	180	6.40	41.80
10	9748.00	47.70 PK	74.00	-26.30	1.13 H	182	3.10	44.60

- NOTE:**
1. Emission level = Raw Value - Correction Factor
 2. Correction Factor = External Preamp. Gain - Ant. Factor - Cable loss
(External Preamp. Gain = 0, when the test receiver is used for the test.)
 3. The other emission levels were very low against the limit.
 4. Margin value = Emission level - Limit value
 5. The limit value is defined as per 15.247
 6. " * " : Fundamental frequency



EUT	Flanker Pro Single Radio AP	MODEL	AP-AG-AT-01
MODE	Channel 6	FREQUENCY RANGE	1000MHz~25000MHz
INPUT POWER (SYSTEM)	120Vac, 60Hz	DETECTOR FUNCTION	Peak(PK) Average (AV)
ENVIRONMENTAL CONDITIONS	26deg. C, 67%RH, 972 hPa	TESTED BY	Eric Lee

ANTENNA POLARITY & TEST DISTANCE: VERTICAL AT 3 M

No.	Freq. (MHz)	Emission Level (dBuV/m)	Limit (dBuV/m)	Margin (dB)	Antenna Height (m)	Table Angle (Degree)	Raw Value (dBuV)	Correction Factor (dB/m)
1	2016.00	49.60 PK	74.00	-24.40	1.10 V	186	20.40	29.20
2	2282.00	51.20 PK	74.00	-22.80	1.17 V	178	21.10	30.10
2	2282.00	41.60 AV	54.00	-12.40	1.17 V	178	11.50	30.10
3	2292.00	53.00 PK	74.00	-21.00	1.14 V	177	22.90	30.10
3	2292.00	42.40 AV	54.00	-11.60	1.14 V	177	12.30	30.10
4	2360.00	61.50 PK	74.00	-12.50	1.10 V	179	31.10	30.30
4	2360.00	51.40 AV	54.00	-2.60	1.10 V	179	21.10	30.30
5	2390.00	62.00 PK	74.00	-12.00	1.13 V	187	31.60	30.40
5	2390.00	53.30 AV	54.00	-0.70	1.13 V	187	22.80	30.40
6	*2437.00	113.70 PK			1.11 V	186	83.00	30.70
6	*2437.00	105.30 AV			1.11 V	186	74.60	30.70
7	2483.50	64.20 PK	74.00	-9.80	1.15 V	187	33.30	31.00
7	2483.50	52.60 AV	54.00	-1.40	1.15 V	187	21.60	31.00
8	4874.00	45.10 PK	74.00	-28.90	1.14 V	179	8.70	36.50
9	7311.00	48.50 PK	74.00	-25.50	1.14 V	189	6.70	41.80
10	9748.00	49.10 PK	74.00	-24.90	1.13 V	180	4.50	44.60

- NOTE:**
1. Emission level = Raw Value - Correction Factor
 2. Correction Factor = External Preamp. Gain - Ant. Factor - Cable loss
(External Preamp. Gain = 0, when the test receiver is used for the test.)
 3. The other emission levels were very low against the limit.
 4. Margin value = Emission level - Limit value
 5. The limit value is defined as per 15.247
 6. "*" : Fundamental frequency



EUT	Flanker Pro Single Radio AP	MODEL	AP-AG-AT-01
MODE	Channel 9	FREQUENCY RANGE	1000MHz~25000MHz
INPUT POWER (SYSTEM)	120Vac, 60Hz	DETECTOR FUNCTION	Peak(PK) Average (AV)
ENVIRONMENTAL CONDITIONS	17deg. C, 68%RH, 972 hPa	TESTED BY	Eric Lee

ANTENNA POLARITY & TEST DISTANCE: HORIZONTAL AT 3M

No.	Freq. (MHz)	Emission Level (dBuV/m)	Limit (dBuV/m)	Margin (dB)	Antenna Height (m)	Table Angle (Degree)	Raw Value (dBuV)	Correction Factor (dB/m)
1	2016.00	36.10 PK	74.00	-37.90	1.14 H	85	6.90	29.20
2	2282.00	36.30 PK	74.00	-37.70	1.14 H	189	6.20	30.10
3	2292.00	36.40 PK	74.00	-37.60	1.12 H	187	6.30	30.10
4	2360.00	41.60 PK	74.00	-32.40	1.17 H	67	11.30	30.30
5	*2452.00	93.80 PK			1.11 H	63	63.00	30.80
5	*2452.00	85.40 AV			1.11 H	63	54.60	30.80
6	2483.50	39.10 PK	74.00	-34.90	1.14 H	65	8.10	31.00
7	4904.00	42.40 PK	74.00	-31.60	1.14 H	196	5.80	36.60
8	7356.00	47.90 PK	74.00	-26.10	1.17 H	186	6.00	41.80
9	9808.00	47.50 PK	74.00	-26.50	1.17 H	168	3.10	44.50

ANTENNA POLARITY & TEST DISTANCE: VERTICAL AT 3M

No.	Freq. (MHz)	Emission Level (dBuV/m)	Limit (dBuV/m)	Margin (dB)	Antenna Height (m)	Table Angle (Degree)	Raw Value (dBuV)	Correction Factor (dB/m)
1	2016.00	50.00 PK	74.00	-24.00	1.16 V	169	20.70	29.20
2	2282.00	51.60 PK	74.00	-22.40	1.14 V	157	21.60	30.10
2	2282.00	42.10 AV	54.00	-11.90	1.14 V	157	12.00	30.10
3	2292.00	53.40 PK	74.00	-20.60	1.13 V	189	23.30	30.10
3	2292.00	43.10 AV	54.00	-10.90	1.13 V	189	13.00	30.10
4	2360.00	63.50 PK	74.00	-10.50	1.21 V	178	33.20	30.30
4	2360.00	52.20 AV	54.00	-1.80	1.21 V	178	21.90	30.30
5	*2452.00	114.00 PK			1.11 V	180	83.20	30.80
5	*2452.00	106.00 AV			1.11 V	180	75.20	30.80
6	2483.50	59.10 PK	74.00	-14.90	1.11 V	167	28.20	31.00
6	2483.50	51.10 AV	54.00	-2.90	1.11 V	167	20.20	31.00
7	4909.00	43.60 PK	74.00	-30.40	1.17 V	168	6.90	36.60
8	7356.00	47.20 PK	74.00	-26.80	1.15 V	183	5.40	41.80
9	9808.00	48.90 PK	74.00	-25.10	1.14 V	197	4.40	44.50

- NOTE:**
1. Emission level= Raw Value - Correction Factor
 2. Correction Factor = External Preamp. Gain - Ant. Factor - Cable loss
(External Preamp. Gain = 0, when the test receiver is used for the test.)
 3. The other emission levels were very low against the limit.
 4. Margin value = Emission level - Limit value
 5. The limit value is defined as per 15.247
 6. " * " : Fundamental frequency



4.3 6dB BANDWIDTH MEASUREMENT

4.3.1 LIMITS OF 6dB BANDWIDTH MEASUREMENT

The minimum of 6dB Bandwidth Measurement is 0.5 MHz.

4.3.2 TEST INSTRUMENTS

Description & Manufacturer	Model No.	Serial No.	Calibrated Until
R&S SPECTRUM ANALYZER	FSP	1093.4495.30	Dec. 19, 2004

NOTE:

- 1.The measurement uncertainty is less than +/- 2.6dB, which is calculated as per the NAMAS document NIS81.
- 2.The calibration interval of the above test instruments is 12 months and the calibrations are traceable to NML/ROC and NIST/USA.

4.3.3 TEST PROCEDURE

The transmitter output was connected to the spectrum analyzer through an attenuator. The bandwidth of the fundamental frequency was measured by spectrum analyzer with 100kHz RBW and 100kHz VBW. The 6dB bandwidth is defined as the total spectrum the power of which is higher than peak power minus 6 dB.

4.3.4 DEVIATION FROM TEST STANDARD

No deviation

4.3.5 TEST SETUP

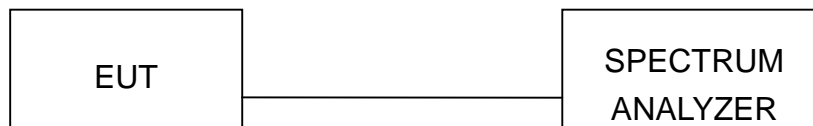

4.3.6 EUT OPERATING CONDITIONS

The software provided by client to enable the EUT under transmission condition continuously at lowest, middle and highest channel frequencies individually.



4.3.7 TEST RESULTS -DSSS

EUT	Flanker Pro Single Radio AP	MODEL	AP-AG-AT-01
INPUT POWER (SYSTEM)	120Vac, 60Hz	ENVIRONMENTAL CONDITIONS	21deg. C, 58%RH, 972 hPa
TESTED BY	Eric Lee		

CHANNEL	CHANNEL FREQUENCY (MHz)	6dB BANDWIDTH (MHz)	MINIMUM LIMIT (MHz)	PASS/FAIL
1	2412	11.69	0.5	PASS
6	2437	11.27	0.5	PASS
11	2462	11.20	0.5	PASS



CH1

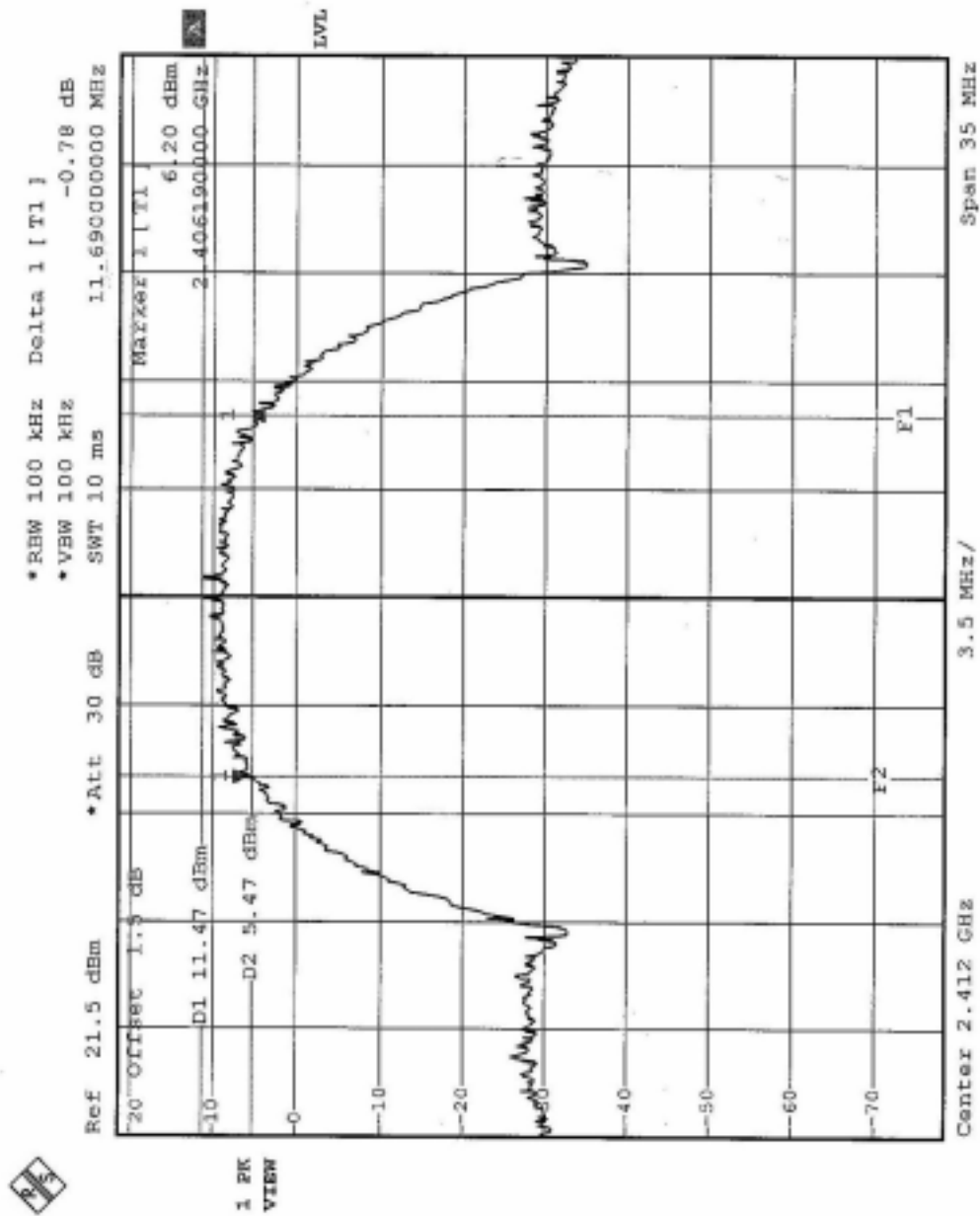



CH6

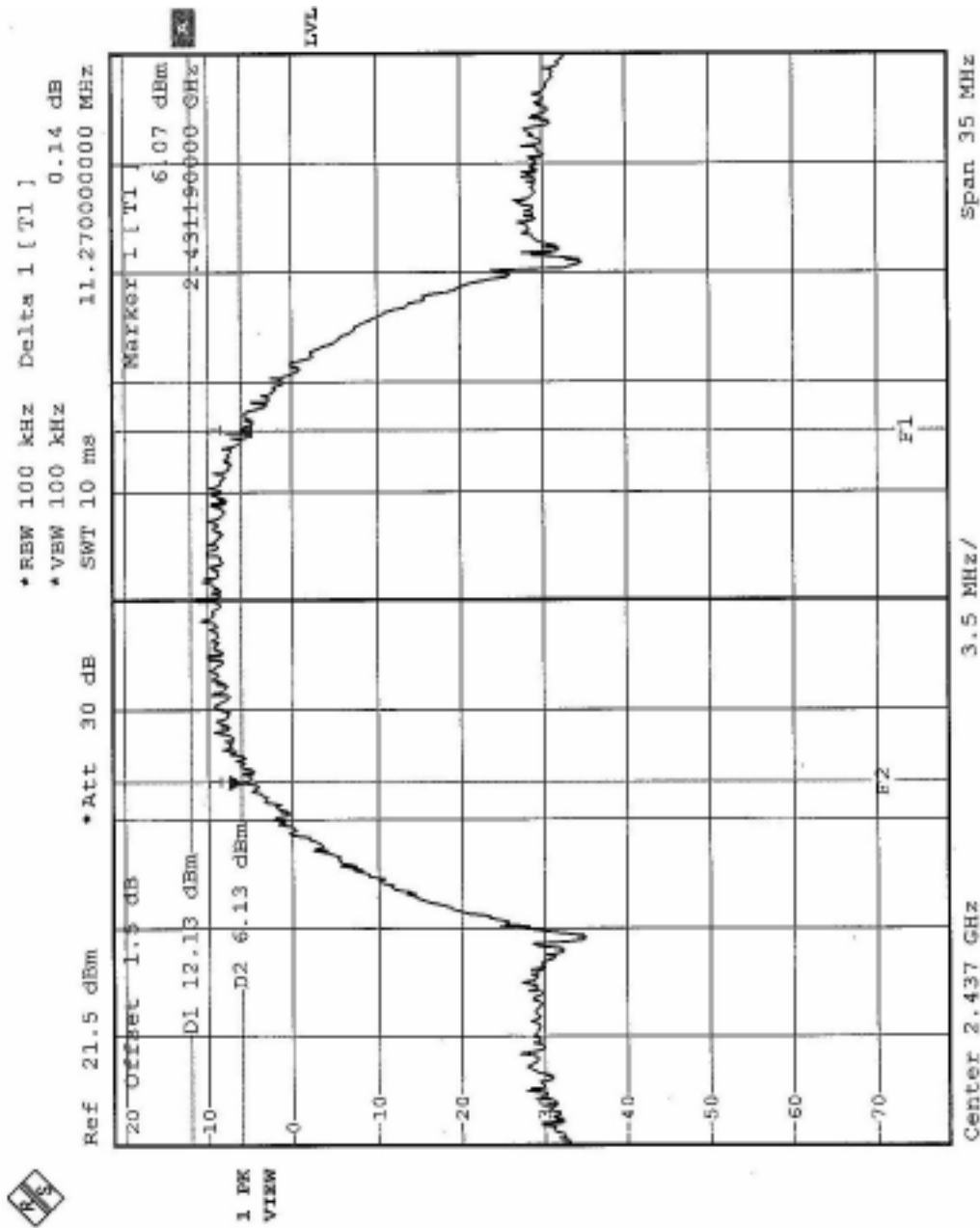



CH11

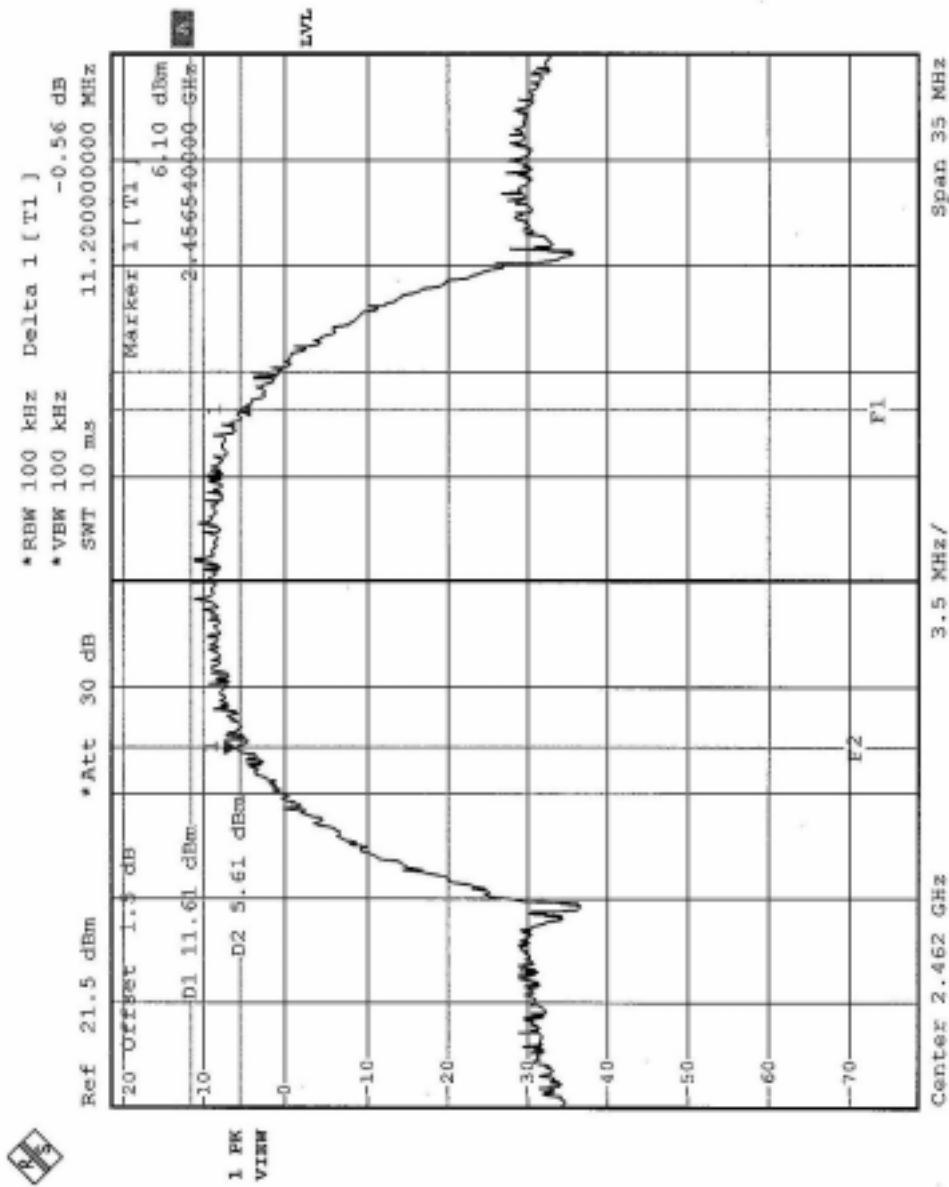



4.3.8 TEST RESULTS -OFDM

EUT	Flanker Pro Single Radio AP	MODEL	AP-AG-AT-01
INPUT POWER (SYSTEM)	120Vac, 60Hz	ENVIRONMENTAL CONDITIONS	21deg. C, 58%RH, 972 hPa
TESTED BY	Eric Lee		

CHANNEL	CHANNEL FREQUENCY (MHz)	6dB BANDWIDTH (MHz)	MINIMUM LIMIT (MHz)	PASS/FAIL
1	2412	16.38	0.5	PASS
6	2437	16.38	0.5	PASS
11	2462	16.38	0.5	PASS



CH 1

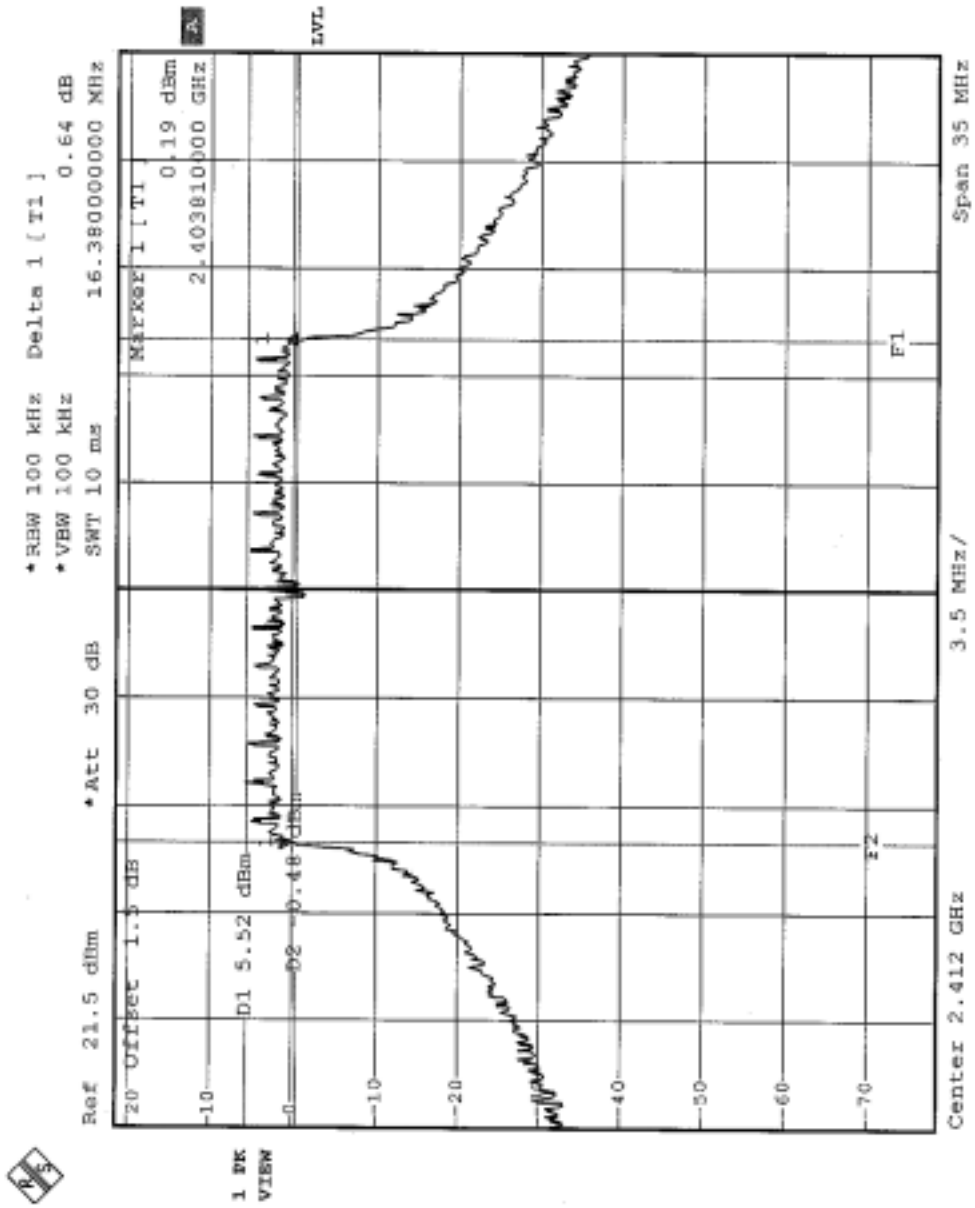



CH6

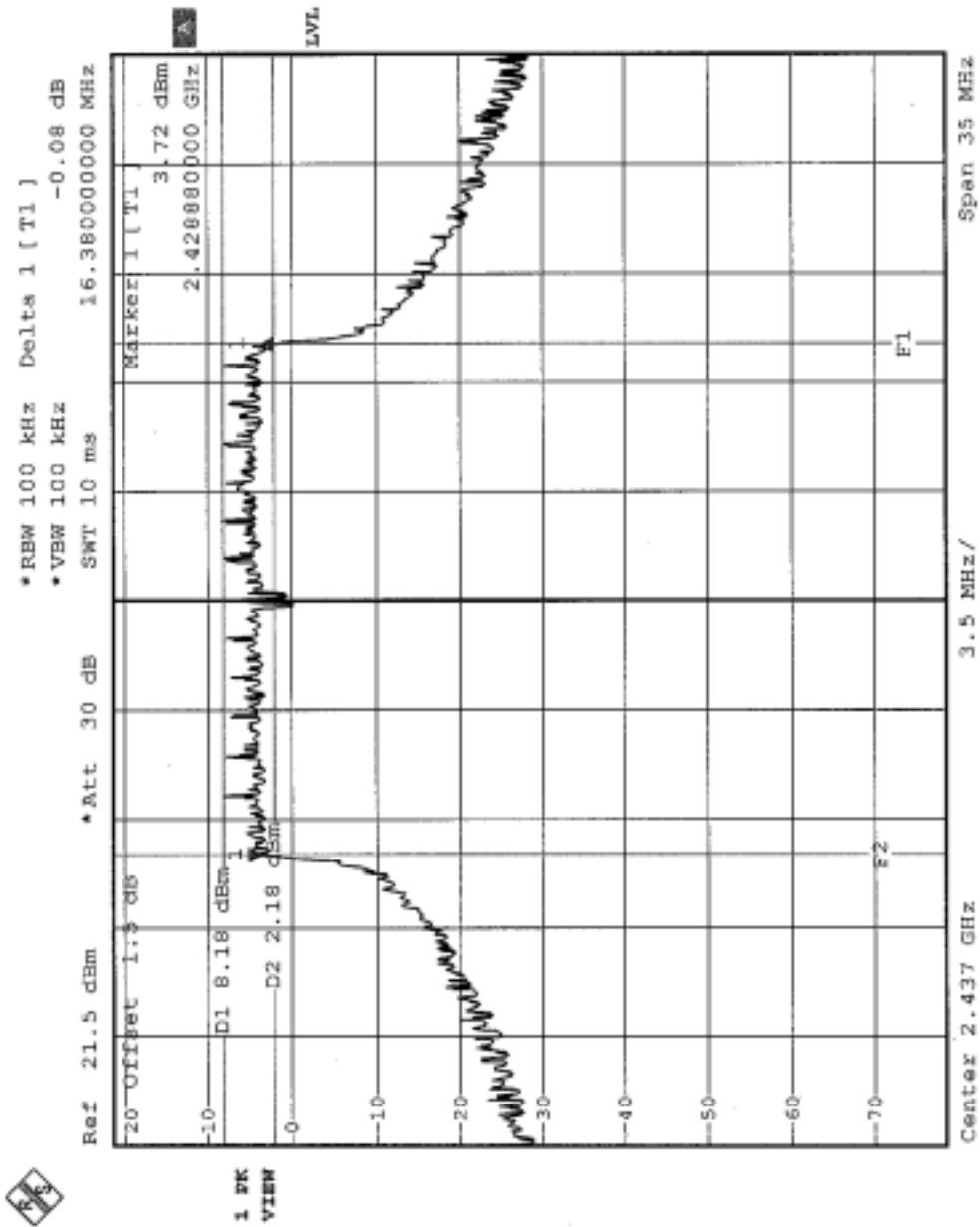



CH11

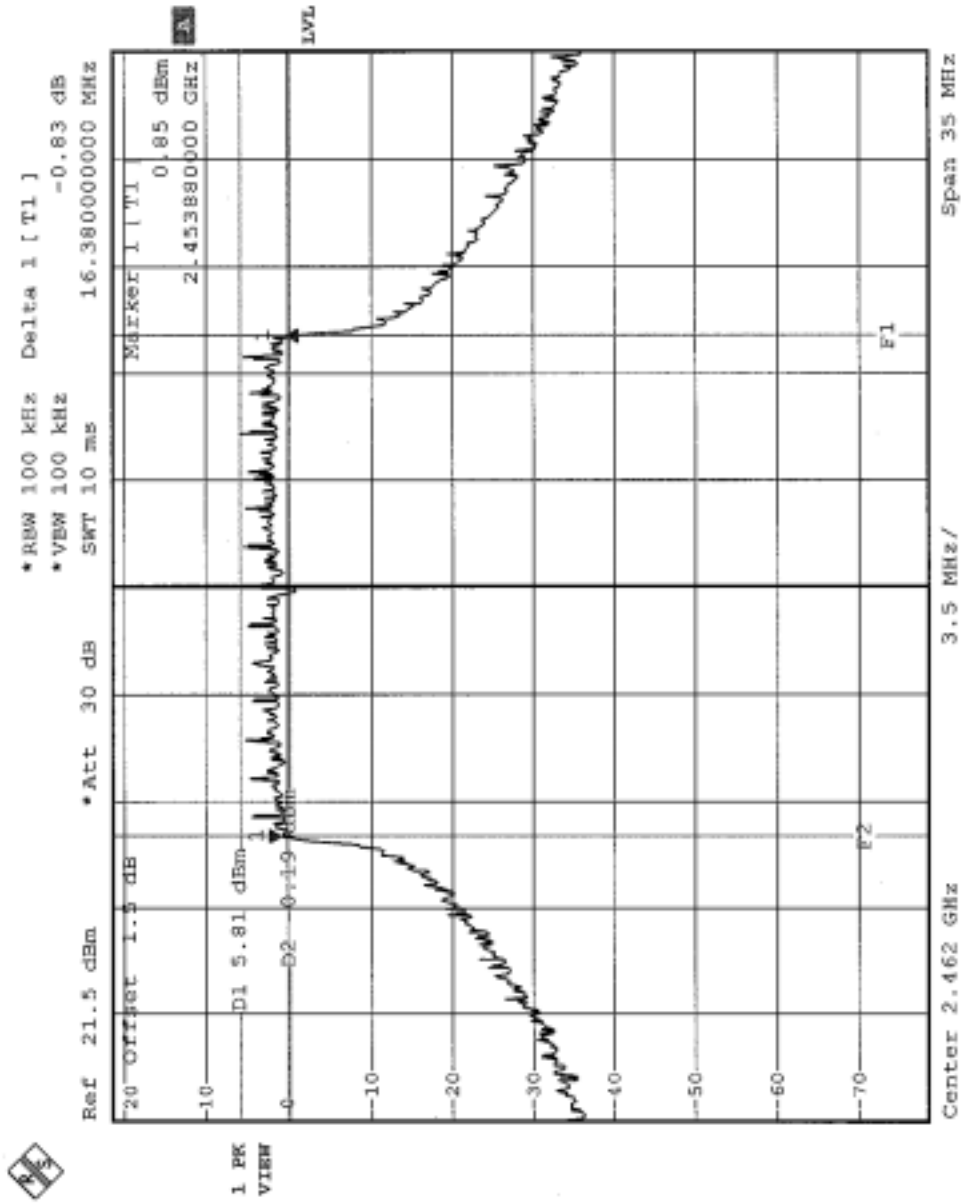



4.4 MAXIMUM PEAK OUTPUT POWER

4.4.1 LIMITS OF MAXIMUM PEAK OUTPUT POWER MEASUREMENT

The Maximum Peak Output Power Measurement is 30dBm.

Note:

1. If transmitting antennas of directional gain greater than 6 dBi are used, the peak output power from the intentional radiator shall be reduced below the stated values as appropriate, by the amount in dB that the directional gain of the antenna exceeds 6 dBi.
2. Systems operating in the 2400-2483.5 MHz band that are used exclusively for fixed, point-to-point operations may employ transmitting antennas with directional gain greater than 6 dBi provided the maximum peak output power of the intentional radiator is reduced by 1 dB for every 3 dB that the directional gain of the antenna exceeds 6 dBi.

4.4.2 INSTRUMENTS

Description & Manufacturer	Model No.	Serial No.	Calibrated Until
R&S SPECTRUM ANALYZER	FSP30	100019	Dec. 19, 2004
R&S SIGNAL GENERATOR	SMP04	100011	May 28, 2004
TEKTRONIX OSCILLOSCOPE	TDS 220	B048470	Mar. 05, 2004
NARDA DETECTOR	4503A	FSCM99899	NA

NOTE:

The calibration interval of the above test instruments is 12 months and the calibrations are traceable to NML/ROC and NIST/USA.

4.4.3 TEST PROCEDURES

1. A detector was used on the output port of the EUT. An oscilloscope was used to read the peak response of the detector.
2. Replaced the EUT by the signal generator. The center frequency of the S.G was adjusted to the center frequency of the measured channel.
3. Adjusted the power to have the same peak reading on oscilloscope.
Record the power level.

4.4.4 TEST SETUP

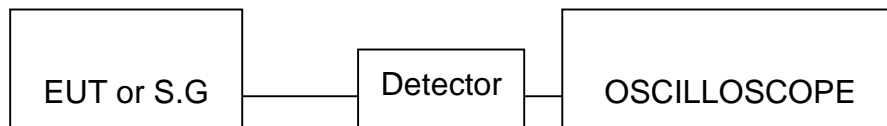

4.4.5 EUT OPERATING CONDITIONS

Same as Item 4.3.6



4.4.6 TEST RESULTS -DSSS

EUT	Flanker Pro Single Radio AP	MODEL	AP-AG-AT-01
INPUT POWER (SYSTEM)	120Vac, 60Hz	ENVIRONMENTAL CONDITIONS	19deg. C, 64%RH, 972 hPa
TESTED BY	Eric Lee		

Antenna 1 (Gain: 2.5dBi)

CHANNEL	CHANNEL FREQUENCY (MHz)	PEAK POWER OUTPUT (dBm)	PEAK POWER LIMIT (dBm)	PASS/FAIL
1	2412	20.30	30	PASS
6	2437	21.34	30	PASS
11	2462	21.50	30	PASS

Antenna 2 (Gain: 2.0dBi)

CHANNEL	CHANNEL FREQUENCY (MHz)	PEAK POWER OUTPUT (dBm)	PEAK POWER LIMIT (dBm)	PASS/FAIL
1	2412	21.52	30	PASS
6	2437	21.94	30	PASS
11	2462	21.42	30	PASS

Antenna 3 (Gain: 3.0dBi)

CHANNEL	CHANNEL FREQUENCY (MHz)	PEAK POWER OUTPUT (dBm)	PEAK POWER LIMIT (dBm)	PASS/FAIL
1	2412	20.30	30	PASS
6	2437	21.34	30	PASS
11	2462	21.50	30	PASS

Antenna 4 (Gain: 10.0dBi)

CHANNEL	CHANNEL FREQUENCY (MHz)	PEAK POWER OUTPUT (dBm)	PEAK POWER LIMIT (dBm)	PASS/FAIL
1	2412	18.23	26	PASS
6	2437	20.90	26	PASS
11	2462	19.00	26	PASS



EUT	Flanker Pro Single Radio AP	MODEL	AP-AG-AT-01
INPUT POWER (SYSTEM)	120Vac, 60Hz	ENVIRONMENTAL CONDITIONS	19deg. C, 64%RH, 972 hPa
TESTED BY	Eric Lee		

Antenna 5 (Gain: 14.0dBi)

CHANNEL	CHANNEL FREQUENCY (MHz)	PEAK POWER OUTPUT (dBm)	PEAK POWER LIMIT (dBm)	PASS/FAIL
1	2412	8.61	22	PASS
6	2437	13.62	22	PASS
11	2462	13.65	22	PASS

Antenna 6 (Gain: 14.0dBi)

CHANNEL	CHANNEL FREQUENCY (MHz)	PEAK POWER OUTPUT (dBm)	PEAK POWER LIMIT (dBm)	PASS/FAIL
1	2412	12.50	22	PASS
6	2437	17.82	22	PASS
11	2462	15.74	22	PASS

Antenna 7 (Gain: 24.0dBi)

CHANNEL	CHANNEL FREQUENCY (MHz)	PEAK POWER OUTPUT (dBm)	PEAK POWER LIMIT (dBm)	PASS/FAIL
3	2422	8.61	24	PASS
6	2437	9.50	24	PASS
9	2452	8.54	24	PASS



4.4.7 TEST RESULTS -OFDM

EUT	Flanker Pro Single Radio AP	MODEL	AP-AG-AT-01
INPUT POWER (SYSTEM)	120Vac, 60Hz	ENVIRONMENTAL CONDITIONS	19deg. C, 64%RH, 972 hPa
TESTED BY	Eric Lee		

Antenna 1 (Gain: 2.5dBi)

CHANNEL	CHANNEL FREQUENCY (MHz)	PEAK POWER OUTPUT (dBm)	PEAK POWER LIMIT (dBm)	PASS/FAIL
1	2412	21.09	30	PASS
6	2437	22.09	30	PASS
11	2462	21.37	30	PASS

Antenna 2 (Gain: 2.0dBi)

CHANNEL	CHANNEL FREQUENCY (MHz)	PEAK POWER OUTPUT (dBm)	PEAK POWER LIMIT (dBm)	PASS/FAIL
1	2412	20.82	30	PASS
6	2437	23.28	30	PASS
11	2462	21.43	30	PASS

Antenna 3 (Gain: 3.0dBi)

CHANNEL	CHANNEL FREQUENCY (MHz)	PEAK POWER OUTPUT (dBm)	PEAK POWER LIMIT (dBm)	PASS/FAIL
1	2412	21.09	30	PASS
6	2437	22.09	30	PASS
11	2462	21.37	30	PASS

Antenna 4 (Gain: 10.0dBi)

CHANNEL	CHANNEL FREQUENCY (MHz)	PEAK POWER OUTPUT (dBm)	PEAK POWER LIMIT (dBm)	PASS/FAIL
1	2412	15.20	26	PASS
6	2437	21.00	26	PASS
11	2462	16.33	26	PASS



EUT	Flanker Pro Single Radio AP	MODEL	AP-AG-AT-01
INPUT POWER (SYSTEM)	120Vac, 60Hz	ENVIRONMENTAL CONDITIONS	19deg. C, 64%RH, 972 hPa
TESTED BY	Eric Lee		

Antenna 5 (Gain: 14.0dBi)

CHANNEL	CHANNEL FREQUENCY (MHz)	PEAK POWER OUTPUT (dBm)	PEAK POWER LIMIT (dBm)	PASS/FAIL
1	2412	10.12	22	PASS
6	2437	18.05	22	PASS
11	2462	11.91	22	PASS

Antenna 6 (Gain: 14.0dBi)

CHANNEL	CHANNEL FREQUENCY (MHz)	PEAK POWER OUTPUT (dBm)	PEAK POWER LIMIT (dBm)	PASS/FAIL
1	2412	12.00	22	PASS
6	2437	18.01	22	PASS
11	2462	14.72	22	PASS

Antenna 7 (Gain: 24.0dBi)

CHANNEL	CHANNEL FREQUENCY (MHz)	PEAK POWER OUTPUT (dBm)	PEAK POWER LIMIT (dBm)	PASS/FAIL
3	2422	11.86	24	PASS
6	2437	11.57	24	PASS
9	2452	12.01	24	PASS



4.5 POWER SPECTRAL DENSITY MEASUREMENT

4.5.1 LIMITS OF POWER SPECTRAL DENSITY MEASUREMENT

The Maximum of Power Spectral Density Measurement is 8dBm.

4.5.2 TEST INSTRUMENTS

Description & Manufacturer	Model No.	Serial No.	Calibrated Until
R&S SPECTRUM ANALYZER	FSP	1093.4495.30	Dec. 19, 2004

NOTE:

- 1.The measurement uncertainty is less than +/- 2.6dB, which is calculated as per the NAMAS document NIS81.
- 2.The calibration interval of the above test instruments is 12 months and the calibrations are traceable to NML/ROC and NIST/USA.

4.5.3 TEST PROCEDURE

The transmitter output was connected to the spectrum analyzer through an attenuator, the bandwidth of the fundamental frequency was measured with the spectrum analyzer using 3 kHz RBW and 30 kHz VBW, set sweep time = span/3 kHz. The power spectral density was measured and recorded.

The sweep time is allowed to be longer than span/3 kHz for a full response of the mixer in the spectrum analyzer.

4.5.4 DEVIATION FROM TEST STANDARD

No deviation

4.5.5 TEST SETUP

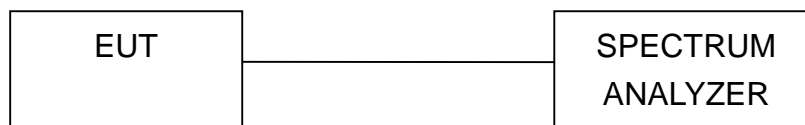

4.5.6 EUT OPERATING CONDITION

Same as Item 4.3.6



4.5.7 TEST RESULTS-DSSS

EUT	Flanker Pro Single Radio AP	MODEL	AP-AG-AT-01
INPUT POWER (SYSTEM)	120Vac, 60Hz	ENVIRONMENTAL CONDITIONS	21deg. C, 58RH, 972 hPa
TESTED BY	Eric Lee		

CHANNEL NUMBER	CHANNEL FREQUENCY (MHz)	RF POWER LEVEL IN 3 kHz BW (dBm)	MAXIMUM LIMIT (dBm)	PASS/FAIL
1	2412	3.43	8	PASS
6	2437	4.65	8	PASS
11	2462	4.48	8	PASS



CH1

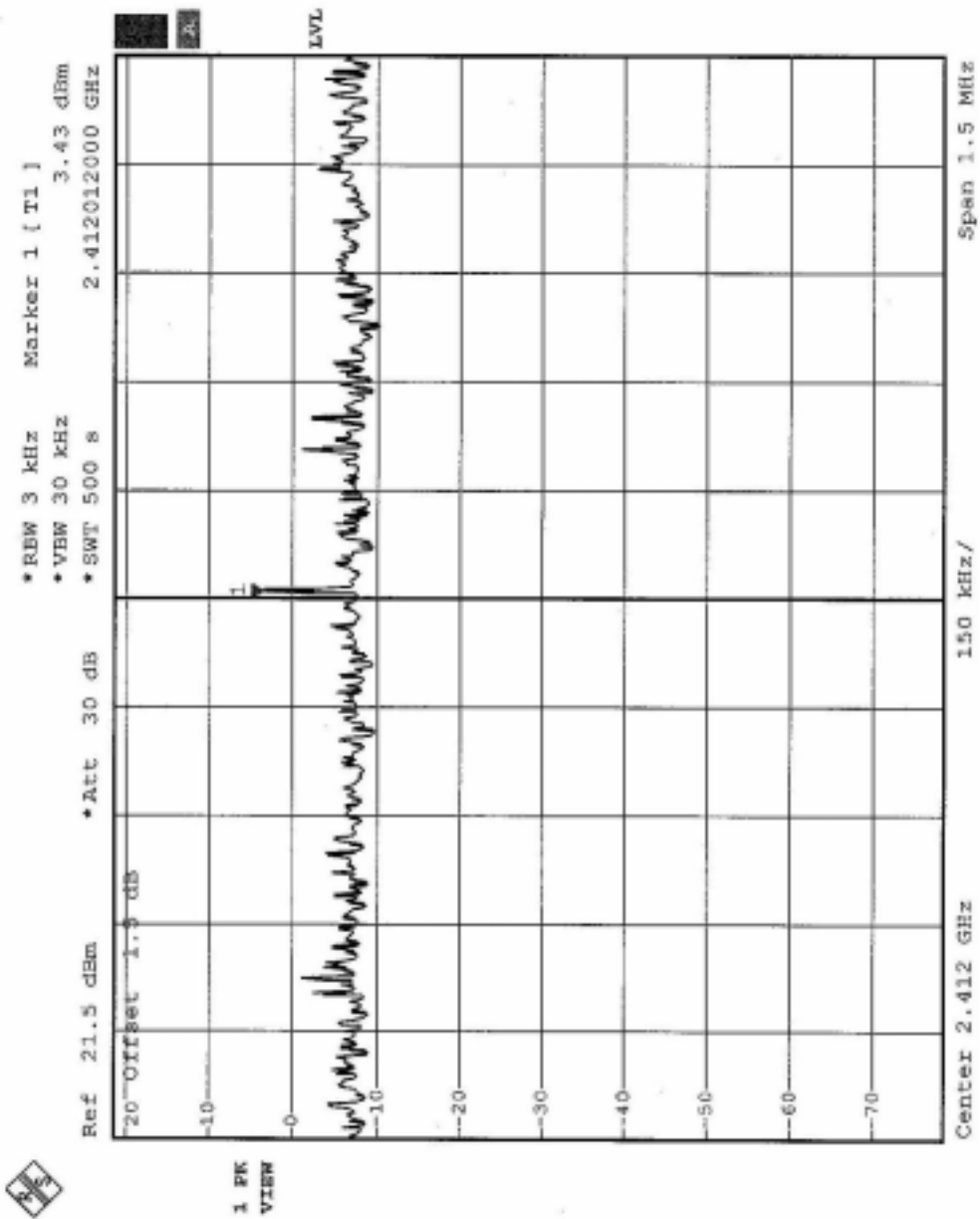



CH6

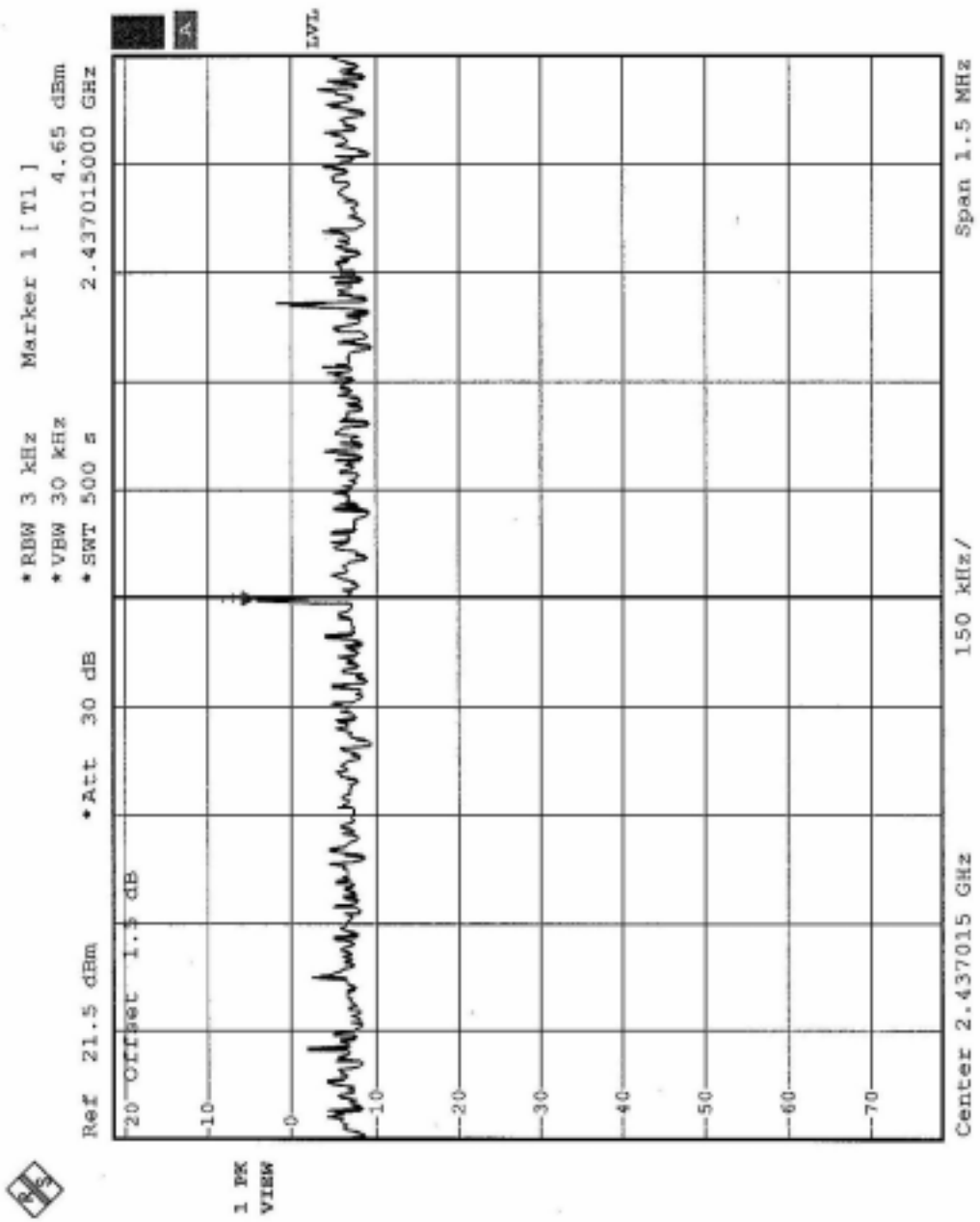



CH11

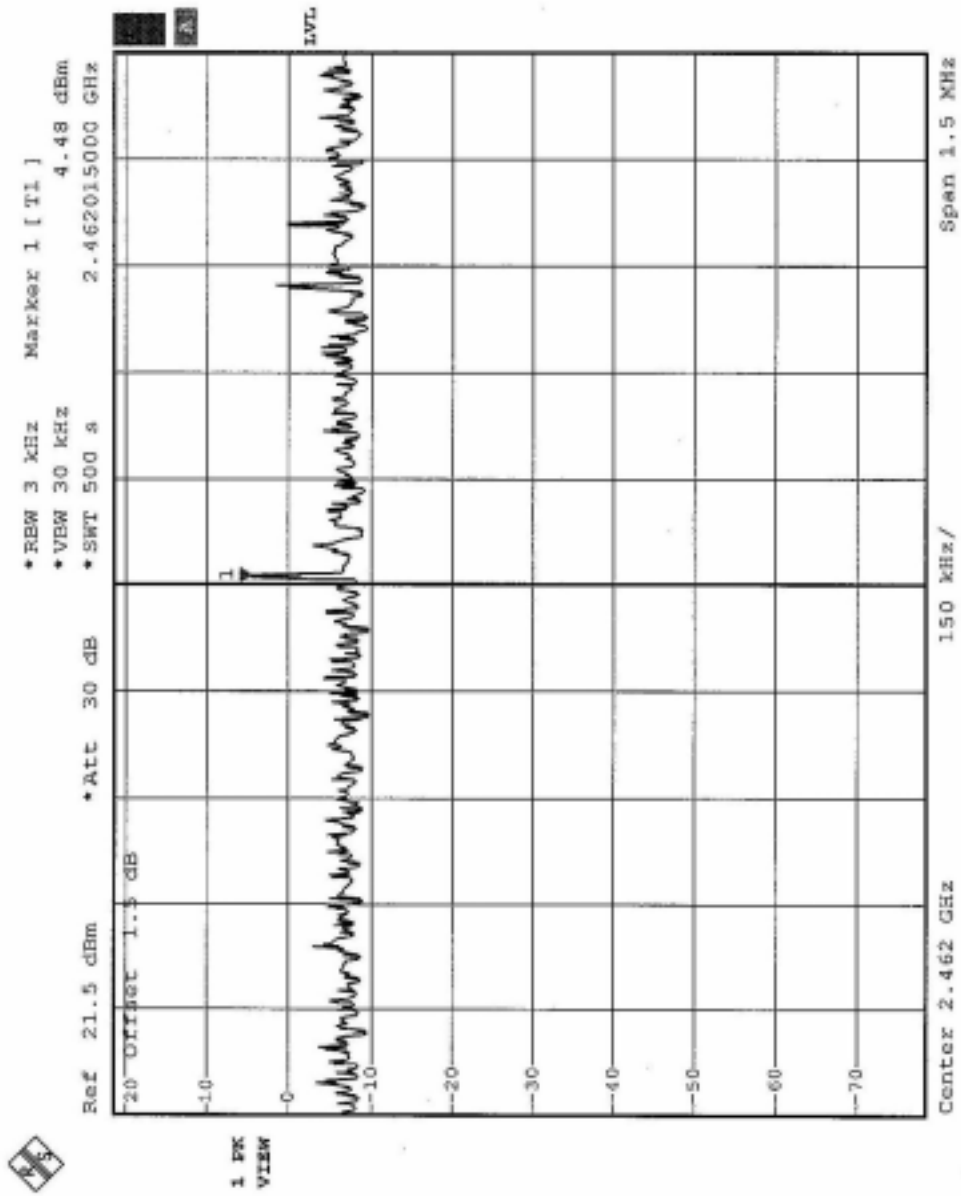



4.5.8 TEST RESULTS-OFDM

EUT	Flanker Pro Single Radio AP	MODEL	AP-AG-AT-01
INPUT POWER (SYSTEM)	120Vac, 60Hz	ENVIRONMENTAL CONDITIONS	21deg. C, 58RH, 972 hPa
TESTED BY	Eric Lee		

CHANNEL NUMBER	CHANNEL FREQUENCY (MHz)	RF POWER LEVEL IN 3 kHz BW (dBm)	MAXIMUM LIMIT (dBm)	PASS/FAIL
1	2412	0.75	8	PASS
6	2437	4.12	8	PASS
11	2462	1.98	8	PASS



CH1

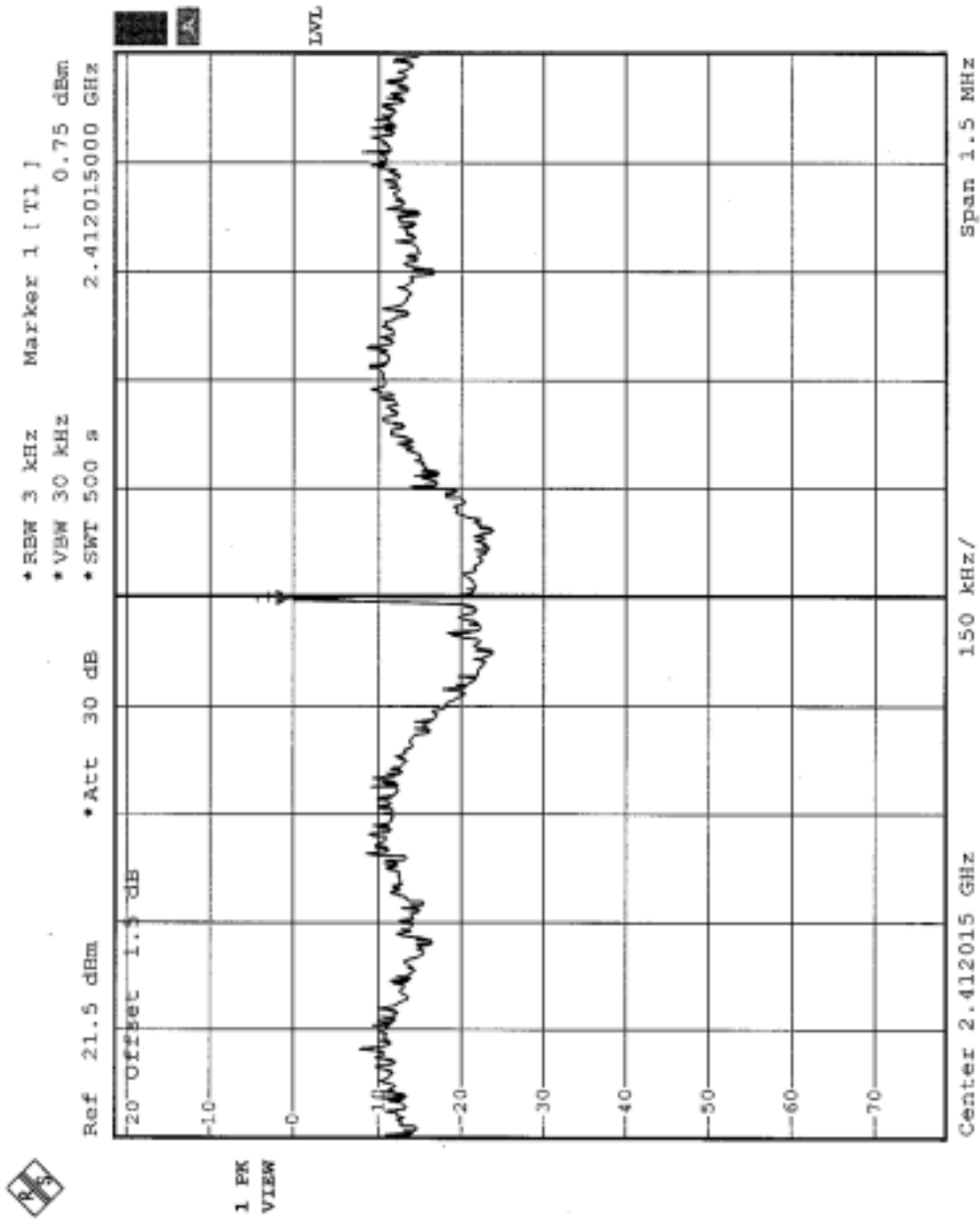



CH6

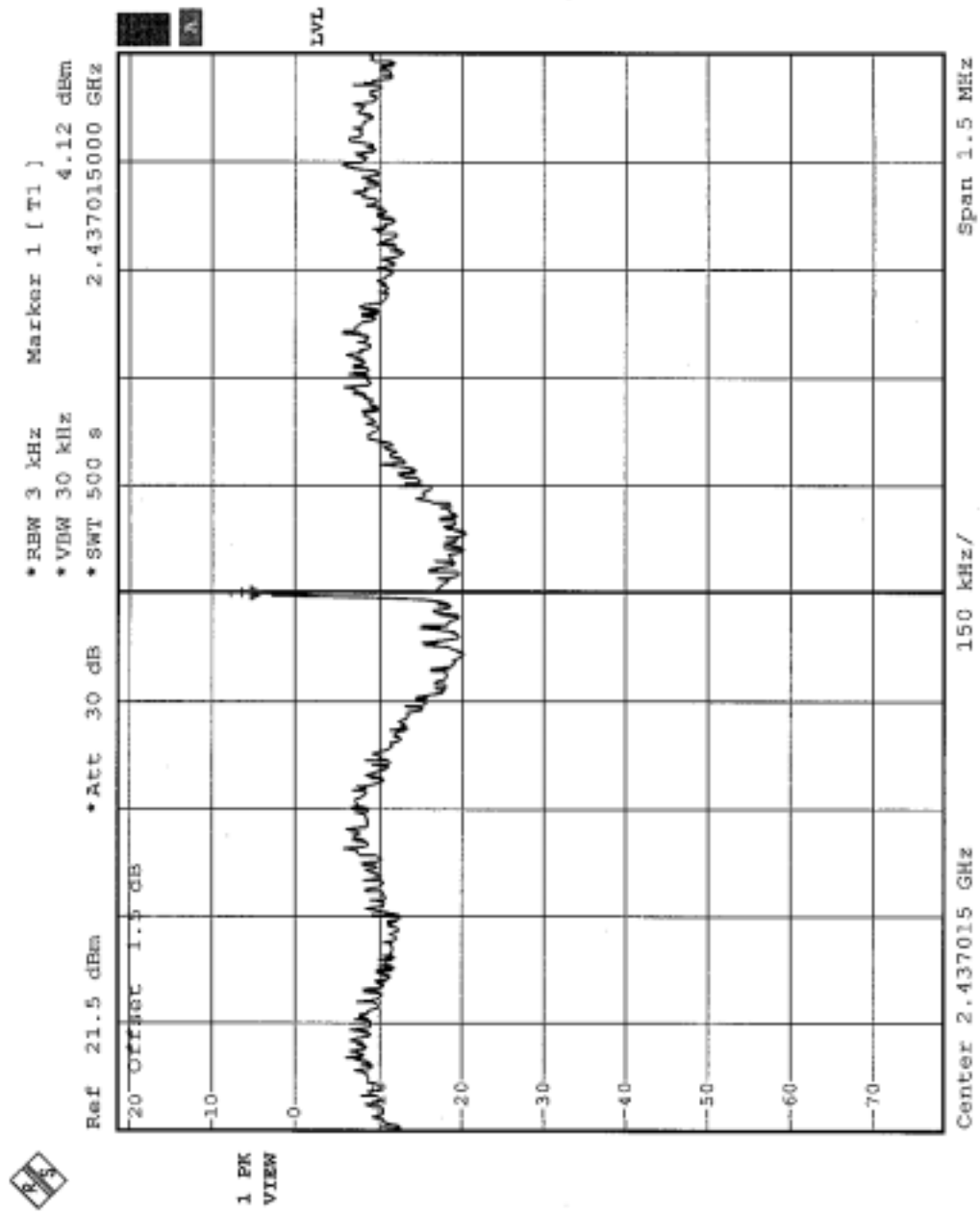



CH11

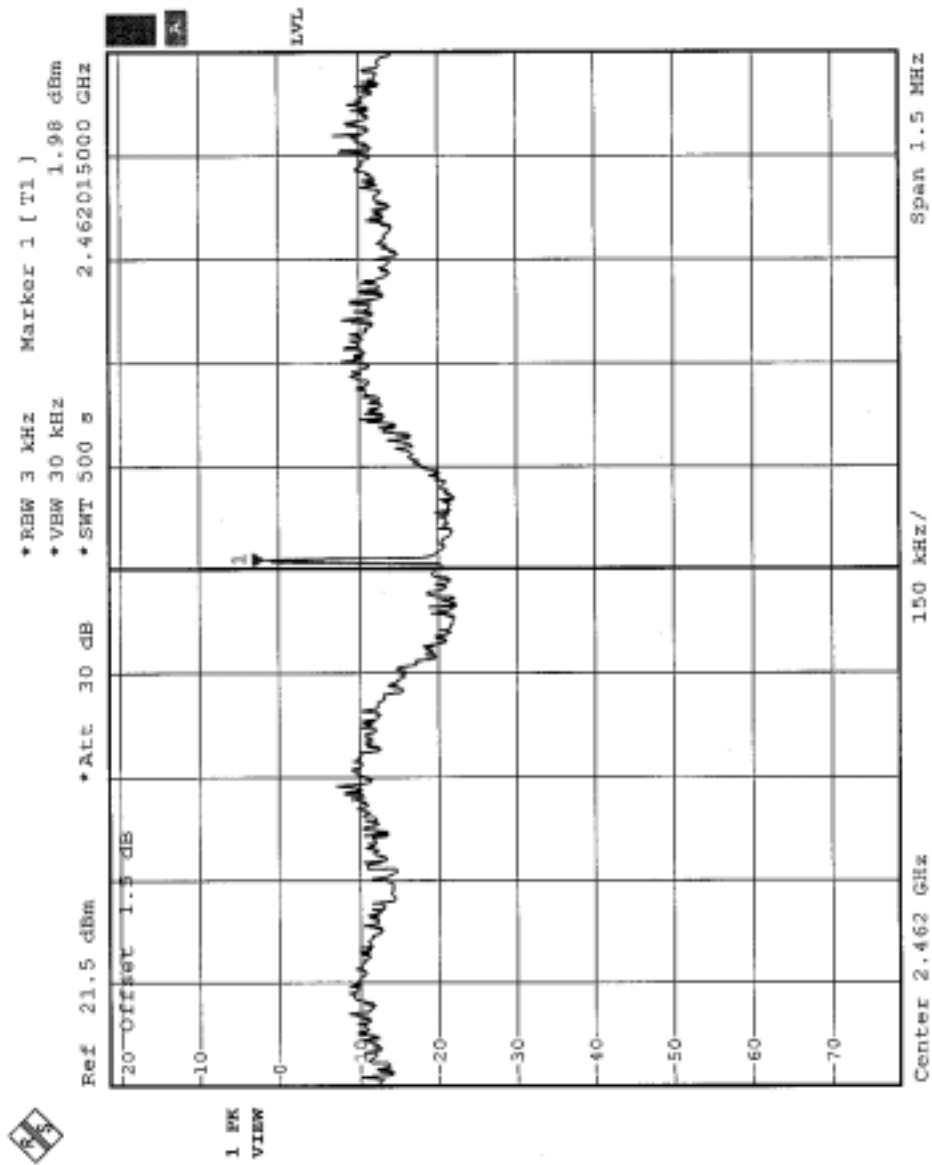



4.6 BAND EDGES MEASUREMENT

4.6.1 LIMITS OF BAND EDGES MEASUREMENT

Below -20dB of the highest emission level of operating band (in 100KHz Resolution Bandwidth).

4.6.2 TEST INSTRUMENTS

Description & Manufacturer	Model No.	Serial No.	Calibrated Until
R&S SPECTRUM ANALYZER	FSP	1093.4495.30	Dec. 19, 2004

NOTE:

- 1.The measurement uncertainty is less than +/- 2.6dB, which is calculated as per the NAMAS document NIS81.
- 2.The calibration interval of the above test instruments is 12 months and the calibrations are traceable to NML/ROC and NIST/USA.

4.6.3 TEST PROCEDURE

The transmitter output was connected to the spectrum analyzer via a low loss cable. Set both RBW and VBW of spectrum analyzer to 100 kHz with suitable frequency span including 100 kHz bandwidth from band edge. The band edges was measured and recorded.

4.6.4 DEVIATION FROM TEST STANDARD

No deviation



4.6.5 EUT OPERATING CONDITION

Same as Item 4.3.6

4.6.6 TEST RESULTS –DSSS (Antenna 1)

The spectrum plots are attached on the following 2 pages. D1 line indicates the highest level, and D2 line indicates the 20dB offset below D2. It shows compliance with the requirement in part 15.247(C).

NOTE (1): The band edge emission plot on the following first page shows 51.48dB delta between carrier maximum power and local maximum emission in restrict band (2.3900GHz). The emission of carrier strength list in the test result of channel 1 at the item 4.2 is 103.80dBuV/m, so the maximum field strength in restrict band is $103.80 - 51.48 = 52.32$ dBuV/m which is under 54 dBuV/m limit.

NOTE (2): The band edge emission plot on the following second page shows 54.56 dB delta between carrier maximum power and local maximum emission in restrict band (2.4835GHz). The emission of carrier strength list in the test result of channel 11 at the item 4.2 is 105.20dBuV/m, so the maximum field strength in restrict band is $105.20 - 54.56 = 50.64$ dBuV/m which is under 54 dBuV/m limit.

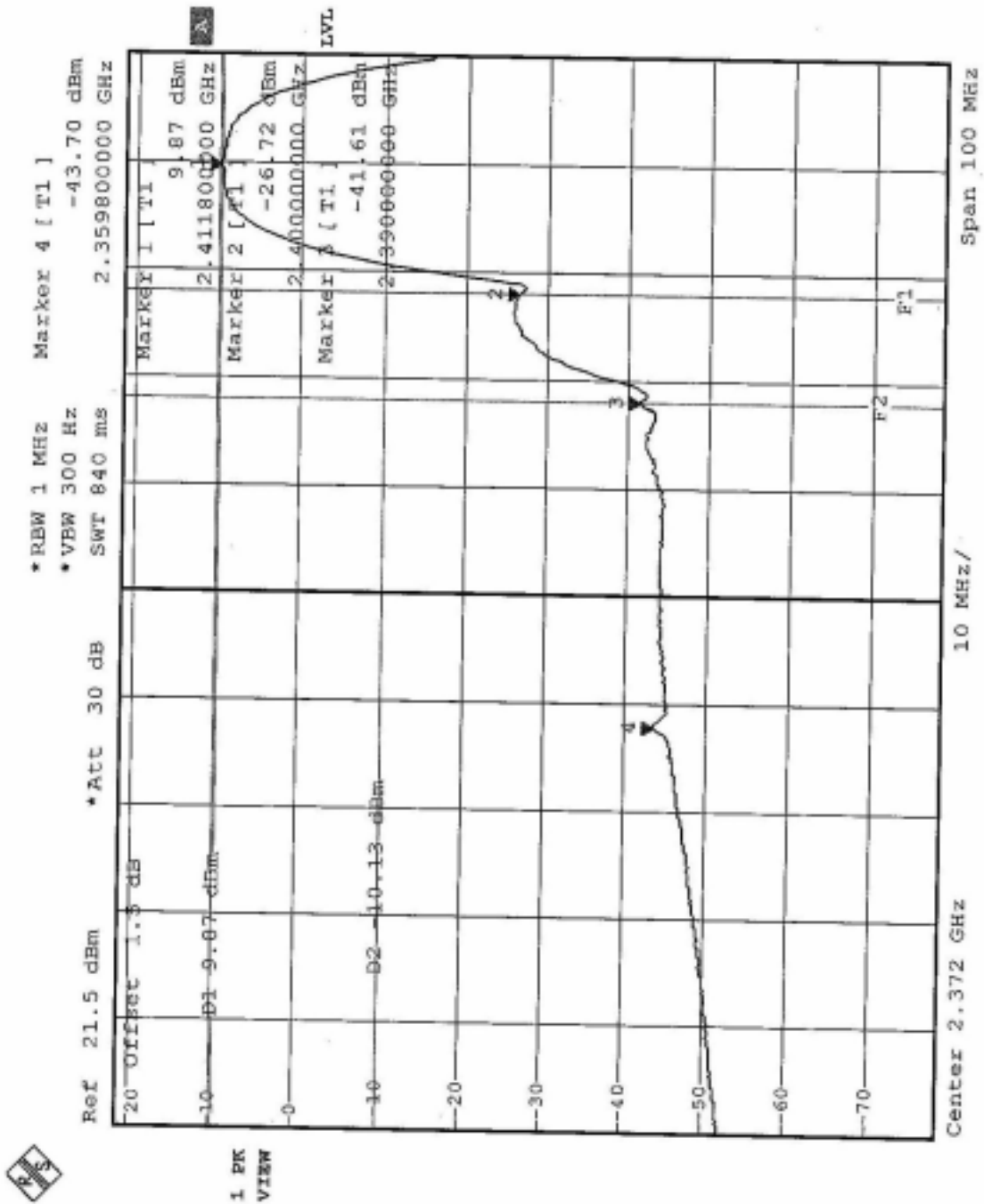

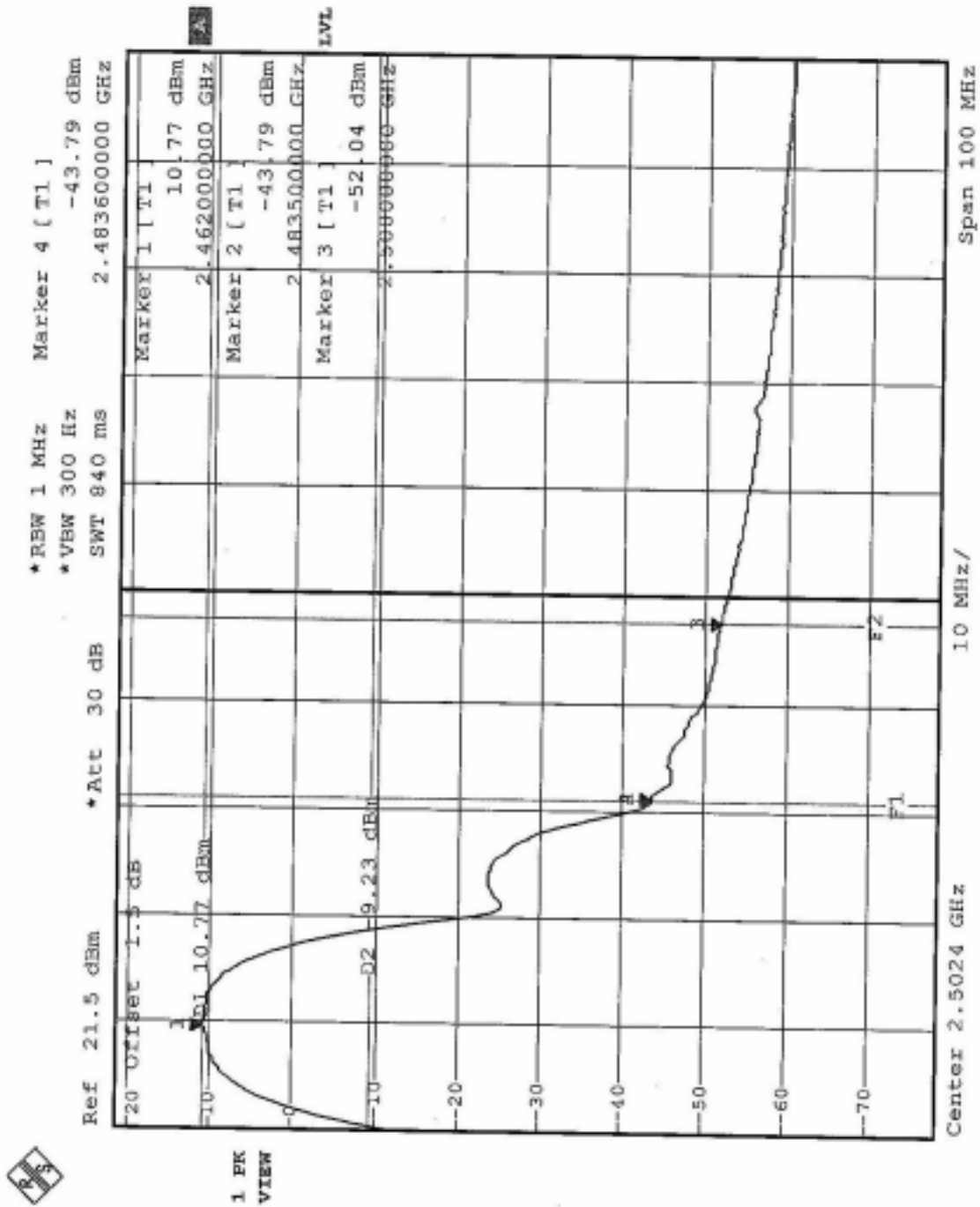



4.6.7 TEST RESULTS –DSSS (Antenna 2)

The spectrum plots are attached on the following 2 pages. D1 line indicates the highest level, and D2 line indicates the 20dB offset below D2. It shows compliance with the requirement in part 15.247(C).

NOTE (1): The band edge emission plot on the following first page shows 52.38dB delta between carrier maximum power and local maximum emission in restrict band (2.3900GHz). The emission of carrier strength list in the test result of channel 1 at the item 4.2 is 103.60dBuV/m, so the maximum field strength in restrict band is $103.60-52.38=51.22$ dBuV/m which is under 54 dBuV/m limit.

NOTE (2): The band edge emission plot on the following second page shows 57.08 dB delta between carrier maximum power and local maximum emission in restrict band (2.4835GHz). The emission of carrier strength list in the test result of channel 11 at the item 4.2 is 105.70dBuV/m, so the maximum field strength in restrict band is $105.70-57.08=48.62$ dBuV/m which is under 54 dBuV/m limit.

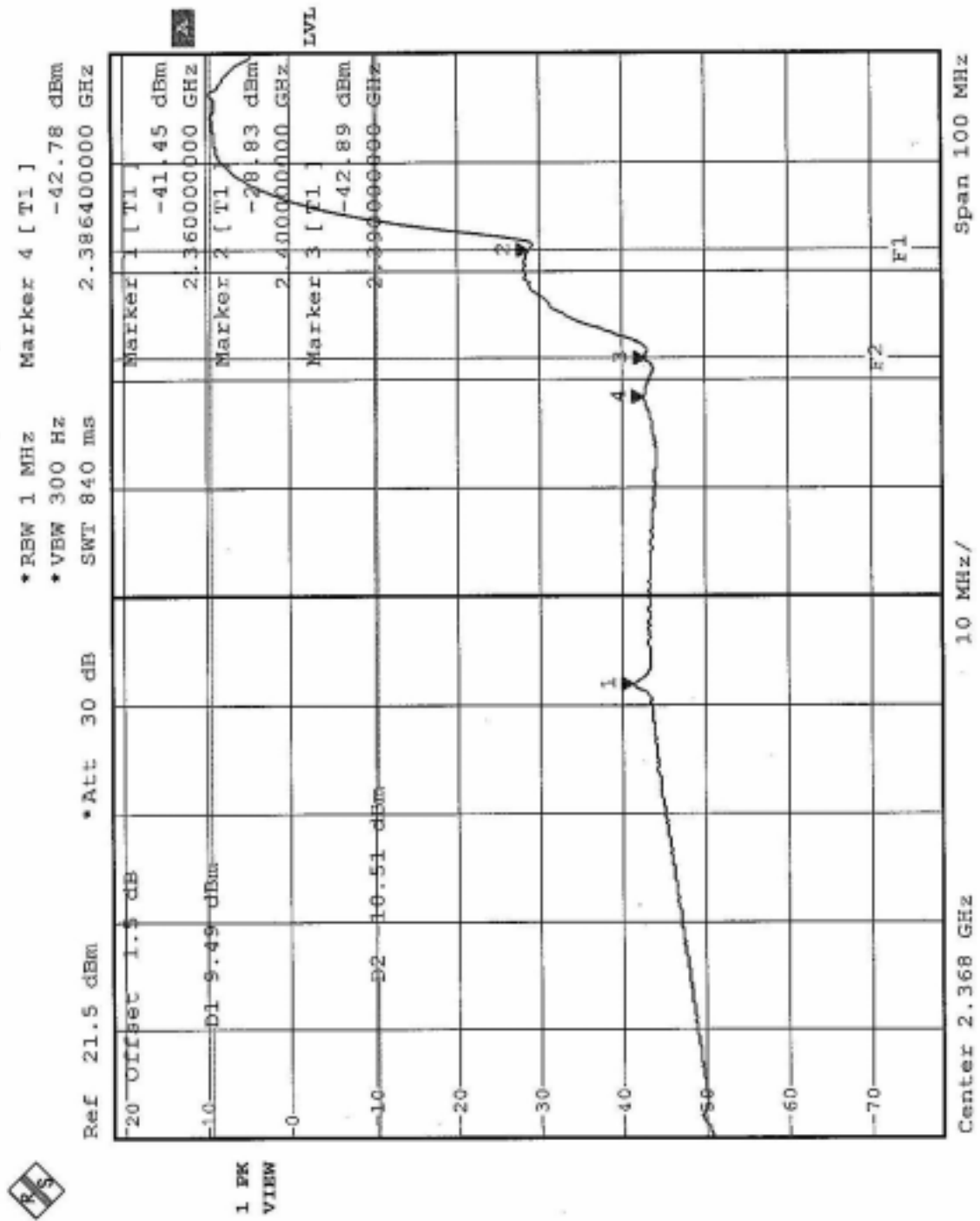

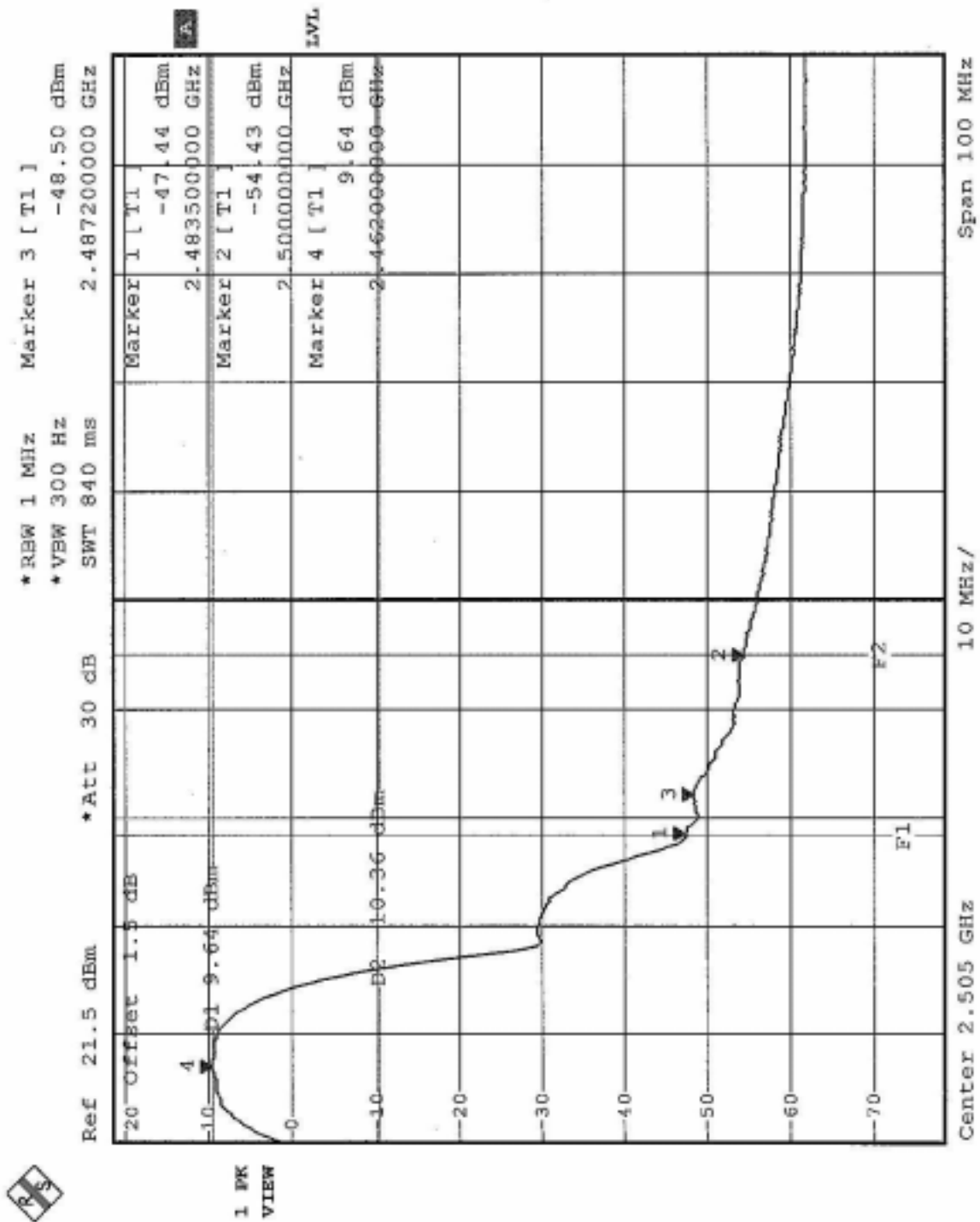



4.6.8 TEST RESULTS –DSSS (Antenna 3)

The spectrum plots are attached on the following 2 pages. D1 line indicates the highest level, and D2 line indicates the 20dB offset below D2. It shows compliance with the requirement in part 15.247(C).

NOTE (1): The band edge emission plot on the following first page shows 54.53dB delta between carrier maximum power and local maximum emission in restrict band (2.3900GHz). The emission of carrier strength list in the test result of channel 1 at the item 4.2 is 100.30dBuV/m, so the maximum field strength in restrict band is $100.30-54.53=45.77$ dBuV/m which is under 54 dBuV/m limit.

NOTE (2): The band edge emission plot on the following second page shows 57.83 dB delta between carrier maximum power and local maximum emission in restrict band (2.4835GHz). The emission of carrier strength list in the test result of channel 11 at the item 4.2 is 102.10dBuV/m, so the maximum field strength in restrict band is $102.10-57.83=44.27$ dBuV/m which is under 54 dBuV/m limit.

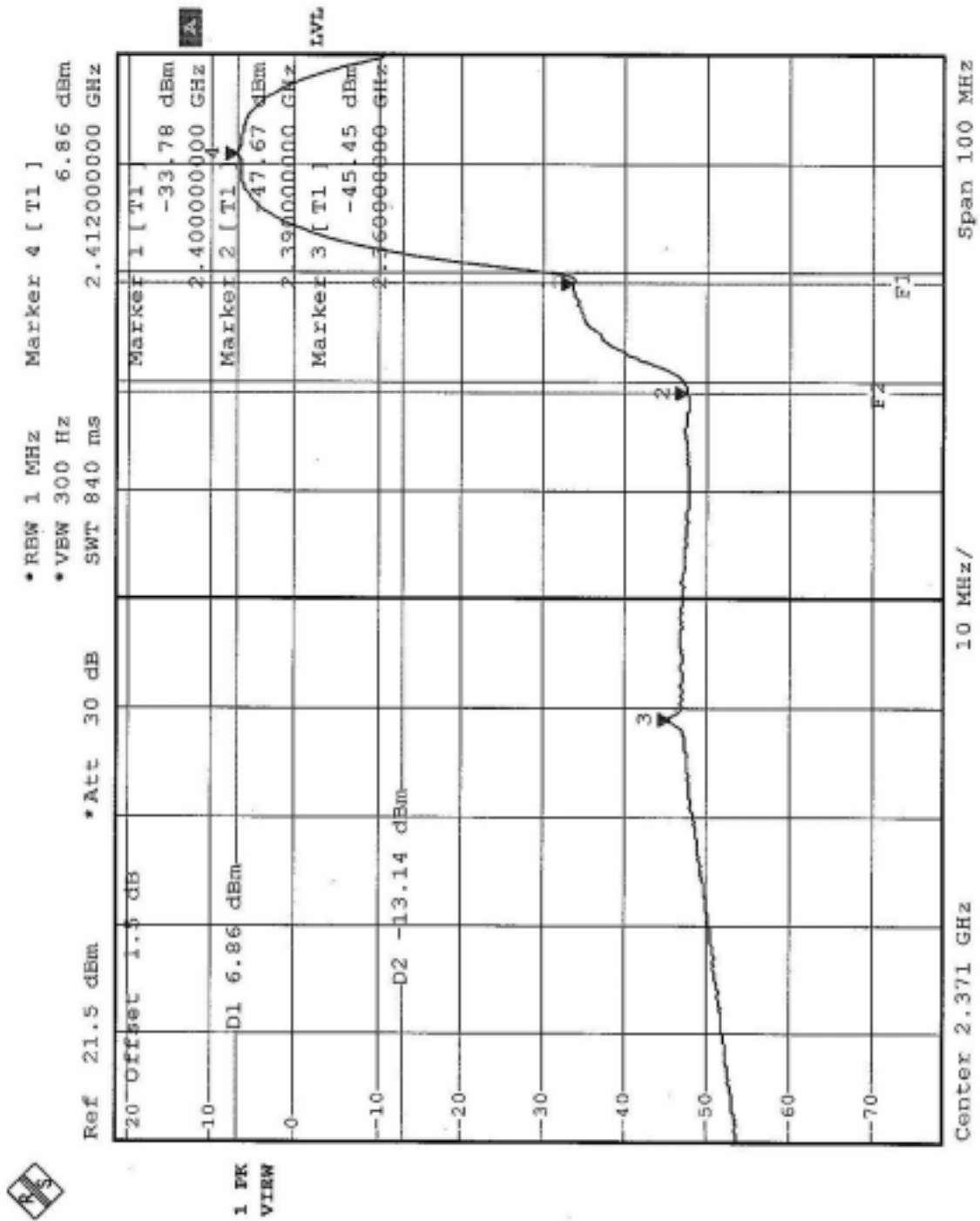

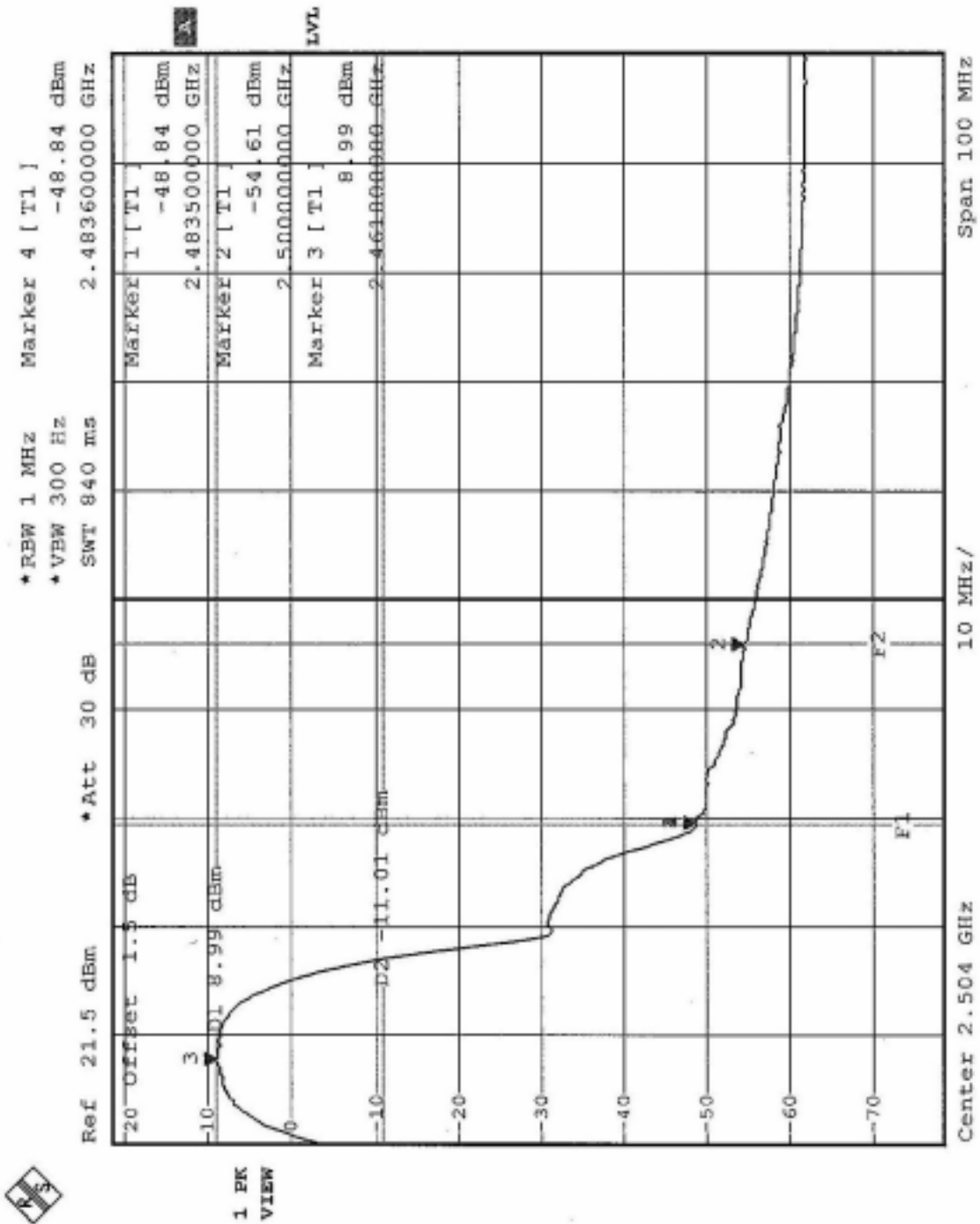



4.6.9 TEST RESULTS –DSSS (Antenna 4)

The spectrum plots are attached on the following 2 pages. D1 line indicates the highest level, and D2 line indicates the 20dB offset below D2. It shows compliance with the requirement in part 15.247(C).

NOTE (1): The band edge emission plot on the following first page shows 56.00dB delta between carrier maximum power and local maximum emission in restrict band (2.3864GHz). The emission of carrier strength list in the test result of channel 1 at the item 4.2 is 107.80dBuV/m, so the maximum field strength in restrict band is $107.80-56.00=51.80$ dBuV/m which is under 54 dBuV/m limit.

NOTE (2): The band edge emission plot on the following second page shows 58.82 dB delta between carrier maximum power and local maximum emission in restrict band (2.4835GHz). The emission of carrier strength list in the test result of channel 11 at the item 4.2 is 109.00dBuV/m, so the maximum field strength in restrict band is $109.00-58.82=50.20$ dBuV/m which is under 54 dBuV/m limit.

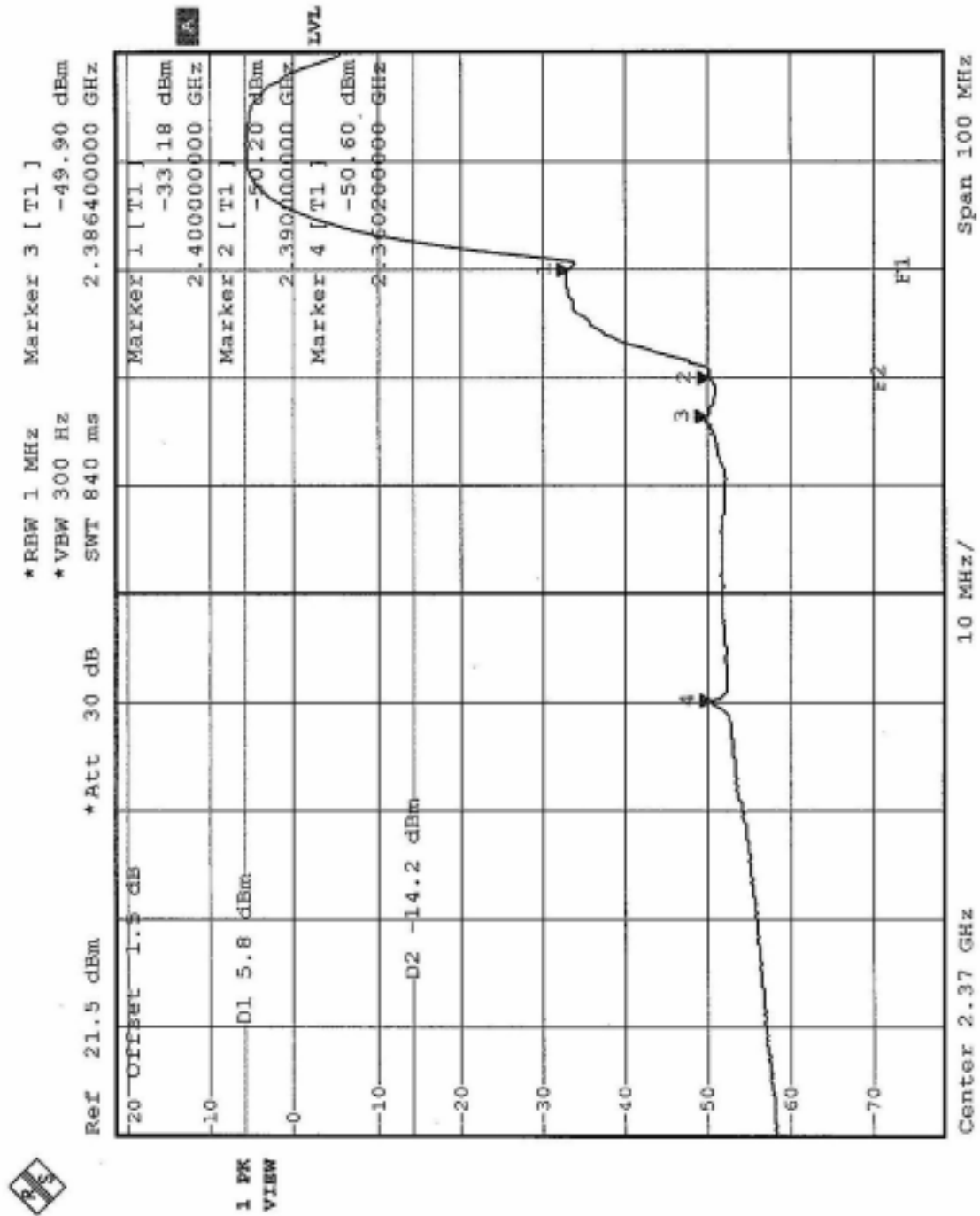

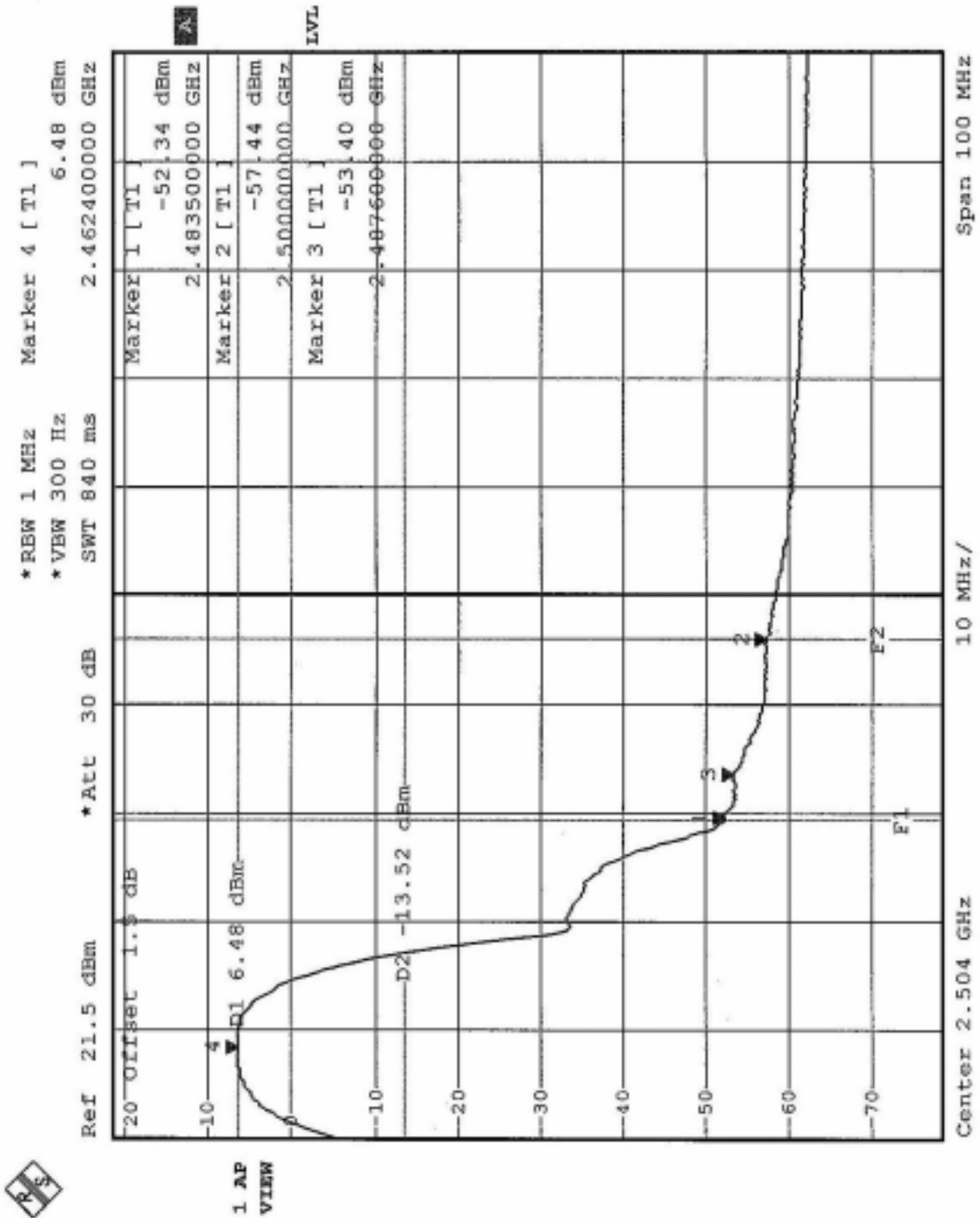



4.6.10 TEST RESULTS –DSSS (Antenna 5)

The spectrum plots are attached on the following 2 pages. D1 line indicates the highest level, and D2 line indicates the 20dB offset below D2. It shows compliance with the requirement in part 15.247(C).

NOTE (1): The band edge emission plot on the following first page shows 52.80dB delta between carrier maximum power and local maximum emission in restrict band (2.3900GHz). The emission of carrier strength list in the test result of channel 1 at the item 4.2 is 104.30dBuV/m, so the maximum field strength in restrict band is $104.30-52.80=51.50$ dBuV/m which is under 54 dBuV/m limit.

NOTE (2): The band edge emission plot on the following second page shows 56.54 dB delta between carrier maximum power and local maximum emission in restrict band (2.4835GHz). The emission of carrier strength list in the test result of channel 11 at the item 4.2 is 109.60dBuV/m, so the maximum field strength in restrict band is $109.60-56.54=53.06$ dBuV/m which is under 54 dBuV/m limit.

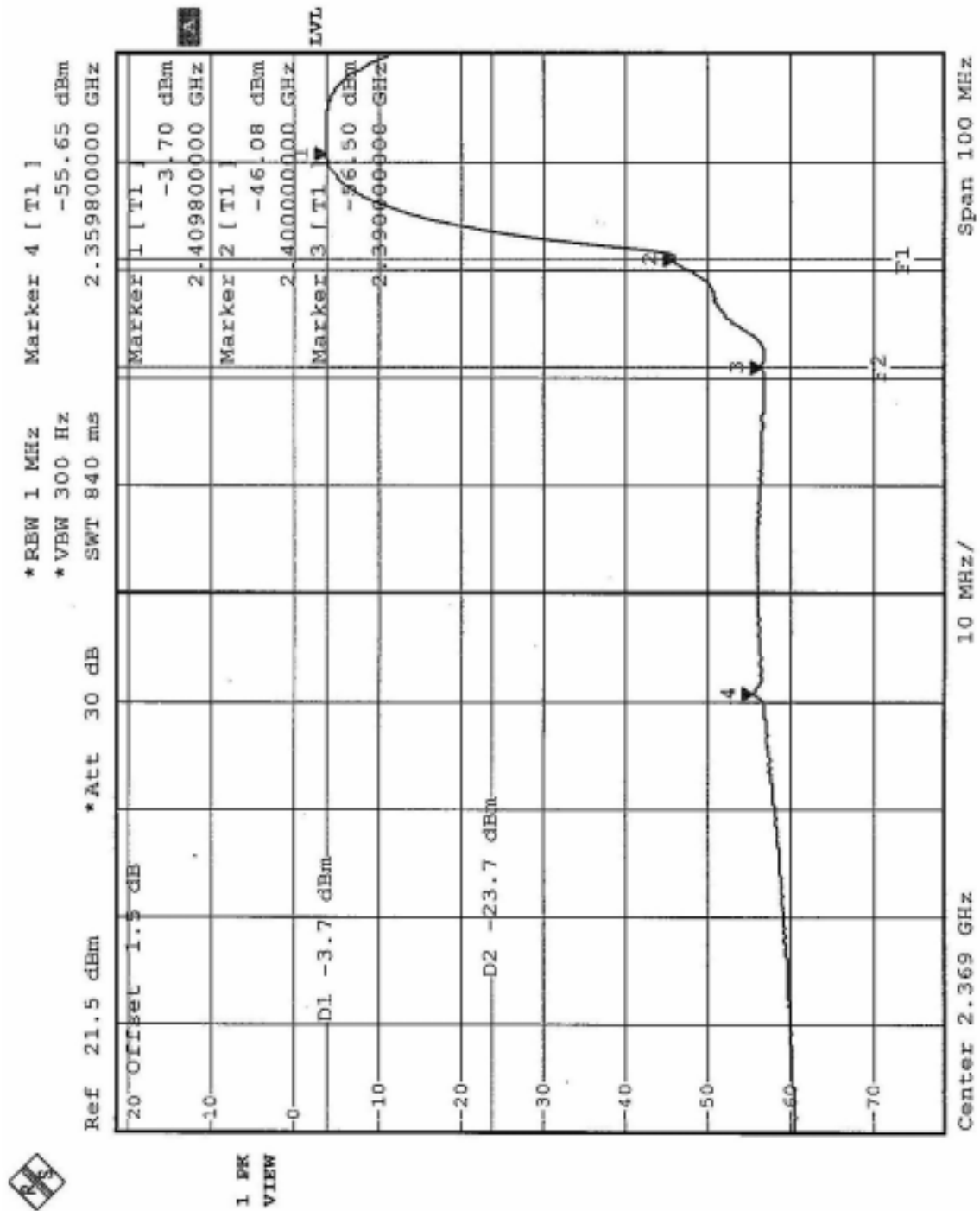

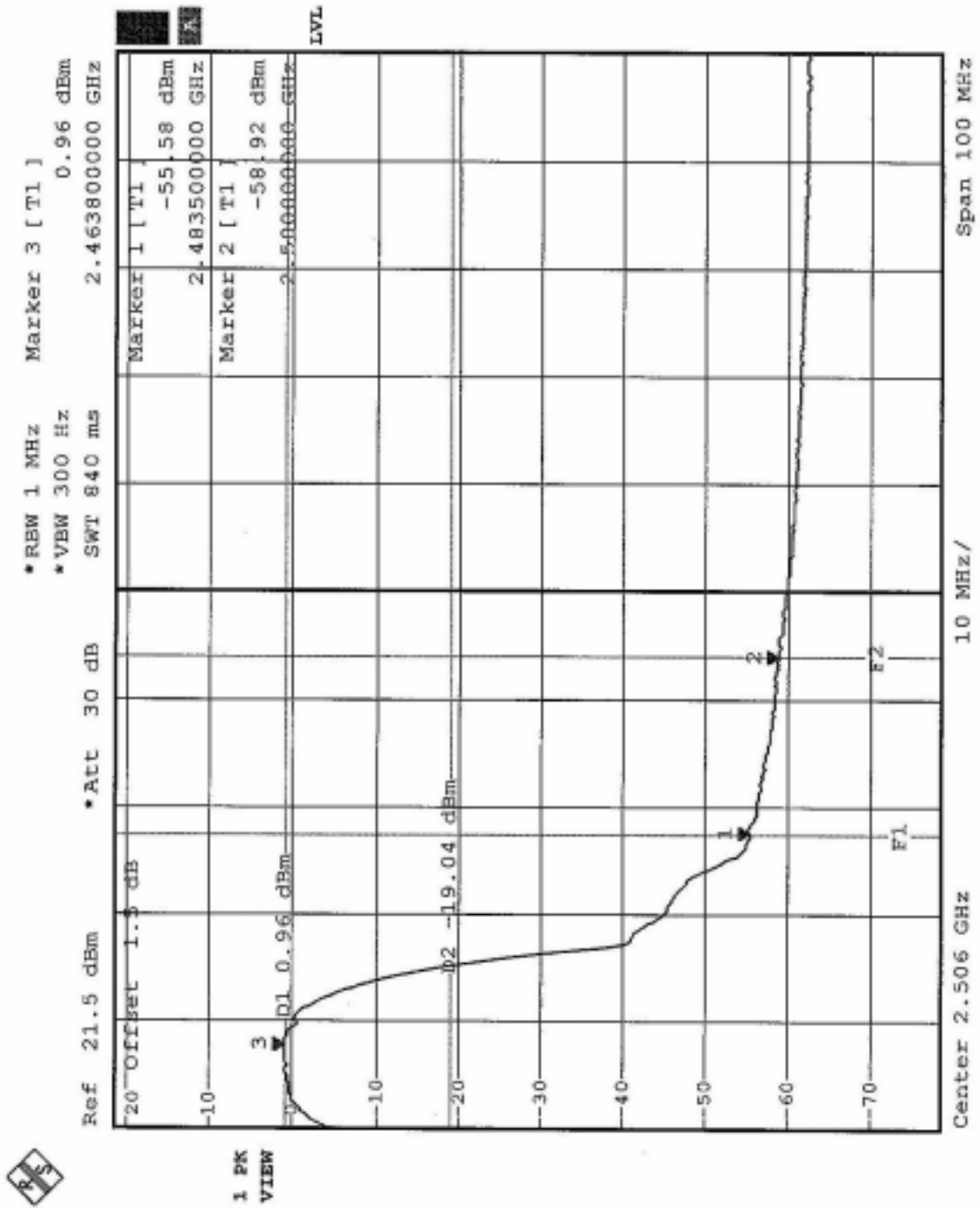



4.6.11 TEST RESULTS –DSSS (Antenna 6)

The spectrum plots are attached on the following 2 pages. D1 line indicates the highest level, and D2 line indicates the 20dB offset below D2. It shows compliance with the requirement in part 15.247(C).

NOTE (1): The band edge emission plot on the following first page shows 53.04dB delta between carrier maximum power and local maximum emission in restrict band (2.3900GHz). The emission of carrier strength list in the test result of channel 1 at the item 4.2 is 105.50dBuV/m, so the maximum field strength in restrict band is $105.50-53.04=52.46$ dBuV/m which is under 54 dBuV/m limit.

NOTE (2): The band edge emission plot on the following second page shows 57.87 dB delta between carrier maximum power and local maximum emission in restrict band (2.4835GHz). The emission of carrier strength list in the test result of channel 11 at the item 4.2 is 108.10dBuV/m, so the maximum field strength in restrict band is $108.10-57.87=50.23$ dBuV/m which is under 54 dBuV/m limit.

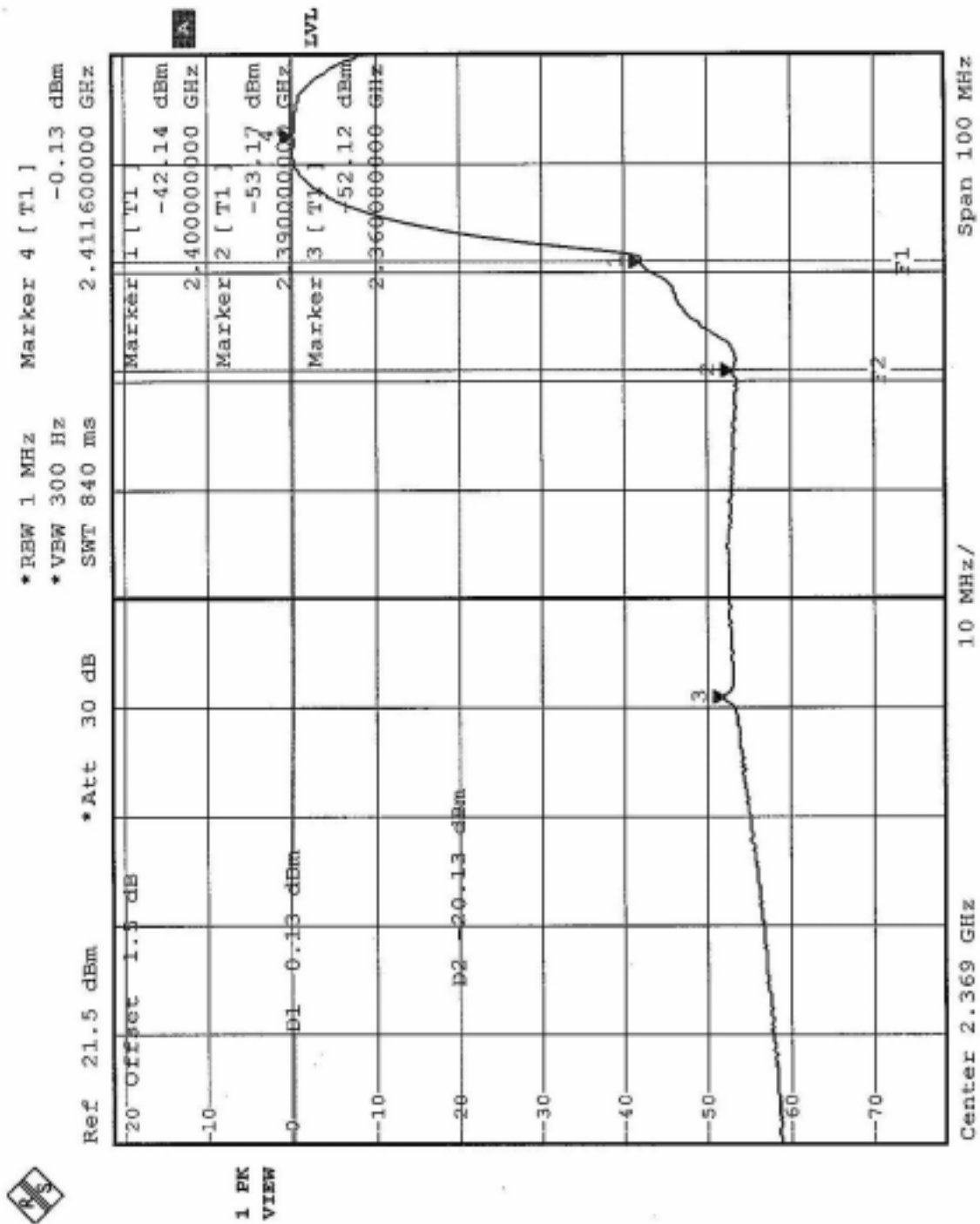

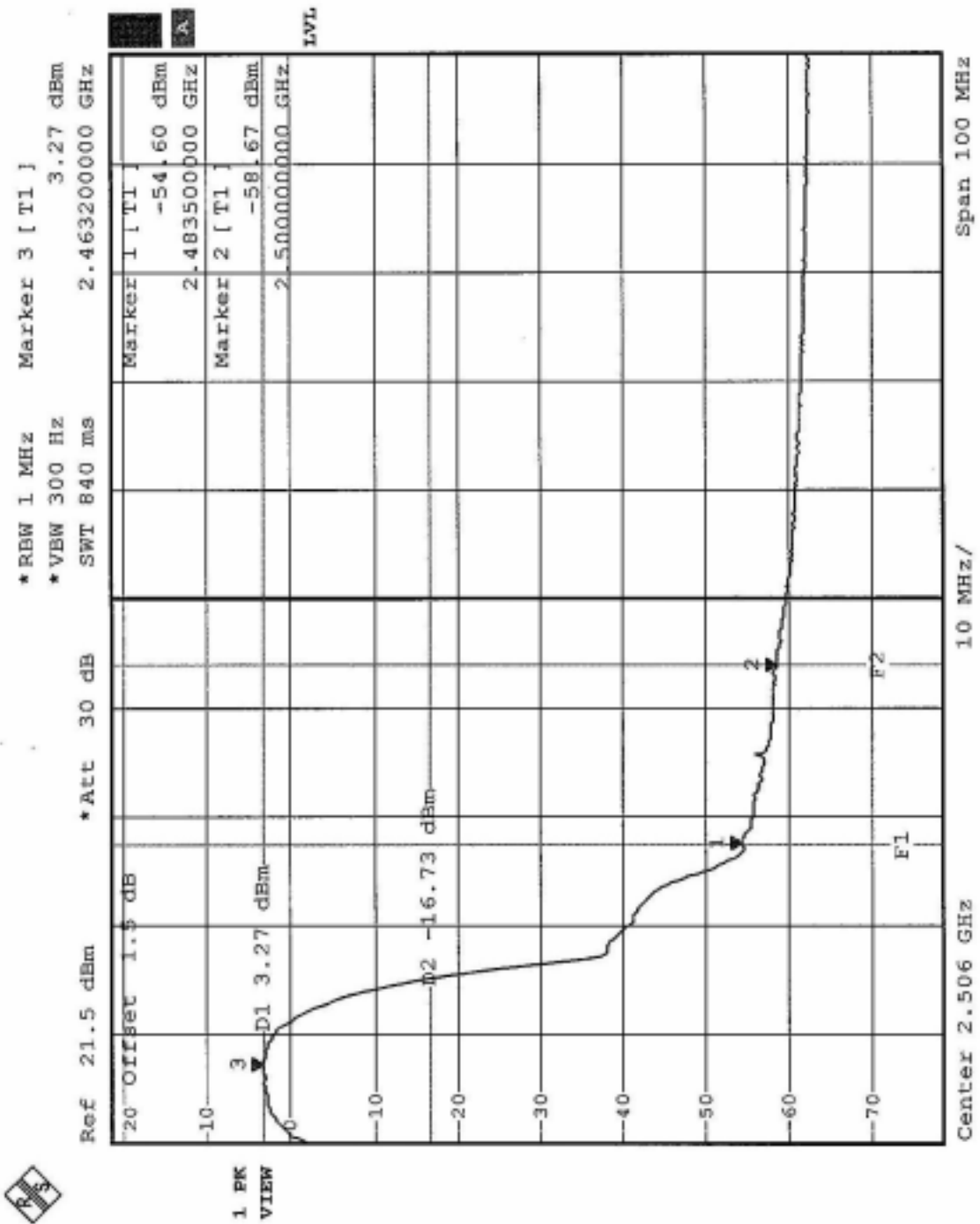



4.6.12 TEST RESULTS –DSSS (Antenna 7)

The spectrum plots are attached on the following 2 pages. D1 line indicates the highest level, and D2 line indicates the 20dB offset below D2. It shows compliance with the requirement in part 15.247(C).

NOTE (1): The band edge emission plot on the following first page shows 54.27dB delta between carrier maximum power and local maximum emission in restrict band (2.3900GHz). The emission of carrier strength list in the test result of channel 1 at the item 4.2 is 107.60dBuV/m, so the maximum field strength in restrict band is $107.60 - 54.27 = 53.33$ dBuV/m which is under 54 dBuV/m limit.

NOTE (2): The band edge emission plot on the following second page shows 55.03 dB delta between carrier maximum power and local maximum emission in restrict band (2.4835GHz). The emission of carrier strength list in the test result of channel 11 at the item 4.2 is 108.20dBuV/m, so the maximum field strength in restrict band is $108.20 - 55.03 = 53.17$ dBuV/m which is under 54 dBuV/m limit.

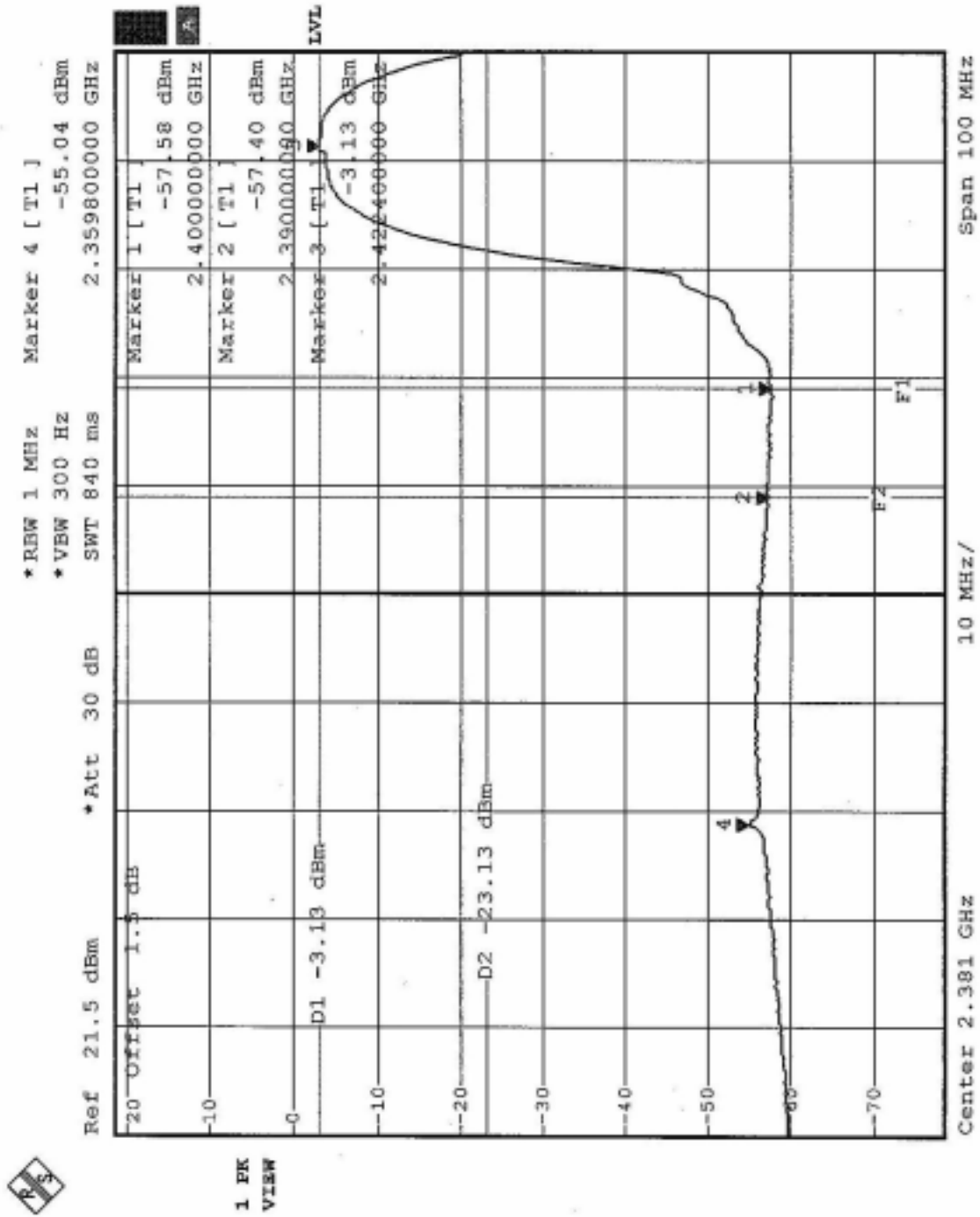

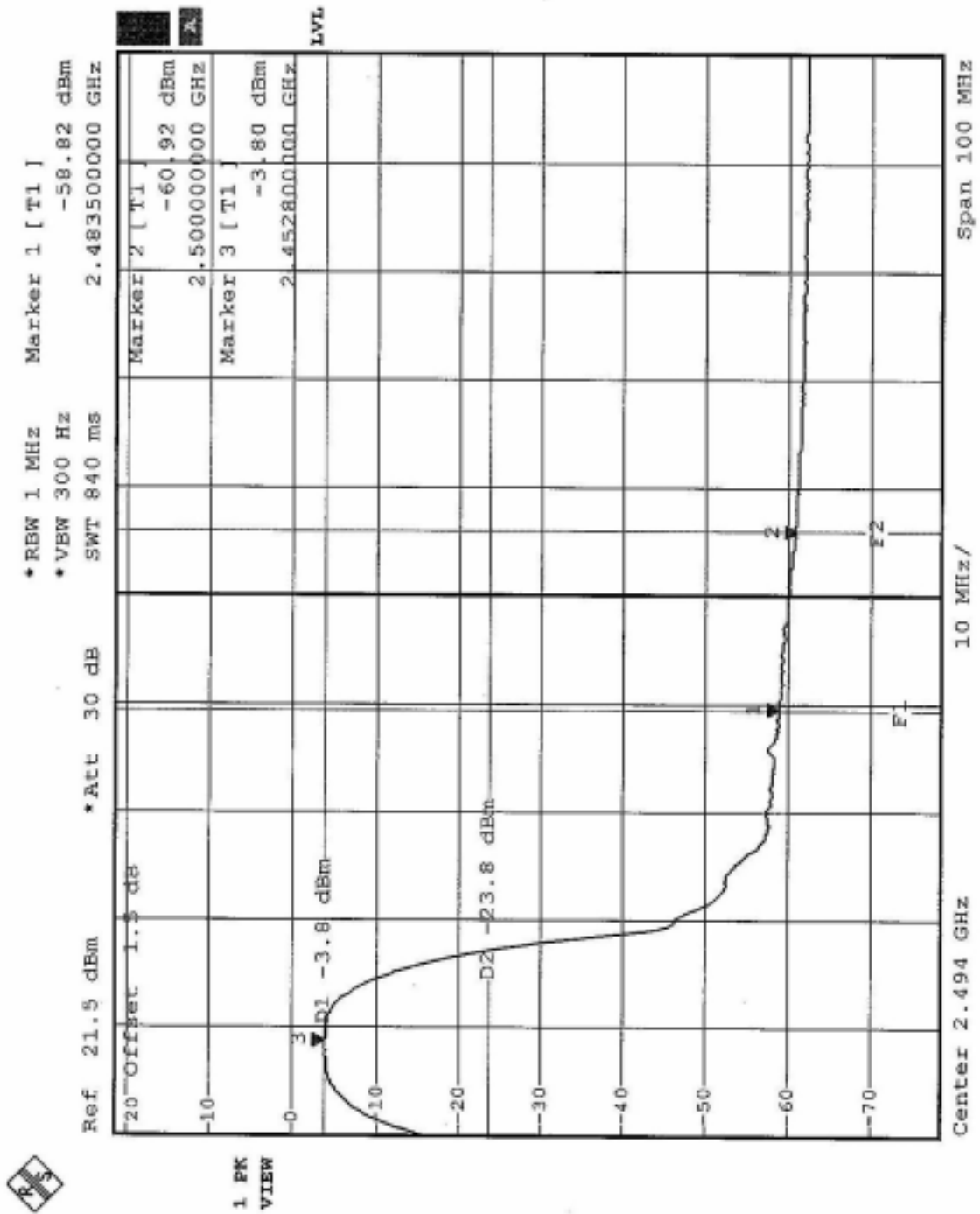



4.6.13 TEST RESULTS –OFDM (Antenna 1)

The spectrum plots are attached on the following 2 pages. D1 line indicates the highest level, and D2 line indicates the 20dB offset below D2. It shows compliance with the requirement in part 15.247(C).

NOTE (1): The band edge emission plot on the following first page shows 45.70dB delta between carrier maximum power and local maximum emission in restrict band (2.390GHz). The emission of carrier strength list in the test result of channel 1 at the item 4.2 is 98.50dBuV/m, so the maximum field strength in restrict band is $98.50 - 45.70 = 52.80$ dBuV/m which is under 54 dBuV/m limit.

NOTE (2): The band edge emission plot on the following second page shows 44.53 dB delta between carrier maximum power and local maximum emission in restrict band (2.4835GHz). The emission of carrier strength list in the test result of channel 11 at the item 4.2 is 98.00dBuV/m, so the maximum field strength in restrict band is $98.00 - 44.53 = 53.47$ dBuV/m which is under 54 dBuV/m limit.

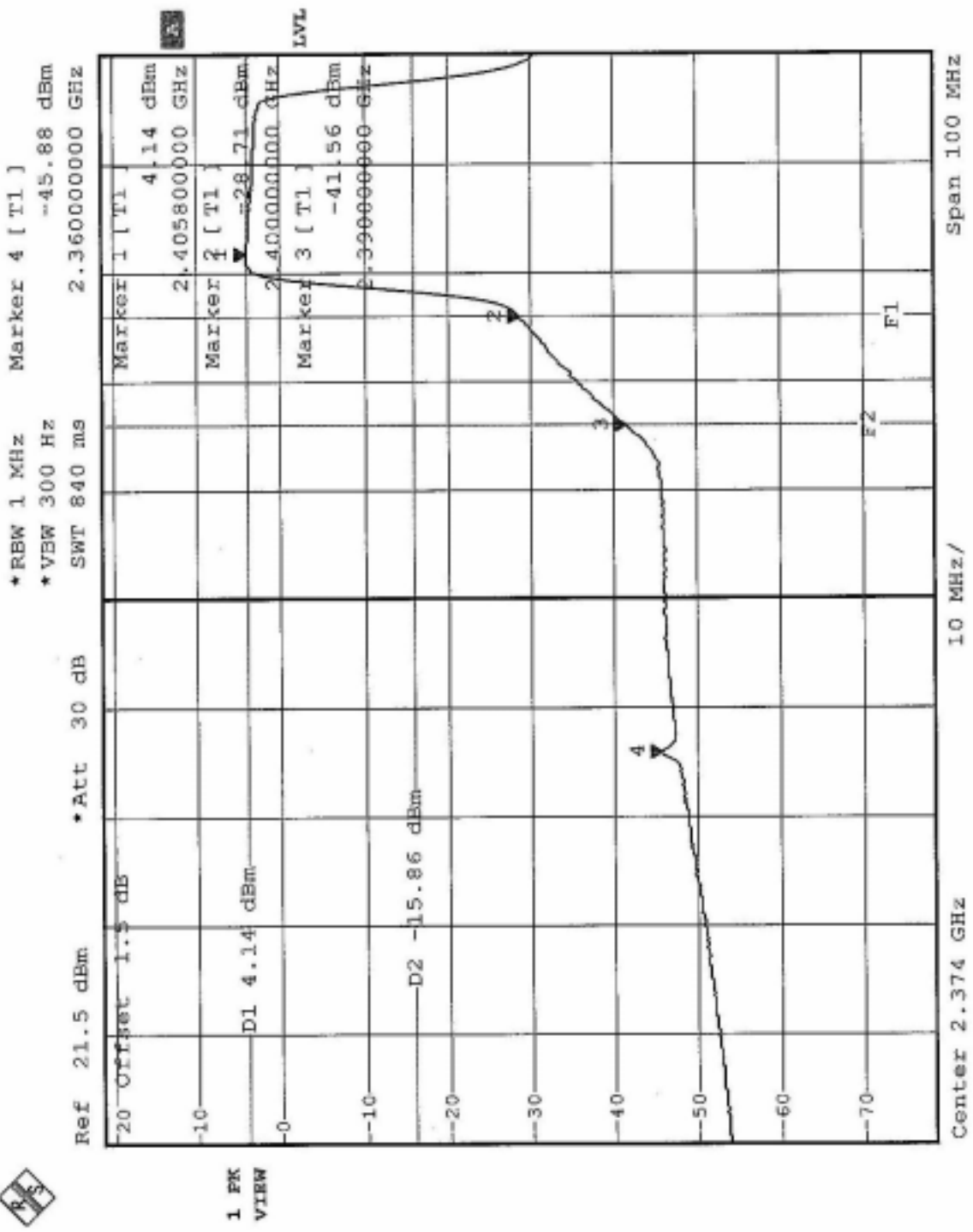

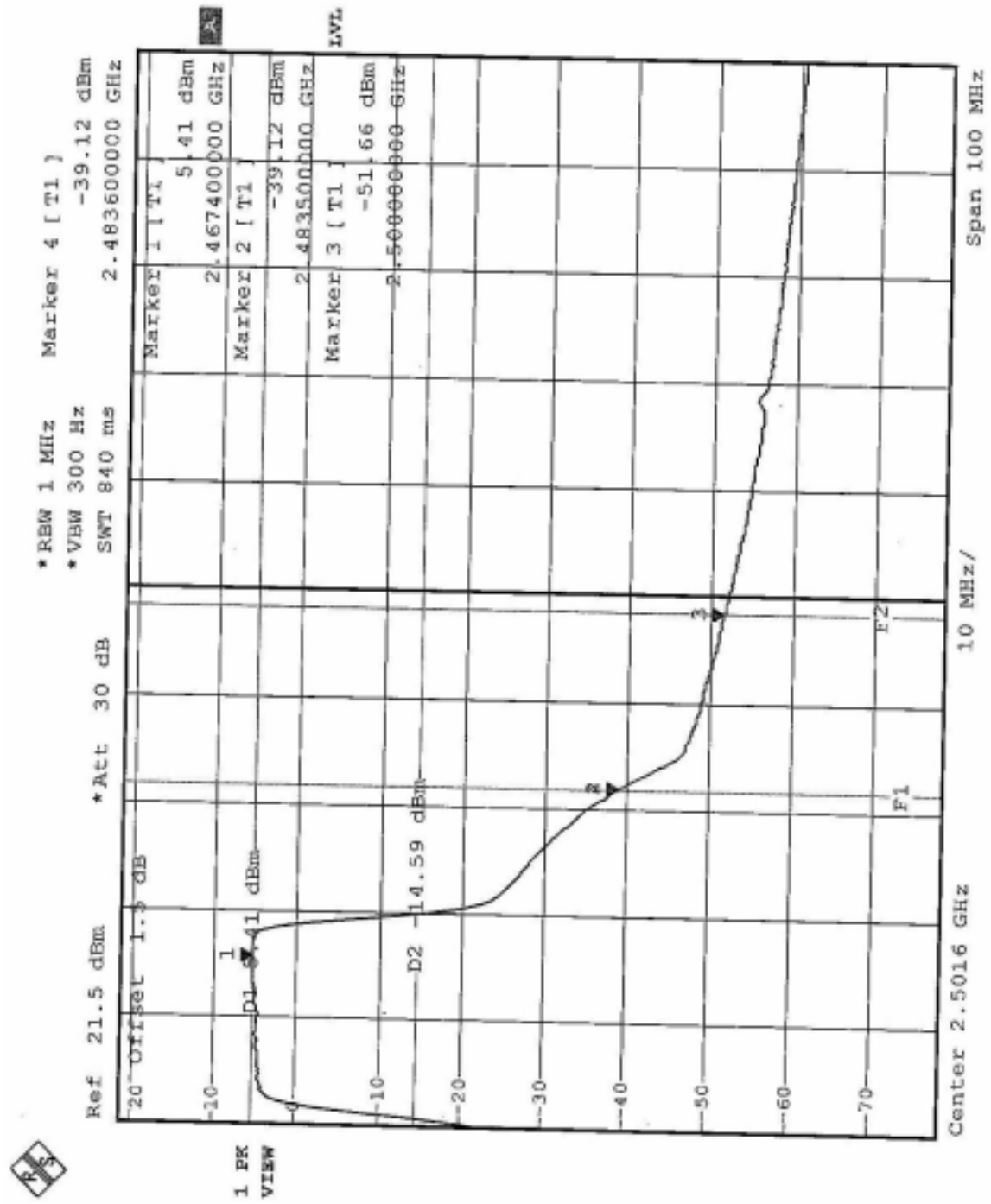



4.6.14 TEST RESULTS –OFDM (Antenna 2)

The spectrum plots are attached on the following 2 pages. D1 line indicates the highest level, and D2 line indicates the 20dB offset below D2. It shows compliance with the requirement in part 15.247(C).

NOTE (1): The band edge emission plot on the following first page shows 46.66dB delta between carrier maximum power and local maximum emission in restrict band (2.390GHz). The emission of carrier strength list in the test result of channel 1 at the item 4.2 is 98.20dBuV/m, so the maximum field strength in restrict band is $98.20 - 46.66 = 51.54$ dBuV/m which is under 54 dBuV/m limit.

NOTE (2): The band edge emission plot on the following second page shows 48.83 dB delta between carrier maximum power and local maximum emission in restrict band (2.4835GHz). The emission of carrier strength list in the test result of channel 11 at the item 4.2 is 100.20dBuV/m, so the maximum field strength in restrict band is $100.20 - 48.83 = 51.37$ dBuV/m which is under 54 dBuV/m limit.

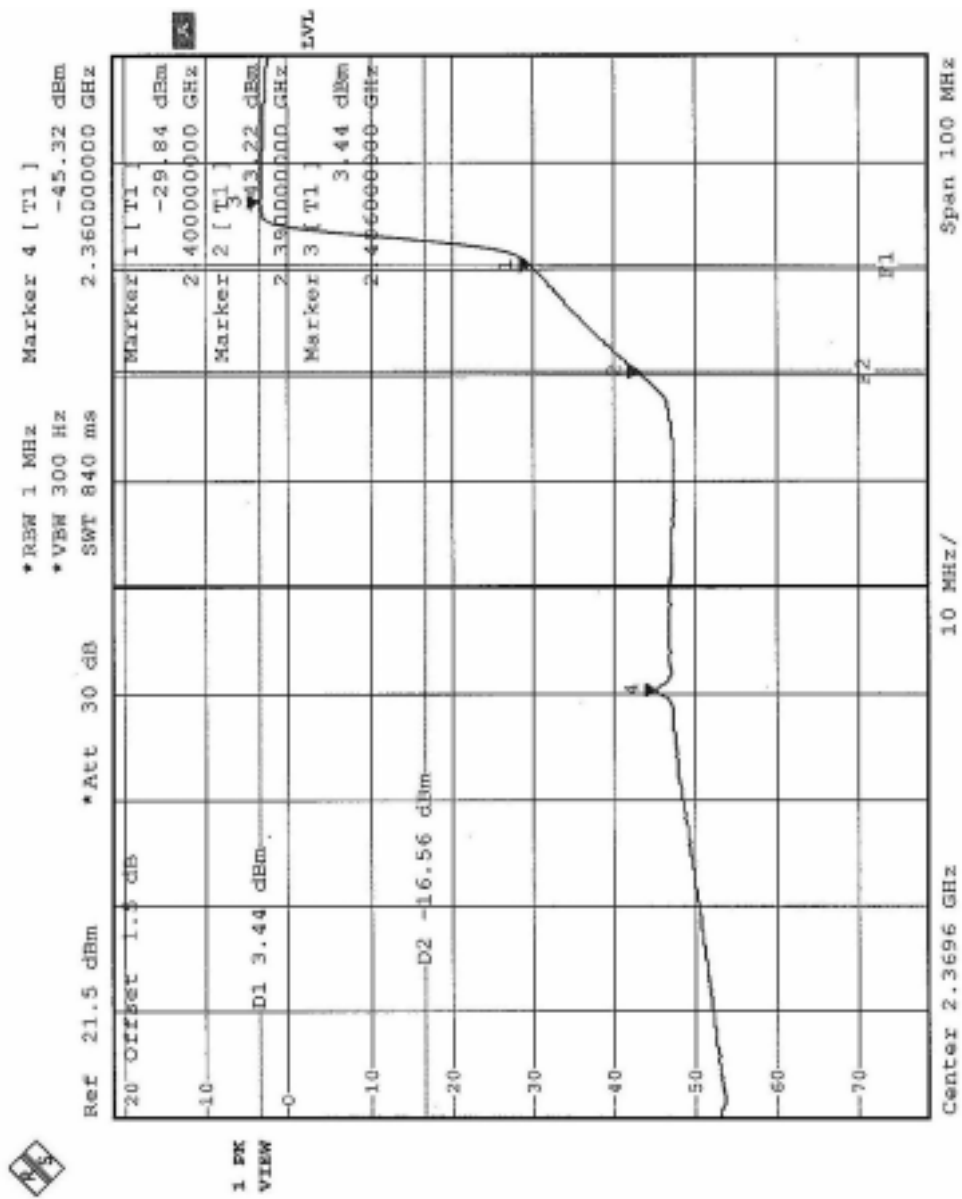

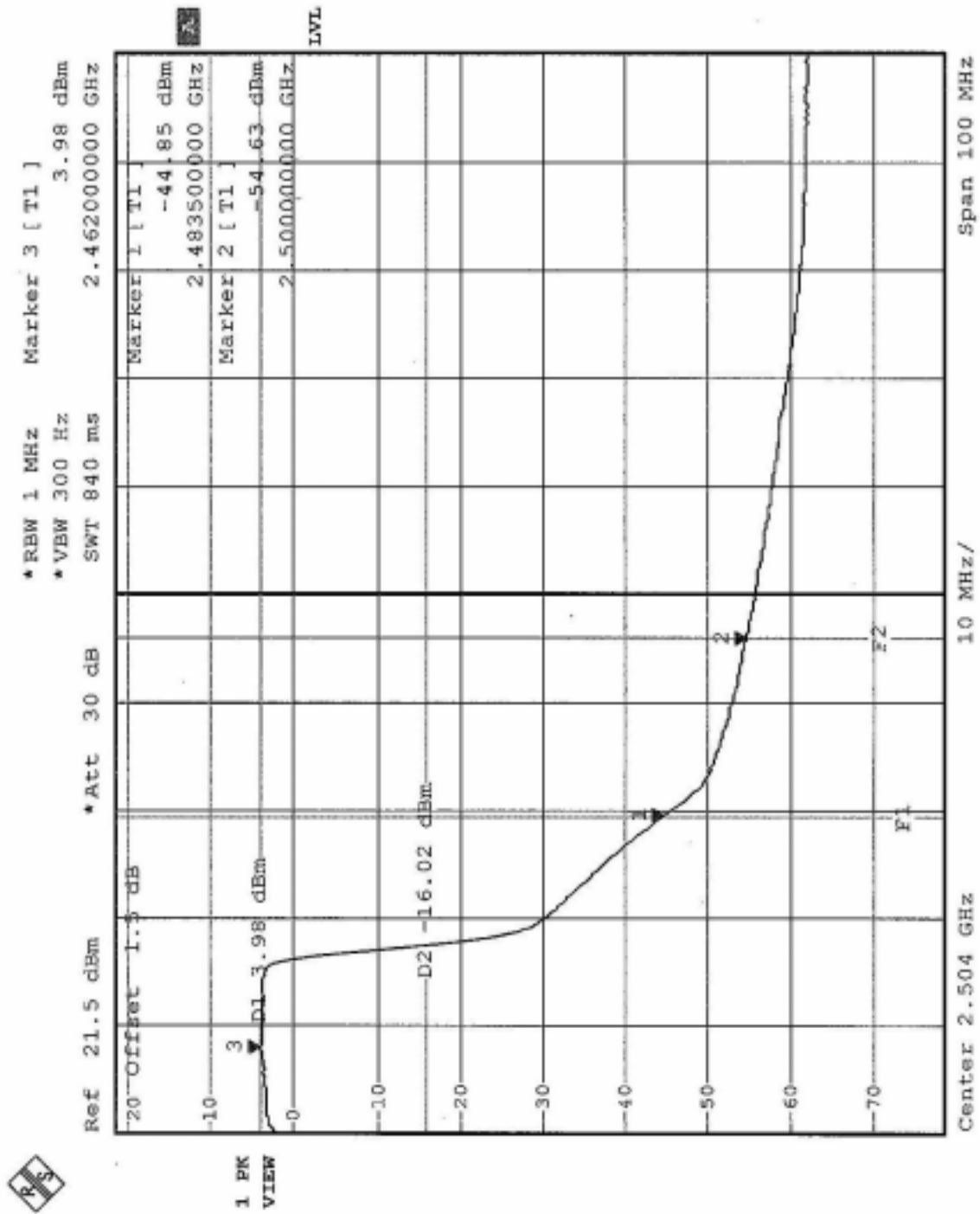



4.6.15 TEST RESULTS –OFDM (Antenna 3)

The spectrum plots are attached on the following 2 pages. D1 line indicates the highest level, and D2 line indicates the 20dB offset below D2. It shows compliance with the requirement in part 15.247(C).

NOTE (1): The band edge emission plot on the following first page shows 47.03dB delta between carrier maximum power and local maximum emission in restrict band (2.390GHz). The emission of carrier strength list in the test result of channel 1 at the item 4.2 is 98.50dBuV/m, so the maximum field strength in restrict band is $98.50 - 47.03 = 51.47$ dBuV/m which is under 54 dBuV/m limit.

NOTE (2): The band edge emission plot on the following second page shows 48.83 dB delta between carrier maximum power and local maximum emission in restrict band (2.4835GHz). The emission of carrier strength list in the test result of channel 11 at the item 4.2 is 98.90dBuV/m, so the maximum field strength in restrict band is $98.90 - 48.83 = 50.07$ dBuV/m which is under 54 dBuV/m limit.

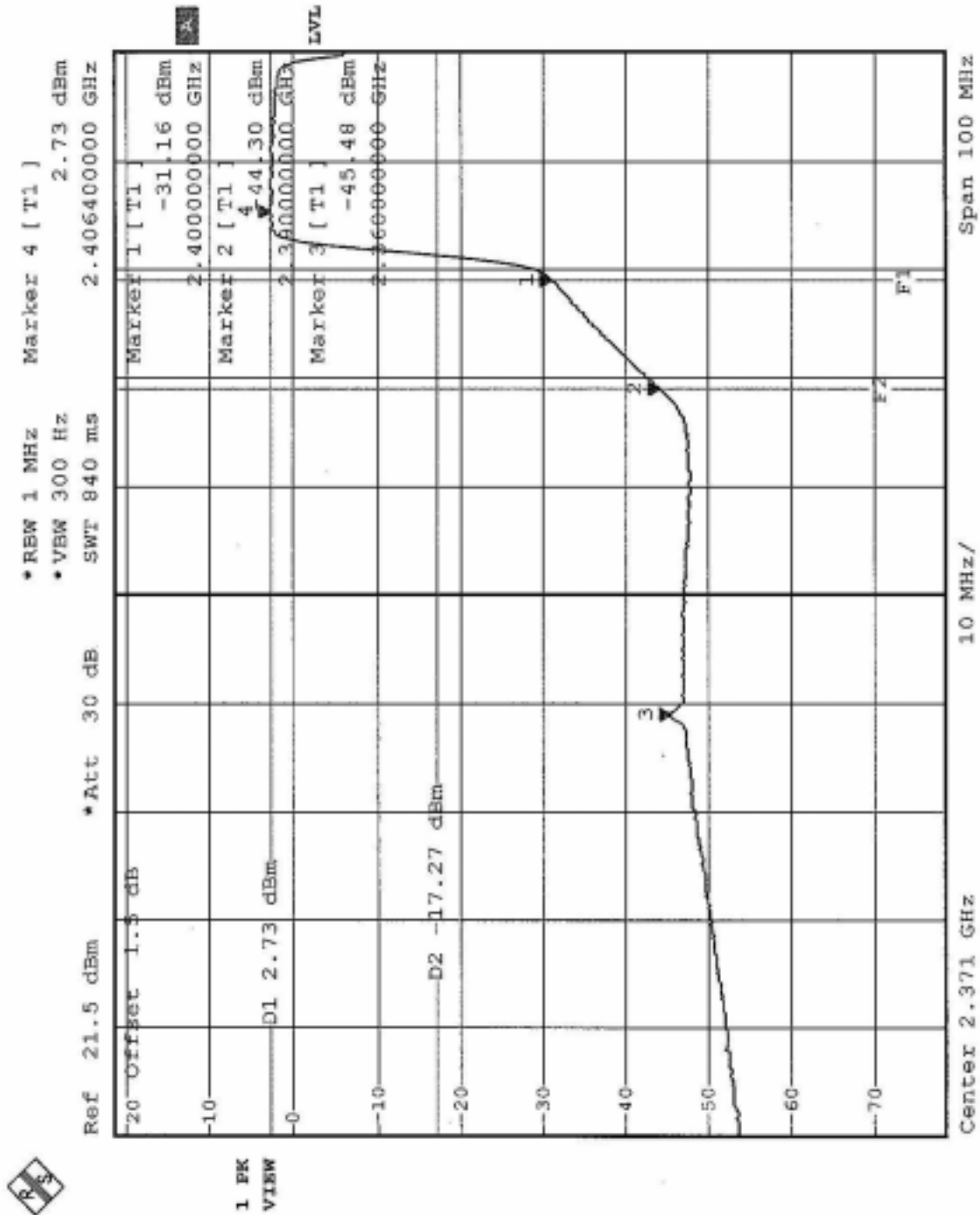

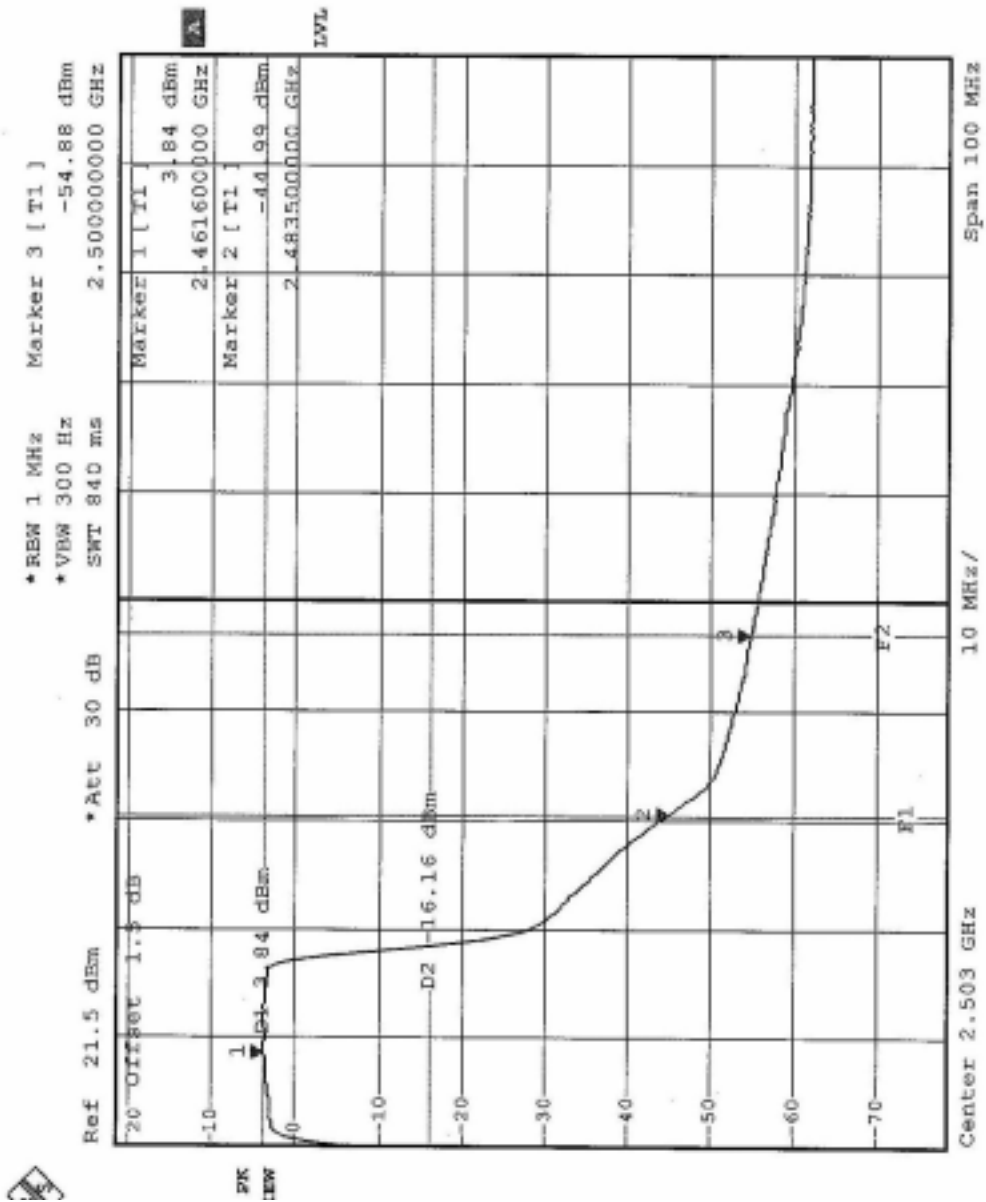



4.6.16 TEST RESULTS –OFDM (Antenna 4)

The spectrum plots are attached on the following 2 pages. D1 line indicates the highest level, and D2 line indicates the 20dB offset below D2. It shows compliance with the requirement in part 15.247(C).

NOTE (1): The band edge emission plot on the following first page shows 48.92dB delta between carrier maximum power and local maximum emission in restrict band (2.390GHz). The emission of carrier strength list in the test result of channel 1 at the item 4.2 is 100.20dBuV/m, so the maximum field strength in restrict band is $100.20 - 48.92 = 51.28$ dBuV/m which is under 54 dBuV/m limit.

NOTE (2): The band edge emission plot on the following second page shows 49.94 dB delta between carrier maximum power and local maximum emission in restrict band (2.4835GHz). The emission of carrier strength list in the test result of channel 11 at the item 4.2 is 101.50dBuV/m, so the maximum field strength in restrict band is $101.50 - 49.94 = 51.56$ dBuV/m which is under 54 dBuV/m limit.

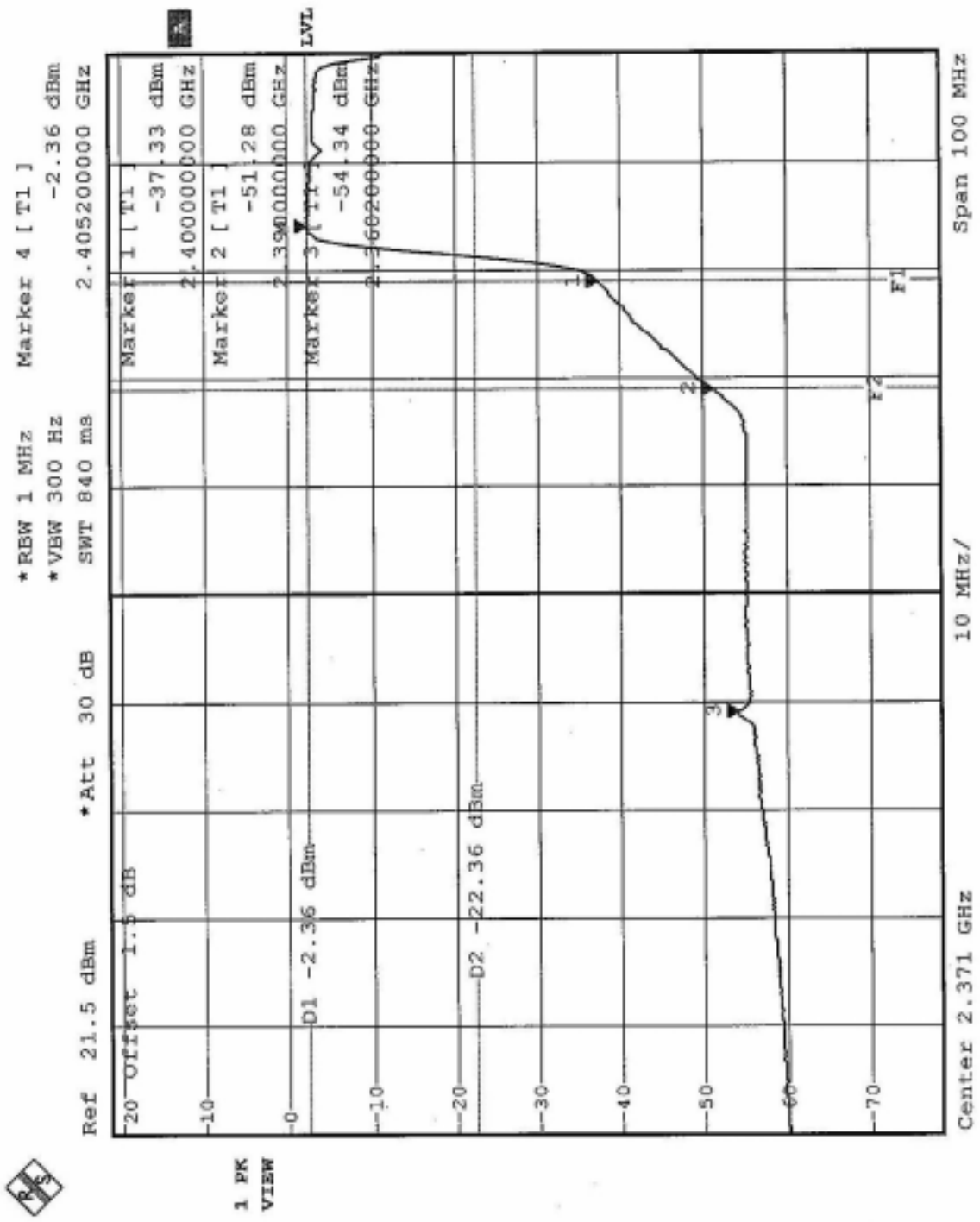

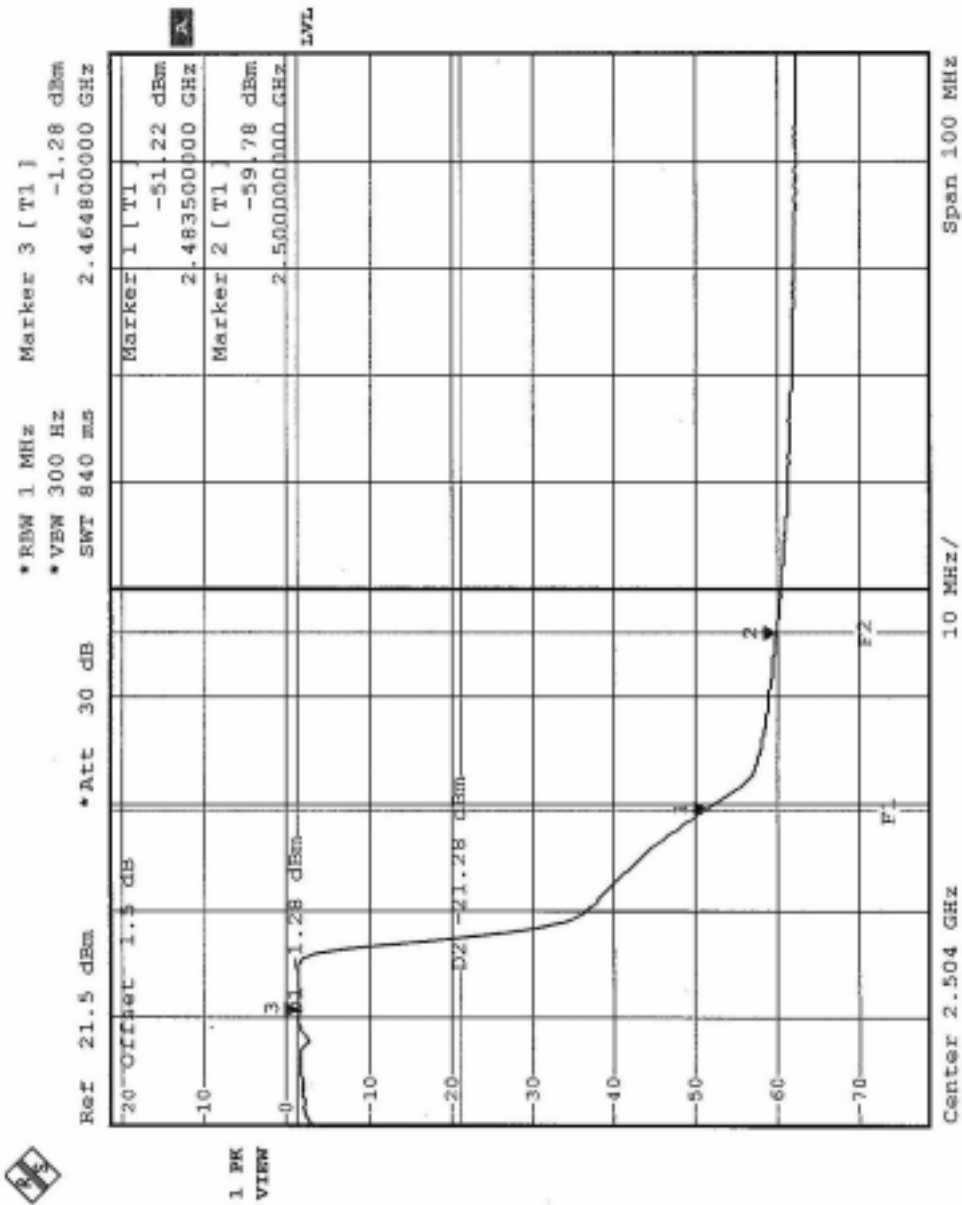



4.6.17 TEST RESULTS –OFDM (Antenna 5)

The spectrum plots are attached on the following 2 pages. D1 line indicates the highest level, and D2 line indicates the 20dB offset below D2. It shows compliance with the requirement in part 15.247(C).

NOTE (1): The band edge emission plot on the following first page shows 48.09dB delta between carrier maximum power and local maximum emission in restrict band (2.390GHz). The emission of carrier strength list in the test result of channel 1 at the item 4.2 is 100.000dBuV/m, so the maximum field strength in restrict band is $100.00-48.09=51.91$ dBuV/m which is under 54 dBuV/m limit.

NOTE (2): The band edge emission plot on the following second page shows 49.42 dB delta between carrier maximum power and local maximum emission in restrict band (2.4835GHz). The emission of carrier strength list in the test result of channel 11 at the item 4.2 is 101.70dBuV/m, so the maximum field strength in restrict band is $101.70-49.42=52.28$ dBuV/m which is under 54 dBuV/m limit.

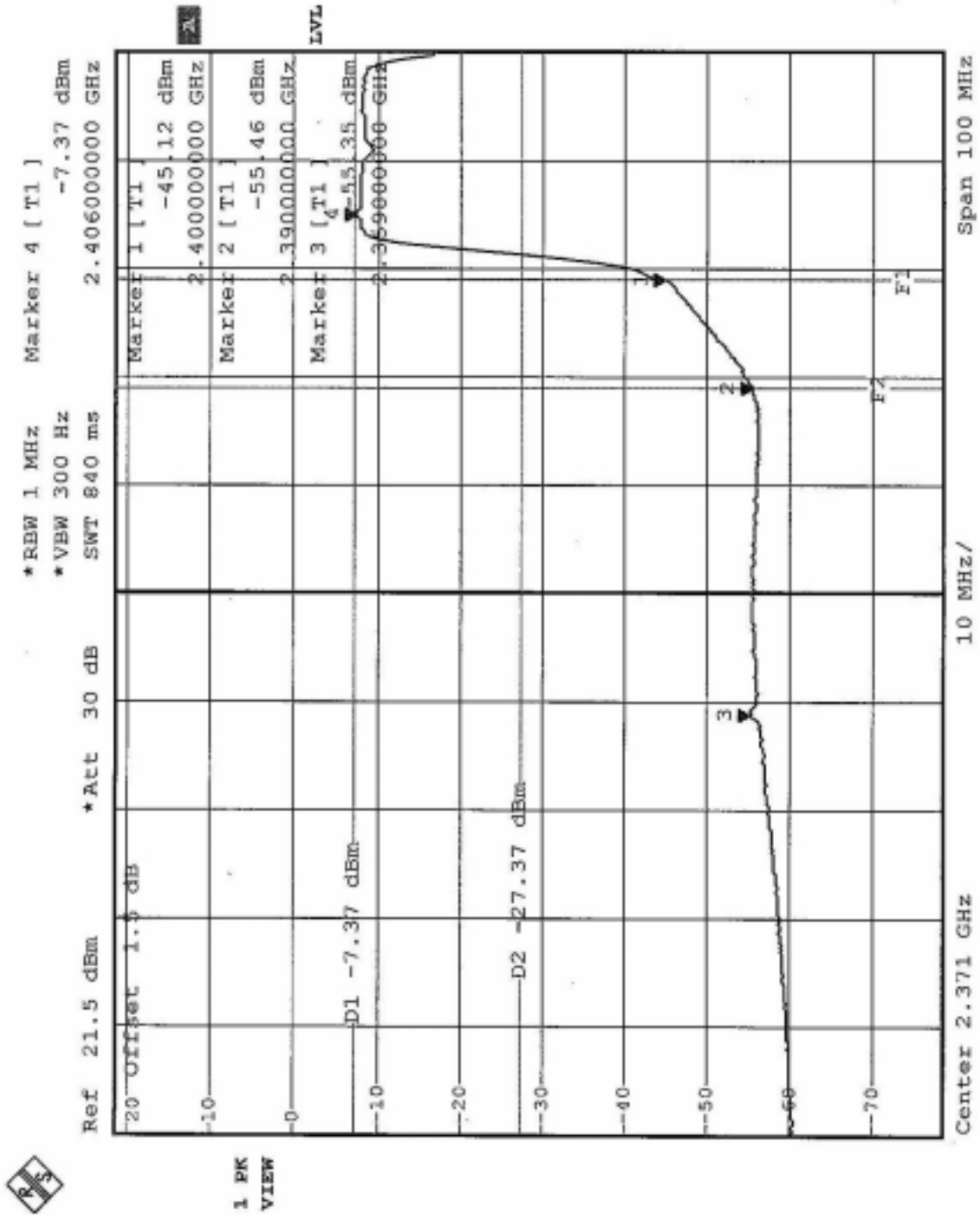

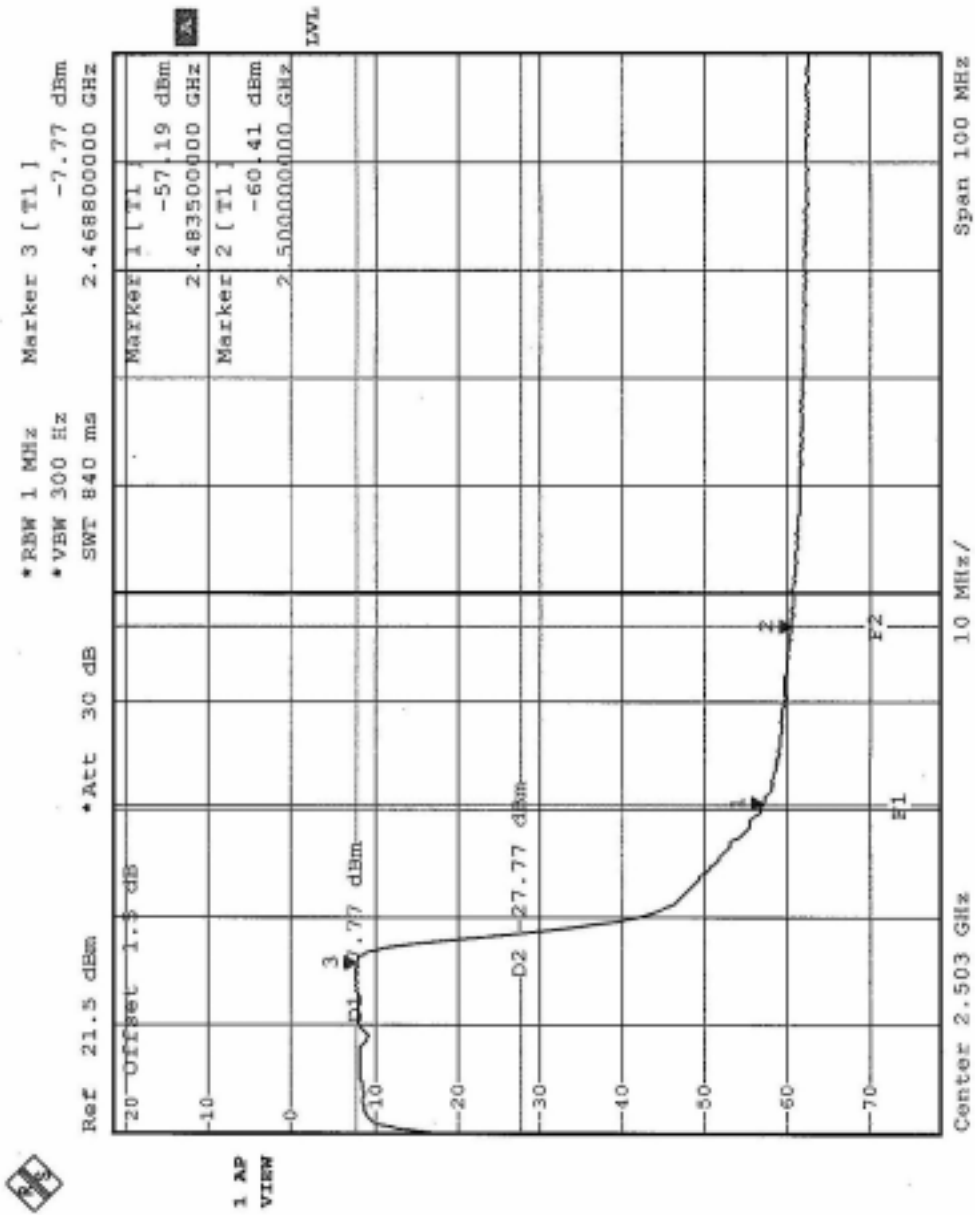



4.6.18 TEST RESULTS –OFDM (Antenna 6)

The spectrum plots are attached on the following 2 pages. D1 line indicates the highest level, and D2 line indicates the 20dB offset below D2. It shows compliance with the requirement in part 15.247(C).

NOTE (1): The band edge emission plot on the following first page shows 47.66dB delta between carrier maximum power and local maximum emission in restrict band (2.390GHz). The emission of carrier strength list in the test result of channel 1 at the item 4.2 is 99.60dBuV/m, so the maximum field strength in restrict band is $99.60 - 47.66 = 51.94$ dBuV/m which is under 54 dBuV/m limit.

NOTE (2): The band edge emission plot on the following second page shows 50.52 dB delta between carrier maximum power and local maximum emission in restrict band (2.4835GHz). The emission of carrier strength list in the test result of channel 11 at the item 4.2 is 102.00dBuV/m, so the maximum field strength in restrict band is $102.00 - 50.52 = 51.48$ dBuV/m which is under 54 dBuV/m limit.

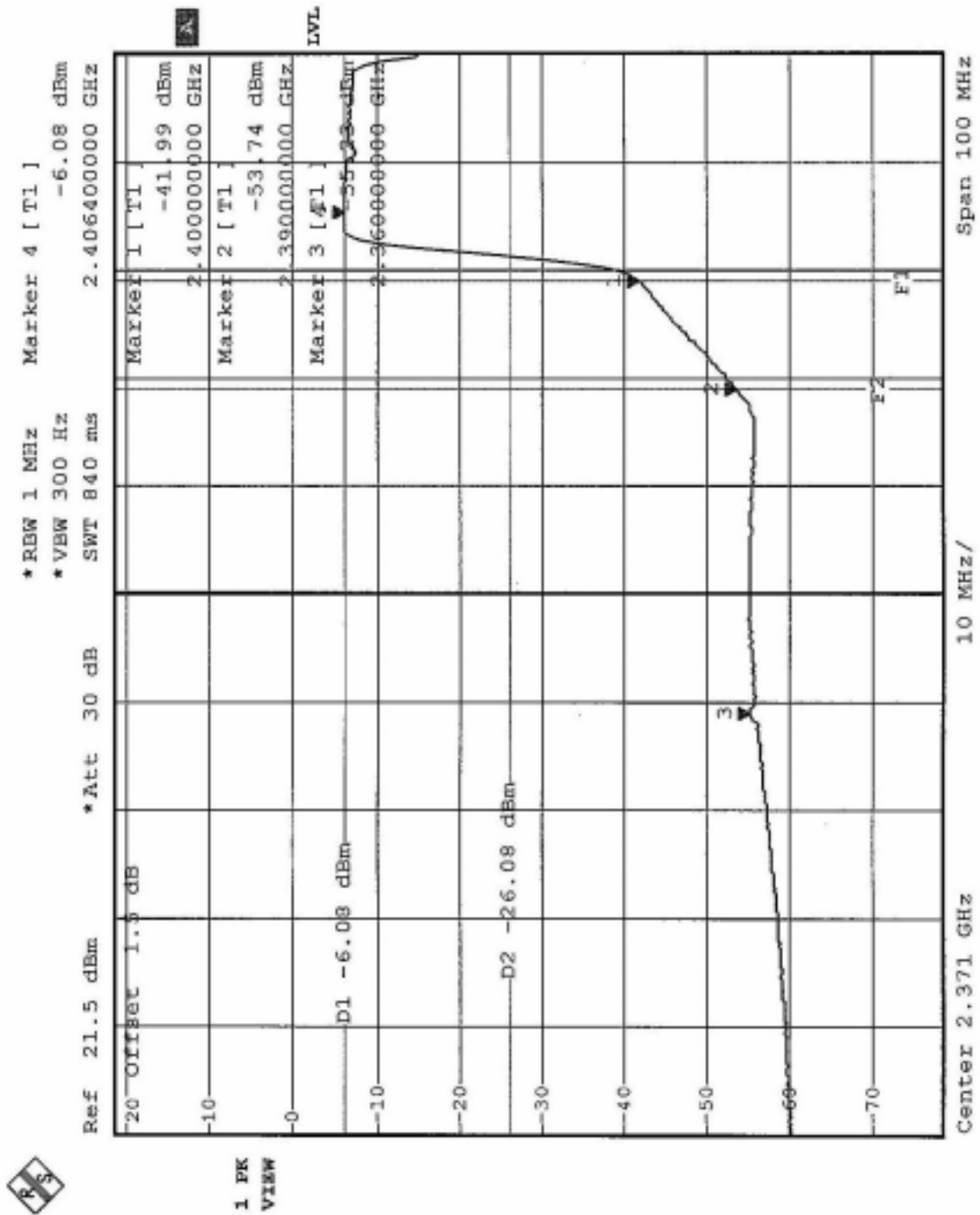

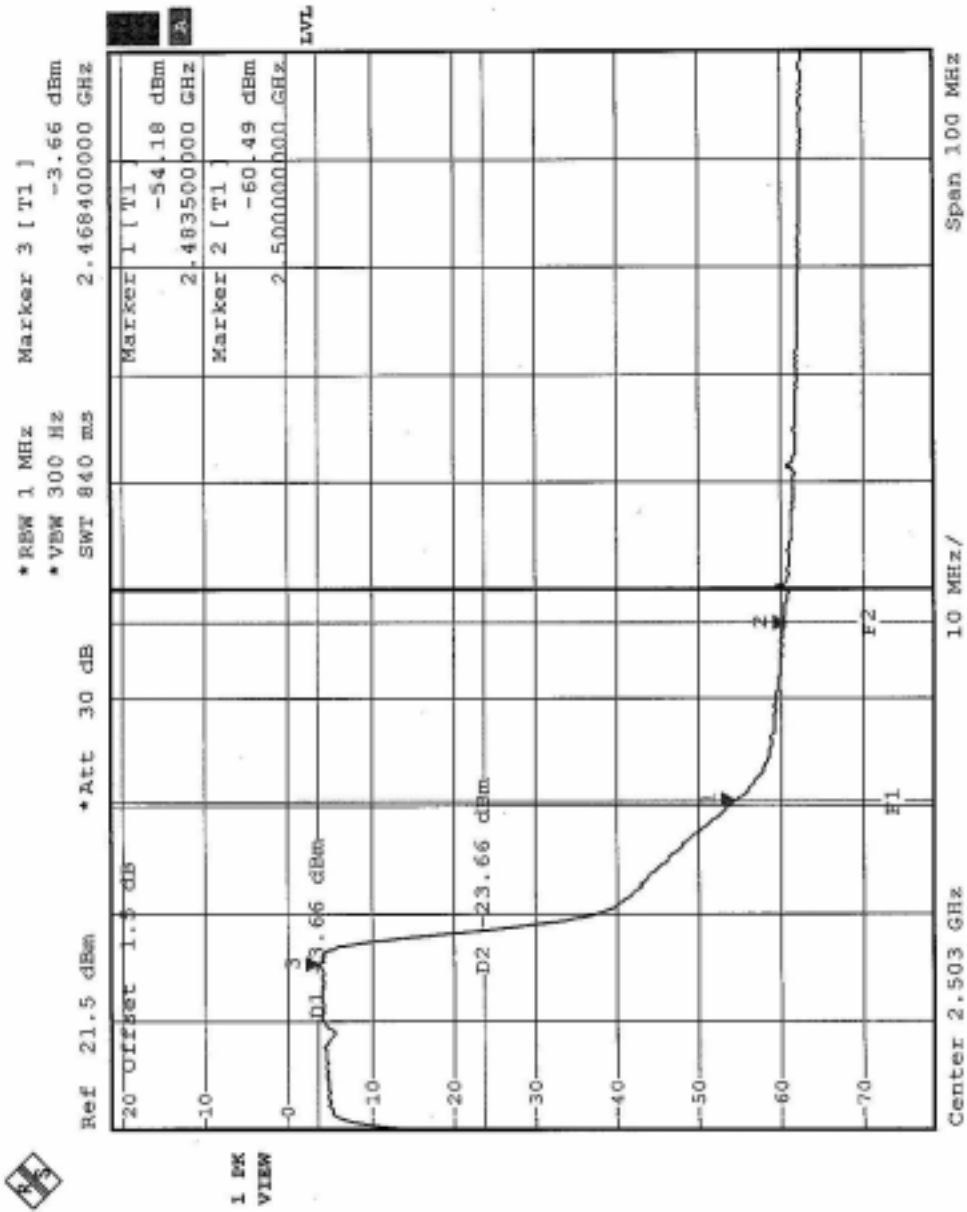



4.6.19 TEST RESULTS –OFDM (Antenna 7)

The spectrum plots are attached on the following 2 pages. D1 line indicates the highest level, and D2 line indicates the 20dB offset below D2. It shows compliance with the requirement in part 15.247(C).

NOTE (1): The band edge emission plot on the following first page shows 51.66dB delta between carrier maximum power and local maximum emission in restrict band (2.390GHz). The emission of carrier strength list in the test result of channel 1 at the item 4.2 is 105.40dBuV/m, so the maximum field strength in restrict band is $105.40-51.66=53.74$ dBuV/m which is under 54 dBuV/m limit.

NOTE (2): The band edge emission plot on the following second page shows 53.23 dB delta between carrier maximum power and local maximum emission in restrict band (2.4835GHz). The emission of carrier strength list in the test result of channel 11 at the item 4.2 is 106.00dBuV/m, so the maximum field strength in restrict band is $106.00-53.23=52.77$ dBuV/m which is under 54 dBuV/m limit.

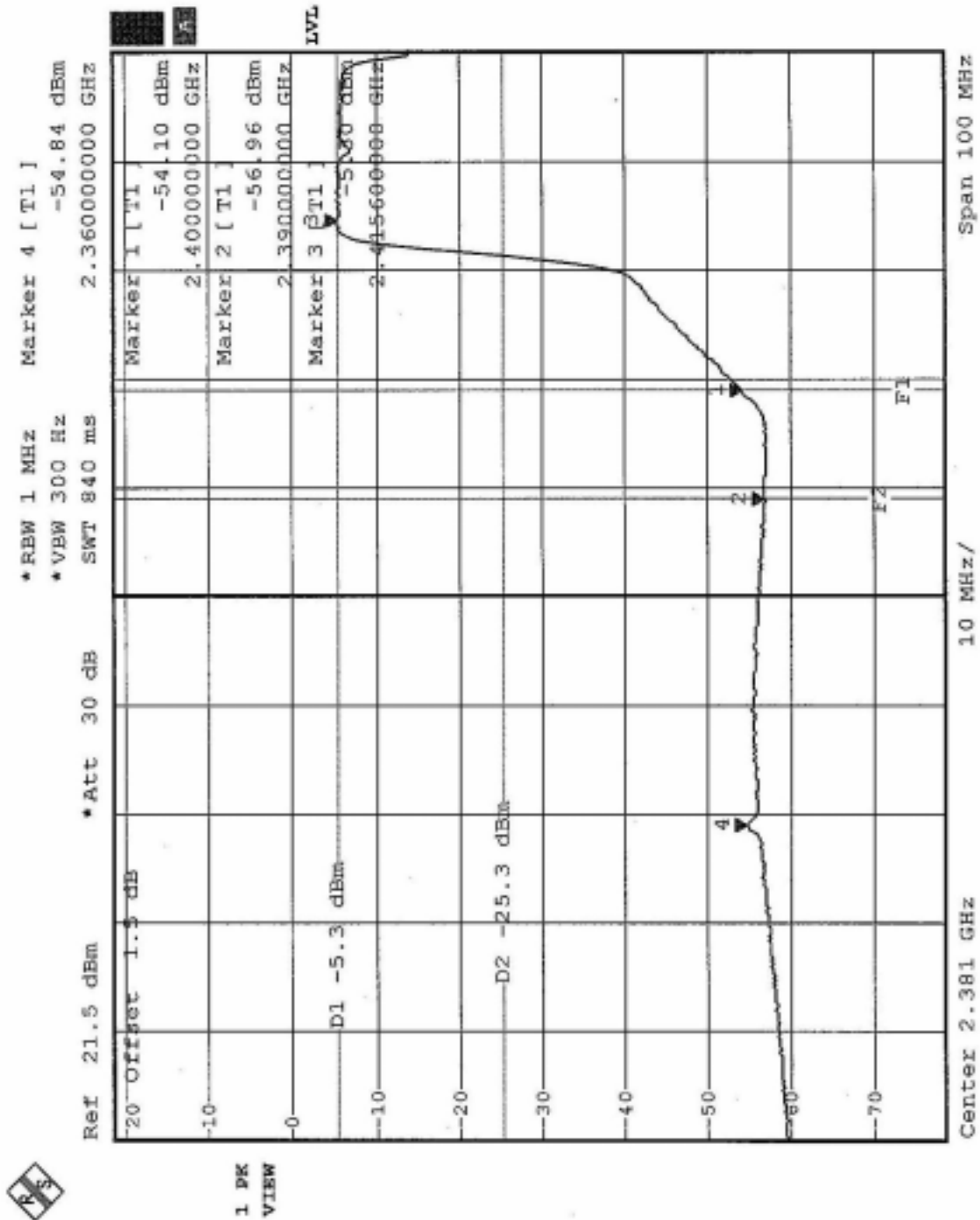

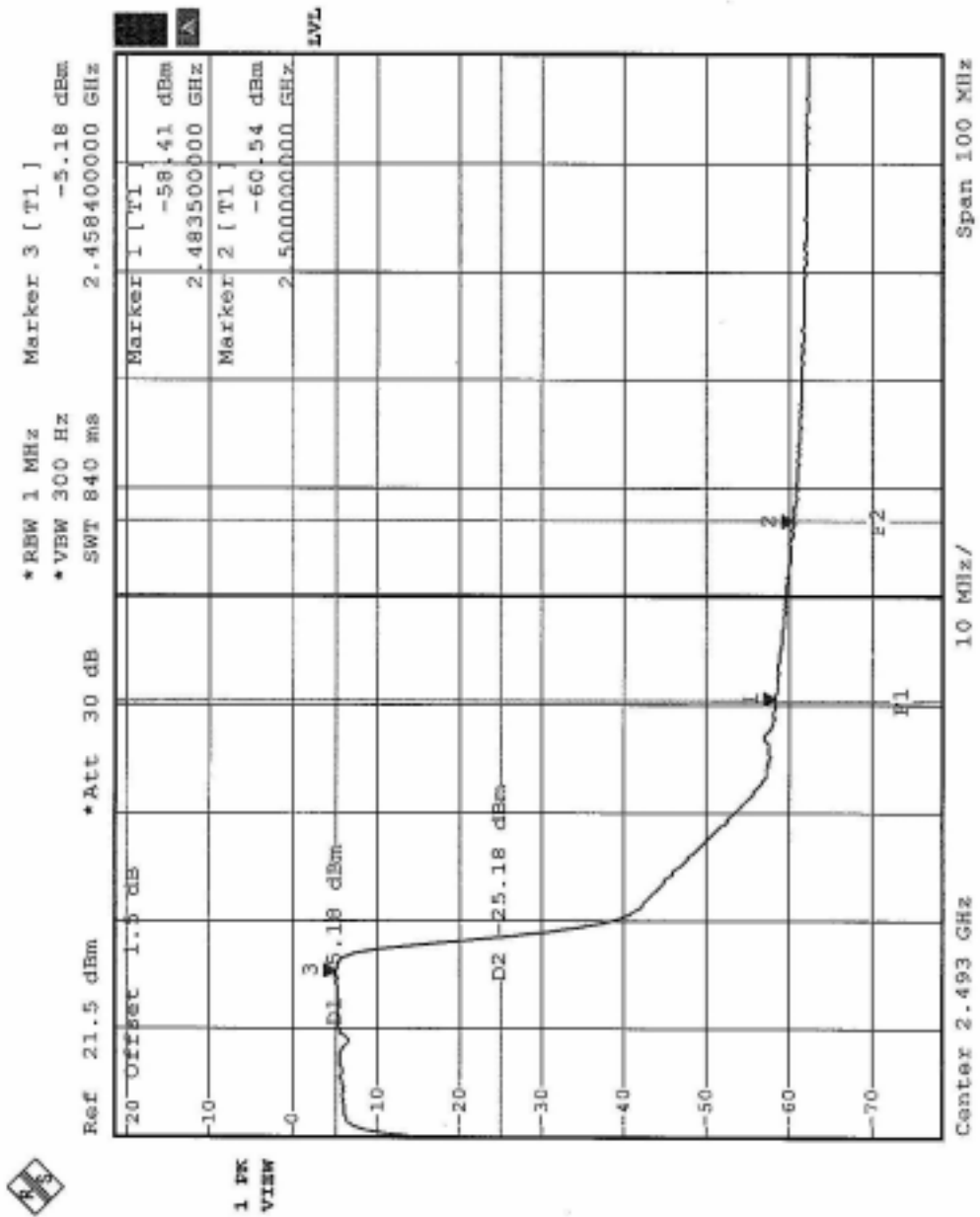



4.7 ANTENNA REQUIREMENT

4.7.1 STANDARD APPLICABLE

For intentional device, according to FCC 47 CFR Section 15.203, an intentional radiator shall be designed to ensure that no antenna other than that furnished by the responsible party shall be used with the device. And according to FCC 47 CFR Section 15.247 (b), if transmitting antennas of directional gain greater than 6dBi are used, the power shall be reduced by the amount in dB that the directional gain of the antenna exceeds 6dBi.

4.7.2 ANTENNA CONNECTED CONSTRUCTION

The antennas used in this product are Dual-Band Omni-Directional Antenna with Aliner 31-401A R/A plug connector and Chip Antenna without connector and Omni, Panel, Yagi, Parabol Antennas with female N-type connectors.

Antenna 1: The maximum Gain of the antenna is 2.5dBi.

Antenna 2: The maximum Gain of the antenna is 2.0dBi.

Antenna 3: The maximum Gain of the antenna is 3.0dBi.

Antenna 4: The maximum Gain of the antenna is 10.0dBi.

Antenna 5: The maximum Gain of the antenna is 14.0dBi.

Antenna 6: The maximum Gain of the antenna is 14.0dBi.

Antenna 7: The maximum Gain of the antenna is 24.0dBi.