



FCC TEST REPORT

REPORT NO.: RF950510H02

MODEL NO.: US-G-AT-01

RECEIVED: May 12, 2006

TESTED: May 12 to 16, 2006

ISSUED: May 16, 2006

APPLICANT: UNIVERSAL SCIENTIFIC INDUSTRIAL CO.,
LTD.

ADDRESS: 141, Lane 351, Taiping Road, Sec. 1, Tsao Tuen,
Nan-Tou, Taiwan, R.O.C.

ISSUED BY: Advance Data Technology Corporation

LAB LOCATION: No. 81-1, Lu Liao Keng, 9 Ling, Wu Lung Tsuen,
Chiung Lin Hsiang, Hsin Chu Hsien,
Taiwan, R.O.C.

This test report consists of 69 pages in total. It may be duplicated completely for legal use with the approval of the applicant. It should not be reproduced except in full, without the written approval of our laboratory. The client should not use it to claim product endorsement by CNLA, A2LA or any government agencies. The test results in the report only apply to the tested sample. The test results in this report are traceable to the national or international standards.





Table of Contents

| | | |
|-------|---|----|
| 1 | CERTIFICATION..... | 4 |
| 2 | SUMMARY OF TEST RESULTS..... | 5 |
| 3 | GENERAL INFORMATION | 6 |
| 3.1 | GENERAL DESCRIPTION OF EUT..... | 6 |
| 3.2 | DESCRIPTION OF TEST MODES..... | 7 |
| 3.3 | TEST MODE APPLICABILITY AND TESTED CHANNEL DETAIL:..... | 8 |
| 3.4 | GENERAL DESCRIPTION OF APPLIED STANDARDS | 10 |
| 3.5 | DESCRIPTION OF SUPPORT UNITS..... | 11 |
| 3.6 | CONFIGURATION OF SYSTEM UNDER TEST | 12 |
| 4 | TEST TYPES AND RESULTS..... | 13 |
| 4.1 | CONDUCTED EMISSION MEASUREMENT | 13 |
| 4.1.1 | LIMITS OF CONDUCTED EMISSION MEASUREMENT | 13 |
| 4.1.2 | TEST INSTRUMENTS | 13 |
| 4.1.3 | TEST PROCEDURES..... | 14 |
| 4.1.4 | TEST SETUP | 14 |
| 4.1.5 | EUT OPERATING CONDITIONS..... | 15 |
| 4.1.6 | TEST RESULTS..... | 16 |
| 4.2 | RADIATED EMISSION MEASUREMENT | 18 |
| 4.2.1 | LIMITS OF RADIATED EMISSION MEASUREMENT | 18 |
| 4.2.2 | TEST INSTRUMENTS | 19 |
| 4.2.3 | TEST PROCEDURES..... | 20 |
| 4.2.4 | TEST SETUP..... | 21 |
| 4.2.5 | EUT OPERATING CONDITIONS..... | 21 |
| 4.2.6 | TEST RESULTS..... | 22 |
| 4.2.7 | TEST RESULTS - DSSS..... | 24 |
| 4.2.8 | TEST RESULTS - OFDM | 31 |
| 4.3 | 6dB BANDWIDTH MEASUREMENT | 38 |
| 4.3.1 | LIMITS OF 6dB BANDWIDTH MEASUREMENT | 38 |
| 4.3.2 | TEST INSTRUMENTS | 38 |
| 4.3.3 | TEST PROCEDURE | 39 |
| 4.3.4 | TEST SETUP | 39 |
| 4.3.5 | EUT OPERATING CONDITIONS..... | 39 |
| 4.3.6 | TEST RESULTS –DSSS | 40 |
| 4.3.7 | TEST RESULTS-OFDM | 43 |
| 4.4 | MAXIMUM PEAK OUTPUT POWER..... | 46 |
| 4.4.1 | LIMITS OF MAXIMUM PEAK OUTPUT POWER MEASUREMENT..... | 46 |
| 4.4.2 | TEST INSTRUMENTS | 46 |
| 4.4.3 | TEST PROCEDURES..... | 47 |
| 4.4.4 | TEST SETUP..... | 47 |



| | | |
|-------|---|-----|
| 4.4.5 | EUT OPERATING CONDITIONS..... | 47 |
| 4.4.6 | TEST RESULTS – DSSS | 48 |
| 4.4.7 | TEST RESULTS –OFDM | 49 |
| 4.5 | POWER SPECTRAL DENSITY MEASUREMENT..... | 50 |
| 4.5.1 | LIMITS OF POWER SPECTRAL DENSITY MEASUREMENT | 50 |
| 4.5.2 | TEST INSTRUMENTS | 50 |
| 4.5.3 | TEST PROCEDURE | 51 |
| 4.5.4 | TEST SETUP | 51 |
| 4.5.5 | EUT OPERATING CONDITIONS..... | 51 |
| 4.5.6 | TEST RESULTS –DSSS | 52 |
| 4.5.7 | TEST RESULTS –OFDM | 55 |
| 4.6 | CONDUCTED EMISSION AND BAND EDGES MEASUREMENT | 58 |
| 4.6.1 | LIMITS OF CONDUCTED EMISSION AND BAND EDGES MEASUREMENT | 58 |
| 4.6.2 | TEST INSTRUMENTS | 58 |
| 4.6.3 | TEST PROCEDURE | 58 |
| 4.6.4 | DEVIATION FROM TEST STANDARD | 58 |
| 4.6.5 | EUT OPERATING CONDITION | 58 |
| 4.6.6 | TEST RESULTS..... | 59 |
| 4.7 | ANTENNA REQUIREMENT | 64 |
| 4.7.1 | STANDARD APPLICABLE | 64 |
| 4.7.2 | ANTENNA CONNECTED CONSTRUCTION..... | 64 |
| 5 | PHOTOGRAPHS OF THE TEST CONFIGURATION..... | 65 |
| 6 | INFORMATION ON THE TESTING LABORATORIES | 68 |
| | APPENDIX-A | A-1 |



1 CERTIFICATION

PRODUCT : WIRELESS USB ADAPTER
BRAND NAME : USI
MODEL NO. : US-G-AT-01
TESTED: May 12 to 16, 2006
APPLICANT : UNIVERSAL SCIENTIFIC INDUSTRIAL CO., LTD.
TEST ITEM: R&D SAMPLE
STANDARDS : 47 CFR Part 15, Subpart C (Section 15.247),
ANSI C63.4-2003

The above equipment (Model: US-G-AT-01) has been tested by **Advance Data Technology Corporation**, and found compliance with the requirement of the above standards. The test record, data evaluation & Equipment Under Test (EUT) configurations represented herein are true and accurate accounts of the measurements of the sample's EMC characteristics under the conditions specified in this report.

PREPARED BY : Midoli Peng , **DATE:** May 16, 2006
(Midoli Peng)

TECHNICAL ACCEPTANCE : Hank Chung , **DATE:** May 16, 2006
Responsible for RF (Hank Chung)

APPROVED BY : May Chen , **DATE:** May 16, 2006
(May Chen, Deputy Manager)



2 SUMMARY OF TEST RESULTS

The EUT has been tested according to the following specifications:

| APPLIED STANDARD: 47 CFR Part 15, Subpart C | | | |
|--|---|---------------|---|
| Standard Section | Test Type and Limit | Result | REMARK |
| 15.207 | AC Power Conducted Emission | PASS | Meet the requirement of limit Minimum passing margin is -14.73 dB at 0.170 MHz |
| 15.247(a)(2) | Spectrum Bandwidth of a Direct Sequence Spread Spectrum System Limit: min. 500kHz | PASS | Meet the requirement of limit |
| 15.247(b) | Maximum Peak Output Power Limit: max. 30dBm | PASS | Meet the requirement of limit |
| 15.247(c) | Transmitter Radiated Emissions Limit: Table 15.209 | PASS | Meet the requirement of limit Minimum passing margin is -0.1 dB at 4924.00 MHz |
| 15.247(d) | Power Spectral Density Limit: max. 8dBm | PASS | Meet the requirement of limit |
| 15.247(c) | Band Edge Measurement Limit: 20 dB less than the peak value of fundamental frequency | PASS | Meet the requirement of limit |

3 GENERAL INFORMATION

3.1 GENERAL DESCRIPTION OF EUT

| | |
|---------------------------|---|
| PRODUCT | WIRELESS USB ADAPTER |
| MODEL NO. | US-G-AT-01 |
| FCC ID | IXM-USGAT01 |
| POWER SUPPLY | DC 5V from host equipment |
| MODULATION TYPE | CCK, DQPSK, DBPSK for DSSS 64QAM, 16QAM, QPSK, BPSK for OFDM |
| RADIO TECHNOLOGY | DSSS, OFDM |
| TRANSFER RATE | 802.11b: 11/5.5/2/1Mbps 802.11g: 54/48/36/24/18/12/9/6Mbps |
| FREQUENCY RANGE | 2412MHz ~ 2462MHz |
| NUMBER OF CHANNEL | 11 |
| CHANNEL SPACING | 5MHz |
| OUTPUT POWER | 802.11b: 63.096mW 802.11g: 63.096mW |
| ANTENNA TYPE | Printed antenna with 1.98dBi antenna gain |
| INTERFACE | USB interface |
| DATA CABLE | USB cable (Unshielded, 1.6m) |
| ASSOCIATED DEVICES | USB Cradle |

NOTE:

1. The EUT operates in the 2.4GHz frequency spectrum with throughput of up to 54Mbps.
2. The EUT complies with IEEE 802.11g standards, and backwards compatible with IEEE 802.11b products.
3. The above EUT information was declared by the manufacturer and for more detailed features description, please refer to the manufacturer's specifications or User's Manual.

3.2 DESCRIPTION OF TEST MODES

Operated in 2400 ~ 2483.5MHz band:

For 802.11b/g normal mode: Eleven channels are provided to this EUT.

| Channel | Frequency | Channel | Frequency |
|---------|-----------|---------|-----------|
| 1 | 2412 MHz | 7 | 2442 MHz |
| 2 | 2417 MHz | 8 | 2447 MHz |
| 3 | 2422 MHz | 9 | 2452 MHz |
| 4 | 2427 MHz | 10 | 2457 MHz |
| 5 | 2432 MHz | 11 | 2462 MHz |
| 6 | 2437 MHz | | |

3.3 TEST MODE APPLICABILITY AND TESTED CHANNEL DETAIL:

| EUT configure mode | Applicable to | | | | Description |
|--------------------|---------------|-------|-------|------|-------------|
| | PLC | RE<1G | RE≥1G | APCM | |
| - | √ | √ | √ | √ | NA |

Where PLC: Power Line Conducted Emission RE<1G RE: Radiated Emission below 1GHz
 RE≥1G: Radiated Emission above 1GHz APCM: Antenna Port Conducted Measurement

Power Line Conducted Emission Test:

- Pre-Scan has been conducted to determine the worst-case mode from all possible combinations between available modulations, data rates and antenna ports (if EUT with antenna diversity architecture).
- Following channel(s) was (were) selected for the final test as listed below.

| Mode | Available Channel | Tested Channel | Modulation Technology | Modulation Type | Data Rate (Mbps) |
|---------|-------------------|----------------|-----------------------|-----------------|------------------|
| 802.11b | 1 to 11 | 1 | DSSS | CCK | 1 |

- The EUT was pre-tested in chamber as the following test modes:

| Test Mode | Description |
|-----------|--------------------|
| Mode 1 | With USB cradle |
| Mode 2 | Without USB cradle |

Mode 1, the worse case one, was chosen for final test.

Radiated Emission Test (Below 1 GHz):

- Pre-Scan has been conducted to determine the worst-case mode from all possible combinations between available modulations, data rates and antenna ports (if EUT with antenna diversity architecture).
- Following channel(s) was (were) selected for the final test as listed below.

| Mode | Available Channel | Tested Channel | Modulation Technology | Modulation Type | Data Rate (Mbps) |
|---------|-------------------|----------------|-----------------------|-----------------|------------------|
| 802.11b | 1 to 11 | 1 | DSSS | CCK | 1 |

- The EUT was tested with the following modes:

| Test Mode | Description |
|-----------|--------------------|
| Mode 1 | With USB cradle |
| Mode 2 | Without USB cradle |



Radiated Emission Test (Above 1 GHz):

- Pre-Scan has been conducted to determine the worst-case mode from all possible combinations between available modulations, data rates and antenna ports (if EUT with antenna diversity architecture).
- Following channel(s) was (were) selected for the final test as listed below.

| Mode | Available Channel | Tested Channel | Modulation Technology | Modulation Type | Data Rate (Mbps) |
|---------|-------------------|----------------|-----------------------|-----------------|------------------|
| 802.11b | 1 to 11 | 1, 6, 11 | DSSS | CCK | 1 |
| 802.11g | 1 to 11 | 1, 6, 11 | OFDM | BPSK | 6 |

- The EUT was pre-tested in chamber as the following test modes:

| Test Mode | Description |
|-----------|--------------------|
| Mode 1 | With USB cradle |
| Mode 2 | Without USB cradle |

Mode 1, the worse case one, was chosen for final test.

Bandedge Measurement:

- Pre-Scan has been conducted to determine the worst-case mode from all possible combinations between available modulations, data rates and antenna ports (if EUT with antenna diversity architecture).
- Following channel(s) was (were) selected for the final test as listed below.

| Mode | Available Channel | Tested Channel | Modulation Technology | Modulation Type | Data Rate (Mbps) |
|---------|-------------------|----------------|-----------------------|-----------------|------------------|
| 802.11b | 1 to 11 | 1, 11 | DSSS | CCK | 1 |
| 802.11g | 1 to 11 | 1, 11 | OFDM | BPSK | 6 |

Antenna Port Conducted Measurement:

- Pre-Scan has been conducted to determine the worst-case mode from all possible combinations between available modulations, data rates and antenna ports (if EUT with antenna diversity architecture).
- Following channel(s) was (were) selected for the final test as listed below.

| Mode | Available Channel | Tested Channel | Modulation Technology | Modulation Type | Data Rate (Mbps) |
|---------|-------------------|----------------|-----------------------|-----------------|------------------|
| 802.11b | 1 to 11 | 1, 6, 11 | DSSS | CCK | 1 |
| 802.11g | 1 to 11 | 1, 6, 11 | OFDM | BPSK | 6 |



3.4 GENERAL DESCRIPTION OF APPLIED STANDARDS

The EUT is a WIRELESS USB ADAPTER. According to the specifications of the manufacturer, it must comply with the requirements of the following standards:

47 CFR Part 15, Subpart C. (15.247)
ANSI C63.4 : 2003

All tests have been performed and recorded as per the above standards.



3.5 DESCRIPTION OF SUPPORT UNITS

The EUT has been tested as an independent unit together with other necessary accessories or support units. The following support units or accessories were used to form a representative test configuration during the tests.

| No. | Product | Brand | Model No. | Serial No. | FCC ID |
|-----|----------------------|-------|-----------|------------|------------|
| 1 | NOTEBOOK COMPUTER | DELL | PP036 | NA | NA |
| 2 | MODEM | ACEEX | 1414 | 0206026775 | IFAXDM1414 |

| No. | Signal cable description |
|-----|--|
| 1 | NA |
| 2 | 1.0 m braid shielded wire, terminated with DB25 and DB9 connector via metallic frame, w/o core |

Note: 1. All power cords of the above support units are unshielded (1.8m).

3.6 CONFIGURATION OF SYSTEM UNDER TEST

Without USB cradle

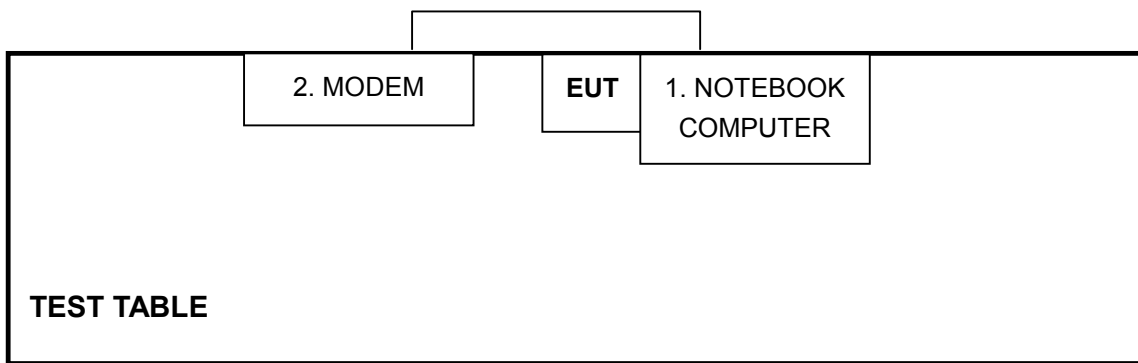

With USB cradle

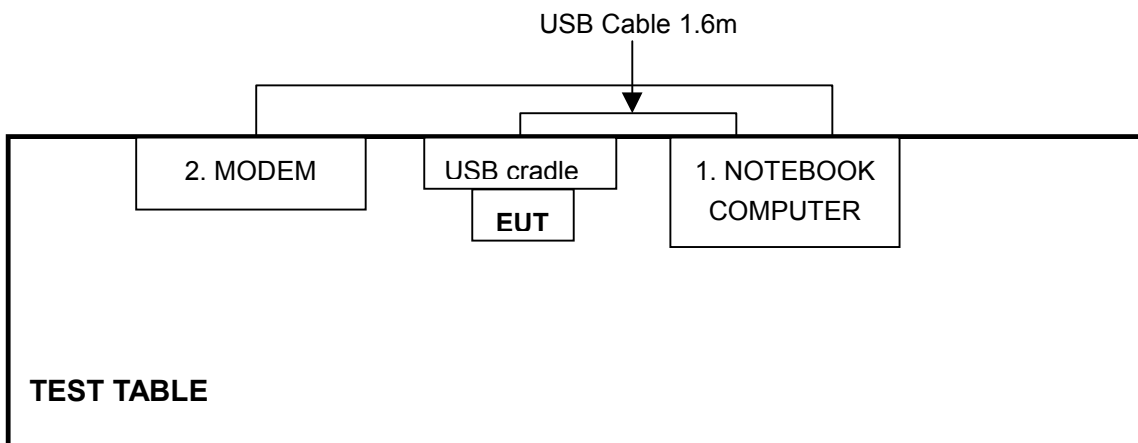

NOTE: 1. Please refer to the photos of test configuration in Item 5 also.

4 TEST TYPES AND RESULTS

4.1 CONDUCTED EMISSION MEASUREMENT

4.1.1 LIMITS OF CONDUCTED EMISSION MEASUREMENT

| FREQUENCY OF EMISSION (MHz) | CONDUCTED LIMIT (dB μ V) | |
|-----------------------------|------------------------------|----------|
| | Quasi-peak | Average |
| 0.15-0.5 | 66 to 56 | 56 to 46 |
| 0.5-5 | 56 | 46 |
| 5-30 | 60 | 50 |

NOTE:

1. The lower limit shall apply at the transition frequencies.
2. All emanations from a class B digital device or system, including any network of conductors and apparatus connected thereto, shall not exceed the level of field strengths specified above.

4.1.2 TEST INSTRUMENTS

| DESCRIPTION & MANUFACTURER | MODEL NO. | SERIAL NO. | CALIBRATED UNTIL |
|--|-----------------|-------------|------------------|
| Test Receiver | ESCS 30 | 847124/029 | Dec. 15, 2006 |
| Line-Impedance Stabilization Network(for EUT) | ENV-216 | 100071 | Nov. 10, 2006 |
| Line-Impedance Stabilization Network(for Peripheral) | KNW-407 | 8/1395/12 | Jul. 19, 2006 |
| RF Cable (JETBAO) | RG233/U | Cable_CB_01 | Dec. 09, 2006 |
| Terminator | 50 | 2 | Oct. 08, 2006 |
| Software | ADT_Cond_V7.3.2 | NA | NA |

- NOTE: 1. The calibration interval of the above test instruments is 12 months and the calibrations are traceable to NML/ROC and NIST/USA.
 2. The test was performed in ADT Shielded Room No. B.
 3. The VCCI Con B Registration No. is C-2193.

4.1.3 TEST PROCEDURES

- a. The EUT/HOST was placed 0.4 meters from the conducting wall of the shielded room with EUT/HOST being connected to the power mains through a line impedance stabilization network (LISN). Other support units were connected to the power mains through another LISN. The two LISNs provide 50 ohm/ 50uH of coupling impedance for the measuring instrument.
- b. Both lines of the power mains connected to the EUT/HOST were checked for maximum conducted interference.
- c. The frequency range from 150 kHz to 30 MHz was searched. Emission levels over 10dB under the prescribed limits could not be reported

4.1.4 TEST SETUP

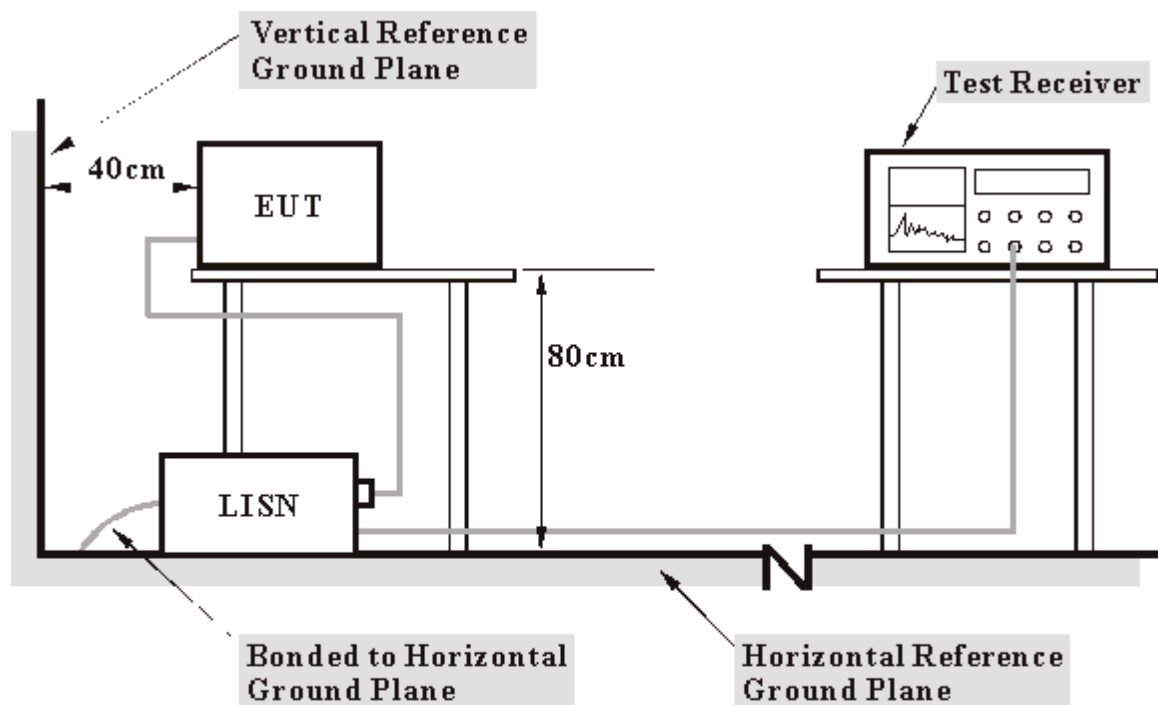

- Note:**
1. Support units were connected to second LISN.
 2. Both of LISNs (AMN) 80 cm from EUT and at the least 80 cm from other units and other metal planes support units.

For the actual test configuration, please refer to the related item – Photographs of the Test Configuration.

4.1.5 EUT OPERATING CONDITIONS

- a. Connect the EUT with the support unit 1 (Notebook computer) which placed on a testing table.
- b. The support unit 1 (Notebook computer) ran a test program “ART 53 build 13” to enable EUT under transmission condition continuously.

4.1.6 TEST RESULTS

| | | | |
|---------------------------------|-------------------------|----------------------|-----------|
| MODULATION TYPE | DSSS | CHANNEL | Channel 1 |
| INPUT POWER (SYSTEM) | 120Vac, 60 Hz | 6dB BANDWIDTH | 9 kHz |
| PHASE | Line (L) | TRANSFER RATE | 1Mbps |
| ENVIRONMENTAL CONDITIONS | 27deg. C, 59%RH, 972hPa | TESTED BY | Tony Chen |

| No | Freq. [MHz] | Corr. Factor (dB) | Reading Value | | Emission Level | | Limit | | Margin | |
|----|----------------|-------------------------|---------------|-----|----------------|-----|-----------|-------|--------|-----|
| | | | [dB (uV)] | | [dB (uV)] | | [dB (uV)] | | (dB) | |
| | | | Q.P. | AV. | Q.P. | AV. | Q.P. | AV. | Q.P. | AV. |
| 1 | 0.170 | 9.60 | 40.65 | - | 50.25 | - | 64.98 | 54.98 | -14.73 | - |
| 2 | 0.255 | 9.60 | 28.63 | - | 38.23 | - | 61.58 | 51.58 | -23.35 | - |
| 3 | 0.341 | 9.60 | 25.35 | - | 34.95 | - | 59.17 | 49.17 | -24.22 | - |
| 4 | 0.427 | 9.60 | 24.38 | - | 33.98 | - | 57.30 | 47.30 | -23.32 | - |
| 5 | 4.273 | 9.71 | 18.42 | - | 28.13 | - | 56.00 | 46.00 | -27.87 | - |
| 6 | 4.957 | 9.73 | 17.25 | - | 26.98 | - | 56.00 | 46.00 | -29.02 | - |

- REMARKS:**
1. Q.P. and AV. are abbreviations of quasi-peak and average individually.
 2. "-": The Quasi-peak reading value also meets average limit and measurement with the average detector is unnecessary.
 3. The emission levels of other frequencies were very low against the limit.
 4. Margin value = Emission level - Limit value
 5. Correction factor = Insertion loss + Cable loss
 6. Emission Level = Correction Factor + Reading Value.

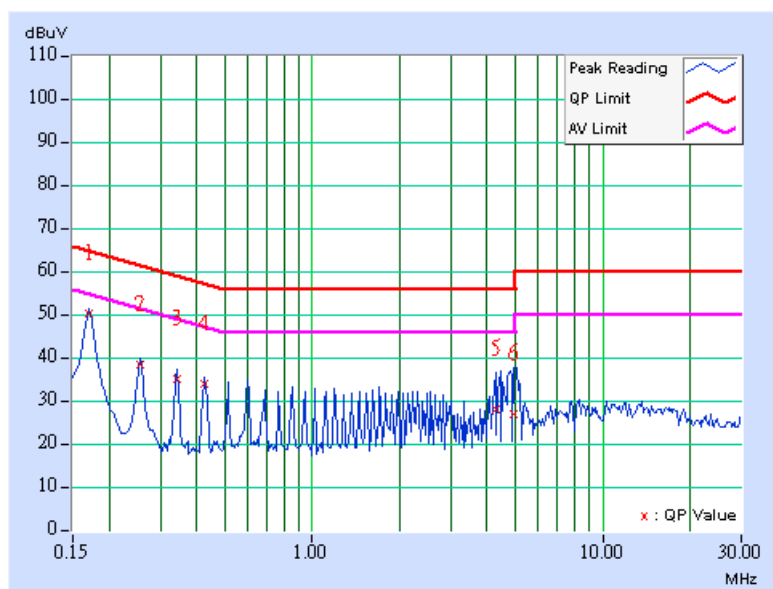

| | | | |
|---------------------------------|-------------------------|----------------------|-----------|
| MODULATION TYPE | DSSS | CHANNEL | Channel 1 |
| INPUT POWER (SYSTEM) | 120Vac, 60 Hz | 6dB BANDWIDTH | 9 kHz |
| PHASE | Neutral (N) | TRANSFER RATE | 1Mbps |
| ENVIRONMENTAL CONDITIONS | 27deg. C, 59%RH, 972hPa | TESTED BY | Tony Chen |

| No | Freq. [MHz] | Corr. Factor (dB) | Reading Value | | Emission Level | | Limit | | Margin | |
|----|----------------|-------------------------|---------------|-----|----------------|-----|-----------|-------|--------|-----|
| | | | [dB (uV)] | | [dB (uV)] | | [dB (uV)] | | (dB) | |
| | | | Q.P. | AV. | Q.P. | AV. | Q.P. | AV. | Q.P. | AV. |
| 1 | 0.170 | 9.60 | 39.90 | - | 49.50 | - | 64.98 | 54.98 | -15.48 | - |
| 2 | 0.255 | 9.60 | 28.23 | - | 37.83 | - | 61.58 | 51.58 | -23.75 | - |
| 3 | 0.341 | 9.60 | 22.13 | - | 31.73 | - | 59.17 | 49.17 | -27.44 | - |
| 4 | 0.685 | 9.60 | 21.00 | - | 30.60 | - | 56.00 | 46.00 | -25.40 | - |
| 5 | 4.625 | 9.72 | 21.71 | - | 31.43 | - | 56.00 | 46.00 | -24.57 | - |
| 6 | 4.797 | 9.73 | 20.94 | - | 30.67 | - | 56.00 | 46.00 | -25.33 | - |

- REMARKS:**
1. Q.P. and AV. are abbreviations of quasi-peak and average individually.
 2. "-": The Quasi-peak reading value also meets average limit and measurement with the average detector is unnecessary.
 3. The emission levels of other frequencies were very low against the limit.
 4. Margin value = Emission level - Limit value
 5. Correction factor = Insertion loss + Cable loss
 6. Emission Level = Correction Factor + Reading Value.

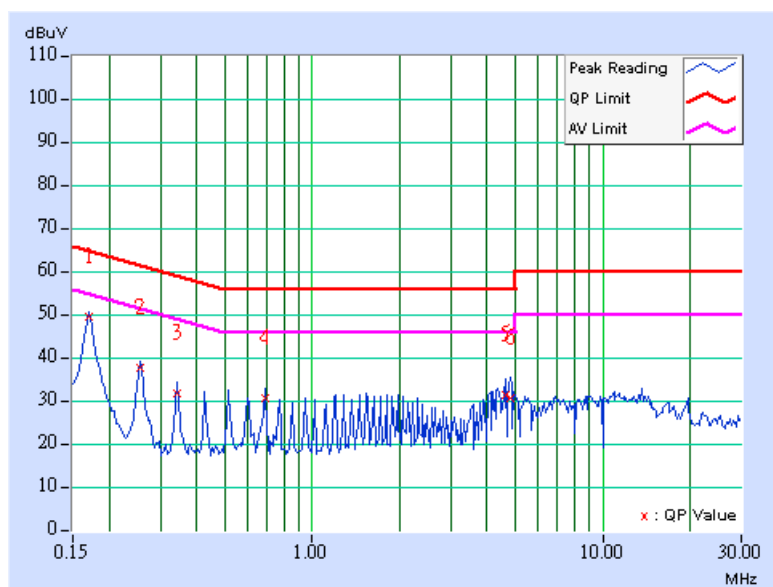

4.2 RADIATED EMISSION MEASUREMENT

4.2.1 LIMITS OF RADIATED EMISSION MEASUREMENT

Emissions radiated outside of the specified bands, shall be according to the general radiated limits in 15.209 as following:

| Frequencies (MHz) | Field strength (microvolts/meter) | Measurement distance (meters) |
|-------------------|-----------------------------------|-------------------------------|
| 0.009-0.490 | 2400/F(kHz) | 300 |
| 0.490-1.705 | 24000/F(kHz) | 30 |
| 1.705-30.0 | 30 | 30 |
| 30-88 | 100 | 3 |
| 88-216 | 150 | 3 |
| 216-960 | 200 | 3 |
| Above 960 | 500 | 3 |

NOTE:

1. The lower limit shall apply at the transition frequencies.
2. Emission level (dBuV/m) = 20 log Emission level (uV/m).
3. As shown in 15.35(b), for frequencies above 1000MHz, the field strength limits are based on average detector, however, the peak field strength of any emission shall not exceed the maximum permitted average limits, specified above by more than 20dB under any condition of modulation.

4.2.2 TEST INSTRUMENTS

| DESCRIPTION & MANUFACTURER | MODEL NO. | SERIAL NO. | CALIBRATED UNTIL |
|----------------------------------|------------------------|-------------------------|------------------|
| ADVANTEST Spectrum Analyzer | R3271A | 85060311 | July 07, 2006 |
| HP Pre_Amplifier | 8449B | 3008A01922 | Oct. 02, 2006 |
| ROHDE & SCHWARZ Test Receiver | ESCS30 | 100287 | Dec. 08, 2006 |
| CHASE Broadband Antenna | VULB9168 | 138 | Dec. 21, 2006 |
| Schwarzbeck Horn_Antenna | BBHA9120 | D124 | Dec. 11, 2006 |
| Schwarzbeck Horn_Antenna | BBHA 9170 | BBHA9170153 | Jan. 05, 2007 |
| SCHWARZBECK Biconical Antenna | VHBA9123 | 459 | Jun. 26, 2006 |
| SCHWARZBECK Periodic Antenna | UPA6108 | 1148 | Jun. 26, 2006 |
| RF Switches (ARNITSU) | CS-201 | 1565157 | NA |
| RF CABLE (Chaintek) 1GHz-20GHz | SF102 | 22054-2 | Nov. 16. 2006 |
| RF Cable(RICHTEC) | 9913-30M | STCCAB-30M- 1GHz-021 | Jul. 16, 2006 |
| Software | ADT_Radiated_V 5.14 | NA | NA |
| CHANCE MOST Antenna Tower | AT-100 | 0203 | NA |
| CHANCE MOST Turn Table | TT-100 | 0203 | NA |

Note: 1. The calibration interval of the above test instruments is 12 months (36 months for Periodic Antenna) and the calibrations are traceable to NML/ROC and NIST/USA.

2. The horn antenna and HP preamplifier (model: 8449B) are used only for the measurement of emission frequency above 1GHz if tested.
3. The test was performed in ADT Open Site No. C.
4. The FCC Site Registration No. is 656396.
5. The VCCI Site Registration No. is R-1626.
6. The CANADA Site Registration No. is IC 4824-3.
7. The following table is for the measurement uncertainty, which is calculated as per the document CISPR 16-4. This uncertainty represents an expanded uncertainty expressed at approximately the 95% confidence level using a coverage factor of k=2.

| Measurement | Value |
|-----------------------------------|---------|
| Radiated emissions (30MHz-1GHz) | 2.98 dB |
| Radiated emissions (1GHz ~18GHz) | 2.21 dB |
| Radiated emissions (18GHz ~20GHz) | 1.88 dB |

4.2.3 TEST PROCEDURES

- a. The EUT was placed on the top of a rotating table 0.8 meters above the ground at a 10 meter open area test site. The table was rotated 360 degrees to determine the position of the highest radiation.
- b. The EUT was set 3 meters away from the interference-receiving antenna, which was mounted on the top of a variable-height antenna tower.
- c. The antenna is a broadband antenna, and its height is varied from one meter to four meters above the ground to determine the maximum value of the field strength. Both horizontal and vertical polarizations of the antenna are set to make the measurement.
- d. For each suspected emission, the EUT was arranged to its worst case and then the antenna was tuned to heights from 1 meter to 4 meters and the rotatable table was turned from 0 degrees to 360 degrees to find the maximum reading.
- e. The test-receiver system was set to Peak Detect Function and Specified Bandwidth with Maximum Hold Mode.
- f. If the emission level of the EUT in peak mode was 10 dB lower than the limit specified, then testing could be stopped and the peak values of the EUT would be reported. Otherwise the emissions that did not have 10 dB margin would be re-tested one by one using peak, quasi-peak or average method as specified and then reported in a data sheet.

NOTE:

1. The resolution bandwidth and video bandwidth of test receiver/spectrum analyzer is 120kHz for Peak detection (PK) and Quasi-peak detection (QP) at frequency below 1GHz.
2. The resolution bandwidth and video bandwidth of test receiver/spectrum analyzer is 1 MHz for Peak detection at frequency above 1GHz.
3. The resolution bandwidth of test receiver/spectrum analyzer is 1 MHz and the video bandwidth is 10 Hz for Average detection (AV) at frequency above 1GHz.

4.2.4 TEST SETUP

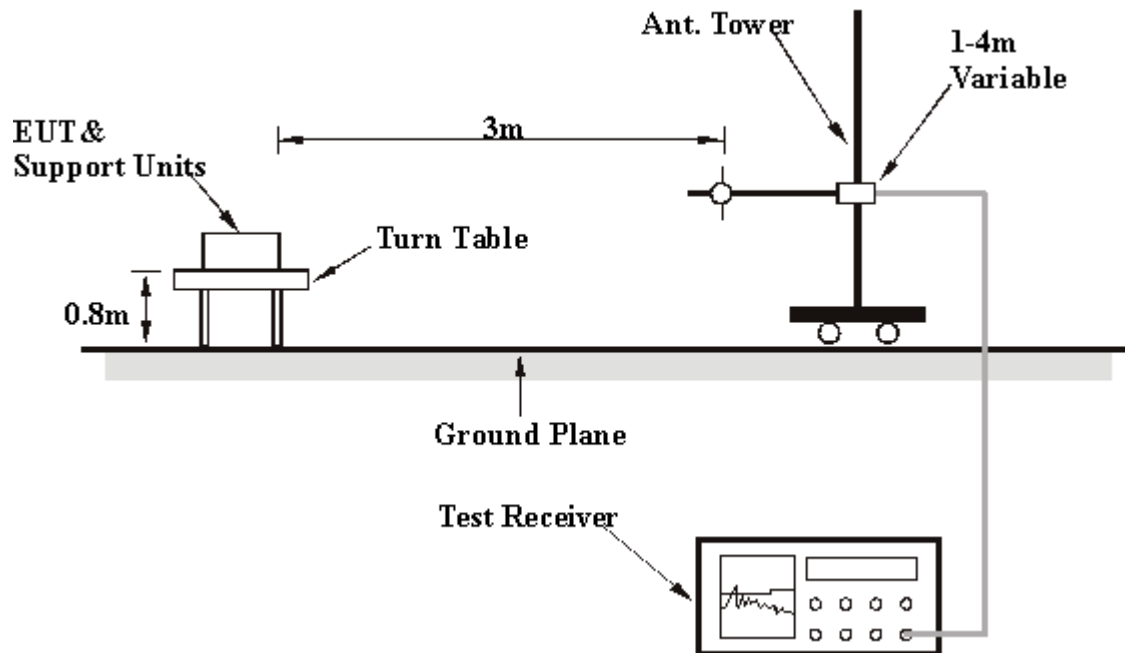

For the actual test configuration, please refer to the related item – Photographs of the Test Configuration.

4.2.5 EUT OPERATING CONDITIONS

Same as 4.1.5



4.2.6 TEST RESULTS

Below 1GHz Worst-Case Data

| | | | |
|---------------------------------|-------------------------|--------------------------|--------------------|
| TEST MODE | With USB cradle | | |
| MODULATION TYPE | DSSS | CHANNEL | Channel 1 |
| INPUT POWER (SYSTEM) | 120Vac, 60 Hz | FREQUENCY RANGE | 30-1000 MHz |
| ENVIRONMENTAL CONDITIONS | 27deg. C, 59%RH, 972hPa | TRANSFER RATE | 1Mbps |
| TESTED BY | Tony Chen | DETECTOR FUNCTION | Quasi-Peak, 120kHz |

| ANTENNA POLARITY & TEST DISTANCE: HORIZONTAL AT 3 M | | | | | | | | |
|---|-------------|-------------------------|----------------|-------------|--------------------|----------------------|------------------|--------------------------|
| No. | Freq. (MHz) | Emission Level (dBuV/m) | Limit (dBuV/m) | Margin (dB) | Antenna Height (m) | Table Angle (Degree) | Raw Value (dBuV) | Correction Factor (dB/m) |
| 1 | 158.05 | 20.60 QP | 43.50 | -22.90 | 1.25 H | 21 | 6.90 | 13.70 |
| 2 | 431.59 | 31.60 QP | 46.00 | -14.40 | 1.62 H | 111 | 12.40 | 19.20 |
| 3 | 479.97 | 31.30 QP | 46.00 | -14.70 | 1.55 H | 344 | 10.90 | 20.40 |
| 4 | 663.26 | 33.40 QP | 46.00 | -12.60 | 1.41 H | 288 | 9.10 | 24.20 |
| 5 | 878.32 | 34.90 QP | 46.00 | -11.10 | 1.51 H | 356 | 7.20 | 27.70 |
| 6 | 960.00 | 33.60 QP | 46.00 | -12.40 | 1.24 H | 203 | 4.70 | 28.90 |

| ANTENNA POLARITY & TEST DISTANCE: VERTICAL AT 3 M | | | | | | | | |
|---|-------------|-------------------------|----------------|-------------|--------------------|----------------------|------------------|--------------------------|
| No. | Freq. (MHz) | Emission Level (dBuV/m) | Limit (dBuV/m) | Margin (dB) | Antenna Height (m) | Table Angle (Degree) | Raw Value (dBuV) | Correction Factor (dB/m) |
| 1 | 38.11 | 29.10 QP | 40.00 | -10.90 | 1.19 V | 82 | 15.70 | 13.40 |
| 2 | 158.02 | 29.30 QP | 43.50 | -14.20 | 1.00 V | 231 | 15.60 | 13.70 |
| 3 | 431.68 | 33.60 QP | 46.00 | -12.40 | 1.18 V | 324 | 14.40 | 19.20 |
| 4 | 480.06 | 39.10 QP | 46.00 | -6.90 | 1.08 V | 148 | 18.70 | 20.40 |
| 5 | 665.44 | 35.10 QP | 46.00 | -10.90 | 1.49 V | 111 | 10.80 | 24.30 |
| 6 | 960.00 | 35.80 QP | 46.00 | -10.20 | 1.26 V | 113 | 7.00 | 28.90 |

- REMARKS:**
1. Emission level(dBuV/m)=Raw Value(dBuV) + Correction Factor(dB/m)
 2. Correction Factor(dB/m) = Antenna Factor (dB/m) + Cable Factor (dB)
 3. The other emission levels were very low against the limit.
 4. Margin value = Emission level – Limit value.

| | | | |
|---------------------------------|-------------------------|--------------------------|--------------------|
| TEST MODE | Without USB cradle | | |
| MODULATION TYPE | DSSS | CHANNEL | Channel 1 |
| INPUT POWER (SYSTEM) | 120Vac, 60 Hz | FREQUENCY RANGE | 30-1000 MHz |
| ENVIRONMENTAL CONDITIONS | 27deg. C, 59%RH, 972hPa | TRANSFER RATE | 1Mbps |
| TESTED BY | Tony Chen | DETECTOR FUNCTION | Quasi-Peak, 120kHz |

ANTENNA POLARITY & TEST DISTANCE: HORIZONTAL AT 3 M

| No. | Freq. (MHz) | Emission Level (dBuV/m) | Limit (dBuV/m) | Margin (dB) | Antenna Height (m) | Table Angle (Degree) | Raw Value (dBuV) | Correction Factor (dB/m) |
|-----|-------------|-------------------------|----------------|-------------|--------------------|----------------------|------------------|--------------------------|
| 1 | 158.54 | 24.90 QP | 43.50 | -18.60 | 1.63 H | 171 | 11.20 | 13.70 |
| 2 | 432.54 | 35.20 QP | 46.00 | -10.80 | 1.79 H | 329 | 15.90 | 19.20 |
| 3 | 480.05 | 37.60 QP | 46.00 | -8.40 | 1.40 H | 330 | 17.20 | 20.40 |
| 4 | 663.28 | 34.80 QP | 46.00 | -11.20 | 1.51 H | 4 | 10.60 | 24.20 |
| 5 | 878.77 | 34.40 QP | 46.00 | -11.60 | 1.51 H | 49 | 6.70 | 27.70 |
| 6 | 960.00 | 35.70 QP | 46.00 | -10.30 | 1.32 H | 314 | 6.90 | 28.90 |

ANTENNA POLARITY & TEST DISTANCE: VERTICAL AT 3 M

| No. | Freq. (MHz) | Emission Level (dBuV/m) | Limit (dBuV/m) | Margin (dB) | Antenna Height (m) | Table Angle (Degree) | Raw Value (dBuV) | Correction Factor (dB/m) |
|-----|-------------|-------------------------|----------------|-------------|--------------------|----------------------|------------------|--------------------------|
| 1 | 39.84 | 31.20 QP | 40.00 | -8.80 | 1.15 V | 109 | 17.20 | 14.00 |
| 2 | 158.03 | 28.60 QP | 43.50 | -14.90 | 1.23 V | 267 | 14.90 | 13.70 |
| 3 | 431.69 | 36.20 QP | 46.00 | -9.80 | 1.27 V | 320 | 16.90 | 19.20 |
| 4 | 480.07 | 37.70 QP | 46.00 | -8.30 | 1.09 V | 96 | 17.20 | 20.40 |
| 5 | 664.88 | 38.10 QP | 46.00 | -7.90 | 1.23 V | 10 | 13.80 | 24.30 |
| 6 | 842.09 | 38.10 QP | 46.00 | -7.90 | 1.38 V | 273 | 10.80 | 27.30 |

- REMARKS:**
1. Emission level(dBuV/m)=Raw Value(dBuV) + Correction Factor(dB/m)
 2. Correction Factor(dB/m) = Antenna Factor (dB/m) + Cable Factor (dB)
 3. The other emission levels were very low against the limit.
 4. Margin value = Emission level – Limit value.



4.2.7 TEST RESULTS - DSSS
802.11b DSSS modulation

| | | | |
|---------------------------------|-----------------------------|--|------------------------------------|
| MODE | Channel 1 | FREQUENCY RANGE | 1000~25000MHz |
| INPUT POWER (SYSTEM) | 120Vac, 60 Hz | DETECTOR FUNCTION & BANDWIDTH | Peak (PK) Average (AV) 1 MHz |
| ENVIRONMENTAL CONDITIONS | 22 deg. C, 72%RH, 972hPa | TESTED BY | Tony Chen |

| ANTENNA POLARITY & TEST DISTANCE: HORIZONTAL AT 3 M | | | | | | | | |
|---|-------------|-------------------------|----------------|-------------|--------------------|----------------------|------------------|--------------------------|
| No. | Freq. (MHz) | Emission Level (dBuV/m) | Limit (dBuV/m) | Margin (dB) | Antenna Height (m) | Table Angle (Degree) | Raw Value (dBuV) | Correction Factor (dB/m) |
| 1 | 2390.00 | 60.40 PK | 74.00 | -13.60 | 1.48 H | 176 | 30.70 | 29.70 |
| 1 | 2390.00 | 51.80 AV | 54.00 | -2.20 | 1.48 H | 176 | 22.10 | 29.70 |
| 2 | *2412.00 | 107.80 PK | | | 1.48 H | 176 | 78.00 | 29.80 |
| 2 | *2412.00 | 104.30 AV | | | 1.48 H | 176 | 74.50 | 29.80 |
| 3 | 4824.00 | 54.30 PK | 74.00 | -19.70 | 1.23 H | 20 | 19.20 | 35.10 |
| 3 | 4824.00 | 51.60 AV | 54.00 | -2.40 | 1.23 H | 20 | 16.50 | 35.10 |
| 4 | 7236.00 | 51.30 PK | 74.00 | -22.70 | 1.19 H | 176 | 10.80 | 40.50 |
| 4 | 7236.00 | 40.50 AV | 54.00 | -13.50 | 1.19 H | 176 | 0.00 | 40.50 |

| ANTENNA POLARITY & TEST DISTANCE: VERTICAL AT 3 M | | | | | | | | |
|---|-------------|-------------------------|----------------|-------------|--------------------|----------------------|------------------|--------------------------|
| No. | Freq. (MHz) | Emission Level (dBuV/m) | Limit (dBuV/m) | Margin (dB) | Antenna Height (m) | Table Angle (Degree) | Raw Value (dBuV) | Correction Factor (dB/m) |
| 1 | 2390.00 | 56.00 PK | 74.00 | -18.00 | 1.23 V | 236 | 26.30 | 29.70 |
| 1 | 2390.00 | 44.00 AV | 54.00 | -10.00 | 1.23 V | 236 | 14.30 | 29.70 |
| 2 | *2412.00 | 102.00 PK | | | 1.23 V | 236 | 72.20 | 29.80 |
| 2 | *2412.00 | 98.10 AV | | | 1.23 V | 236 | 68.30 | 29.80 |
| 3 | 4824.00 | 53.20 PK | 74.00 | -20.80 | 1.40 V | 244 | 18.10 | 35.10 |
| 3 | 4824.00 | 50.00 AV | 54.00 | -4.00 | 1.40 V | 244 | 14.90 | 35.10 |
| 4 | 7236.00 | 53.40 PK | 74.00 | -20.60 | 1.11 V | 84 | 12.90 | 40.50 |
| 4 | 7236.00 | 43.60 AV | 54.00 | -10.40 | 1.11 V | 84 | 3.10 | 40.50 |

- REMARKS:**
1. Emission level(dBuV/m)=Raw Value(dBuV) + Correction Factor(dB/m)
 2. Correction Factor(dB/m) = Antenna Factor (dB/m) + Cable Factor (dB)
 3. The other emission levels were very low against the limit.
 4. Margin value = Emission level – Limit value.
 5. The limit value is defined as per 15.247
 6. “ * “ : Fundamental frequency



| | | | |
|---------------------------------|-----------------------------|--|------------------------------------|
| MODE | Channel 6 | FREQUENCY RANGE | 1000~25000MHz |
| INPUT POWER (SYSTEM) | 120Vac, 60 Hz | DETECTOR FUNCTION & BANDWIDTH | Peak (PK) Average (AV) 1 MHz |
| ENVIRONMENTAL CONDITIONS | 22 deg. C, 72%RH, 972hPa | TESTED BY | Tony Chen |

ANTENNA POLARITY & TEST DISTANCE: HORIZONTAL AT 3 M

| No. | Freq. (MHz) | Emission Level (dBuV/m) | Limit (dBuV/m) | Margin (dB) | Antenna Height (m) | Table Angle (Degree) | Raw Value (dBuV) | Correction Factor (dB/m) |
|-----|-------------|-------------------------|----------------|-------------|--------------------|----------------------|------------------|--------------------------|
| 1 | *2437.00 | 107.30 PK | | | 1.18 H | 52 | 77.40 | 29.90 |
| 1 | *2437.00 | 103.60 AV | | | 1.18 H | 52 | 73.70 | 29.90 |
| 2 | 4874.00 | 56.50 PK | 74.00 | -17.50 | 1.03 H | 137 | 21.20 | 35.30 |
| 2 | 4874.00 | 53.70 AV | 54.00 | -0.30 | 1.03 H | 137 | 18.40 | 35.30 |
| 3 | 7311.00 | 51.70 PK | 74.00 | -22.30 | 1.43 H | 116 | 11.00 | 40.70 |
| 3 | 7311.00 | 42.50 AV | 54.00 | -11.50 | 1.43 H | 116 | 1.80 | 40.70 |

ANTENNA POLARITY & TEST DISTANCE: VERTICAL AT 3 M

| No. | Freq. (MHz) | Emission Level (dBuV/m) | Limit (dBuV/m) | Margin (dB) | Antenna Height (m) | Table Angle (Degree) | Raw Value (dBuV) | Correction Factor (dB/m) |
|-----|-------------|-------------------------|----------------|-------------|--------------------|----------------------|------------------|--------------------------|
| 1 | *2437.00 | 104.40 PK | | | 1.22 V | 290 | 74.50 | 29.90 |
| 1 | *2437.00 | 100.30 AV | | | 1.22 V | 290 | 70.40 | 29.90 |
| 2 | 4874.00 | 55.00 PK | 74.00 | -19.00 | 1.01 V | 83 | 19.70 | 35.30 |
| 2 | 4874.00 | 51.70 AV | 54.00 | -2.30 | 1.01 V | 83 | 16.40 | 35.30 |
| 3 | 7311.00 | 52.60 PK | 74.00 | -21.40 | 1.10 V | 58 | 11.90 | 40.70 |
| 3 | 7311.00 | 42.90 AV | 54.00 | -11.10 | 1.10 V | 58 | 2.20 | 40.70 |

- REMARKS:**
1. Emission level(dBuV/m)=Raw Value(dBuV) + Correction Factor(dB/m)
 2. Correction Factor(dB/m) = Antenna Factor (dB/m) + Cable Factor (dB)
 3. The other emission levels were very low against the limit.
 4. Margin value = Emission level – Limit value.
 5. The limit value is defined as per 15.247
 6. “ * “ : Fundamental frequency



| | | | |
|---------------------------------|-----------------------------|--|------------------------------------|
| MODE | Channel 11 | FREQUENCY RANGE | 1000~25000MHz |
| INPUT POWER (SYSTEM) | 120Vac, 60 Hz | DETECTOR FUNCTION & BANDWIDTH | Peak (PK) Average (AV) 1 MHz |
| ENVIRONMENTAL CONDITIONS | 27 deg. C, 72%RH, 972hPa | TESTED BY | Tony Chen |

ANTENNA POLARITY & TEST DISTANCE: HORIZONTAL AT 3 M

| No. | Freq. (MHz) | Emission Level (dBuV/m) | Limit (dBuV/m) | Margin (dB) | Antenna Height (m) | Table Angle (Degree) | Raw Value (dBuV) | Correction Factor (dB/m) |
|----------|----------------|-------------------------|----------------|--------------|--------------------|----------------------|------------------|--------------------------|
| 1 | *2462.00 | 106.50 PK | | | 1.34 H | 170 | 76.50 | 30.00 |
| 1 | *2462.00 | 102.70 AV | | | 1.34 H | 170 | 72.70 | 30.00 |
| 2 | 2483.50 | 60.70 PK | 74.00 | -13.30 | 1.34 H | 170 | 30.60 | 30.10 |
| 2 | 2483.50 | 52.40 AV | 54.00 | -1.60 | 1.34 H | 170 | 22.30 | 30.10 |
| 3 | 4924.00 | 56.60 PK | 74.00 | -17.40 | 1.03 H | 139 | 21.10 | 35.50 |
| 3 | 4924.00 | 53.90 AV | 54.00 | -0.10 | 1.03 H | 139 | 18.30 | 35.50 |
| 4 | 7386.00 | 51.60 PK | 74.00 | -22.40 | 1.31 H | 110 | 10.80 | 40.80 |
| 4 | 7386.00 | 40.50 AV | 54.00 | -13.50 | 1.31 H | 110 | -0.40 | 40.80 |

ANTENNA POLARITY & TEST DISTANCE: VERTICAL AT 3 M

| No. | Freq. (MHz) | Emission Level (dBuV/m) | Limit (dBuV/m) | Margin (dB) | Antenna Height (m) | Table Angle (Degree) | Raw Value (dBuV) | Correction Factor (dB/m) |
|-----|-------------|-------------------------|----------------|-------------|--------------------|----------------------|------------------|--------------------------|
| 1 | *2462.00 | 101.20 PK | | | 1.15 V | 299 | 71.20 | 30.00 |
| 1 | *2462.00 | 97.20 AV | | | 1.15 V | 299 | 67.20 | 30.00 |
| 2 | 2483.50 | 55.90 PK | 74.00 | -18.10 | 1.15 V | 299 | 25.80 | 30.10 |
| 2 | 2483.50 | 45.50 AV | 54.00 | -8.50 | 1.15 V | 299 | 15.40 | 30.10 |
| 3 | 4924.00 | 53.00 PK | 74.00 | -21.00 | 1.52 V | 257 | 17.40 | 35.50 |
| 3 | 4924.00 | 50.20 AV | 54.00 | -3.80 | 1.52 V | 257 | 14.70 | 35.50 |
| 4 | 7386.00 | 51.30 PK | 74.00 | -22.70 | 1.88 V | 352 | 10.40 | 40.80 |
| 4 | 7386.00 | 40.80 AV | 54.00 | -13.20 | 1.88 V | 352 | -0.10 | 40.80 |

- REMARKS:**
1. Emission level(dBuV/m)=Raw Value(dBuV) + Correction Factor(dB/m)
 2. Correction Factor(dB/m) = Antenna Factor (dB/m) + Cable Factor (dB)
 3. The other emission levels were very low against the limit.
 4. Margin value = Emission level – Limit value.
 5. The limit value is defined as per 15.247
 6. “ * “ : Fundamental frequency

RESTRICTED BANDEDGE (802.11b MODE,CH1, HORIZONTAL)

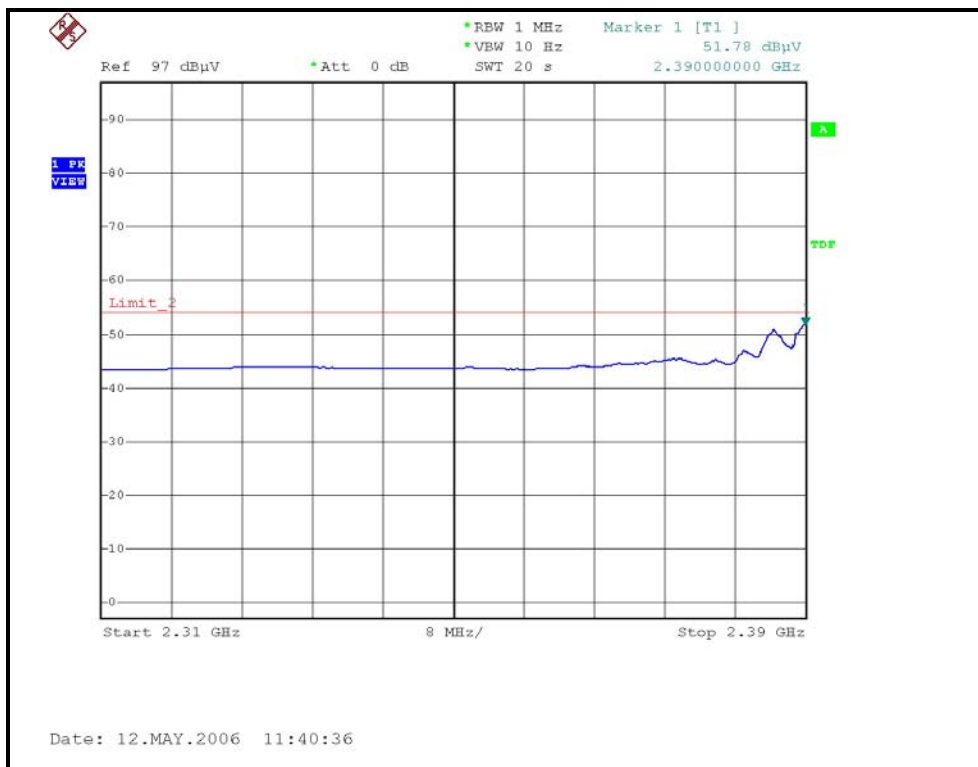
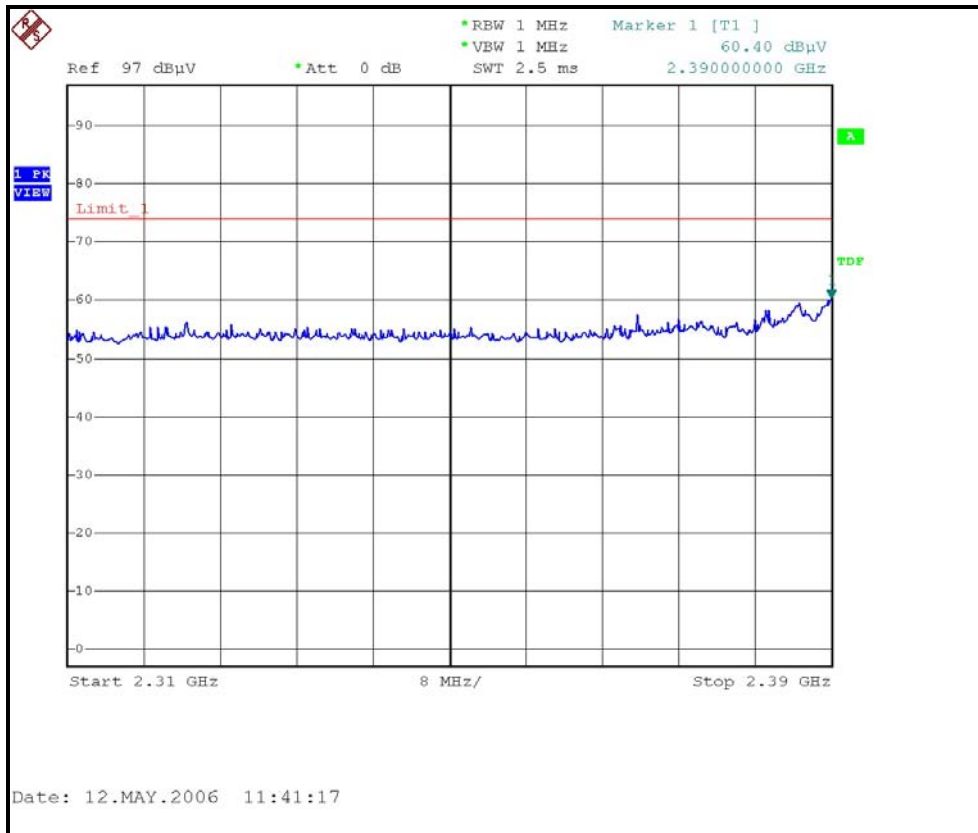

RESTRICTED BANDEDGE (802.11b MODE, CH1, VERTICAL)

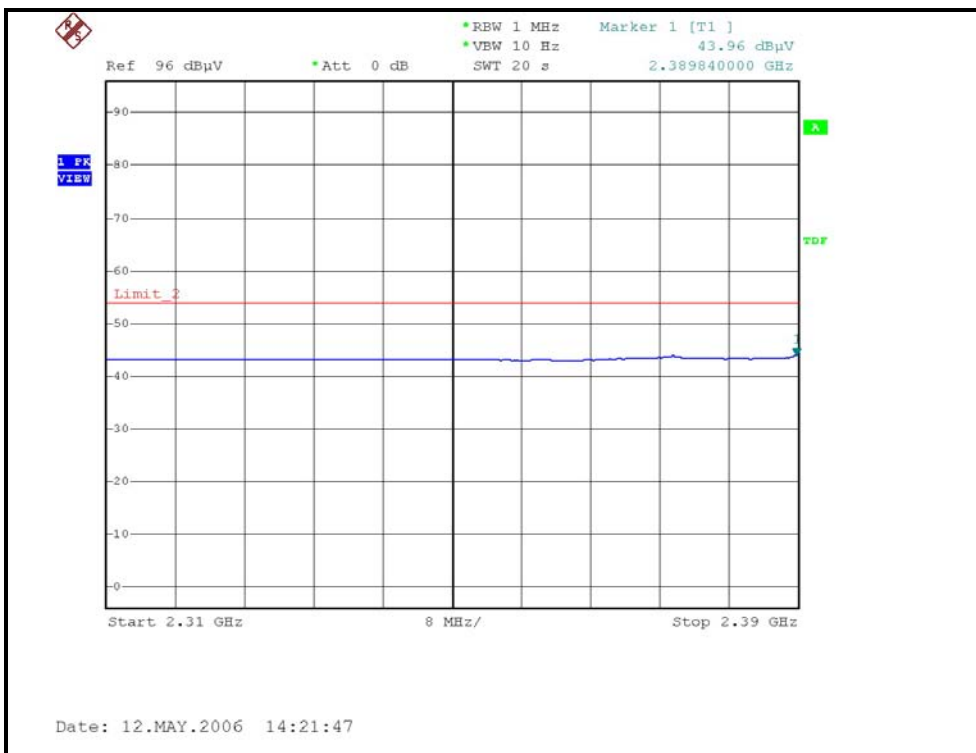
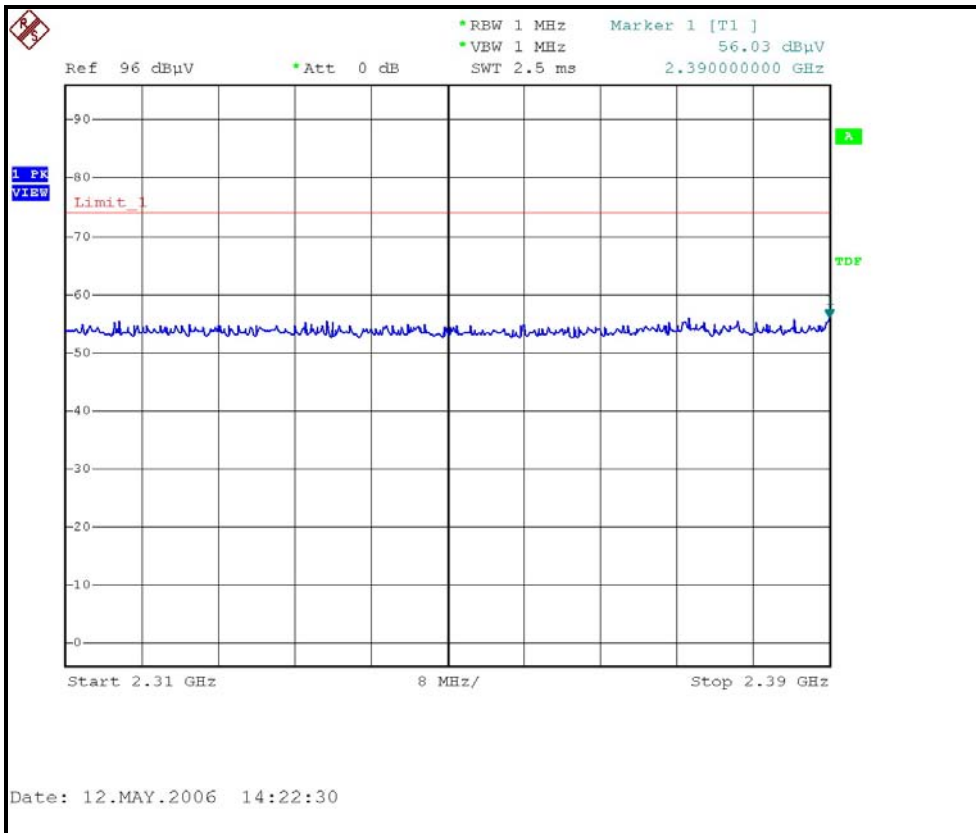

RESTRICTED BANDEDGE (802.11b MODE,CH11, HORIZONTAL)

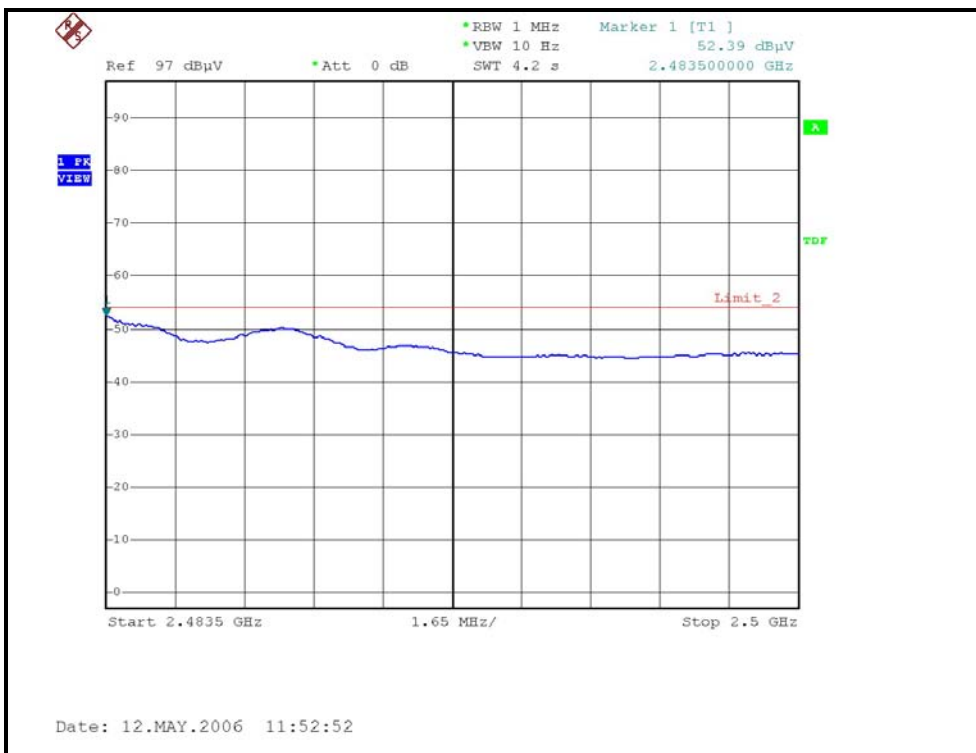
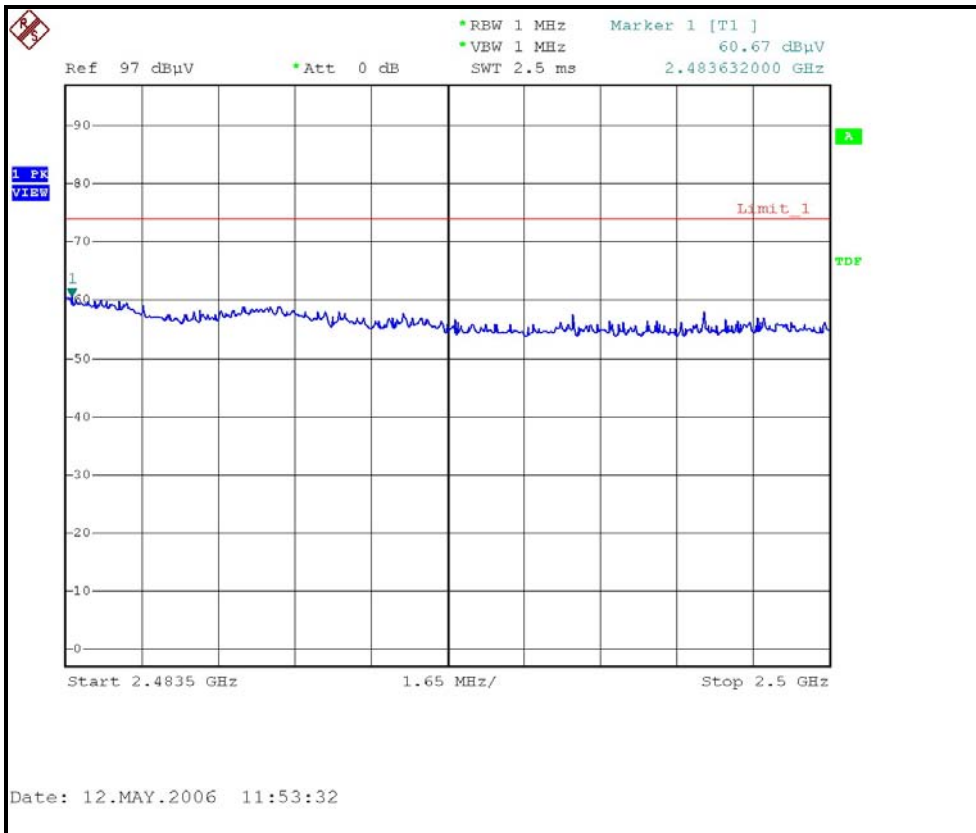

RESTRICTED BANDEDGE (802.11b MODE, CH11, VERTICAL)

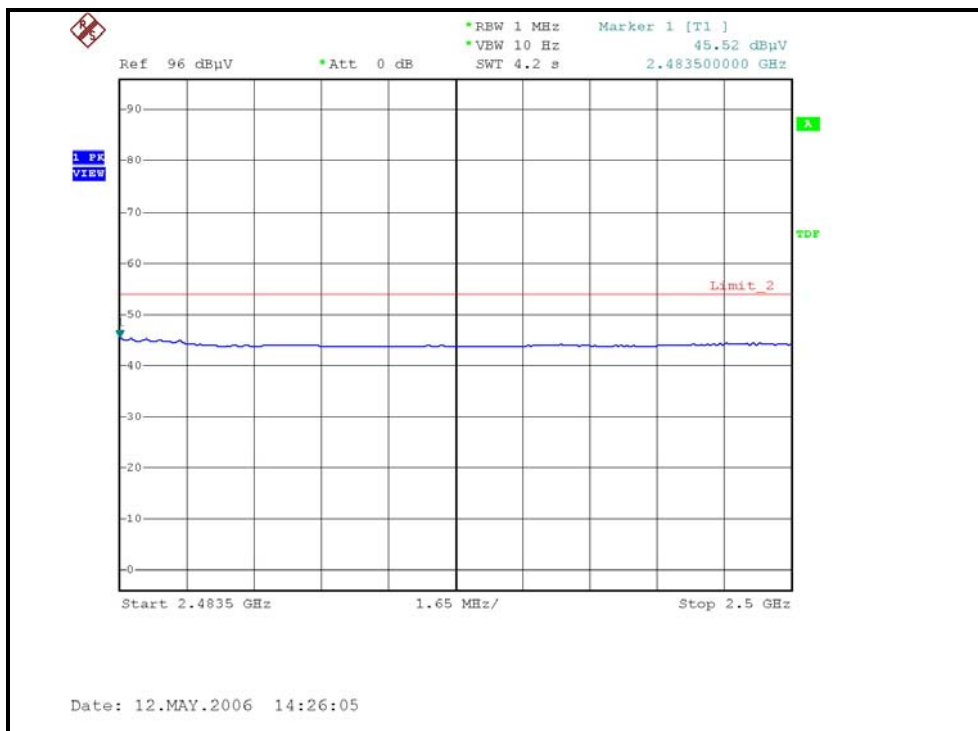
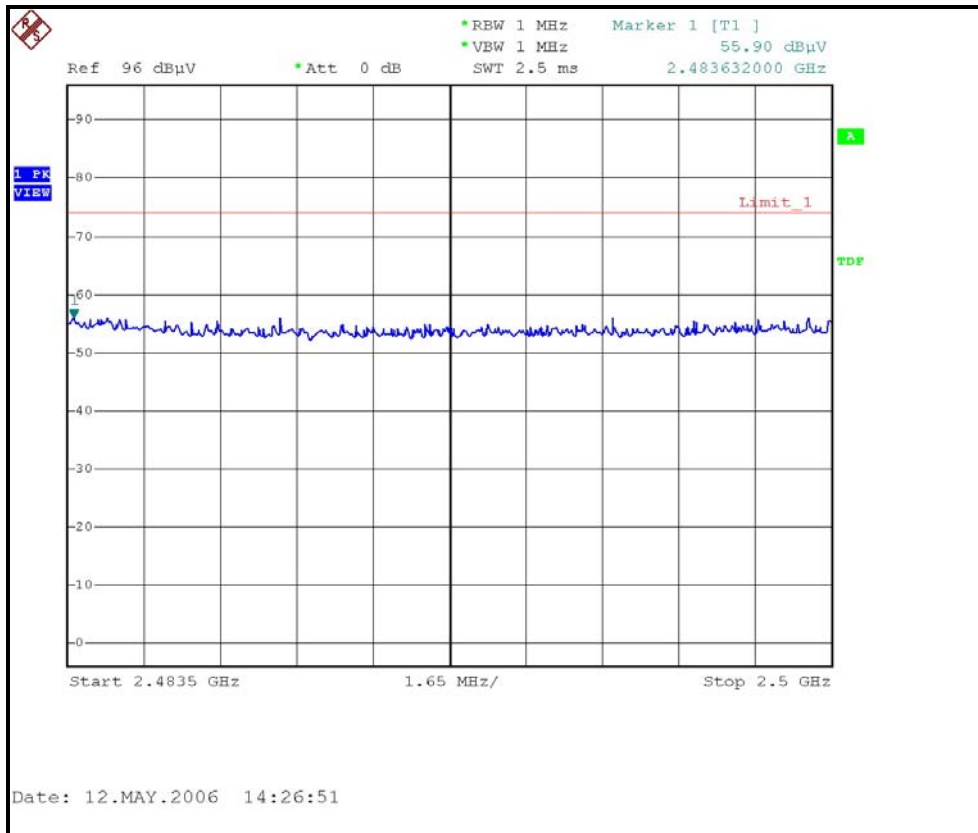



4.2.8 TEST RESULTS - OFDM
802.11g Normal OFDM modulation

| | | | |
|---------------------------------|-----------------------------|--|------------------------------------|
| MODE | Channel 1 | FREQUENCY RANGE | 1000~25000MHz |
| INPUT POWER (SYSTEM) | 120Vac, 60 Hz | DETECTOR FUNCTION & BANDWIDTH | Peak (PK) Average (AV) 1 MHz |
| ENVIRONMENTAL CONDITIONS | 22 deg. C, 72%RH, 972hPa | TESTED BY | Tony Chen |

| ANTENNA POLARITY & TEST DISTANCE: HORIZONTAL AT 3 M | | | | | | | | |
|---|-------------|-------------------------|----------------|-------------|--------------------|----------------------|------------------|--------------------------|
| No. | Freq. (MHz) | Emission Level (dBuV/m) | Limit (dBuV/m) | Margin (dB) | Antenna Height (m) | Table Angle (Degree) | Raw Value (dBuV) | Correction Factor (dB/m) |
| 1 | 2390.00 | 65.50 PK | 74.00 | -8.50 | 1.26 H | 331 | 35.80 | 29.70 |
| 1 | 2390.00 | 47.50 AV | 54.00 | -6.50 | 1.26 H | 331 | 17.80 | 29.70 |
| 2 | *2412.00 | 105.40 PK | | | 1.26 H | 331 | 75.60 | 29.80 |
| 2 | *2412.00 | 93.00 AV | | | 1.26 H | 331 | 63.20 | 29.80 |
| 3 | 4824.00 | 48.10 PK | 74.00 | -25.90 | 1.13 H | 22 | 13.00 | 35.10 |
| 3 | 4824.00 | 35.10 AV | 54.00 | -18.90 | 1.13 H | 22 | 0.00 | 35.10 |
| 4 | 7236.00 | 50.50 PK | 74.00 | -23.50 | 1.46 H | 111 | 10.00 | 40.50 |
| 4 | 7236.00 | 37.70 AV | 54.00 | -16.30 | 1.46 H | 111 | -2.80 | 40.50 |

| ANTENNA POLARITY & TEST DISTANCE: VERTICAL AT 3 M | | | | | | | | |
|---|-------------|-------------------------|----------------|-------------|--------------------|----------------------|------------------|--------------------------|
| No. | Freq. (MHz) | Emission Level (dBuV/m) | Limit (dBuV/m) | Margin (dB) | Antenna Height (m) | Table Angle (Degree) | Raw Value (dBuV) | Correction Factor (dB/m) |
| 1 | 2390.00 | 60.30 PK | 74.00 | -13.70 | 1.20 V | 234 | 30.60 | 29.70 |
| 1 | 2390.00 | 45.50 AV | 54.00 | -8.50 | 1.20 V | 234 | 15.80 | 29.70 |
| 2 | *2412.00 | 99.80 PK | | | 1.20 V | 234 | 70.00 | 29.80 |
| 2 | *2412.00 | 90.00 AV | | | 1.20 V | 234 | 60.20 | 29.80 |
| 3 | 4824.00 | 48.90 PK | 74.00 | -25.10 | 1.52 V | 257 | 13.80 | 35.10 |
| 3 | 4824.00 | 35.40 AV | 54.00 | -18.60 | 1.52 V | 257 | 0.30 | 35.10 |
| 4 | 7236.00 | 50.60 PK | 74.00 | -23.40 | 1.31 V | 37 | 10.10 | 40.50 |
| 4 | 7236.00 | 37.20 AV | 54.00 | -16.80 | 1.31 V | 37 | -3.30 | 40.50 |

- REMARKS:**
1. Emission level(dBuV/m)=Raw Value(dBuV) + Correction Factor(dB/m)
 2. Correction Factor(dB/m) = Antenna Factor (dB/m) + Cable Factor (dB)
 3. The other emission levels were very low against the limit.
 4. Margin value = Emission level – Limit value.
 5. The limit value is defined as per 15.247
 6. " * " : Fundamental frequency



| | | | |
|---------------------------------|-----------------------------|--|------------------------------------|
| MODE | Channel 6 | FREQUENCY RANGE | 1000~25000MHz |
| INPUT POWER (SYSTEM) | 120Vac, 60 Hz | DETECTOR FUNCTION & BANDWIDTH | Peak (PK) Average (AV) 1 MHz |
| ENVIRONMENTAL CONDITIONS | 22 deg. C, 72%RH, 972hPa | TESTED BY | Tony Chen |

ANTENNA POLARITY & TEST DISTANCE: HORIZONTAL AT 3 M

| No. | Freq. (MHz) | Emission Level (dBuV/m) | Limit (dBuV/m) | Margin (dB) | Antenna Height (m) | Table Angle (Degree) | Raw Value (dBuV) | Correction Factor (dB/m) |
|-----|-------------|-------------------------|----------------|-------------|--------------------|----------------------|------------------|--------------------------|
| 1 | *2437.00 | 103.40 PK | | | 1.23 H | 52 | 73.50 | 29.90 |
| 1 | *2437.00 | 94.10 AV | | | 1.23 H | 52 | 64.20 | 29.90 |
| 2 | 4874.00 | 48.90 PK | 74.00 | -25.10 | 1.33 H | 129 | 13.60 | 35.30 |
| 2 | 4874.00 | 36.30 AV | 54.00 | -17.70 | 1.33 H | 129 | 1.00 | 35.30 |
| 3 | 7311.00 | 49.50 PK | 74.00 | -24.50 | 1.50 H | 43 | 8.80 | 40.70 |
| 3 | 7311.00 | 36.90 AV | 54.00 | -17.10 | 1.50 H | 43 | -3.70 | 40.70 |

ANTENNA POLARITY & TEST DISTANCE: VERTICAL AT 3 M

| No. | Freq. (MHz) | Emission Level (dBuV/m) | Limit (dBuV/m) | Margin (dB) | Antenna Height (m) | Table Angle (Degree) | Raw Value (dBuV) | Correction Factor (dB/m) |
|-----|-------------|-------------------------|----------------|-------------|--------------------|----------------------|------------------|--------------------------|
| 1 | *2437.00 | 100.00 PK | | | 1.01 V | 294 | 70.10 | 29.90 |
| 1 | *2437.00 | 90.10 AV | | | 1.01 V | 294 | 60.20 | 29.90 |
| 2 | 4874.00 | 47.90 PK | 74.00 | -26.10 | 1.22 V | 31 | 12.60 | 35.30 |
| 2 | 4874.00 | 34.70 AV | 54.00 | -19.30 | 1.22 V | 31 | -0.70 | 35.30 |
| 3 | 7311.00 | 49.20 PK | 74.00 | -24.80 | 1.30 V | 33 | 8.50 | 40.70 |
| 3 | 7311.00 | 36.50 AV | 54.00 | -17.50 | 1.30 V | 33 | -4.20 | 40.70 |

- REMARKS:**
1. Emission level(dBuV/m)=Raw Value(dBuV) + Correction Factor(dB/m)
 2. Correction Factor(dB/m) = Antenna Factor (dB/m) + Cable Factor (dB)
 3. The other emission levels were very low against the limit.
 4. Margin value = Emission level – Limit value.
 5. The limit value is defined as per 15.247
 6. “ * “ : Fundamental frequency



| | | | |
|---------------------------------|-----------------------------|--|------------------------------------|
| MODE | Channel 11 | FREQUENCY RANGE | 1000~25000MHz |
| INPUT POWER (SYSTEM) | 120Vac, 60 Hz | DETECTOR FUNCTION & BANDWIDTH | Peak (PK) Average (AV) 1 MHz |
| ENVIRONMENTAL CONDITIONS | 22 deg. C, 72%RH, 972hPa | TESTED BY | Tony Chen |

ANTENNA POLARITY & TEST DISTANCE: HORIZONTAL AT 3 M

| No. | Freq. (MHz) | Emission Level (dBuV/m) | Limit (dBuV/m) | Margin (dB) | Antenna Height (m) | Table Angle (Degree) | Raw Value (dBuV) | Correction Factor (dB/m) |
|-----|-------------|-------------------------|----------------|-------------|--------------------|----------------------|------------------|--------------------------|
| 1 | *2462.00 | 103.40 PK | | | 1.26 H | 331 | 73.40 | 30.00 |
| 1 | *2462.00 | 93.60 AV | | | 1.26 H | 331 | 63.60 | 30.00 |
| 2 | 2483.50 | 60.30 PK | 74.00 | -13.70 | 1.26 H | 331 | 30.20 | 30.10 |
| 2 | 2483.50 | 50.80 AV | 54.00 | -3.20 | 1.26 H | 331 | 20.70 | 30.10 |
| 3 | 4924.00 | 53.90 PK | 74.00 | -20.10 | 1.68 H | 146 | 18.40 | 35.50 |
| 3 | 4924.00 | 39.30 AV | 54.00 | -14.70 | 1.68 H | 146 | 3.80 | 35.50 |
| 4 | 7386.00 | 49.70 PK | 74.00 | -24.30 | 1.55 H | 157 | 8.90 | 40.80 |
| 4 | 7386.00 | 38.50 AV | 54.00 | -15.50 | 1.55 H | 157 | -2.40 | 40.80 |

ANTENNA POLARITY & TEST DISTANCE: VERTICAL AT 3 M

| No. | Freq. (MHz) | Emission Level (dBuV/m) | Limit (dBuV/m) | Margin (dB) | Antenna Height (m) | Table Angle (Degree) | Raw Value (dBuV) | Correction Factor (dB/m) |
|-----|-------------|-------------------------|----------------|-------------|--------------------|----------------------|------------------|--------------------------|
| 1 | *2462.00 | 100.30 PK | | | 1.27 V | 62 | 70.30 | 30.00 |
| 1 | *2462.00 | 90.20 AV | | | 1.27 V | 62 | 60.20 | 30.00 |
| 2 | 2483.50 | 65.60 PK | 74.00 | -8.40 | 1.27 V | 62 | 35.50 | 30.10 |
| 2 | 2483.50 | 45.60 AV | 54.00 | -8.40 | 1.27 V | 62 | 15.50 | 30.10 |
| 3 | 4924.00 | 51.10 PK | 74.00 | -22.90 | 1.53 V | 252 | 15.60 | 35.50 |
| 3 | 4924.00 | 36.80 AV | 54.00 | -17.20 | 1.53 V | 252 | 1.30 | 35.50 |
| 4 | 7386.00 | 51.70 PK | 74.00 | -22.30 | 1.02 V | 37 | 10.80 | 40.80 |
| 4 | 7386.00 | 39.40 AV | 54.00 | -14.60 | 1.02 V | 37 | -1.50 | 40.80 |

- REMARKS:**
1. Emission level(dBuV/m)=Raw Value(dBuV) + Correction Factor(dB/m)
 2. Correction Factor(dB/m) = Antenna Factor (dB/m) + Cable Factor (dB)
 3. The other emission levels were very low against the limit.
 4. Margin value = Emission level – Limit value.
 5. The limit value is defined as per 15.247
 6. “ * “ : Fundamental frequency

RESTRICTED BANDEDGE (802.11g MODE,CH1, HORIZONTAL)

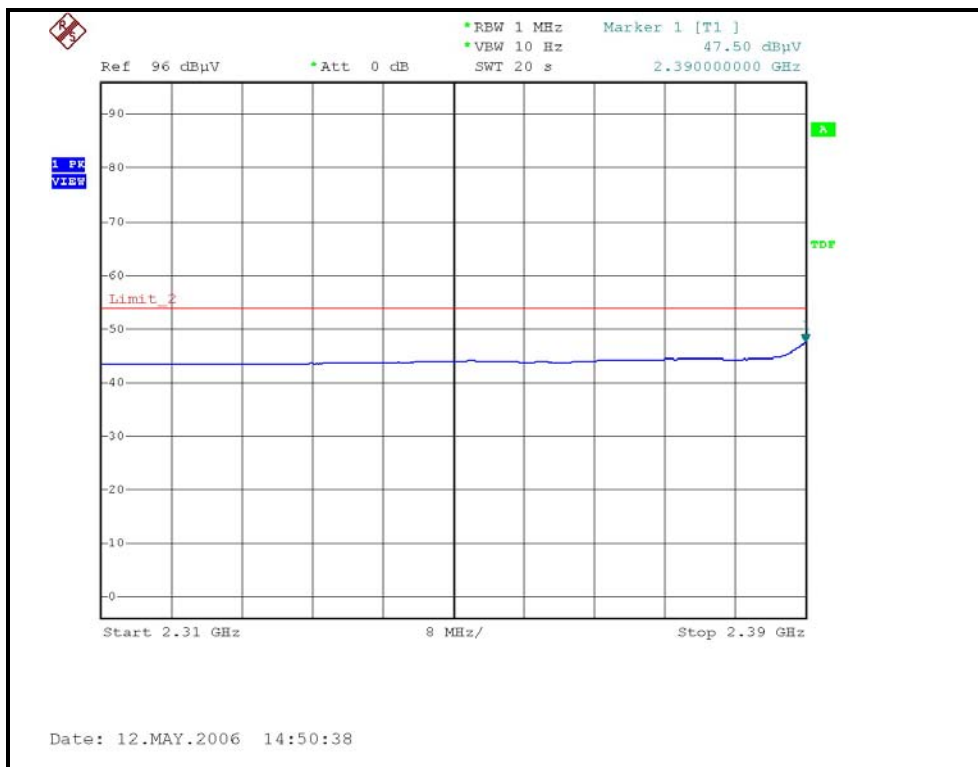
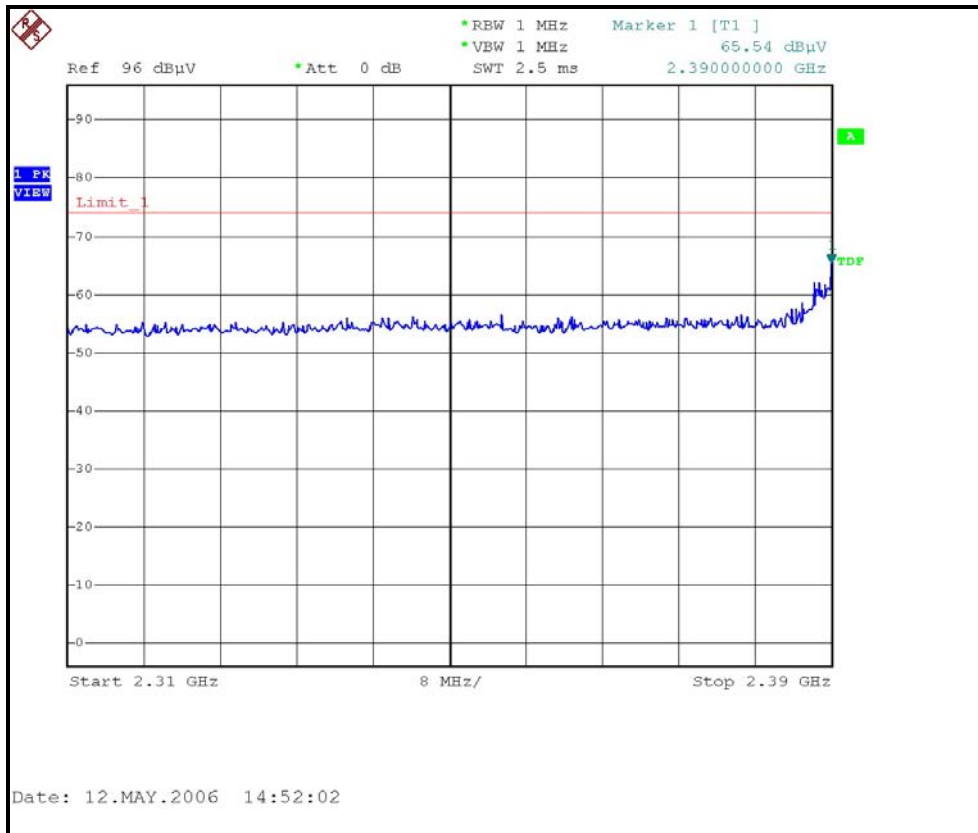

RESTRICTED BANDEDGE (802.11g MODE, CH1, VERTICAL)

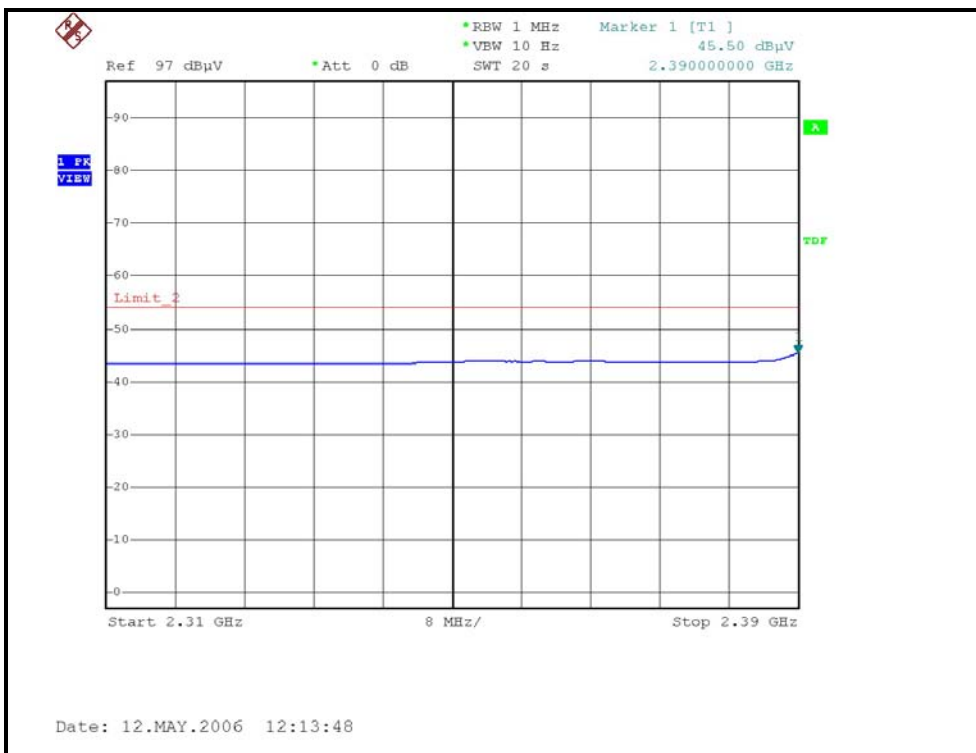
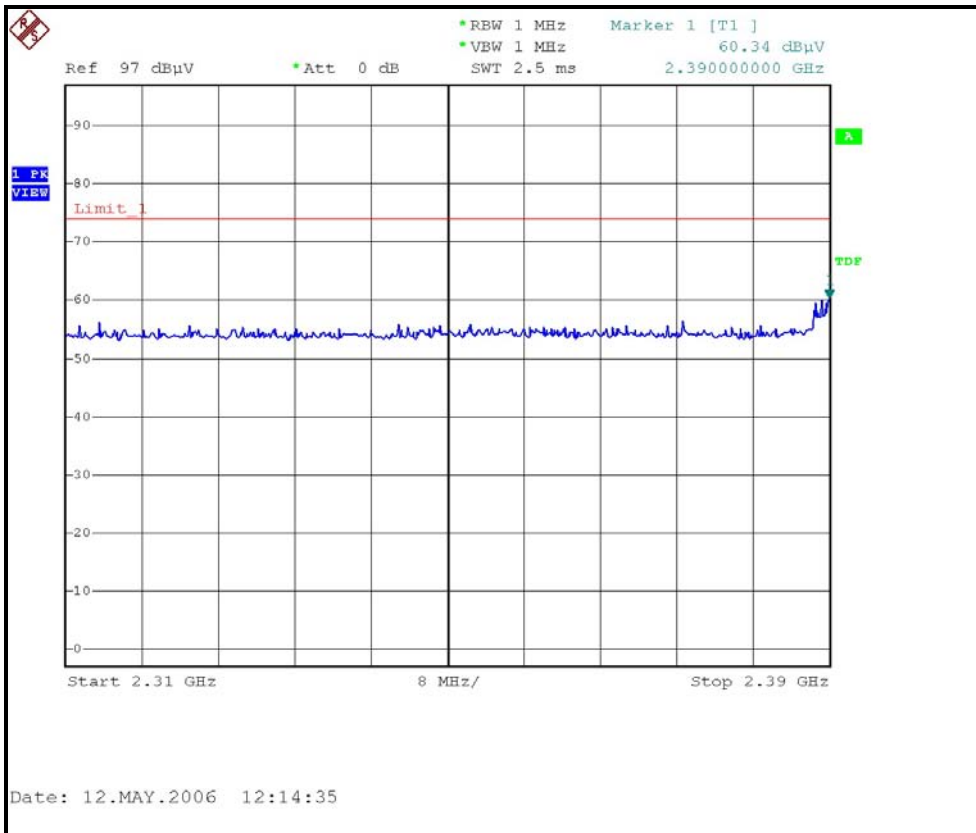

RESTRICTED BANDEDGE (802.11g MODE,CH11, HORIZONTAL)

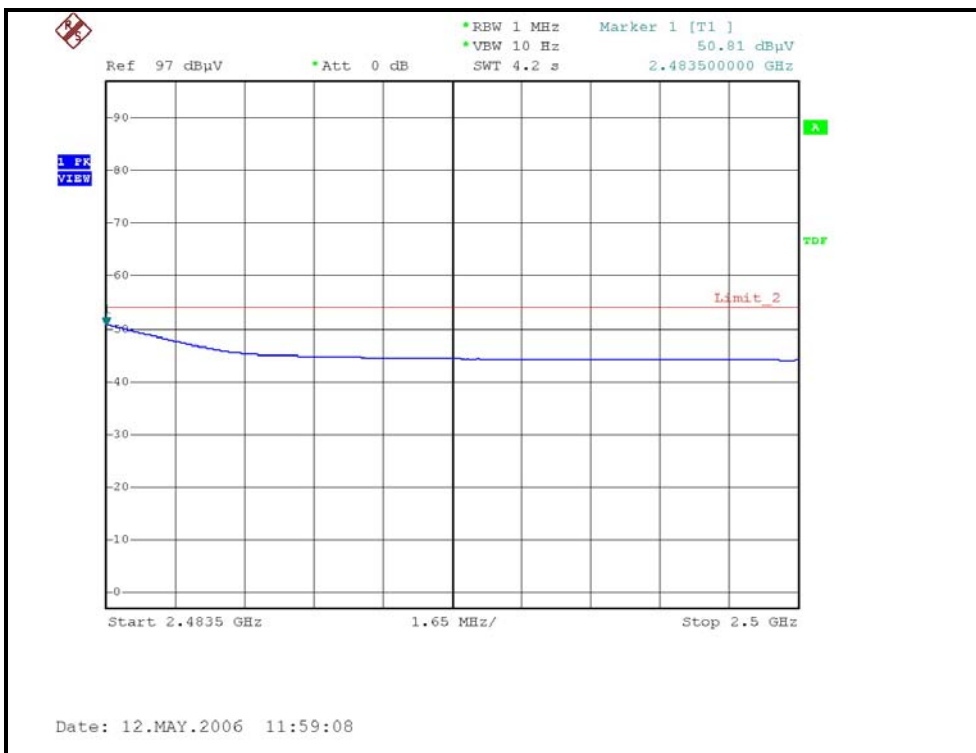
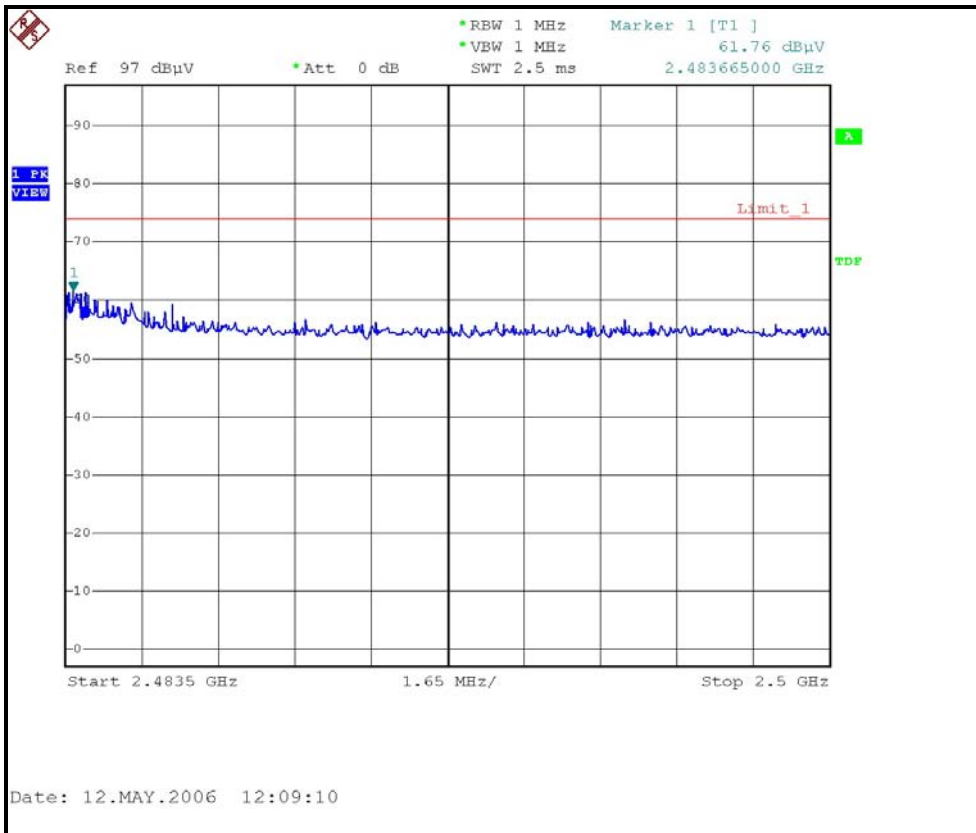

RESTRICTED BANDEDGE (802.11g MODE, CH11, VERTICAL)

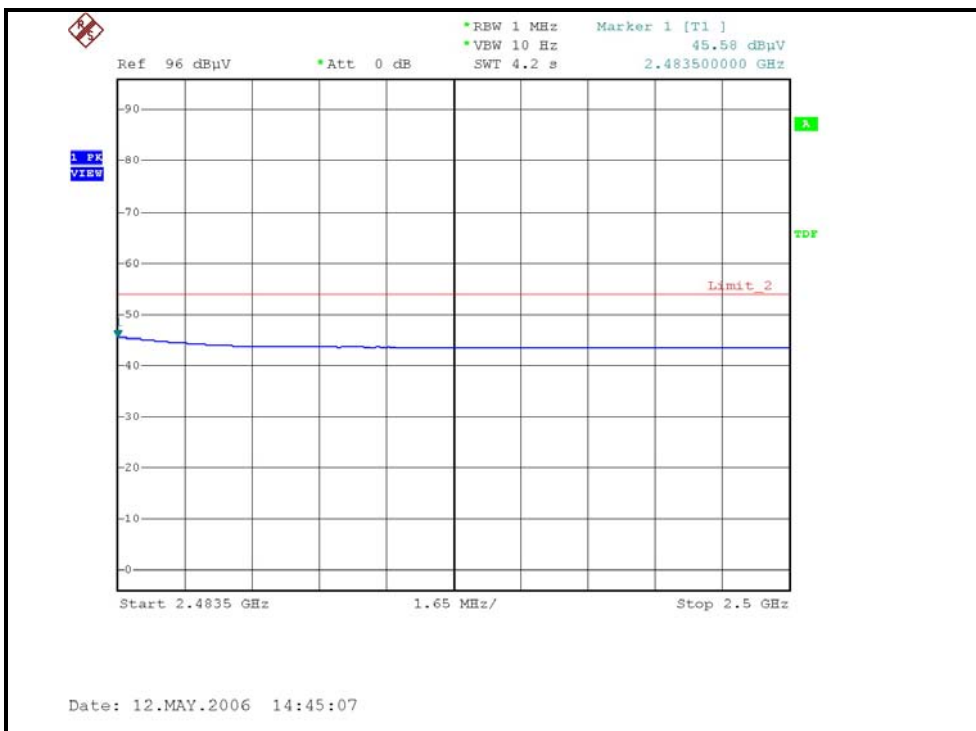
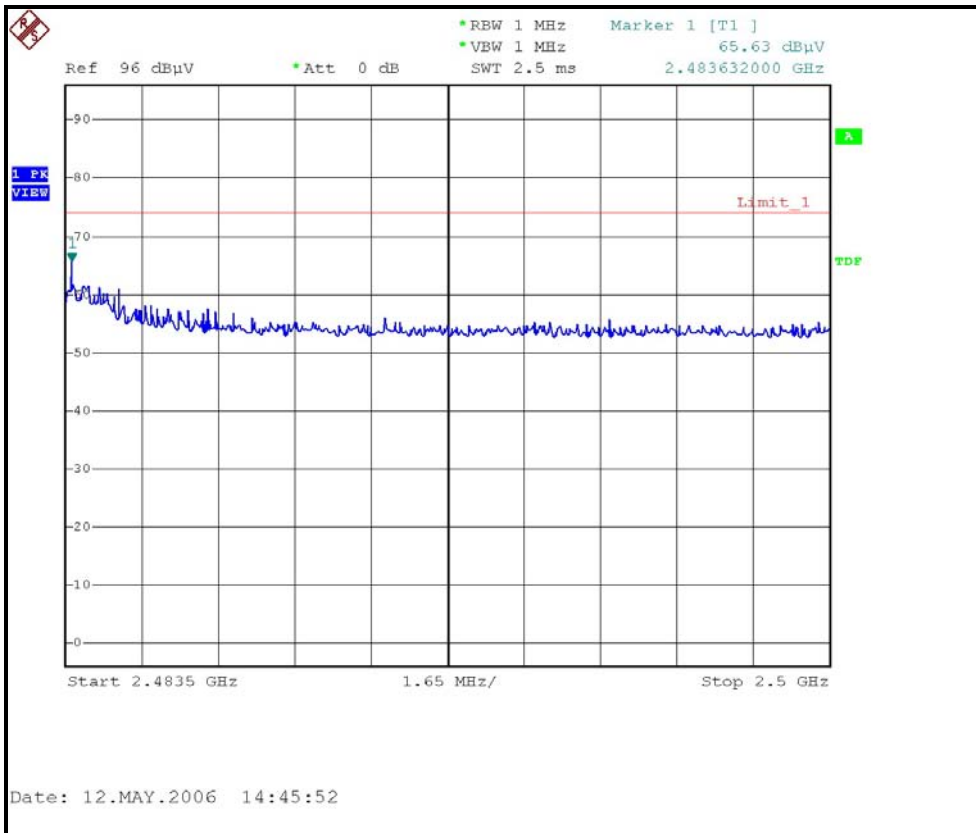



4.3 6dB BANDWIDTH MEASUREMENT

4.3.1 LIMITS OF 6dB BANDWIDTH MEASUREMENT

The minimum of 6dB Bandwidth Measurement is 0.5 MHz.

4.3.2 TEST INSTRUMENTS

| Description & Manufacturer | Model No. | Serial No. | Calibrated Until |
|----------------------------|-----------|------------|------------------|
| R&S SPECTRUM ANALYZER | FSP40 | 100036 | Nov. 23, 2006 |

NOTE:

- 1.The measurement uncertainty is less than +/- 2.6dB, which is calculated as per the NAMAS document NIS81.
- 2.The calibration interval of the above test instruments is 12 months and the calibrations are traceable to NML/ROC and NIST/USA.

4.3.3 TEST PROCEDURE

The transmitter output was connected to the spectrum analyzer through an attenuator. The bandwidth of the fundamental frequency was measured by spectrum analyzer with 100 kHz RBW and 100 kHz VBW. The 6 dB bandwidth is defined as the total spectrum the power of which is higher than peak power minus 6 dB.

4.3.4 TEST SETUP



For the actual test configuration, please refer to the related Item – Photographs of the Test Configuration.

4.3.5 EUT OPERATING CONDITIONS

The software provided by client to enable the EUT under transmission condition continuously at lowest, middle and highest channel frequencies individually.



4.3.6 TEST RESULTS –DSSS

802.11b DSSS modulation

| | | | |
|-----------------------------|---------------|---------------------------------|-------------------------|
| MODULATION TYPE | CCK | TRANSFER RATE | 1Mbps |
| INPUT POWER (SYSTEM) | 120Vac, 60 Hz | ENVIRONMENTAL CONDITIONS | 20deg. C, 60%RH, 972hPa |
| TESTED BY | Tony Chen | | |

| CHANNEL | CHANNEL FREQUENCY (MHz) | 6 dB BANDWIDTH (MHz) | MINIMUM LIMIT (MHz) | PASS/FAIL |
|----------------|--------------------------------|-----------------------------|----------------------------|------------------|
| 1 | 2412 | 12.55 | 0.5 | PASS |
| 6 | 2437 | 12.50 | 0.5 | PASS |
| 11 | 2462 | 12.50 | 0.5 | PASS |

CH1

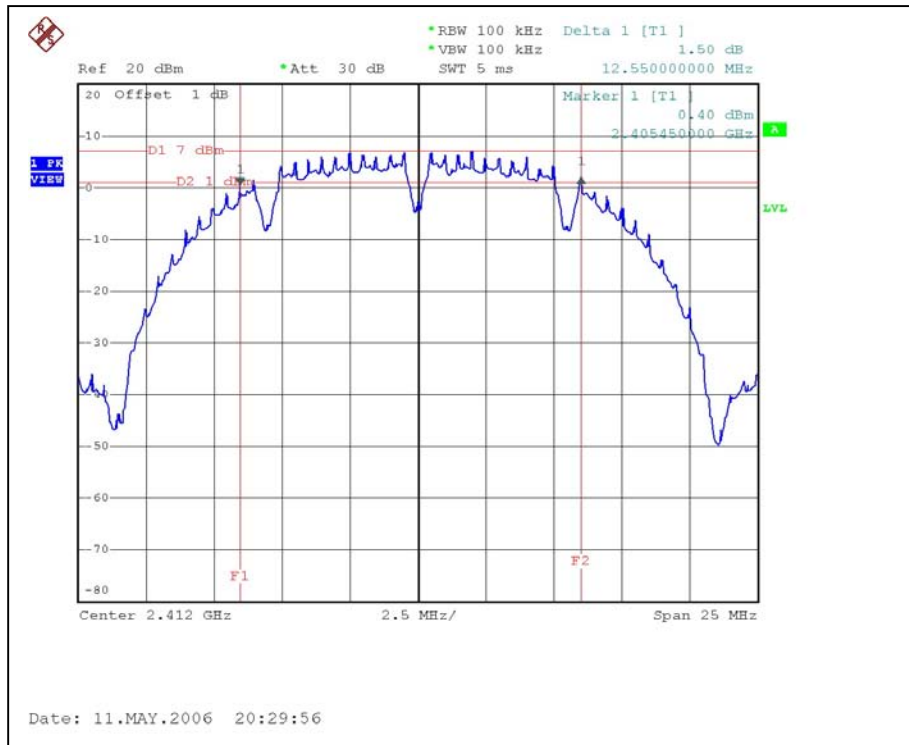

CH6

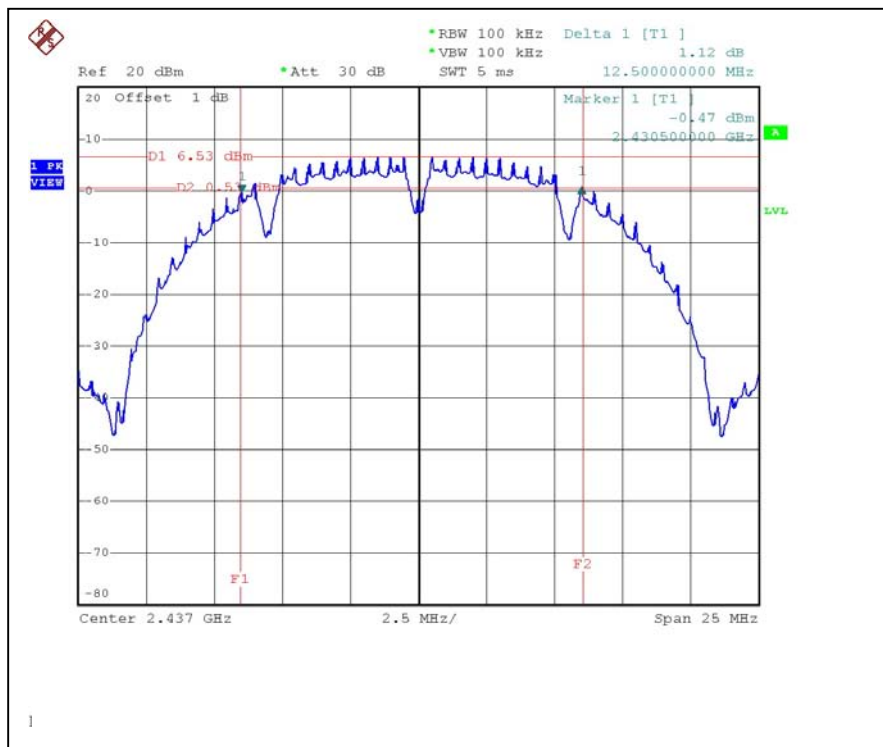

CH11

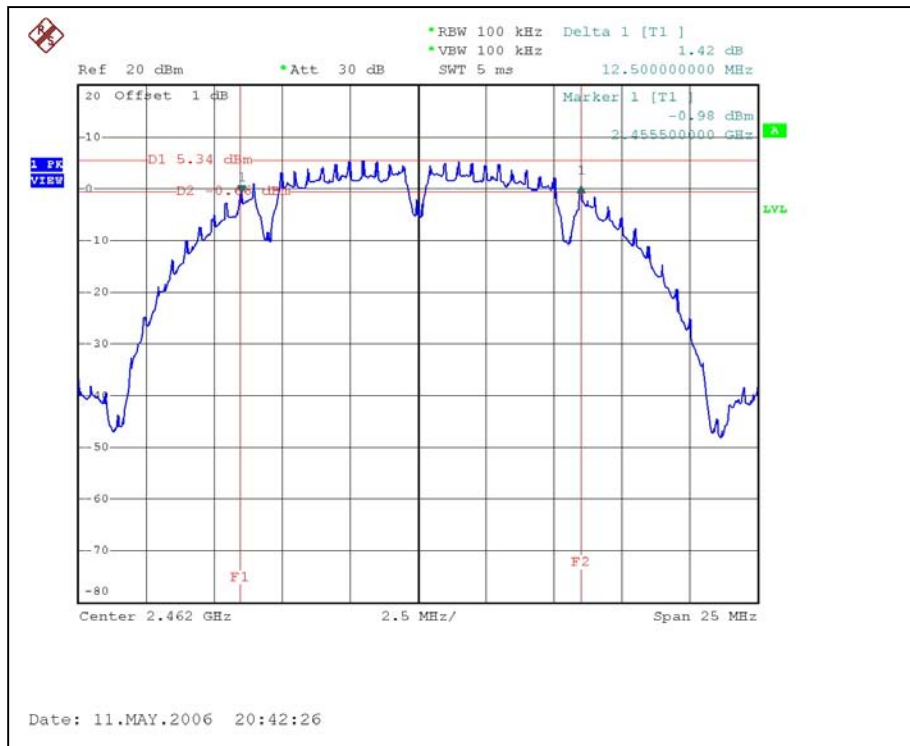



4.3.7 TEST RESULTS-OFDM

802.11g OFDM modulation

| | | | |
|-----------------------------|---------------|---------------------------------|-------------------------|
| MODULATION TYPE | BPSK | TRANSFER RATE | 6Mbps |
| INPUT POWER (SYSTEM) | 120Vac, 60 Hz | ENVIRONMENTAL CONDITIONS | 20deg. C, 60%RH, 972hPa |
| TESTED BY | Tony Chen | | |

| CHANNEL | CHANNEL FREQUENCY (MHz) | 6 dB BANDWIDTH (MHz) | MINIMUM LIMIT (MHz) | PASS/FAIL |
|----------------|--------------------------------|-----------------------------|----------------------------|------------------|
| 1 | 2412 | 16.60 | 0.5 | PASS |
| 6 | 2437 | 16.60 | 0.5 | PASS |
| 11 | 2462 | 16.60 | 0.5 | PASS |

CH1

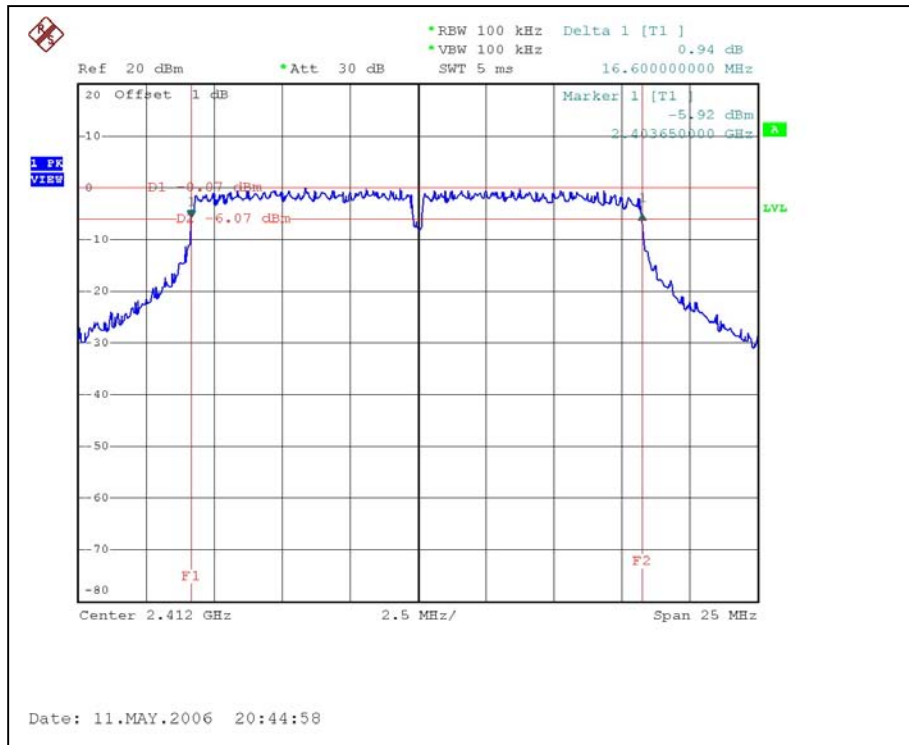

CH6

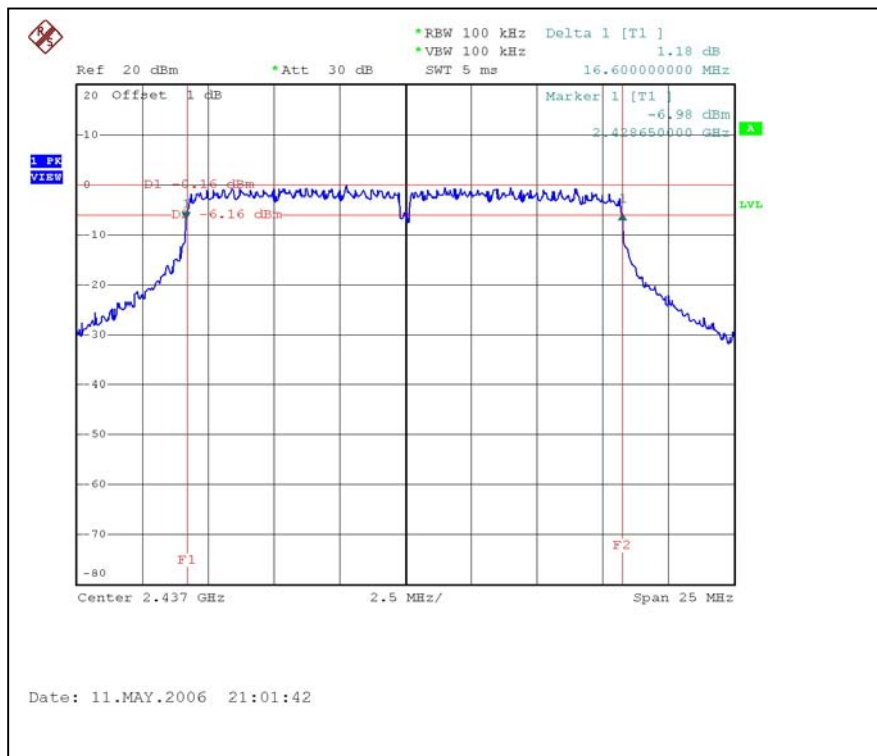

CH11

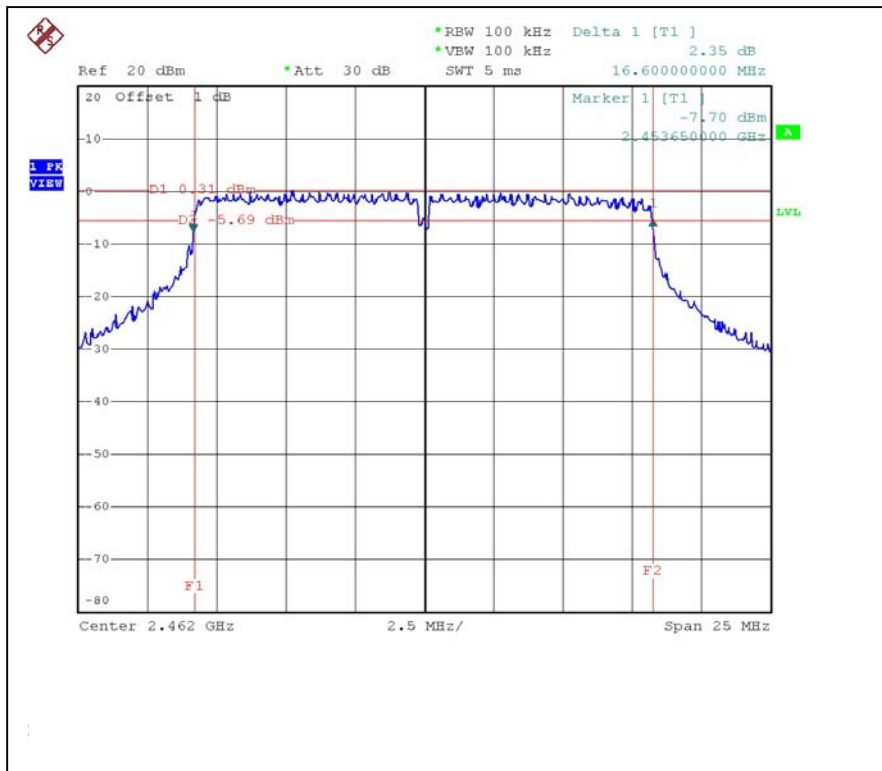



4.4 MAXIMUM PEAK OUTPUT POWER

4.4.1 LIMITS OF MAXIMUM PEAK OUTPUT POWER MEASUREMENT

The Maximum Peak Output Power Measurement is 30dBm.

4.4.2 TEST INSTRUMENTS

| Description & Manufacturer | Model No. | Serial No. | Calibrated Until |
|----------------------------|-----------|------------|------------------|
| R&S SPECTRUM ANALYZER | FSP40 | 100036 | Nov. 23, 2006 |
| Agilent SIGNAL GENERATOR | E8257C | MY43320668 | Dec. 07, 2006 |
| TEKTRONIX OSCILLOSCOPE | TDS380 | B016335 | Jun. 22, 2006 |
| NARDA DETECTOR | 4503A | FSCM99899 | NA |

NOTE:

The calibration interval of the above test instruments is 12 months and the calibrations are traceable to NML/ROC and NIST/USA.

4.4.3 TEST PROCEDURES

1. A detector was used on the output port of the EUT. An oscilloscope was used to read the peak response of the detector.
2. Replaced the EUT by the signal generator. The center frequency of the S.G was adjusted to the center frequency of the measured channel.
3. Adjusted the power to have the same peak reading on oscilloscope. Record the power level.

4.4.4 TEST SETUP

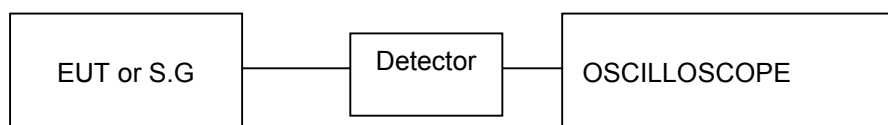

4.4.5 EUT OPERATING CONDITIONS

Same as Item 4.3.5



4.4.6 TEST RESULTS – DSSS

802.11b DSSS modulation

| | | | |
|-----------------------------|--------------|---------------------------------|-------------------------|
| MODULATION TYPE | CCK | TRANSFER RATE | 1Mbps |
| INPUT POWER (SYSTEM) | 120Vac, 60Hz | ENVIRONMENTAL CONDITIONS | 20deg. C, 60%RH, 972hPa |
| TESTED BY | Tony Chen | | |

| CHANNEL | CHANNEL FREQUENCY (MHz) | PEAK POWER OUTPUT (mW) | PEAK POWER OUTPUT (dBm) | PEAK POWER LIMIT (dBm) | PASS/FAIL |
|---------|-------------------------|------------------------|-------------------------|------------------------|-----------|
| 1 | 2412 | 63.096 | 18.00 | 30 | PASS |
| 6 | 2437 | 60.534 | 17.82 | 30 | PASS |
| 11 | 2462 | 50.119 | 17.00 | 30 | PASS |



4.4.7 TEST RESULTS –OFDM

802.11g OFDM modulation

| | | | |
|-----------------------------|--------------|---------------------------------|-------------------------|
| MODULATION TYPE | BPSK | TRANSFER RATE | 6Mbps |
| INPUT POWER (SYSTEM) | 120Vac, 60Hz | ENVIRONMENTAL CONDITIONS | 20deg. C, 60%RH, 972hPa |
| TESTED BY | Tony Chen | | |

| CHANNEL | CHANNEL FREQUENCY (MHz) | PEAK POWER OUTPUT (mW) | PEAK POWER OUTPUT (dBm) | PEAK POWER LIMIT (dBm) | PASS/FAIL |
|----------------|--------------------------------|-------------------------------|--------------------------------|-------------------------------|------------------|
| 1 | 2412 | 61.660 | 17.90 | 30 | PASS |
| 6 | 2437 | 58.884 | 17.70 | 30 | PASS |
| 11 | 2462 | 63.096 | 18.00 | 30 | PASS |



4.5 POWER SPECTRAL DENSITY MEASUREMENT

4.5.1 LIMITS OF POWER SPECTRAL DENSITY MEASUREMENT

The Maximum of Power Spectral Density Measurement is 8dBm.

4.5.2 TEST INSTRUMENTS

| Description & Manufacturer | Model No. | Serial No. | Calibrated Until |
|----------------------------|-----------|------------|------------------|
| R&S SPECTRUM ANALYZER | FSP40 | 100036 | Nov. 23, 2006 |

NOTE:

- 1.The measurement uncertainty is less than +/- 2.6dB, which is calculated as per the NAMAS document NIS81.
- 2.The calibration interval of the above test instruments is 12 months and the calibrations are traceable to NML/ROC and NIST/USA.

4.5.3 TEST PROCEDURE

The transmitter output was connected to the spectrum analyzer through an attenuator, the bandwidth of the fundamental frequency was measured with the spectrum analyzer using 3 kHz RBW and 30 kHz VBW, set sweep time=span/3kHz. The power spectral density was measured and recorded. The sweep time is allowed to be longer than span/3KHz for a full response of the mixer in the spectrum analyzer.

4.5.4 TEST SETUP

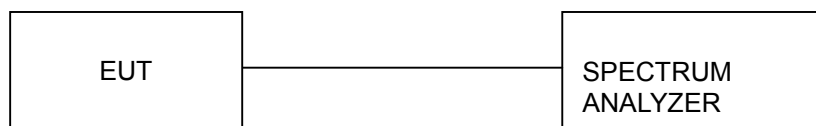

4.5.5 EUT OPERATING CONDITIONS

Same as 4.3.5



4.5.6 TEST RESULTS –DSSS

802.11b DSSS modulation

| | | | |
|-----------------------------|--------------|---------------------------------|-------------------------|
| MODULATION TYPE | CCK | TRANSFER RATE | 1Mbps |
| INPUT POWER (SYSTEM) | 120Vac, 60Hz | ENVIRONMENTAL CONDITIONS | 20deg. C, 60%RH, 972hPa |
| TESTED BY | Tony Chen | | |

| CHANNEL NUMBER | CHANNEL FREQUENCY (MHz) | RF POWER LEVEL IN 3 KHz BW (dBm) | MAXIMUM LIMIT (dBm) | PASS/FAIL |
|-----------------------|---------------------------------|---|----------------------------|------------------|
| 1 | 2412 | -7.24 | 8 | PASS |
| 6 | 2437 | -6.21 | 8 | PASS |
| 11 | 2462 | -7.34 | 8 | PASS |

CH1

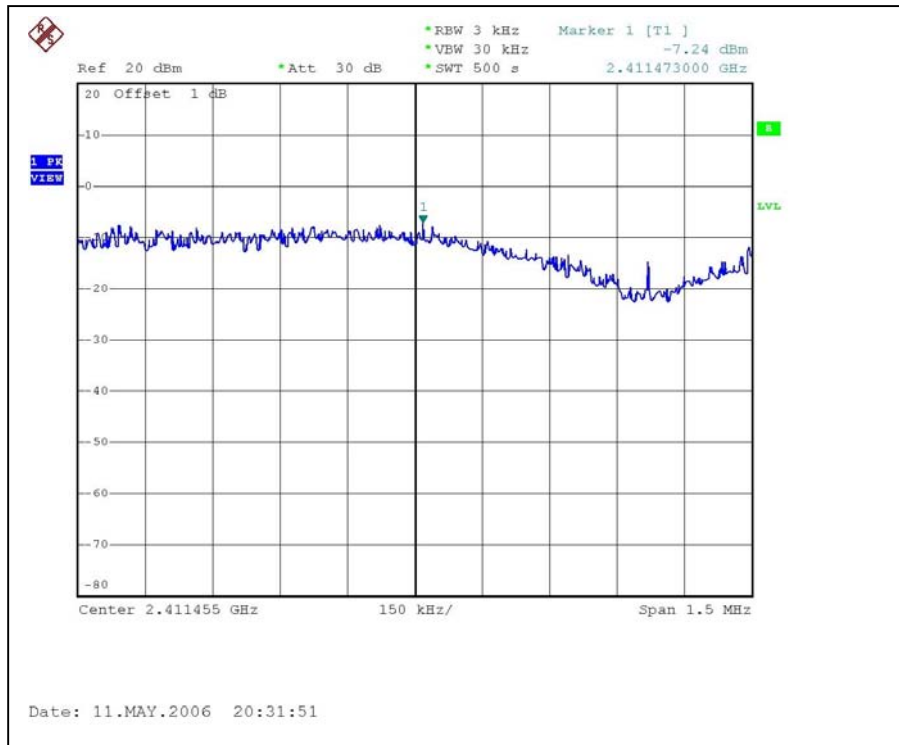

CH6

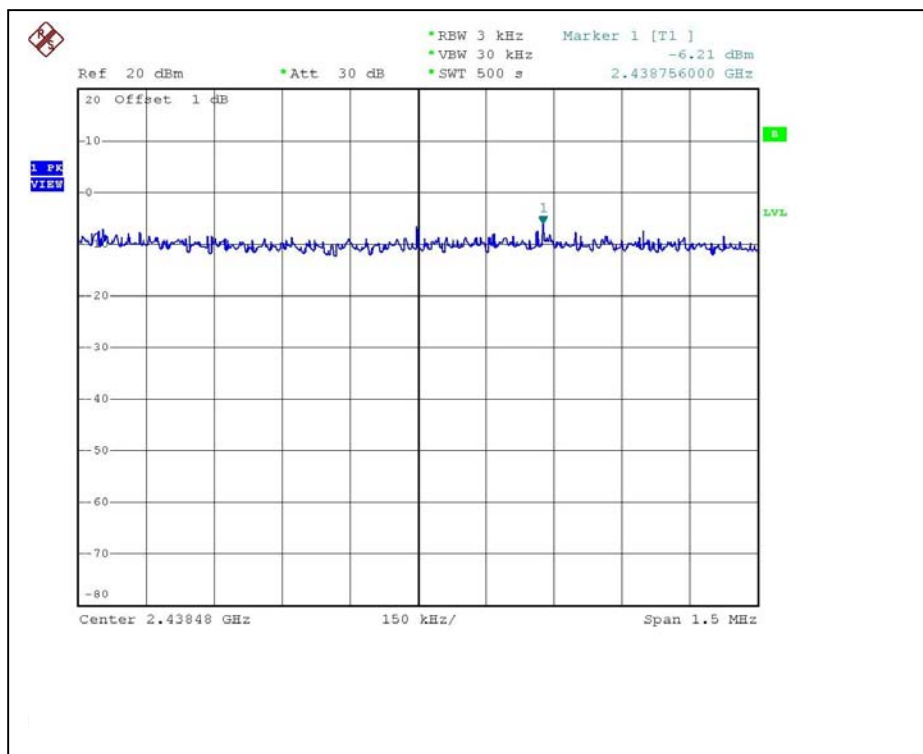

CH11

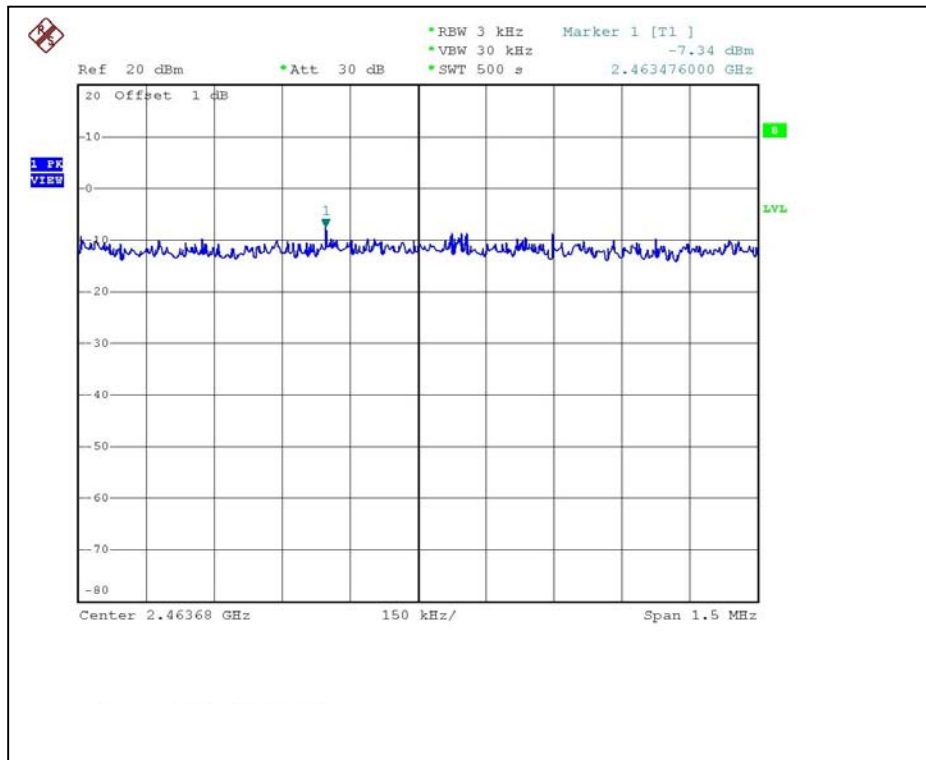



4.5.7 TEST RESULTS –OFDM

802.11g OFDM modulation

| | | | |
|-----------------------------|--------------|---------------------------------|-------------------------|
| MODULATION TYPE | BPSK | TRANSFER RATE | 6Mbps |
| INPUT POWER (SYSTEM) | 120Vac, 60Hz | ENVIRONMENTAL CONDITIONS | 20deg. C, 60%RH, 972hPa |
| TESTED BY | Tony Chen | | |

| CHANNEL NUMBER | CHANNEL FREQUENCY (MHz) | RF POWER LEVEL IN 3 KHz BW (dBm) | MAXIMUM LIMIT (dBm) | PASS/FAIL |
|-----------------------|---------------------------------|---|----------------------------|------------------|
| 1 | 2412 | -9.18 | 8 | PASS |
| 6 | 2437 | -9.47 | 8 | PASS |
| 11 | 2462 | -9.38 | 8 | PASS |

CH1

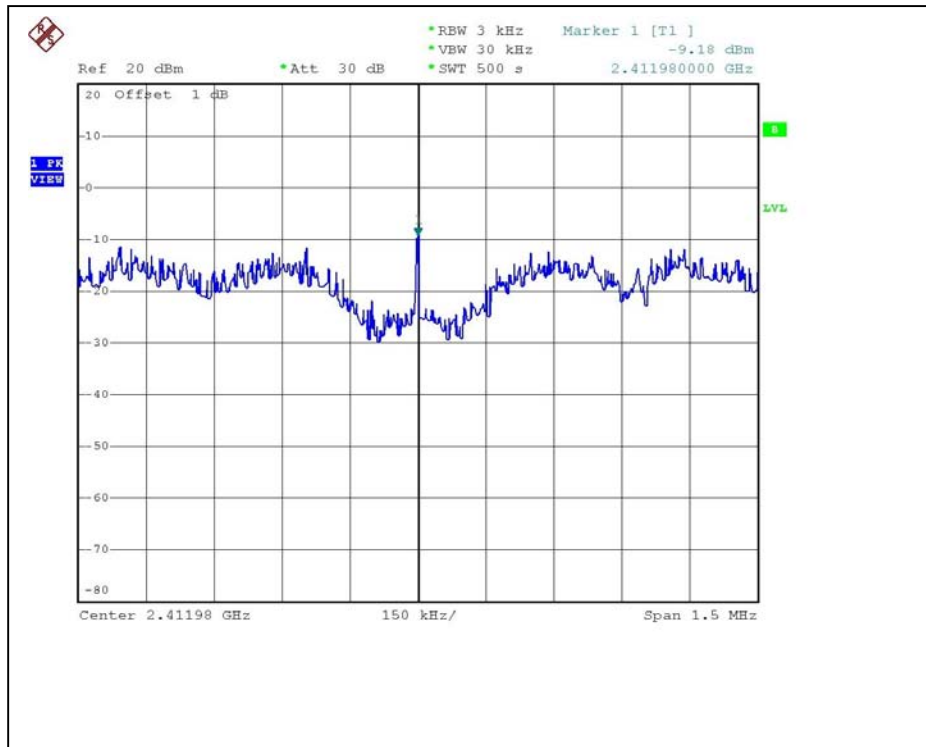

CH6

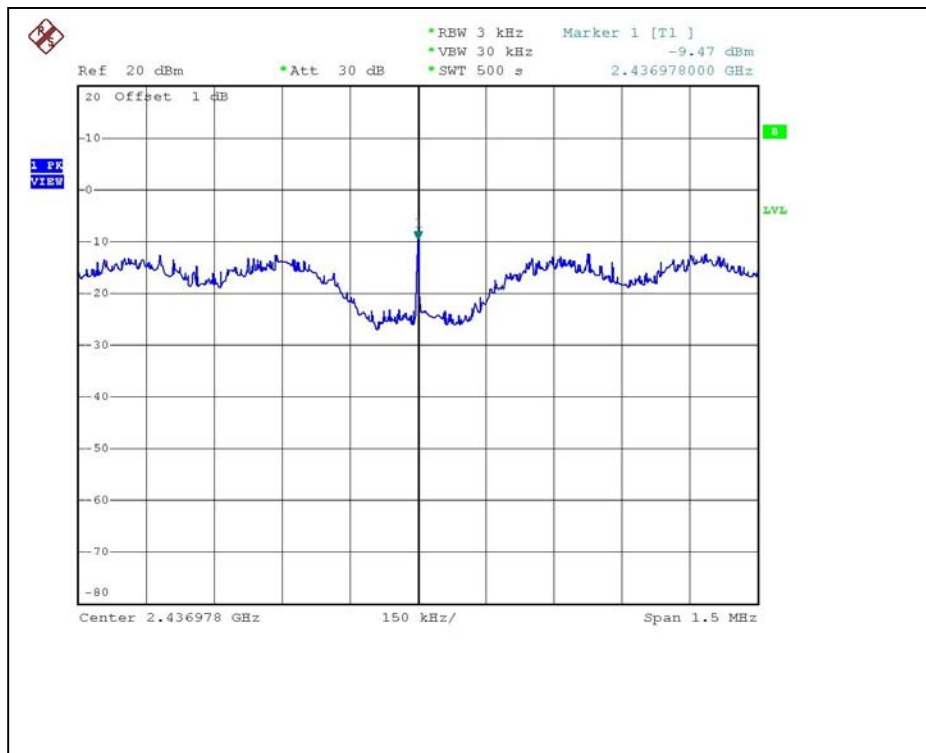

CH11

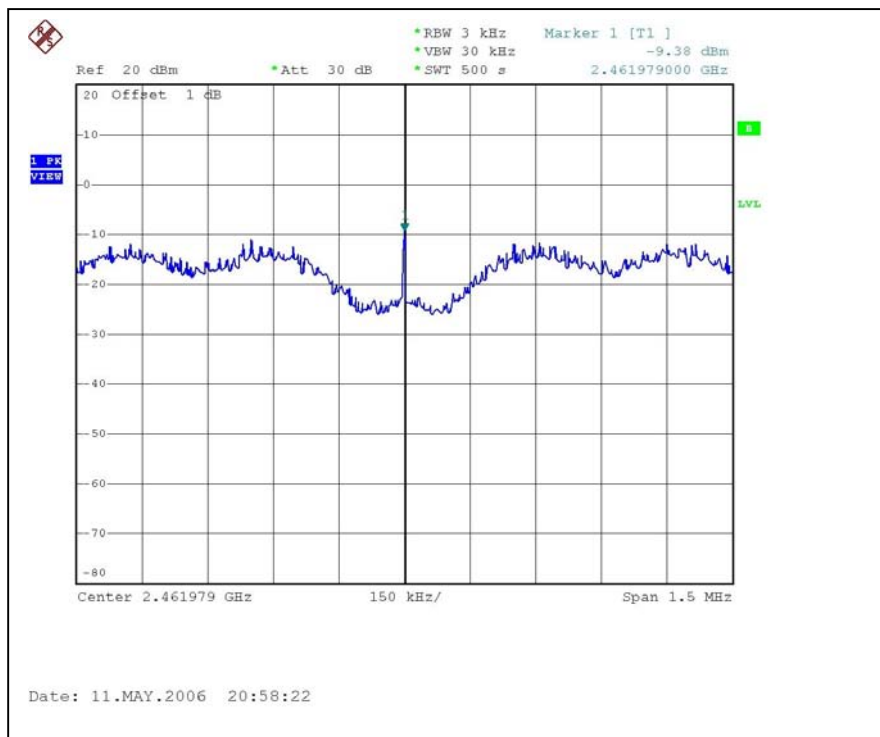



4.6 CONDUCTED EMISSION AND BAND EDGES MEASUREMENT

4.6.1 LIMITS OF CONDUCTED EMISSION AND BAND EDGES MEASUREMENT

Below -20dB of the highest emission level of operating band (in 100KHz Resolution Bandwidth).

4.6.2 TEST INSTRUMENTS

| Description & Manufacturer | Model No. | Serial No. | Calibrated Until |
|----------------------------|-----------|------------|------------------|
| R&S SPECTRUM ANALYZER | FSP40 | 100036 | Nov. 23, 2006 |

NOTE:

- 1.The measurement uncertainty is less than +/- 2.6dB, which is calculated as per the NAMAS document NIS81.
- 2.The calibration interval of the above test instruments is 12 months and the calibrations are traceable to NML/ROC and NIST/USA.

4.6.3 TEST PROCEDURE

The transmitter output was connected to the spectrum analyzer via a low loss cable. Set both RBW and VBW of spectrum analyzer to 100kHz with suitable frequency span including 100 MHz bandwidth from band edge. The band edges was measured and recorded.

The spectrum plots (RBW = VBW = 100kHz) are attached on the following pages.

4.6.4 DEVIATION FROM TEST STANDARD

No deviation

4.6.5 EUT OPERATING CONDITION

Same as Item 4.3.6



4.6.6 TEST RESULTS

The spectrum plots are attached on the following 12 images. D1 line indicates the highest level, and D2 line indicates the 20dB offset below D1. It shows compliance with the requirement in part 15.247(d).

**802.11b DSSS MODULATION:
CH1**

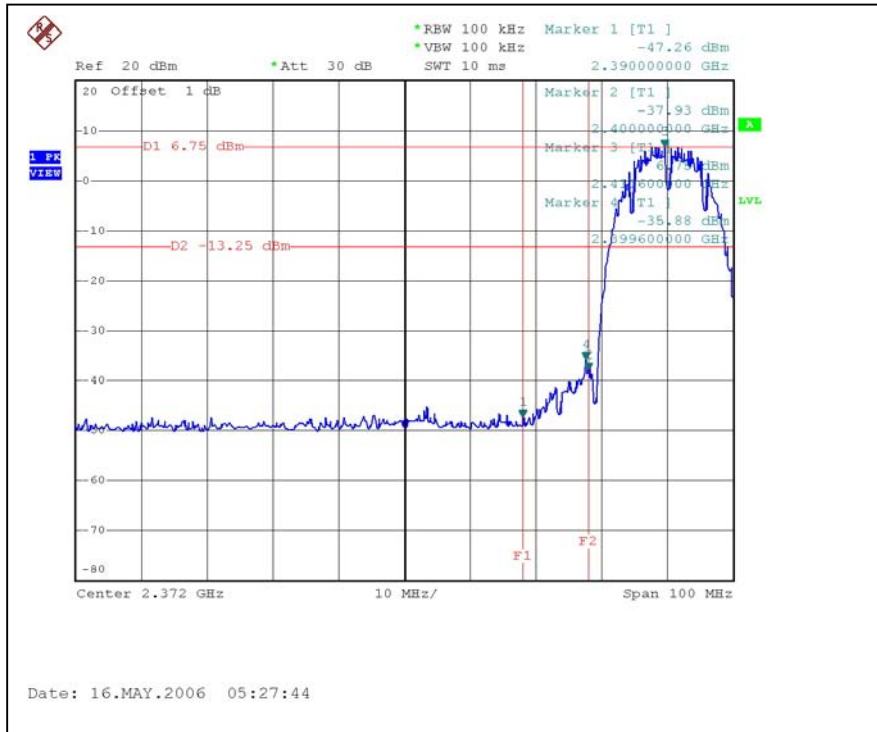

CH11

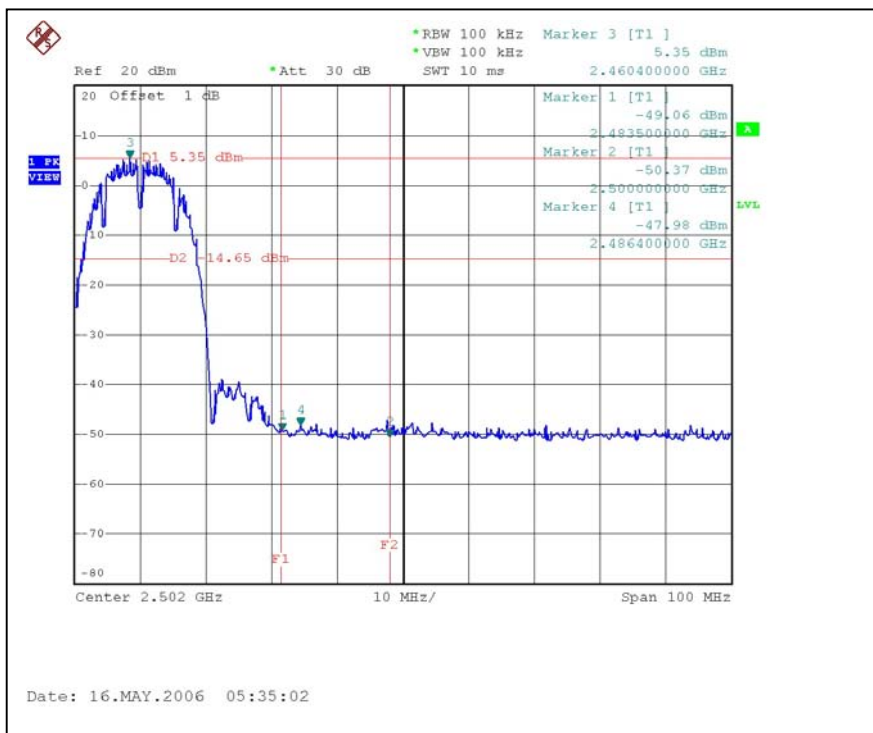

CH1

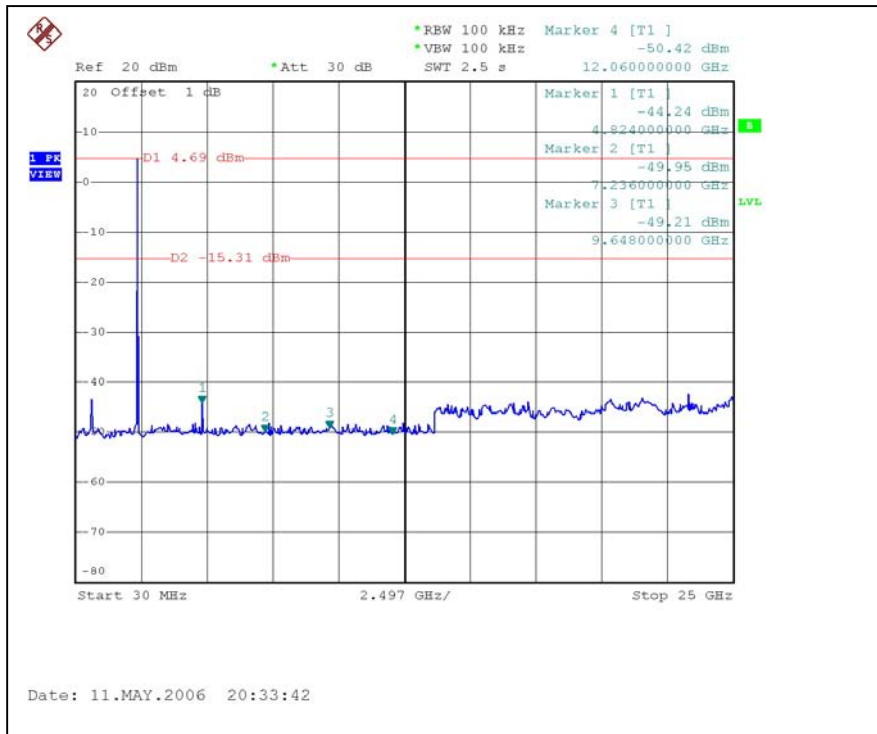

CH11

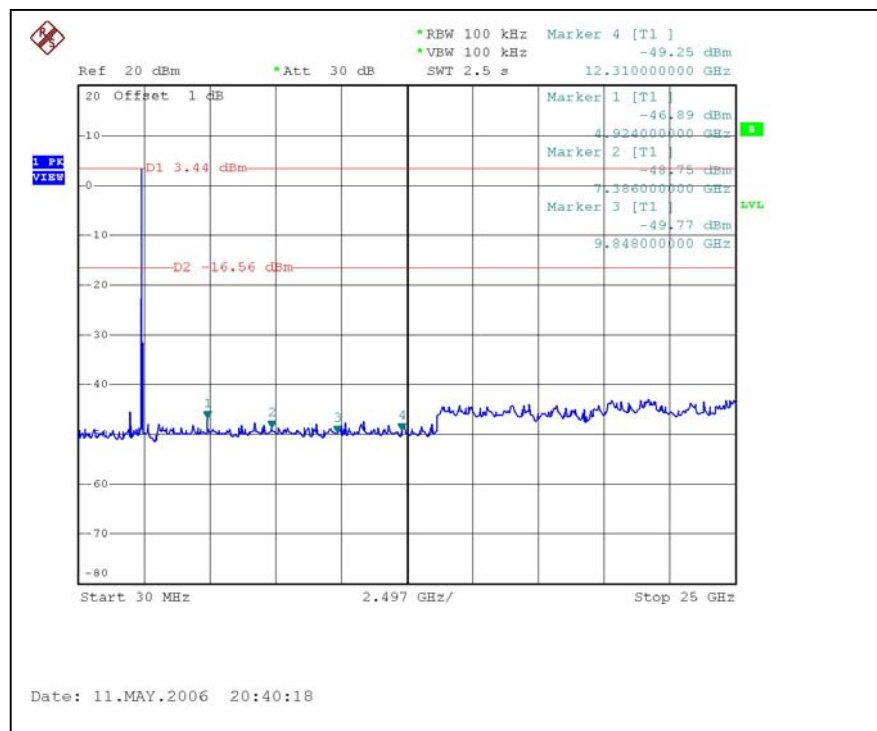

802.11g OFDM MODULATION: CH1

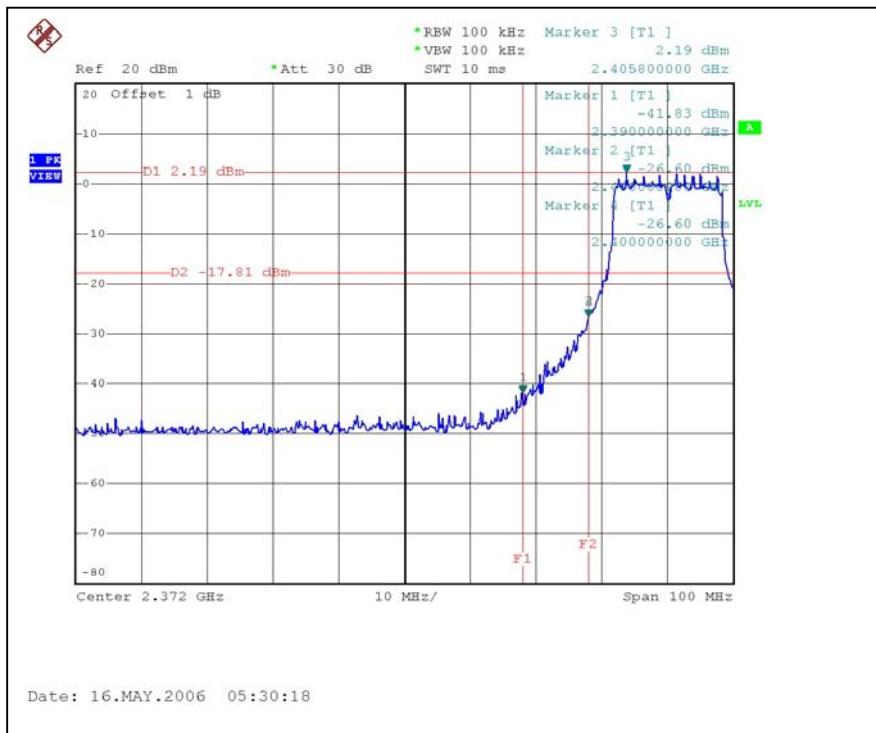

CH11

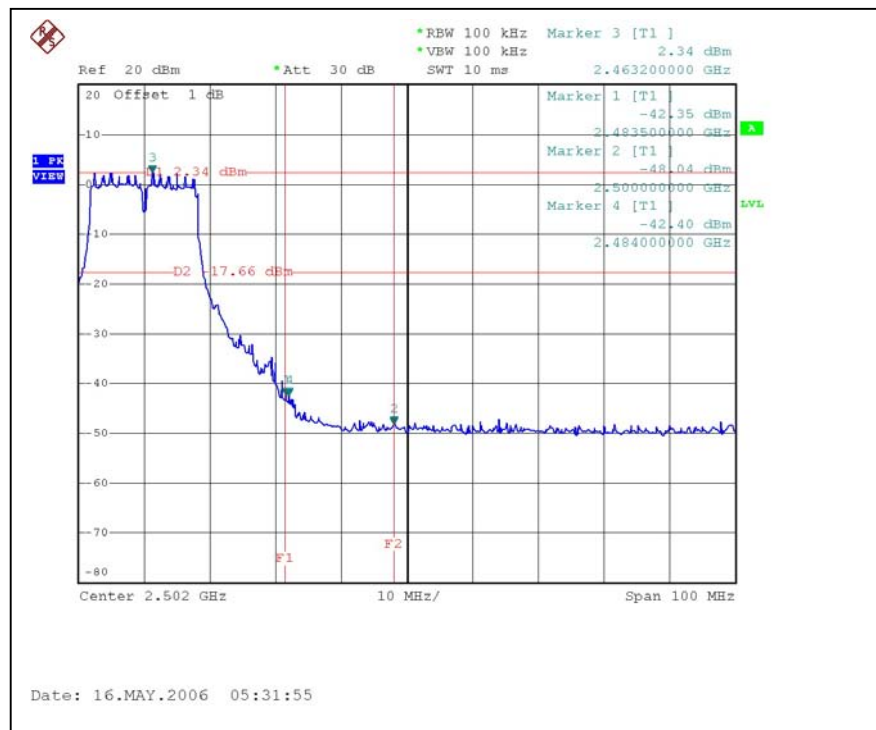

CH1

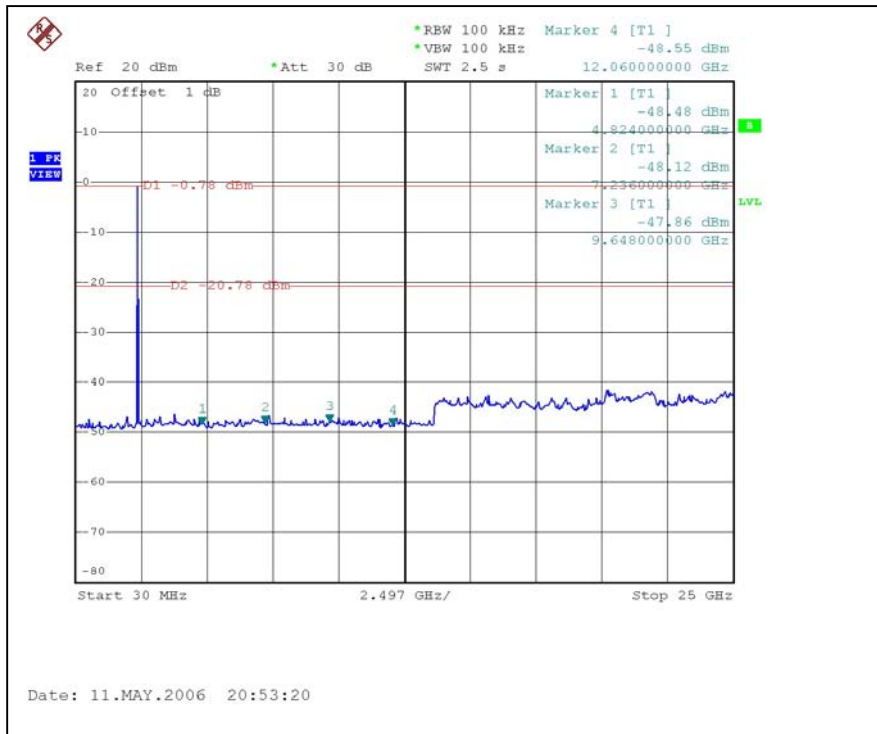

CH11

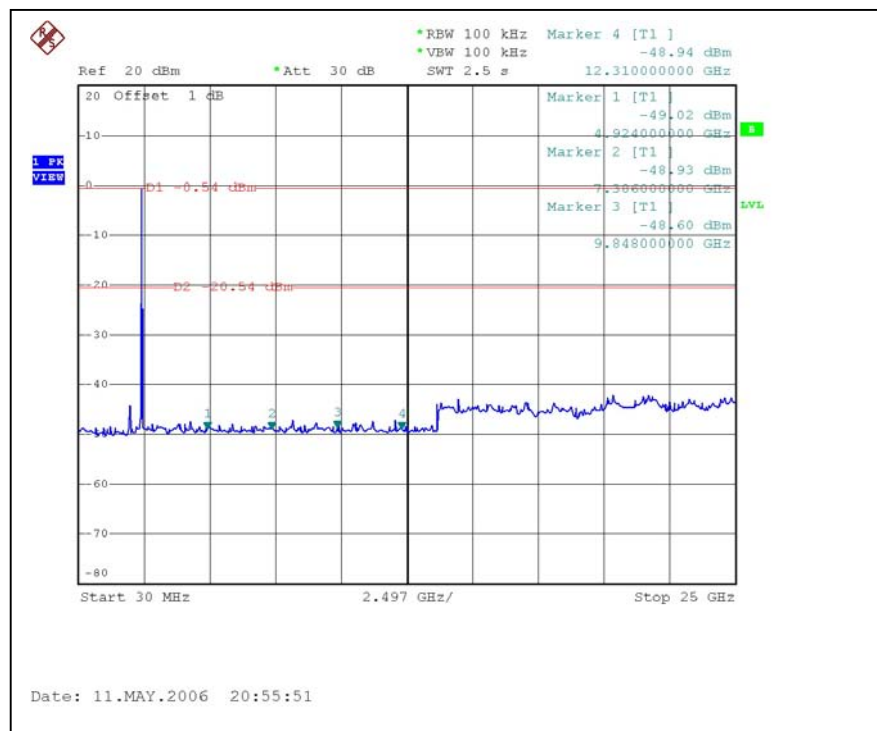



4.7 ANTENNA REQUIREMENT

4.7.1 STANDARD APPLICABLE

For intentional device, according to FCC 47 CFR Section 15.203, an intentional radiator shall be designed to ensure that no antenna other than that furnished by the responsible party shall be used with the device.

And according to FCC 47 CFR Section 15.247 (b), if transmitting antennas of directional gain greater than 6dBi are used, the power shall be reduced by the amount in dB that the directional gain of the antenna exceeds 6dBi.

4.7.2 ANTENNA CONNECTED CONSTRUCTION

The antenna used in this product is printed antenna without connector. The maximum Gain of the antenna is 1.98dBi.

5 PHOTOGRAPHS OF THE TEST CONFIGURATION CONDUCTED EMISSION TEST (WITH USB CRADLE)



RADIATED EMISSION TEST (WITHOUT USB CRADLE)



RADIATED EMISSION TEST (WITH USB CRADLE)





6 INFORMATION ON THE TESTING LABORATORIES

We, ADT Corp., were founded in 1988 to provide our best service in EMC, Radio, Telecom and Safety consultation. Our laboratories are accredited and approved by the following approval agencies according to ISO/IEC 17025:

| | |
|--------------------|----------------------|
| USA | FCC, UL, A2LA |
| Germany | TUV Rheinland |
| Japan | VCCI |
| Norway | NEMKO |
| Canada | INDUSTRY CANADA, CSA |
| R.O.C. | CNLA, BSMI, DGT |
| Netherlands | Telefication |
| Singapore | PSB, GOST-ASIA (MOU) |
| Russia | CERTIS (MOU) |

Copies of accreditation certificates of our laboratories obtained from approval agencies can be downloaded from our web site: www.adt.com.tw/index.5/phtml.

If you have any comments, please feel free to contact us at the following:

Linko EMC/RF Lab:

Tel: 886-2-26052180

Fax: 886-2-26052943

Hsin Chu EMC/RF Lab:

Tel: 886-3-5935343

Fax: 886-3-5935342

Hwa Ya EMC/RF/Safety/Telecom Lab:

Tel: 886-3-3183232

Fax: 886-3-3185050

Email: service@adt.com.tw

Web Site: www.adt.com.tw

The address and road map of all our labs can be found in our web site also.



APPENDIX-A

MODIFICATIONS RECORDERS FOR ENGINEERING CHANGES TO THE EUT BY THE LAB

No any modifications are made to the EUT by the lab during the test.