



FCC TEST REPORT

for

47 CFR Part 15 Subpart C and IC RSS-210

Equipment : U.S. Robotics MAXg Wireless Router
U.S. Robotics MAXg Wireless Access Point

Trade Name : UNIVERSAL SCIENTIFIC INDUSTRIAL CO., LTD. (for FCC)
U.S.ROBOTICS CORPORATION (for IC)

Model No. : USR5465 (for Router)
USR5455 (for AP)

FCC ID : IXM-RTGBR03 (for Router)
IXM-APGBR03 (for AP)

IC ID : 550A-15042 (for Router)
550A-15043 (for AP)

Filing Type : Certification

Applicant : Universal Scientific Industrial Co., Ltd.

141, Lane 351, Taiping Road, Sec. 1, Tsao Tuen, Nan-Tou, Taiwan

- The test result refers exclusively to the test presented test model / sample.
- Without written approval of SPORTON International Inc., the test report shall not be reproduced except in full.
- **Certificate or Test Report must not be used by the applicant to claim the product in this test report endorsement by NVLAP or any agency of U.S. government.**
- The data shown in this test report were carried out on Apr. 27, 2007 at **Sporton International Inc. LAB.**
- Report No.: FR732603, Report Version: Rev. 01

Roy Wu
Deputy Manager

SPORTON International Inc.

6F, No.106, Sec. 1, Hsin Tai Wu Rd., Hsi Chih, Taipei Hsien, Taiwan, R.O.C.

SPORTON International Inc.

TEL : 886-2-2696-2468

FAX : 886-2-2696-2255

Report Version: Rev. 01



Table of Contents

History of this test report.....ii

1. General Description of Equipment under Test..... 1

 1.1 Applicant1

 1.2 Manufacturer1

 1.3 Basic Description of Equipment under Test.....1

 1.4 Feature of Equipment under Test2

2 Test Configuration of Equipment under Test3

 2.1 Test Manner3

 2.2 Test Mode3

 2.3 Connection Diagram of Test System4

 2.4 Ancillary Equipment List.....4

3. RF Utility5

4. General Information of Test.....6

 4.1 Test Voltage6

 4.2 Standard for Methods of Measurement.....6

 4.3 Test in Compliance with6

 4.4 Frequency Range Investigated6

 4.5 Test Distance6

5. Test Data and Test Result.....7

 5.1 List of Measurements and Examinations7

 5.2 6dB Bandwidth Measurement8

 5.3 Power Spectral Density Measurement.....15

 5.4 Band Edges Measurement.....23

 5.5 Peak Output Power Measurement30

 5.6 Conducted Emission31

 5.7 Radiated Emission Measurement38

 5.8 Antenna Requirements100

6 List of Measuring Equipments Used101

7 Uncertainty Evaluation.....102

Appendix A. Photographs of EUT External

Appendix B. Photographs of EUT Internal

Appendix C. Photographs of Setup



History of this test report

Report Issue Date: Apr. 30, 2007

Report No.	Description



1. General Description of Equipment under Test

1.1 Applicant

Universal Scientific Industrial Co., Ltd.

141, Lane 351, Taiping Road, Sec. 1, Tsao Tuen, Nan-Tou, Taiwan

1.2 Manufacturer

Universal Scientific Industrial Co., Ltd.

141, Lane 351, Taiping Road, Sec. 1, Tsao Tuen, Nan-Tou, Taiwan

1.3 Basic Description of Equipment under Test

Equipment : U.S. Robotics MAXg Wireless Router
U.S. Robotics MAXg Wireless Access Point

Trade Name : UNIVERSAL SCIENTIFIC INDUSTRIAL CO., LTD. (for FCC)
U.S.ROBOTICS CORPORATION (for IC)

Model No. : USR5465 (for AP)
USR5455 (for Router)

FCC ID : IXM-RTGBR03 (for AP)
IXM-APGBR03 (for Router)

IC ID : 550A-15042 (for AP)
550A-15043 (for Router)

Power Supply Type : Switching

AC Power Cord : AC 120V, Wall-mount, 1.8 m, 2 pin

Adapter 1 : SINO-AMERICAN, SA110C-09S-1

Adapter 2 : OEM, ADS10W090120



1.4 Feature of Equipment under Test

Product Feature & Specification	
1. DUT Type	U.S. Robotics MAXg Wireless Router U.S. Robotics MAXg Wireless Access Point
2. Trade Name	UNIVERSAL SCIENTIFIC INDUSTRIAL CO., LTD. (for FCC) U.S.ROBOTICS CORPORATION (for IC)
3. Model Name	USR5465 (for Router) USR5455 (for AP)
4. FCC ID	IXM-RTGBR03 (for Router) IXM-APGBR03 (for AP)
5. IC ID	550A-15042 (for Router) 550A-15043 (for AP)
6. Tx Frequency	2400 ~ 2483.5 MHz
7. Rx Frequency	2400 ~ 2483.5 MHz
8. Number of Channels	11
9. Carrier Frequency of Each Channel	$2412+(n-1)*5$ MHz; $n=1\sim 11$
10. Antenna Connector	Reverse SMA
11. Antenna Type	Dipole Antenna
12. Antenna Gain	1.8 dBi
13. Maximum Output Power	802.11b : 21.03 dBm 802.11g : 22.62 dBm
14. Type of Modulation	DSSS / OFDM
15. DUT Stage	Identical Prototype
16. Application Type	Certification



2 Test Configuration of Equipment under Test

2.1 Test Manner

- a. The EUT has been associated with peripherals pursuant to ANSI C63.4-2003 and configuration operated in a manner tended to maximize its emission characteristics in a typical application.
- b. For spurious emission below 1GHz, only one channel of each application was tested because it is not related to channel selection.
- c. The EUT is programmed to transmit signal continuously for all testings.
- d. Frequency range investigated: conduction 150 kHz to 30 MHz, radiation 30 MHz to 25000MHz.

2.2 Test Mode

Application		
	802.11b	802.11b
Radiated Emission	Mode 1: Tx_CH01_2412 MHz	Mode 4: Tx_CH01_2412 MHz
	Mode 2: Tx_CH06_2437 MHz	Mode 5: Tx_CH06_2437 MHz
	Mode 3: Tx_CH11_2462 MHz	Mode 6: Tx_CH11_2462 MHz
Conducted Emission	Mode 1: WLAN Link Mode + LAN + Print + Adapter 1 for USR5465	
	Mode 2: WLAN Link Mode + LAN + Print + Adapter 2 for USR5465	
	Mode 3: WLAN Link Mode + LAN + Adapter 1 for USR5455	

2.3 Connection Diagram of Test System

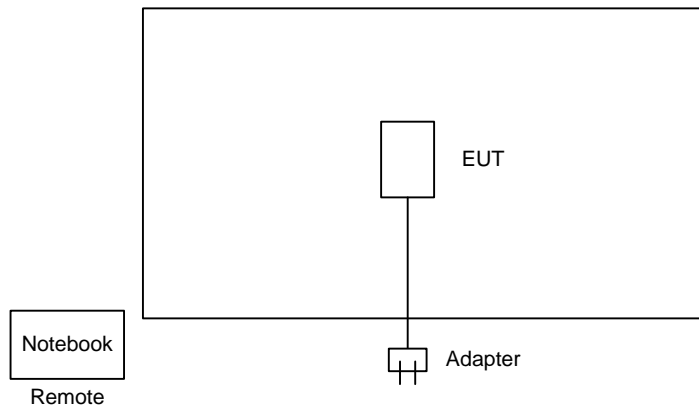

2.4 Ancillary Equipment List

Item	Asset	Model Name	Power Cord
1.	Notebook (DELL)	PP03L	N/A



3. RF Utility

The programmed RF Utility is installed in notebook to provide channel selection, power lever, data rate and the application type. RF Utility can send transmitting signal for all testings.



4. General Information of Test

Test Site Location : No. 52, Hwa Ya 1st Rd., Hwa Ya Technology Park,
Kwei-Shan Hsiang, Tao Yuan Hsien, Taiwan, R.O.C.
TEL : 886-3-327-3456
FAX : 886-3-318-0055

Test Site No : CO01-HY, 03CH06-HY, TH02-HY

4.1 Test Voltage

120V/ 60Hz

4.2 Standard for Methods of Measurement

ANSI C63.4-2003

4.3 Test in Compliance with

47 CFR Part 15 Subpart C and IC RSS-210 Issued 6

4.4 Frequency Range Investigated

- a. Conducted Emission : from 150 KHz to 30 MHz
- b. Radiated Emission : from 30 MHz to 25000 MHz

4.5 Test Distance

The test distance of radiated emission from antenna to EUT is 3 m.



5. Test Data and Test Result

5.1 List of Measurements and Examinations

FCC Rule	IC Rule	Description of Test	Result
15.207	RSS-Gen 7.2.2	Conducted Emission	Pass
15.247(a)(2)	A8.2 (1)	6dB Bandwidth	Pass
15.247(b)	A8.4 (4)	Maximum Peak Output Power	Pass
15.209(a)	2.6	Radiated Emission	Pass
15.247 (c)	A8.5	100kHz Bandwidth of Frequency Band Edges	Pass
15.247(d)	A8.2 (2)	Power Spectral Density	Pass
15.203 15.247(b)(4)	A8.4 (6)	Antenna Requirement	Pass

5.2 6dB Bandwidth Measurement

5.2.1 Measuring Instruments :

As described in chapter 6 of this test report.

5.2.2 Test Procedure :

1. The transmitter output was connected to the spectrum analyzer directly.
2. Set RBW of spectrum analyzer to 100kHz and VBW to 100kHz.
3. The 6 dB bandwidth is defined as the frequency range where the power is higher than the peak power minus 6dB.

5.2.3 Test Setup Layout :

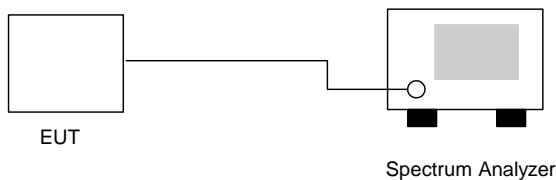

5.2.4 Test Result :

- Application Type : WLAN 802.11b/g
- Temperature : 25°C
- Relative Humidity : 53%
- Test Enginner : Tony

802.11b

Channel	Frequency (MHz)	6dB Emission bandwidth (MHz)	Limits (MHz)	Plot Ref. No.
01	2412	10.45	> 0.5MHz	Mode 1
06	2437	9.71	> 0.5MHz	Mode 2
11	2462	9.78	> 0.5MHz	Mode 3

802.11g

Channel	Frequency (MHz)	6dB Emission bandwidth (MHz)	Limits (MHz)	Plot Ref. No.
01	2412	16.31	> 0.5MHz	Mode 4
06	2437	16.38	> 0.5MHz	Mode 5
11	2462	16.38	> 0.5MHz	Mode 6



5.2.5 6dB Bandwidth

Mode 1

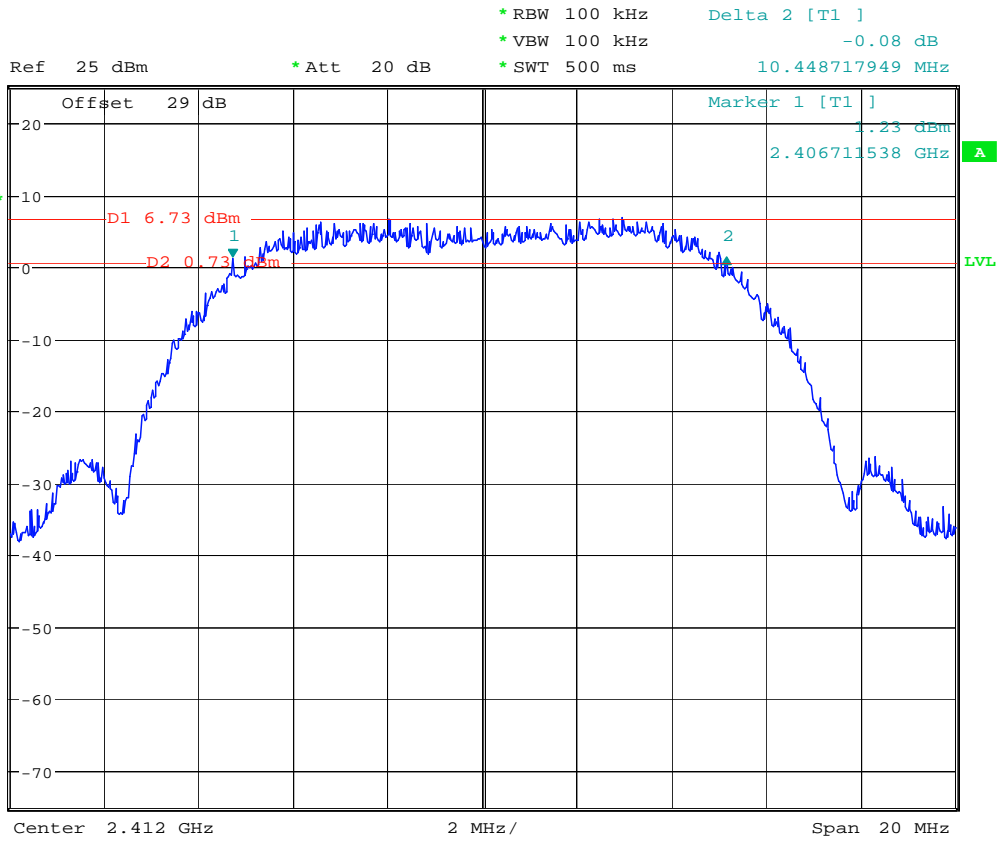

Date: 15.APR.2007 05:03:32



Mode 2

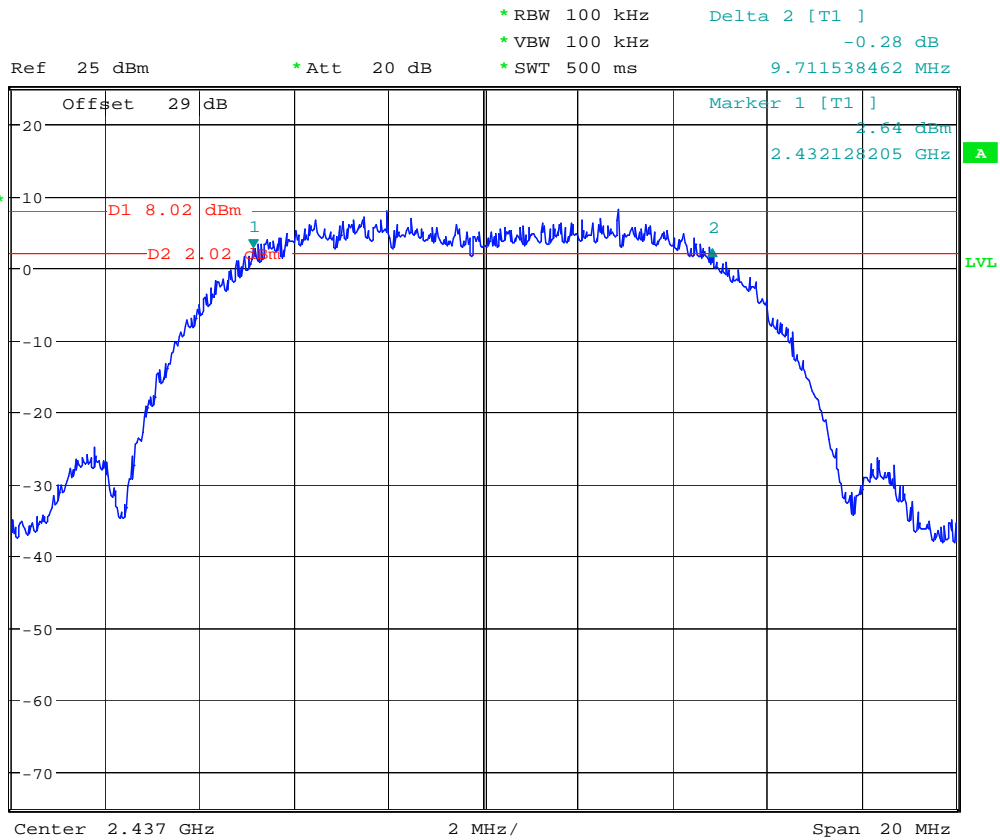

Date: 15.APR.2007 05:06:17



Mode 3



* RBW 100 kHz Delta 2 [T1]
 * VBW 100 kHz 0.55 dB
 * SWT 500 ms 9.775641026 MHz

Ref 25 dBm

* Att 20 dB

1 PK VIEW

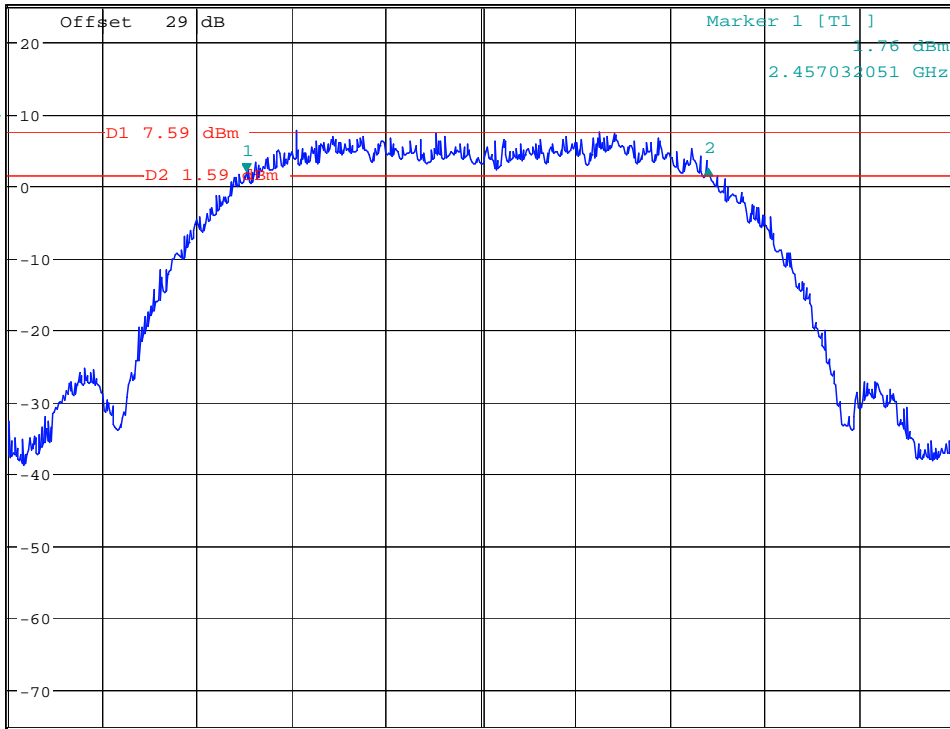

Center 2.462 GHz

2 MHz/

Span 20 MHz

Date: 15.APR.2007 05:08:28



Mode 4

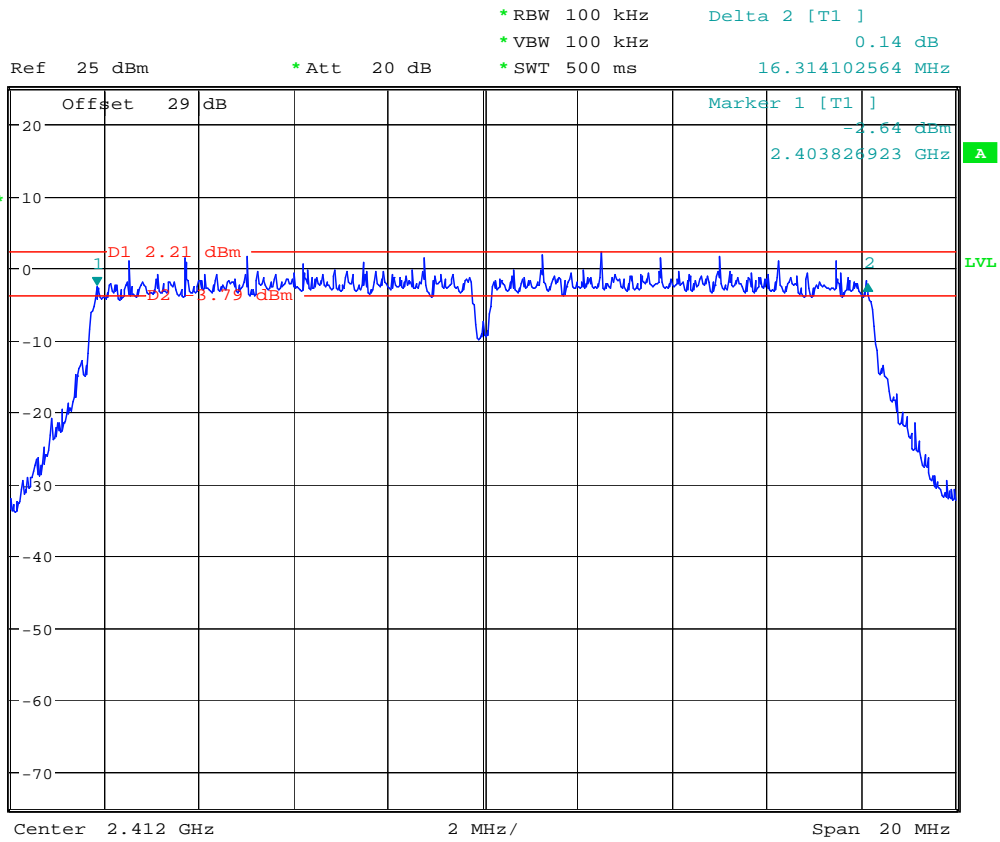

Date: 15.APR.2007 06:25:22



Mode 5

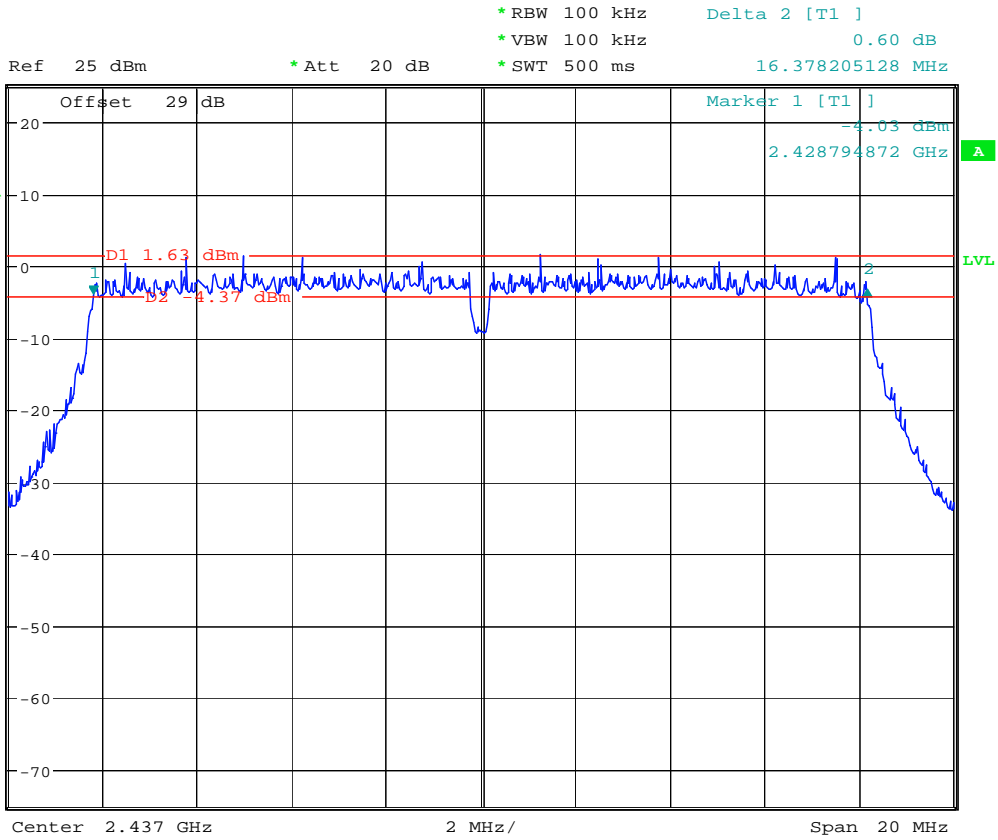

Date: 15.APR.2007 06:27:10



Mode 6

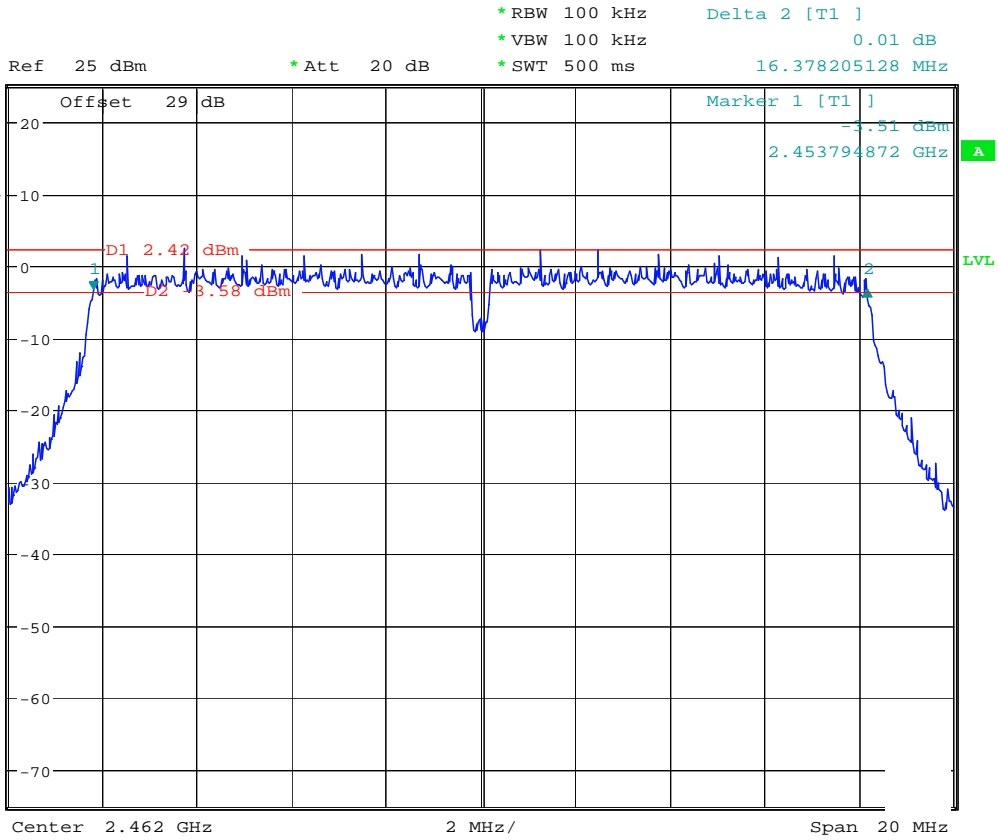

Date: 15.APR.2007 06:29:41

5.3 Power Spectral Density Measurement

5.3.1 Measuring Instruments :

As described in chapter 6 of this test report.

5.3.2 Test Procedure :

1. The transmitter output was connected to spectrum analyzer directly.
2. The spectrum analyzer's resolution bandwidth was set at 3kHz RBW and 30kHz VBW as that of the fundamental frequency. Set the sweep time=span/3kHz.
3. The power spectral density was measured and recorded.
4. The sweep time is allowed to be longer than span/3kHz for a full response of the mixer in the spectrum analyzer.

5.3.3 Test Setup Layout :

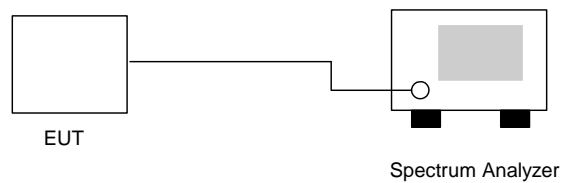



5.3.4 Test Result :

- Application Type : 802.11b/g
- Temperature : 25°C
- Relative Humidity : 53%
- Test Enginner : Tony

802.11b

Channel	Frequency (MHz)	Power Spectral Density (dBm)	Limits (dBm)	Plot Ref. No.
01	2412	-5.98	8	Mode 1
06	2437	-5.69	8	Mode 2
11	2462	-6.81	8	Mode 3

802.11g

Channel	Frequency (MHz)	Power Spectral Density (dBm)	Limits (dBm)	Plot Ref. No.
01	2412	-1.50	8	Mode 4
06	2437	-0.35	8	Mode 5
11	2462	-10.81	8	Mode 6



5.3.5 Power Spectral Density

Mode 1

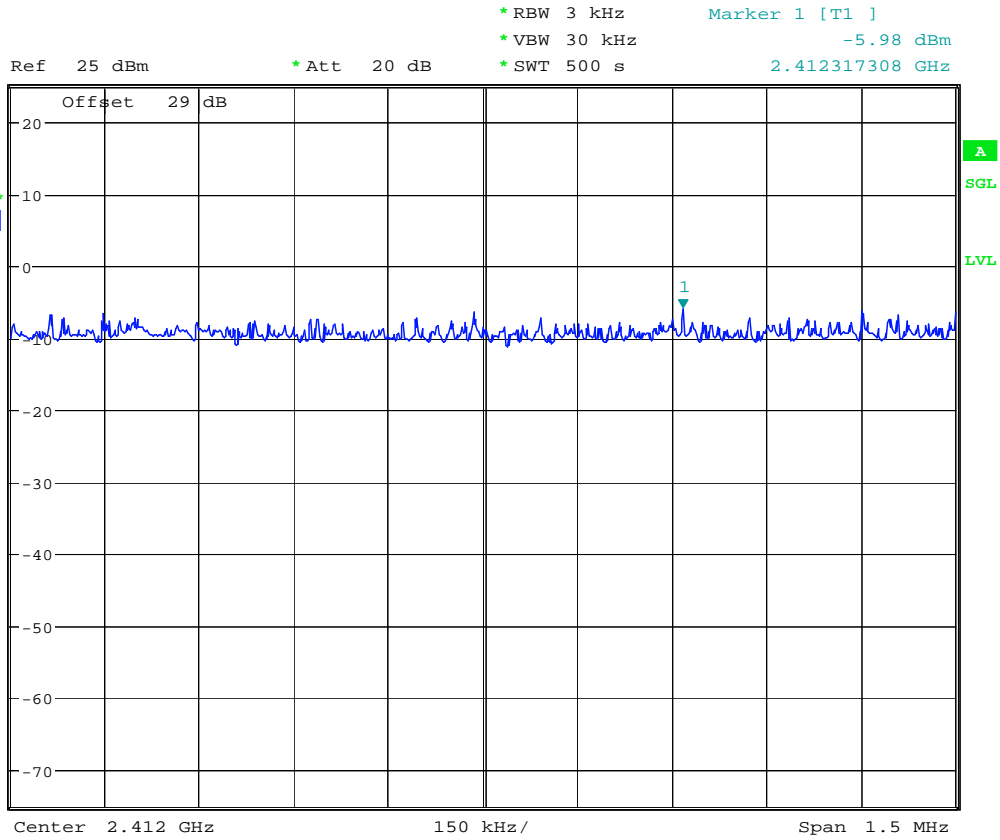

Date: 16.APR.2007 13:42:35



Mode 2



*RBW 3 kHz Marker 1 [T1]
*VBW 30 kHz -5.69 dBm
*SWT 500 s 2.437750000 GHz

Ref 25 dBm

*Att 20 dB

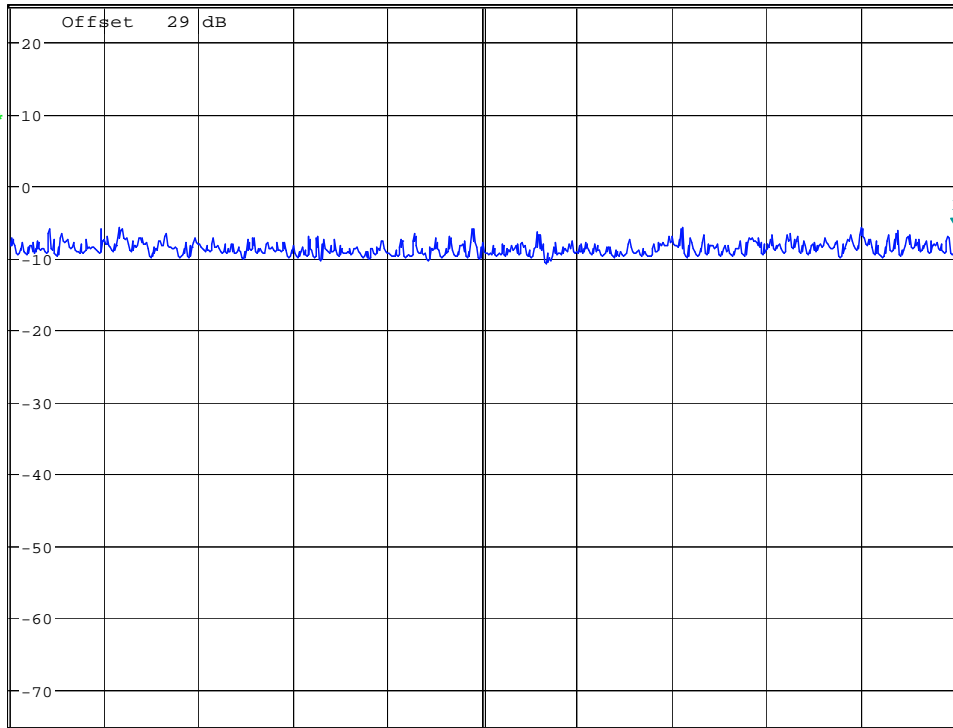

Center 2.437 GHz

150 kHz/

Span 1.5 MHz

Date: 16.APR.2007 13:55:10



Mode 3



*RBW 3 kHz Marker 1 [T1]
*VBW 30 kHz -6.81 dBm
*SWT 500 s 2.462314904 GHz

Ref 25 dBm

*Att 20 dB

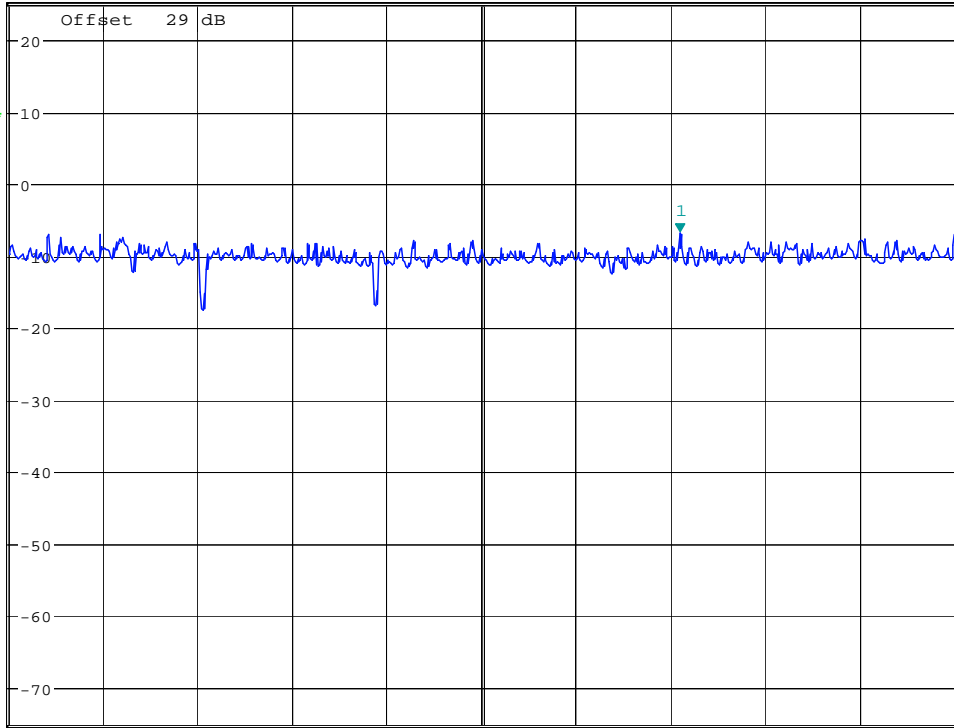

Center 2.462 GHz

150 kHz/

Span 1.5 MHz

Date: 16.APR.2007 14:07:48



Mode 4



*RBW 3 kHz Marker 1 [T1]
*VBW 30 kHz -1.50 dBm
*SWT 500 s 2.411985577 GHz

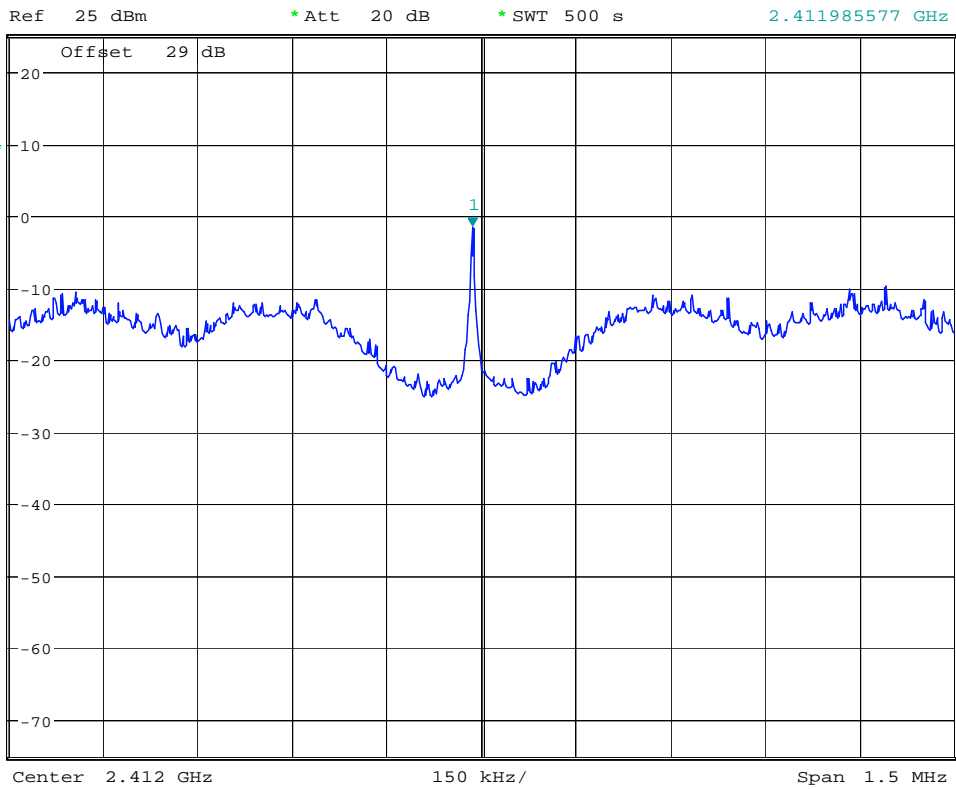

Date: 15.APR.2007 06:55:30



Mode 5



*RBW 3 kHz Marker 1 [T1]
*VBW 30 kHz -0.35 dBm
*SWT 500 s 2.436985577 GHz

Ref 25 dBm

*Att 20 dB

1 PK *
CLRWR

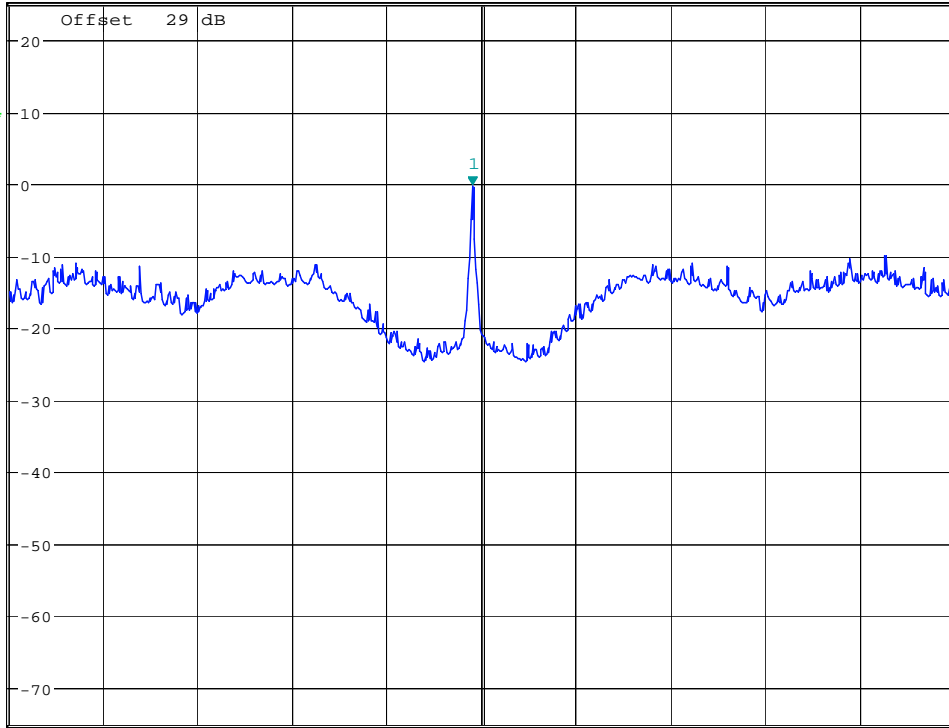

Center 2.437 GHz

150 kHz/

Span 1.5 MHz

Date: 15.APR.2007 07:07:58



Mode 6



*RBW 3 kHz Marker 1 [T1]
*VBW 30 kHz -10.81 dBm
*SWT 500 s 2.462639423 GHz

Ref 25 dBm

*Att 20 dB

1 PK *
CLRWR

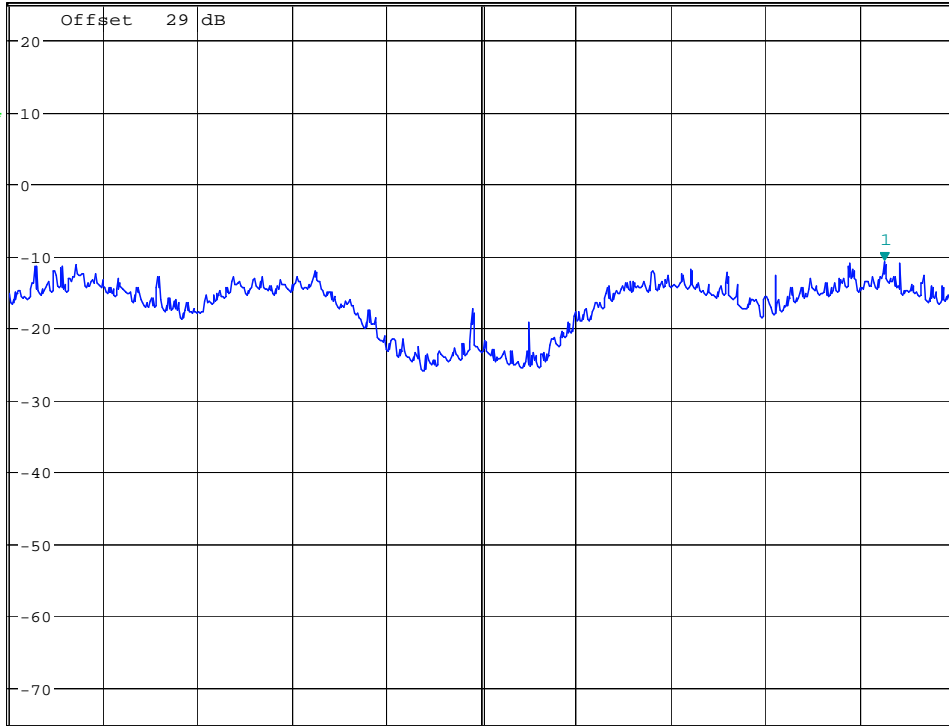

Date: 16.APR.2007 13:32:51



5.4 Band Edges Measurement

5.4.1 Measuring Instruments :

As described in chapter 6 of this test report.

5.4.2 Test Procedure :

1. The transmitter output was connected to the spectrum analyzer via a low lose cable.
2. Set both RBW and VBW of spectrum analyzer to 100kHz with suitable frequency span including 100 kHz bandwidth from band edge.
3. The band edges was measured and recorded.

5.4.3 Test Result :

- Application Type : WLAN 802.11b/g
- Temperature : 25°C
- Relative Humidity : 53%
- Test Enginner : Tony

- Test Result in WLAN lower band (Channel 1) : PASS
- Test Result in WLAN higher band (Channel 11) : PASS

5.4.4 Note on Band Edge Emission :

➤WLAN 802.11b

CH01 (Horizontal)

Frequency (MHz)	Level (dBuV/m)	Over Limit (dB)	Limit Line (dBuV/m)	Read Level (dBuV)	Abtebba Factor (dB/m)	Cable Loss (dB)	Preamp Factor (dB)	Ant Pos (cm)	Table Pos (deg)	Remark
2389.92	52.45	-21.55	74.00	53.90	30.26	3.75	35.46	100	0	Peak
2389.92	41.47	-12.53	54.00	42.92	30.26	3.75	35.46	100	60	Average

CH01 (Vertical)

Frequency (MHz)	Level (dBuV/m)	Over Limit (dB)	Limit Line (dBuV/m)	Read Level (dBuV)	Abtebba Factor (dB/m)	Cable Loss (dB)	Preamp Factor (dB)	Ant Pos (cm)	Table Pos (deg)	Remark
2389.52	59.93	-14.07	74.00	61.38	30.26	3.75	35.46	100	0	Peak
2389.52	46.52	-7.48	54.00	47.95	30.26	3.75	35.44	100	320	Average



CH11 (Horizontal)

Frequency (MHz)	Level (dBuV/m)	Over Limit (dB)	Limit Line (dBuV/m)	Read Level (dBuV)	Abtebba Factor (dB/m)	Cable Loss (dB)	Preamp Factor (dB)	Ant Pos (cm)	Table Pos (deg)	Remark
2483.62	60.26	-13.74	74.00	61.62	30.29	3.86	35.51	100	0	Peak
2483.62	44.34	-9.66	54.00	45.70	30.29	3.86	35.51	116	339	Average

CH11 (Vertical)

Frequency (MHz)	Level (dBuV/m)	Over Limit (dB)	Limit Line (dBuV/m)	Read Level (dBuV)	Abtebba Factor (dB/m)	Cable Loss (dB)	Preamp Factor (dB)	Ant Pos (cm)	Table Pos (deg)	Remark
2483.95	52.85	-21.15	74.00	54.21	30.29	3.86	35.51	100	0	Peak
2483.95	41.34	-12.66	54.00	42.70	30.29	3.86	35.51	100	159	Average

➤WLAN 802.11g

CH01 (Horizontal)

Frequency (MHz)	Level (dBuV/m)	Over Limit (dB)	Limit Line (dBuV/m)	Read Level (dBuV)	Abtebba Factor (dB/m)	Cable Loss (dB)	Preamp Factor (dB)	Ant Pos (cm)	Table Pos (deg)	Remark
2389.36	65.24	-8.76	74.00	66.69	30.26	3.75	35.46	100	0	Peak
2389.36	44.42	-9.58	54.00	45.85	30.26	3.75	35.44	115	35	Average

CH01 (Vertical)

Frequency (MHz)	Level (dBuV/m)	Over Limit (dB)	Limit Line (dBuV/m)	Read Level (dBuV)	Abtebba Factor (dB/m)	Cable Loss (dB)	Preamp Factor (dB)	Ant Pos (cm)	Table Pos (deg)	Remark
2388.96	57.03	-16.97	74.00	58.48	30.26	3.75	35.46	100	0	Peak
2388.96	39.86	-14.14	54.00	41.29	30.26	3.75	35.44	100	236	Average

CH11 (Horizontal)

Frequency (MHz)	Level (dBuV/m)	Over Limit (dB)	Limit Line (dBuV/m)	Read Level (dBuV)	Abtebba Factor (dB/m)	Cable Loss (dB)	Preamp Factor (dB)	Ant Pos (cm)	Table Pos (deg)	Remark
2483.53	60.20	-13.80	74.00	61.56	30.29	3.86	35.51	100	0	Peak
2483.53	42.93	-11.07	54.00	44.29	30.29	3.86	35.51	100	57	Average



CH11 (Vertical)

Frequency (MHz)	Level (dBuV/m)	Over Limit (dB)	Limit Line (dBuV/m)	Read Level (dBuV)	Abtebba Factor (dB/m)	Cable Loss (dB)	Preamp Factor (dB)	Ant Pos (cm)	Table Pos (deg)	Remark
2483.50	73.32	-0.68	74.00	74.68	30.29	3.86	35.51	100	0	Peak
2483.50	52.25	-1.75	54.00	53.61	30.29	3.86	35.51	100	314	Average



5.4.4 20dB Band Edge

WLAN 802.11b

CH01

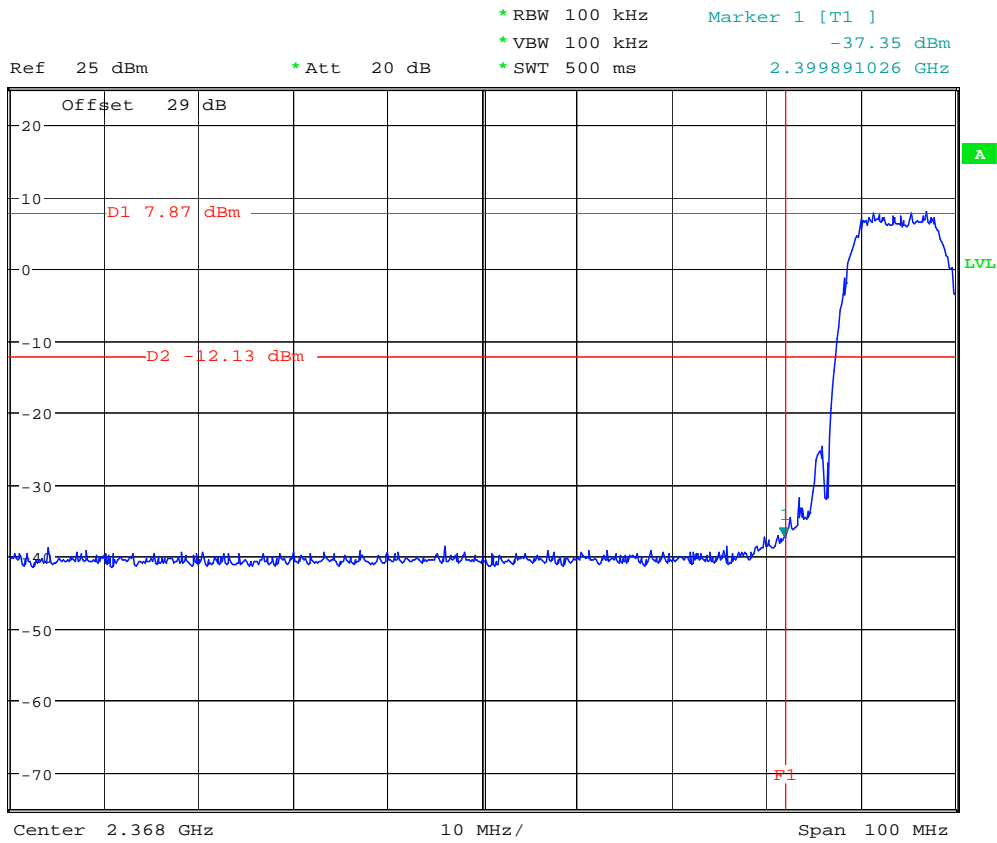

Date: 15.APR.2007 05:17:44



CH11

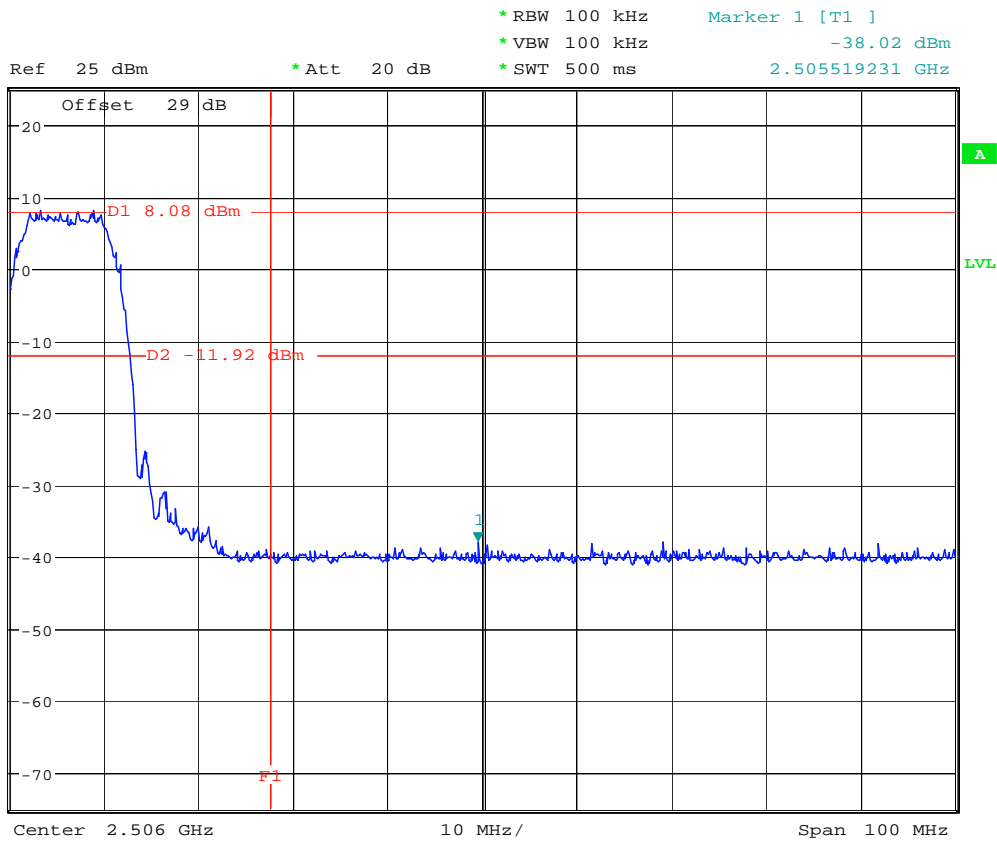

Date: 15.APR.2007 05:15:23



WLAN 802.11g

CH01

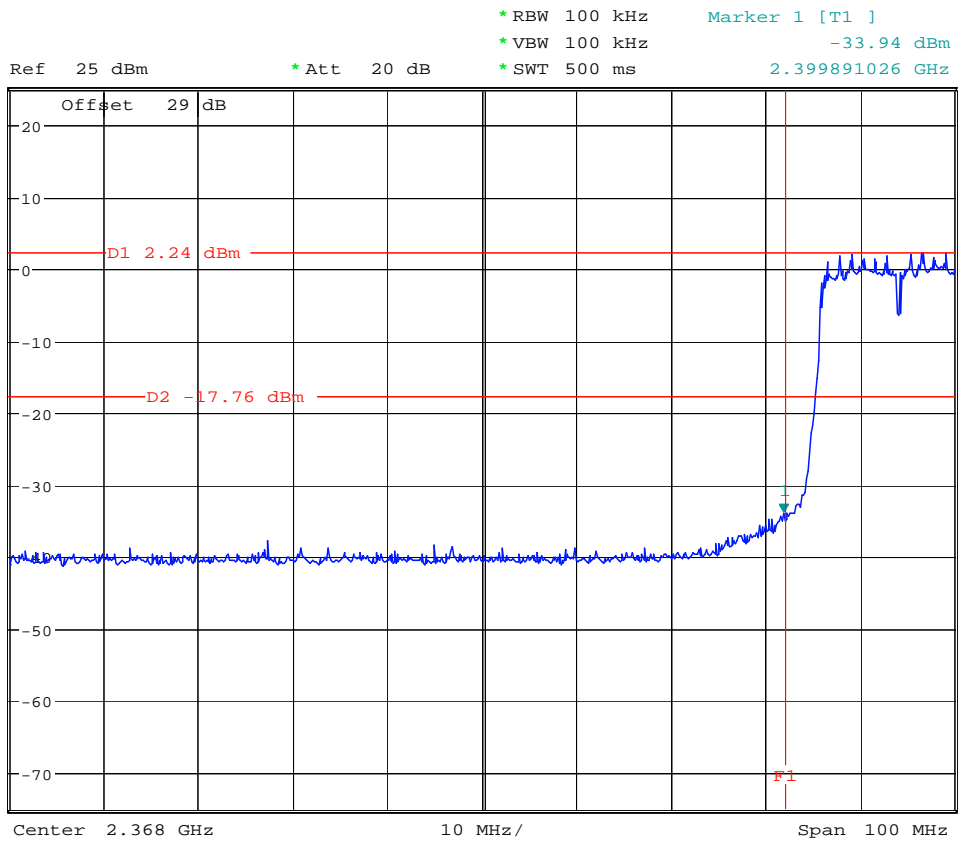

Date: 15.APR.2007 06:32:37



CH11



*RBW 100 kHz Marker 1 [T1]
*VBW 100 kHz -38.27 dBm
*SWT 500 ms 2.483564103 GHz

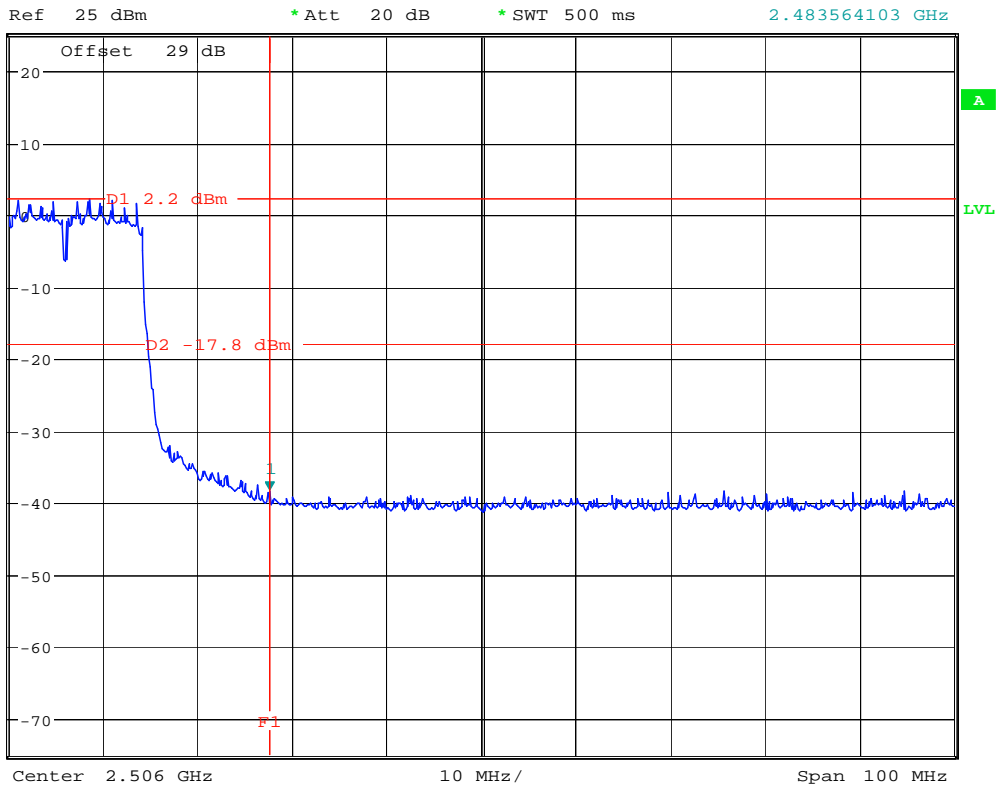

Date: 15.APR.2007 06:34:34

5.5 Peak Output Power Measurement

5.5.1 Measuring Instruments :

As described in chapter 6 of this test report.

5.5.2 Test Procedure :

1. The antenna port (RF output) of the EUT was connected to the input (RF input) of a power meter for WLAN measurement. The power is equal to the reading level on power meter plus cable loss at the EUT antenna terminal.
2. The antenna port(RF output) of the EUT was connected to the input (RF input) of a spectrum analyzer for BT measurement. The cable loss has been offset before testing.

5.5.3 Test Setup Layout :

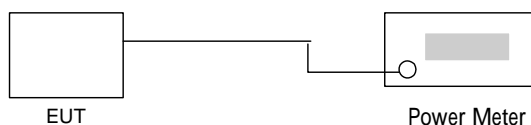

5.5.4 Test Result :

- Application Type : WLAN 802.11b/g
- Temperature : 25°C
- Relative Humidity : 53%
- Test Enginner : Tony

WLAN 802.11b

Channel	Frequency (MHz)	Measured Output Power (dBm)	Limits (Watt/dBm)
01	2412	20.48	1W/30 dBm
06	2437	20.59	1W/30 dBm
11	2462	21.03	1W/30 dBm

WLAN 802.11g

Channel	Frequency (MHz)	Measured Output Power (dBm)	Limits (Watt/dBm)
01	2412	21.33	1W/30 dBm
06	2437	22.62	1W/30 dBm
11	2462	21	1W/30 dBm



5.6 Conducted Emission

5.6.1 Measuring Instruments

As described in chapter 6 of this test Report.

5.6.2 Test Procedures :

- a. The EUT was placed 0.4 meter from the conducting wall of the shielding room was kept at least 80 centimeters from any other grounded conducting surface.
- b. Connect EUT to the power port of a line impedance stabilization network (LISN).
- c. All the support units are connected to the other LISN.
- d. The LISN provides 50 ohm coupling impedance for the measuring instrument.
- e. The FCC states that a 50 ohm, 50 microhenry LISN should be used.
- f. Both sides of AC line were checked for maximum conducted interference.
- g. The frequency range from 150 kHz to 30 MHz was searched.
- h. Set the test-receiver system to Peak Detect Function and specified bandwidth with Maximum Hold Mode.



5.6.3 Test Data

- Temperature : 24°C
- Relative Humidity : 52%
- Test Enginner : Sam
- Test Mode : Mode 1

The test that passed at minimum margin was marked by the frame in the following table.

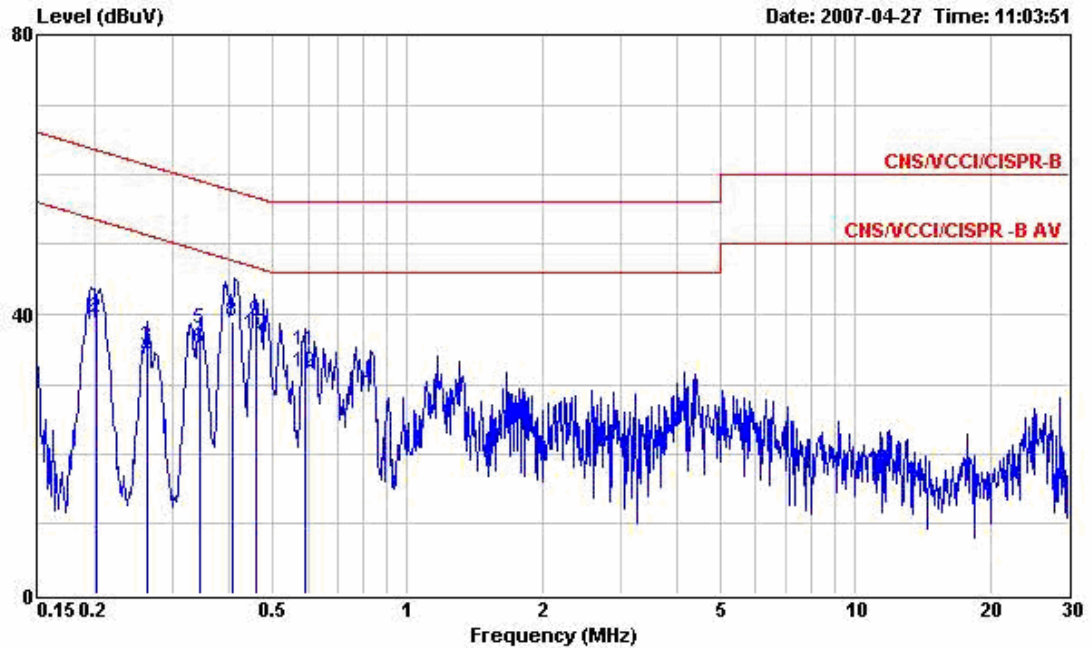

Site : CO01-HY
 Condition : CNS/VCCI/CISPR-B 2001/004 200604 LINE
 EUT : Adaptor B
 Power : 120V/60Hz
 Model : FD732603
 Memo :
 Memo : Sample A
 Memo :

	Freq	Level	Over	Limit	Read	Probe	Cable	
	MHz	dBuV	Limit	Line	Level	Factor	Loss	Remark
			dB	dBuV	dBuV	dB	dB	
1	0.201	38.84	-14.72	53.56	38.60	0.10	0.14	Average
2	0.201	39.54	-24.02	63.56	39.30	0.10	0.14	QP
3	0.262	35.34	-26.03	61.37	35.02	0.10	0.22	QP
4	0.262	33.80	-17.57	51.37	33.48	0.10	0.22	Average
5	0.345	37.83	-21.26	59.09	37.43	0.10	0.30	QP
6	0.345	34.99	-14.10	49.09	34.59	0.10	0.30	Average
7	0.408	38.81	-18.88	57.69	38.37	0.10	0.34	QP
8	0.408	38.84	-8.85	47.69	38.40	0.10	0.34	Average
9	0.460	38.97	-17.72	56.69	38.56	0.10	0.31	QP
10	0.460	37.07	-9.62	46.69	36.66	0.10	0.31	Average
11	0.589	34.69	-21.31	56.00	34.34	0.10	0.25	QP
12	0.589	31.77	-14.23	46.00	31.42	0.10	0.25	Average

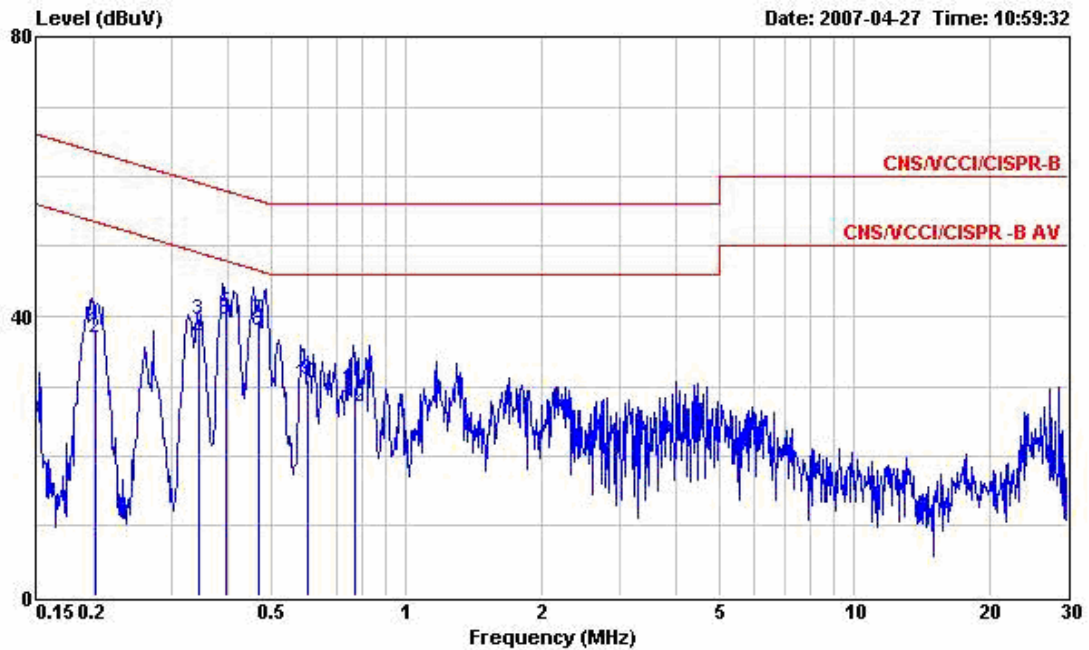

Site : CO01-HY
 Condition : CNS/VCCI/CISPR-B 2001/004 200604 NEUTRAL
 EUT : Adaptor B
 Power : 120V/60Hz
 Model : FD732603
 Memo :
 Memo : Sample A
 Memo :

	Freq	Level	Over Limit	Limit Line	Read Level	Probe Factor	Cable Loss	Remark
	MHz	dBuV	dB	dBuV	dBuV	dB	dB	
1	0.202	37.91	-25.62	63.53	37.67	0.10	0.14	QP
2	0.202	36.88	-16.65	53.53	36.64	0.10	0.14	Average
3	0.344	39.38	-19.72	59.10	38.98	0.10	0.30	QP
4	0.344	36.69	-12.41	49.10	36.29	0.10	0.30	Average
5	0.396	40.56	-17.38	57.94	40.12	0.10	0.34	QP
6	0.396	39.36	-8.58	47.94	38.92	0.10	0.34	Average
7	0.467	39.55	-17.01	56.56	39.15	0.10	0.30	QP
8	0.467	37.96	-8.60	46.56	37.56	0.10	0.30	Average
9	0.604	30.93	-25.07	56.00	30.59	0.10	0.24	QP
10	0.604	30.35	-15.65	46.00	30.01	0.10	0.24	Average
11	0.771	29.49	-26.51	56.00	29.21	0.10	0.18	QP
12	0.771	27.05	-18.95	46.00	26.77	0.10	0.18	Average



- Temperature : 24°C
- Relative Humidity : 48%
- Test Enginner : James
- Test Mode : Mode 2

The test that passed at minimum margin was marked by the frame in the following table.

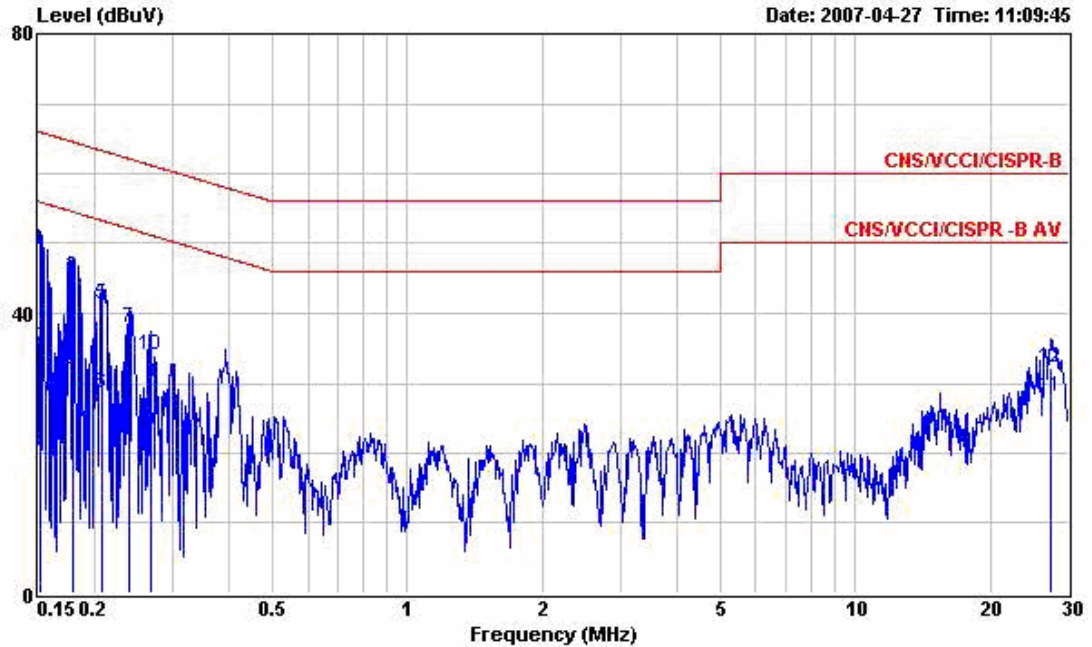

Site : CO01-HY
 Condition : CNS/VCCI/CISPR-B 2001/004 200604 LINE
 EUT : Adaptor B
 Power : 120V/60Hz
 Model : FD732603
 Memo :
 Memo : Sample A
 Memo :

	Freq	Level	Over Limit	Limit Line	Read Level	Probe Factor	Cable Loss	Remark
	MHz	dBuV	dB	dBuV	dBuV	dB	dB	
1	0.151	49.20	-16.74	65.94	48.98	0.10	0.12	QP
2	0.151	35.14	-20.80	55.94	34.92	0.10	0.12	Average
3	0.180	45.11	-19.38	64.49	44.88	0.10	0.13	QP
4	0.180	31.41	-23.08	54.49	31.18	0.10	0.13	Average
5	0.208	41.41	-21.87	63.28	41.16	0.10	0.15	QP
6	0.208	28.67	-24.61	53.28	28.42	0.10	0.15	Average
7	0.239	38.01	-24.12	62.13	37.72	0.10	0.19	QP
8	0.239	26.52	-25.61	52.13	26.23	0.10	0.19	Average
9	0.267	23.18	-28.03	51.21	22.86	0.10	0.22	Average
10	0.267	34.13	-27.08	61.21	33.81	0.10	0.22	QP
11	27.420	28.10	-21.90	50.00	27.36	0.55	0.19	Average
12	27.420	32.28	-27.72	60.00	31.54	0.55	0.19	QP

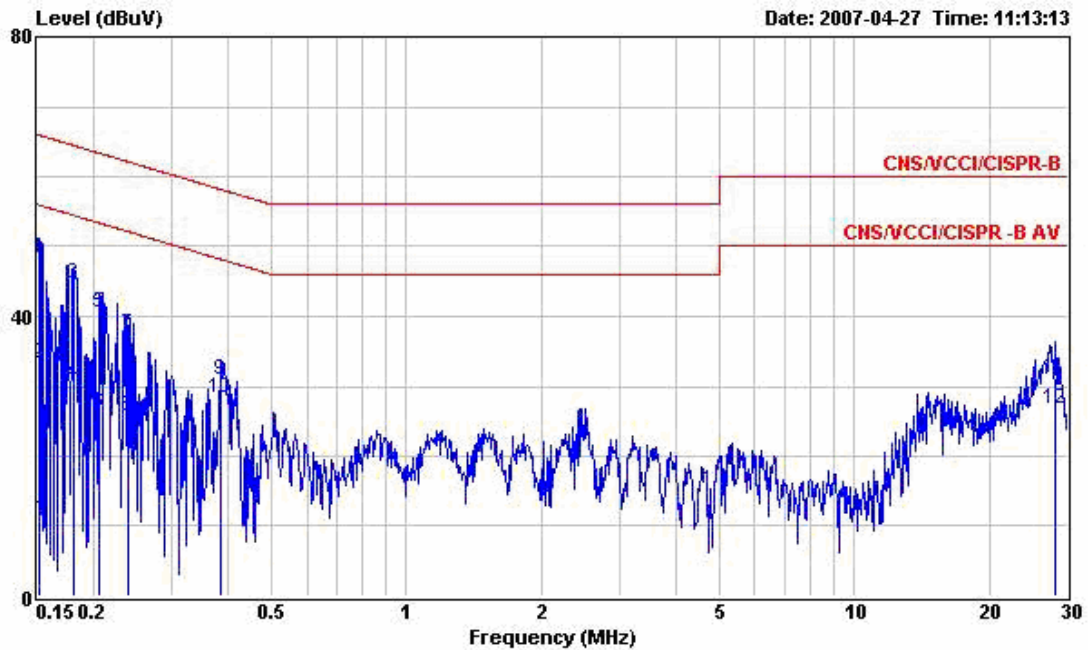

Site : CO01-HY
 Condition : CNS/VCCI/CISPR-B 2001/004 200604 NEUTRAL
 EUT : Adaptor B
 Power : 120V/60Hz
 Model : FD732603
 Memo :
 Memo : Sample A
 Memo :

	Freq	Level	Over Limit	Limit Line	Read Level	Probe Factor	Cable Loss	Remark
	MHz	dBuV	dB	dBuV	dBuV	dB	dB	
1	0.152	48.36	-17.53	65.89	48.14	0.10	0.12	QP
2	0.152	33.26	-22.63	55.89	33.04	0.10	0.12	Average
3	0.180	44.67	-19.81	64.48	44.44	0.10	0.13	QP
4	0.180	30.43	-24.05	54.48	30.20	0.10	0.13	Average
5	0.206	40.48	-22.89	63.37	40.23	0.10	0.15	QP
6	0.206	26.26	-27.11	53.37	26.01	0.10	0.15	Average
7	0.238	37.29	-24.86	62.15	37.00	0.10	0.19	QP
8	0.238	25.73	-26.42	52.15	25.44	0.10	0.19	Average
9	0.386	30.81	-27.33	58.14	30.38	0.10	0.33	QP
10	0.386	28.23	-19.91	48.14	27.80	0.10	0.33	Average
11	28.000	31.28	-28.72	60.00	30.40	0.69	0.19	QP
12	28.000	26.74	-23.26	50.00	25.86	0.69	0.19	Average



- Temperature : 24°C
- Relative Humidity : 48%
- Test Enginner : James
- Test Mode : Mode 3

The test that passed at minimum margin was marked by the frame in the following table.

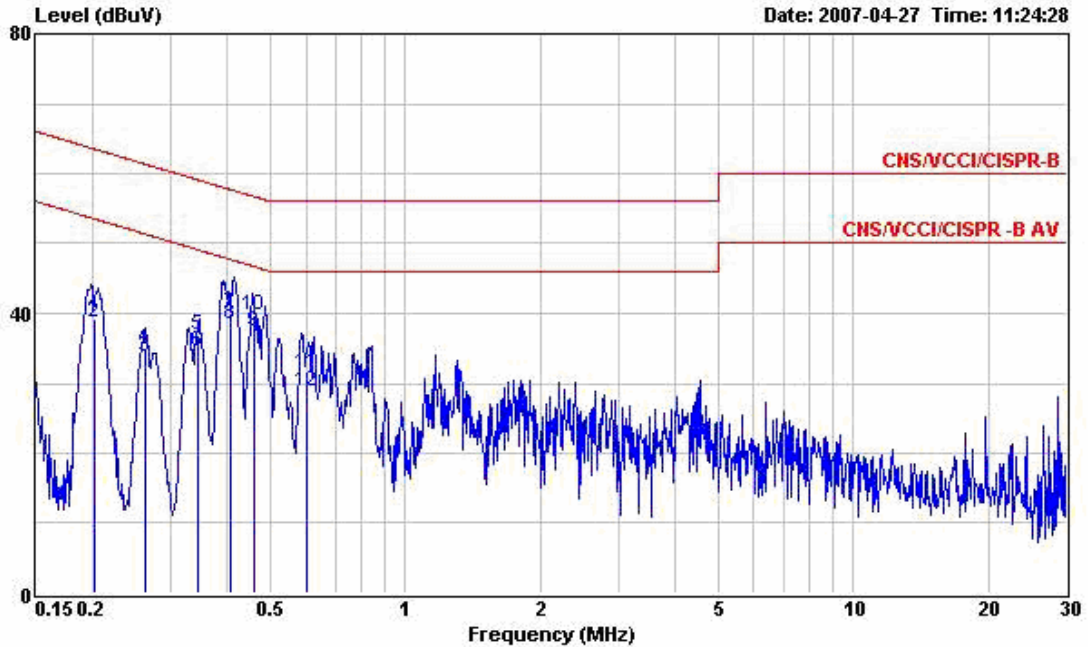

Site : CO01-HY
 Condition : CNS/VCCI/CISPR-B 2001/004 200604 LINE
 EUT : Adaptor B
 Power : 120V/60Hz
 Model : FD732603
 Memo :
 Memo : sample B
 Memo :

	Freq	Level	Over Limit	Limit Line	Read Level	Probe Factor	Cable Loss	Remark
	MHz	dBuV	dB	dBuV	dBuV	dB	dB	
1	0.202	39.30	-24.25	63.55	39.06	0.10	0.14	QP
2	0.202	38.68	-24.87	63.55	38.44	0.10	0.14	Average
3	0.263	33.86	-27.47	61.33	33.54	0.10	0.22	Average
4	0.263	35.11	-26.22	61.33	34.79	0.10	0.22	QP
5	0.343	36.88	-22.24	59.12	36.48	0.10	0.30	QP
6	0.343	34.61	-24.51	59.12	34.21	0.10	0.30	Average
7	0.406	39.95	-17.78	57.73	39.51	0.10	0.34	QP
8	0.406	38.32	-19.41	57.73	37.88	0.10	0.34	Average
9	0.459	37.41	-19.31	56.72	37.00	0.10	0.31	Average
10	0.459	39.65	-17.07	56.72	39.24	0.10	0.31	QP
11	0.600	31.39	-24.61	56.00	31.05	0.10	0.24	QP
12	0.600	28.83	-27.17	56.00	28.49	0.10	0.24	Average

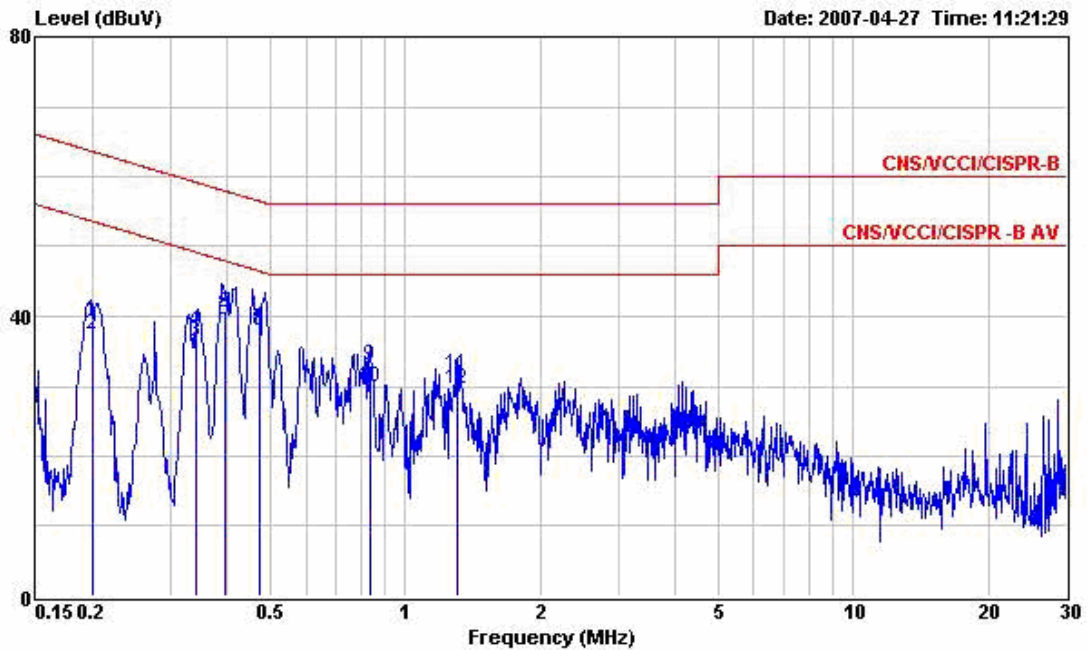

Site : CO01-HY
 Condition : CNS/VCCI/CISPR-B 2001/004 200604 NEUTRAL
 EUT : Adaptor B
 Power : 120V/60Hz
 Model : FD732603
 Memo :
 Memo : sample B
 Memo :

	Freq	Level	Over Limit	Limit Line	Read Level	Probe Factor	Cable Loss	Remark
	MHz	dBuV	dB	dBuV	dBuV	dB	dB	
1	0.200	39.26	-24.34	63.60	39.02	0.10	0.14	QP
2	0.200	37.38	-16.22	53.60	37.14	0.10	0.14	Average
3	0.342	36.42	-12.72	49.14	36.02	0.10	0.30	Average
4	0.342	37.97	-21.17	59.14	37.57	0.10	0.30	QP
5	0.397	40.54	-17.38	57.92	40.10	0.10	0.34	QP
6	0.397	39.56	-8.36	47.92	39.12	0.10	0.34	Average
7	0.471	38.26	-18.24	56.50	37.86	0.10	0.30	QP
8	0.471	37.81	-8.69	46.50	37.41	0.10	0.30	Average
9	0.834	33.01	-22.99	56.00	32.75	0.10	0.16	QP
10	0.834	29.98	-16.02	46.00	29.72	0.10	0.16	Average
11	1.300	31.63	-24.37	56.00	31.34	0.10	0.19	QP
12	1.300	29.55	-16.45	46.00	29.26	0.10	0.19	Average



5.7 Radiated Emission Measurement

5.7.1 Measuring Instruments

As described in chapter 6 of this Report.

5.7.2 Test Procedures

- a. The EUT was placed on a rotatable table top 0.8 meter above ground.
- b. The EUT was set 3 meters from the interference receiving antenna which was mounted on the top of a variable height antenna tower.
- c. The table was rotated 360 degrees to determine the position of the highest radiation.
- d. The antenna is a broadband antenna and its height is varied between one meter and four meters above ground to find the maximum value of the field strength for both horizontal polarization and vertical polarization of the antenna.
- e. For each suspected emission, the EUT was arranged to its worst case and then tune the antenna tower (from 1 m to 4 m) and turntable (from 0 degree to 360 degrees) to find the maximum reading.
- f. Set the test-receiver system to Peak or CISPR quasi-peak Detect Function and specified bandwidth with Maximum Hold Mode.
- g. For testing below 1GHz, If the emission level of the EUT in peak mode was 3 dB lower than the limit specified, then testing will be stopped and peak values of EUT will be reported, otherwise, the emissions will be repeated one by one using the quasi-peak method and reported.
- h. For testing above 1GHz, the emission level of the EUT in peak mode was 20dB lower than average limit (that means the emission level in average mode also complies with the limit in average mode), then testing will be stopped and peak values of EUT will be reported, otherwise, the emissions will be measured in average mode again and reported.

5.7.3 Typical Test Setup Layout of Radiated Emission

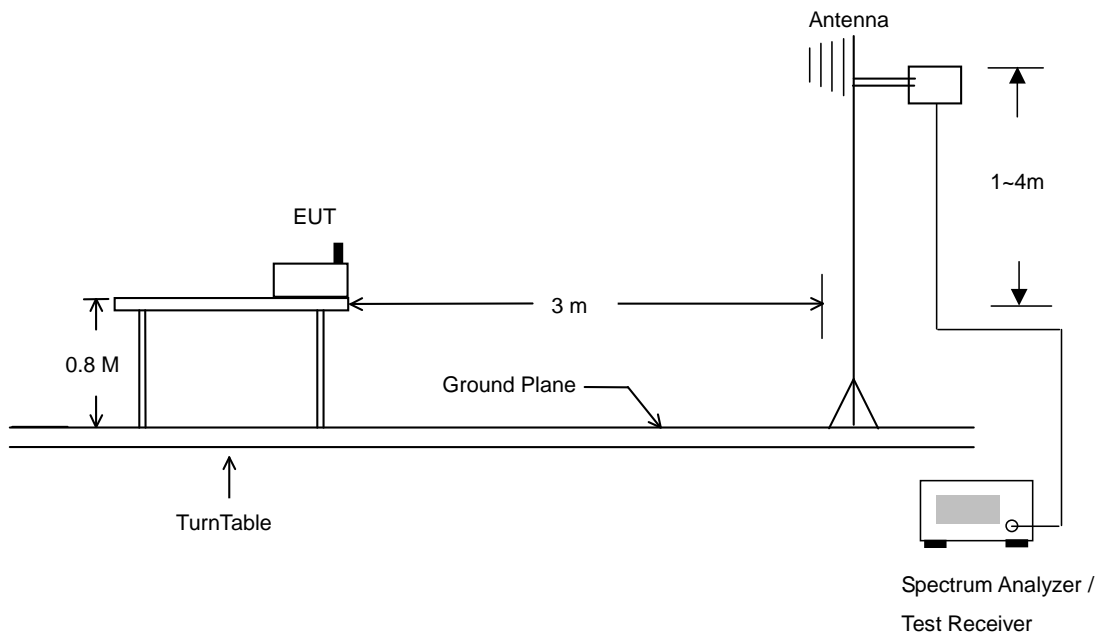



5.7.4 Test Data

- Temperature : 25°C
- Relative Humidity : 53%
- Test Enginner : Andrew
- Test Mode : Mode 1
- Polarization : Horizontal

The test that passed at minimum margin was marked by the frame in the following table.



Trace: (Discrete)
 Condition : LF-ANT(951121) HORIZONTAL
 EUT : AP/Router
 Power : 120Vac/60Hz
 Model : FR 732603
 Mode : WLAN 11b_Tx_Ch01;2412MHz
 Data Rate : 11

	Freq	Level	Over Limit	Limit Line	ReadAntenna Level	Antenna Factor	Cable Loss	Preamp Factor	Ant Pos	Table Pos	Remark
	MHz	dBuV/m	dB	dBuV/m	dBuV	dB/m	dB	dB	cm	deg	
1	119.64	28.01	-15.49	43.50	44.96	12.50	1.63	31.08	---	---	Peak
2	239.79	33.98	-12.02	46.00	50.95	11.64	2.32	30.93	---	---	Peak
3 @	299.73	37.03	-8.97	46.00	52.12	13.21	2.63	30.93	---	---	Peak



Data: 2 File: D:\Project\2007Q2\項目\732603\Part 15C\11b\11b_Tx_Ch01;2412MHz.EMI (18) Date: 2007-04-13

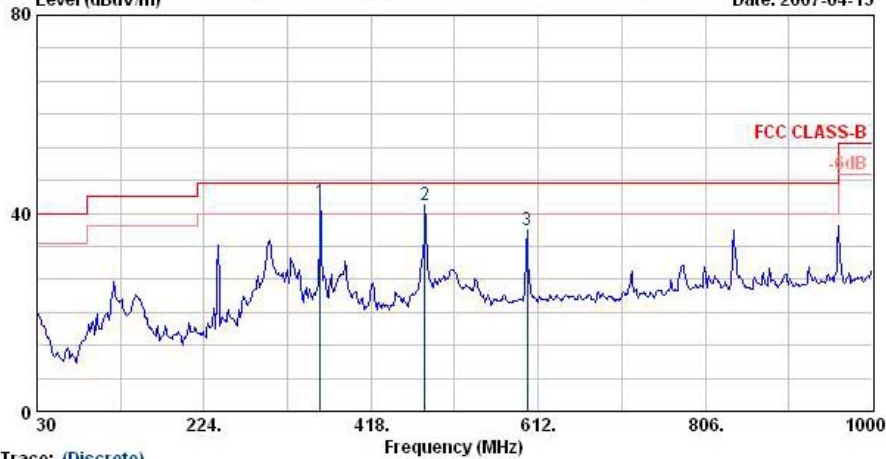

Trace: (Discrete)
 Condition : LF-ANT(951121) HORIZONTAL
 EUT : AP/Router
 Power : 120Vac/60Hz
 Model : FR 732603
 Mode : WLAN 11b_Tx_Ch01;2412MHz
 Data Rate : 11

	Freq	Level	Over Limit	Limit Line	ReadAntenna Level	Antenna Factor	Cable Loss	Preamp Factor	Ant Pos	Table Pos	Remark
	MHz	dBuV/m	dB	dBuV/m	dBuV	dB/m	dB	dB	cm	deg	
1 @	358.83	42.13	-3.87	46.00	55.40	14.72	2.90	30.89	100	233	QP
2 @	480.08	41.60	-4.40	46.00	51.87	17.09	3.45	30.81	---	---	Peak
3	599.39	36.62	-9.38	46.00	44.95	18.46	3.87	30.66	---	---	Peak

Data: 3 File: D:\Project\2007Q2\項目\732603\Part 15C\11b\11b_Tx_Ch01;2412MHz.EMI (18) Date: 2007-04-13

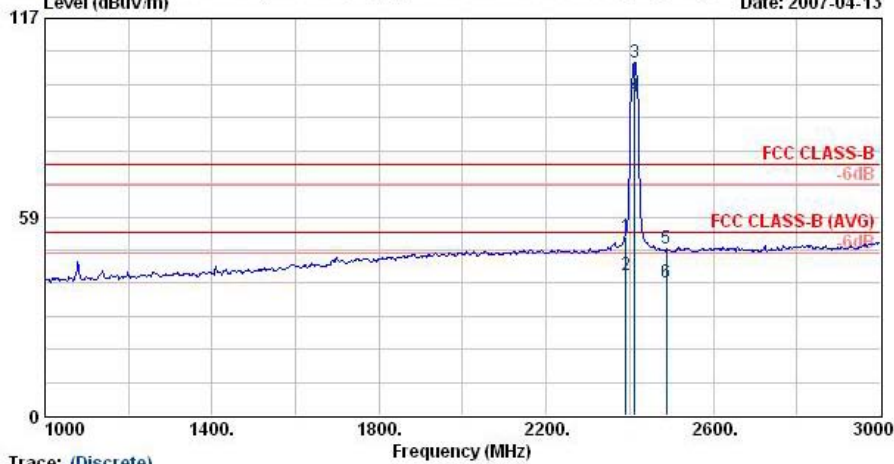

Trace: (Discrete)
 Condition : HF-ANT-060410 HORIZONTAL
 EUT : AP/Router
 Power : 120Vac/60Hz
 Model : FR 732603
 Mode : WLAN 11b_Tx_Ch01;2412MHz
 Data Rate : 11

	Freq	Level	Over Limit	Limit Line	ReadAntenna Level	Antenna Factor	Cable Loss	Preamp Factor	Ant Pos	Table Pos	Remark
	MHz	dBuV/m	dB	dBuV/m	dBuV	dB/m	dB	dB	cm	deg	
1	2389.92	52.45	-21.55	74.00	53.90	30.26	3.75	35.46	100	0	Peak
2	2389.92	41.47	-12.53	54.00	42.92	30.26	3.75	35.46	100	60	Average
3 @	2412.00	103.96			105.38	30.27	3.77	35.46	100	0	Peak
4 @	2412.00	93.93			95.35	30.27	3.77	35.46	100	60	Average
5	2488.00	48.97	-25.03	74.00	50.32	30.30	3.86	35.51	100	0	Peak
6	2488.00	39.24	-14.76	54.00	40.59	30.30	3.86	35.51	100	60	Average

Remark: #3 and #4 Fundamental Signal



FCC/IC TEST REPORT

Report No. : FR732603

Data: 4 File: D:\Project\2007Q2\項目\732603\Part 15C\11b\11b_Tx_Ch01;2412MHz.EMI (18) Date: 2007-04-14

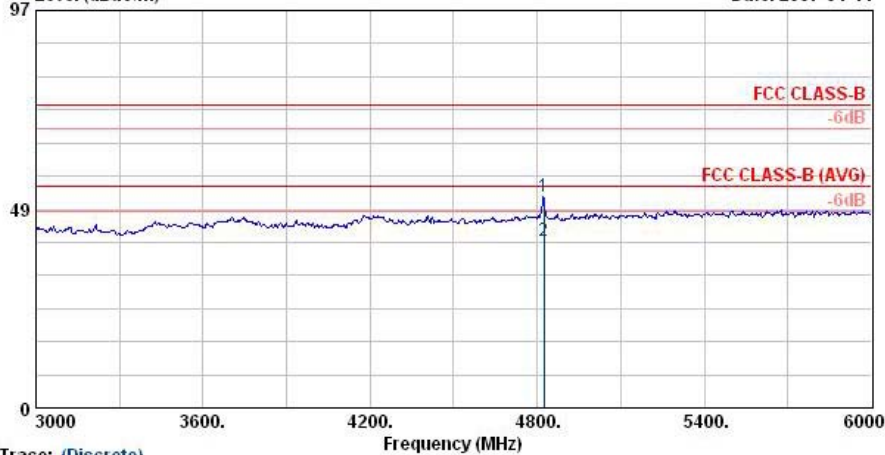

Trace: (Discrete)
 Condition : HF-ANT-060410 HORIZONTAL
 EUT : AP/Router
 Power : 120Vac/60Hz
 Model : FR 732603
 Mode : WLAN 11b_Tx_Ch01;2412MHz
 Data Rate : 11

	Freq	Level	Over Limit	Limit Line	ReadAntenna Level	Antenna Factor	Cable Loss	Preamp Factor	Ant Pos	Table Pos	Remark
	MHz	dBuV/m	dB	dBuV/m	dBuV	dB/m	dB	dB	cm	deg	
1	4824.00	51.49	-22.51	74.00	48.82	32.94	5.84	36.12	100	0	Peak
2	4824.00	40.87	-13.13	54.00	38.20	32.94	5.84	36.12	100	57	Average

Data: 5 File: D:\Project\2007Q2\項目\732603\Part 15C\11b\11b_Tx_Ch01;2412MHz.EMI (18) Date: 2007-04-14

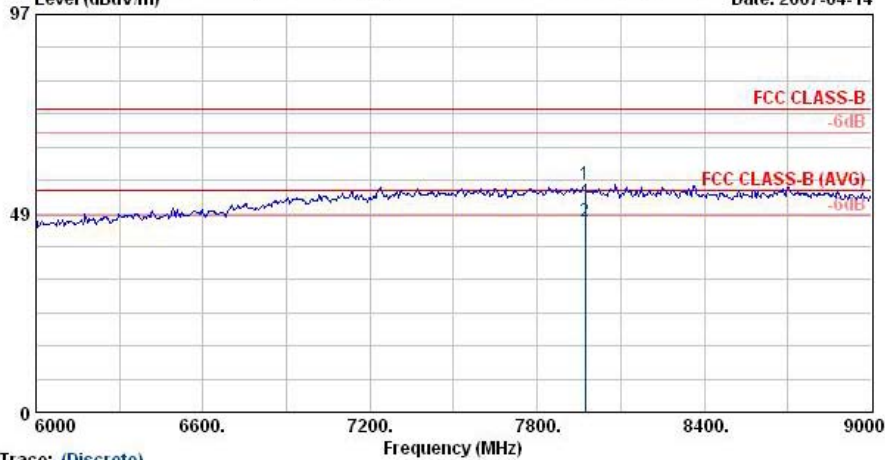

Trace: (Discrete)
 Condition : HF-ANT-060410 HORIZONTAL
 EUT : AP/Router
 Power : 120Vac/60Hz
 Model : FR 732603
 Mode : WLAN 11b_Tx_Ch01;2412MHz
 Data Rate : 11

	Freq	Level	Over Limit	Limit Line	ReadAntenna Level	Antenna Factor	Cable Loss	Preamp Factor	Ant Pos	Table Pos	Remark
	MHz	dBuV/m	dB	dBuV/m	dBuV	dB/m	dB	dB	cm	deg	
1	7971.00	55.52	-18.48	74.00	44.05	39.55	7.78	35.86	100	0	Peak
2 @	7971.00	46.68	-7.32	54.00	35.20	39.55	7.78	35.86	100	304	Average



Data: 6 File: D:\Project\2007Q2\環程\732603\Part 15C\11b\11b_Tx_Ch01;2412MHz.EMI (18) Date: 2007-04-14

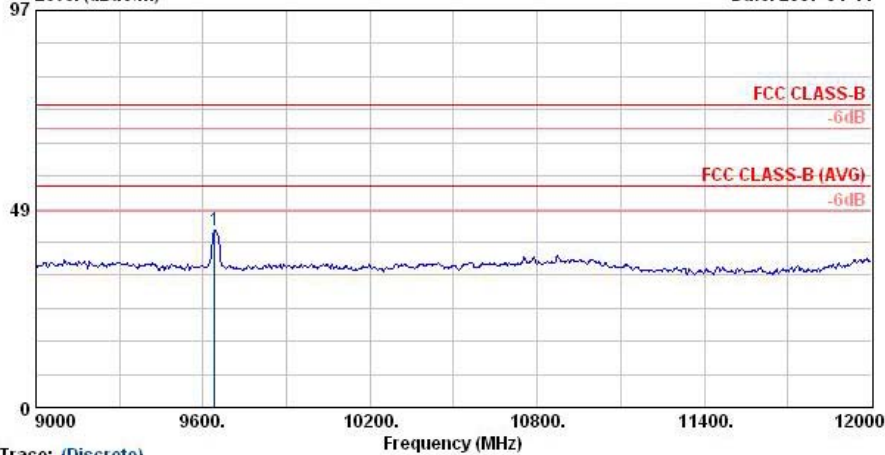

Trace: (Discrete)
 Condition : HF-ANT(8-18)-060918 HORIZONTAL
 EUT : AP/Router
 Power : 120Vac/60Hz
 Model : FR 732603
 Mode : WLAN 11b_Tx_Ch01;2412MHz
 Data Rate : 11

	Freq	Level	Over Limit	Limit Line	ReadAntenna Level	Antenna Factor	Cable Loss	Preamp Factor	Ant Pos	Table Pos	Remark
	MHz	dBuV/m	dB	dBuV/m	dBuV	dB/m	dB	dB	cm	deg	
1	9642.00	43.44	-30.56	74.00	81.09	-10.09	9.12	36.68	---	---	Peak

Data: 7 File: D:\Project\2007Q2\環程\732603\Part 15C\11b\11b_Tx_Ch01;2412MHz.EMI (18) Date: 2007-04-14

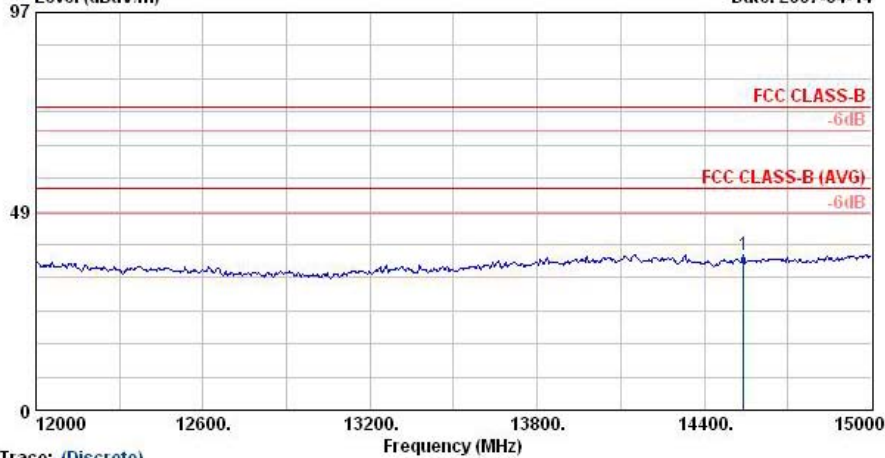

Trace: (Discrete)
 Condition : HF-ANT(8-18)-060918 HORIZONTAL
 EUT : AP/Router
 Power : 120Vac/60Hz
 Model : FR 732603
 Mode : WLAN 11b_Tx_Ch01;2412MHz
 Data Rate : 11

	Freq	Level	Over Limit	Limit Line	ReadAntenna Level	Antenna Factor	Cable Loss	Preamp Factor	Ant Pos	Table Pos	Remark
	MHz	dBuV/m	dB	dBuV/m	dBuV	dB/m	dB	dB	cm	deg	
1	14541.00	37.99	-36.01	74.00	68.41	-6.57	11.69	35.55	---	---	Peak



Data: 8 File: D:\Project\2007Q2\項目732603\Part 15C\11b\11b_Tx_Ch01;2412MHz.EMI (18) Date: 2007-04-14

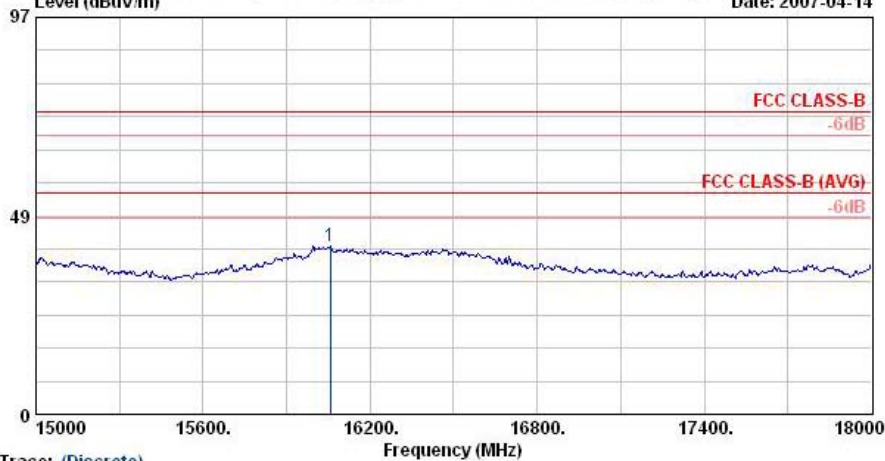

Trace: (Discrete)
 Condition : HF-ANT(6-16)-060918 HORIZONTAL
 EUT : AP/Router
 Power : 120Vac/60Hz
 Model : FR 732603
 Mode : WLAN 11b_Tx_Ch01;2412MHz
 Data Rate : 11

	Freq	Level	Over Limit	Limit Line	Read Level	Antenna Factor	Cable Loss	Preamp Factor	Ant Pos	Table Pos	Remark
	MHz	dBuV/m	dB	dBuV/m	dBuV	dB/m	dB	dB	cm	deg	
1	16056.00	41.02	-32.98	74.00	69.71	-4.64	11.78	35.83	---	---	Peak

Data: 17 File: D:\Project\2007Q2\項目732603\Part 15C\11b\11b_Tx_Ch01;2412MHz.EMI (18) Date: 2007-04-13

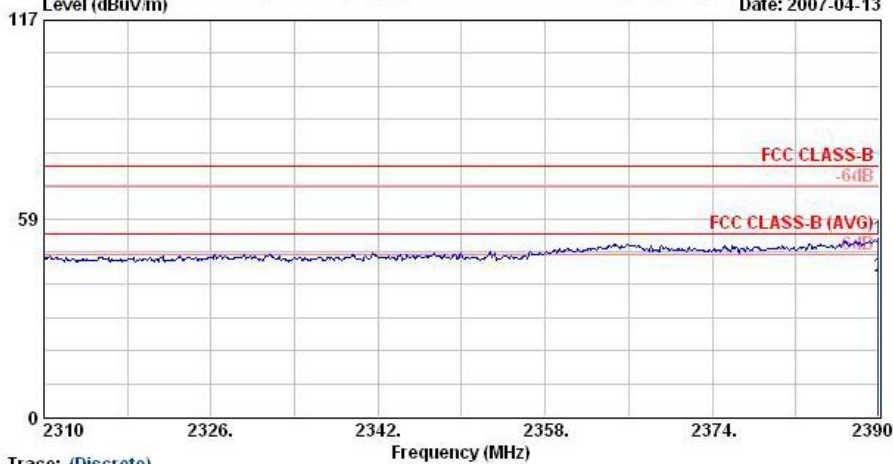

Trace: (Discrete)
 Condition : HF-ANT-060410 HORIZONTAL
 EUT : AP/Router
 Power : 120Vac/60Hz
 Model : FR 732603
 Mode : WLAN 11b_Tx_Ch01;2412MHz
 Data Rate : 11

	Freq	Level	Over Limit	Limit Line	Read Level	Antenna Factor	Cable Loss	Preamp Factor	Ant Pos	Table Pos	Remark
	MHz	dBuV/m	dB	dBuV/m	dBuV	dB/m	dB	dB	cm	deg	
1	2389.92	52.45	-21.55	74.00	53.90	30.26	3.75	35.46	100	0	Peak
2	2389.92	41.47	-12.53	54.00	42.92	30.26	3.75	35.46	100	60	Average



- Polarization : Vertical

The test that passed at minimum margin was marked by the frame in the following table.

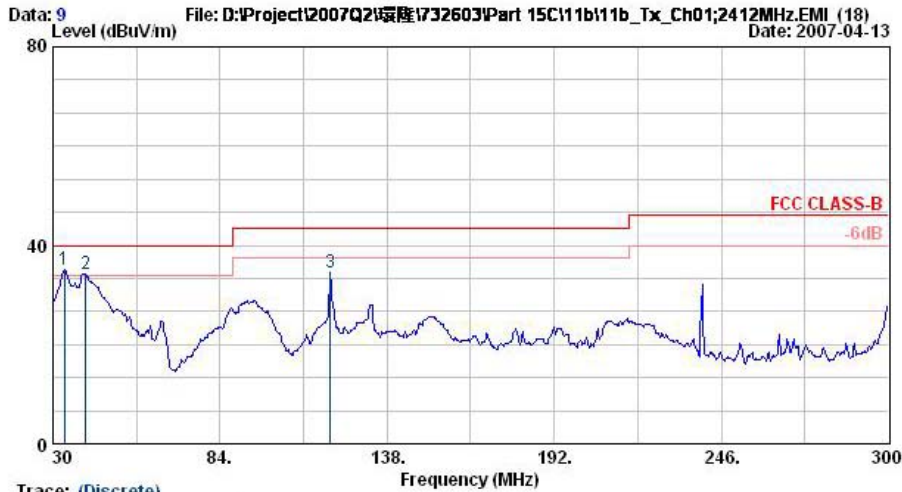

Trace: (Discrete)
 : LF-ANT(951121) VERTICAL
 : AP/Router
 Power : 120Vac/60Hz
 Model : FR 732603
 Mode : WLAN 11b_Tx_Ch01;2412MHz
 Data Rate : 11

	Freq	Level	Over	Limit	Read	Antenna	Cable	Preamp	Ant	Table	Remark
	MHz	dBuV/m	Limit	Line	Level	Factor	Loss	Factor	Pos	Pos	
			dB	dBuV/m	dBuV	dB/m	dB	dB	cm	deg	
1 @	33.78	35.24	-4.76	40.00	48.85	16.84	0.87	31.32	100	198	Peak
2 @	40.53	34.19	-5.81	40.00	51.45	13.01	0.92	31.19	---	---	Peak
3	119.64	34.44	-9.06	43.50	51.38	12.50	1.63	31.08	---	---	Peak

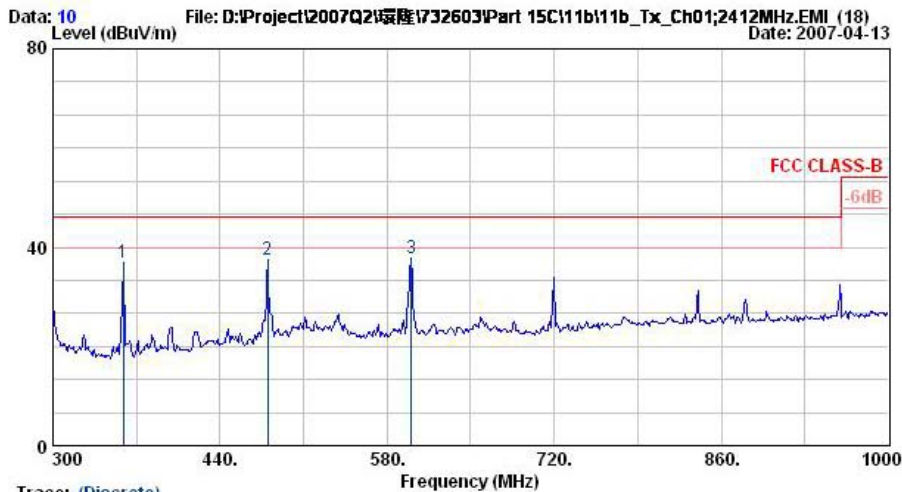

Trace: (Discrete)
 : LF-ANT(951121) VERTICAL
 : AP/Router
 Power : 120Vac/60Hz
 Model : FR 732603
 Mode : WLAN 11b_Tx_Ch01;2412MHz
 Data Rate : 11

	Freq	Level	Over	Limit	Read	Antenna	Cable	Preamp	Ant	Table	Remark
	MHz	dBuV/m	Limit	Line	Level	Factor	Loss	Factor	Pos	Pos	
			dB	dBuV/m	dBuV	dB/m	dB	dB	cm	deg	
1	358.80	36.75	-9.25	46.00	50.03	14.72	2.90	30.89	---	---	Peak
2 @	479.90	37.48	-8.52	46.00	47.75	17.09	3.45	30.81	---	---	Peak
3 @	600.30	37.91	-8.09	46.00	46.23	18.47	3.87	30.66	---	---	Peak



FCC/IC TEST REPORT

Report No. : FR732603

Data: 11 File: D:\Project\2007Q2\Report\732603\Part 15C\11b\11b_Tx_Ch01;2412MHz.EMI (18) Level (dBuV/m) Date: 2007-04-13

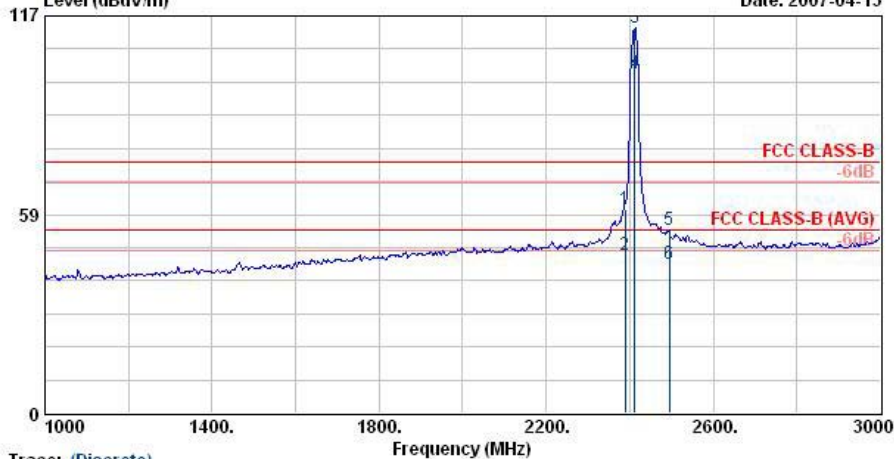

Trace: (Discrete)
 Condition : HF-ANT-060410 VERTICAL
 EUT : AP/Router
 Power : 120Vac/60Hz
 Model : FR 732603
 Mode : WLAN 11b_Tx_Ch01;2412MHz
 Data Rate : 11

	Freq	Level	Over Limit	Limit Line	Read Level	Antenna Factor	Cable Loss	Preamp Factor	Ant Pos	Table Pos	Remark
	MHz	dBuV/m	dB	dBuV/m	dBuV	dB/m	dB	dB	cm	deg	
1	2389.52	59.93	-14.07	74.00	61.38	30.26	3.75	35.46	100	0	Peak
2 @	2389.52	46.52	-7.48	54.00	47.95	30.26	3.75	35.44	100	320	Average
3 @	2412.00	113.43			114.85	30.27	3.77	35.46	100	0	Peak
4 @	2412.00	99.88			101.30	30.27	3.77	35.46	100	320	Average
5	2494.00	53.82	-20.18	74.00	55.17	30.30	3.88	35.53	100	0	Peak
6	2494.00	43.95	-10.05	54.00	45.30	30.30	3.88	35.53	100	320	Average

Remark: #3 and #4 Fundamental Signal

Data: 12 File: D:\Project\2007Q2\Report\732603\Part 15C\11b\11b_Tx_Ch01;2412MHz.EMI (18) Level (dBuV/m) Date: 2007-04-14

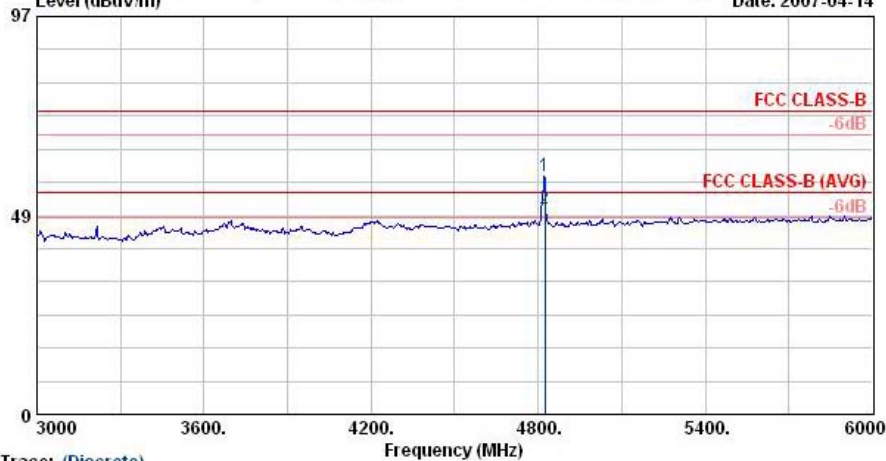

Trace: (Discrete)
 Condition : HF-ANT-060410 VERTICAL
 EUT : AP/Router
 Power : 120Vac/60Hz
 Model : FR 732603
 Mode : WLAN 11b_Tx_Ch01;2412MHz
 Data Rate : 11

	Freq	Level	Over Limit	Limit Line	Read Level	Antenna Factor	Cable Loss	Preamp Factor	Ant Pos	Table Pos	Remark
	MHz	dBuV/m	dB	dBuV/m	dBuV	dB/m	dB	dB	cm	deg	
1	4824.00	57.94	-16.06	74.00	55.27	32.94	5.84	36.12	100	0	Peak
2 @	4824.00	49.97	-4.03	54.00	47.30	32.94	5.84	36.12	100	114	Average



Data: 13 File: D:\Project\2007Q2\项目732603\Part 15C\11b\11b_Tx_Ch01;2412MHz.EMI (18) Date: 2007-04-14

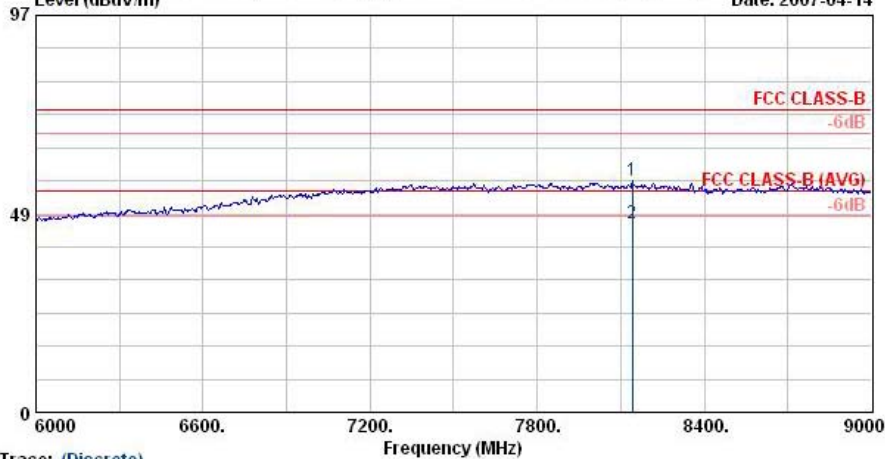

Trace: (Discrete)
 Condition : HF-ANT-060410 VERTICAL
 EUT : AP/Router
 Power : 120Vac/60Hz
 Model : FR 732603
 Mode : WLAN 11b_Tx_Ch01;2412MHz
 Data Rate : 11

	Freq	Level	Over Limit	Limit Line	ReadAntenna Level	Antenna Factor	Cable Loss	Preamp Factor	Ant Pos	Table Pos	Remark
	MHz	dBuV/m	dB	dBuV/m	dBuV	dB/m	dB	dB	cm	deg	
1	8142.00	56.58	-17.42	74.00	45.06	39.49	7.96	35.93	100	0	Peak
2 @	8142.00	46.02	-7.98	54.00	34.50	39.49	7.96	35.93	100	330	Average

Data: 14 File: D:\Project\2007Q2\项目732603\Part 15C\11b\11b_Tx_Ch01;2412MHz.EMI (18) Date: 2007-04-14

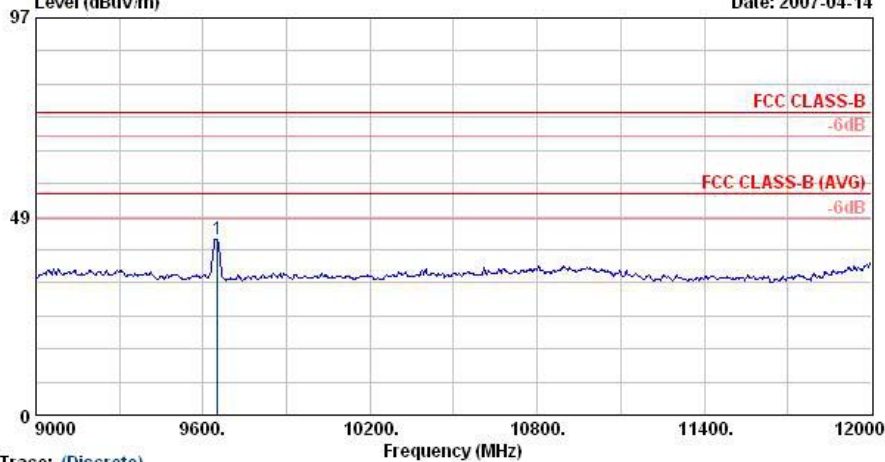

Trace: (Discrete)
 Condition : HF-ANT(6-18)-060918 VERTICAL
 EUT : AP/Router
 Power : 120Vac/60Hz
 Model : FR 732603
 Mode : WLAN 11b_Tx_Ch01;2412MHz
 Data Rate : 11

	Freq	Level	Over Limit	Limit Line	ReadAntenna Level	Antenna Factor	Cable Loss	Preamp Factor	Ant Pos	Table Pos	Remark
	MHz	dBuV/m	dB	dBuV/m	dBuV	dB/m	dB	dB	cm	deg	
1	9651.00	43.06	-30.94	74.00	80.69	-10.07	9.12	36.68	---	---	Peak



Data: 15 File: D:\Project\2007Q2\环境\732603\Part 15C\11b\11b_Tx_Ch01;2412MHz.EMI (18) Date: 2007-04-14

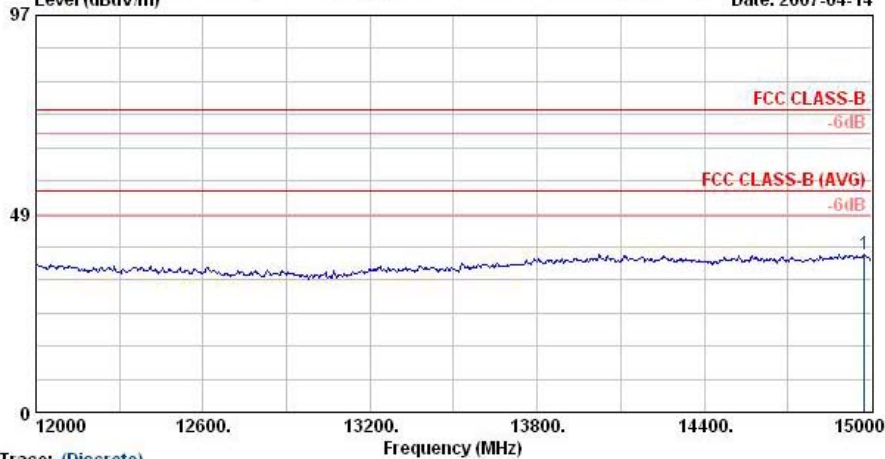

Trace: (Discrete)
Condition : HF-ANT(6-16)-060918 VERTICAL
EUT : AP/Router
Power : 120Vac/60Hz
Model : FR 732603
Mode : WLAN 11b_Tx_Ch01;2412MHz
Data Rate : 11

Table with 12 columns: Freq, Level, Over Limit, Limit Line, ReadAntenna Level, Antenna Factor, Cable Loss, Preamp Factor, Ant Pos, Table Pos, Remark. Row 1: 14976.00, 38.71, -35.29, 74.00, 69.66, -6.22, 11.27, 36.01, ---, ---, Peak

Data: 16 File: D:\Project\2007Q2\环境\732603\Part 15C\11b\11b_Tx_Ch01;2412MHz.EMI (18) Date: 2007-04-14

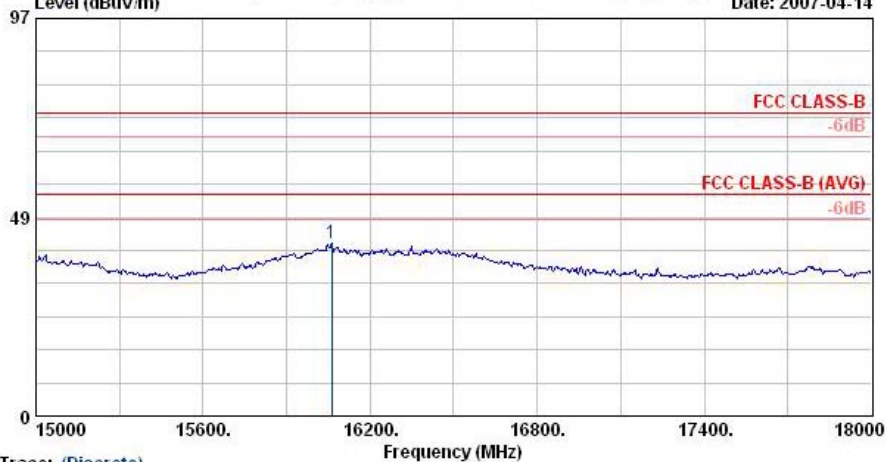

Trace: (Discrete)
Condition : HF-ANT(6-16)-060918 VERTICAL
EUT : AP/Router
Power : 120Vac/60Hz
Model : FR 732603
Mode : WLAN 11b_Tx_Ch01;2412MHz
Data Rate : 11

Table with 12 columns: Freq, Level, Over Limit, Limit Line, ReadAntenna Level, Antenna Factor, Cable Loss, Preamp Factor, Ant Pos, Table Pos, Remark. Row 1: 16062.00, 42.17, -31.83, 74.00, 70.57, -4.64, 11.79, 35.53, ---, ---, Peak



Data: 18 File: D:\Project\2007Q2\Report\732603\Part 15C\11b\11b_Tx_Ch01;2412MHz.EMI (18) Level (dBuV/m) Date: 2007-04-13

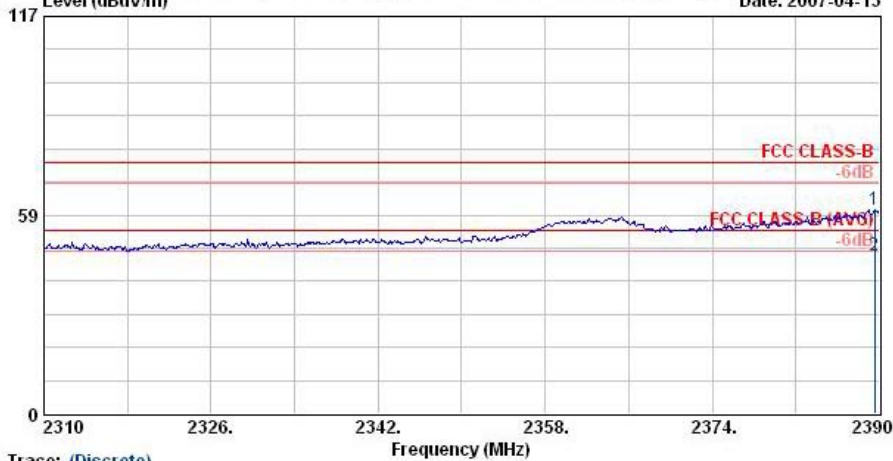

Trace: (Discrete) Condition : HF-ANT-060410 VERTICAL EUT : AP/Router Power : 120Vac/60Hz Model : FR 732603 Mode : WLAN 11b_Tx_Ch01;2412MHz Data Rate : 11

Table with 12 columns: Freq, Level, Over Limit, Limit Line, ReadAntenna Level, Antenna Factor, Cable Loss, Preamp Factor, Ant Pos, Table Pos, Remark. It lists two data points at 2389.52 MHz.

Remark: There is no more obvious spurious emission except the listings above.



- Test Mode : Mode 2
- Polarization : Horizontal

The test that passed at minimum margin was marked by the frame in the following table.

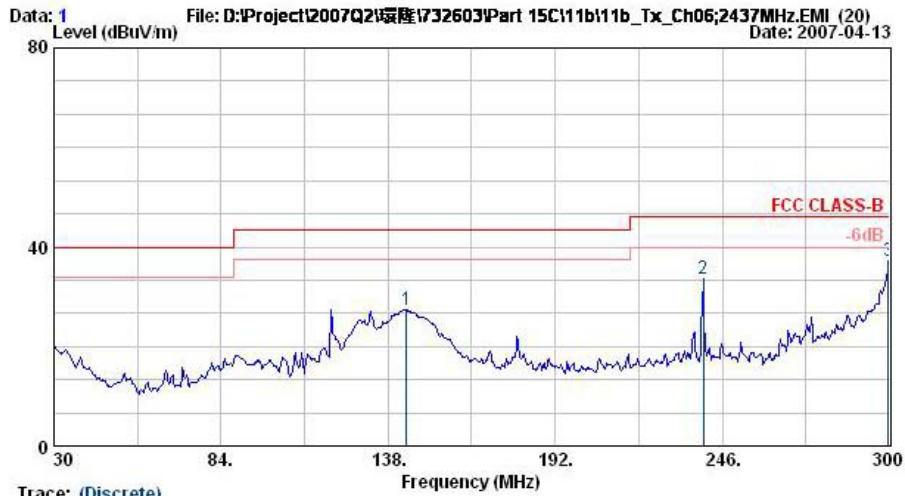

Trace: (Discrete)
 Condition : LF-ANT(951121) HORIZONTAL
 EUT : AP/Router
 Power : 120Vac/60Hz
 Model : FR 732603
 Mode : WLAN 11b_Tx_Ch06; 2437MHz
 Data Rate : 11

	Freq	Level	Over	Limit	Read	Antenna	Cable	Preamp	Ant	Table	Remark
	MHz	dBuV/m	dB	dBuV/m	dBuV	dB/m	dB	dB	cm	deg	
1 @	143.94	27.45	-16.05	43.50	46.43	10.30	1.77	31.05	---	---	Peak
2 @	239.79	33.58	-12.42	46.00	50.55	11.64	2.32	30.93	---	---	Peak
3 @	299.73	37.03	-8.97	46.00	52.12	13.21	2.63	30.93	---	---	Peak

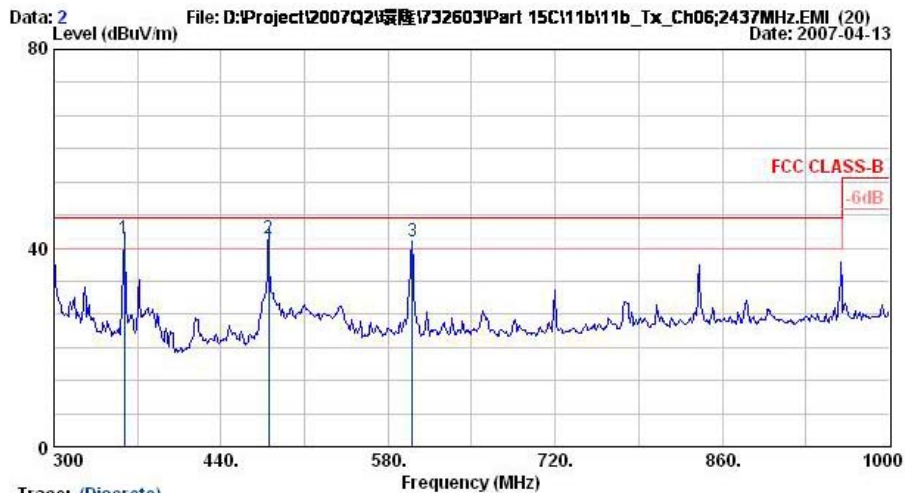

Trace: (Discrete)
 Condition : LF-ANT(951121) HORIZONTAL
 EUT : AP/Router
 Power : 120Vac/60Hz
 Model : FR 732603
 Mode : WLAN 11b_Tx_Ch06; 2437MHz
 Data Rate : 11

	Freq	Level	Over	Limit	Read	Antenna	Cable	Preamp	Ant	Table	Remark
	MHz	dBuV/m	dB	dBuV/m	dBuV	dB/m	dB	dB	cm	deg	
1 @	358.80	41.93	-4.07	46.00	55.20	14.72	2.90	30.89	100	220	QP
2 @	479.90	42.03	-3.97	46.00	52.30	17.09	3.45	30.81	100	224	QP
3 @	600.30	41.25	-4.75	46.00	49.57	18.47	3.87	30.66	---	---	Peak



Data: 3 File: D:\Project\2007Q2\环境\732603\Part 15C\11b\11b_Tx_Ch06;2437MHz.EMI (20) Date: 2007-04-14

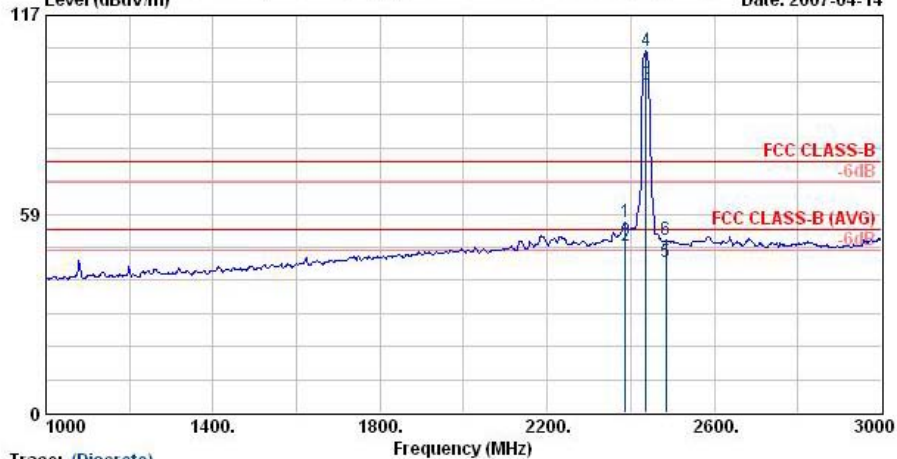

Trace: (Discrete)
 Condition : HF-ANT-060410 HORIZONTAL
 EUT : AP/Router
 Power : 120Vac/60Hz
 Model : FR 732603
 Mode : WLAN 11b_Tx_Ch06; 2437MHz
 Data Rate : 11

	Freq	Level	Over	Limit	Read	Antenna	Cable	Preamp	Ant	Table	Remark
	MHz	dBuV/m	dB	dBuV/m	dBuV	dB/m	dB	dB	cm	deg	
1 @	2388.00	56.21	-17.79	74.00	57.64	30.26	3.75	35.44	100	0	Peak
2 @	2388.00	49.12	-4.88	54.00	50.55	30.26	3.75	35.44	118	35	Average
3 @	2437.00	96.76			98.14	30.28	3.82	35.47	118	35	Average
4 @	2437.00	106.57			107.98	30.27	3.79	35.47	100	0	Peak
5 @	2484.00	44.46	-9.54	54.00	45.89	30.26	3.75	35.44	118	35	Average
6 @	2484.00	50.72	-23.28	74.00	52.07	30.29	3.86	35.51	100	0	Peak

Remark: #3 and #4 Fundamental Signal

Data: 4 File: D:\Project\2007Q2\环境\732603\Part 15C\11b\11b_Tx_Ch06;2437MHz.EMI (20) Date: 2007-04-14

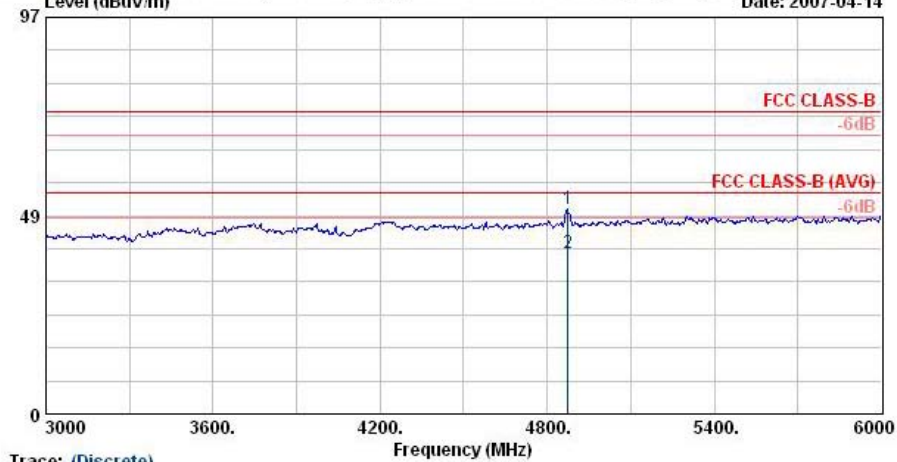

Trace: (Discrete)
 Condition : HF-ANT-060410 HORIZONTAL
 EUT : AP/Router
 Power : 120Vac/60Hz
 Model : FR 732603
 Mode : WLAN 11b_Tx_Ch06; 2437MHz
 Data Rate : 11

	Freq	Level	Over	Limit	Read	Antenna	Cable	Preamp	Ant	Table	Remark
	MHz	dBuV/m	dB	dBuV/m	dBuV	dB/m	dB	dB	cm	deg	
1 @	4874.00	50.07	-23.93	74.00	47.22	33.14	5.88	36.16	100	0	Peak
2 @	4874.00	39.40	-14.60	54.00	36.54	33.14	5.88	36.16	100	55	Average



Data: 5 File: D:\Project\2007Q2\环境\732603\Part 15C\11b\11b_Tx_Ch06;2437MHz.EMI (20) Date: 2007-04-14

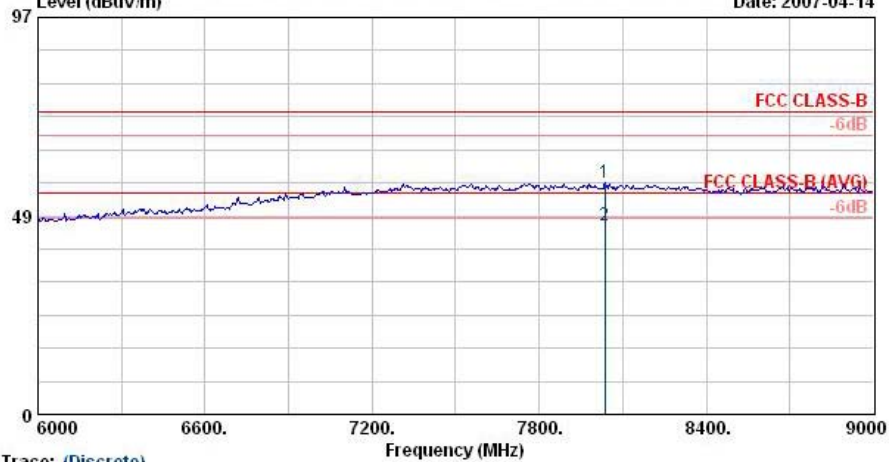

Trace: (Discrete)
Condition : HF-ANT-060410 HORIZONTAL
EUT : AP/Router
Power : 120Vac/60Hz
Model : FR 732603
Mode : WLAN 11b_Tx_Ch06; 2437MHz
Data Rate : 11

Table with 12 columns: Freq, Level, Over Limit, Limit Line, ReadAntenna Level, Antenna Factor, Cable Loss, Preamp Factor, Ant Pos, Table Pos, Remark. Contains two rows of data for peak and average values at 8037.00 MHz.

Data: 6 File: D:\Project\2007Q2\环境\732603\Part 15C\11b\11b_Tx_Ch06;2437MHz.EMI (20) Date: 2007-04-14

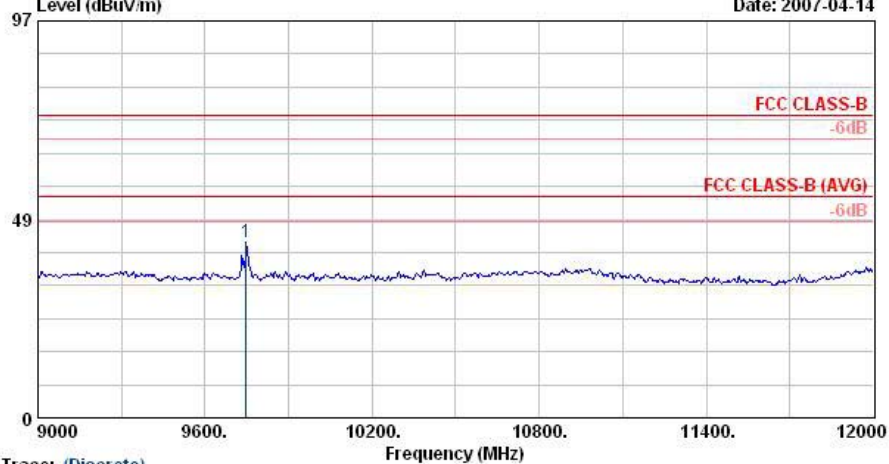

Trace: (Discrete)
Condition : HF-ANT(8-18)-060918 HORIZONTAL
EUT : AP/Router
Power : 120Vac/60Hz
Model : FR 732603
Mode : WLAN 11b_Tx_Ch06; 2437MHz
Data Rate : 11

Table with 12 columns: Freq, Level, Over Limit, Limit Line, ReadAntenna Level, Antenna Factor, Cable Loss, Preamp Factor, Ant Pos, Table Pos, Remark. Contains one row of data for peak value at 9747.00 MHz.



Data: 7 File: D:\Project\2007Q2\环境\732603\Part 15C\11b\11b_Tx_Ch06;2437MHz.EMI (20) Date: 2007-04-14

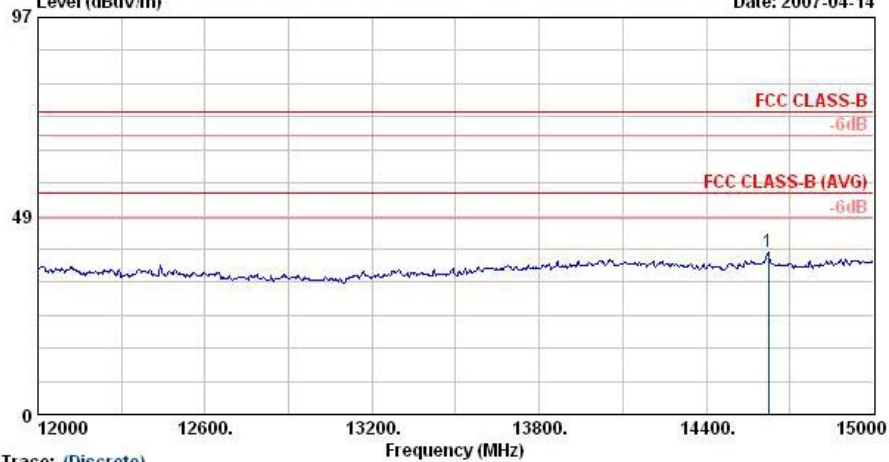

Trace: (Discrete)
 Condition : HF-ANT(8-18)-060918 HORIZONTAL
 EUT : AP/Router
 Power : 120Vac/60Hz
 Model : FR 732603
 Mode : WLAN 11b_Tx_Ch06; 2437MHz
 Data Rate : 11

	Freq	Level	Over Limit	Limit Line	Read Level	Antenna Factor	Cable Loss	Preamp Factor	Ant Pos	Table Pos	Remark
	MHz	dBuV/m	dB	dBuV/m	dBuV	dB/m	dB	dB	cm	deg	
1	14622.00	39.61	-34.39	74.00	70.12	-6.50	11.62	35.63	---	---	Peak

Data: 8 File: D:\Project\2007Q2\环境\732603\Part 15C\11b\11b_Tx_Ch06;2437MHz.EMI (20) Date: 2007-04-14

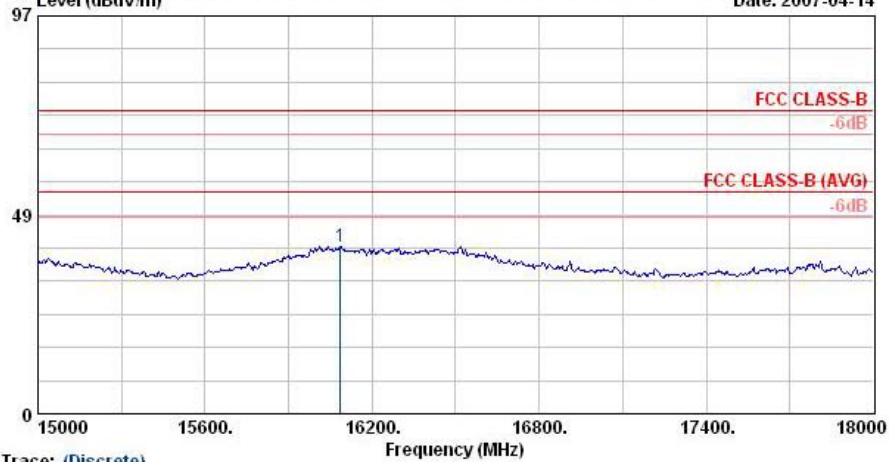

Trace: (Discrete)
 Condition : HF-ANT(8-18)-060918 HORIZONTAL
 EUT : AP/Router
 Power : 120Vac/60Hz
 Model : FR 732603
 Mode : WLAN 11b_Tx_Ch06; 2437MHz
 Data Rate : 11

	Freq	Level	Over Limit	Limit Line	Read Level	Antenna Factor	Cable Loss	Preamp Factor	Ant Pos	Table Pos	Remark
	MHz	dBuV/m	dB	dBuV/m	dBuV	dB/m	dB	dB	cm	deg	
1	16086.00	40.92	-33.08	74.00	69.39	-5.02	11.79	35.24	---	---	Peak



Data: 9 File: D:\Project\2007Q2\环境\732603\Part 15C\11b\11b_Tx_Ch06;2437MHz.EMI (20) Date: 2007-04-14

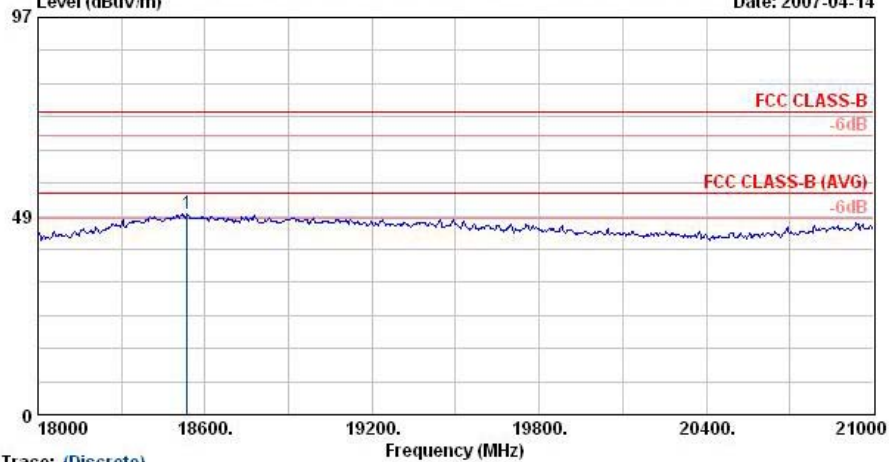

Trace: (Discrete)
 Condition : SHF-EHF HORN HORIZONTAL
 EUT : AP/Router
 Power : 120Vac/60Hz
 Model : FR 732603
 Mode : WLAN 11b_Tx_Ch06; 2437MHz
 Data Rate : 11

	Freq	Level	Over Limit	Limit Line	ReadAntenna Level	Antenna Factor	Cable Loss	Preamp Factor	Ant Pos	Table Pos	Remark
	MHz	dBuV/m	dB	dBuV/m	dBuV	dB/m	dB	dB	cm	deg	
1 @	18537.00	49.09	-24.91	74.00	44.58	21.19	19.23	35.91	---	---	Peak

Data: 10 File: D:\Project\2007Q2\环境\732603\Part 15C\11b\11b_Tx_Ch06;2437MHz.EMI (20) Date: 2007-04-14

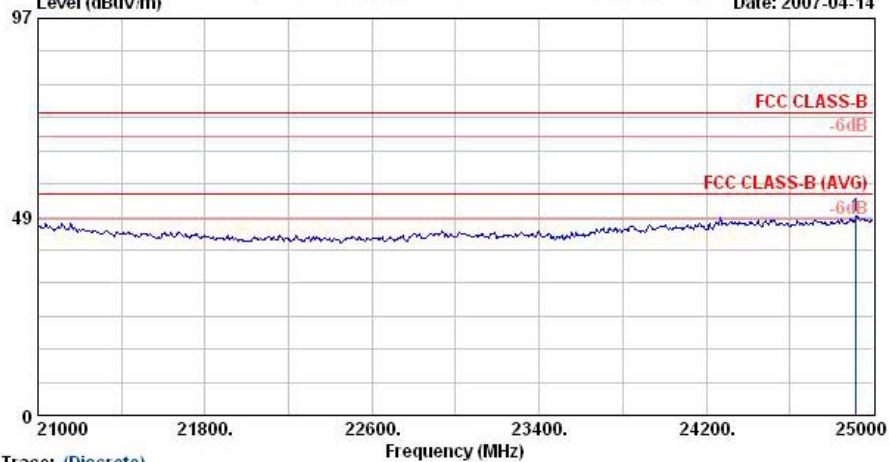

Trace: (Discrete)
 Condition : SHF-EHF HORN HORIZONTAL
 EUT : AP/Router
 Power : 120Vac/60Hz
 Model : FR 732603
 Mode : WLAN 11b_Tx_Ch06; 2437MHz
 Data Rate : 11

	Freq	Level	Over Limit	Limit Line	ReadAntenna Level	Antenna Factor	Cable Loss	Preamp Factor	Ant Pos	Table Pos	Remark
	MHz	dBuV/m	dB	dBuV/m	dBuV	dB/m	dB	dB	cm	deg	
1 @	24916.00	48.59	-25.41	74.00	46.57	21.87	18.69	38.55	---	---	Peak



- Polarization : Vertical

The test that passed at minimum margin was marked by the frame in the following table.

Data: 11 File: D:\Project\2007Q2\Report\732603\Part 15C\11b\11b_Tx_Ch06;2437MHz.EMI (20) Date: 2007-04-13

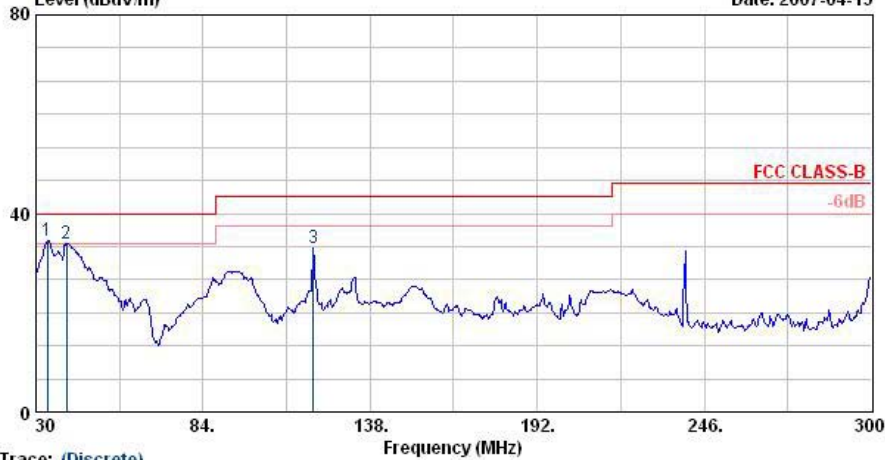

Trace: (Discrete)
 Condition : LF-ANT(051121) VERTICAL
 EUT : AP/Router
 Power : 120Vac/60Hz
 Model : FR 732603
 Mode : WLAN 11b_Tx_Ch06;2437MHz
 Data Rate : 11

	Freq	Level	Over	Limit	ReadAntenna	Cable	Preamp	Ant	Table	Remark
	MHz	dBuV/m	dB	dBuV/m	dBuV	dB/m	dB	dB	cm	deg
1 @	33.78	34.62	-5.38	40.00	48.23	16.84	0.87	31.32	100	228 Peak
2 @	39.99	34.02	-5.98	40.00	50.80	13.51	0.92	31.21	---	---
3 @	119.64	33.08	-10.42	43.50	50.03	12.50	1.63	31.08	---	---

Data: 12 File: D:\Project\2007Q2\Report\732603\Part 15C\11b\11b_Tx_Ch06;2437MHz.EMI (20) Date: 2007-04-13

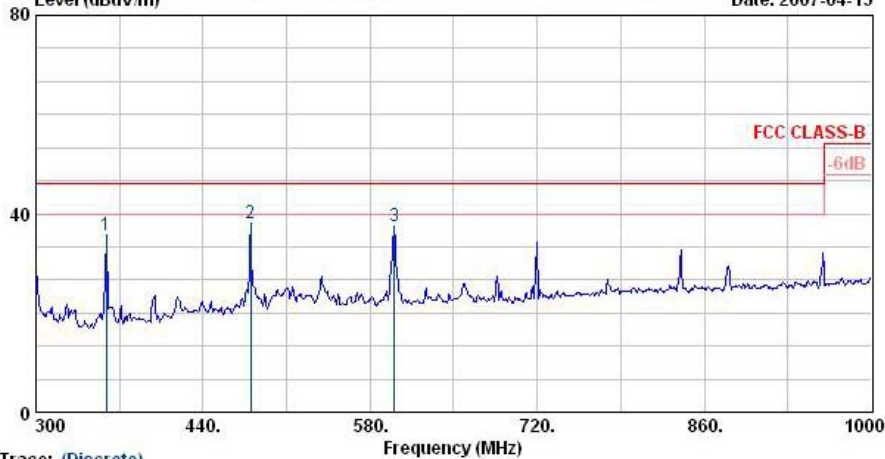

Trace: (Discrete)
 Condition : LF-ANT(051121) VERTICAL
 EUT : AP/Router
 Power : 120Vac/60Hz
 Model : FR 732603
 Mode : WLAN 11b_Tx_Ch06;2437MHz
 Data Rate : 11

	Freq	Level	Over	Limit	ReadAntenna	Cable	Preamp	Ant	Table	Remark
	MHz	dBuV/m	dB	dBuV/m	dBuV	dB/m	dB	dB	cm	deg
1 @	358.80	35.82	-10.18	46.00	49.09	14.72	2.90	30.89	---	---
2 @	479.90	38.04	-7.96	46.00	48.31	17.09	3.45	30.81	---	---
3 @	600.30	37.41	-8.59	46.00	45.73	18.47	3.87	30.66	---	---



Data: 13 File: D:\Project\2007Q2\Report\732603\Part 15C\11b\11b_Tx_Ch06;2437MHz.EMI (20) Date: 2007-04-14

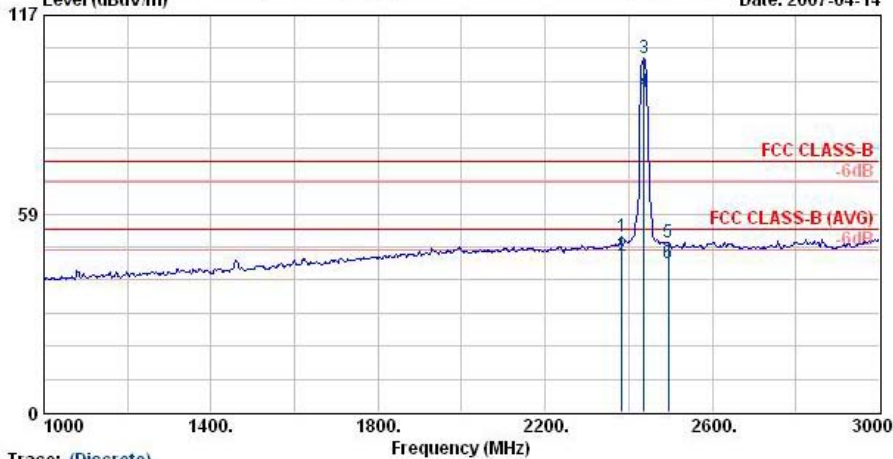

Trace: (Discrete)
 Condition : HF-ANT-060410 VERTICAL
 EUT : AP/Router
 Power : 120Vac/60Hz
 Model : FR 732603
 Mode : WLAN 11b_Tx_Ch06;2437MHz
 Data Rate : 11

	Freq	Level	Over Limit	Limit Line	Read Level	Antenna Factor	Cable Loss	Preamp Factor	Ant Pos	Table Pos	Remark
	MHz	dBuV/m	dB	dBuV/m	dBuV	dB/m	dB	dB	cm	deg	
1 @	2384.00	51.88	-22.12	74.00	53.32	30.25	3.75	35.44	100	0	Peak
2 @	2384.00	46.28	-7.72	54.00	47.72	30.25	3.75	35.44	104	326	Average
3 @	2437.00	104.57			105.98	30.27	3.79	35.47	100	0	Peak
4 @	2437.00	94.23			95.61	30.28	3.82	35.47	104	326	Average
5 @	2494.00	49.93	-24.07	74.00	51.28	30.30	3.88	35.53	100	0	Peak
6 @	2494.00	43.79	-10.21	54.00	45.14	30.30	3.88	35.53	104	326	Average

Remark: #3 and #4 Fundamental Signal

Data: 14 File: D:\Project\2007Q2\Report\732603\Part 15C\11b\11b_Tx_Ch06;2437MHz.EMI (20) Date: 2007-04-14

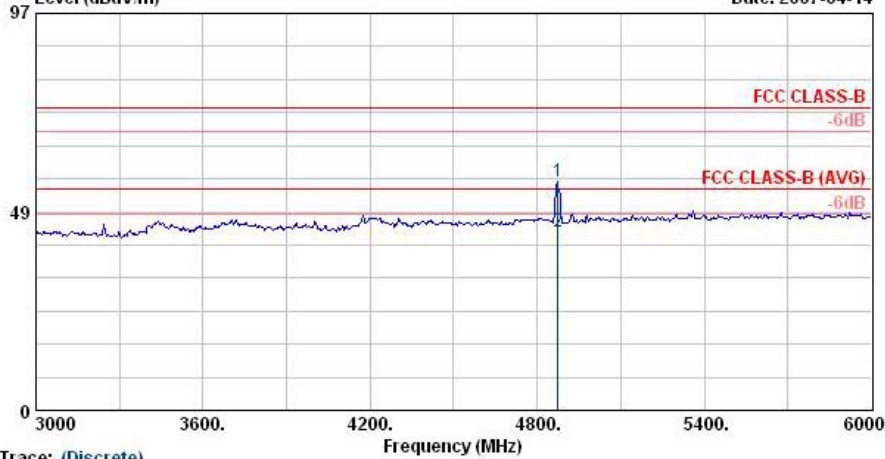

Trace: (Discrete)
 Condition : HF-ANT-060410 VERTICAL
 EUT : AP/Router
 Power : 120Vac/60Hz
 Model : FR 732603
 Mode : WLAN 11b_Tx_Ch06;2437MHz
 Data Rate : 11

	Freq	Level	Over Limit	Limit Line	Read Level	Antenna Factor	Cable Loss	Preamp Factor	Ant Pos	Table Pos	Remark
	MHz	dBuV/m	dB	dBuV/m	dBuV	dB/m	dB	dB	cm	deg	
1 @	4874.00	55.83	-18.17	74.00	52.98	33.14	5.88	36.16	100	0	Peak
2 @	4874.00	43.49	-10.51	54.00	40.63	33.14	5.88	36.16	100	118	Average



Data: 15 File: D:\Project\2007Q2\环境\732603\Part 15C\11b\11b_Tx_Ch06;2437MHz.EMI (20) Date: 2007-04-14

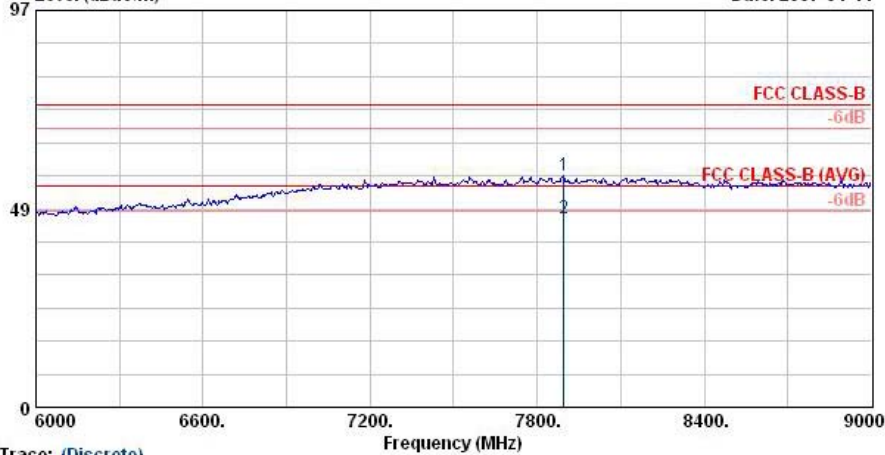

Trace: (Discrete)
 Condition : HF-ANT-060410 VERTICAL
 EUT : AP/Router
 Power : 120Vac/60Hz
 Model : FR 732603
 Mode : WLAN 11b_Tx_Ch06;2437MHz
 Data Rate : 11

	Freq	Level	Over Limit	Limit Line	ReadAntenna Level	Antenna Factor	Cable Loss	Preamp Factor	Ant Pos	Table Pos	Remark
	MHz	dBuV/m	dB	dBuV/m	dBuV	dB/m	dB	dB	cm	deg	
1 @	7896.00	56.46	-17.54	74.00	45.13	39.46	7.76	35.89	100	0	Peak
2 @	7896.00	46.30	-7.70	54.00	34.98	39.46	7.76	35.89	100	117	Average

Data: 16 File: D:\Project\2007Q2\环境\732603\Part 15C\11b\11b_Tx_Ch06;2437MHz.EMI (20) Date: 2007-04-14

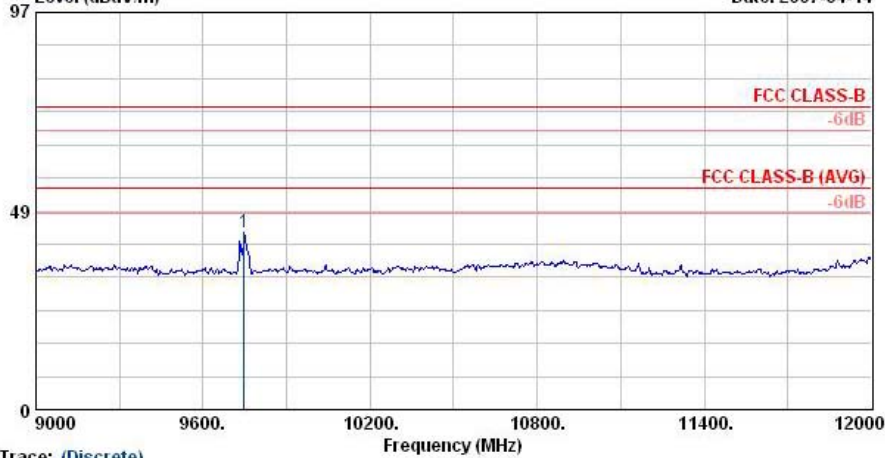

Trace: (Discrete)
 Condition : HF-ANT(8-16)-060918 VERTICAL
 EUT : AP/Router
 Power : 120Vac/60Hz
 Model : FR 732603
 Mode : WLAN 11b_Tx_Ch06;2437MHz
 Data Rate : 11

	Freq	Level	Over Limit	Limit Line	ReadAntenna Level	Antenna Factor	Cable Loss	Preamp Factor	Ant Pos	Table Pos	Remark
	MHz	dBuV/m	dB	dBuV/m	dBuV	dB/m	dB	dB	cm	deg	
1	9747.00	43.15	-30.85	74.00	80.46	-9.85	9.15	36.61	---	---	Peak



Data: 17 File: D:\Project\2007Q2\环境\732603\Part 15C\11b\11b_Tx_Ch06;2437MHz.EMI (20) Date: 2007-04-14

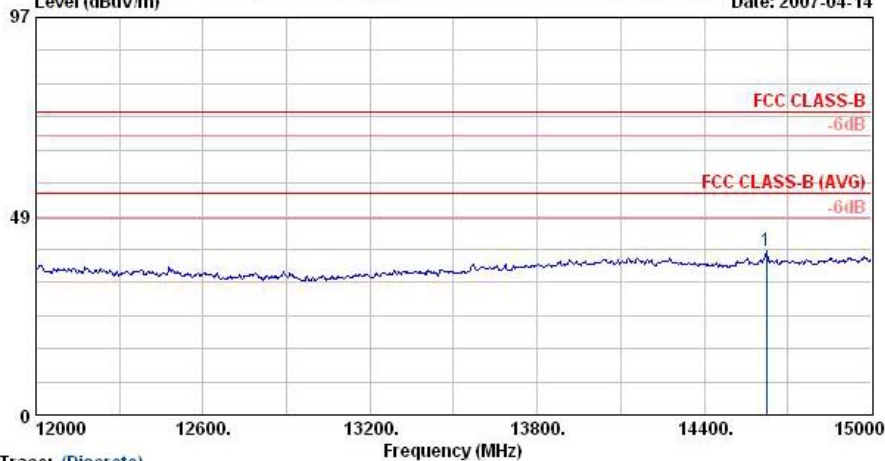

Trace: (Discrete)
 Condition : HF-ANT(6-16)-060918 VERTICAL
 EUT : AP/Router
 Power : 120Vac/60Hz
 Model : FR 732603
 Mode : WLAN 11b_Tx_Ch06;2437MHz
 Data Rate : 11

	Freq	Level	Over Limit	Limit Line	ReadAntenna Level	Antenna Factor	Cable Loss	Preamp Factor	Ant Pos	Table Pos	Remark
	MHz	dBuV/m	dB	dBuV/m	dBuV	dB/m	dB	dB	cm	deg	
1	14622.00	40.11	-33.89	74.00	70.63	-6.50	11.62	35.63	---	---	Peak

Data: 18 File: D:\Project\2007Q2\环境\732603\Part 15C\11b\11b_Tx_Ch06;2437MHz.EMI (20) Date: 2007-04-14

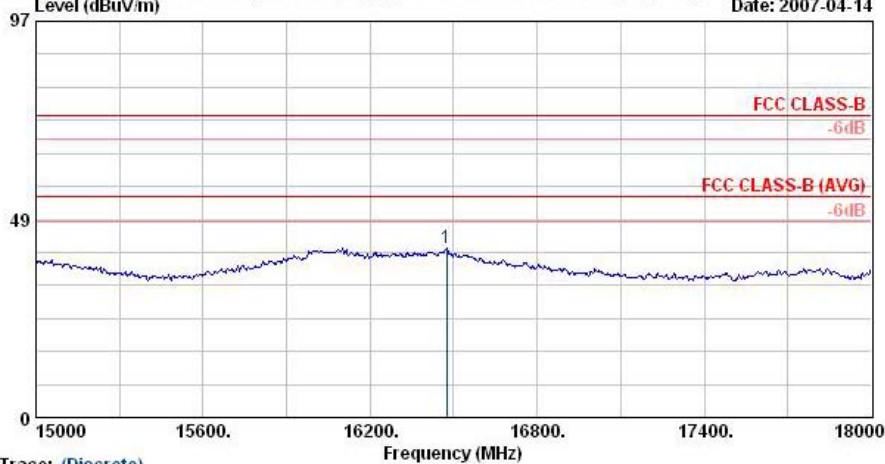

Trace: (Discrete)
 Condition : HF-ANT(6-16)-060918 VERTICAL
 EUT : AP/Router
 Power : 120Vac/60Hz
 Model : FR 732603
 Mode : WLAN 11b_Tx_Ch06;2437MHz
 Data Rate : 11

	Freq	Level	Over Limit	Limit Line	ReadAntenna Level	Antenna Factor	Cable Loss	Preamp Factor	Ant Pos	Table Pos	Remark
	MHz	dBuV/m	dB	dBuV/m	dBuV	dB/m	dB	dB	cm	deg	
1	16476.00	41.44	-32.56	74.00	70.23	-9.85	11.88	30.81	---	---	Peak



Data: 19 File: D:\Project\2007Q2\Report\732603\Part 15C\11b\11b_Tx_Ch06;2437MHz.EMI (20) Date: 2007-04-14

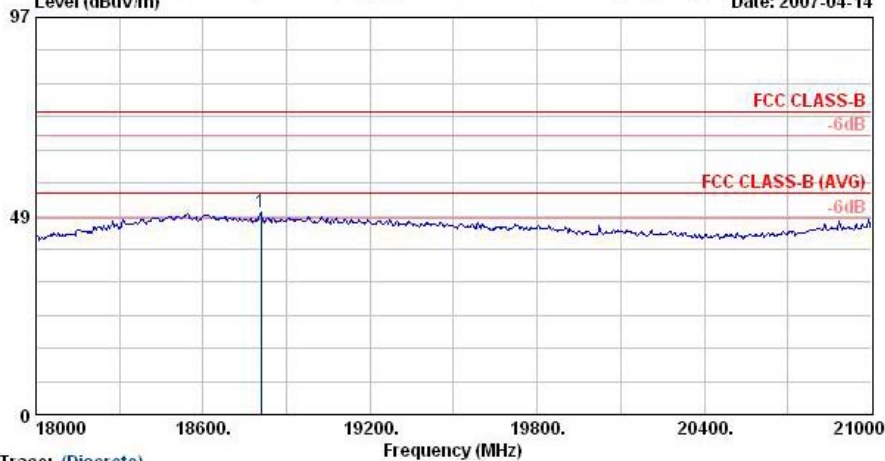

Trace: (Discrete)
Condition : SHF-EHF HORN VERTICAL
EUT : AP/Router
Power : 120Vac/60Hz
Model : FR 732603
Mode : WLAN 11b_Tx_Ch06;2437MHz
Data Rate : 11

Table with 12 columns: Freq, Level, Over Limit, Limit Line, ReadAntenna Level, Antenna Factor, Cable Loss, Preamp Factor, Ant Pos, Table Pos, Remark. Row 1: 1 @ 18807.00 MHz, 49.32 dBuV/m, -24.68 dB, 74.00 dBuV/m, 45.17 dBuV, 21.37 dB/m, 18.60 dB, 35.82 dB, --- cm, --- deg, Peak

Data: 20 File: D:\Project\2007Q2\Report\732603\Part 15C\11b\11b_Tx_Ch06;2437MHz.EMI (20) Date: 2007-04-14

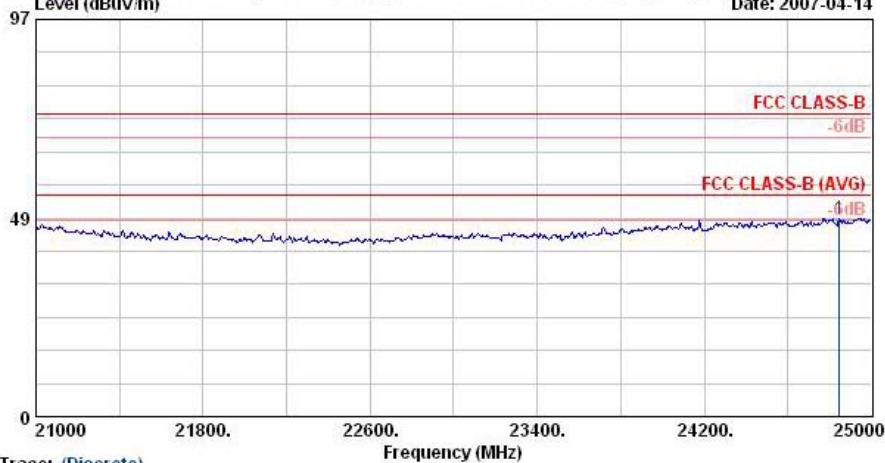

Trace: (Discrete)
Condition : SHF-EHF HORN VERTICAL
EUT : AP/Router
Power : 120Vac/60Hz
Model : FR 732603
Mode : WLAN 11b_Tx_Ch06;2437MHz
Data Rate : 11

Table with 12 columns: Freq, Level, Over Limit, Limit Line, ReadAntenna Level, Antenna Factor, Cable Loss, Preamp Factor, Ant Pos, Table Pos, Remark. Row 1: 1 @ 24848.00 MHz, 48.42 dBuV/m, -25.58 dB, 74.00 dBuV/m, 46.19 dBuV, 21.98 dB/m, 18.86 dB, 38.62 dB, --- cm, --- deg, Peak

Remark: There is no more obvious spurious emission except the listings above.



- Test Mode : Mode 3
- Polarization : Horizontal

The test that passed at minimum margin was marked by the frame in the following table.



Trace: (Discrete)
 Condition : LF-ANT(851121) HORIZONTAL
 EUT : AP/Router
 Power : 120Vac/60Hz
 Model : FR 732603
 Mode : WLAN 11b_Tx_Ch11;2462MHz
 Data Rate : 11

	Freq	Level	Over	Limit	ReadAntenna	Cable	Preamp	Ant	Table	Remark	
	MHz	dBuV/m	dB	dBuV/m	dBuV	dB/m	dB	dB	cm	deg	
1	119.64	27.60	-15.90	43.50	44.55	12.50	1.63	31.08	---	---	Peak
2 @	239.79	34.98	-11.02	46.00	51.95	11.64	2.32	30.93	---	---	Peak
3 @	299.46	34.99	-11.01	46.00	50.08	13.21	2.63	30.93	---	---	Peak

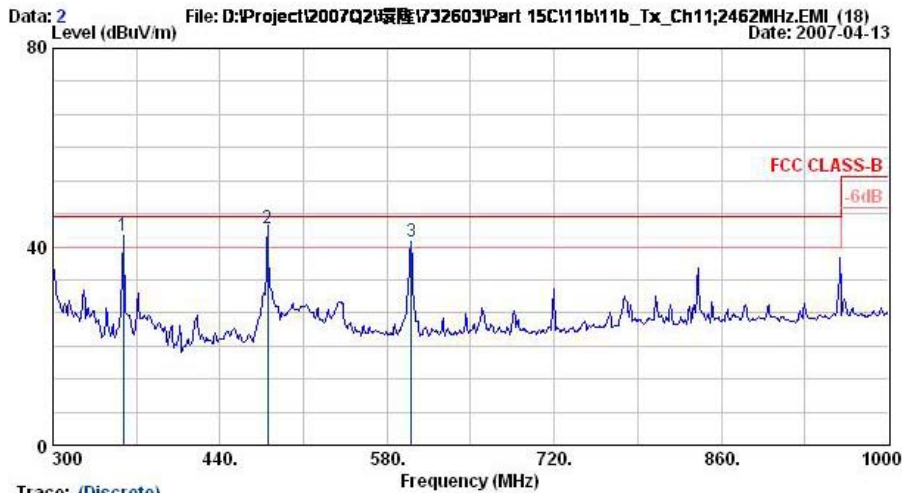

Trace: (Discrete)
 Condition : LF-ANT(851121) HORIZONTAL
 EUT : AP/Router
 Power : 120Vac/60Hz
 Model : FR 732603
 Mode : WLAN 11b_Tx_Ch11;2462MHz
 Data Rate : 11

	Freq	Level	Over	Limit	ReadAntenna	Cable	Preamp	Ant	Table	Remark	
	MHz	dBuV/m	dB	dBuV/m	dBuV	dB/m	dB	dB	cm	deg	
1 @	358.80	42.38	-3.62	46.00	55.65	14.72	2.90	30.89	---	---	Peak
2 @	479.90	43.63	-2.37	46.00	53.90	17.09	3.45	30.81	100	221	QP
3 @	600.30	41.16	-4.84	46.00	49.48	18.47	3.87	30.66	---	---	Peak



Data: 3 File: D:\Project\2007Q2\环境\732603\Part 15C\11b\11b_Tx_Ch11;2462MHz.EMI (18) Date: 2007-04-14

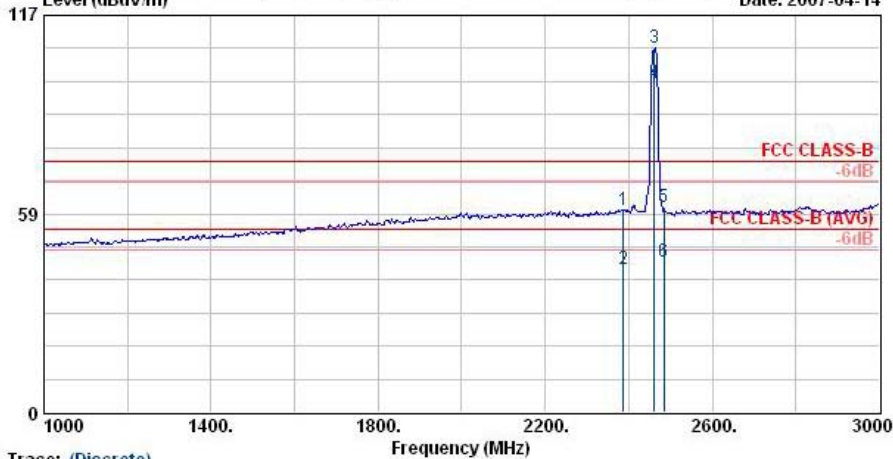

Trace: (Discrete)

Condition : HF-ANT-060410 HORIZONTAL
 EUT : AP/Router
 Power : 120Vac/60Hz
 Model : FR 732603
 Mode : WLAN 11b_Tx_Ch11;2462MHz
 Data Rate : 11

	Freq	Level	Over Limit	Limit Line	ReadAntenna Level	Antenna Factor	Cable Loss	Preamp Factor	Ant Pos	Table Pos	Remark
	MHz	dBuV/m	dB	dBuV/m	dBuV	dB/m	dB	dB	cm	deg	
1	2388.00	59.77	-14.23	74.00	61.20	30.26	3.75	35.44	100	0	Peak
2 @	2388.00	42.29	-11.71	54.00	43.72	30.26	3.75	35.44	116	339	Average
3 @	2462.00	107.24			108.61	30.29	3.84	35.49	100	0	Peak
4 @	2462.00	97.10			98.47	30.29	3.84	35.49	116	339	Average
5	2483.62	60.26	-13.74	74.00	61.62	30.29	3.86	35.51	100	0	Peak
6 @	2483.62	44.34	-9.66	54.00	45.70	30.29	3.86	35.51	116	339	Average

Remark: #3 and #4 Fundamental Signal

Data: 4 File: D:\Project\2007Q2\环境\732603\Part 15C\11b\11b_Tx_Ch11;2462MHz.EMI (18) Date: 2007-04-14

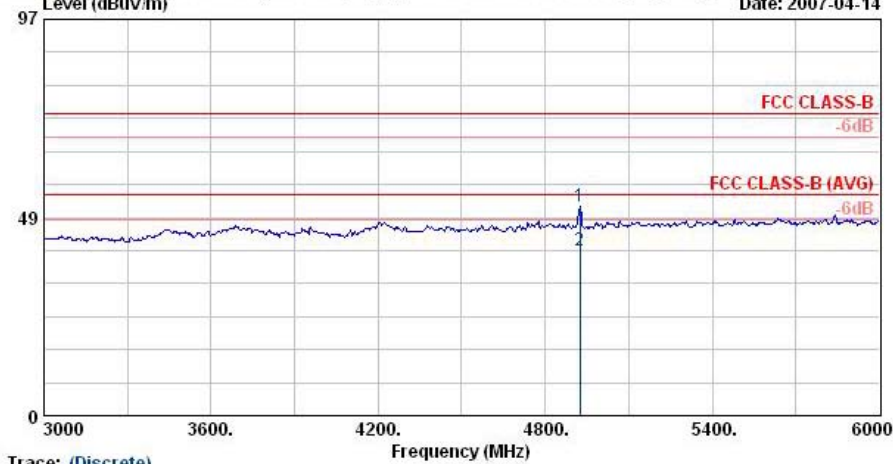

Trace: (Discrete)

Condition : HF-ANT-060410 HORIZONTAL
 EUT : AP/Router
 Power : 120Vac/60Hz
 Model : FR 732603
 Mode : WLAN 11b_Tx_Ch11;2462MHz
 Data Rate : 11

	Freq	Level	Over Limit	Limit Line	ReadAntenna Level	Antenna Factor	Cable Loss	Preamp Factor	Ant Pos	Table Pos	Remark
	MHz	dBuV/m	dB	dBuV/m	dBuV	dB/m	dB	dB	cm	deg	
1	4924.00	51.10	-22.90	74.00	48.06	33.34	5.92	36.21	100	0	Peak
2	4924.00	40.25	-13.75	54.00	37.20	33.34	5.92	36.21	100	52	Average



Data: 5 File: D:\Project\2007Q2\设备\732603\Part 15C\11b\11b_Tx_Ch11;2462MHz.EMI (18) Date: 2007-04-14

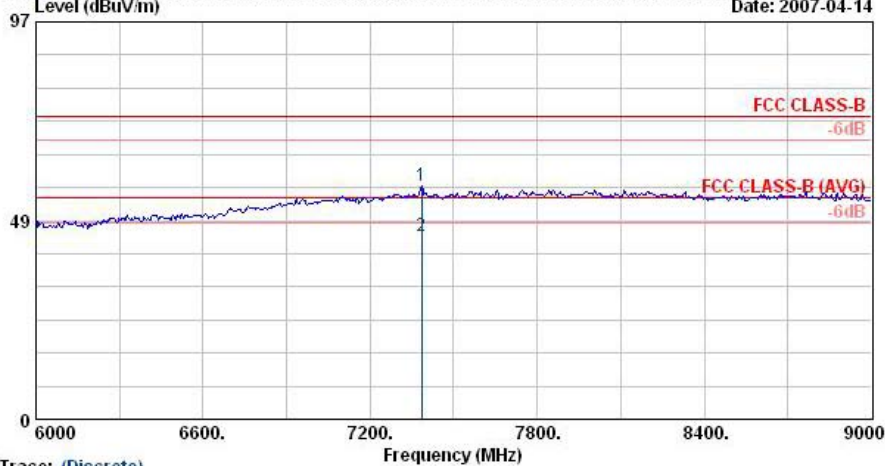

Condition : HF-ANT-060410 HORIZONTAL
 EUT : AP/Router
 Power : 120Vac/60Hz
 Model : FR 732603
 Mode : WLAN 11b_Tx_Ch11;2462MHz
 Data Rate : 11

	Freq	Level	Over Limit	Limit Line	ReadAntenna Level	Antenna Factor	Cable Loss	Preamp Factor	Ant Pos	Table Pos	Remark
	MHz	dBuV/m	dB	dBuV/m	dBuV	dB/m	dB	dB	cm	deg	
1	7386.00	56.84	-17.16	74.00	46.49	38.67	7.68	36.00	---	---	Peak
2 @	7386.00	44.85	-9.15	54.00	34.50	38.67	7.68	36.00	100	320	Average

Data: 6 File: D:\Project\2007Q2\设备\732603\Part 15C\11b\11b_Tx_Ch11;2462MHz.EMI (18) Date: 2007-04-14

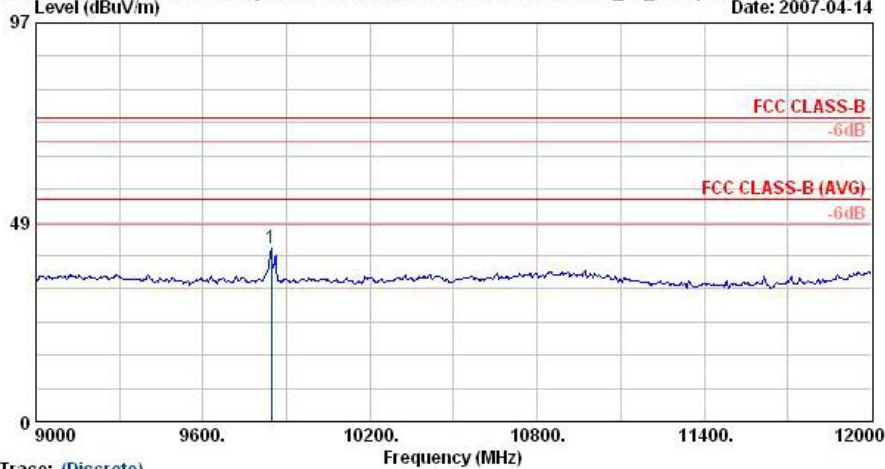

Condition : HF-ANT(6-16)-060918 HORIZONTAL
 EUT : AP/Router
 Power : 120Vac/60Hz
 Model : FR 732603
 Mode : WLAN 11b_Tx_Ch11;2462MHz
 Data Rate : 11

	Freq	Level	Over Limit	Limit Line	ReadAntenna Level	Antenna Factor	Cable Loss	Preamp Factor	Ant Pos	Table Pos	Remark
	MHz	dBuV/m	dB	dBuV/m	dBuV	dB/m	dB	dB	cm	deg	
1	9846.00	42.29	-31.71	74.00	79.27	-9.63	9.18	36.54	---	---	Peak



Data: 7 File: D:\Project\2007Q2\項目\732603\Part 15C\11b\11b_Tx_Ch11;2462MHz.EMI (18) Date: 2007-04-14

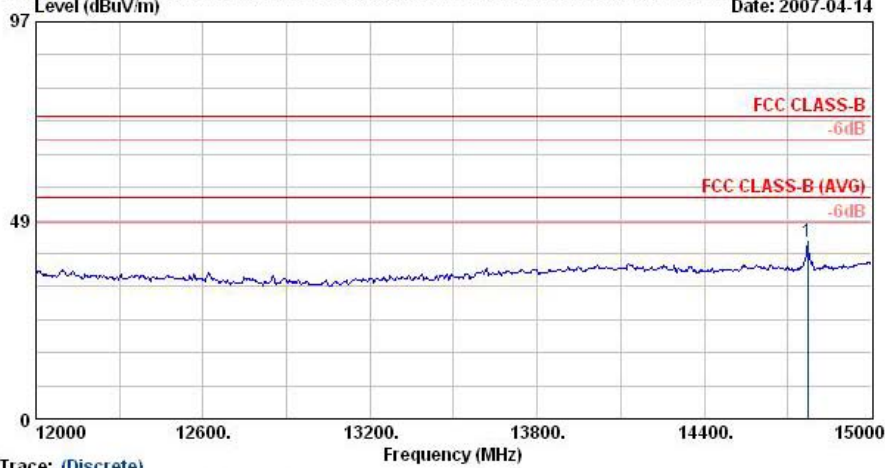

Trace: (Discrete)
 Condition : HF-ANT(6-16)-060918 HORIZONTAL
 EUT : AP/Router
 Power : 120Vac/60Hz
 Model : FR 732603
 Mode : WLAN 11b_Tx_Ch11;2462MHz
 Data Rate : 11

	Freq	Level	Over Limit	Limit Line	ReadAntenna Level	Antenna Factor	Cable Loss	Preamp Factor	Ant Pos	Table Pos	Remark
	MHz	dBuV/m	dB	dBuV/m	dBuV	dB/m	dB	dB	cm	deg	
1	14772.00	43.19	-30.81	74.00	73.89	-6.38	11.47	35.79	---	---	Peak

Data: 8 File: D:\Project\2007Q2\項目\732603\Part 15C\11b\11b_Tx_Ch11;2462MHz.EMI (18) Date: 2007-04-14

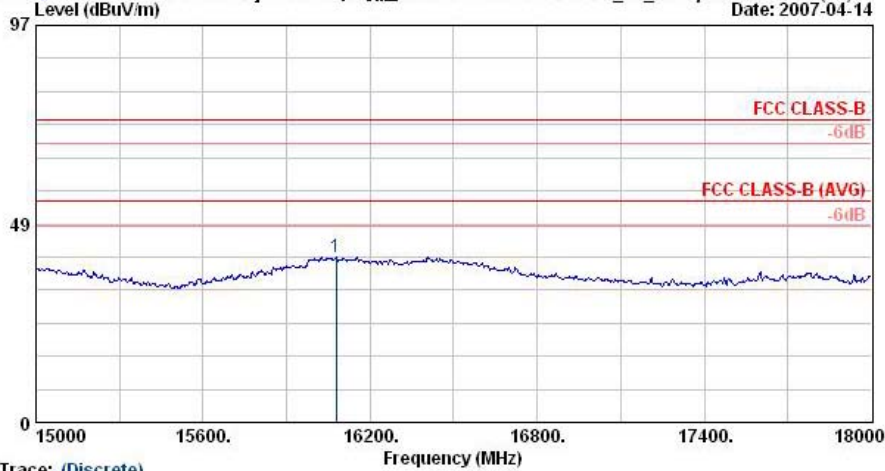

Trace: (Discrete)
 Condition : HF-ANT(6-16)-060918 HORIZONTAL
 EUT : AP/Router
 Power : 120Vac/60Hz
 Model : FR 732603
 Mode : WLAN 11b_Tx_Ch11;2462MHz
 Data Rate : 11

	Freq	Level	Over Limit	Limit Line	ReadAntenna Level	Antenna Factor	Cable Loss	Preamp Factor	Ant Pos	Table Pos	Remark
	MHz	dBuV/m	dB	dBuV/m	dBuV	dB/m	dB	dB	cm	deg	
1	16077.00	40.50	-33.50	74.00	69.13	-4.89	11.79	35.53	---	---	Peak



Data: 17 File: D:\Project\2007Q2\Report\732603\Part 15C\11b\11b_Tx_Ch11;2462MHz.EMI (18) Date: 2007-04-14
 Level (dBuV/m)

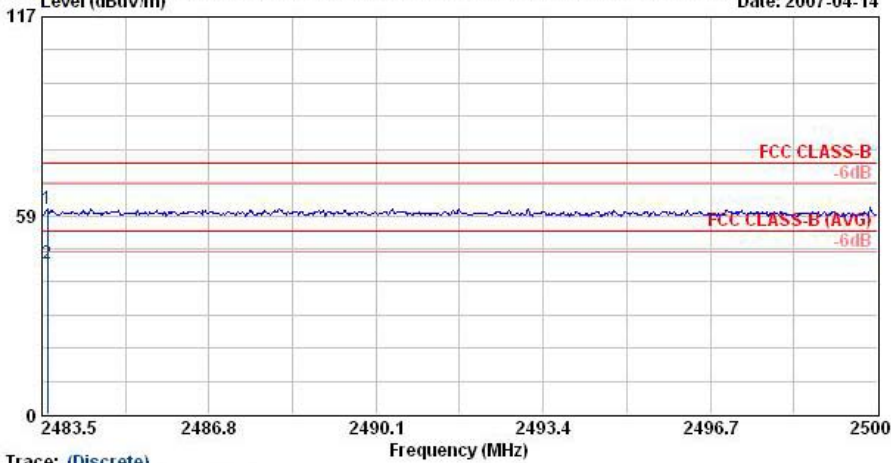

Trace: (Discrete)

Condition : HF-ANT-060410 HORIZONTAL
 EUT : AP/Router
 Power : 120Vac/60Hz
 Model : FR 732603
 Mode : WLAN 11b_Tx_Ch11;2462MHz
 Data Rate : 11

	Freq	Level	Over Limit	Limit Line	ReadAntenna Level	Antenna Factor	Cable Loss	Preamp Factor	Ant Pos	Table Pos	Remark
	MHz	dBuV/m	dB	dBuV/m	dBuV	dB/m	dB	dB	cm	deg	
1	2483.62	60.26	-13.74	74.00	61.61	30.29	3.86	35.51	100	0	Peak
2 @	2483.62	44.34	-9.66	54.00	45.70	30.29	3.86	35.51	116	339	Average



- Polarization : Vertical

The test that passed at minimum margin was marked by the frame in the following table.

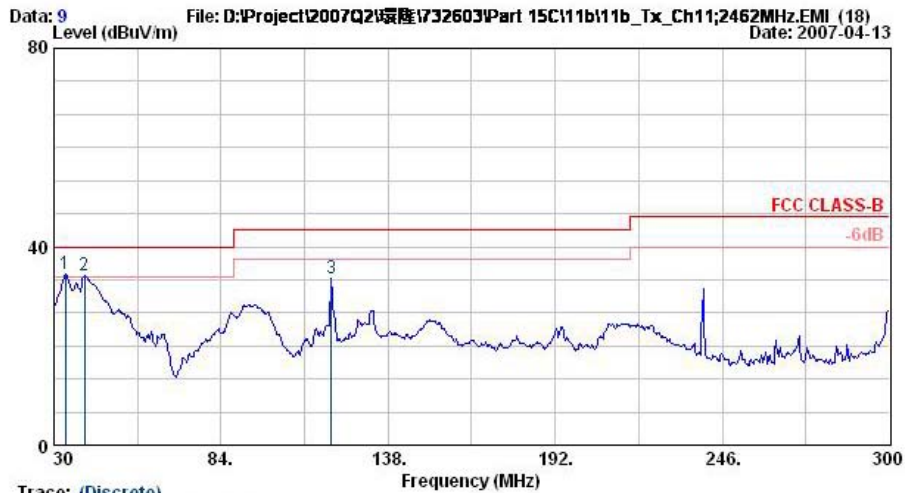

Trace: (Discrete)
 Condition : LF-ANT(951121) VERTICAL
 EUT : AP/Router
 Power : 120Vac/60Hz
 Model : FR 732603
 Mode : WLAN 11b_Tx_Ch11;2462MHz
 Data Rate : 11

	Freq	Level	Over	Limit	Read	Antenna	Cable	Preamp	Ant	Table	Remark
	MHz	dBuV/m	dB	dBuV/m	dBuV	dB/m	dB	dB	cm	deg	
1 @	33.78	34.41	-5.59	40.00	48.02	16.84	0.87	31.32	100	204	Peak
2 @	39.99	34.21	-5.79	40.00	50.99	13.51	0.92	31.21	---	---	Peak
3 @	119.64	33.53	-9.97	43.50	50.48	12.50	1.63	31.08	---	---	Peak

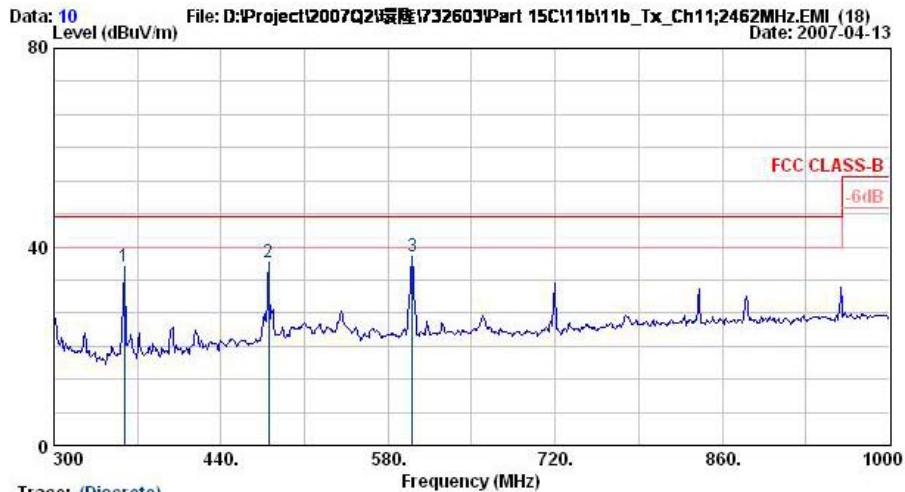

Trace: (Discrete)
 Condition : LF-ANT(951121) VERTICAL
 EUT : AP/Router
 Power : 120Vac/60Hz
 Model : FR 732603
 Mode : WLAN 11b_Tx_Ch11;2462MHz
 Data Rate : 11

	Freq	Level	Over	Limit	Read	Antenna	Cable	Preamp	Ant	Table	Remark
	MHz	dBuV/m	dB	dBuV/m	dBuV	dB/m	dB	dB	cm	deg	
1 @	358.80	35.94	-10.06	46.00	49.21	14.72	2.90	30.89	---	---	Peak
2 @	479.90	36.93	-9.07	46.00	47.20	17.09	3.45	30.81	---	---	Peak
3 @	600.30	38.16	-7.84	46.00	46.48	18.47	3.87	30.66	---	---	Peak



Data: 11 File: D:\Project\2007Q2\环境\732603\Part 15C\11b\11b_Tx_Ch11;2462MHz.EMI (18) Date: 2007-04-13

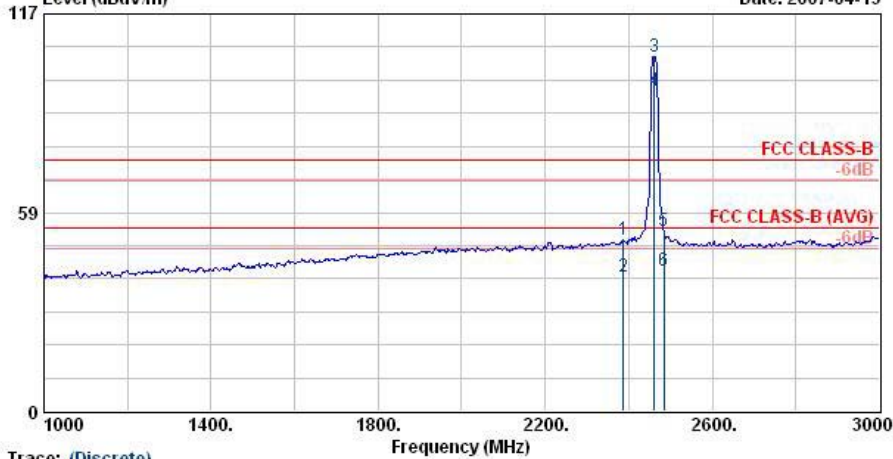

Trace: (Discrete)

Condition : HF-ANT-060410 VERTICAL
EUT : AP/Router
Power : 120Vac/60Hz
Model : FR 732603
Mode : WLAN 11b_Tx_Ch11;2462MHz
Data Rate : 11

Table with 12 columns: Freq, Level, Over Limit, Limit Line, Read Level, Antenna Factor, Cable Loss, Preamp Factor, Ant Pos, Table Pos, Remark. Contains 6 rows of data for peaks at 2388.00, 2462.00, and 2483.95 MHz.

Remark: #3 and #4 Fundamental Signal

Data: 12 File: D:\Project\2007Q2\环境\732603\Part 15C\11b\11b_Tx_Ch11;2462MHz.EMI (18) Date: 2007-04-14

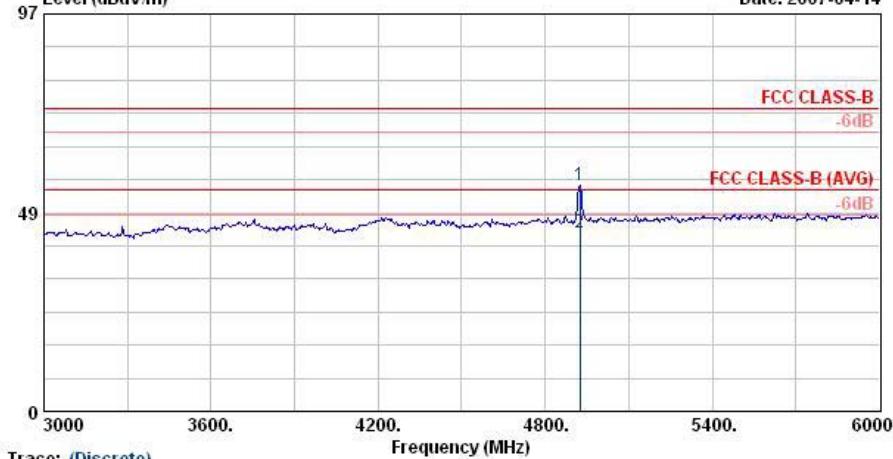

Trace: (Discrete)

Condition : HF-ANT-060410 VERTICAL
EUT : AP/Router
Power : 120Vac/60Hz
Model : FR 732603
Mode : WLAN 11b_Tx_Ch11;2462MHz
Data Rate : 11

Table with 12 columns: Freq, Level, Over Limit, Limit Line, Read Level, Antenna Factor, Cable Loss, Preamp Factor, Ant Pos, Table Pos, Remark. Contains 2 rows of data for peaks at 4924.00 MHz.



Data: 13 File: D:\Project\2007Q2\环境\732603\Part 15C\11b\11b_Tx_Ch11;2462MHz.EMI (18) Date: 2007-04-14

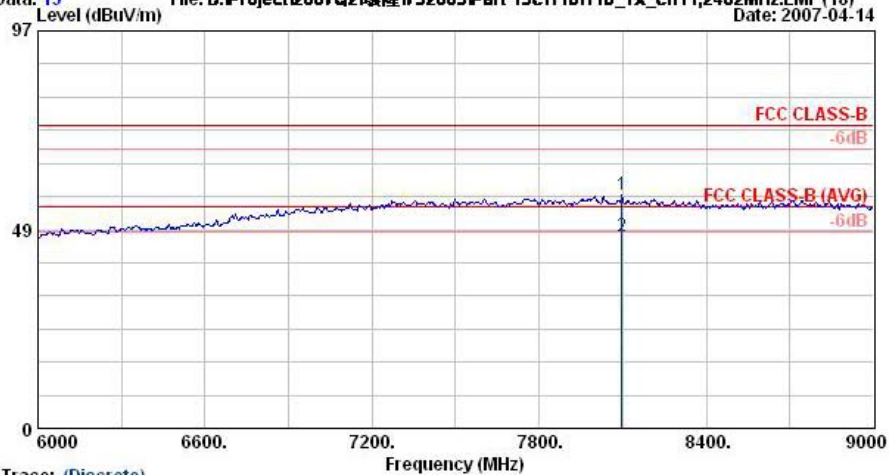

Condition : HF-ANT-060410 VERTICAL
 EUT : AP/Router
 Power : 120Vac/60Hz
 Model : FR 732603
 Mode : WLAN 11b_Tx_Ch11; 2462MHz
 Data Rate : 11

Trace: (Discrete)

	Freq	Level	Over Limit	Limit Line	Read Level	Antenna Factor	Cable Loss	Preamp Factor	Ant Pos	Table Pos	Remark
	MHz	dBuV/m	dB	dBuV/m	dBuV	dB/m	dB	dB	cm	deg	
1	8097.00	56.88	-17.12	74.00	45.33	39.53	7.91	35.90	100	0	Peak
2 @	8097.00	47.00	-7.00	54.00	35.46	39.53	7.91	35.90	100	223	Average

Data: 14 File: D:\Project\2007Q2\环境\732603\Part 15C\11b\11b_Tx_Ch11;2462MHz.EMI (18) Date: 2007-04-14

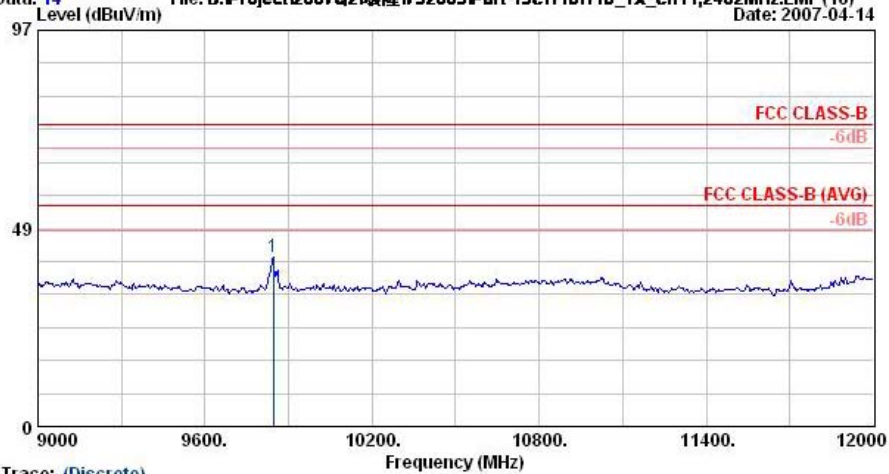

Condition : HF-ANT(8-18)-060918 VERTICAL
 EUT : AP/Router
 Power : 120Vac/60Hz
 Model : FR 732603
 Mode : WLAN 11b_Tx_Ch11; 2462MHz
 Data Rate : 11

Trace: (Discrete)

	Freq	Level	Over Limit	Limit Line	Read Level	Antenna Factor	Cable Loss	Preamp Factor	Ant Pos	Table Pos	Remark
	MHz	dBuV/m	dB	dBuV/m	dBuV	dB/m	dB	dB	cm	deg	
1	9846.00	41.51	-32.49	74.00	78.50	-9.63	9.18	36.54	---	---	Peak