

TEST REPORT

Test Report Reference: F081232E01

Equipment under Test: PRM15 / SWH2400

FCC ID: IXLPRM15SWH2400

IC: 1893A-PRM15

Serial Number: 7122201069

Applicant: deister electronic GmbH

Manufacturer: deister electronic GmbH

**Test Laboratory
(CAB)
accredited by
DATech GmbH
in compliance with DIN EN ISO/IEC 17025
under the
Reg. No. DAT-P-105/99-21
and
FCC Test site registration number 90877**

TEST REPORT REFERENCE: F081232E01

Contents:	Page
1 IDENTIFICATION	3
1.1 APPLICANT	3
1.2 MANUFACTURER	3
1.3 DATES	3
1.4 TEST LABORATORY	4
1.5 RESERVATION	4
1.6 NORMATIVE REFERENCES	4
1.7 TEST RESULTS	4
2 TECHNICAL DATA OF EQUIPMENT	5
2.1 DEVICE UNDER TEST	5
2.2 PERIPHERY DEVICES	5
2.3 SPECIAL EMC MEASURES	5
3 OPERATIONAL STATES AND PHYSICAL BOUNDARIES	6
4 LIST OF MEASUREMENTS	7
5 TEST RESULTS	8
5.1 CONDUCTED EMISSIONS ON POWER SUPPLY LINES (150 kHz to 30 MHz)	8
5.1.1 METHOD OF MEASUREMENT	8
5.1.2 CONDUCTED EMISSION MEASUREMENT ON AC MAINS (150 kHz to 30 MHz)	9
5.2 RADIATED EMISSIONS	12
5.2.1 METHOD OF MEASUREMENT (RADIATED EMISSIONS)	12
5.2.2 PRELIMINARY RADIATED EMISSION TEST (9 kHz to 1 GHz)	19
5.2.3 FINAL RADIATED EMISSION TEST (9 kHz to 30 MHz)	22
5.2.4 FINAL RADIATED EMISSION TEST (30 MHz to 1 GHz)	23
5.3 SPECTRUM MASK	25
5.3.1 METHOD OF MEASUREMENT (SPECTRUM MASK)	25
5.3.2 TEST RESULTS (SPECTRUM MASK)	26
5.4 OCCUPIED BANDWIDTH	28
5.4.1 METHOD OF MEASUREMENT (OCCUPIED BANDWIDTH)	28
5.4.2 TEST RESULTS (OCCUPIED BANDWIDTH)	29
5.5 FREQUENCY TOLERANCE	30
5.5.1 METHOD OF MEASUREMENT (FREQUENCY TOLERANCE)	30
5.5.2 TEST RESULT (FREQUENCY TOLERANCE)	31
6 TEST EQUIPMENT AND ANCILLARIES USED FOR TESTS	32
7 LIST OF ANNEXES	34

TEST REPORT REFERENCE: F081232E01

1 IDENTIFICATION

1.1 APPLICANT

Name:	deister electronic GmbH
Address:	Hermann-Bahlsen-Str. 11 30890 Barsinghausen
Country:	Germany
Name for contact purposes:	Mr. Stefan EICHLER
Tel:	+ 49 51 05 51 61 29
Fax:	+ 49 51 05 51 62 66
e-mail address:	eichler@deister-gmbh.de

1.2 MANUFACTURER

Name:	deister electronic GmbH
Address:	Hermann-Bahlsen-Str. 11 30890 Barsinghausen
Country:	Germany
Name for contact purposes:	Mr. Stefan EICHLER
Tel:	+ 49 51 05 51 61 29
Fax:	+ 49 51 05 51 62 66
e-mail address:	eichler@deister-gmbh.de

1.3 DATES



Date of receipt of test sample:	15 May 2008
Start of test:	04 June 2008
End of test:	30 June 2008

TEST REPORT REFERENCE: F081232E01

1.4 TEST LABORATORY

The tests were carried out at: **PHOENIX TESTLAB GmbH**
Königswinkel 10
D-32825 Blomberg Phone: **+49 (0) 52 35 / 95 00-0**
Germany Fax: **+49 (0) 52 35 / 95 00-10**

accredited by DATech GmbH in compliance with DIN EN ISO/IEC 17025 under Reg. No. DAT-P-105/99-21 and FCC Test site registration number 90877

Test engineer:	Thomas KÜHN		13 August 2008
	Name	Signature	Date
Test report checked:	Bernd STEINER		13 August 2008
	Name	Signature	Date

PHOENIX TESTLAB GmbH
Königswinkel 10
32825 Blomberg
Tel. 0 52 35 / 95 00-0
Fax 0 52 35 / 95 00-10

Stamp

1.5 RESERVATION

This test report is only valid in its original form.

Any reproduction of its contents without written permission of the accredited test laboratory PHOENIX TESTLAB GmbH is prohibited.

The test results herein refer only to the tested sample. PHOENIX TESTLAB GmbH is not responsible for any generalisations or conclusions drawn from these test results concerning further samples. Any modification of the tested samples is prohibited and leads to the invalidity of this test report. Each page necessarily contains the PHOENIX TESTLAB Logo and the TEST REPORT REFERENCE.

1.6 NORMATIVE REFERENCES

- [1] **ANSI C63.4-2003** American National Standard for Methods of Measuring of Radio-Noise Emissions from Low-Voltage Electrical and Electronic Equipment in the Range of 9 kHz to 40 GHz.
- [2] **FCC CFR 47 Part 15 (October 2007)** Radio Frequency Devices
- [3] **RSS-210 Issue 7 (June 2007)** Low-power Licence-exempt Radiocommunication Devices (All Frequency Bands): Category I Equipment
- [4] **RSS-Gen Issue 2 (June 2007)** General Requirements and Information for the Certification of Radiocommunication Equipment
- [5] **FCC Knowledge DataBase document number 174176 (July 2008)** Under what conditions may a dummy load be connected in place of an antenna when calculating AC power line conducted measurements for a Part 15 device?

1.7 TEST RESULTS

The requirements of this test document are fulfilled by the equipment under test. The complete test results are presented in the following.

TEST REPORT REFERENCE: F081232E01

2 TECHNICAL DATA OF EQUIPMENT

2.1 DEVICE UNDER TEST

Type of equipment:	13.56 MHz Reader
Type designation:	PRM15 / SWH2400
FCC ID:	IXLPRM15SWH2400
IC:	1893B-PRM15
Serial No.:	7122201069
Lowest internal frequency:	11.05 MHz
Highest internal frequency:	13.56 MHz
Antenna type:	Integral
Supply Voltage:	8 V DC to 30 V DC
Printed circuit design:	07 02 05
Software Version:	PRM5c15 or SWH2400

The following external I/O cables were used:

Cable	Length	Shielding	Connector
Connection cable (including DC supply lines and Data in/ out lines)	2.5 m *	Yes	12 pole terminal block
-	-	-	-
-	-	-	-
-	-	-	-
-	-	-	-

*: Length during the test

2.2 PERIPHERY DEVICES

The following equipment was used as control unit and ancillary equipment:

During the occupied bandwidth measurements a 13.56 MHz (mifare) transponder card was used.

2.3 SPECIAL EMC MEASURES

The following EMC measures were necessary to reach the documented results:

None.

TEST REPORT REFERENCE: F081232E01

3 OPERATIONAL STATES AND PHYSICAL BOUNDARIES

During all tests the EUT was supplied with a DC supply voltage, which was provided by an external power supply or an AC / DC adaptor type FW 3288 (used only for the conducted emissions on AC-mains).

For the conducted emission measurement on AC-mains the AC / DC adaptor was supplied with 120 V AC / 60 Hz. During this measurement the antenna of the EUT was disconnected and replaced by an antenna termination, which was delivered by the applicant. This was done because the signal of the reader was coupled directly to the LISN so that the fundamental frequency was above the limit also without connection between the EUT and the LISN (EUT powered by a battery). The matching of the antenna termination could be easily checked with the easy trim function of the EUT. There was no difference in position of the trim switch using the antenna termination or the antenna.

If a variation of the supply voltage was necessary, it was done in the range 8.0 V DC to 30 V DC. This range was declared by the applicant as extreme supply voltage range.

If not otherwise stated, the tests were carried out with the EUT powered on in awaiting a transponder card. In this mode a 13.56 MHz carrier were produced by the EUT.

During the measurement of occupied bandwidth a 13.56 MHz card (mifare) was presented in the front of the EUT.

For the whole frequency range a preliminary measurement in a fully anechoic chamber with a measuring distance of 3 m was carried out to determine the frequencies, which were radiated by the EUT.

The final measurements on the detected frequencies were carried out on an outdoor test site without ground plane (for the frequency range 9 kHz to 30 MHz) and on an open area test site with ground plane (for the frequency range 30 MHz to 1 GHz).

During the tests, the EUT was not sealed or labelled with a FCC-label.

The physical boundaries of the Equipment Under Test are shown below.

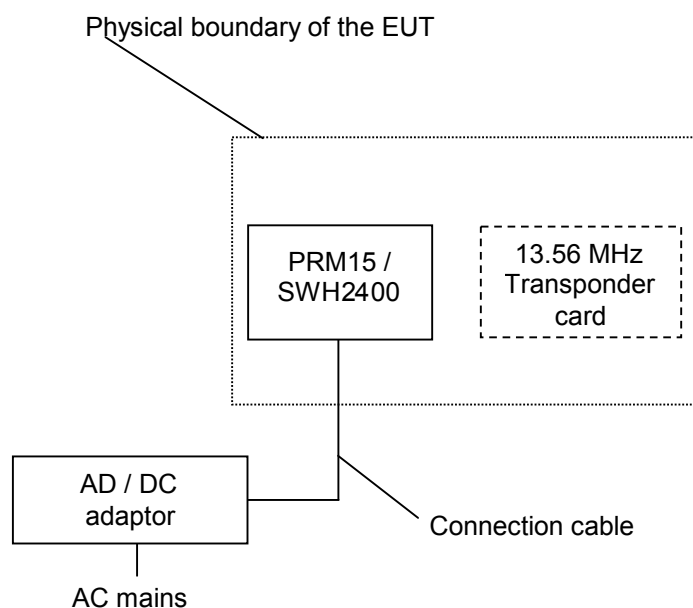

TEST REPORT REFERENCE: F081232E01

4 LIST OF MEASUREMENTS

Application	Frequency range [MHz]	FCC 47 CFR Part 15 section [2]	RSS 210, Issue 7 [3] or RSS-Gen, Issue 2 [4]	Status	Refer page
Conducted emissions on supply line	0.15 - 30	15.207 (a)	7.2.2 [4]	Passed	8 et seq.
Radiated emissions	0.009 - 1,000	15.205 (a) 15.209 (a)	2.6 [3]	Passed	12 et seq.
Radiated emissions	13.553 to 13.567	15.225 (a)	A2.6 [3]	Passed	12 et seq.
Frequency tolerance	13.560 MHz	15.225 (e)	A2.6 [3]	Passed	30 et seq.
20 dB bandwidth	13.560 MHz	15.215 (c)	-	Passed	28 et seq.
99 % bandwidth	13.560 MHz	-	4.6.1 [4]	Passed	Annex D

TEST REPORT REFERENCE: F081232E01

5 TEST RESULTS

5.1 CONDUCTED EMISSIONS ON POWER SUPPLY LINES (150 kHz to 30 MHz)

5.1.1 METHOD OF MEASUREMENT

This test will be carried out in a shielded chamber. Tabletop devices will set up on a non-conducting support with a size of 1 m by 1.5 m and a height of 80 cm above the ground plane. Floor-standing devices will be placed directly on the ground plane. The set up of the Equipment under test will be in accordance to ANSI C63.4-2003 [1].

The frequency range 150 kHz to 30 MHz will be measured with an EMI Receiver set to MAX Hold mode with peak and average detector and a resolution bandwidth of 9 kHz. A scan will be carried out on the phase (or plus pole in case of DC powered devices) of the AC mains network. If levels detected 10 dB below the appropriate limit, this emission will be measured with the average and quasi-peak detector on all lines.

Frequency range	Resolution bandwidth
150 kHz to 30 MHz	9 kHz

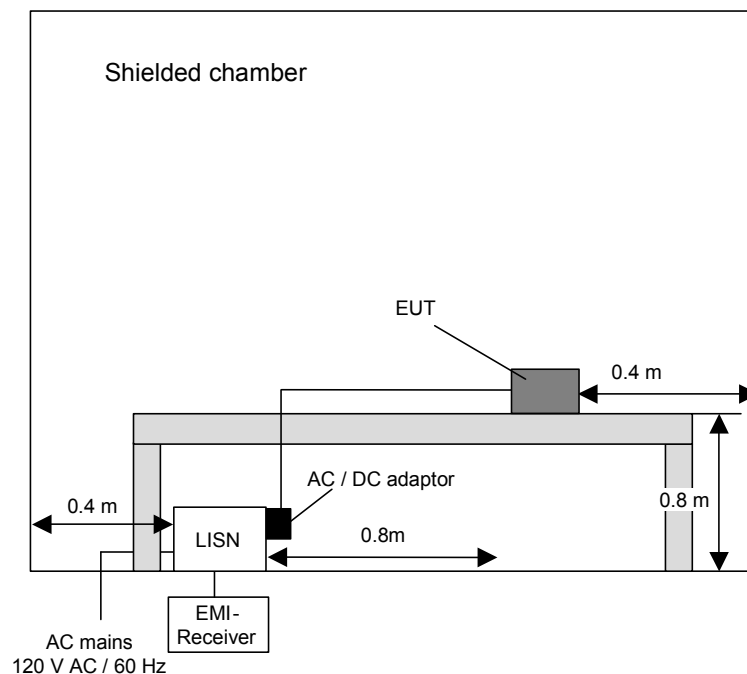

TEST REPORT REFERENCE: F081232E01

5.1.2 CONDUCTED EMISSION MEASUREMENT ON AC MAINS (150 kHz to 30 MHz)

Ambient temperature:	21 °C	Relative humidity:	56 %
----------------------	-------	--------------------	------

Position of EUT: The EUT was set-up on a wooden table of a height of 0.8 m.

Cable guide: All cables of the EUT were fixed on the wooden table. For further information of the cable guide refer to the pictures in annex A of this test report.

Test record: The test was carried out in normal operation mode of the EUT (without reading a TAG). All results are shown in the following.

Power supply: During this test the EUT was powered by an AC/DC adaptor type FW 3288 with 12 V DC.

Remark: This measurement was carried out with the use of an antenna dummy according to FCC Knowledge DataBase document number 174176.

Title: Mains terminal disturbance voltage measurement with protective ground conductor simulation

EUT: PRN15

Manufacturer: deister electronic GmbH

Operating Condition: 120 V / 60 Hz

Test site: PHOENIX TESTLAB Blomberg M4

Operator: Th. KÜHN

Test Specification: Awaiting TAG, operate with antenna

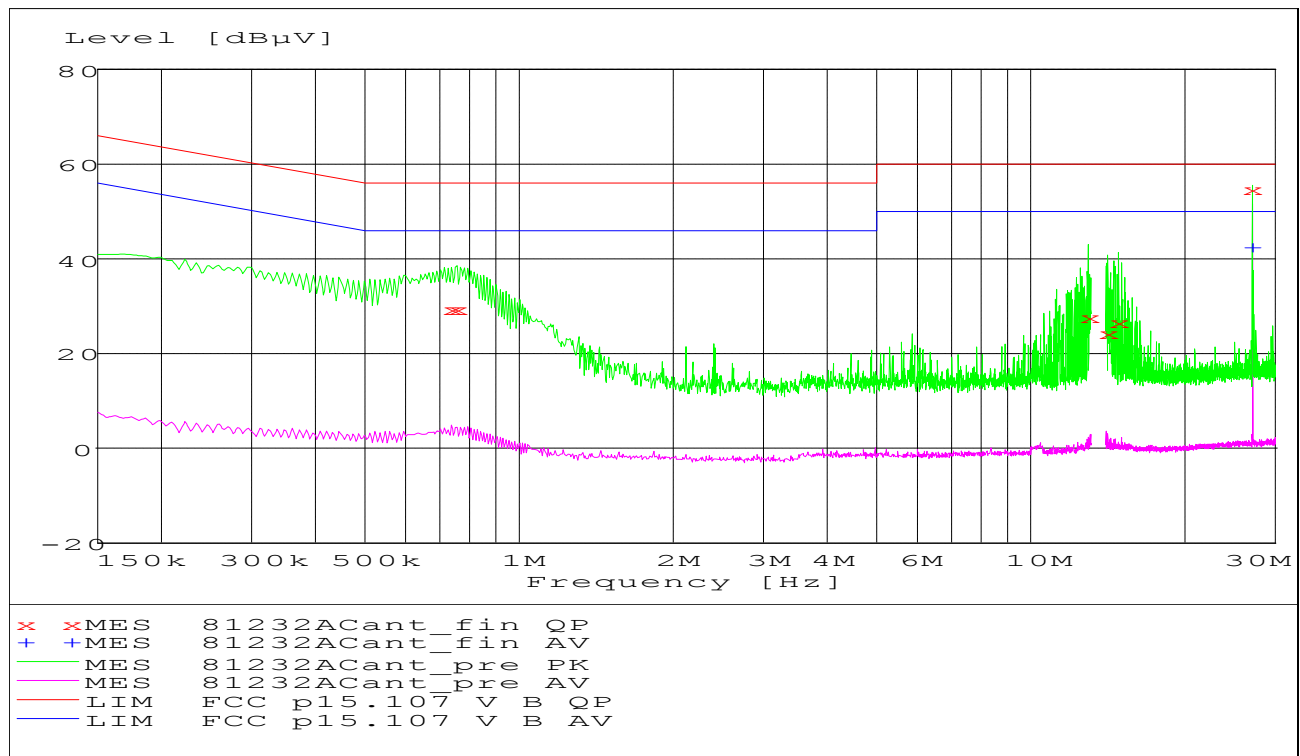

Data record name: 81232ACant

TEST REPORT REFERENCE: F081232E01

Result measured with the quasipeak detector:

(These values are marked in the above diagram by an x)

Frequency MHz	Level dB μ V	Transducer dB	Limit dB μ V	Margin dB	Line	PE
0.736080	29.80	0.8	56.0	26.2	L1	FLO
0.751560	29.80	0.8	56.0	26.2	L1	FLO
12.924420	28.10	1.7	60.0	31.9	N	FLO
14.120700	24.40	1.8	60.0	35.6	N	FLO
14.831790	26.60	1.9	60.0	33.4	N	FLO
27.121740	54.90	3.0	60.0	5.1	N	FLO

Data record name: 81232ACant_fin QP

Result measured with the average detector:

(These values are marked in the above diagram by an +)

Frequency MHz	Level dB μ V	Transducer dB	Limit dB μ V	Margin dB	Line	PE
27.121200	42.30	3.0	50.0	7.7	N	FLO

Data record name: 81232ACant_fin AV

Title: Mains terminal disturbance voltage measurement
with protective ground conductor simulation

EUT: PRM 15

Manufacturer: deister electronic GmbH

Operating Condition: 120 V / 60 Hz at PC power supply

Test site: PHOENIX TESTLAB Blomberg M4

Operator: Th. KÜHN

Test Specification: Awaiting TAG, operating with antenna dummy

Comment:

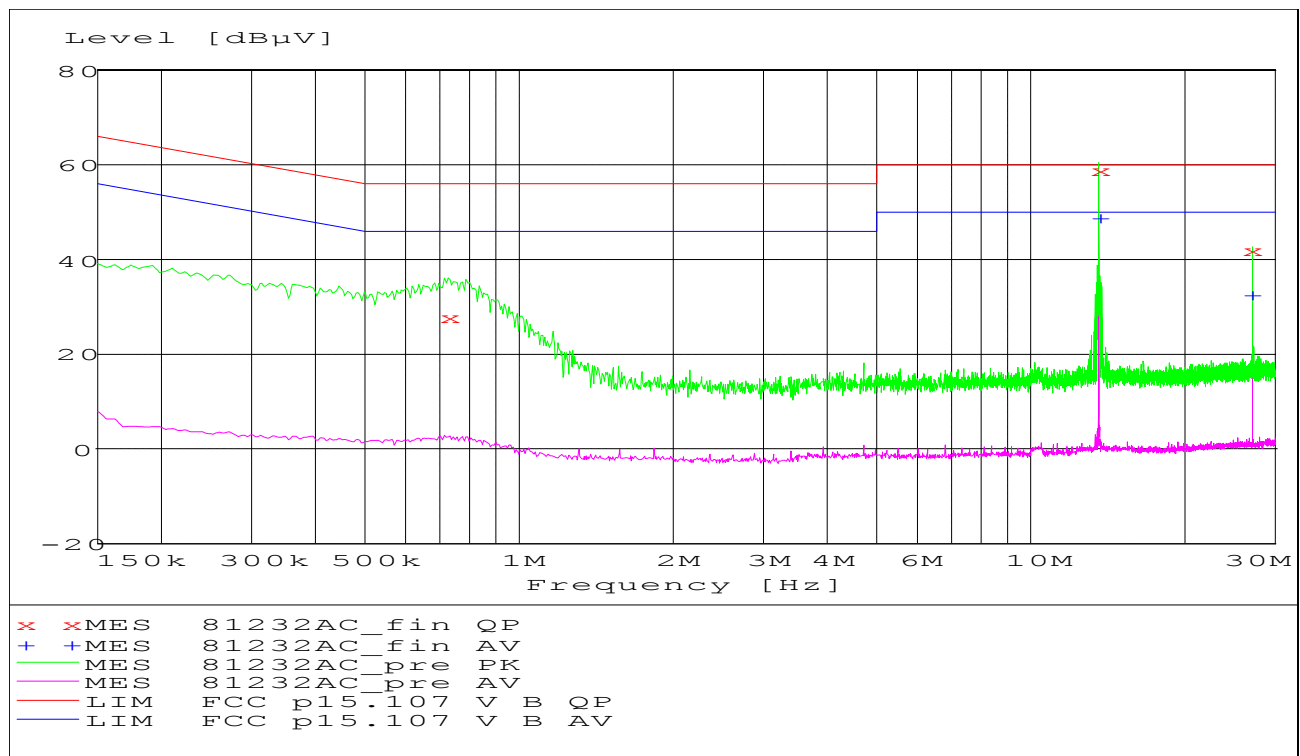

Data record name: 81232AC

TEST REPORT REFERENCE: F081232E01

Result measured with the quasipeak detector:

(These values are marked in the above diagram by an x)

Frequency MHz	Level dB μ V	Transducer dB	Limit dB μ V	Margin dB	Line	PE
0.727980	28.20	0.8	56.0	27.8	L1	FLO
13.560720	59.30	1.8	60.0	0.7	N	FLO
27.121830	42.30	3.0	60.0	17.7	N	FLO

Data record name: 81232AC_fin QP

Result measured with the average detector:

(These values are marked in the above diagram by an +)

Frequency MHz	Level dB μ V	Transducer dB	Limit dB μ V	Margin dB	Line	PE
13.561260	48.70	1.9	50.0	1.3	N	FLO
27.121920	32.40	3.0	50.0	17.6	N	FLO

Data record name: 81232AC_fin AV

Test: Passed

TEST EQUIPMENT USED:
1 - 6

TEST REPORT REFERENCE: F081232E01

5.2 RADIATED EMISSIONS

5.2.1 METHOD OF MEASUREMENT (RADIATED EMISSIONS)

The radiated emission measurement is subdivided into five stages.

- A preliminary measurement carried out in a fully anechoic chamber with a fixed antenna height in the frequency range 9 kHz to 1 GHz.
- A final measurement carried out on an outdoor test side without reflecting ground plane and a fixed antenna height in the frequency range 9 kHz to 30 MHz.
- A final measurement carried out on an open area test side with reflecting ground plane and various antenna height in the frequency range 30 MHz to 1 GHz.
- A preliminary measurement carried out in a fully anechoic chamber with a variable antenna distance and height in the frequency range 1 GHz to GHz.
- A final measurement carried out in a fully anechoic chamber with a fixed antenna height in the frequency range 1 GHz to 110 GHz.

All measurements will be carried out with the EUT working on the middle and upper and lower edge of the assigned frequency band. For this reason the hopping function of the EUT has to be disabled.

Preliminary measurement (9 kHz to 30 MHz):

In the first stage a preliminary measurement will be performed in a shielded room with a measuring distance of 3 meters. Tabletop devices will set up on a non-conducting support with a size of 1 m by 1.5 m and a height of 80 cm. Floor-standing devices will be placed directly on the turntable/ground plane. The set up of the Equipment under test will be in accordance to ANSI C63.4-2003 [1].

The frequency range 9 kHz to 30 MHz will be monitored with a spectrum analyser while the system and its cables will be manipulated to find out the configuration with the maximum emission levels if applicable. The EMI Receiver will be set to MAX Hold mode. The EUT and the measuring antenna will be rotated around their vertical axis to found the maximum emissions.

The resolution bandwidth of the spectrum analyser will be set to the following values:

Frequency range	Resolution bandwidth
9 kHz to 150 kHz	200 Hz
150 kHz to 30 MHz	10 kHz

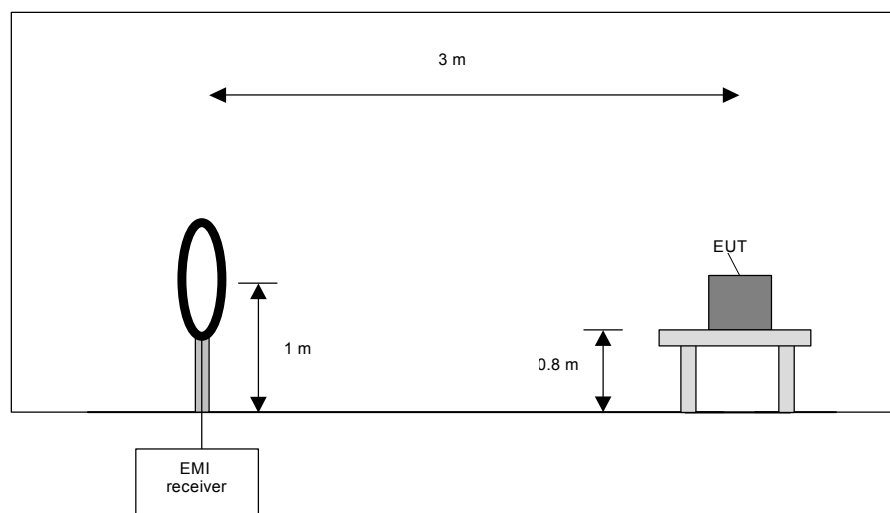

TEST REPORT REFERENCE: F081232E01

Preliminary measurement procedure:

Prescans were performed in the frequency range 9 kHz to 150 kHz and 150 kHz to 30 MHz.

The following procedure will be used:

- 1) Monitor the frequency range at horizontal polarisation and a EUT azimuth of 0 °.
- 2) Manipulate the system cables within the range to produce the maximum level of emission.
- 3) Rotate the EUT by 360 ° to maximize the detected signals.
- 4) Make a hardcopy of the spectrum.
- 5) Measure the frequencies of highest detected emission with a lower span and resolution bandwidth to increase the accuracy and note the frequency value.
- 6) Repeat steps 1) to 5) with the other orthogonal axes of the EUT (because of EUT is a module and might be used in a handheld equipment application).
- 7) Rotate the measuring antenna and repeat steps 1) to 5).

Final measurement (9 kHz to 30 MHz):

In the second stage a final measurement will be performed on an open area test site with no conducting ground plane in a measuring distances of 3 m, 10 m and 30 m. In the case where larger measuring distances are required the results will be extrapolated based on the values measured on the closer distances according to Section 15.31 (f) (2) [2]. The final measurement will be performed with a EMI Receiver set to Quasi Peak detector except for the frequency bands 9 kHz to 90 kHz and 110 kHz to 490 kHz where an average detector will be used according Section 15.209 (d) [2].

On the during the preliminary measurement detected frequencies the final measurement will be performed while rotating the EUT and the measuring antenna in the range of 0 ° to 360 ° around their vertical axis until the maximum value is found.

The resolution bandwidth of the EMI Receiver will be set to the following values:

Frequency range	Resolution bandwidth
9 kHz to 150 kHz	200 Hz
150 kHz to 30 MHz	9 kHz

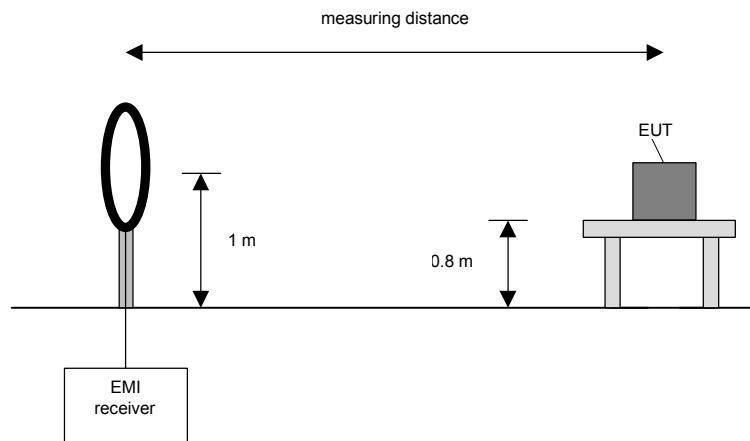

TEST REPORT REFERENCE: F081232E01

Final measurement procedure:

The following procedure will be used:

- 1) Monitor the frequency range with the measuring antenna at vertical orientation parallel to the EUT at an azimuth of 0 °.
- 2) Rotate the EUT by 360 ° to maximize the detected signals and note the azimuth and orientation.
- 3) Rotate the measuring antenna to find the maximum and note the value.
- 4) Rotate the measuring antenna and repeat steps 1) to 3) until the maximum value is found.
- 5) Repeat steps 1) to 4) with the other orthogonal axes of the EUT (because of EUT is a module and might be used in a handheld equipment application).

Preliminary measurement (30 MHz to 1 GHz)

In the first stage a preliminary measurement will be performed in a fully anechoic chamber with a measuring distance of 3 meter. Tabletop devices will set up on a non-conducting support with a size of 1 m by 1.5 m and a height of 80 cm. Floor-standing devices will be placed directly on the turntable/ground plane. The set up of the Equipment under test will be in accordance to ANSI C63.4-2003 [1].

The frequency range 30 MHz to 1 GHz will be measured with an EMI Receiver set to MAX Hold mode and a resolution bandwidth of 100 kHz. The measurement will be performed in horizontal and vertical polarisation of the measuring antenna and while rotating the EUT in its vertical axis in the range of 0 ° to 360 °.

The resolution bandwidth of the EMI Receiver will be set to the following values:

Frequency range	Resolution bandwidth
30 MHz to 230 MHz	100 kHz
230 MHz to 1 GHz	100 kHz

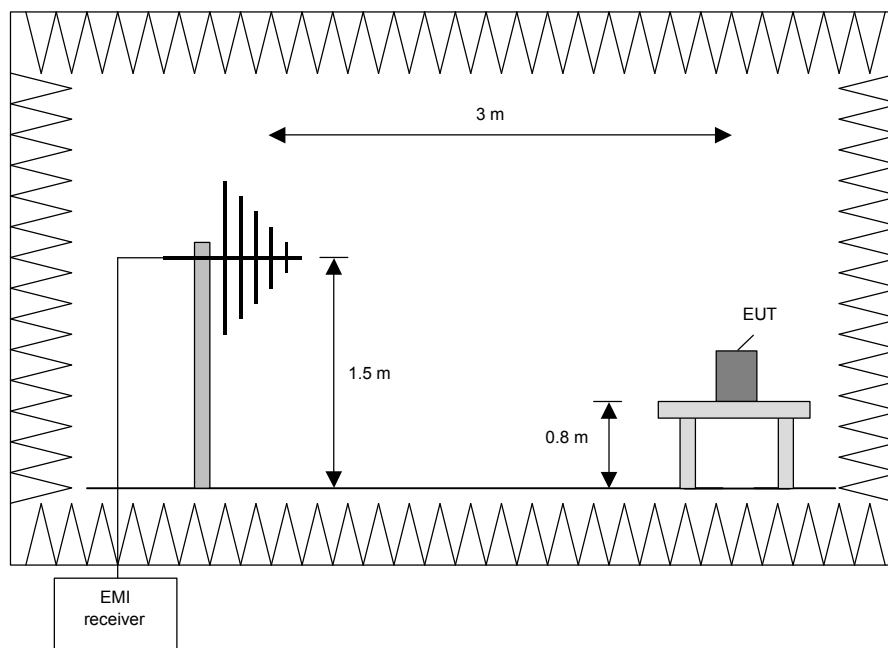

TEST REPORT REFERENCE: F081232E01

Procedure preliminary measurement:

Prescans were performed in the frequency range 30 MHz to 230 MHz and 230 MHz to 1 GHz.
The following procedure will be used:

1. Monitor the frequency range at horizontal polarisation and a EUT azimuth of 0 °.
2. Manipulate the system cables within the range to produce the maximum level of emission.
3. Rotate the EUT by 360 ° to maximize the detected signals.
4. Make a hardcopy of the spectrum.
5. Measure the frequency of the detected emissions with a lower span and resolution bandwidth to increase the accuracy and note the frequency value.
6. Repeat 1) to 4) with the other orthogonal axes of the EUT (because of EUT is a module and might be used in a handheld equipment application).
7. Repeat 1) to 5) with the vertical polarisation of the measuring antenna.

Final measurement (30 MHz to 1 GHz)

A final measurement on an open area test site will be performed on selected frequencies found in the preliminary measurement. During this test the EUT will be rotated in the range of 0 ° to 360 °, the measuring antenna will be set to horizontal and vertical polarisation and raised and lowered in the range from 1 m to 4 m to find the maximum level of emissions.

The resolution bandwidth of the EMI Receiver will be set to the following values:

Frequency range	Resolution bandwidth
30 MHz to 1 GHz	120 kHz

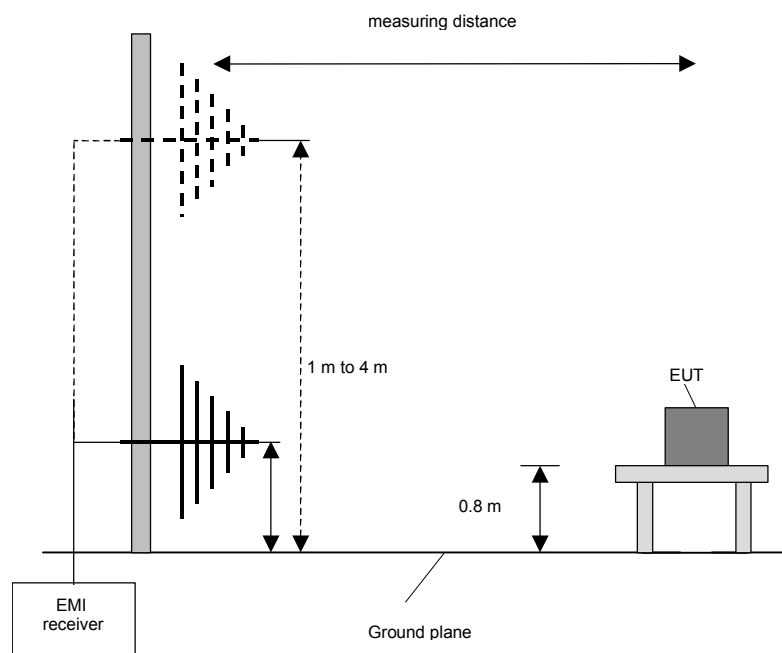

TEST REPORT REFERENCE: F081232E01

Procedure final measurement:

The following procedure will be used:

- 1) Measure on the selected frequencies at an antenna height of 1 m and a EUT azimuth of 23 °.
- 2) Move the antenna from 1 m to 4 m and note the maximum value at each frequency.
- 3) Rotate the EUT by 45 ° and repeat 2) until an azimuth of 337 ° is reached.
- 4) Repeat 1) to 3) for the other orthogonal antenna polarization.
- 5) Move the antenna and the turntable to the position where the maximum value is detected.
- 6) Measure while moving the antenna slowly +/- 1 m.
- 7) Set the antenna to the position where the maximum value is found.
- 8) Measure while moving the turntable +/- 45 °.
- 9) Set the turntable to the azimuth where the maximum value is found.
- 10) Measure with Final detector (QP and AV) and note the value.
- 11) Repeat 5) to 10) for each frequency.
- 12) Repeat 1) to 11) for each orthogonal axes of the EUT (because of EUT is a module and might be used in a handheld equipment application).

Preliminary and final measurement (1 GHz to 110 GHz)

This measurement will be performed in a fully anechoic chamber. Tabletop devices will set up on a non-conducting support with a size of 1 m by 1.5 m and a height of 80 cm. Floor-standing devices will be placed directly on the turntable/ground plane. The set up of the Equipment under test will be in accordance to ANSI C63.4-2003 [1].

Preliminary measurement (1 GHz to 110 GHz)

The frequency range will be divided into different sub ranges depending of the frequency range of the used horn antenna. The spectrum analyser set to MAX Hold mode and a resolution bandwidth of 100 kHz. The measurement will be performed in horizontal and vertical polarisation of the measuring antenna, the antenna close to the EUT and while moving the antenna over all sides of the EUT. With the spectrum analyser in CLEAR / WRITE mode the cone of the emission should be found and than the measuring distance will be set to 3 m with the receiving antenna moving in this cone of emission. At this position the final measurement will be carried out.

The resolution bandwidth of the EMI Receiver will be set to the following values:

Frequency range	Resolution bandwidth
1 GHz to 4 GHz	100 kHz
4 GHz to 12 GHz	100 kHz
12 GHz to 18 GHz	100 kHz
18 GHz to 26.5 GHz	100 kHz
26.5 GHz to 40 GHz	100 kHz
40 GHz to 60 GHz	100 kHz
50 GHz to 75 GHz	100 kHz
75 GHz to 110 GHz	100 kHz

TEST REPORT REFERENCE: F081232E01

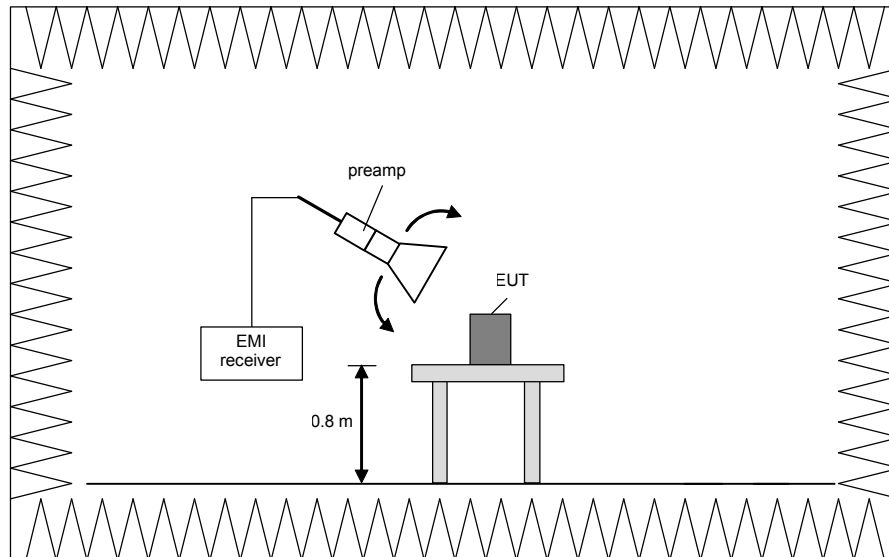

Final measurement (1 GHz to 110 GHz)

The frequency range will be divided into different sub ranges depending of the frequency range of the used horn antenna. The EMI Receiver set to peak and average mode and a resolution bandwidth of 1 MHz. The measurement will be performed in horizontal and vertical polarisation of the measuring antenna and while rotating the EUT in its vertical axis in the range of 0 ° to 360 ° in order to have the antenna inside the cone of radiation.

The resolution bandwidth of the EMI Receiver will be set to the following values:

Frequency range	Resolution bandwidth
1 GHz to 4 GHz	1 MHz
4 GHz to 12 GHz	1 MHz
12 GHz to 18 GHz	1 MHz
18 GHz to 26.5 GHz	1 MHz
26.5 GHz to 40 GHz	1 MHz
40 GHz to 60 GHz	1 MHz
50 GHz to 75 GHz	1 MHz
75 GHz to 110 GHz	1 MHz

TEST REPORT REFERENCE: F081232E01

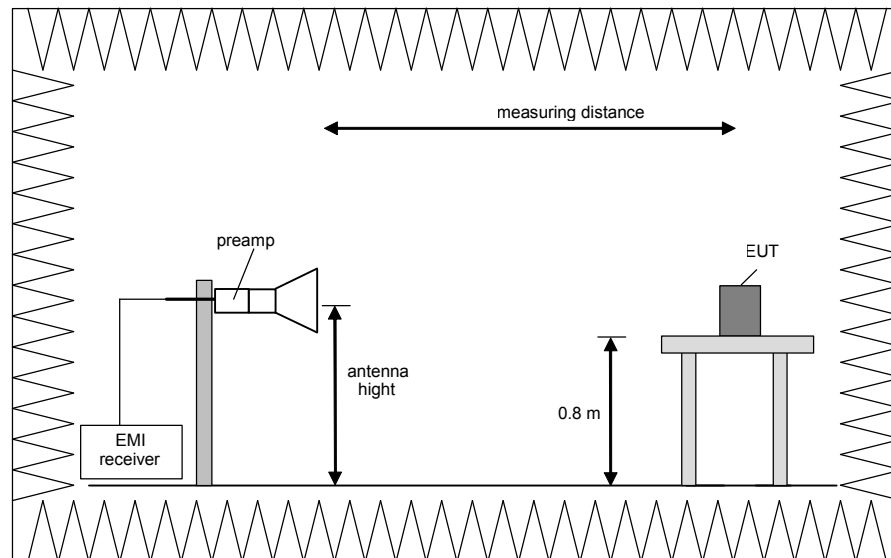

Procedure of measurement:

The measurements were performed in the frequency range 1 GHz to 4 GHz, 4 GHz to 12 GHz, 12 GHz to 18 GHz, 18 GHz to 26.5 GHz, 26.5 GHz to 40 GHz, 40 GHz to 60 GHz, 60 GHz to 75 GHz and 75 GHz to 110 GHz.

The following procedure will be used:

- 1) Monitor the frequency range at horizontal polarisation and move the antenna over all sides of the EUT (if necessary move the EUT to another orthogonal axis).
- 2) Change the antenna polarisation and repeat 1) with vertical polarisation.
- 3) Make a hardcopy of the spectrum.
- 4) Measure the frequency of the detected emissions with a lower span and resolution bandwidth to increase the accuracy and note the frequency value.
- 5) Change the analyser mode to Clear / Write and found the cone of emission.
- 6) Rotate and move the EUT, so that the measuring distance can be enlarged to 3 m and the antenna will be still inside the cone of emission.
- 7) Measure the level of the detected frequency with the correct resolution bandwidth, with the antenna polarisation and azimuth and the peak and average detector, which causes the maximum emission.
- 8) Repeat steps 1) to 7) for the next antenna spot if the EUT is larger than the antenna beamwidth.

Step 1) to 6) are defined as preliminary measurement.

TEST REPORT REFERENCE: F081232E01

5.2.2 PRELIMINARY RADIATED EMISSION TEST (9 kHz to 1 GHz)

Ambient temperature:	20 °C	Relative humidity:	63 %
----------------------	-------	--------------------	------

- Position of EUT: The EUT was set-up on a non-conducting table of a height of 0.8 m. The distance between EUT and antenna was 3 m.
- Cable guide: The cable of the EUT was fixed on the non-conducting table. For further information of the cable guide refer to the pictures in annex A of this test report.
- Test record: The test was carried out in normal operation mode of the EUT (awaiting TAG). All results are shown in the following.
- Remark: The emissions found at 160.220 kHz and 356.112 kHz caused by the measuring system and not by the EUT.

81232_1.wmf: Spurious emissions from 9 kHz to 150 kHz:

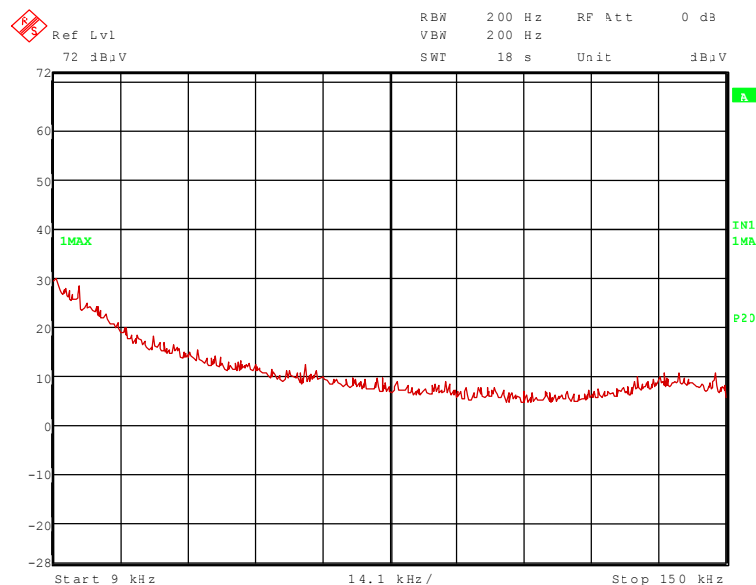

TEST EQUIPMENT USED THE TEST:
29, 31 – 34, 43, 54, 56

TEST REPORT REFERENCE: F081232E01

81232_2.wmf: Spurious emissions from 150 kHz to 1 MHz:

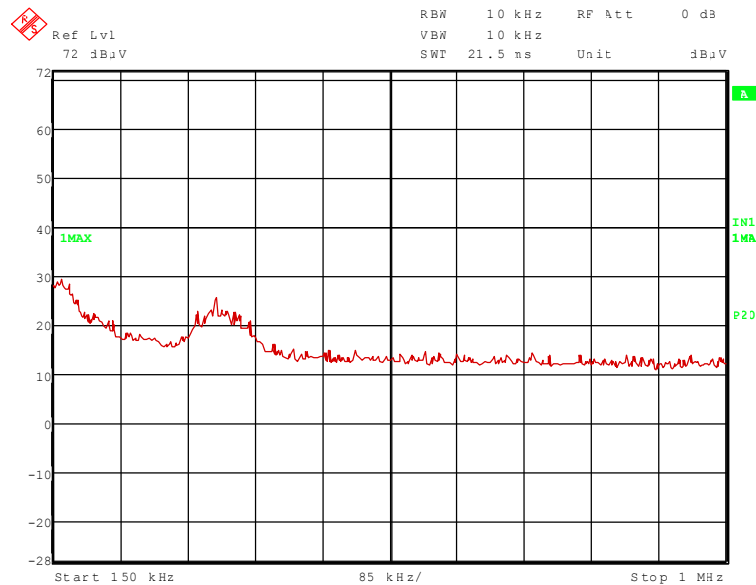

81232_3.wmf: Spurious emissions from 1 MHz to 30 MHz:

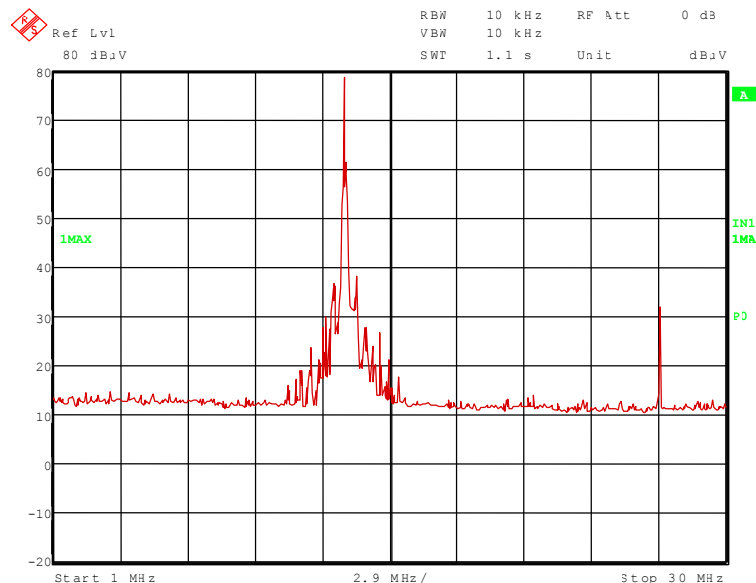

The following emission was found according to FCC 47 CFR Part 15 section 15.209 (a).
27.122MHz

The following frequency was found inside the 13.533 to 13.567 MHz band according to FCC 47 CFR Part 15 section 15.225 [2]:

13.561 MHz.

These frequencies have to be measured on the outdoor test site. The results of this final measurement are shown in the following.

TEST REPORT REFERENCE: F081232E01

81232_4.wmf: Spurious emissions from 30 MHz to 230 MHz:

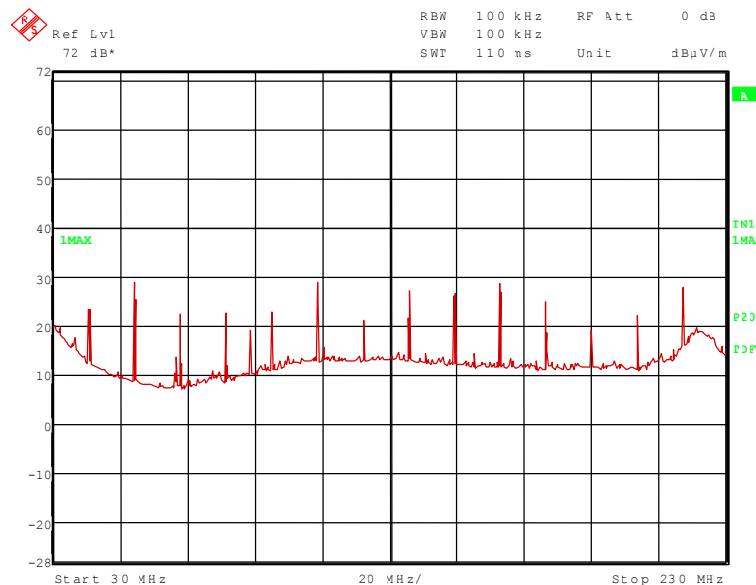

81232_5.wmf: Spurious emissions from 230 MHz to 1 GHz:

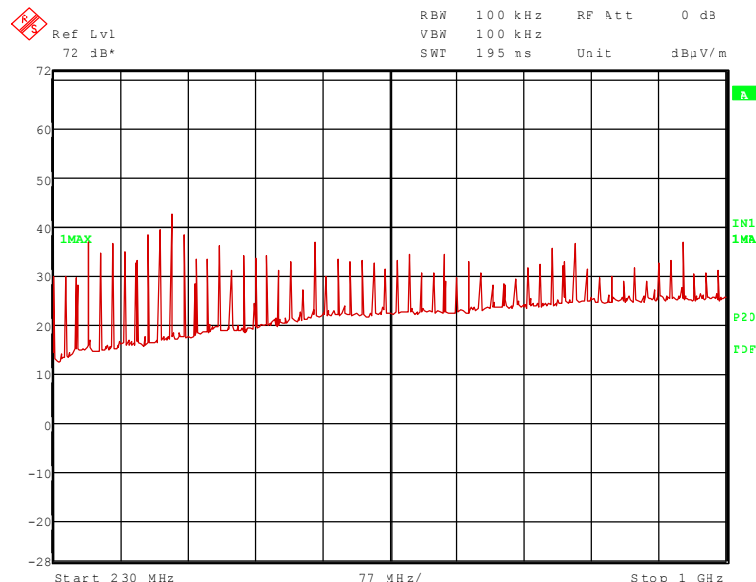

The following frequencies were found during the preliminary radiated emission test:

54.243 MHz, 149.169 MHz, 216.973 MHz, 352.581 MHz, 366.142 MHz, 528.872 MHz, 827.208 MHz and 949.257 MHz

The following frequencies were found inside the restricted bands according to FCC 47 CFR Part 15 section 15.205 [2].

108.486 MHz, 135.608 MHz, 162.730 MHz and 271.216 MHz

These frequencies have to be measured on the open area test site. The results of this final measurement are shown in the following.

TEST REPORT REFERENCE: F081232E01

5.2.3 FINAL RADIATED EMISSION TEST (9 kHz to 30 MHz)

Ambient temperature:	22 °C	Relative humidity:	38 %
----------------------	-------	--------------------	------

- Position of EUT:** The EUT was set-up on a non-conducting table of a height of 0.8 m. The distance between EUT and antenna was 3 m, 10 m and 30 m.
- Cable guide:** The cable of the EUT was fixed on the non-conducting table. For further information of the cable guide refer to the pictures in annex A of this test report.
- Test record:** The test was carried out in normal operation mode of the EUT (awaiting TAG). All results are shown in the following.
- Supply voltage:** The EUT was supplied with 12 V DC, because no difference was noticeable with supply voltages from 8 V DC to 30 V DC.
- Test results:** The test results were calculated with the following formula:

$$\text{Result [dB}\mu\text{V/m]} = \text{reading [dB}\mu\text{V]} + \text{antenna factor [dB/m]}$$

Results with measuring distance of 3 m						
Frequency	Result	Limit	Margin	Detector	Readings	Antenna factor *
	dB μ V/m	dB μ V/m	dB		dB μ V	dB/m
13.561 MHz	98.1	124.0	25.9	QP	78.1	20.0
27.122 MHz	44.7	70.0	25.3	QP	24.7	20.0
Results with measuring distance of 10 m						
Frequency	Result	Limit	Margin	Detector	Readings	Antenna factor *
MHz	dB μ V/m	dB μ V/m	dB		dB μ V	dB/m
13.561 MHz	86.0	104.0	18.0	QP	66.0	20.0
27.122 MHz	25.0	50.0	25.0	QP	5.0	20.0
Results with measuring distance of 30 m						
Frequency	Result	Limit	Margin	Detector	Readings	Antenna factor *
MHz	dB μ V/m	dB μ V/m	dB		dB μ V	dB/m
13.561 MHz	76.0	84.0	8.0	QP	55.9	20.0
27.122 MHz	Signal was below the noise floor of the system					
Measurement uncertainty				+2.2 dB / -3.6 dB		

*: Cable loss included

Test: Passed

TEST EQUIPMENT USED FOR THE TEST:
54, 56, 57

TEST REPORT REFERENCE: F081232E01

5.2.4 FINAL RADIATED EMISSION TEST (30 MHz to 1 GHz)

Ambient temperature:	20 °C	Relative humidity:	53 %
----------------------	-------	--------------------	------

- Position of EUT:** The EUT was set-up on a non-conducting table of a height of 0.8 m. The distance between EUT and antenna was 3 m.
- Cable guide:** The cable of the EUT was fixed on the non-conducting table. For further information of the cable guide refer to the pictures in annex A of this test report.
- Test record:** The test was carried out in normal operation mode of the EUT (awaiting TAG). All results are shown in the following.
- Supply voltage:** The EUT was supplied with 12 V DC, because no difference was noticeable with supply voltages from 8 V DC to 30 V DC.
- Test results:** The test results were calculated with the following formula:

$$\text{Result [dB}\mu\text{V/m]} = \text{reading [dB}\mu\text{V]} + \text{cable loss [dB]} + \text{antenna factor [dB/m]}$$

The measured points and the limit line in the following diagram refer to the standard measurement of the emitted interference in compliance with the above-mentioned standard. The measured points marked with an x are the measured results of the standard final measurement on the open area test site.

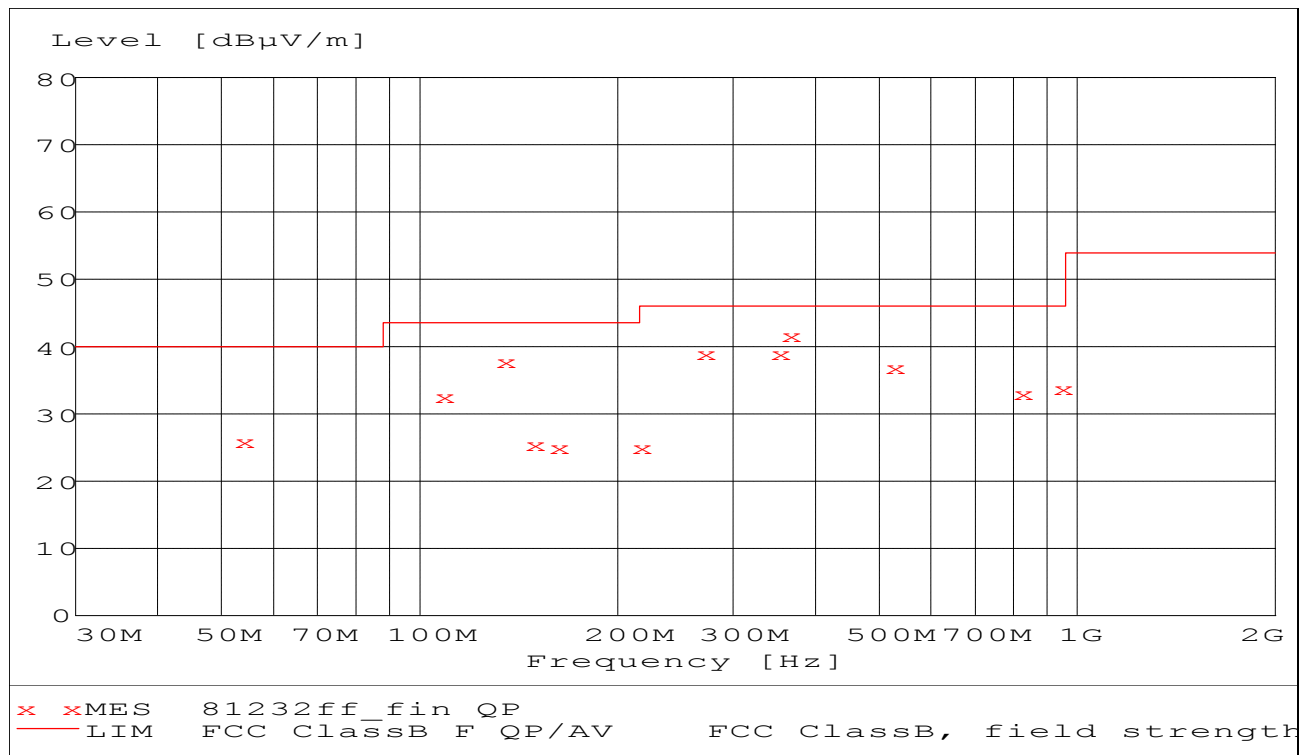

Data record name: 81232ff

TEST REPORT REFERENCE: F081232E01

The results of the standard final measurement on the open area test site are indicated in the table below. The limits as well as the measured results (levels) refer to the above-mentioned standard while taking account of the specified requirements for a 3 m measuring distance.

The measurement time with the quasi-peak measuring detector is 1 second.

Result measured with the quasipeak detector:

(These values are marked in the above diagram by an x)

Spurious emissions outside restricted bands									
Frequency MHz	Result dB μ V/m	Limit dB μ V/m	Margin dB	Readings dB μ V	Antenna factor dB/m	Cable loss dB	Height cm	Azimuth deg	Pol.
54.243	25.9	40.0	14.1	17.9	7.2	0.8	225.0	90.0	Vert.
149.169	25.6	43.5	17.9	12.6	11.7	1.3	225.0	135.0	Hor.
216.973	25.3	46.0	20.7	14.1	9.6	1.6	125.0	180.0	Hor.
352.581	39.2	46.0	6.8	23.0	14.2	2.0	125.0	19.0	Vert.
366.142	41.9	46.0	4.1	25.4	14.4	2.1	123.0	57.0	Vert.
528.872	37	46.0	9.0	16.5	17.9	2.6	100.0	311.0	Vert.
827.208	33	46.0	13.0	7.4	22.4	3.2	148.0	178.0	Vert.
949.257	34	46.0	12.0	6.6	23.9	3.5	152.0	359.0	Vert.
Spurious emissions in restricted bands									
Frequency MHz	Result dB μ V/m	Limit dB μ V/m	Margin dB	Readings dB μ V	Antenna factor dB/m	Cable loss dB	Height cm	Azimuth deg	Pol.
108.486	32.5	43.5	11.0	19.8	11.6	1.1	100.0	92.0	Vert.
135.608	37.8	43.5	5.7	24.6	11.9	1.3	224.0	180.0	Vert.
162.730	25.1	43.5	18.4	12.8	10.9	1.4	175.0	292.0	Hor.
271.216	38.9	46.0	7.1	24.7	12.3	1.9	100.0	45.0	Hor.
Measurement uncertainty				+2.2 dB / -3.6 dB					

The test results were calculated with the following formula:

$$\text{Result [dB}\mu\text{V/m]} = \text{reading [dB}\mu\text{V]} + \text{cable loss [dB]} + \text{antenna factor [dB/m]}$$

Test: Passed

TEST EQUIPMENT USED FOR THE TEST:

14 – 20

TEST REPORT REFERENCE: F081232E01

5.3 SPECTRUM MASK

5.3.1 METHOD OF MEASUREMENT (SPECTRUM MASK)

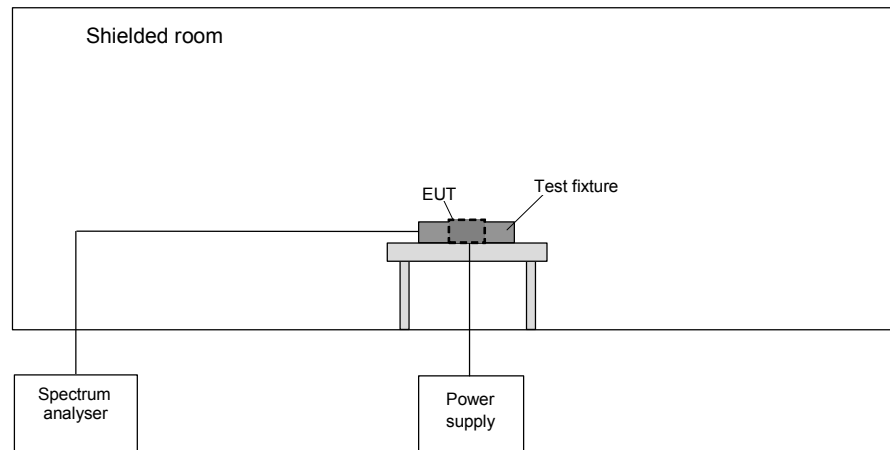

The following procedure will be used for the spectrum mask measurement:

- 1) Place the EUT in the test fixture and switch it on.
- 2) Use the following spectrum analyser settings: $RWB = VBW = 1 \text{ kHz}$, Span = wide enough to capture the whole 13 MHz band including the frequency ranges where the 15.209 limit applies, Trace mode = MaxHold, select the limit line 15225spc
- 3) After trace stabilisation, set the marker to the signal peak.
- 4) The Reference level will be calculated by the amount of the margin of the wanted signal to its 30 m emission limit plus the marker value.
- 5) The whole signal trace has to be below the limit line.

TEST REPORT REFERENCE: F081232E01

5.3.2 TEST RESULTS (SPECTRUM MASK)

Ambient temperature:	21 °C	Relative humidity:	50 %
----------------------	-------	--------------------	------

Supply voltage: The EUT was supplied with 12 V DC.

Test record: The test was carried out while the EUT was reading a TAG.

The Reference level in the plot below was calculated with the following formular:

$$\text{Reflevel} = (\text{Limit}_{\text{OATS}} - \text{Level}_{\text{OATS}}) + \text{Marker value}$$

Where $\text{Limit}_{\text{OATS}} = 84.0 \text{ dB}\mu\text{V}/\text{m}$, $\text{Level}_{\text{OATS}} = 76.0 \text{ dB}\mu\text{V}/\text{m}$ and Marker value = 108 dB μV .

81232sp1.wmf: Spectrum mask at 13.561 MHz:

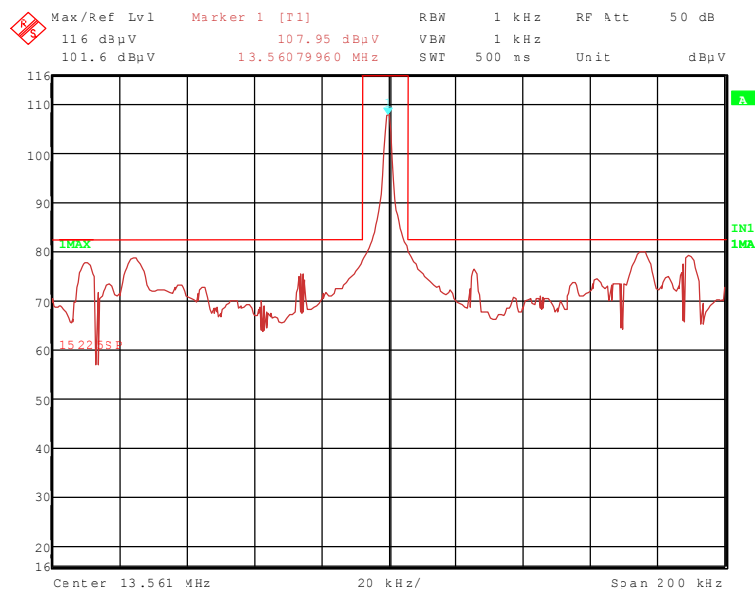

TEST REPORT REFERENCE: F081232E01

81232sp2.wmf: Spectrum mask at 13.561 MHz:

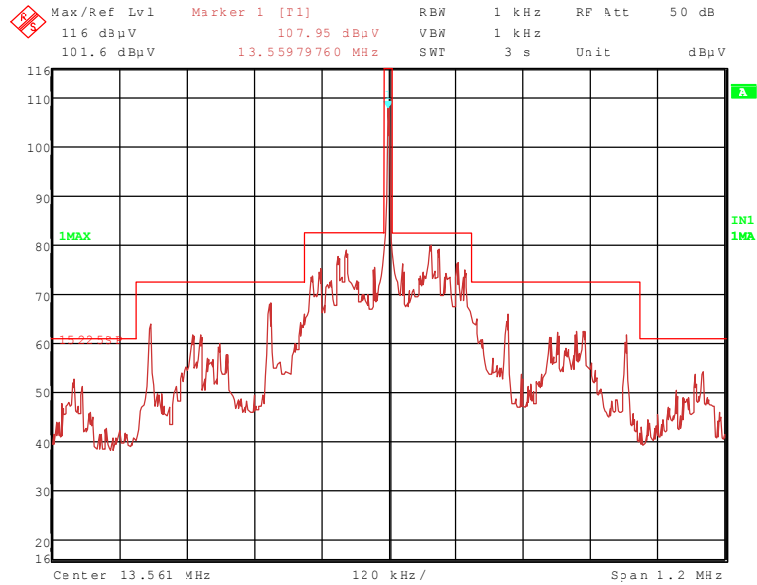

Test result: Passed

TEST EQUIPMENT USED THE TEST:
31, 54, 58, 59

TEST REPORT REFERENCE: F081232E01

5.4 OCCUPIED BANDWIDTH

5.4.1 METHOD OF MEASUREMENT (OCCUPIED BANDWIDTH)

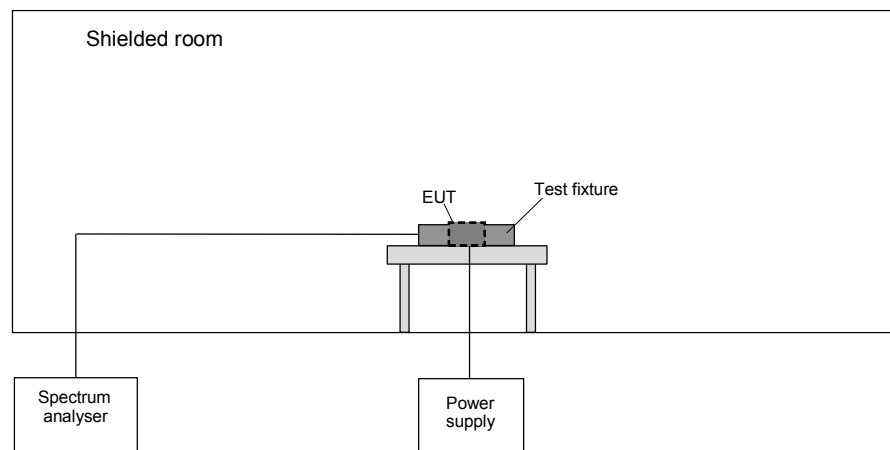

The following procedure will be used for the occupied bandwidth measurement:

- 1) Place the EUT in the test fixture and switch it on.
- 2) Use the following spectrum analyser settings: $RWB = VBW = 10 \text{ kHz}$, $\text{Span} = \text{wide enough to capture app. 1.5 times the 20 dB bandwidth}$, $\text{Trace mode} = \text{MaxHold}$.
- 3) After trace stabilisation, set the first marker and the first display line to the signal peak. Set the second display line 20 dB below the first display line. The second marker and its delta marker shall be set to cross points of the spectrum line and the second display line and note these frequencies.
- 4) Alternatively the 20 dB down function of the analyser could be used, if this function will be applicable to the displayed spectrum.

TEST REPORT REFERENCE: F081232E01

5.4.2 TEST RESULTS (OCCUPIED BANDWIDTH)

Ambient temperature:	20 °C	Relative humidity:	50 %
----------------------	-------	--------------------	------

Supply voltage: The EUT was supplied with 12 V DC.

Test record: The test was carried out while the EUT was reading a TAG.

81232_20.wmf: Occupied bandwidth at 13.561 MHz:

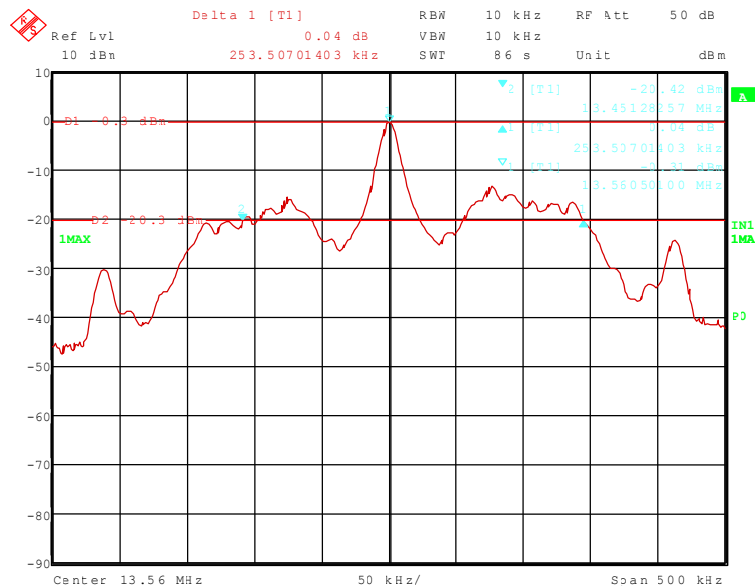

F _L	F _U	BW (F _U - F _L)
13.451283 MHz	13.704790 MHz	253.507 kHz
Measurement uncertainty		< ± 1*10 ⁻⁷

TEST EQUIPMENT USED THE TEST:
31, 54, 58, 59

TEST REPORT REFERENCE: F081232E01

5.5 FREQUENCY TOLERANCE

5.5.1 METHOD OF MEASUREMENT (FREQUENCY TOLERANCE)

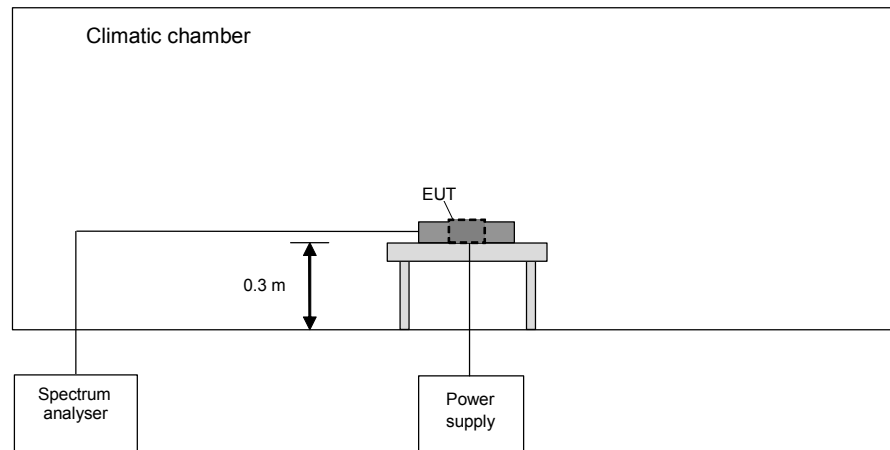

The following procedure will be used:

- 1) Place the EUT in the climatic chamber.
- 2) Switch on the EUT and check the correct function and the settings of the spectrum analyser.
- 3) Switch off the EUT and tune the climatic chamber to a temperature of 50 °C. Wait until the thermal balance is obtained.
- 4) Switch the EUT on and record the frequencies at start-up and 2, 5 and 10 minutes after powering on.
- 5) Repeat 4) with the minimum and the maximum of the supply voltage.
- 6) Switch off the EUT and tune the climatic chamber to a temperature range of 50 °C to –20 °C to in ten-degree steps. Wait until the thermal balance is obtained for every step.
- 7) Switch the EUT on and record the frequencies at start-up and 2, 5 and 10 minutes after powering on.
- 8) Repeat 7) with the minimum and the maximum of the supply voltage at 20 °C.
- 9) Repeat 6) with the next temperature step until –20 °C were reached.

TEST REPORT REFERENCE: F081232E01

5.5.2 TEST RESULT (FREQUENCY TOLERANCE)

Ambient temperature	20 °C	Relative humidity	50 %
---------------------	-------	-------------------	------

Test set-up: For this test the EUT was fixed on a wooden table inside the climatic chamber.

Cable guide: For further information of the cable guide refer to the pictures in annex A of this test report.

Temperature	Supply voltage	Minutes after switch on	Frequency [MHz]	Allowed tolerance	Measured tolerance	Result
50 °C	12 V DC	0	13.560780	±1.356 kHz	-13 Hz	Passed
	12 V DC	2	13.560770	±1.356 kHz	-23 Hz	Passed
	12 V DC	5	13.560750	±1.356 kHz	-43 Hz	Passed
	12 V DC	10	13.560710	±1.356 kHz	-83 Hz	Passed
40 °C	12 V DC	0	13.560750	±1.356 kHz	-43 Hz	Passed
	12 V DC	2	13.560760	±1.356 kHz	-33 Hz	Passed
	12 V DC	5	13.560743	±1.356 kHz	-50 Hz	Passed
	12 V DC	10	13.560727	±1.356 kHz	-66 Hz	Passed
30 °C	12 V DC	0	13.560771	±1.356 kHz	-22 Hz	Passed
	12 V DC	2	13.560744	±1.356 kHz	-49 Hz	Passed
	12 V DC	5	13.560766	±1.356 kHz	-27 Hz	Passed
	12 V DC	10	13.560760	±1.356 kHz	-33 Hz	Passed
20 °C	8 V DC (U _{min})	0	13.560810	±1.356 kHz	+17 Hz	Passed
	12 V DC (U _{nom})		13.560816	±1.356 kHz	+23 Hz	Passed
	30 V DC (U _{max})		13.560816	±1.356 kHz	+23 Hz	Passed
	8 V DC (U _{min})	2	13.560805	±1.356 kHz	+12 Hz	Passed
	12 V DC (U _{nom})		13.560810	±1.356 kHz	+17 Hz	Passed
	30 V DC (U _{max})		13.560816	±1.356 kHz	+23 Hz	Passed
	8 V DC (U _{min})	5	13.560793	±1.356 kHz	0 Hz	Passed
	12 V DC (U _{nom})		13.560783	±1.356 kHz	-10 Hz	Passed
	30 V DC (U _{max})		13.560805	±1.356 kHz	+12 Hz	Passed
	8 V DC (U _{min})	10	13.560773	±1.356 kHz	-20 Hz	Passed
	12 V DC (U _{nom})		13.560793	-	-	Reference
	30 V DC (U _{max})		13.560783	±1.356 kHz	-10 Hz	Passed
10 °C	12 V DC	0	13.560853	±1.356 kHz	+60 Hz	Passed
	12 V DC	2	13.560853	±1.356 kHz	+60 Hz	Passed
	12 V DC	5	13.560846	±1.356 kHz	+53 Hz	Passed
	12 V DC	10	13.560817	±1.356 kHz	+24 Hz	Passed
0 °C	12 V DC	0	13.560913	±1.356 kHz	+120 Hz	Passed
	12 V DC	2	13.560894	±1.356 kHz	+101 Hz	Passed
	12 V DC	5	13.560882	±1.356 kHz	+89 Hz	Passed
	12 V DC	10	13.560885	±1.356 kHz	+92 Hz	Passed
-10 °C	12 V DC	0	13.560933	±1.356 kHz	+140 Hz	Passed
	12 V DC	2	13.560925	±1.356 kHz	+132 Hz	Passed
	12 V DC	5	13.560925	±1.356 kHz	+132 Hz	Passed
	12 V DC	10	13.560925	±1.356 kHz	+132 Hz	Passed
-20 °C	12 V DC	0	13.560932	±1.356 kHz	+139 Hz	Passed
	12 V DC	2	13.560932	±1.356 kHz	+139 Hz	Passed
	12 V DC	5	13.560932	±1.356 kHz	+139 Hz	Passed
	12 V DC	10	13.560941	±1.356 kHz	+148 Hz	Passed
Measurement uncertainty				< ± 1*10 ⁻⁷		

Test result: Passed

TEST EQUIPMENT USED FOR THE TEST:
31, 54, 58, 59, 61

TEST REPORT REFERENCE: F081232E01

6 TEST EQUIPMENT AND ANCILLARIES USED FOR TESTS

TEST REPORT REFERENCE: F081232E01

No.	Test equipment	Type	Manufacturer	Serial No.	PM. No.	Cal. Date	Cal. due
1	Shielded chamber M4	-	Siemens	B83117S1-X158	480088	Weekly verification (system cal.)	
2	Measuring receiver	ESAI	Rohde & Schwarz	831953/001 833181/018	480025 480026	02/27/2008	02/2010
3	LISN	NSLK8128	Schwarzbeck	8128155	480058	01/09/2008	01/2009
4	DC-filter	B84266-A21-E13	Siemens	940164525	480099	Weekly verification (system cal.)	
5	AC-filter	B84299-D87-E3	Siemens	930262292	480097	Weekly verification (system cal.)	
6	EMI-Software	ES-K1	Rohde & Schwarz	-	480111	-	-
14	Open area test site	-	Phoenix Test-Lab	-	480085	Weekly verification (system cal.)	
15	Measuring receiver	ESCS30	Rohde & Schwarz	828985/014	480270	02/27/2008	02/2010
16	Controller	HD100	Deisel	100/670	480139	-	-
17	Turntable	DS420HE	Deisel	420/620/80	480087	-	-
18	Antenna support	AS615P	Deisel	615/310	480086	-	-
19	Antenna	CBL6111 A	Chase	1643	480147	08/01/2007	08/2012
20	EMI Software	ES-K1	Rohde & Schwarz	-	480111	-	-
29	Fully anechoic chamber M20	-	Albatross Projects	B83107-E2439-T232	480303	Weekly verification (system cal.)	
31	Measuring receiver	ESI 40	Rohde & Schwarz	100064	480355	02/25/2008	02/2010
32	Controller	HD100	Deisel	100/670	480326	-	-
33	Turntable	DS420HE	Deisel	420/620/80	480315	-	-
34	Antenna support	AS615P	Deisel	615/310	480187	-	-
35	Antenna	CBL6112 B	Chase	2688	480328	10/11/2005	10/2010
43	RF-cable No. 30	RTK 081	Rosenberger	-	410141	Weekly verification (system cal.)	
54	Power supply	TOE 8852	Toellner	51712	480233	11/27/2006	11/2008
56	Loop antenna	HFH2-Z2	Rohde & Schwarz	832609/014	480059	03/15/2006	03/2011
57	EMI test receiver	ESPC	Rohde & Schwarz	843756/006	480150	02/28/2008	02/2010
58	Loop Antenna Ø = 110 mm	-	Phoenix Test-Lab	-	410084	Weekly verification	
59	RF-cable No. 10	RG223	Phoenix-Test-Lab	-	410102	Weekly verification	
61	Climatic chamber	MK 240	BINDER	05-79022	480462	01/22/2008	07/2009

TEST REPORT REFERENCE: F081232E01

7 LIST OF ANNEXES

ANNEX A	PHOTOGRAPHS OF THE TEST SET-UPS:	7 pages
	PRM15 / SWH2400, test set-up shielded chamber	81232_s.jpg
	PRM15 / SWH2400, test set-up fully anechoic chamber	81232_c.jpg
	PRM15 / SWH2400, test set-up fully anechoic chamber	81232_d.jpg
	PRM15 / SWH2400, test set-up fully anechoic chamber	81232_b.jpg
	PRM15 / SWH2400, test set-up outdoor test site	81232_f.jpg
	PRM15 / SWH2400, test set-up open area test site	81232_i.jpg
	PRM15 / SWH2400, test set-up climatic chamber	81232_t.jpg
ANNEX B	INTERNAL PHOTOGRAPHS OF THE TEST SAMPLE:	6 page
	PRM15 / SWH2400, internal view	81232_7.jpg
	PRM15 / SWH2400, detail view to internal cover	81232_6.jpg
	PRM15 / SWH2400, internal cover removed	81232_4.jpg
	PRM15 / SWH2400, PCB, top view	81232_3.jpg
	PRM15 / SWH2400, PCB, bottom view	81232_2.jpg
	PRM15 / SWH2400, antenna PCB, top view	81232_11.jpg
ANNEX C	EXTERNAL PHOTOGRAPHS OF THE TEST SAMPLE:	3 pages
	PRM15 / SWH2400, 3D-view 1	81232_12.jpg
	PRM15 / SWH2400, 3D-view 2	81232_10.jpg
	PRM15 / SWH2400, type plate view	81232_8.jpg
ANNEX D	ADDITIONAL MEASUREMENT RESULTS FOR INDUSTRY CANADA:	2 pages