

# TEST REPORT

**Test Report Reference: R51291A Edition 1**

**Equipment under Test: PRD5 / SWH-3100**

**Serial Number: -**

**Applicant: deister electronic GmbH**

**Manufacturer: deister electronic GmbH**

**Test Laboratory  
(CAB)  
accredited by  
DATech e.V.  
in compliance with DIN EN ISO/IEC 17025  
under the  
Reg. No. DAT-P-105/99-21,  
FCC Test site registration number 90877  
and  
Industry Canada Test site registration IC3469**

TEST REPORT REFERENCE: R51291A Edition 1

---

<b>Contents:</b>	<b>Page</b>
1 IDENTIFICATION .....	3
1.1 APPLICANT .....	3
1.2 MANUFACTURER .....	3
1.3 DATES .....	3
1.4 TEST LABORATORY .....	4
1.5 RESERVATION .....	4
1.6 NORMATIVE REFERENCES .....	4
1.7 TEST RESULTS .....	4
2 TECHNICAL DATA OF EQUIPMENT .....	5
2.1 DEVICE UNDER TEST .....	5
2.2 PEREPHERY DEVICES .....	5
2.3 SPECIAL EMC MEASURES .....	5
3 OPERATIONAL STATES AND PHYSICAL BOUNDARIES .....	6
4 LIST OF TEST MODULES .....	7
4.1 EMISSION .....	7
5 METHOD OF MEASUREMENT .....	8
5.1 CONDUCTED EMISSIONS ON POWER SUPPLY LINES (150 kHz to 30 MHz) .....	8
5.2 RADIATED EMISSIONS 9 kHz to 30 MHz .....	9
5.3 RADIATED EMISSIONS 30 MHz to 1 GHz .....	11
5.4 FREQUENCY STABILITY WITH RESPECT TO AMBIENT TEMPERATURE AND SUPPLY VOLTAGE .....	13
6 TEST RESULTS EMISSION TEST .....	14
6.1 CONDUCTED EMISSION MEASUREMENT ON AC MAINS (150 kHz to 30 MHz) .....	14
6.2 PRELIMINARY RADIATED EMISSION TEST (9 kHz to 30 MHz) .....	15
6.3 PRELIMINARY RADIATED EMISSION TEST (30 MHz to 1 GHz) .....	17
6.4 FINAL RADIATED EMISSION TEST (9 kHz to 30 MHz) .....	19
6.5 FINAL RADIATED EMISSION TEST (30 MHz to 1 GHz) .....	20
6.6 OCCUPIED BANDWIDTH .....	22
6.7 FREQUENCY TOLLERANCE .....	24
7 TEST EQUIPMENT AND ANCILLARIES USED FOR TESTS .....	26
8 LIST OF ANNEXES .....	30

TEST REPORT REFERENCE: R51291A Edition 1

---

## 1 IDENTIFICATION

### 1.1 APPLICANT

Name:	deister electronic GmbH
Address:	Hermann-Bahlsen-Straße 11 – 13 30890 Barsinghausen
Country:	Germany
Name for contact purposes:	Mr. Stefan Eichler
Tel:	+49 51 05 516-129
Fax:	+49 51 05 516-266
e-mail address:	eichler@deister-gmbh.de

### 1.2 MANUFACTURER

Name:	deister electronic GmbH
Address:	Hermann-Bahlsen-Straße 11 – 13 30890 Barsinghausen
Country:	Germany
Name for contact purposes:	Mr. Stefan Eichler
Tel:	+49 51 05 516-129
Fax:	+49 51 05 516-266
e-mail address:	eichler@deister-gmbh.de

### 1.3 DATES

Date of receipt of test sample:	07 July 2005
Start of test:	25 July 2005
End of test:	19 August 2005

TEST REPORT REFERENCE: R51291A Edition 1

---

## 1.4 TEST LABORATORY

The tests were carried out at: **PHOENIX TESTLAB GmbH**  
**Königswinkel 10**  
**D-32825 Blomberg**                      **Phone: +49 (0) 52 35 / 95 00-0**  
**Germany**                                      **Fax: +49 (0) 52 35 / 95 00-10**

accredited by DATech e.V. in compliance with DIN EN ISO/IEC 17025 under Reg. No. DAT-P-105/99-21,  
FCC Test site registration number 90877 and Industry Canada Test site registration IC3469

Test engineer:	Thomas KÜHN		22 August 2005
	Name	Signature	Date
Test report checked:	Bernd STEINER		22 August 2005
	Name	Signature	Date

**PHOENIX TESTLAB GmbH**  
Königswinkel 10  
32825 Blomberg  
Tel. 0 52 35 / 95 00-0  
Fax 0 52 35 / 95 00-10

Stamp

## 1.5 RESERVATION

This test report is only valid in its original form.

Any reproduction of its contents without written permission of the accredited test laboratory  
PHOENIX TESTLAB GmbH is prohibited.

The test results herein refer only to the tested sample. PHOENIX TESTLAB GmbH is not responsible for any generalisations or conclusions drawn from these test results concerning further samples. Any modification of the tested samples is prohibited and leads to the invalidity of this test report. Each page necessarily contains the PHOENIX TESTLAB Logo and the TEST REPORT REFERENCE.

## 1.6 NORMATIVE REFERENCES

- [1] **ANSI C63.4-2003** American National Standard for Methods of Measuring of Radio-Noise Emissions from Low-Voltage Electrical and Electronic Equipment in the Range of 9 kHz to 40 GHz.
- [2] **FCC 47 CFR Part 15 (April 2005)** Radio Frequency Devices

## 1.7 TEST RESULTS

The requirements of this test document are fulfilled by the equipment under test. The complete test results are presented in the following.

TEST REPORT REFERENCE: R51291A Edition 1

---

## 2 TECHNICAL DATA OF EQUIPMENT

### 2.1 DEVICE UNDER TEST

Type of equipment:	125 kHz and 13.56 MHz Reader
Type designation:	PRD5 / SWH-3100
Serial No.:	-
Highest internal frequency:	13.56 MHz
Antenna type:	Integral

The following external I/O cables were used:

Cable	Length	Shielding	Connector
Connection cable (including DC supply lines and Data in/ out lines)	2.5 m *	No	12 pole terminal block
-	-	-	-
-	-	-	-
-	-	-	-
-	-	-	-

\*: Length during the test

### 2.2 PEREPHERY DEVICES

The following equipment was used as control unit and ancillary equipment:

During all measurements the EUT was reading a 125 kHz or 13.56 MHz transponder card.

### 2.3 SPECIAL EMC MEASURES

The following EMC measures were necessary to reach the documented results:

None

TEST REPORT REFERENCE: R51291A Edition 1

### 3 OPERATIONAL STATES AND PHYSICAL BOUNDARIES

During all tests the EUT was supplied with a DC supply voltage, which was provided by an external power supply or an AC / DC adaptor type FW 2388 (used only for the conducted emissions on AC-mains). For the conducted emission measurement on AC-mains the AC / DC adaptor was supplied with 120 V AC / 60 Hz.

If a variation of the supply voltage was necessary, it was done in the range 8.0 V DC to 16 V DC. This range was declared by the applicant as extreme supply voltage range.

If not otherwise stated, the tests were carried out with the EUT in the in the following operation mode: Reading a passive 13.56 MHz TAG (type ISO14443, A). During a preliminary test, this mode was detected as the operation mode produces higher spurious emissions than reading a passive 125 kHz TAG (type FSK).

For the whole frequency range a preliminary measurement in a fully anechoic chamber with a measuring distance of 3 m was carried out to determine the frequencies, which were radiated by the EUT. The final measurements on the detected frequencies were carried out on an outdoor test site without ground plane (for the frequency range 9 kHz to 30 MHz) and on an open area test site with ground plane (for the frequency range 30 MHz to 1 GHz).

During the tests, the EUT was not sealed and not labelled with a FCC-label.

The physical boundaries of the Equipment Under Test are shown below.

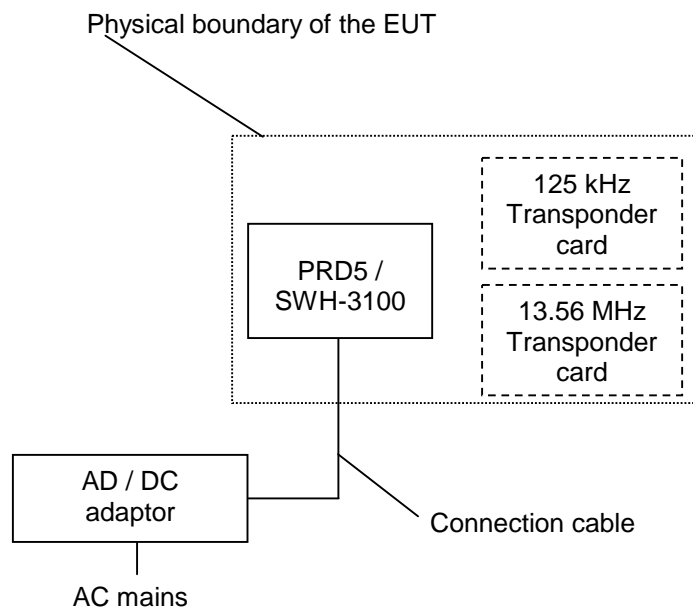

TEST REPORT REFERENCE: R51291A Edition 1

## 4 LIST OF TEST MODULES

### 4.1 EMISSION

Conducted emissions FCC 47 CFR Part 15 section 15.207 (a)[2]					
Application	Frequency range	Limits	Reference standard	Remark	Status
On AC supply line	0.15 to 0.5 MHz	66 to 56 dB $\mu$ V (QP) * 56 to 46 dB $\mu$ V (AV) *	ANSI C63.4 (2003)	-	Passed
	0.5 to 5 MHz	56 dB $\mu$ V (QP) 46 dB $\mu$ V (AV)			
	5 to 30 MHz	60 dB $\mu$ V (QP) 50 dB $\mu$ V (AV)			
*: Decreases with the logarithm of the frequency					
Radiated emissions FCC 47 CFR Part 15 section 15.209 [2]					
Application	Frequency range	Limits (microvolts/meter)	Reference standard	Remark	Status
Intentional radiator	0.009 to 0.49 MHz	2400/f(kHz) at 300 m	ANSI C63.4 (2003);	-	Passed
	0.490 to 1.705 MHz	24000/f(kHz) at 30 m			
	1.705 to 30.0 MHz	30.0 dB $\mu$ V/m at 30 m			
	30 to 88 MHz	40.0 dB $\mu$ V/m at 3 m			
	88 to 216 MHz	43.5 dB $\mu$ V/m at 3 m			
	216 to 960 MHz	46.0 dB $\mu$ V/m at 3 m			
	960 to 1000 MHz	54.0 dB $\mu$ V/m at 3 m			
Radiated emissions FCC 47 CFR Part 15 section 15.225 (a)[2]					
	Frequency range	Limits (microvolts/meter)	Reference standard	Remark	Status
Operation with in the band 13.553 – 13.567 MHz	13.553 to 13.567 MHz	15,848 at 30 m	ANSI C63.4 (2003);	-	Passed
Frequency tolerance over temperature and supply voltage FCC 47 CFR Part 15 section 15.225 (e)[2]					
Application		Limits	Reference standard	Remark	Status
Temperature range -20°C to +50°C and supply voltage 85 to 115 % or new battery		0.01 %	ANSI C63.4 (2003);	-	Passed

TEST REPORT REFERENCE: R51291A Edition 1

## 5 METHOD OF MEASUREMENT

### 5.1 CONDUCTED EMISSIONS ON POWER SUPPLY LINES (150 kHz to 30 MHz)

This test will be carried out in a shielded chamber. Tabletop devices will set up on a non-conducting support with a size of 1 m by 1.5 m and a height of 80 cm above the ground plane. Floor-standing devices will be placed directly on the ground plane. The set up of the Equipment under test will be in accordance to ANSI C63.4-2003 [1].

The frequency range 150 kHz to 30 MHz will be measured with an EMI Receiver set to MAX Hold mode with peak and average detector and a resolution bandwidth of 9 kHz. A scan will be carried out on the phase (or plus pole in case of DC powered devices) of the AC mains network. If levels detected 10 dB below the appropriate limit, this emission will be measured with the average and quasi-peak detector on all lines.

Frequency range	Resolution bandwidth
150 kHz to 30 MHz	9 kHz

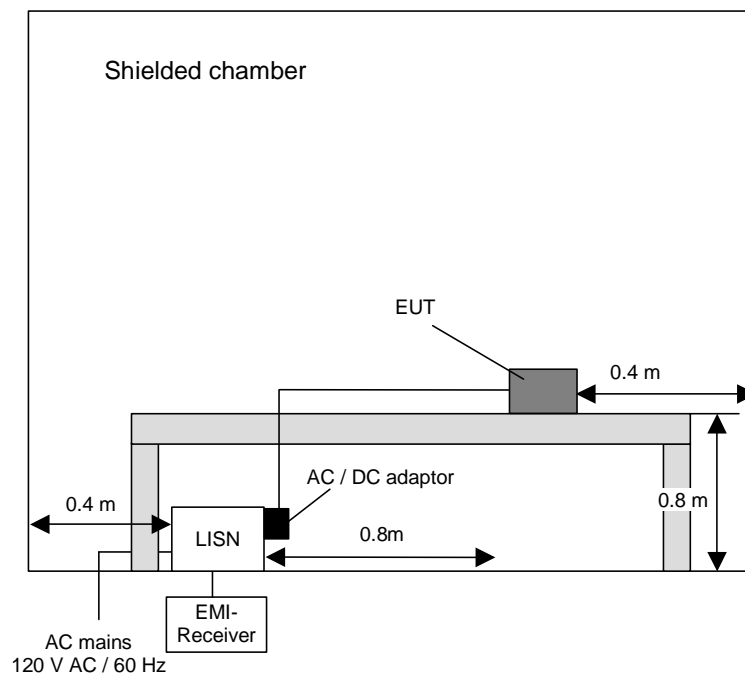



TEST REPORT REFERENCE: R51291A Edition 1

## 5.2 RADIATED EMISSIONS 9 kHz to 30 MHz

The radiated emission measurement is divided into two stages.

### Preliminary measurement:

In the first stage a preliminary measurement will be performed in a shielded room with a measuring distance of 3 meters. Tabletop devices will set up on a non-conducting support with a size of 1 m by 1.5 m and a height of 80 cm. Floor-standing devices will be placed directly on the turntable/ground plane. The set up of the Equipment under test will be in accordance to ANSI C63.4-2003 [1].

The frequency range 9 kHz to 30 MHz will be monitored with a spectrum analyser while the system and its cables will be manipulated to find out the configuration with the maximum emission levels if applicable. The EMI Receiver will be set to MAX Hold mode. The EUT and the measuring antenna will be rotated around their vertical axis to found the maximum emissions.

The resolution bandwidth of the spectrum analyser will be set to the following values:

Frequency range	Resolution bandwidth
9 kHz to 150 kHz	200 Hz
150 kHz to 30 MHz	10 kHz

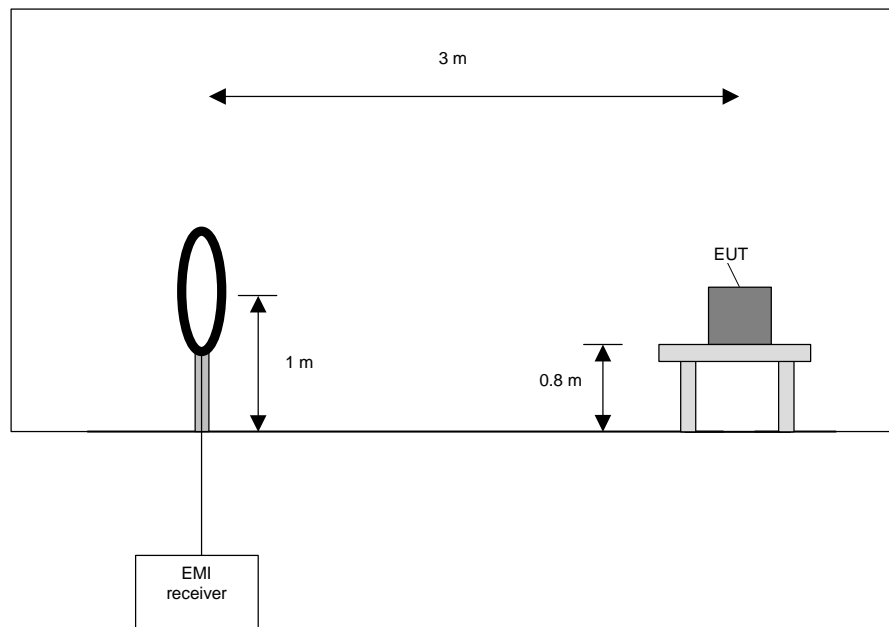

TEST REPORT REFERENCE: R51291A Edition 1

Preliminary measurement procedure:

Prescans were performed in the frequency range 9 kHz to 150 kHz and 150 kHz to 30 MHz.

The following procedure will be used:

- 1) Monitor the frequency range at horizontal polarisation and a EUT azimuth of 0 °.
- 2) Manipulate the system cables within the range to produce the maximum level of emission.
- 3) Rotate the EUT by 360 ° to maximize the detected signals.
- 4) Make a hardcopy of the spectrum.
- 5) Measure the frequencies of highest detected emission with a lower span and resolution bandwidth to increase the accuracy and note the frequency value.
- 6) Repeat steps 1) to 4) with the other orthogonal axes of the EUT.
- 7) Rotate the measuring antenna and repeat steps 1) to 5).

**Final measurement:**

In the second stage a final measurement will be performed on an open area test site with no conducting ground plane in a measuring distances of 3 m, 10 m and 30 m. In the case where larger measuring distances are required the results will be extrapolated based on the values measured on the closer distances according to Section 15.31 (f) (2) [2]. The final measurement will be performed with a EMI Receiver set to Quasi Peak detector except for the frequency bands 9 kHz to 90 kHz and 110 kHz to 490 kHz where an average detector will be used according Section 15.209 (d) [2].

On the during the preliminary measurement detected frequencies the final measurement will be performed while rotating the EUT and the measuring antenna in the range of 0 ° to 360 ° around their vertical axis until the maximum value is found.

The resolution bandwidth of the EMI Receiver will be set to the following values:

Frequency range	Resolution bandwidth
9 kHz to 150 kHz	200 Hz
150 kHz to 30 MHz	9 kHz

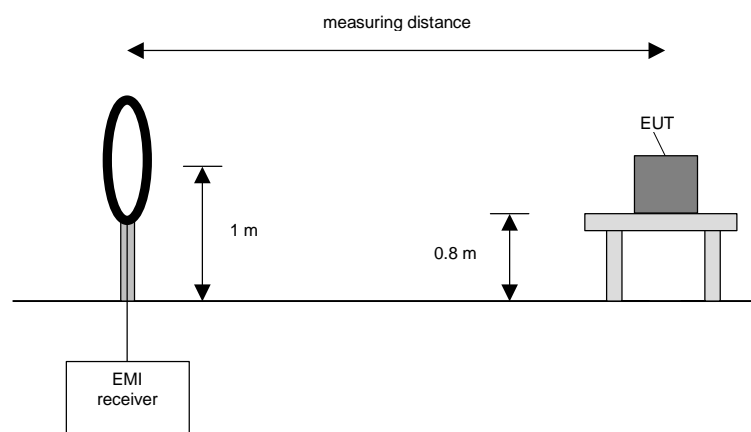

TEST REPORT REFERENCE: R51291A Edition 1

Final measurement procedure:

The following procedure will be used:

- 1) Monitor the frequency range with the measuring antenna at vertical orientation parallel to the EUT at an azimuth of 0 °.
- 2) Rotate the EUT by 360 ° to maximize the detected signals and note the azimuth and orientation.
- 3) Rotate the measuring antenna to find the maximum and note the value.
- 4) Rotate the measuring antenna and repeat steps 1) to 3) until the maximum value is found.
- 5) Repeat steps 1) to 4) with the other orthogonal axes of the EUT if applicable (handheld equipment).

### 5.3 RADIATED EMISSIONS 30 MHz to 1 GHz

The radiated emission measurement is divided into two stages.

**Preliminary measurement:**

In the first stage a preliminary measurement will be performed in a fully anechoic chamber with a measuring distance of 3 meter. Tabletop devices will set up on a non-conducting support with a size of 1 m by 1.5 m and a height of 80 cm. Floor-standing devices will be placed directly on the turntable/ground plane. The set up of the Equipment under test will be in accordance to ANSI C63.4-2003 [1].

The frequency range 30 MHz to 1 GHz will be measured with an EMI Receiver set to MAX Hold mode and a resolution bandwidth of 100 kHz. The measurement will be performed in horizontal and vertical polarisation of the measuring antenna and while rotating the EUT in its vertical axis in the range of 0 ° to 360 °.

The resolution bandwidth of the EMI Receiver will be set to the following values:

Frequency range	Resolution bandwidth
30 MHz to 1 GHz	100 kHz

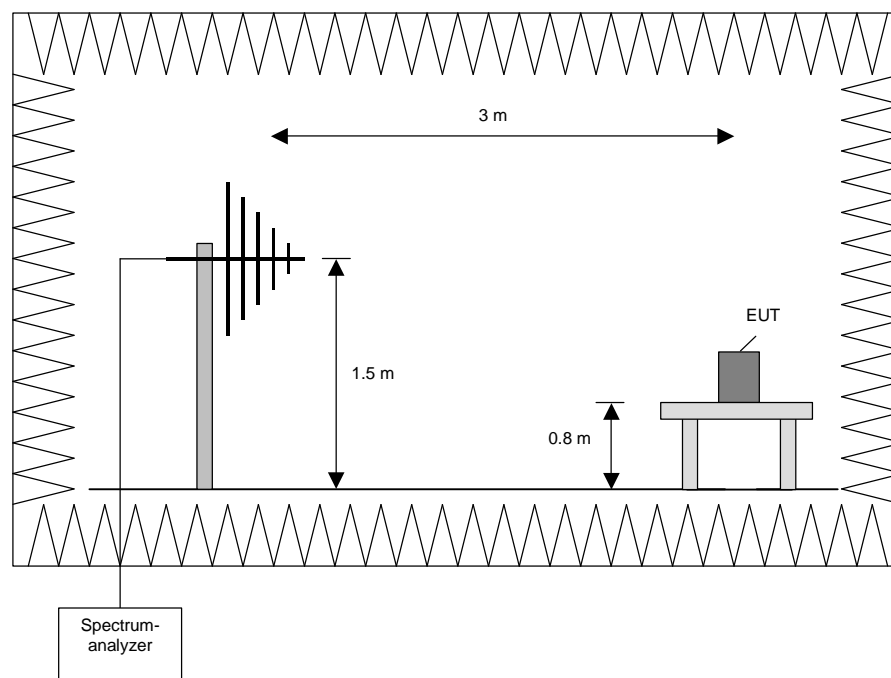

TEST REPORT REFERENCE: R51291A Edition 1

**Procedure preliminary measurement:**

Prescans were performed in the frequency range 30 MHz to 230 MHz and 230 MHz to 1 GHz.  
The following procedure will be used:

1. Monitor the frequency range at horizontal polarisation and a EUT azimuth of 0 °.
2. Manipulate the system cables within the range to produce the maximum level of emission.
3. Rotate the EUT by 360 ° to maximize the detected signals.
4. Make a hardcopy of the spectrum.
5. Measure the frequency of 3 highest detected emissions with a lower span and resolution bandwidth to increase the accuracy and note the frequency value.
6. Repeat steps 1) to 4) with the other orthogonal axes of the EUT.
7. Repeat steps 1) to 5) with the vertical polarisation of the measuring antenna.

**Final Measurement:**

In the second stage a final measurement on an open area test site will be performed on selected frequencies found in the preliminary measurement. During this test the EUT will be rotated in the range of 0 ° to 360 °, the measuring antenna will be set to horizontal and vertical polarisation and raised and lowered in the range from 1 m to 4 m to find the maximum level of emissions.

The resolution bandwidth of the EMI Receiver will be set to the following values:

Frequency range	Resolution bandwidth
30 MHz to 1 GHz	120 kHz

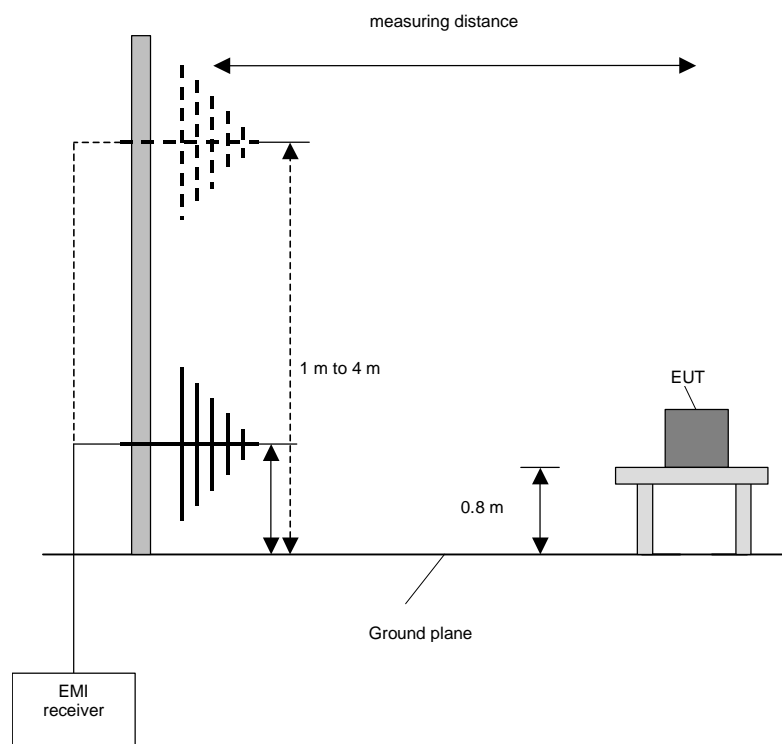

TEST REPORT REFERENCE: R51291A Edition 1

Procedure final measurement:

The following procedure will be used:

- 1) Measure on the selected frequencies at an antenna height of 1 m and a EUT azimuth of 23 °.
- 2) Move the antenna from 1 m to 4 m and note the maximum value at each frequency.
- 3) Rotate the EUT by 45 ° and repeat 2) until an azimuth of 337 ° is reached.
- 4) Repeat 1) to 3) for the other orthogonal antenna polarization.
- 5) Move the antenna and the turntable to the position where the maximum value is detected.
- 6) Measure while moving the antenna slowly +/- 1 m.
- 7) Set the antenna to the position where the maximum value is found.
- 8) Measure while moving the turntable +/- 45 °.
- 9) Set the turntable to the azimuth where the maximum value is found.
- 10) Measure with Final detector (QP or AV) and note the value.
- 11) Repeat 5) to 10) for each frequency.
- 12) Repeat 1) to 11) for each orthogonal axes of the EUT if handheld equipment.

#### 5.4 FREQUENCY STABILITY WITH RESPECT TO AMBIENT TEMPERATURE AND SUPPLY VOLTAGE

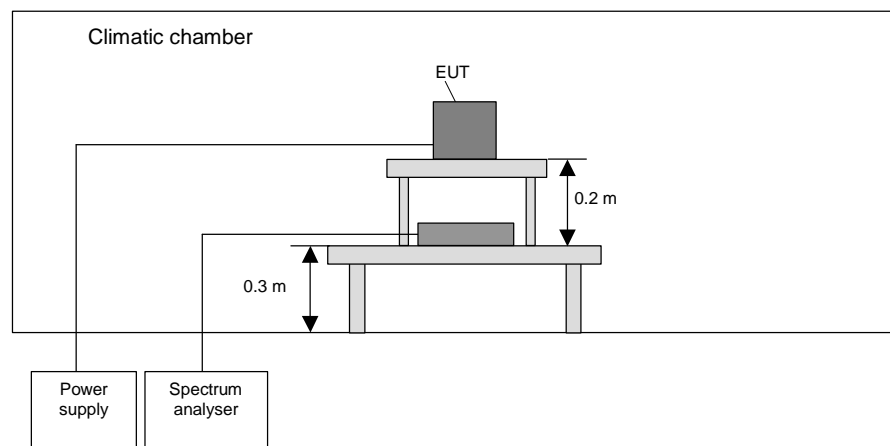

The following procedure will be used:

- 1) Place the EUT in the climatic chamber.
- 2) Switch on the EUT and check the correct function and the settings of the spectrum analyser.
- 3) Switch off the EUT and tune the climatic chamber to a temperature of 50 °C. Wait until the thermal balance is obtained.
- 4) Switch the EUT on and record the frequencies at start-up and 2, 5 and 10 minutes after powering on.
- 5) Repeat 4) with the minimum and the maximum of the supply voltage.
- 6) Switch off the EUT and tune the climatic chamber to a temperature range of 50 °C to -20 °C in ten-degree steps. Wait until the thermal balance is obtained for every step.
- 7) Switch the EUT on and record the frequencies at start-up and 2, 5 and 10 minutes after powering on.
- 8) Repeat 7) with the minimum and the maximum of the supply voltage.
- 9) Repeat 6) with the next temperature step until -20 °C were reached.

TEST REPORT REFERENCE: R51291A Edition 1

## 6 TEST RESULTS EMISSION TEST

### 6.1 CONDUCTED EMISSION MEASUREMENT ON AC MAINS (150 kHz to 30 MHz)

Ambient temperature:	20 °C	Relative humidity:	47 %
----------------------	-------	--------------------	------

Position of EUT: The EUT was set-up on a wooden table of a height of 0.8 m.

Cable guide: All cables of the EUT were fixed on the wooden table. For further information of the cable guide refer to the pictures in annex A of this test report.

Test record: The test was carried out in normal operation mode of the EUT (reading a 13.56 MHz TAG). All results are shown in the following.

Power supply: During this test the EUT was powered by an AC / DC adaptor type FW3288.

Title: AC Powerline Conducted Emission Test with protective ground conductor simulating network

EUT: PRD5 / SWH-3100

Manufacturer: deister electronic GmbH

Operating Condition: Reading 13.56 MHz Transponder

Test site: PHOENIX TESTLAB Blomberg M4

Operator: Th. KÜHN

Test Specification:

Comment:

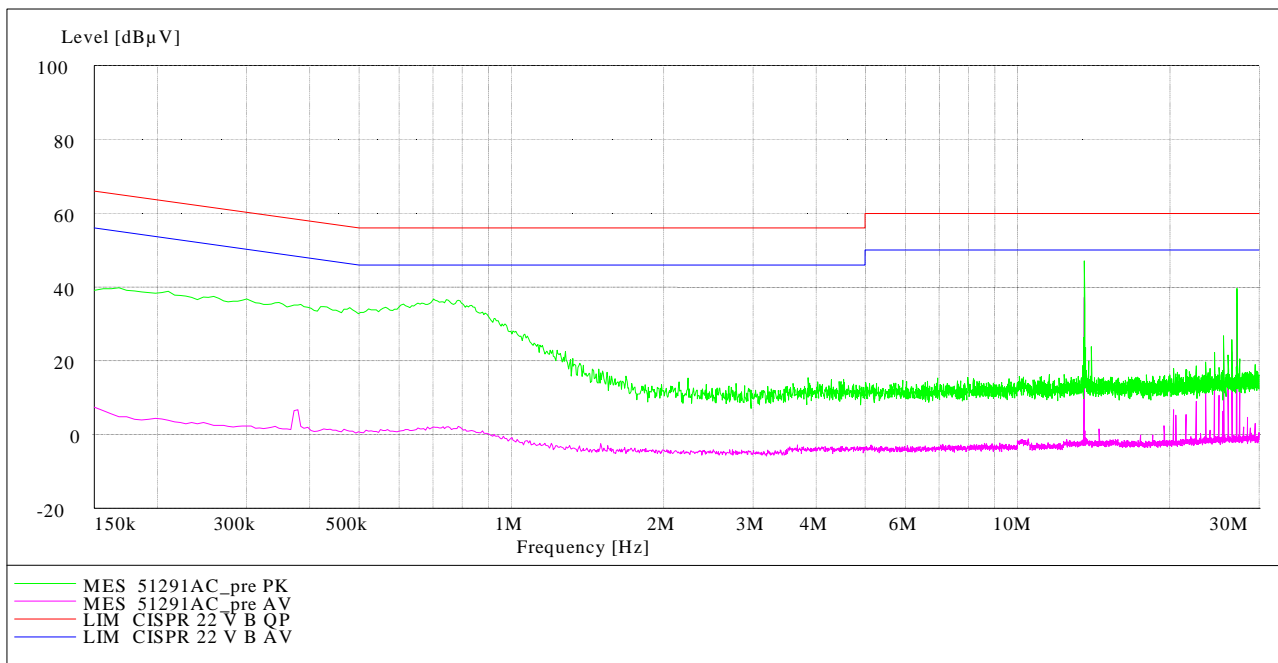

Data record name: 51291AC

Test: Passed

TEST EQUIPMENT USED:

1 - 3, 5, 6

TEST REPORT REFERENCE: R51291A Edition 1

## 6.2 PRELIMINARY RADIATED EMISSION TEST (9 kHz to 30 MHz)

Ambient temperature:	21 °C	Relative humidity:	56 %
----------------------	-------	--------------------	------

- Position of EUT:** The EUT was set-up on a non-conducting table of a height of 0.8 m. The distance between EUT and antenna was 3 m.
- Cable guide:** The cable of the EUT was fixed on the non-conducting table. For further information of the cable guide refer to the pictures in annex A of this test report.
- Test record:** The test was carried out in normal operation mode of the EUT (reading a 125 kHz TAG (for the frequency range up to 1 MHz) or a 13.56 MHz TAG (for the frequency range up to 30 MHz)). All results are shown in the following.
- Remark:** The emissions found at 15.5 kHz, 31 kHz, 47.9 kHz and 62.5 kHz caused by the measuring system and not by the EUT.

51291\_3.wmf: Spurious emissions from 9 kHz to 150 kHz:

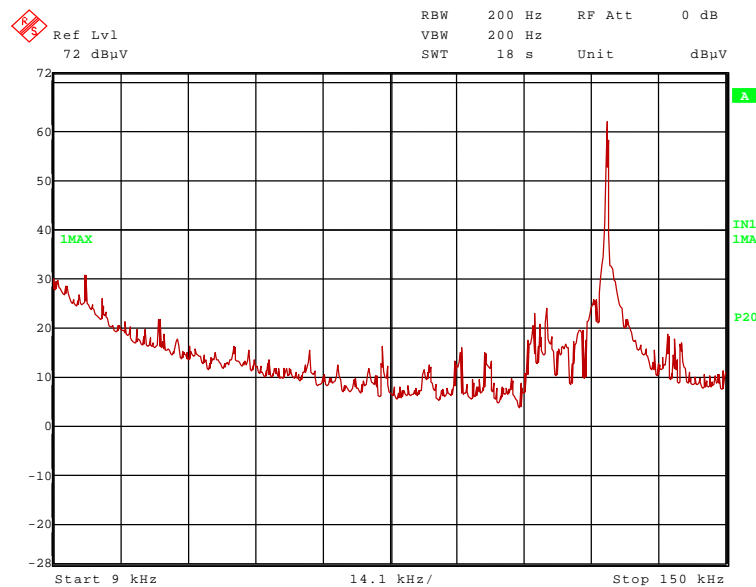

TEST EQUIPMENT USED THE TEST:

29, 31 – 33, 54, 56

TEST REPORT REFERENCE: R51291A Edition 1

51291\_4.wmf: Spurious emissions from 150 kHz to 1 MHz:

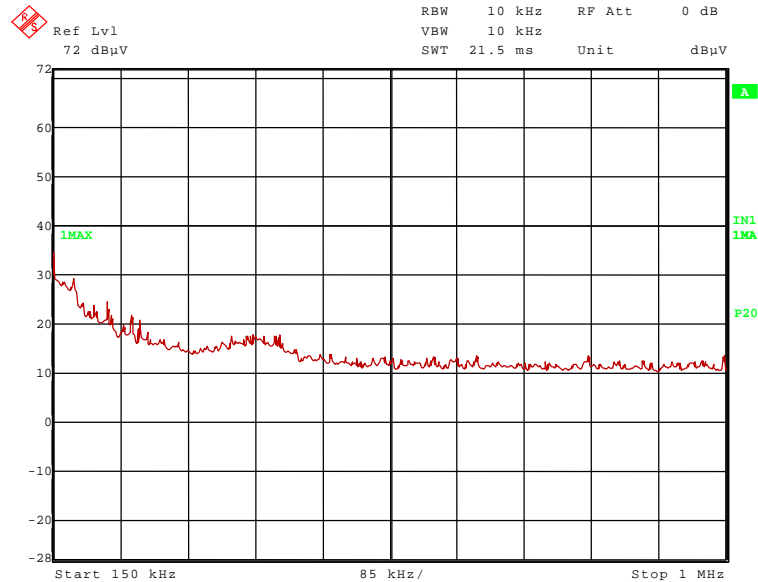

51291\_5.wmf: Spurious emissions from 1 MHz to 30 MHz:

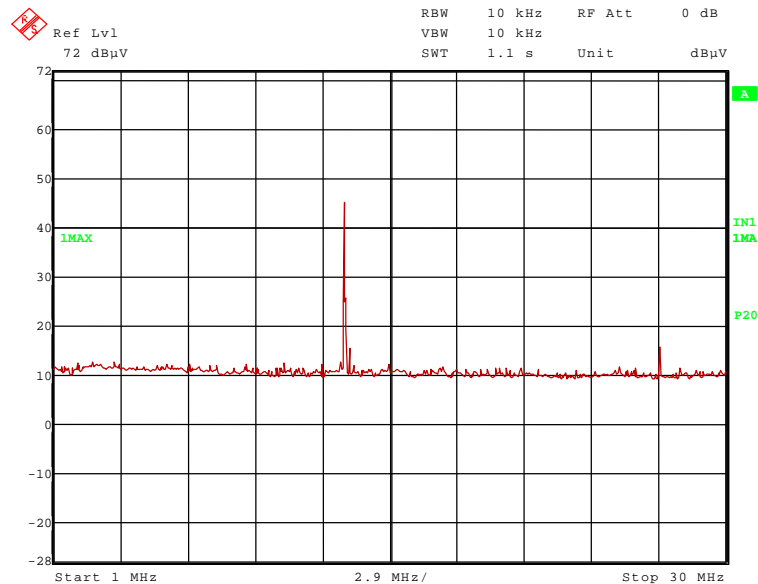

The following emission was found according to FCC 47 CFR Part 15 section 15.209 (a).

125.060 kHz, 27.122 MHz

The following frequency was found inside the 13.533 to 13.567 MHz band according to FCC 47 CFR Part 15 section 15.225 [2]:

13.561 MHz.

This frequency has to be measured on the outdoor test site. The result of this final measurement is shown in subclause 6.4 of this test report.



TEST REPORT REFERENCE: R51291A Edition 1

### 6.3 PRELIMINARY RADIATED EMISSION TEST (30 MHz to 1 GHz)

Ambient temperature:	21 °C	Relative humidity:	56 %
----------------------	-------	--------------------	------

Position of EUT: The EUT was set-up on a non-conducting table of a height of 0.8 m. The distance between EUT and antenna was 3 m.

Cable guide: The cable of the EUT was fixed on the non-conducting table. For further information of the cable guide refer to the pictures in annex A of this test report.

Test record: The test was carried out in normal operation mode of the EUT (reading 13.56 MHz TAG). All results are shown in the following.

#### 51291\_1.wmf: Spurious emissions from 30 MHz to 230 MHz:

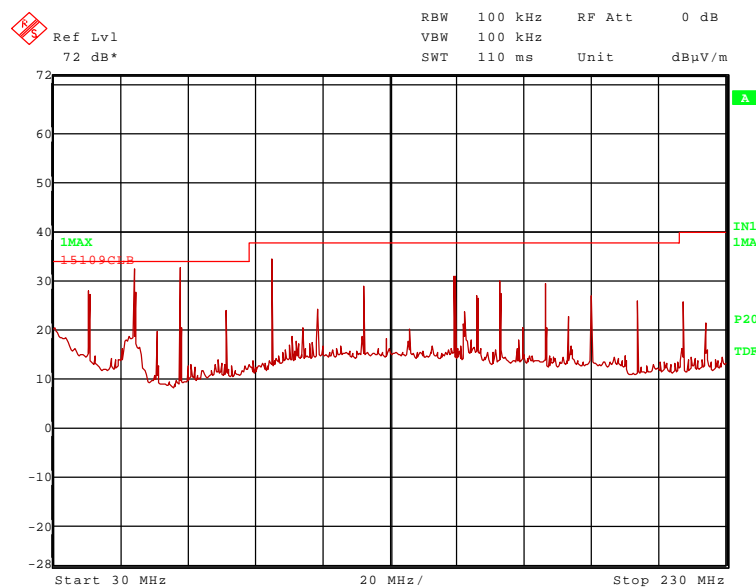

TEST REPORT REFERENCE: R51291A Edition 1

51291\_2.wmf: Spurious emissions from 230 MHz to 1 GHz:

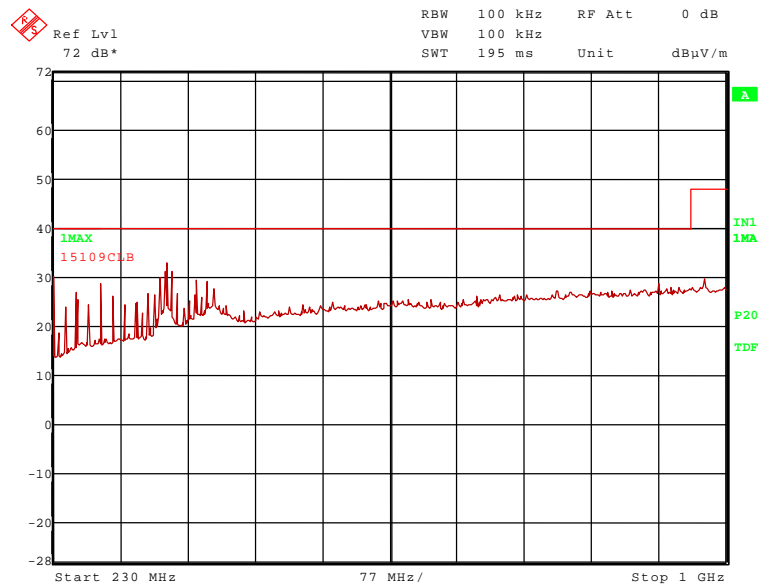

The following frequencies were found during the preliminary radiated emission test:

- 40.683 MHz,
- 54.244 MHz,
- 67.804 MHz,
- 94.926 MHz,
- 122.048 MHz,
- 149.169 MHz,
- 176.292 MHz,
- 230.534 MHz,
- 352.582 MHz,
- 359.360 MHz,
- 366.142 MHz,
- and 393.265 MHz.

The following frequency was found inside the restricted bands according to FCC 47 CFR Part 15 section 15.205 [2].

- 162.731MHz,
- and 406.825 MHz.

These frequencies have to be measured on the open area test site. The results of this final measurement are shown in subclause 6.5 of this test report.

TEST EQUIPMENT USED FOR THE TEST:

29, 31 - 35, 43, 54

TEST REPORT REFERENCE: R51291A Edition 1

## 6.4 FINAL RADIATED EMISSION TEST (9 kHz to 30 MHz)

Ambient temperature:	14 °C	Relative humidity:	60 %
----------------------	-------	--------------------	------

- Position of EUT:** The EUT was set-up on a non-conducting table of a height of 0.8 m. The distance between EUT and antenna was 30 m.
- Cable guide:** The cable of the EUT was fixed on the non-conducting table. For further information of the cable guide refer to the pictures in annex A of this test report.
- Test record:** The test was carried out in normal operation mode of the EUT (reading 125 kHz or 13.56 MHz TAG). All results are shown in the following.
- Supply voltage:** The EUT was supplied with 12 V DC via suitable AC/DC adaptors, and no difference was noticeable with supply voltages from 8 V DC to 16 V DC.
- Test results:** The test results were calculated with the following formula:  

$$\text{Result [dB}\mu\text{V/m]} = \text{reading [dB}\mu\text{V]} + \text{antenna factor [dB/m]}$$

Results with measuring distance of 3 m						
Frequency MHz	Result dB $\mu$ V/m	Limit dB $\mu$ V/m	Margin dB	Detector	Readings dB $\mu$ V	Antenna factor * dB/m
0.125	77.0	105.7	28.7	QP	57.0	20.0
13.561	39.9	124.0	84.1	QP	19.6	20.0
27.122 MHz	Signal was below the noise floor of the system (4 dB $\mu$ V/m)					
Results with measuring distance of 10 m						
Frequency MHz	Result dB $\mu$ V/m	Limit dB $\mu$ V/m	Margin dB	Detector	Readings dB $\mu$ V	Antenna factor * dB/m
0.125	56.0	85.7	29.7	QP	36.0	20.0
13.561	32.9	104.0	71.1	QP	12.9	20.0
27.122 MHz	Signal was below the noise floor of the system (4 dB $\mu$ V/m)					

\*: Cable loss included

Test: Passed

TEST EQUIPMENT USED FOR THE TEST:

54 – 57
---------

TEST REPORT REFERENCE: R51291A Edition 1

### 6.5 FINAL RADIATED EMISSION TEST (30 MHz to 1 GHz)

Ambient temperature:	20 °C	Relative humidity:	47 %
----------------------	-------	--------------------	------

- Position of EUT:** The EUT was set-up on a non-conducting table of a height of 0.8 m. The distance between EUT and antenna was 3 m.
- Cable guide:** The cable of the EUT was fixed on the non-conducting table. For further information of the cable guide refer to the pictures in annex A of this test report.
- Test record:** The test was carried out in normal operation mode of the EUT (reading a 13.56 kHz TAG). All results are shown in the following.
- Supply voltage:** The EUT was supplied with 12 V DC via suitable AC/DC adaptors, and no difference was noticeable with supply voltages from 8 V DC to 16 V DC.
- Test results:** The test results were calculated with the following formula:
- $$\text{Result [dB}\mu\text{V/m]} = \text{reading [dB}\mu\text{V]} + \text{cable loss [dB]} + \text{antenna factor [dB/m]}$$

The measured points and the limit line in the following diagram refer to the standard measurement of the emitted interference in compliance with the above-mentioned standard. The measured points marked with x are the measured results of the standard final measurement on the open area test site.

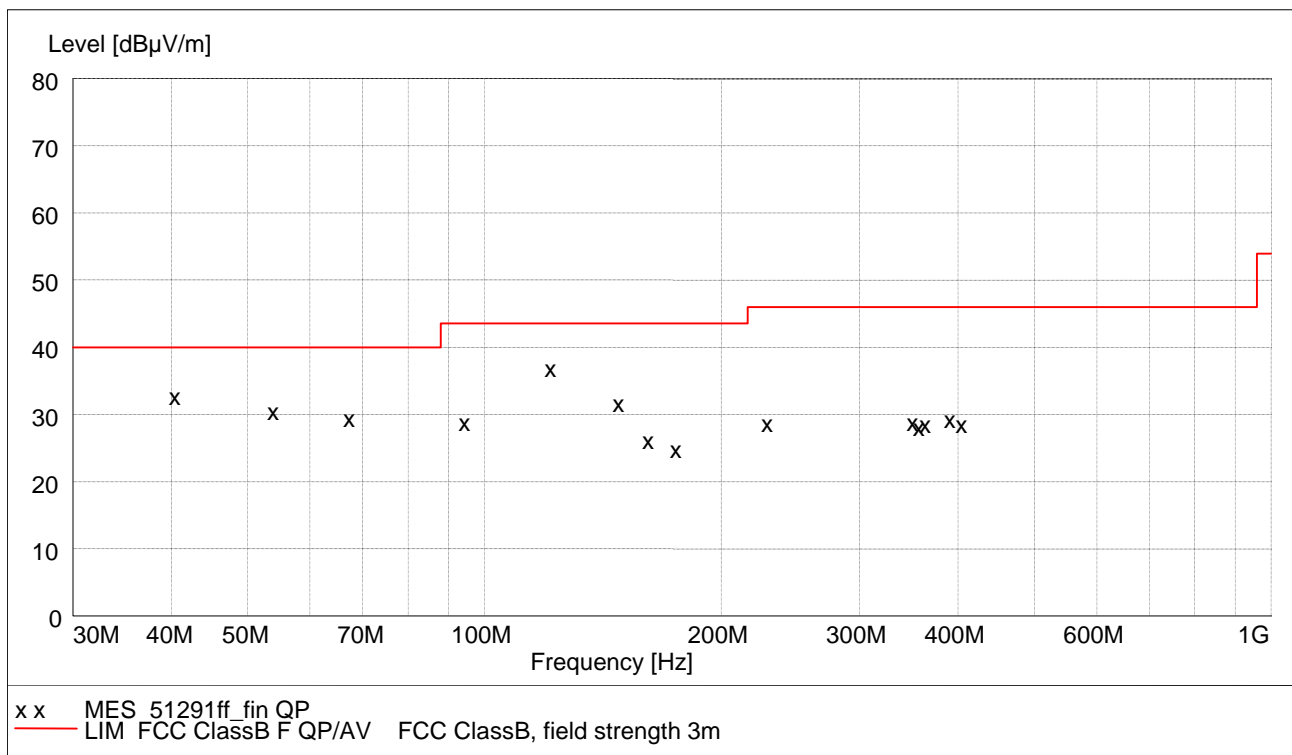

Data record name: 51291ff

TEST REPORT REFERENCE: R51291A Edition 1

The results of the standard final measurement on the open area test site are indicated in the table below. The limits as well as the measured results (levels) refer to the above-mentioned standard while taking account of the specified requirements for a 3 m measuring distance.

The measurement time with the quasi-peak measuring detector is 1 second.

Spurious emissions outside restricted bands									
Frequency MHz	Result dB $\mu$ V/m	Limit dB $\mu$ V/m	Margin dB	Readings dB $\mu$ V	Antenna factor dB/m	Cable loss dB	Height cm	Azimuth deg	Pol.
40.683	33.0	40.0	7.0	18.0	14.6	0.4	278.0	293.0	Vert.
54.244	30.8	40.0	9.2	23.1	7.3	0.4	227.0	202.0	Vert.
67.804	29.7	40.0	10.3	23.0	6.2	0.5	350.0	232.0	Vert.
94.926	29.1	43.5	14.4	18.0	10.5	0.6	204.0	293.0	Hor.
122.048	37.2	43.5	6.3	24.1	12.4	0.7	272.0	295.0	Hor.
149.169	32.0	43.5	11.5	19.6	11.7	0.7	127.0	114.0	Vert.
176.292	25.2	43.5	18.3	14.5	9.9	0.8	125.0	359.0	Vert.
230.534	29.0	46.0	17.0	17.8	10.3	0.9	175.0	293.0	Hor.
352.582	29.1	46.0	16.9	13.7	14.3	1.1	100.0	341.0	Vert.
359.360	28.4	46.0	17.6	12.9	14.3	1.2	190.0	202.0	Vert.
366.142	28.9	46.0	17.1	13.4	14.3	1.2	213.0	305.0	Hor.
393.265	29.6	46.0	16.4	13.0	15.4	1.2	224.0	316.00	Hor.
Spurious emissions in restricted bands									
Frequency MHz	Result dB $\mu$ V/m	Limit dB $\mu$ V/m	Margin dB	Readings dB $\mu$ V	Antenna factor dB/m	Cable loss dB	Height cm	Azimuth deg	Pol.
162.731	26.5	43.5	17.0	14.6	11.1	0.8	225.0	293.00	Hor.
406.825	28.9	46.0	17.1	11.9	15.8	1.2	225.0	316.00	Hor.

The test results were calculated with the following formula:

$$\text{Result [dB}\mu\text{V/m]} = \text{reading [dB}\mu\text{V]} + \text{cable loss [dB]} + \text{antenna factor [dB/m]}$$

Test: Passed

TEST EQUIPMENT USED FOR THE TEST:

14 - 20

TEST REPORT REFERENCE: R51291A Edition 1

## 6.6 OCCUPIED BANDWIDTH

Ambient temperature:	21 °C	Relative humidity:	56 %
----------------------	-------	--------------------	------

Test set-up: For this test the test set-up from the preliminary emission measurement test set-up was used.

Cable guide: The cable of the EUT was fixed on the non-conducting table. For further information of the cable guide refer to the pictures in annex A of this test report, because the same test set-up as for the frequency error was used.

Supply voltage: The EUT was supplied with 12 V DC by an external power supply.

Test record: The test was carried out in normal operation mode of the EUT (transmit mode with reading a TAG). All results are shown in the following.

51291\_1.hgl: Occupied bandwidth at 125 kHz:

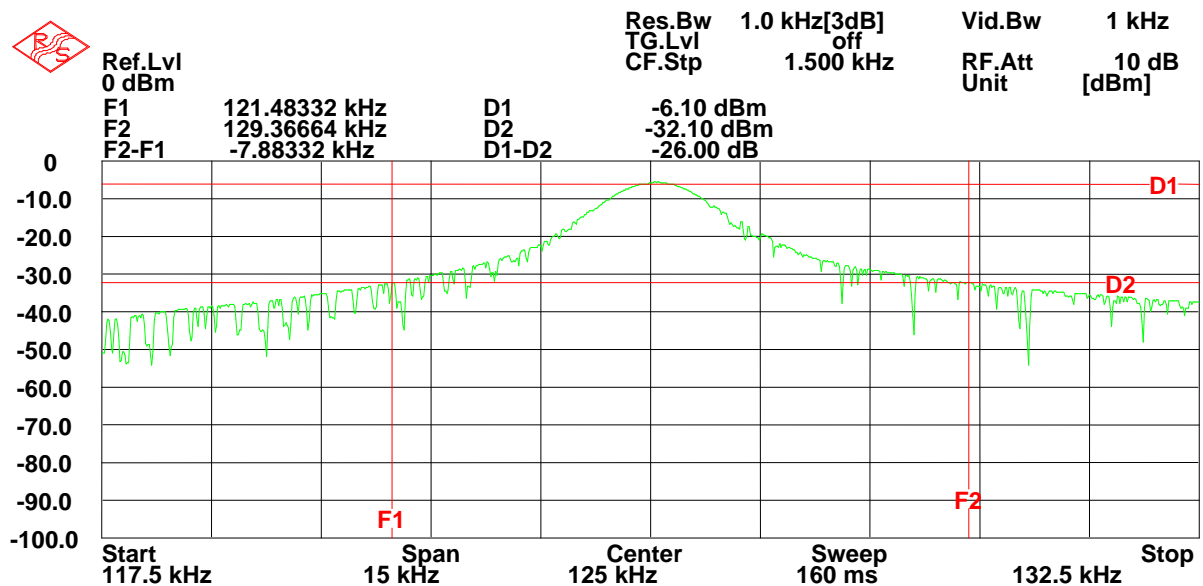

$F_L$	$F_U$	BW ( $F_U - F_L$ )
121.48332 kHz	129.36664 kHz	7.833 kHz

TEST REPORT REFERENCE: R51291A Edition 1

51291\_6.wmf: Occupied bandwidth at 13.56 MHz:

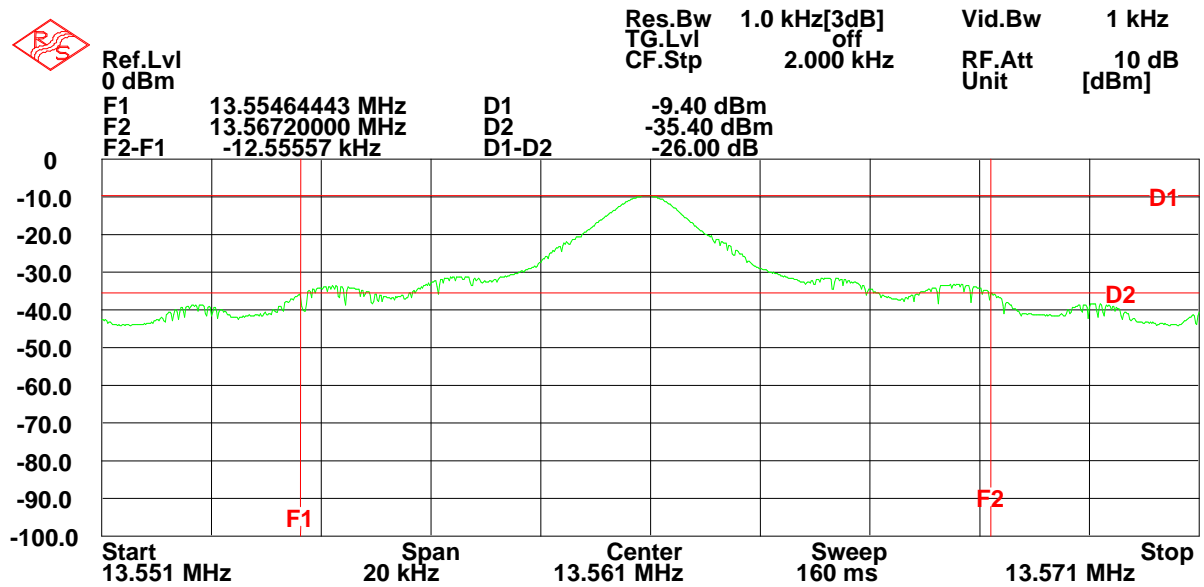

$F_L$	$F_U$	BW ( $F_U - F_L$ )
13.554644 MHz	13.567200 MHz	12.556 kHz

TEST EQUIPMENT USED THE TEST:

22, 54, 58, 59

TEST REPORT REFERENCE: R51291A Edition 1

## 6.7 FREQUENCY TOLLERANCE

Ambient temperature	21 °C	Relative humidity	56 %
---------------------	-------	-------------------	------

Test set-up: For this test the test set-up from the preliminary emission measurement test set-up was used.

Cable guide: The cable of the EUT was fixed on the non-conducting table. For further information of the cable guide refer to the pictures in annex A of this test report.

Supply voltage: 8.0 V DC

Temperature:	Minutes after switch on	Frequency:	Allowed tolerance:	Measured tolerance:	Result:
50 °C	0	13.560866 MHz	±1.356 kHz	-14 Hz	Passed
	2	13.560866 MHz	±1.356 kHz	-14 Hz	Passed
	5	13.560875 MHz	±1.356 kHz	-5 Hz	Passed
	10	13.560871 MHz	±1.356 kHz	-9 Hz	Passed
40 °C	0	13.560871 MHz	±1.356 kHz	-9 Hz	Passed
	2	13.560871 MHz	±1.356 kHz	-9 Hz	Passed
	5	13.560871 MHz	±1.356 kHz	-9 Hz	Passed
	10	13.560875 MHz	±1.356 kHz	-5 Hz	Passed
30 °C	0	13.560890 MHz	±1.356 kHz	+10 Hz	Passed
	2	13.560888 MHz	±1.356 kHz	+8 Hz	Passed
	5	13.560884 MHz	±1.356 kHz	+4 Hz	Passed
	10	13.560880 MHz	±1.356 kHz	0 Hz	Passed
20 °C	0	13.560893 MHz	-	+13 Hz	For information
	2	13.560809 MHz	-	+9 Hz	For information
	5	13.560804 MHz	-	+4 Hz	For information
	10	13.560880 MHz	-	-	Reference
10 °C	0	13.560915 MHz	±1.356 kHz	+35 Hz	Passed
	2	13.560906 MHz	±1.356 kHz	+26 Hz	Passed
	5	13.560911 MHz	±1.356 kHz	+31 Hz	Passed
	10	13.560902 MHz	±1.356 kHz	+22 Hz	Passed
0 °C	0	13.560920 MHz	±1.356 kHz	+40 Hz	Passed
	2	13.560924 MHz	±1.356 kHz	+44 Hz	Passed
	5	13.560920 MHz	±1.356 kHz	+40 Hz	Passed
	10	13.560920 MHz	±1.356 kHz	+40 Hz	Passed
-10 °C	0	13.560902 MHz	±1.356 kHz	+22 Hz	Passed
	2	13.560920 MHz	±1.356 kHz	+40 Hz	Passed
	5	13.560906 MHz	±1.356 kHz	+26 Hz	Passed
	10	13.560920 MHz	±1.356 kHz	+40 Hz	Passed
-20 °C	0	13.560853 MHz	±1.356 kHz	-27 Hz	Passed
	2	13.560888 MHz	±1.356 kHz	+8 Hz	Passed
	5	13.560888 MHz	±1.356 kHz	+8 Hz	Passed
	10	13.560902 MHz	±1.356 kHz	+22 Hz	Passed

Continued next page



TEST REPORT REFERENCE: R51291A Edition 1

Supply voltage: 16.0 V DC

Temperature:	Minutes after switch on	Frequency:	Allowed tolerance:	Measured tolerance:	Result:
50 °C	0	13.560866 MHz	±1.356 kHz	-14 Hz	Passed
	2	13.560871 MHz	±1.356 kHz	-9 Hz	Passed
	5	13.560871 MHz	±1.356 kHz	-9 Hz	Passed
	10	13.560875 MHz	±1.356 kHz	-5 Hz	Passed
40 °C	0	13.560875 MHz	±1.356 kHz	-5 Hz	Passed
	2	13.560866 MHz	±1.356 kHz	-14 Hz	Passed
	5	13.560875 MHz	±1.356 kHz	-5 Hz	Passed
	10	13.560871 MHz	±1.356 kHz	-9 Hz	Passed
30 °C	0	13.560890 MHz	±1.356 kHz	+10 Hz	Passed
	2	13.560884 MHz	±1.356 kHz	+4 Hz	Passed
	5	13.560884 MHz	±1.356 kHz	+4 Hz	Passed
	10	13.560880 MHz	±1.356 kHz	0 Hz	Passed
20 °C	0	13.560893 MHz	-	+13 Hz	For information
	2	13.560809 MHz	-	+9 Hz	For information
	5	13.560804 MHz	-	+4 Hz	For information
	10	13.560880 MHz	-	-	Reference
10 °C	0	13.560911 MHz	±1.356 kHz	+31 Hz	Passed
	2	13.560906 MHz	±1.356 kHz	+26 Hz	Passed
	5	13.560906 MHz	±1.356 kHz	+26 Hz	Passed
	10	13.560902 MHz	±1.356 kHz	+22 Hz	Passed
0 °C	0	13.560915 MHz	±1.356 kHz	+35 Hz	Passed
	2	13.560920 MHz	±1.356 kHz	+40 Hz	Passed
	5	13.560920 MHz	±1.356 kHz	+40 Hz	Passed
	10	13.560924 MHz	±1.356 kHz	+44 Hz	Passed
-10 °C	0	13.560902 MHz	±1.356 kHz	+22 Hz	Passed
	2	13.560920 MHz	±1.356 kHz	+40 Hz	Passed
	5	13.560915 MHz	±1.356 kHz	+35 Hz	Passed
	10	13.560924 MHz	±1.356 kHz	+44 Hz	Passed
-20 °C	0	13.560862 MHz	±1.356 kHz	-18 Hz	Passed
	2	13.560880 MHz	±1.356 kHz	0 Hz	Passed
	5	13.560884 MHz	±1.356 kHz	+4 Hz	Passed
	10	13.560902 MHz	±1.356 kHz	+22 Hz	Passed

Test result: Passed

TEST EQUIPMENT USED FOR THE TEST:

22, 54, 58, 59, 61
--------------------

TEST REPORT REFERENCE: R51291A Edition 1

---

## **7 TEST EQUIPMENT AND ANCILLARIES USED FOR TESTS**

TEST REPORT REFERENCE: R51291A Edition 1

Emission measurement at AC mains and DC in / out ports at M4					
No.	Test equipment	Type	Manufacturer	Serial No.	PM-No
1	Shielded chamber M4	-	Siemens	B83117S1-X158	480088
2	Measuring receiver	ESAI	Rohde & Schwarz	831953/001 833181/018	480025 480026
3	LISN	NSLK8128	Schwarzbeck	8128155	480058
4	LISN	NSLK 8128-	Schwarzbeck	8128161	480138
5	AC-filter	B84299-D87- E3	Siemens	930262292	480097
6	EMI-Software	ES-K1	Rohde & Schwarz	-	480111

Radiated emission measurement at M5					
No.	Test equipment	Type	Manufacturer	Serial No.	PM-No
7	Fully anechoic chamber M5	-	Siemens	B83177-S1-X156	480073
8	Measuring receiver	ESVS30	Rohde & Schwarz	829673/012	480024
9	Controller	HD100	Deisel	100/324	480067
10	Antenna support	MA240	Deisel	228/314	480069
11	Turntable	DS412	Deisel	412/317	480070
12	Antenna	CBL6112C	Chase	2689	480327
13	EMI Software	ES-K1	Rohde & Schwarz	-	480111

Radiated emission measurement at M6					
No.	Test equipment	Type	Manufacturer	Serial No.	PM-No
14	Open area test site	-	Phoenix Test-Lab	-	480085
15	Measuring receiver	ESVS30	Rohde & Schwarz	829673/012	480024
16	Controller	HD100	Deisel	100/670	480139
17	Turntable	DS420HE	Deisel	420/620/80	480087
18	Antenna support	AS615P	Deisel	615/310	480086
19	Antenna	CBL6111 A	Chase	1643	480147
20	EMI Software	ES-K1	Rohde & Schwarz	-	480111

TEST REPORT REFERENCE: R51291A Edition 1

Radiated emission measurement at M8					
No.	Test equipment	Type	Manufacturer	Serial No.	PM-No
21	Fully anechoic chamber M8	-	Siemens	B83117-E7019-T231	480190
22	Measuring receiver	ESMI	Rohde & Schwarz	843977/001 843530/018	480179 480180
23	Measuring receiver	ESCS 30	Rohde & Schwarz	828985/014	480270
24	Controller	HD100	Deisel	100/427	480181
25	Turntable	DS420	Deisel	420/435/97	480186
26	Antenna support	AS615P	Deisel	615/310	480187
27	Antenna	CBL6112 A	Chase	2034	480185
28	EMI Software	ES-K1	Rohde & Schwarz	-	480111

Radiated emission measurement at M20					
No.	Test equipment	Type	Manufacturer	Serial No.	PM-No
29	Fully anechoic chamber M20	-	Albatross Projects	B83107-E2439-T232	480303
30	Measuring receiver	ESMI	Rohde & Schwarz	843977/001 843530/018	480179 480180
31	Measuring receiver	ESI 40	Rohde & Schwarz	100064	480355
32	Controller	HD100	Deisel	100/670	480326
33	Turntable	DS420HE	Deisel	420/620/80	480315
34	Antenna support	AS615P	Deisel	615/310	480187
35	Antenna	CBL6112 B	Chase	2688	480328
36	Antenna	3115 A	EMCO	9609-4918	480183
37	Standard Gain Horn 11.9GHZ – 18GHZ	18240-20	Flann Microwave	483	480294
38	Standard Gain Horn 11.9GHZ – 18GHZ	18240-20	Flann Microwave	482	480295
39	Standard Gain Horn 17.9GHZ – 26.7GHZ	20240-20	Flann Microwave	411	480297
40	Standard Gain Horn 17.9GHZ – 26.7GHZ	20240-20	Flann Microwave	410	480296
41	Standard Gain Horn 26.4GHZ – 40.1GHZ	22240-20	Flann Microwave	469	480299

TEST REPORT REFERENCE: R51291A Edition 1

No.	Test equipment	Type	Manufacturer	Serial No.	PM-No
42	Standard Gain Horn 26.4GHz – 40.1GHZ	22240-20	Flann Microwave	468	480298
43	RF-cable No. 30	RTK 081	Rosenberger	-	410141
44	RF-cable No. 31	RTK 081	Rosenberger	-	410142
45	RF-cable 1m	KPS-1533- 400-KPS	Insulated Wire	-	480300
46	RF-cable 1m	KPS-1533- 400-KPS	Insulated Wire	-	480301
47	RF-cable 2m	KPS-1533- 400-KPS	Insulated Wire	-	480302
48	RF-cable No. 5	RTK 081	Rosenberger		410097
49	Preamplifier	JS3- 00101200- 23-5A	Miteq	681851	480337
50	Preamplifier	JS3- 12001800- 16-5A	Miteq	571667	480343
51	Preamplifier	JS3- 18002600- 20-5A	Miteq	658697	480342
52	Preamplifier	JS3- 26004000- 25-5A	Miteq	563593	480344
53	EMI Software	ES-K1	Rohde & Schwarz	-	480111

Ancillary equipment used for testing					
No.	Test equipment	Type	Manufacturer	Serial No.	PM-No
54	Power supply	TOE 8852	Toellner	51712	480233
55	Outdoor test site	-	Phoenix Test-Lab	-	480293
56	Loop antenna	HFH2-Z2	Rohde & Schwarz	832609/014	480059
57	EMI test receiver	ESPC	Rohde & Schwarz	843756/006	480150
58	Loop Antenna Ø = 225 mm	-	Phoenix Test-Lab	-	410085
59	RF-cable No. 10	RG223	Phoenix-Test-Lab	-	410102
60	AC power source / analyser	6813A	Hewlett Packard	3524A-00484	480155
61	Climatic chamber	MK 240	BINDER	05-79022	480462

All used measurement equipment was calibrated (if necessary). The calibration intervals and the calibration history will be given out on request.

TEST REPORT REFERENCE: R51291A Edition 1

---

## 8 LIST OF ANNEXES

<b>ANNEX A</b>	<b>PHOTOGRAPHS OF THE TEST SET-UPS:</b>	<b>6 pages</b>
	PRD5 / SWH-3100, test set-up shielded chamber	51291_h.jpg
	PRD5 / SWH-3100, test set-up fully anechoic chamber	51291_k.jpg
	PRD5 / SWH-3100, test set-up fully anechoic chamber	51291_l.jpg
	PRD5 / SWH-3100, test set-up outdoor test site	51291_f.jpg
	PRD5 / SWH-3100, test set-up open area test site	51291_g.jpg
	PRD5 / SWH-3100, test set-up climatic chamber	51291_b.jpg
<b>ANNEX B</b>	<b>INTERNAL PHOTOGRAPHS OF THE TEST SAMPLE:</b>	<b>5 pages</b>
	PRD5 / SWH-3100, rear view	51291_5.jpg
	PRD5 / SWH-3100, main PCB, top view	51291_4.jpg
	PRD5 / SWH-3100, main PCB, bottom view	51291_1.jpg
	PRD5 / SWH-3100, antenna PCB, top view	51291_7.jpg
	PRD5 / SWH-3100, antenna PCB, bottom view	51291_3.jpg
<b>ANNEX C</b>	<b>EXTERNAL PHOTOGRAPHS OF THE TEST SAMPLE:</b>	<b>1 page</b>
	PRD5 / SWH-3100, front view	51291_2.jpg