

TIMCO ENGINEERING INC.

849 NW State Road 45

Newberry, Florida 32669

<http://www.timcoengr.com>

888.472.2424 F 352.472.2030 email: sid@timcoengr.com



Test Report

Product Name: UHF TRANSCEIVER

FREQUENCY RANGE: 430 - 470 MHz

FCC ID: IV9FNCU-M45

Applicant:

**KANEMATSU USA INC.
543 WEST ALGONQUIN ROAD
ARLINGTON HEIGHTS ILLINOIS 60005**

Date Receipt: JANUARY 17, 2005

Date Tested: JANUARY 25, 2005

APPLICANT: KANEMATSU USA INC.

FCC ID: IV9FNCU-M45

REPORT #: K\KANEMATSU USA_\104AUT4\104AUT4TestReport.doc

COVER SHEET

TIMCO ENGINEERING INC.

849 NW State Road 45
Newberry, Florida 32669
<http://www.timcoengr.com>
888.472.2424 F 352.472.2030 email: sid@timcoengr.com

APPLICANT: KANEMATSU USA INC.

FCC ID: IV9FNCU-M45

TABLE OF CONTENTS LIST

TEST REPORT:

PAGE 1.....GENERAL INFORMATION
PAGE 2.....MODULATION LIMITING
PAGE 3-4.....OCCUPIED BANDWIDTH
PAGE 5-6.....TRANSIENT FREQUENCY STABILITY
PAGE 7-8.....TRANSIENT FREQUENCY RESPONSE PLOTS
PAGE 9-14.....EQUIPMENT LIST

EXHIBITS CONTAINING:

CLASS II PERMISSIVE CHANGE REQUEST LETTER

APPLICANT: KANEMATSU USA INC.

FCC ID: IV9FNCU-M45

REPORT #: K\KANEMATSU USA_\104AUT4\104AUT4TestReport.doc

TABLE OF CONTENTS

TIMCO ENGINEERING INC.

849 NW State Road 45

Newberry, Florida 32669

<http://www.timcoengr.com>

888.472.2424 F 352.472.2030 email: sid@timcoengr.com

GENERAL INFORMATION REQUIRED FOR TYPE ACCEPTANCE

2.1033(c)(1)(2) KANEMATSU USA INC. will manufacture the
FCCID: IV9FNCU-M45 VHF TRANSCEIVER in
quantity, for use under FCC RULES PART 90.

KANEMATSU USA INC.
543 WEST ALGONQUIN ROAD
ARLINGTON HEIGHTS, ILLINOIS 60005

2.1033(c) TECHNICAL DESCRIPTION

2.1033(c) (4) Type of Emission: 15K7F3E
90.209

Bn = 2M + 2DK

M = 3000

D = 4880

Bn = 2(3000) + 2(4880) = 15.76k

90.217 (b) Authorized Bandwidth 25 kHz

2.1033(c)(5) Frequency Range: 430 - 470 MHz

APPLICANT: KANEMATSU USA INC.

FCC ID: IV9FNCU-M45

REPORT #: K\KANEMATSU USA_\104AUT4\104AUT4TestReport.doc

TIMCO ENGINEERING INC.

849 NW State Road 45
Newberry, Florida 32669
<http://www.timcoengr.com>
888.472.2424 F 352.472.2030 email: sid@timcoengr.com

2.1047(b)

Audio input versus modulation

The audio input level needed for a particular percentage of modulation was measured in accordance with TIA/EIA Specification 603. The audio input curves versus modulation are shown below. Curves are provided for audio input frequencies of 300, 1000, and 2500 Hz.

2.5k blue, 1k green, 300hz yellow

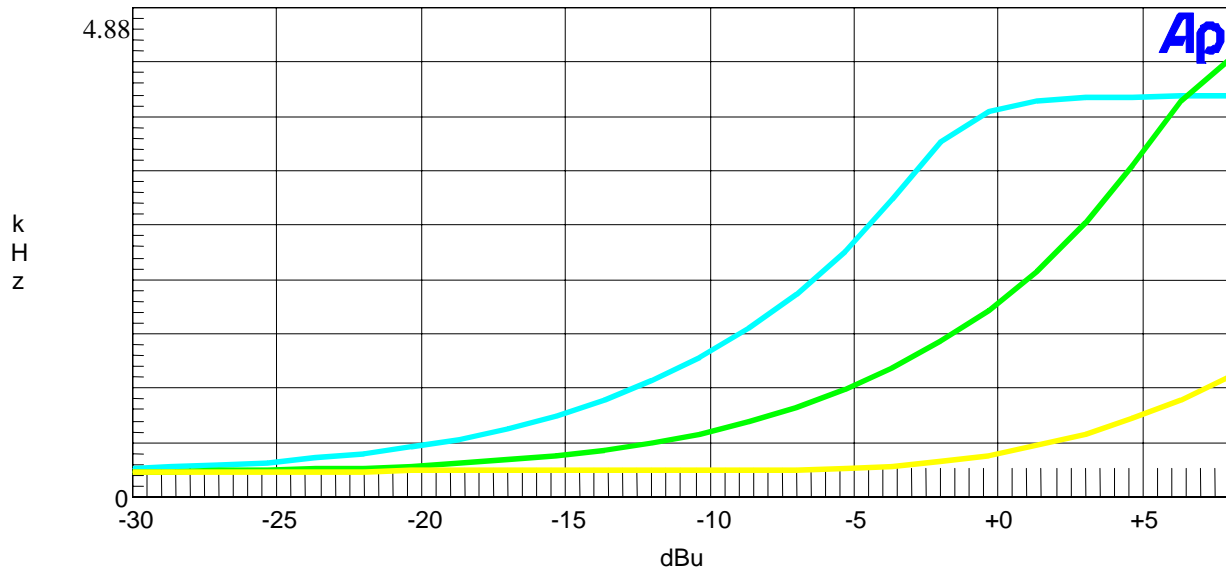

APPLICANT: KANEMATSU USA INC.

FCC ID: IV9FNCU-M45

REPORT #: K\KANEMATSU USA_\104AUT4\104AUT4TestReport.doc

TIMCO ENGINEERING INC.

849 NW State Road 45
Newberry, Florida 32669
<http://www.timcoengr.com>
888.472.2424 F 352.472.2030 email: sid@timcoengr.com

2.1049 **Occupied bandwidth:**
90.210(b)

Data in the plots show that on any frequency removed from the assigned frequency by more than 50%, but not more than 100%: At least 25dB. On any frequency removed from the assigned frequency by more than 100%, but not more than 250%: At least 35 dB. On any frequency removed from the assigned frequency by more than 250%, of the authorized bandwidth: At least $43 + 10\log(P)$ dB.

Radiotelephone Transmitter with Modulation Limiter

Test procedure: TIA/EIA-603 para 2.2.11, with the exception that various tones were used.

Test procedure diagram

OCCUPIED BANDWIDTH MEASUREMENT

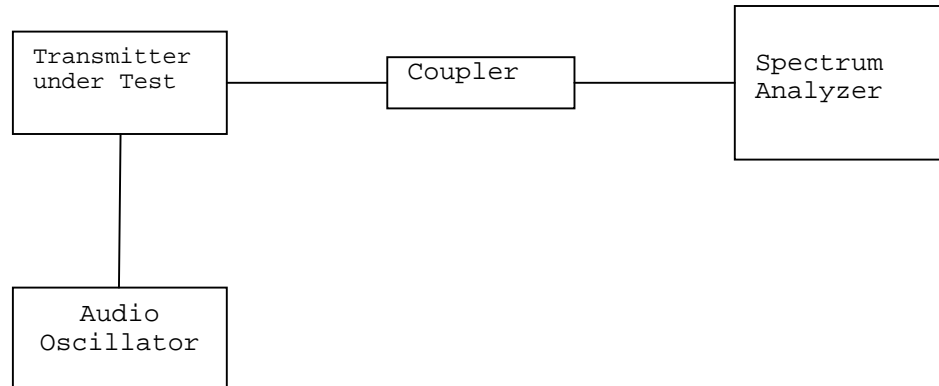

APPLICANT: KANEMATSU USA INC.

FCC ID: IV9FNCU-M45

REPORT #: K\KANEMATSU USA_\104AUT4\104AUT4TestReport.doc

TIMCO ENGINEERING INC.

849 NW State Road 45
Newberry, Florida 32669
<http://www.timcoengr.com>
888.472.2424 F 352.472.2030 email: sid@timcoengr.com

OCCUPIED BANDWIDTH PLOT

NOTES:

KANEMATSU USA INC. - FCC ID: IV9 FNCU-M25
OCCUPIED BANDWIDTH PLOT

FCC 90.210 Mask B

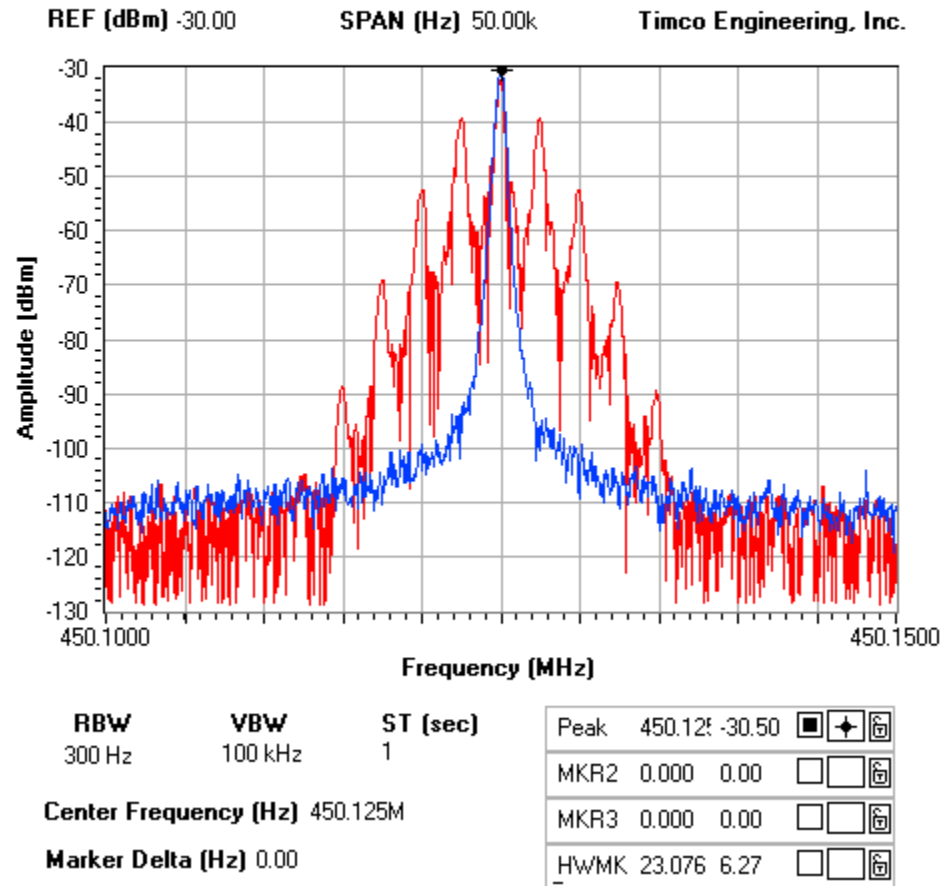

APPLICANT: KANEMATSU USA INC.

FCC ID: IV9FNCU-M45

REPORT #: K\KANEMATSU USA_\104AUT4\104AUT4TestReport.doc

TIMCO ENGINEERING INC.

849 NW State Road 45
 Newberry, Florida 32669
<http://www.timcoengr.com>
 888.472.2424 F 352.472.2030 email: sid@timcoengr.com

2.1055(a)(1) Frequency stability:
 90.214 Transient Frequency Behavior

REQUIREMENTS: Transmitters designed to operate in the 150-174 MHz and 421-512 MHz frequency bands must maintain transient frequencies within the maximum transient frequencies within the maximum frequency difference limits during the time intervals indicated:

Time Intervals	Maximum frequency difference	All Equipment	
		150-174 MHz	421-512 MHz

Transient Frequency Behavior for Equipment Designed to Operate on 25 kHz Channels

t_1^4	±25.0 kHz	5.0 mS	10.0 mS
t_2	±12.5 kHz	20.0 mS	25.0 mS
t_3^4	±25.0 kHz	5.0 mS	10.0 mS

Transient Frequency Behavior for Equipment Designed to Operate on 12.5 kHz Channels

t_1^4	±12.5 kHz	5.0 mS	10.0 mS
t_2	±6.25 kHz	20.0 mS	25.0 mS
t_3^4	±12.5 kHz	5.0 mS	10.0 mS

Transient Frequency Behavior for Equipment Designed to Operate on 6.25 kHz Channels

t_1^4	±6.25 kHz	5.0 mS	10.0 mS
t_2	±3.125 kHz	20.0 mS	25.0 mS
t_3^4	±6.25 kHz	5.0 mS	10.0 mS

APPLICANT: KANEMATSU USA INC.

FCC ID: IV9FNCU-M45

REPORT #: K\KANEMATSU USA_\104AUT4\104AUT4TestReport.doc

TIMCO ENGINEERING INC.

849 NW State Road 45

Newberry, Florida 32669

<http://www.timcoengr.com>

888.472.2424 F 352.472.2030 email: sid@timcoengr.com

TEST PROCEEDURE: TIA/EIA TS603 PARA 2.2.19, the levels were set as follows;

1. Using the variable attenuator the transmitter level was set to 40 dB below the test receivers maximum input level, then the transmitter was turned off.
2. With the transmitter off the signal generator was set 20dB below the level of the transmitter in the above step, this level will be maintained with the signal generator through-out the test.
3. Reduce the attenuation between the transmitter and the RF detector by 30 dB.
4. With the levels set as above the transient frequency behavior was observed & recorded.

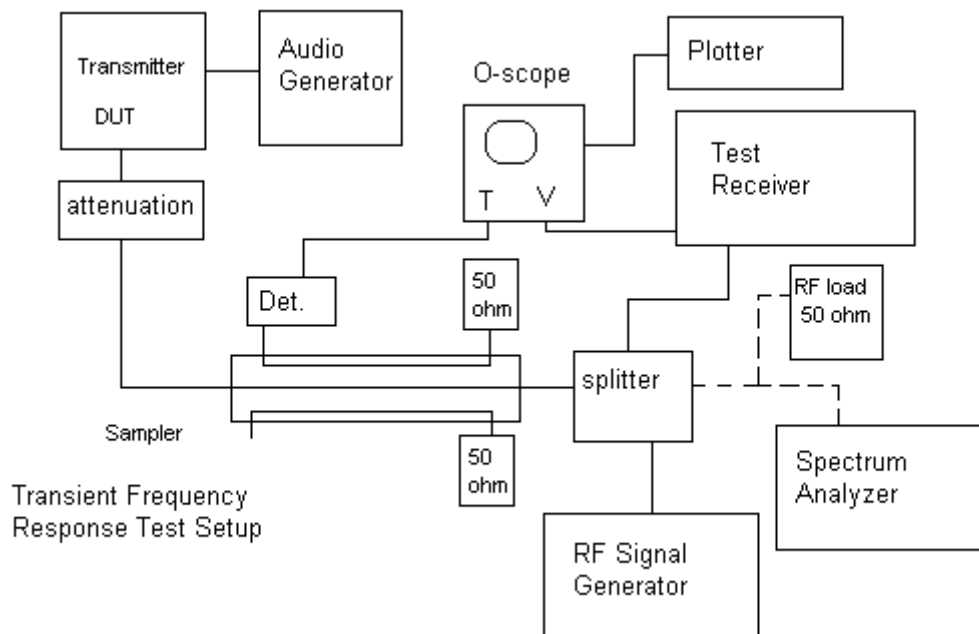

APPLICANT: KANEMATSU USA INC.

FCC ID: IV9FNCU-M45

REPORT #: K\KANEMATSU USA_\104AUT4\104AUT4TestReport.doc

TIMCO ENGINEERING INC.

849 NW State Road 45

Newberry, Florida 32669

<http://www.timcoengr.com>

888.472.2424 F 352.472.2030 email: sid@timcoengr.com

TRANSIENT FREQUENCY RESPONSE 25 kHz - LOW POWER

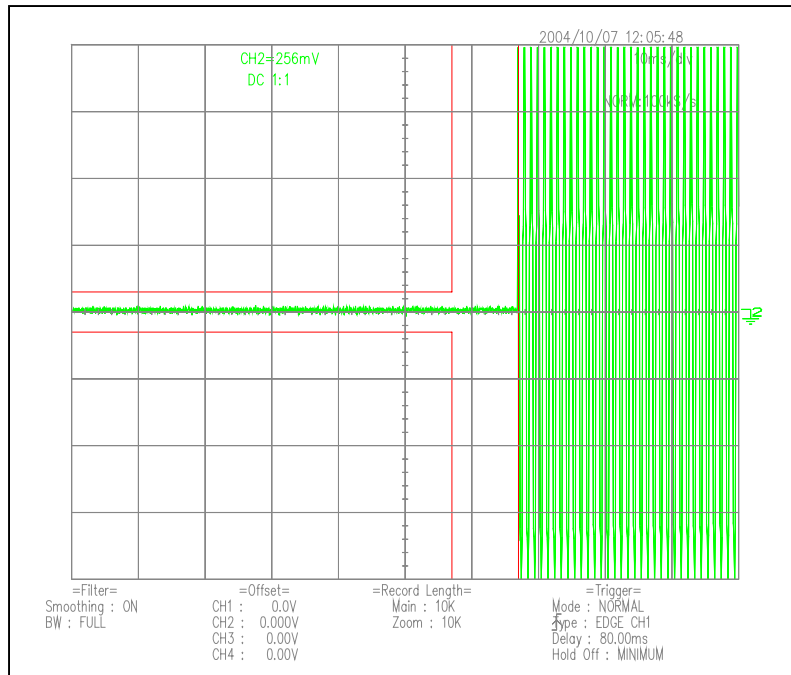
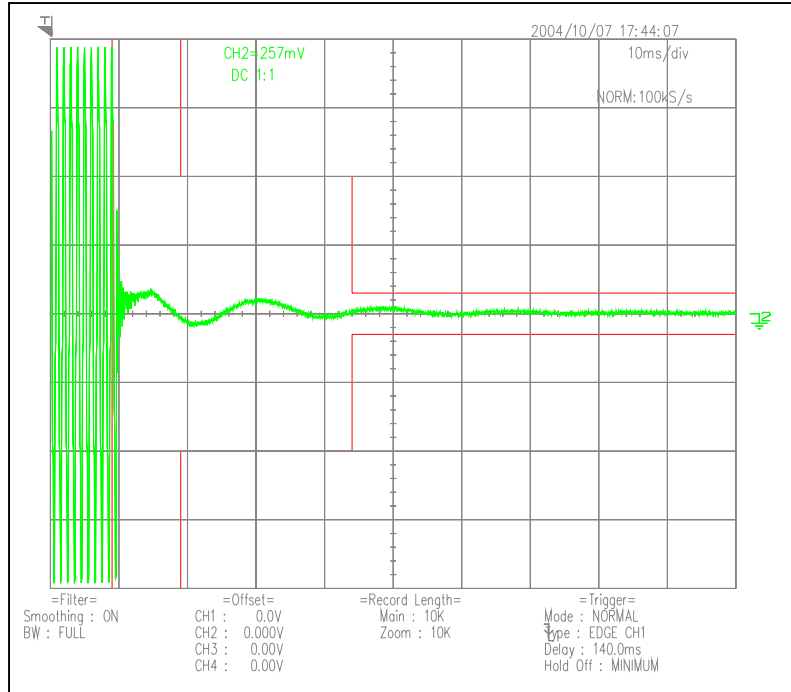

APPLICANT: KANEMATSU USA INC.

FCC ID: IV9FNCU-M45

REPORT #: K\KANEMATSU USA_\104AUT4\104AUT4TestReport.doc

TIMCO ENGINEERING INC.

849 NW State Road 45

Newberry, Florida 32669

<http://www.timcoengr.com>

888.472.2424 F 352.472.2030 email: sid@timcoengr.com

TRANSIENT FREQUENCY RESPONSE 25 kHz - HIGH POWER

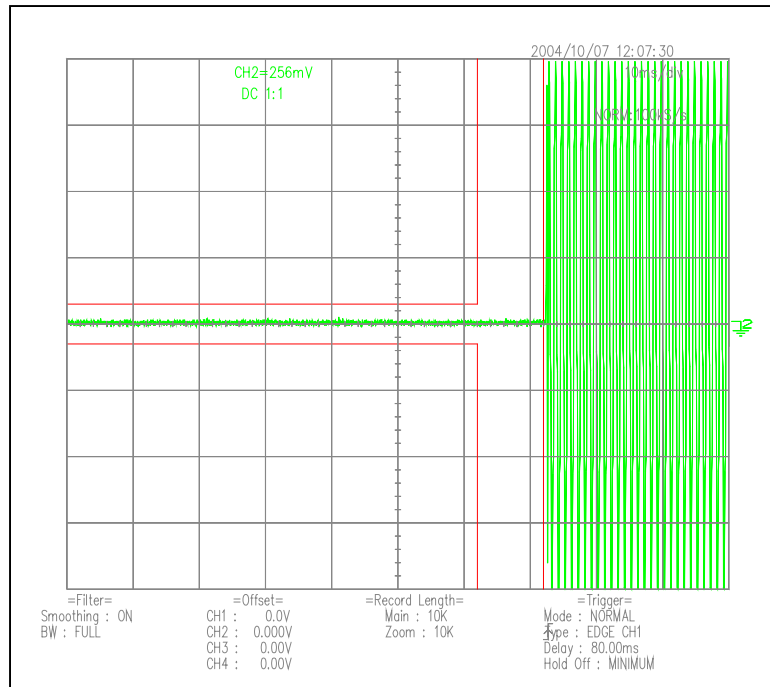
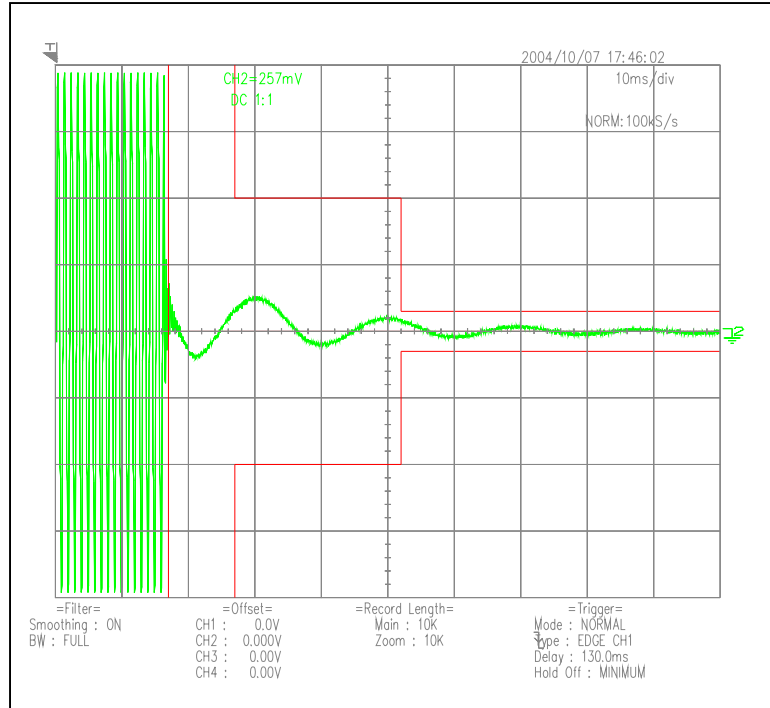

APPLICANT: KANEMATSU USA INC.

FCC ID: IV9FNCU-M45

REPORT #: K\KANEMATSU USA_\104AUT4\104AUT4TestReport.doc

TIMCO ENGINEERING INC.

849 NW State Road 45
 Newberry, Florida 32669
<http://www.timcoengr.com>
 888.472.2424 F 352.472.2030 email: sid@timcoengr.com

EMC Equipment List

Device	Manufacturer	Model	Serial Number	Cal/Char Date	Due Date or Status
3-Meter OATS	TEI	N/A	N/A	Listed 1/13/03	1/12/06
3/10-Meter OATS	TEI	N/A	N/A	Listed 3/27/04	3/26/07
Tan Tower Spectrum Analyzer	HP	8566B Opt 462	3138A07786 3144A20661	CAL 9/23/03	9/23/05
Tan Tower RF Preselector	HP	85685A	3221A01400	CAL 9/23/03	9/23/05
Tan Tower Quasi-Peak Adapter	HP	85650A	3303A01690	CAL 9/23/03	9/23/05
Tan Tower Preamplifier	HP	8449B-H02	3008A00372	CAL 9/23/03	9/23/05
Blue Tower Spectrum Analyzer	HP	8568B	2928A04729 2848A18049	CAL 4/15/03	4/15/05
Blue Tower RF Preselector	HP	85685A	2620A00294	CAL 4/27/04	4/27/06
Blue Tower Quasi-Peak Adapter	HP	85650A	2811A01279	CAL 4/15/03	4/15/05
Silver Tower Spectrum Analyzer	HP	8566B Opt 462	3552A22064 3638A08608	CAL 3/22/04	3/22/06
Silver Tower RF Preselector	HP	85685A	2926A00983	CAL 3/22/04	3/22/06
Silver Tower Quasi-Peak Adapter	HP	85650A	3303A01844	CAL 3/22/04	3/22/06
Silver Tower Preamplifier	HP	8449B	3008A01075	CAL 3/22/04	3/22/06
Biconnical Antenna	Electro-Metrics	BIA-25	1171	CAL 4/26/01	4/26/03
Biconnical Antenna	Eaton	94455-1	1096	CAL 8/17/04	8/17/06
Biconnical Antenna	Eaton	94455-1	1057	CAL 3/18/03	3/18/05
BiconiLog Antenna	EMCO	3143	9409-1043	No Cal Required	
Log-Periodic Antenna	Electro-Metrics	LPA-25	1122	CAL 8/26/04	8/26/06
Log-Periodic Antenna	Electro-Metrics	LPA-30	409	CAL 3/4/03	3/4/05
Log-Periodic	Eaton	96005	1243	CAL	5/8/05

APPLICANT: KANEMATSU USA INC.

FCC ID: IV9FNCU-M45

REPORT #: K\KANEMATSU USA_\104AUT4\104AUT4TestReport.doc

TIMCO ENGINEERING INC.

849 NW State Road 45

Newberry, Florida 32669

<http://www.timcoengr.com>

888.472.2424 F 352.472.2030 email: sid@timcoengr.com

Device	Manufacturer	Model	Serial Number	Cal/Char Date	Due Date or Status
Antenna				5/8/03	
Dipole Antenna Kit	Electro-Metrics	TDA-30/1-4	152	CAL 3/21/01	3/21/04
Dipole Antenna Kit	Electro-Metrics	TDA-30/1-4	153	CAL 9/26/02	9/26/05
Double-Ridged Horn Antenna	Electro-Metrics	RGA-180	2319	CAL 2/17/03	2/17/05
Horn Antenna *(at 3 meters)	Electro-Metrics	EM-6961	6246	CAL 3/31/03	3/31/05
Horn Antenna *(at 10 meters)	Electro-Metrics	EM-6961	6246	CAL 6/4/03	6/4/05
Passive Loop Antenna	EMC Test Systems	EMCO 6512	9706-1211	CHAR 7/10/01	7/10/03
Harmonic Mixer with Horn Antenna	Oleson Microwave Labs	M08HW/A	F30425-1	CHAR 4/25/03	4/25/05
Harmonic Mixer with Horn Antenna	Oleson Microwave Labs	M12HW/A	E30425-1	CHAR 4/25/03	4/25/05
LISN	Electro-Metrics	ANS-25/2	2604	CAL 8/27/04	8/27/06
LISN	Electro-Metrics	EM-7820	2682	CAL 3/12/03	3/12/05
Termaline Wattmeter	Bird Electronic Corporation	611	16405	CAL 7/16/04	7/16/06
Termaline Wattmeter	Bird Electronic Corporation	6104	1926	CAL 7/16/04	7/16/06
Oscilloscope	Tektronix	2230	300572	CAL 7/3/03	7/3/05
System One	Audio Precision	System One	SYS1-45868	CHAR 4/25/02	4/25/04
Temperature Chamber	Tenney Engineering	TTRC	11717-7	CHAR 1/22/02	1/22/04
AC Voltmeter	HP	400FL	2213A14499	CAL 7/19/04	7/19/06
AC Voltmeter	HP	400FL	2213A14261	CHAR 10/15/01	10/15/03
AC Voltmeter	HP	400FL	2213A14728	CHAR 10/15/01	10/15/03
Digital Multimeter	Fluke	77	35053830	CHAR 1/8/02	1/8/04
Digital Multimeter	Fluke	77	43850817	CHAR 1/8/02	1/8/04

APPLICANT: KANEMATSU USA INC.

FCC ID: IV9FNCU-M45

REPORT #: K\KANEMATSU USA_\104AUT4\104AUT4TestReport.doc

TIMCO ENGINEERING INC.

849 NW State Road 45
 Newberry, Florida 32669
<http://www.timcoengr.com>
 888.472.2424 F 352.472.2030 email: sid@timcoengr.com

Device	Manufacturer	Model	Serial Number	Cal/Char Date	Due Date or Status
Digital Multimeter	HP	E2377A	2927J05849	CHAR 1/8/02	1/8/04
Multimeter	Fluke	FLUKE-77-3	79510405	CHAR 9/26/01	9/26/03
Peak Power Meter	HP	8900C	2131A00545	CAL 7/2/03	7/2/05
Power Sensor	Agilent Technologies	84811A	2551A02705	CAL 7/2/03	7/2/05
Power Meter	HP	432A	1141A07655	CAL 4/15/03	4/15/05
Power Sensor	HP	478A	72129	CAL 4/15/03	4/15/05
Power Meter And Sensor	Bird	4421-107 & 4022	0166 & 0218	CAL 4/16/03	4/16/05
Digital Thermometer	Fluke	2166A	42032	CAL 7/19/04	7/19/06
Thermometer	Traulsen	SK-128		CHAR 1/22/02	1/22/04
Thermometer	Extech	4028	14871-2	CAL 3/7/03	3/7/05
Hygro-Thermometer	Extech	445703	0602	CAL 10/4/02	10/4/04
Frequency Counter	HP	5352B	2632A00165	CAL 8/3/04	8/3/06
Frequency Counter	HP	5385A	2730A03025	CAL 3/7/03	3/7/05
Service Monitor	IFR	FM/AM 500A	5182	CAL 11/22/00	Out of Service
Comm. Serv. Monitor	IFR	FM/AM 1200S	6593	CAL 5/12/02	5/12/04
Signal Generator	HP	8640B	2308A21464	CAL 8/26/04	8/26/06
Sweep Generator	Wiltron	6648	101009	CAL 4/15/03	4/15/05
Sweep Generator	Wiltron	6669M	007005	CAL 3/3/03	3/3/05
Modulation Analyzer	HP	8901A	3435A06868	CAL 9/5/01	9/5/03
Modulation Meter	Boonton	8220	10901AB	CAL 4/15/03	4/15/05
Near Field Probe	HP	HP11940A	2650A02748	CHAR 2/1/01	Out of Service
BandReject Filter	Lorch	5BR4-	Z1	CHAR	4/17/05

APPLICANT: KANEMATSU USA INC.

FCC ID: IV9FNCU-M45

REPORT #: K\KANEMATSU USA_\104AUT4\104AUT4TestReport.doc

TIMCO ENGINEERING INC.

849 NW State Road 45
 Newberry, Florida 32669
<http://www.timcoengr.com>
 888.472.2424 F 352.472.2030 email: sid@timcoengr.com

Device	Manufacturer	Model	Serial Number	Cal/Char Date	Due Date or Status
	Microwave	2400/60-N		4/17/03	
BandReject Filter	Lorch Microwave	6BR6-2442/300-N	Z1	CHAR 4/17/03	4/17/05
BandReject Filter	Lorch Microwave	5BR4-10525/900-S	Z1	CHAR 4/12/03	4/12/05
Notch Filter	Lorch Microwave	5BRX-850/X100-N	AD-1	CHAR 4/17/03	4/17/05
High Pass Filter	Unk	3768(5)-400	041	CHAR 12/17/02	12/17/04
High Pass Filter	Microlab	HA-10N		CHAR 11/17/02	11/17/04
High Pass Filter	Microlab	HA-20N		CHAR 12/17/02	12/17/04
Audio Oscillator	HP	653A	832-00260	CHAR 12/1/02	12/1/04
Audio Generator	B&K Precision	3010	8739686	CHAR 12/1/02	12/1/04
Frequency Counter	HP	5382A	1620A03535	CHAR 3/2/01	Out of Service
Frequency Counter	HP	5385A	3242A07460	CAL 3/7/03	3/7/05
Amplifier	HP	11975A	2738A01969	No Cal Required	
Egg Timer	Unk			CHAR 2/1/02	2/1/04
Measuring Tape-20M	Kraftixx	0631-20		CHAR 2/1/02	2/1/04
Measuring Tape-7.5M	Kraftixx	7.5M PROFI		CHAR 2/1/02	2/1/04
Coaxial Cable #51	Insulated Wire Inc.	NPS 2251-2880	Timco #51	CHAR 1/23/02	1/23/04
Coaxial Cable #64	Semflex Inc.	60637	Timco #64	CHAR 1/24/02	1/24/04
Coaxial Cable #65	General Cable Co.	E9917 RG233/U	Timco #65	CHAR 1/23/02	1/23/04
Coaxial Cable #106	Unknown	Unknown	Timco #106	CHAR 1/23/02	1/23/04
Injection Probe	Fischer Custom Communications	F-120-9A	270	CAL 6/1/01	6/1/03
Power Line Coupling/Decoupling Network	Fischer Custom Communications	FCC-801-M2-16A	01048	CAL 8/29/01	8/29/03
Power Line	Fischer Custom	FCC-801-M3-	01060	CAL	8/29/03

APPLICANT: KANEMATSU USA INC.

FCC ID: IV9FNCU-M45

REPORT #: K\KANEMATSU USA_\104AUT4\104AUT4TestReport.doc

TIMCO ENGINEERING INC.

849 NW State Road 45
 Newberry, Florida 32669
<http://www.timcoengr.com>
 888.472.2424 F 352.472.2030 email: sid@timcoengr.com

Device	Manufacturer	Model	Serial Number	Cal/Char Date	Due Date or Status
Coupling/Decoupling Network	Communications	16A		8/29/01	
VHF/UHF Current Probe	Fischer Custom Communications	F-52	130	CAL 8/30/01	8/30/03
Passive Impedance Adapter	Fischer Custom Communications	FCC-801-150-50-CDN	01117 & 01118	CAL 8/29/01	8/29/03
Radiating Field Coil	Fischer Custom Communications	F-1000-4-8/9/10-L-1M	9859	CAL 10/15/98	10/15/00
EMC Immunity Test System	Keytek	CEMASTER	9810210	CAL 2/1/02	2/1/04
Compliance Test System - AC Power Source	California Instruments	1251RP	L05865	CAL 2/25/04	2/25/06
Compliance Test System - PACS-1 Module	California Instruments	PACS-1	X71484	CAL 2/25/04	2/25/06
Isotropic Field Probe	Amplifier Research	FP5000	22839		
Isotropic Field Probe	Amplifier Research	FP5000	300103		
Capacitor Clamp	Keytek	CM-CCL	9811359	No Cal Required	
Amplifier	Amplifier Research	10W1000B	23117	No Cal Required	
Field Monitor	Amplifier Research	FM5004	22288	No Cal Required	
ELF Meter	F. W. Bell	4060	Not Serialized		Out of Service
Standard Gain Horn 1.0-2.4 GHz	Polarad	CA-L	235	No Cal Required	
Standard Gain Horn 2.14-4.34 GHz	Polarad	CA-S	203	No Cal Required	
Standard Gain Horn 3.95-5.85 GHz	Scientific-Atlanta Inc.	11A-3.9	8448CG	No Cal Required	
Standard Gain Horn 8.2-12.5 GHz	Systron Donner	DBG-520-20	Not Serialized	No Cal Required	
Standard Gain Horn 18.0-26.3 GHz	Systron Donner	DBE-520-20	Not Serialized	No Cal Required	
Standard Gain Horn 26.5-40.2 GHz	Systron Donner	DBD-520-20	Not Serialized	No Cal Required	
Standard Gain Horn 40.0-60.0 GHz	ATM	19-443-6R	Not Serialized	No Cal Required	
Double-Ridged Horn	EMCO	3116	9011-2145		Out of

APPLICANT: KANEMATSU USA INC.

FCC ID: IV9FNCU-M45

REPORT #: K\KANEMATSU USA_\104AUT4\104AUT4TestReport.doc

TIMCO ENGINEERING INC.

849 NW State Road 45

Newberry, Florida 32669

<http://www.timcoengr.com>

888.472.2424 F 352.472.2030 email: sid@timcoengr.com

Device	Manufacturer	Model	Serial Number	Cal/Char Date	Due Date or Status
Antenna					Service
Standard Gain Horn 12.4-18.0 GHz	ATM	62-442-6	D262108-01	No Cal Required	
Standard Gain Horn 5.85-8.2 GHz	ATM	137-442-2	D261908-01	No Cal Required	
AC Voltmeter	HP	400F	0950A05433	CAL 8/13/03	8/13/05
RF Power Amplifier	Ophir RF	5150F	1041 'X1'	No Cal Required	
Electric Field Sensor	Amplifier Research	FP6001	302504		
Electric Field Sensor	Amplifier Research	FP6001	302510	CAL 6/1/04	6/1/06
Surge Generator	Com-Power Corporation	SG-168	25802	CAL 2/27/04	2/27/06
RF Power Amplifier	Ophir RF, Inc.	5150F	1041	CHAR 10/31/03	10/31/05
3-Meter Anechoic Chamber	Panashield	N/A	N/A	Listed 5/12/04	5/11/07
Digital Multimeter	Fluke	77III	79510408	CAL 7/19/04	7/19/06
Open-Frame Tower Spectrum Analyzer	HP	8566B/85662A	2627A03154/2648A14276	CAL 7/9/04	7/9/06
Open-Frame Tower RF Preselector	HP	85685A	3107A01282	CAL 7/9/04	7/9/06
Open-Frame Tower Quasi-Peak Adapter	HP	85650A	2046A00305	CAL 7/9/04	7/9/06
Signal Generator	HP	8648C	3847A04696	CAL 9/27/04	9/27/06

APPLICANT: KANEMATSU USA INC.

FCC ID: IV9FNCU-M45

REPORT #: K\KANEMATSU USA_\104AUT4\104AUT4TestReport.doc