

MANUAL

IUH-F192-V1-*

Read/Write Head for IDENTControl



IDENTControl

With regard to the supply of products, the current issue of the following document is applicable: The General Terms of Delivery for Products and Services of the Electrical Industry, published by the Central Association of the Electrical Industry (Zentralverband Elektrotechnik und Elektroindustrie (ZVEI) e.V.) in its most recent version as well as the supplementary clause: "Expanded reservation of proprietorship"

1	Introduction.....	6
2	Certificates and Approvals	7
2.1	Declaration of Conformity (R&TTE Directive 1995/5/EC).....	7
2.2	FCC Information	7
2.3	IC Information.....	8
2.4	UL Information.....	8
2.5	Additional Country-Specific Approvals	8
3	Safety	9
3.1	Symbols Relevant to Safety	9
3.2	Intended Use	9
3.3	General Notes on Safety	10
4	Product Description	11
4.1	RFID Frequency Bands.....	11
4.2	UHF General.....	11
4.2.1	Advantages of UHF.....	11
4.2.2	Applications for UHF systems	11
4.2.3	Memory Structure of a Tag acc. to EPC Gen 2 (ISO/IEC 18000-63) .	12
4.2.4	Electronic Product Code (EPC).....	14
4.2.5	Influence of various materials on the sensing range.....	14
4.2.6	Dense Reader Mode (DRM)	15
4.2.7	Frequency Hopping Spread Spectrum.....	16
4.2.8	Relevant Standards for UHF.....	16

4.3	Countries of Use	17
4.3.1	European Union	17
4.3.2	Argentina.....	17
4.3.3	Australia	18
4.3.4	Brazil	18
4.3.5	Canada	18
4.3.6	China.....	18
4.3.7	Hong Kong.....	19
4.3.8	India	19
4.3.9	Japan	19
4.3.10	Colombia.....	19
4.3.11	Malaysia	19
4.3.12	Mexico.....	20
4.3.13	New Zealand.....	20
4.3.14	Russia	20
4.3.15	Singapore.....	20
4.3.16	South Korea	21
4.3.17	Thailand	21
4.3.18	United States of America	22
4.3.19	Vietnam.....	22
4.4	General Functions and Features	22
4.5	Indicators and Operating Elements	23
4.6	Connection.....	23
4.7	Scope of Delivery	24
4.8	Accessories	24
4.8.1	IDENTControl.....	24
4.8.2	Read/Write Tags.....	25
4.8.3	Connection cable for R/W heads and trigger sensors	25
4.8.4	Cable connectors for the power supply	26
4.8.5	Installation accessories	26
5	Installation.....	27
5.1	Storage and Transport	27
5.2	Unpacking	27

5.3	Mounting	27
5.3.1	Room Orientation.....	28
5.3.2	Minimum Distances	29
5.3.3	Polarization	29
5.4	Connection	30
5.5	EMC Concept	30
6	Commissioning	32
6.1	Definitions	32
6.1.1	Display	32
6.1.2	Legend.....	32
6.2	Initial Commissioning	33
6.3	Device Settings	35
6.4	Operation via the Command Interface	35
7	Operation	38
7.1	General	38
7.2	Basic Command Process	38
7.3	Command Overview	39
7.4	Read/Write Commands	40
7.5	Filter Commands	44
7.6	Configuration Commands	47
7.6.1	ChangeTag Command.....	48
7.6.2	Read and Write Parameters	49
7.6.3	Parameters	51
7.7	Error/Status Messages	60
8	Service and Maintenance	61
9	Troubleshooting	62
10	Appendix	63
10.1	Dimensions	63
10.2	ASCII Table	63
10.3	Detection Range	64



1 Introduction

Congratulations

You have chosen a device manufactured by Pepperl+Fuchs. Pepperl+Fuchs develops, produces and distributes electronic sensors and interface modules for the market of automation technology on a worldwide scale.

Before you install this device and put it into operation, please read the operating instructions thoroughly. The instructions and notes contained in this operating manual will guide you step-by-step through the installation and commissioning procedures to ensure trouble-free use of this product. By doing so, you:

- guarantee safe operation of the device
- can utilize the entire range of device functions
- avoid faulty operation and the associated errors
- reduce costs from downtimes and incidental repairs
- increase the effectiveness and operating efficiency of your plant.

Store this operating manual somewhere safe in order to have it available for future work on the device.

After opening the packaging, please ensure that the device is intact and that the package is complete.

Symbols used

The following symbols are used in this manual:



Note!

This symbol draws your attention to important information.



Handling instructions

You will find handling instructions beside this symbol

Contact

If you have any questions about the device, its functions, or accessories, please contact us at:

Pepperl+Fuchs GmbH
Lilienthalstraße 200
68307 Mannheim
Telephone: +49 621 776-4411
Fax: +49 621 776-274411
E-Mail: fa-info@pepperl-fuchs.com

2 Certificates and approvals

2.1 Declaration of Conformity (R&TTE Directive 1995/5/EC)

This product was developed and manufactured under observance of the applicable European standards and guidelines.



Note!

A Declaration of Conformity can be requested from the manufacturer or downloaded from www.pepperl-fuchs.com.

The product manufacturer, Pepperl+Fuchs GmbH, 68307 Mannheim, has a certified quality assurance system that conforms to ISO 9001.



2.2 FCC Information

FCC ID: IREIUH-F192-V1

This device complies with Part 15 of the FCC Rules. Operation is subject to the following two conditions:

1. This device may not cause harmful interference, and
2. This device must accept any interference received, including interference that may cause undesired operation.

Attention:

Changes or modifications not expressly approved by the party responsible for compliance could void the user's authority to operate the equipment.

Note:

This equipment has been tested and found to comply with the limits for a Class A digital device, pursuant to part 15 of the FCC Rules. These limits are designed to provide reasonable protection against harmful interference when the equipment is operated in a commercial environment. This equipment generates, uses, and can radiate radio frequency energy and, if not installed and used in accordance with the instruction manual, may cause harmful interference to radio communications. Operation of this equipment in a residential area is likely to cause harmful interference in which case the user will be required to correct the interference at his own expense.

FCC Notice

To comply with FCC part 15 rules in the United States, the system must be professionally installed to ensure compliance with the Part 15 certification. It is the responsibility of the operator and professional installer to ensure that only certified systems are deployed in the United States. The use of the system in any other combination (such as co-located antennas transmitting the same information) is expressly forbidden.

FCC Exposure Information

To comply with FCC RF exposure compliance requirements, the antennas used for this transmitter must be installed to provide a separation distance of at least 30 cm from all persons and must not be co-located or operated in conjunction with any other antenna or transmitter.

2.3 IC Information

This device complies with Industry Canada licence-exempt RSS standard(s) and with part 15 of the FCC Rules. Operation is subject to the following two conditions:

1. this device may not cause interference, and
2. this device must accept any interference, including interference that may cause undesired operation of the device.

Le présent appareil est conforme aux CNR d'Industrie Canada applicables aux appareils radio exempts de licence. L'exploitation est autorisée aux deux conditions suivantes :

1. l'appareil ne doit pas produire de brouillage, et
2. l'utilisateur de l'appareil doit accepter tout brouillage radioélectrique subi, même si le brouillage est susceptible d'en compromettre le fonctionnement.

IC Exposure Information

To comply with IC RF exposure compliance requirements, the antennas used for this transmitter must be installed to provide a separation distance of at least 30 cm from all persons and must not be co-located or operated in conjunction with any other antenna or transmitter.

2.4 UL Information

Technical Data and Environmental Conditions

This device is for indoor use only.

This device may be operated in altitudes up to 2000 m.

The ambient temperature range is from -25 °C to +50 °C for continuous transmission mode, or -25 °C to +70 °C for operation with non-transmission periods.

The maximum relative humidity is 80 % for temperatures up to 31 °C decreasing linearly to 50 % relative humidity at 40 °C.

Nominal power supply voltage is 24 V_{DC}. For the intended use this read/write head has to be connected to Pepperl+Fuchs IDENTControl control interfaces using a shielded connection cable. The IDENTControl supplies the read/write head with 20 ... 30 V_{DC}, Protective Extra Low Voltage (PELV).

Protection class IP67 is not included in the UL approval. The protection class is tested by Pepperl + Fuchs GmbH.

2.5 Additional country-specific approvals

For all current approvals see the data sheet of your read / write head under www.pepperl-fuchs.com.

3 Safety

3.1 Symbols relevant to safety



Danger!

This symbol indicates an imminent danger.
Non-observance will result in personal injury or death.



Warning!

This symbol indicates a possible fault or danger.
Non-observance may cause personal injury or serious property damage.



Caution!

This symbol indicates a possible fault.
Non-observance could interrupt the device and any connected systems and plants, or result in their complete failure.

3.2 Intended Use

The IUH-F192-V1-^{*} is a read/write head for passive read-only and read/write tags.

Always operate the device as described in these instructions to ensure that the device and connected systems function correctly. The protection of operating personnel and plant is only guaranteed if the device is operated in accordance with its intended use.

Read through these instructions thoroughly. Familiarize yourself with the device before installing, mounting, or operating.

Pepperl+Fuchs GmbH provides no guarantee that the information contained in this document does not contain third-party industrial property rights. Pepperl+Fuchs GmbH does not issue any licenses to its own or third-party patents or other industrial property rights in this document.



Note!

The installation recommendations made in this document are based on favorable conditions. Pepperl+Fuchs GmbH provides no guarantee of correct function in cross environments.



Warning!

Malfunctions with pacemakers

This device does **not** exceed the permissible limits for electromagnetic fields. Maintain a minimum distance of 30cm between the device and your pacemaker.

Inadequate distance from the read/write head can result in inhibitions, reprogramming, or incorrect stimulation pulses.

3.3 General notes on safety

Only instructed specialist staff may operate the device in accordance with the operating manual.

User modification and or repair are dangerous and will void the warranty and exclude the manufacturer from any liability. If serious faults occur, stop using the device. Secure the device against inadvertent operation. In the event of repairs, return the device to your local Pepperl+Fuchs representative or sales office.

The connection of the device and maintenance work when live may only be carried out by a qualified electrical specialist.

The operating company bears responsibility for observing locally applicable safety regulations.

Store the not used device in the original packaging. This offers the device optimal protection against impact and moisture.

Ensure that the ambient conditions comply with regulations.



Note!

Disposal

Electronic waste is hazardous waste. When disposing of the equipment, observe the current statutory requirements in the respective country of use, as well as local regulations.

4 Product Description

4.1 RFID Frequency Bands

The following diagram shows the position of the different frequency bands used for RFID. The read/write heads described in this manual operate in the frequency range from 865 MHz ... 868 MHz and from 902 MHz ... 928 MHz, highlighted in color.

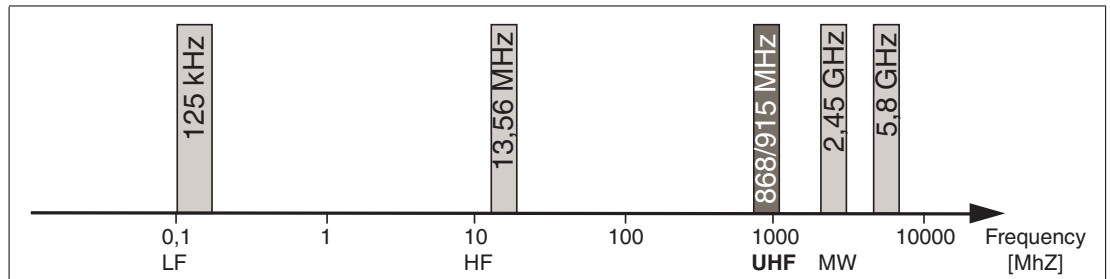

- 100 kHz ... 135 kHz: Low frequency LF
- 13.56 MHz: High frequency HF
- 865 MHz ... 868 MHz (Europe), 902 MHz ... 928 MHz (USA), 920 MHz ... 925 MHz (China): ultra-high frequency UHF
- 2.45 GHz and 5.8 GHz: Microwave MW

4.2 UHF General

4.2.1 Advantages of UHF

- Long detection range
- UHF tags are available as cheap and space-saving adhesive labels
- High transfer rates
- Tag is available with a large working memory (user memory)
- Bulk detection

4.2.2 Applications for UHF systems

- Identification in galvanic coating or painting systems used in automotive production,
- Identification feasible over greater distances than with LF and HF systems,
- Identification of automotive superstructures in automotive production,
- Pallet identification and measurement of goods movements in the logistics sector, and
- Access control at unloading stations with HGV identification.

4.2.3 Memory Structure of a Tag in Accordance with EPC Gen 2 (ISO/IEC 18000-63)

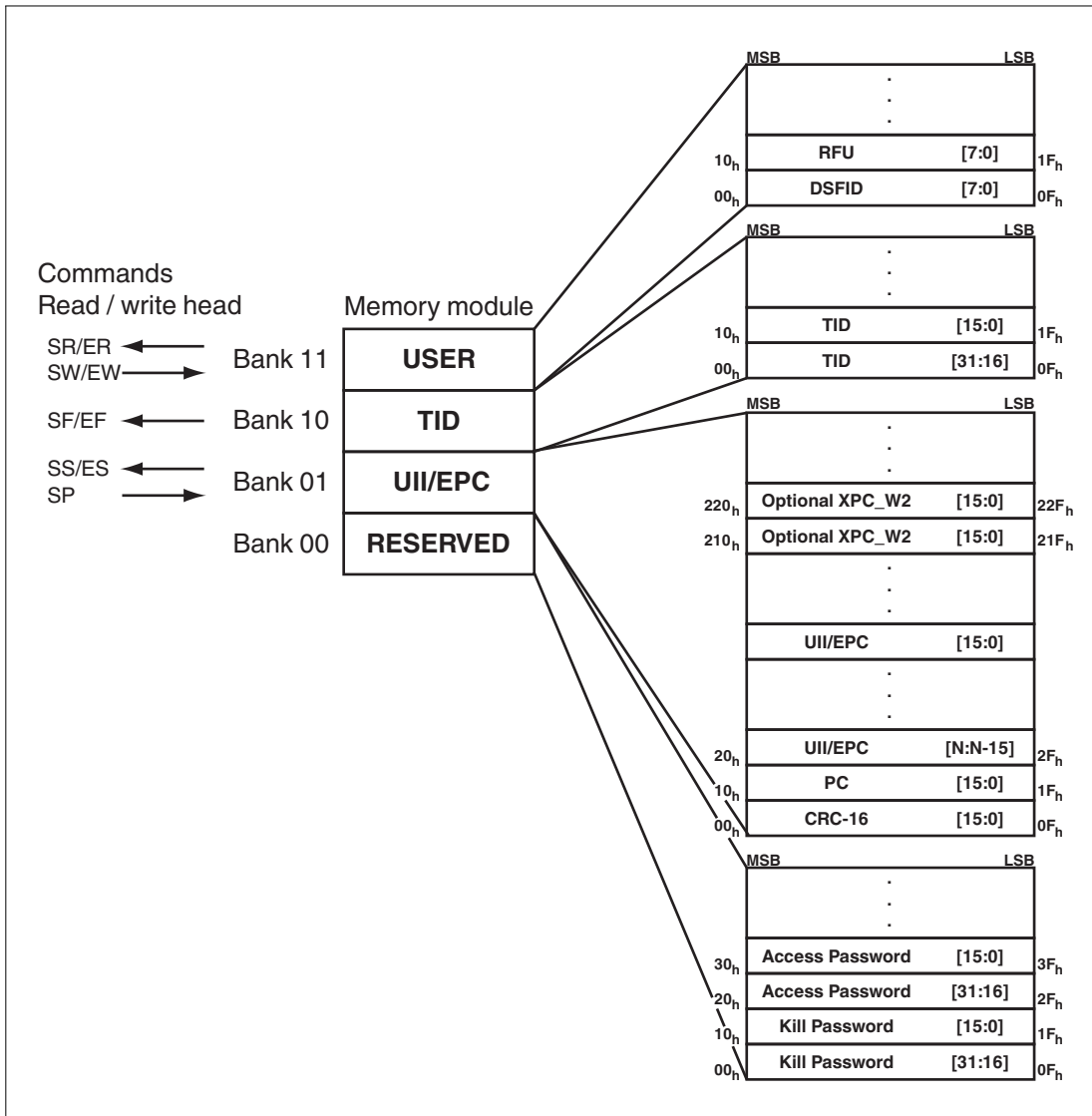

The memory module of an EPC Gen 2 (ISO/IEC 18000-63) tag is split into four segments. The main contents of these segments are:

Segment	Function	Length
Bank 00 (00 _{bin} = 0 _{dec})	Password management	Depending on the tag type, see table "Tag Types, UHF" on page 48/column "Bank 00"
Bank 01 (01 _{bin} = 1 _{dec})	Unique Item Identifier (UII) Electronic Product Code (EPC)	Depending on the tag type, see table "Tag Types, UHF" on page 48/column "UII/EPC"
Bank 10 (10 _{bin} = 2 _{dec})	Tag ID (TID)	4 bytes (MDID, TMN) + 0, 4, or 8 bytes
Bank 11 (11 _{bin} = 3 _{dec})	User memory	Depending on the tag type, see table "Tag Types, UHF" on page 48/column "User Data"

Bank 00: Password Management

The segment **Bank 00** contains the password management information, comprising the access password and the kill password. The read/write head manages the kill password with the standard read/write commands SW and SR. The access password is not supported. See "Single Read Words SR" on page 42, see "Single Write Words SW" on page 43, and see "Memory Module for Tag Accesses to the "Memory Bank" MB" on page 53.

Bank 01: UII/EPC

In addition to the Unique Item Identifier (UII), the segment **Bank 01** contains a calculated checksum CRC (Cyclic Redundancy Check) for verifying data on the tag and the protocol control (PC) area. The PC area contains:

- The length of the UII
- The Application Family Identifier (AFI) box
- A bit switch that shows whether the UII contains an EPC sequence of numbers in accordance with ISO (see chapter 4.2.4)
- A bit switch that shows whether data is stored in segment bank 11 (if present)

The data is addressed via the following commands: single read special read-only code (SS), single write special read-only code (SP), and enhanced read special read-only code (ES). See "Single Read Special Read-Only Code SS" on page 40, see "Single Write Special Read-Only Code SP" on page 41, and see "Enhanced Read Special Read-Only Code ES" on page 41.

Bank 10: TID

The segment **Bank 10** contains the tag identifier (TID), consisting of the part number and optional serial number of the tag. This data is permanently stored without being changed. The first byte denotes the class of the tag with E0_{hex}, E2_{hex}, or E3_{hex}. The rest of the TID depends on the class, and can be derived from standard ISO/IEC 18000-63.

Example:

All tags with the class EPC Gen 2 (ISO/IEC 18000-63) are marked with E2_{hex}. The TID is comprised as follows:

- 4 bytes: part number of the tag
 - 1 byte: identifier
 - 12 bits: tag mask designer identifier (MDID)
 - 12 bits: tag model number (TMN), defined by the manufacturer:
- 4 or 8 bytes: serial number of the tag

Depending on the manufacturer, the serial numbers do not have to be unique or may even be omitted.

The data in segment **Bank 10** can be output via the single read read-only code (SF) and enhanced read read-only code (EF) commands. (see "Single Read Read-Only Code SF" on page 40 and see "Enhanced Read Read-Only Code EF" on page 40)

Bank 11: User Memory

Segment **Bank 11** contains an area to which the user has free access. This size of this area depends on the chip type, or the area may not be present.

The data in segment **Bank 11** is addressed via the single read words (SR), single write words (SW), enhanced read words (ER), and enhanced write words (EW) commands. (see "Single Read Words SR" on page 42, see "Single Write Words SW" on page 43, see "Enhanced Read Words ER" on page 42, and see "Enhanced Write Words EW" on page 43)



4.2.4 Electronic Product Code (EPC)

The electronic product code is a unique identifier in the form of a sequence of numbers. The number sequence has a set structure and a length of 64 bits, 80 bits, 96 bits, or longer (depending on the EPC Ident number used). This number sequence is saved to the RFID tag, offering worldwide unique identification of the tagged object.

The system of Electronic Product Codes (EPC) was defined by GS1/EPCglobal for use in inventory management. Tags with memory banks for EPC codes must be programmed by the user. The memory of new tags must not contain any valid EPC codes. The EPC numbers are managed and assigned by GS1. To obtain EPC numbers, please contact the GS1 branch in your country (<http://www.gs1.com/contact>).

The electronic product code is defined by EPCglobal with at present 13 different encryptions. SGTIN-96 (serialized global trade item number) is given here as an example of a frequently used encryption. SGTIN-96 has a defined format, and is structured as follows:

1. **Header:** The header specifies the EPC standard used, and denotes the number sequence.
2. **Filter value:** Denotes the unit of the product, for example, end product, additional packaging, pallet.
3. **Partition:** Denotes the point at which the following company prefix ends and the object data begins.
4. **Company Prefix:** Assigned sequence of numbers that identifies the producer.
5. **Object class:** Sequence of numbers that describes the object, e.g., item number.

The company prefix and the object class are each of variable length, but together are always 44 bits long.

6. **Serial number:** Sequence of numbers that identifies the item, for example, the sequential serial number of the item.

	Header	Filter value	Partition	Company Prefix	Object class	Serial number
Length	8 Bit	3 Bit	3 Bit	20 - 40 Bit	4 - 24 Bit	38 Bit
Value	48 _{dez}	0 _{dez}	5 _{dez}	4050143 _{dez}	124 _{dez}	203886 _{dez}

To work with unique number sequences without having to use sometimes expensive EPC codes, we recommend using the TID of the tag, which is programmed into the tag chips by the semiconductor manufacturer.

4.2.5 Influence of various materials on the sensing range

In the UHF range, the nature of the surrounding area and the surface to which the transponder is secured have a serious influence on the range that the system can attain. The UHF transponder cannot be mounted on metal without requiring adaptations. Glass has a negative influence on the sensing range when used as a mounting surface. If a UHF transponder is mounted on damp material, the sensing range is much poorer than the range of a transponder mounted on dry material. The mounting surface often affects the read range much more than the material between the transponder and the read/write head. The graph shows the effect of different materials on the sensing range.

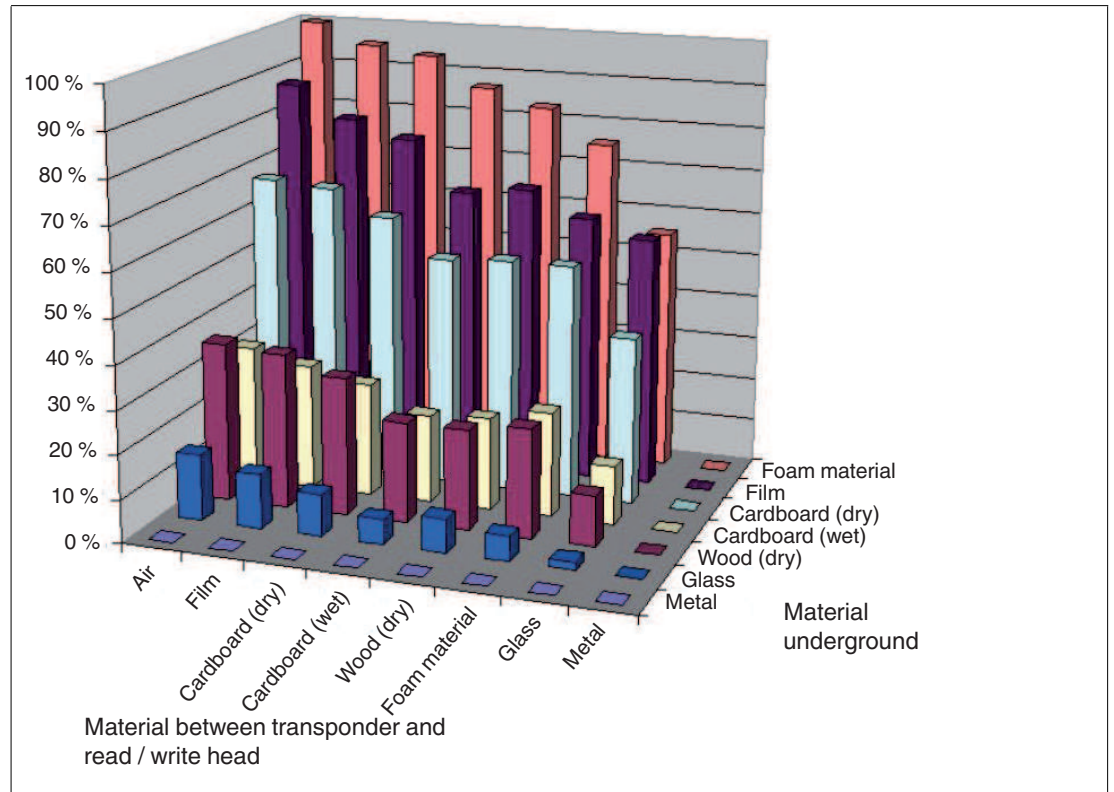

4.2.6 Dense Reader Mode (DRM)

Europe

A special operating mode for read/write tags in accordance with the specification EPC Gen 2 (ISO/IEC 18000-63) allows several read/write heads to be operated close to each other simultaneously without interference.

In accordance with EN 302208, the read/write head uses only channels 4, 7, 10, and 13 in this mode for transmission (read/write head → read/write tag communication path). The transmission power is a maximum of 2 W_{erp} in accordance with EN 302208.

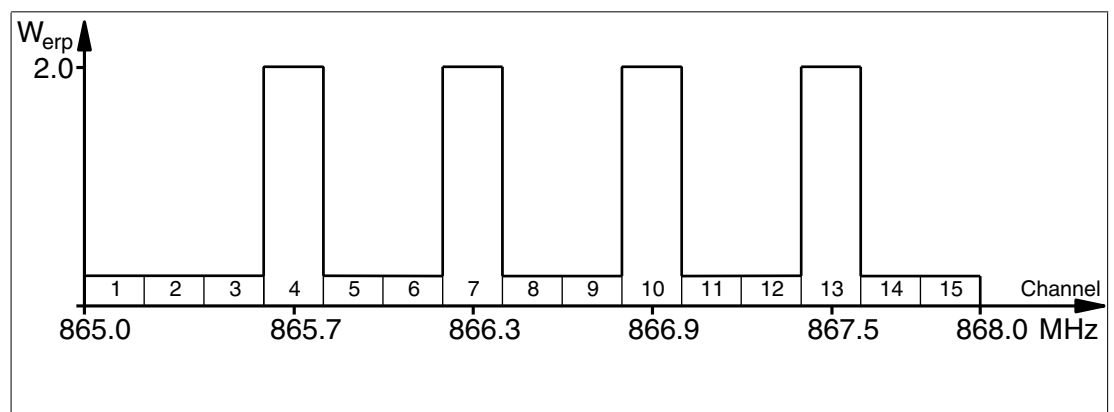

Figure 4.1

The response from the read/write tag appears via the frequency offset, which is achieved by the modulation used in this mode on the two adjacent channels. Due to the high level difference between the transmission channels and the response channels, this technology offers major benefits for reusing frequencies.

4.2.7 Frequency Hopping Spread Spectrum

With FHSS (Frequency Hopping Spread Spectrum), the information to be transmitted is distributed successively through multiple channels. Only one frequency channel is used at any one time. This results in a larger bandwidth for the entire signal, in spite of the fact that each channel has a smaller bandwidth. The following sections set out some examples with various parameters. Different parameterizations apply in other countries.

China

In China, 920 MHz ... 925 MHz is one of the frequency ranges available for UHF-RFID readers. The range is split into channels, each with a bandwidth of 250 kHz. A maximum of 2 W_{ERP} is permitted on 16 of the available channels. The transmission power is indicated in W_{ERP} . FHSS is used with a maximum retention time of two seconds. The IUH-F190-V1-FR2 and the IUH-F192-V1-FR2 use channel 2 to channel 17.

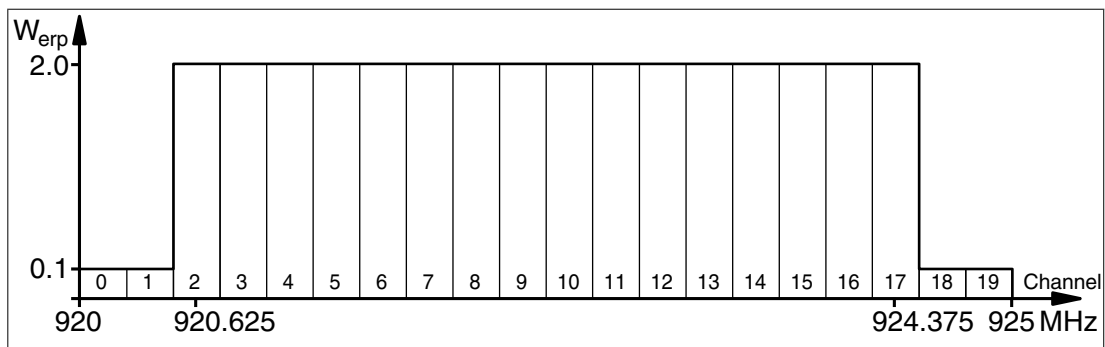

Figure 4.2

United States

The ISM band from 902 MHz ... 928 MHz is available in the USA. The band is split into 50 channels, each with a 500 kHz bandwidth. FHSS with a maximum retention time of 0.4 seconds is used. All channels must be used. Channel restriction is not permitted.

In contrast to the read/write heads for Europe and China, the transmission power is indicated in W_{eirp} . A maximum of 4 W_{eirp} is permitted on all channels.

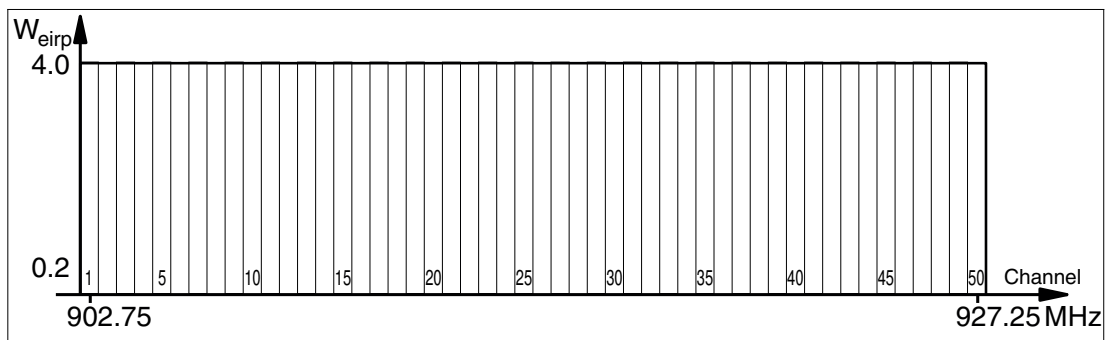

Figure 4.3

4.2.8 Relevant Standards for UHF

European radio standards: EN 300220 and EN 302208

Usage recommendations for RFID type labels, information about recycling, installation of readers and antennae: ISO/IEC TR 24729 parts 1-4

Installation and commissioning of UHF-RFID systems: ETSI TR 102436

Description of air interface: EPC Gen 2 (ISO/IEC 18000-63)

4.3 Countries of Use



Note!

Country Identifier

All IUH-F192-V1-^{*} read/write heads operate within their maximum frequency range with the appropriate settings for the relevant country. You must set the correct country identifier when commissioning for the first time. See chapter 6.2.



Note!

If you wish to use the IUH-F192-V1-^{*} read/write head in a country not included in this chapter, make sure the relevant values for the read/write head are consistent with the local conditions before use.



Note!

Transmission License

A country-specific transmission license is required to operate the read/write head. In the European Union and Turkey, the manufacturer's EU declaration of conformity constitutes an adequate license. A currently valid transmission license may not exist for all countries of use listed in this chapter, as transmission licenses are temporary in some countries. All currently valid transmission licenses can be found in the data sheet for the respective read/write head at www.pepperl-fuchs.com

The country identifier also defines the frequency access method used.

Frequency Access Method

- In many countries, including the USA and China, a frequency hopping spread spectrum is used. See chapter 4.2.7. The number and position of the frequencies is fixed and cannot be changed by the user. All channels are used.
- A programmable frequency list is used in other countries, including the European Union, Singapore, Vietnam, and India. You can compile this frequency list from a specified set of channels. Four channels are specified in the European Union as appropriate for dense reader mode in accordance with EN 302208. See chapter 4.2.6. When selecting this country identifier, you can configure one or more channels, or all four channels.

4.3.1 European Union

In the European Union, the use of RFID in the UHF range is regulated by EN 302208.

- UHF wavelength: 865 MHz ... 868 MHz
- Radiated power: 10 mW ... 2000 mW_{ERP}; Default = 500 mW_{ERP} (IUH-F192-V1-FR1)
- Channel bandwidth: 200 kHz
- Channel spacing: 600 kHz
- Frequency access method: programmable frequency list
- Number of predefined channels: 4
 Programmable channels: 4, 7, 10, 13
 Center frequencies: 865.7 MHz, 866.3 MHz, 866.9 MHz, 867.5 MHz
 Up to four channels can be parameterized and used in sequence.
 Default: dense reader mode on channel 4, 10, 7, 13. See chapter 4.2.6.

4.3.2 Argentina

The regulations for the UHF frequency range in Argentina are the same as the regulations for the UHF frequency range in the USA. See chapter 4.3.18.



4.3.3 Australia

In Australia, the use of RFID in the UHF range is regulated as follows:

- UHF wavelength: 920 MHz ... 926 MHz
- Radiated power: 10 mW ... 4000 mW_{EIRP}; Default = 800 mW_{EIRP} (IUH-F192-V1-FR2)
- Channel bandwidth: 500 kHz
- Channel spacing: 500 kHz
- Frequency access method: frequency hopping spread spectrum. See chapter 4.2.7.
- Number of channels: 12
Channels used: 1, 2, 3, ... 12
Center frequencies: 919.75 MHz + (M x 0.5) MHz
All 12 channels are always used.

4.3.4 Brazil

In Brazil, the use of RFID in the UHF range is regulated as follows:

- UHF wavelength: 915 MHz ... 928 MHz
- Radiated power: 10 mW ... 4000 mW_{EIRP}; Default = 800 mW_{EIRP} (IUH-F192-V1-FR2)
- Channel bandwidth: 250 kHz
- Channel spacing: 250 kHz
- Frequency access method: frequency hopping spread spectrum. See chapter 4.2.7.
- Number of channels: 52
Channels used: 1, 2, 3, ... 52
Center frequencies: 914.875 MHz + (M x 0.25) MHz
All 52 channels are always used.

4.3.5 Canada

The regulations for the UHF frequency range in Canada are the same as the regulations for the UHF frequency range in the USA. See chapter 4.3.18.

4.3.6 China

In China, the use of RFID in the UHF range is regulated by the provisions of the China Ministry of Industry and Information Technology (CMIIT).

- UHF wavelength: 920 MHz ... 925 MHz
- Radiated power: 6 mW ... 2000 mW_{ERP}; Default = 500 mW_{ERP} (IUH-F192-V1-FR2)
- Channel bandwidth: 250 kHz
- Channel spacing: 250 kHz
- Frequency access method: frequency hopping spread spectrum (China). See chapter 4.2.7.
- Number of channels: 16
Channels used: 2, 3, 4, ... 17
Center frequencies: 920.125 MHz + (M x 0.25) MHz
All 16 channels are always used.

4.3.7 Hong Kong

The regulations for the UHF frequency range of 865 MHz to 868 MHz in Hong Kong are the same as the regulations for the UHF frequency range in the European Union. See chapter 4.3.1.

The regulations for the UHF frequency range of 920 MHz to 925 MHz in Hong Kong are the same as the regulations for the UHF frequency range in Thailand. See chapter 4.3.17.

4.3.8 India

In India, the use of RFID in the UHF range is regulated in accordance with EN 302208.

- UHF wavelength: 865 MHz ... 867 MHz
- Radiated power: 10 mW ... 2000 mW_{ERP}; Default = 500 mW_{ERP} (IUH-F192-V1-FR1)
- Channel bandwidth: 200 kHz
- Channel spacing: 200 kHz
- Frequency access method: programmable frequency list
- Number of predefined channels: 10

Programmable channels: 1, 2, 3, ... 10

Center frequencies: 865.1 MHz, 865.3 MHz, 865.5 MHz, 865.7 MHz, 865.9 MHz, 866.1 MHz, 866.3 MHz, 866.5 MHz, 866.7 MHz, 866.9 MHz

Up to ten channels can be parameterized and used in sequence.

Default: dense reader mode on channel 1, 7, 4, 10. See chapter 4.2.6.

4.3.9 Japan

In Japan, the use of RFID in the UHF range is regulated as follows:

- UHF wavelength: 916.7 MHz ... 920.5 MHz
- Radiated power: 10 mW ... 4000 mW_{EIRP}; Default = 800 mW_{EIRP} (IUH-F192-V1-FR2)
- Channel bandwidth: 200 kHz
- Channel spacing: 1200 kHz
- Frequency access method: programmable frequency list.
- Number of predefined channels: 4

Programmable channels: 5, 11, 17, 23

Center frequencies: 916.8 MHz, 918.0 MHz, 919.2 MHz, 920.4 MHz

Up to four channels can be parameterized and used in sequence.

Default: dense reader mode on channel 5, 17, 11, 23. See chapter 4.2.6.

4.3.10 Colombia

The regulations for the UHF frequency range in Colombia are the same as the regulations for the UHF frequency range in the USA. See chapter 4.3.18.

4.3.11 Malaysia

In Malaysia, the use of RFID in the UHF range is regulated as follows:

- UHF wavelength: 919 MHz ... 923 MHz
- Radiated power: 6 mW ... 2000 mW_{ERP}; Default = 500 mW_{ERP} (IUH-F192-V1-FR2)
- Channel bandwidth: 500 kHz
- Channel spacing: 500 kHz



- Frequency access method: frequency hopping spread spectrum. See chapter 4.2.7.
- Number of channels: 8
Channels used: 1, 2, 3, ... 8
Center frequencies: 918.75 MHz + (M x 0.5) MHz
All 8 channels are always used.

4.3.12 Mexico

The regulations for the UHF frequency range in Mexico are the same as the regulations for the UHF frequency range in the USA. See chapter 4.3.18.

4.3.13 New Zealand

In New Zealand, the use of RFID in the UHF range is regulated as follows:

- UHF wavelength: 921.5 MHz ... 928 MHz
- Radiated power: 10 mW ... 4000 mW_{ERP}; Default = 800 mW_{ERP} (IUH-F192-V1-FR2)
- Channel bandwidth: 500 kHz
- Channel spacing: 500 kHz
- Frequency access method: frequency hopping spread spectrum. See chapter 4.2.7.
- Number of channels: 13
Channels used: 1, 2, 3, ... 13
Center frequencies: 921.25 MHz + (M x 0.5) MHz
All 13 channels are always used.

4.3.14 Russia

In Russia, the use of RFID in the UHF range is regulated in accordance with EN 302208:

- UHF wavelength: 866 MHz ... 867.6 MHz
- Radiated power: 10 mW ... 2000 mW_{ERP}; Default = 500 mW_{ERP} (IUH-F192-V1-FR1)
- Channel bandwidth: 200 kHz
- Channel spacing: 200 kHz
- Frequency access method: programmable frequency list.
- Number of predefined channels: 8
Programmable channels: 1, 2, 3, ... 8
Center frequencies: 866.1 MHz, 866.3 MHz, 866.5 MHz, 866.7 MHz, 866.9 MHz, 867.1 MHz, 867.3 MHz, 867.5 MHz
Up to eight channels can be parameterized and used in sequence.
Default: dense reader mode on channel 1, 7, 4. See chapter 4.2.6.

4.3.15 Singapore

In Singapore, the use of RFID in the UHF range of 866 MHz to 868 MHz is regulated in accordance with EN 302208.

- UHF wavelength: 866 MHz ... 868 MHz
- Radiated power: 10 mW ... 500 mW_{ERP}; Default = 500 mW_{ERP} (IUH-F192-V1-FR1)
- Channel bandwidth: 200 kHz
- Channel spacing: 200 kHz

- Frequency access method: programmable frequency list
- Number of predefined channels: 10
 Programmable channels: 1, 2, 3, ... 10
 Center frequencies: 866.1 MHz, 866.3 MHz, 866.5 MHz, 866.7 MHz, 866.9 MHz, 867.1 MHz, 867.3 MHz, 867.5 MHz, 867.7 MHz, 867.9 MHz
 Up to ten channels can be parameterized and used in sequence.
 Default: dense reader mode on channel 1, 7, 4, 10. See chapter 4.2.6.

In Singapore, the use of RFID in the UHF range of 920 MHz to 925 MHz is regulated as follows.

- UHF wavelength: 920 MHz ... 925 MHz
- Radiated power: 6 mW ... 2000 mW_{ERP}; Default = 500 mW_{ERP} (IUH-F192-V1-FR2)
- Channel bandwidth: 500 kHz
- Channel spacing: 500 kHz
- Frequency access method: frequency hopping spread spectrum. See chapter 4.2.7.
- Number of channels: 10
 Channels used: 1, 2, 3, ... 10
 Center frequencies: 919.75 MHz + (M x 0.5) MHz
 All ten channels are always used.

4.3.16 South Korea

In South Korea, the use of RFID in the UHF range is regulated as follows:

- UHF wavelength: 917.2 MHz ... 920.4 MHz
- Radiated power: 10 mW ... 4000 mW_{EIRP}; Default = 800 mW_{EIRP} (IUH-F192-V1-FR2)
- Channel bandwidth: 200 kHz
- Channel spacing: 600 kHz
- Frequency access method: frequency hopping spread spectrum. See chapter 4.2.7.
- Number of channels: 6
 Channels used: 1, 4, 7, 10, 13, 16
 Center frequencies: 917.1 MHz + (M x 0.20) MHz
 All 6 channels are always used.

4.3.17 Thailand

In Thailand, the use of RFID in the UHF range is regulated as follows:

- UHF wavelength: 920 MHz ... 925 MHz
- Radiated power: 10 mW ... 4000 mW_{EIRP}; Default = 800 mW_{EIRP} (IUH-F192-V1-FR2)
- Channel bandwidth: 500 kHz
- Channel spacing: 500 kHz
- Frequency access method: frequency hopping spread spectrum. See chapter 4.2.7.
- Number of channels: 10
 Channels used: 1, 2, 3, ... 10
 Center frequencies: 919.75 MHz + (M x 0.5) MHz
 All ten channels are always used.



4.3.18 United States of America

In the USA, the use of RFID in the UHF range is regulated in accordance with the provisions set out by the Federal Communications Commission (FCC).

- UHF wavelength: 902 MHz ... 928 MHz
- Radiated power: 10 mW ... 4000 mW_{EIRP}; Default = 800 mW_{EIRP} (IUH-F192-V1-FR2-02)
- Channel bandwidth: 500 kHz
- Channel spacing: 500 kHz
- Frequency access method: frequency hopping spread spectrum (USA). See chapter 4.2.7.
- Number of channels: 50
Channels used: 1, 2, 3, ... 50
Center frequencies: 902.25 MHz + (M x 0.5) MHz
All 50 channels are always used.

4.3.19 Vietnam

The regulations for the UHF frequency range in Vietnam are the same as the regulations for the UHF frequency range in Singapore. See chapter 4.3.15.

4.4 General Functions and Features

IUH-F192-V1-FR*



Figure 4.4

Functions

The read/write head was developed for reading and writing passive read/write tags with an ultra-high operating frequency.

Detection Range

The detection range is typically 4 meters. Tags that comply with EPC Gen 2 (ISO/IEC 18000-63) are supported.

Maximum Frequency Range

The IUH-F192-V1-FR1 read/write head can be operated in the frequency range from 865 MHz to 868 MHz. The IUH-F192-V1-FR2 read/write head can be operated in the frequency range from 902 MHz to 928 MHz.

Features

The read/write head has the following features:

- 2 x 3 function indicator LEDs
- Industrial housing
- Bulk detection
- Connects to the IDENTControl via connector V1 (M12 x 1)
- Protected against electrostatic discharge

Integrated antenna

The IUH-F192-V1-FR1 and IUH-F192-V1-FR2 read/write heads have a linear dual-polarized antenna. The read/write heads can transmit and receive waves with horizontal and vertical polarization.

4.5 Indicators and Operating Elements

The IUH-F192-V1-* read/write head has 2 x 3 LEDs, which are green/blue/yellow. The various indicators denote:

- Green LED: Continuously on - Power on
Flashing - Region code must be set. See chapter 6.2.
- Yellow LED: Read/write operation successful
- Blue LED: Transmission mode

4.6 Connection

The read/write head is connected to the IDENTControl control interface via the M12 x 1 connector.

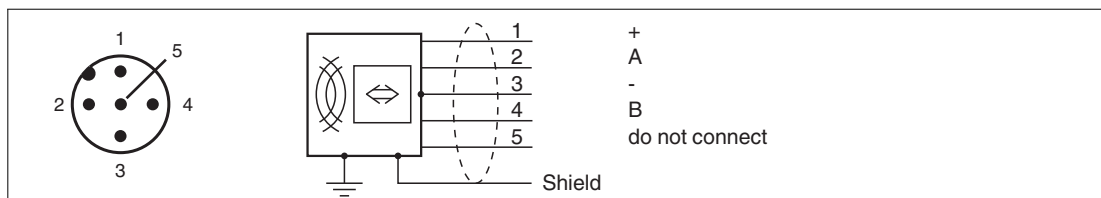
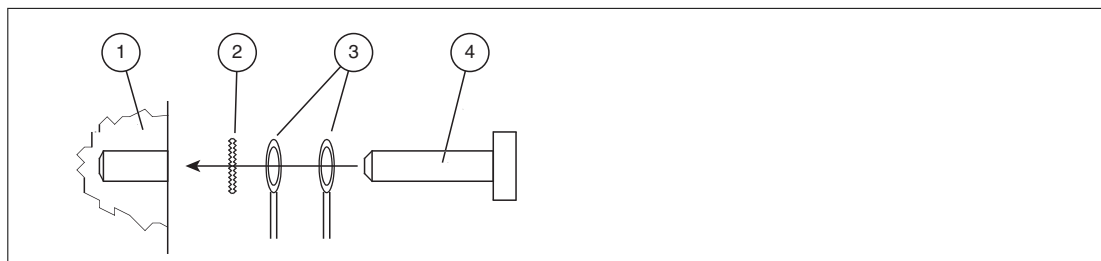

Figure 4.5

Ground connection

The ground connection of the read / write head is on the right side when the cable outlet faces downward. Connect the protective earth conductor to the casing with a crimp connector. To ensure proper grounding, you must install the lock washer between the crimp and the housing.



- 1 Housing
- 2 Serrated lock washer
- 3 Crimp connector
- 4 Lock screw



Use a conductor cross section of at least 4 mm² for the protective earth conductor.

Tighten the lock screw with a torque of 1.6 Nm ±0,4 Nm

4.7 Scope of Delivery

- Read/write head
- Quick start guide

4.8 Accessories

4.8.1 IDENTControl

The read/write head can be connected to Pepperl+Fuchs IDENTControl control interfaces.

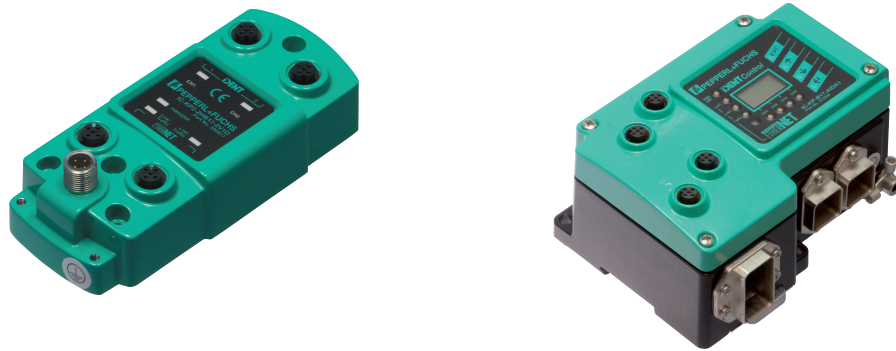

Interface	Designation
4 read/write heads:	
Ethernet	IC-KP-B17-AIDA1
2 read/write heads:	
PROFIBUS	IC-KP2-2HB6-V15B
Ethernet	IC-KP2-2HB17-2V1D
EtherCAT	IC-KP2-2HB21-2V1D
Serial	IC-KP2-2HRX-2V1
1 read/write head:	
PROFIBUS	IC-KP2-1HB6-V15B IC-KP2-1HB6-2V15B
Ethernet	IC-KP2-1HB17-2V1D
Serial	IC-KP2-1HRX-2V1

Table 4.1

4.8.2 Read/Write Tags

Type	Designation
EPC Gen 2 (ISO/IEC 18000-63)	IUC72-F152-M-FR1 IUC72-F152-M-FR2 IUC76-50-FR1 IUC76-50-FR2 IUC76-F157-M-FR1 IUC76-F157-M-FR2 IUC76-F203-M-FR1 IUC76-F203-M-FR2 IUC76-C8-T14-GBL IUC77-F151-M-GBL IUC77-25L100-GBL IUC77-25L110-GBL

Table 4.2

4.8.3 Connection cable for R/W heads and trigger sensors

Compatible connection cables with shielding are available for connecting the R/W heads and trigger sensors.

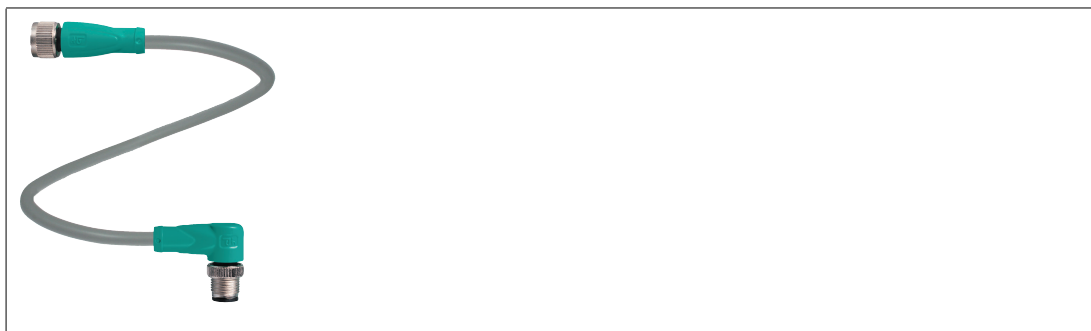

Figure 4.6

Accessories	Description
2 m long (straight female, angled male)	V1-G-2M-PUR-ABG-V1-W
5 m long (straight female, angled male)	V1-G-5M-PUR-ABG-V1-W
10 m long (straight female, angled male)	V1-G-10M-PUR-ABG-V1-W
20 m long (straight female, angled male)	V1-G-20M-PUR-ABG-V1-W
Field attachable female connector, straight, shielded	V1-G-ABG-PG9
Field attachable male connector, straight, shielded	V1S-G-ABG-PG9
Field attachable female connector, angled, shielded	V1-W-ABG-PG9
Field attachable male connector, angled, shielded	V1S-W-ABG-PG9
Dummy plug M12x1	VAZ-V1-B3



4.8.4 Cable connectors for the power supply

Compatible M12 sockets with an open cable end for connecting the IDENTControl to a power supply are available in different lengths.



Figure 4.7

Accessories	Designation
Length 2 m (straight socket)	V1-G-2M-PUR
Length 5 m (straight socket)	V1-G-5M-PUR
Length 10 m (straight socket)	V1-G-10M-PUR

4.8.5 Installation accessories

Two different mounting brackets are available to mount the read/write head on a wall or pole.



Figure 4.8 IUZ-MH10

Accessories	Designation
Mounting bracket for wall attachment	IUZ-MH10
Mounting bracket for pipe installation (pipe with maximum diameter of 40 mm)	IUZ-MH11

5 Installation

5.1 Storage and transport

For storage and transport purposes, package the unit using shockproof packaging material and protect it against moisture. The best method of protection is to package the unit using the original packaging. Furthermore, ensure that the ambient conditions are within allowable range.

5.2 Unpacking

Check the product for damage while unpacking. In the event of damage to the product, inform the post office or parcel service and notify the supplier.

Check the package contents against your purchase order and the shipping documents for:

- Delivery quantity
- Device type and version in accordance with the type label
- Any accessories ordered

Retain the original packaging in case you have to store or ship the device again at a later date.

Should you have any questions, please contact Pepperl+Fuchs.

5.3 Mounting

The read/write head is intended for wall mounting or mounting on brackets in internal areas. Please mount the read/write head using only the holes provided in the housing. The preferred mounting direction is with the cable connection facing vertically downwards.



Note!

Do not lay the connection cable in the main beam direction of the antenna.

To attach the read/write head, use four screws with a diameter of 6 mm, as well as mounting materials that are suitable for the type of mounting surface. The tightening torque of the screws depends on the type of mounting.



Caution!

Mounting the read/write head

Make sure that the read/write head is firmly attached to the mounting surface.



Mounting the Read/Write Head

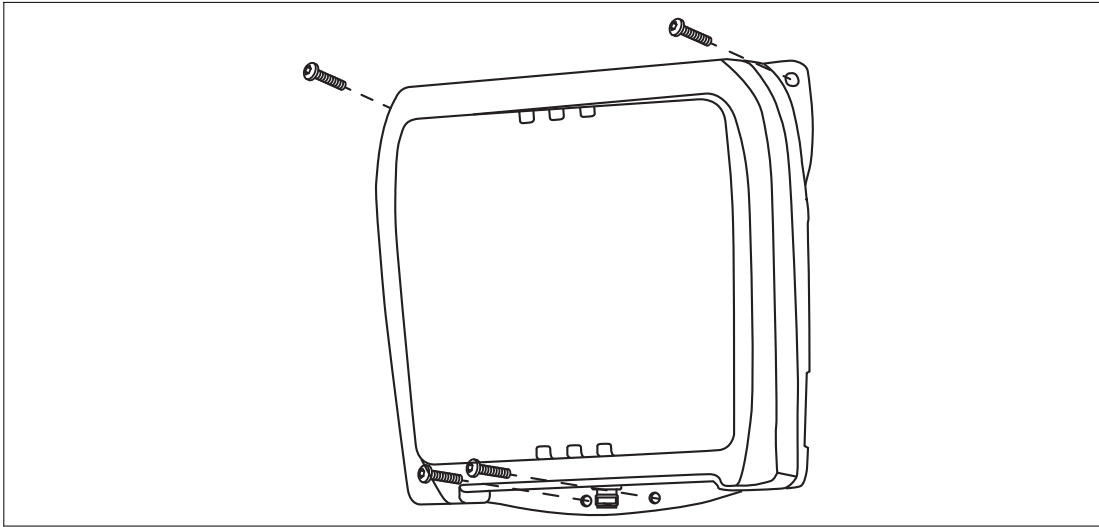
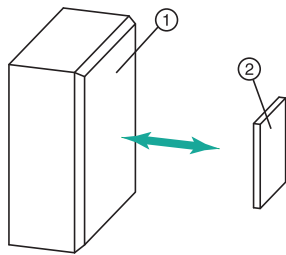

Figure 5.1

5.3.1 Room Orientation

The alignment of the read/write tag antennae in relation to the antennae of the read/write head influences the detection range of the system. Make sure the antennae are aligned parallel to each other.



Optimum alignment of the tag

- Good communication between the read/write head and tag

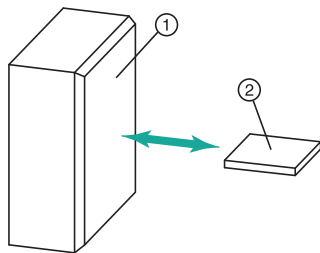

Poor alignment of the tag

- Insufficient communication between the read/write head and tag

- ① Read/write head
- ② Tag

5.3.2 Minimum Distances

When positioning the read/write head, please observe the minimum distances. The lateral distance between the read/write head and metals or liquids should be at least 50 cm. The distance between the read/write head and the ground should be at least 50 cm.

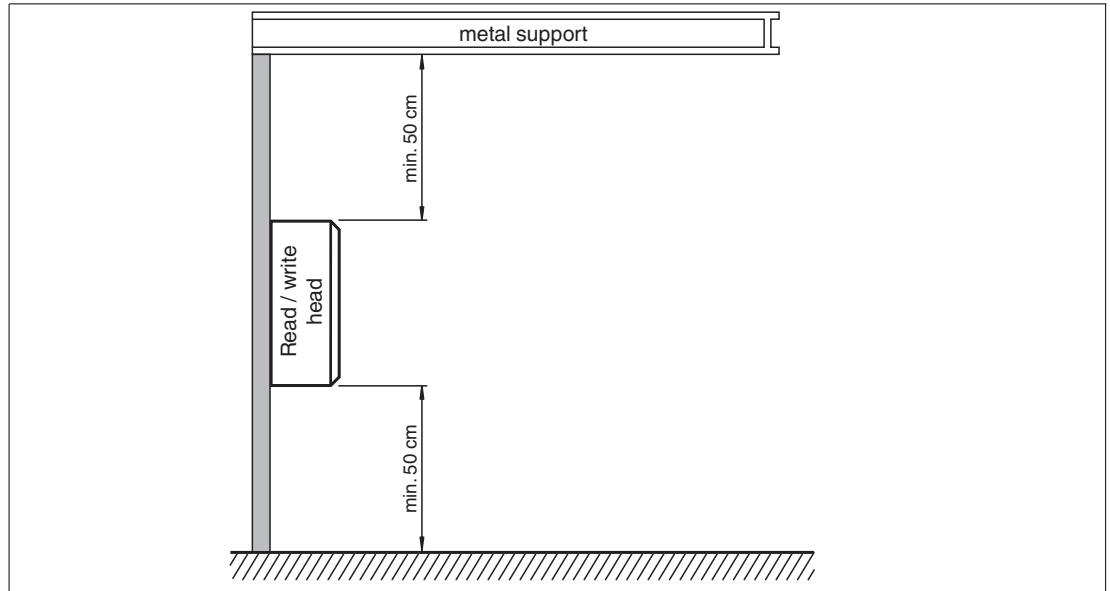

Figure 5.2

During simultaneous operation of several read/write heads, only one read/write head may ever communicate with a tag at any given time. When arranging the read/write heads, make sure that the measurement ranges do not overlap. You can enlarge or reduce the size of the measurement range by changing the transmitting power. Determine the measurement range of each read/write head at the mounting location.



Note!

During mounting, take into account how the read/write heads may cause interference with each other. The further the transmission channels of the read/write heads are from each other, the lower the risk of interference.

If you want to transmit with just one read/write head at any given time, use the multiplex mode of the IDENTControl control interface. Multiplex operating mode allows chronologically exclusive access to tags, and prevents mutual interference from read/write heads. For a precise description, see the manual for your control interface.

5.3.3 Polarization

The polarization of the electromagnetic wave emitted by an antenna depends on the electromagnetic field component and the position of the antenna. Polarization can be either linear or circular. To achieve the maximum detection range for a UHF system, the polarization of the read/write head must match the polarization of the tag. Refer to the relevant data sheet to find the polarization of the tag.

- **Linear polarization:** When an electromagnetic wave has linear polarization, the direction of the vector of the electromagnetic field component is constant. Linear polarization can be either vertical or horizontal. This characteristic depends on the position of the antenna.

- **Circular polarization:** When an electromagnetic wave has circular polarization, the vector of the electromagnetic field component rotates around an axis parallel to the direction of emission. The rotation of the antenna around the transmission axis has no effect.

The integrated antenna of the IUH-F192-V1-^{*} read/write head has dual linear polarization. The read/write head operates in combined mode by default. In combined mode, both horizontal and vertical polarization are used for each read/write access. This increases the reading reliability of tags with an unknown location in the room.

If the orientation of the tags is known, you can optimize the access time by setting a fixed polarization. To do this, you can switch the polarization to horizontally linear polarization or vertically linear polarization via the IDENTControl control interface software. The linear polarization plane refers to the preferred mounting direction with the cable connection mounted vertically downwards.



Figure 5.3 ① = Vertical polarization plane
 ② = Horizontal polarization plane

5.4 Connection

Connect the read/write head to the IDENTControl control interface using a shielded connection cable (see chapter 4.8.3). Ensure that the shield is end-to-end to avoid EMC interference. (see chapter 5.5)



Warning!

Incorrect electrical connection

Damage to the device or plant caused by incorrect electrical connection.

Check all connections in the plant before commissioning the device.

After connecting the supply voltage to the control interface, the POWER LED lights up green on the device. If the LED does not light up on the device, the power supply is not connected correctly.

5.5 EMC Concept

The outstanding noise immunity of the IDENTControl against emission and immission is based on its consistent shielding design, which uses the principle of the Faraday cage. Interference is caught in the shield and safely diverted via the ground connections.

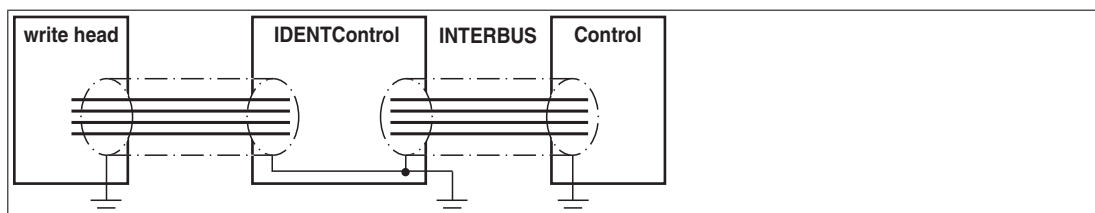

The cable shielding is used to discharge electromagnetic interference. When shielding a cable, you must connect both sides of the shield to ground with low resistance and low inductance.



Note!

If cables with double shields are used, e.g. wire mesh and metalized foil, the both shields must be connected together, with low resistance, at the ends when making up the cable.

Power supply cables are the source of much interference, e.g. from the supply lines of 3-phase electric motors. For this reason, the parallel laying of power supply cables with data and signal cables should be avoided, particularly in the same cable duct.



Note!

The circuit ground is conductively connected to the housing of the write/read head and to the protective ground. (Connection image → see Figure 4.5 on page 23)



6 Commissioning

6.1 Definitions

6.1.1 Display

Angle brackets contain the abbreviated meaning of a command structure, e.g., <Data>

The index _{hex} or .xx denotes a hexadecimal number.

hex_{ASCII} denotes a value in the hexadecimal system, specified in ASCII characters.

Example: 10_{dec} corresponds to A_{hex}; A_{ASCII} corresponds to 41_{hex}. see chapter 10.2

6.1.2 Legend

<ChanNo>:	IDENT <i>Control</i> channel
<CHCK>:	1 byte, 8-bit check sum with the addition of all preceding characters, without overflow
<Data>:	Data with the size <WordNum> multiplied by 4 bytes
<DataLength>:	Length of the data specified to a command, 2 characters binary, HighByte, LowByte
eirp:	equivalent isotropically radiated power
erp:	effective radiated power
<ETX>:	1 byte = 03 _{hex}
<read-only code>:	TID, 4 bytes + an optional 4 or 8 bytes
<Ldata>:	Length of the data in bytes, 2 bytes Use in multiframe protocol
<Length>	1 character hex _{ASCII} = number of data bytes Permitted values in the read/write head IUH*: 2, 4, 6, 8, A, C, E
<Luii>:	Length of the UII in bytes, 2 bytes Use in multiframe protocol
<LogicalOperation>:	Links several filters; OR = 0; AND = 1 If one filter only is used, this value is ignored
<MaskData>:	Mask specification
<MaskLength>:	Mask length in bits, values: 00...FF
<MemBank>:	Number of the memory bank (see parameter MB)
<ParamTyp>:	Parameter type, 2 bytes, or 2 ASCII characters
<Negate>:	Negates the mask comparison; not negated = 0; negated = 1
<PC>:	Protocol control word according to EPC Gen 2 (ISO/IEC 18000-63), 2 bytes, describes characteristics such as the length of the UI/EPC
<SpecialFixcode>:	<PC> & <UII/EPC>
<Status>:	1 ASCII character (see chapter 7.7)
<StartAddress>:	Start address in the selected memory bank in bits, values: 0000...FFFF
<SystemCode>:	= U (for read/write head IUH*)
<TagType>:	2 ASCII characters
<UII/EPC>:	Unique Item Identifier, memory area of a tag in accordance with EPC Gen 2 (ISO/IEC 18000-63), in which the EPC code is stored
<WordAddr>:	Word start address in the read/write tag, 4 hex _{ASCII} characters, range from "0000h" to "FFFF", depending on tag type
<WordNum>:	Number of words to be read or written, 2 hex _{ASCII} characters. Range from "01" through "20" depending on the tag type, word lengths are 4 bytes

6.2 Initial Commissioning



Note!

Transmission License

A country-specific transmission license is required to operate the read/write head. In the European Union and Turkey, the manufacturer's EU declaration of conformity constitutes an adequate license. A currently valid transmission license may not exist for all countries of use listed in this chapter, as transmission licenses are temporary in some countries. All currently valid transmission licenses can be found in the data sheet for the respective read/write head at www.pepperl-fuchs.com

All IUH-F192-V1-* read/write heads operate within their maximum frequency range from 865 MHz to 868 MHz, or from 902 MHz to 928 MHz, with the appropriate settings for the relevant country. This enables the following parameters to be set according to the applicable regulations for the relevant country:

- The maximum occupied bandwidth
- The channel bandwidth
- The channel plan used
- The frequency access method
- The maximum power setting



Note!

Country Identifier

The IUH-F192-V1-FR* read/write head has no valid country identifier by default. This status is indicated by the flashing green LED. In this state, the read/write head will accept only the command for setting the relevant country identifier. Once you have parameterized a valid country identifier, you can begin using the read/write head.

The IUH-F192-V1-FR2-02 is supplied ex-works with the country identifier "02" for the USA, Canada, and Mexico. Due to legal regulations, you cannot change this country identifier in the IUH-F192-V1-FR2-02.



Note!

The country identifier set is saved in the read/write head as non-volatile. The country identifier setting is not affected by a reset to the factory settings. It can be overwritten with another valid country identifier at any time.

Country identifiers for IUH-F192-V1-FR1

(The currently valid transmission licenses can be found in the data sheet at pepperl-fuchs.com)

Country Identifier	Occupied Frequency Bandwidth Frequency Access Method	Country or Region
01	865.6 MHz – 867.6 MHz Programmable frequency list	EU and other countries subject to EN 302208
04	865.0 MHz – 867.0 MHz Programmable frequency list	India
05	866.0 MHz – 868.0 MHz Programmable frequency list	Singapore, Vietnam
06	866.0 MHz – 867.6 MHz Programmable frequency list	Russia

Country identifiers for IUH-F192-V1-FR2

(The currently valid transmission licenses can be found in the data sheet at pepperl-fuchs.com)

Country Identifier	Occupied Frequency Bandwidth Frequency Access Method	Country or Region
02	902 MHz – 928 MHz Frequency hopping spread spectrum	USA Canada Mexico Argentina Colombia
03	920 MHz – 925 MHz Frequency hopping spread spectrum	China
07	915 MHz – 928 MHz Frequency hopping spread spectrum	Brazil
08	916.7 MHz – 920.5 MHz Programmable frequency list	Japan
09	917.2 MHz – 920.4 MHz Frequency hopping spread spectrum	South Korea
10	920 MHz – 926 MHz Frequency hopping spread spectrum	Australia
11	921.5 MHz – 928 MHz Frequency hopping spread spectrum	New Zealand
12	920 MHz – 925 MHz Frequency hopping spread spectrum	Hong Kong Thailand
13	919 MHz – 923 MHz Frequency hopping spread spectrum	Malaysia
14	920 MHz – 925 MHz Frequency hopping spread spectrum	Singapore Vietnam

For technical details regarding the regional settings, see chapter 4.3. For an example of reading and writing the country identifier, see chapter 6.3.

6.3 Device Settings



Warning!

Device not configured or configured incorrectly

Configure the device prior to commissioning. A device that has not been configured or configured incorrectly may lead to faults in the plant.

Before commissioning the read/write head, you need to configure the control interface. To do so, read the "Commissioning" chapter of the manual for your control interface.

Configure the read/write heads with the described system commands (). For a parameterization example, see see chapter 6.4.



Caution!

Uncontrolled triggered processes

Before commissioning the device, make sure that all processes are running smoothly; otherwise damage may occur in the plant.

6.4 Operation via the Command Interface

This section shows you how to operate the read/write head using an IDENTControl control interface with serial interface. The commissioning procedure described relates to the RS-232 interface and involves a PC. The examples include the syntax for coding the commands and parameters via the Ethernet TCP/IP and PROFIBUS/PROFINET interfaces. Further details about these codes and the factory settings for your IDENTControl control interface can be found in the manual.

Example:

In the examples below, the read/write head is connected to channel 1 of the control interface.

The outputs follow the multiframe protocol, see table "Responses Depending on Protocol Mode QV" on page 57.



Reading the Country Identifier

Read Parameter RC

Use the read parameter RC command to read out the read/write head's country identifier:

	Serial	Ethernet	PROFIBUS/PROFINET
Command:	RP1URC.00.00	.00.0A.BE.03.00.55.52.43.00.00	.BE.03.00.55.52.43.00.00
Confirmation:	-	.00.06.BE.03.FF.3E	.BE.03.FF.3E
Response:	.30.31.00.01	.00.0A.BE.03.00.3F.00.02.00.01	.BE.03.00.3F.00.02.00.01

Table 6.1 Read Parameter RC

The country identifier set on the read/write head is 01, where 01 corresponds to the country identifier for the European Union.

Writing the Country Identifier

Write Parameter RC

Use the write parameter RC command to change the country identifier on the read/write head to 04 (= India).

	Serial	Ethernet	PROFIBUS/PROFINET
Command:	WP1URC.00.02.00.04	.00.0C.BF.03.00.55.52.43.00.02.00.04	.BF.03.00.55.52.43.00.02.00.04
Confirmation:	-	.00.06.BF.03.FF.11	.BF.03.FF.11
Response:	.30.31	.00.06.BF.03.00.12	.BF.03.00.12

Table 6.2 Write Parameter RC

Reading Tags

Enhanced Read Read-Only Code

Send the enhanced read read-only code command to the read/write head. The "RF ON" LED on the read/write head lights up blue.

	Serial	Ethernet	PROFIBUS/PROFINET
Command:	EF1	.00.04.1D.03	.1D.03
Confirmation:	-	.00.06.1D.03.FF.0B	.1D.03.FF.0B
Response:	.35.31	.00.06.1D.03.05.0C	.1D.03.05.0C

Table 6.3 Enhanced read read-only code, no tag in the measurement range

Move a tag into the read/write head's measurement range. When the tag has been detected and the read-only code has been read out, the "READ / WRITE" LED on the read/write head lights up yellow. The read-only code is displayed in the terminal program.

	Serial	Ethernet	PROFIBUS/PROFINET
Response:	.30.31.00.0E.30.00.30.14.F7.33.7C.00.1F.00.00.00.00.01.00.08.E2.00.60.03.14.42.D6.D1	.00.20.1D.03.00.0D.00.0E.30.00.30.14.F7.33.7C.00.1F.00.00.00.01.00.08.E2.00.60.03.14.42.D6.D1	.1D.03.00.0D.00.0E.30.00.30.14.F7.33.7C.00.1F.00.00.00.01.00.08.E2.00.60.03.14.42.D6.D1

Table 6.4 Enhanced read read-only code, tag is entering the measurement range

Describing Tags

Single Write Special Read-Only Code

Send the single write special read-only code command to the read/write head while a tag is in the measurement range. See "Single Write Special Read-Only Code SP" on page 41 and see chapter 4.2.4.

	Serial	Ethernet	PROFIBUS/PROFINET
Command:	SP1E.30.00.30.14.F7.33.7C.00.1F.00.00.03.1C.6E	.00.14.0D.E3.00.00.30.00.30.14.F7.33.7C.00.1F.00.00.03.1C.6E	.0D.E3.00.00.30.00.30.14.F7.33.7C.00.1F.00.00.03.1C.6E

	Serial	Ethernet	PROFIBUS/PROFINET
Confirmation:	-	.00.06.0D.E3.FF.2D	.0D.E3.FF.2D
Response:	.30.31.00.0E.30. 00.30.14.F7.33.7 C.00.1F.00.00.03 .1C.6E .46.31.30.30.30.3 1	.00.16.0D.03.00.2E.00.0E. 30.00.30.14.F7.33.7C.00.1 F.00.00.03.1C.6E .00.0A.0D.03.0F.2F.30.30. 30.31	0D.03.00.2E.00.0E.30.00. 30.14.F7.33.7C.00.1F.00.0 0.03.1C.6E .0D.03.0F.2F.30.30.30.31

Single Read Special Read-Only Code

As confirmation, read out the read-only code of the tag within the read/write head's measurement range via the single read special read-only code command. See "Single Read Special Read-Only Code SS" on page 40.

	Serial	Ethernet	PROFIBUS/PROFINET
Command:	SS10	.00.04.0A.02	.0A.02
Confirmation:	-	.00.06.0A.02.FF.30	.0A.02.FF.30
Response:	.30.31.00.0E.30. 00.30.14.F7.33.7 C.00.1F.00.00.03 .1C.6E .46.31.30.30.30.3 1	.00.16.0A.02.00.31.00.0E. 30.00.30.14.F7.33.7C.00.1 F.00.00.03.1C.6E .00.0A.0A.02.0F.32.30.30. 30.31	.0A.02.00.31.00.0E.30.00. 30.14.F7.33.7C.00.1F.00.0 0.03.1C.6E .0A.02.0F.32.30.30.30.31



Parameterizing the Read/Write Head

Requesting and Setting the Transmission Power

Read out the read/write head's transmission power with the read parameter PT command:

	Serial	Ethernet	PROFIBUS/PROFINET
Command:	RP1UPT.00.00	.00.0A.BE.03.00.55.50.54. 00.00	.BE.03.00.55.50.54.00.00
Confirmation:	-	.00.06.BE.03.FF.33	.BE.03.FF.33
Response:	.30.31.00.32	.00.0A.BE.03.00.34.00.02. 00.32	.BE.03.00.34.00.02.00.32

The read/write head's set transmitting power is 50 mW (32_{hex} corresponding to 50_{dec}).

Change the transmitting power of the read/write head to 100 mW (100_{dec} corresponding to 64_{hex}) via the write parameter PT command:

	Serial	Ethernet	PROFIBUS/PROFINET
Command:	WP1UPT.00.02.0 0.64	.00.0C.BF.03.00.55.50.54. 00.02.00.64	.BF.03.00.55.50.54.04.00. 02.00.64
Confirmation:	-	.00.06.BF.03.FF.35	.BF.03.FF.35
Response:	.30.31	.00.06.BF.03.00.36	.BF.03.00.36

7 Operation

7.1 General

The sections below contain information about the commands that relate to your read/write head. The commands are described using the example of an IDENTControl control interface with serial interface. All other generally applicable commands and error messages or status messages can be found in the manual for your IDENTControl control interface.

7.2 Basic Command Process

Interference Due to Multipath Propagation

The electromagnetic waves radiated by the read/write head do not just follow the direct route to the tag, but are also reflected off objects in the vicinity, meaning that multiple partial waves overlap with the waves radiated by the read/write head.

This overlap causes interference (i.e., exaggeration and dampening of the reception field strength), leading to almost complete degradation. Depending on the environment, several reflections may occur with differing intensity and distance. These different reflections lead to a field strength in the measurement range that is difficult to predict. In the areas of degradation, the prevailing field strength is weaker than the minimum detection field strength of the tag. As a result, the tag cannot be activated for communication. Exaggeration of the field strength may lead to unwanted excessive detection ranges.

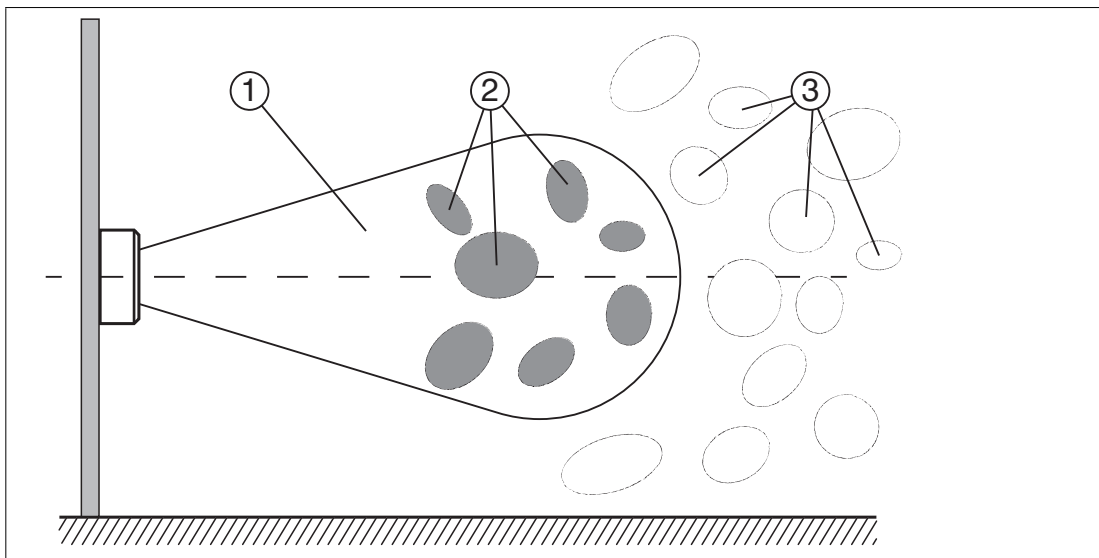

1. Measurement Range
2. Degradation
3. Excessive detection ranges

The reflections and the resulting inhomogeneity of the field strength depend on the frequency used. The absolute value of the field strength depends on the transmission power. Since the tags move in the measurement range of the read/write head, and the environment can change, it is advisable to repeat the commands at different transmission frequencies and at varying power. Different transmission frequencies are advisable, since the manufacturing tolerances and the immediate environment of the tag have an effect the tag's resonance frequency.

Several Tags in the Measurement Range

Each read or write command can access one, several, or all tags in a measurement range. The process is controlled by filter masks, which are managed via the commands Set Filter Mask (FI) and Activate/Deactivate Filter (MF). These commands allow you to detect specific tags in the measurement range. see chapter 7.5.

Read Algorithm

To communicate with tags with the maximum possible probability, the read/write head uses an algorithm that varies the transmitting power and frequency. You can set the corresponding values for this algorithm via the parameters Power Transmit (**PT**), Channel Frequency (**CD**), or Number of Channels (**NC**) for the frequency hopping spread spectrum, and Number of Attempts (**TA**). The number of set attempts is executed for each pairing of power and frequency. This process takes a long time, but leads to a high read/write rate. The algorithm runs through all combinations because it may be the case that a tag can be detected only by one specific combination of power and frequency. This applies when the read/write head uses a programmable frequency list as the frequency access method. This frequency list is defined by parameter **CD**.

If the country identifier (**RC**) specifies a frequency hopping spread spectrum, the channels defined there are used. This is not influenced by the programmable frequency list. You can adjust the number of channels used for each attempt via the Number of Channels parameter (**NC**).

With the parameter Search Algorithm Cancellation Criteria (**NT**), you can specify the number of tags to be processed. If you know the number of tags in the measurement range, you can use this total number as the value for parameter **NT**. If the number of tags found corresponds to or exceeds the value defined in parameter **NT**, the algorithm cancels any further runs to save time.



Tip

If analysis of a specific application shows that a particular frequency and transmission power are sufficient to execute commands successfully, the parameters can be set accordingly, subject to national legislation. This measure reduces the processing time.

7.3 Command Overview

The commands in the list are described in detail on the following pages.

Read/Write Commands

Abbreviation	Command description
SF	See "Single Read Read-Only Code SF" on page 40
EF	See "Enhanced Read Read-Only Code EF" on page 40
SS	See "Single Read Special Read-Only Code SS" on page 40
ES	See "Enhanced Read Special Read-Only Code ES" on page 41
SP	See "Single Write Special Read-Only Code SP" on page 41
SR, #SR	See "Single Read Words SR" on page 42
ER, #ER	See "Enhanced Read Words ER" on page 42
SW, #SW	See "Single Write Words SW" on page 43
EW, #EW	See "Enhanced Write Words EW" on page 43
KI	See "Kill UHF Tag KI" on page 44

Filter Commands

Abbreviation	Command description
FI	See "Set Filter Mask FI" on page 44
MF	See "Activate/Deactivate Filter MF" on page 46

Configuration Commands

Abbreviation	Command description
RP	See "Read Parameters" on page 50
WP	See "Write Parameters" on page 50

7.4 Read/Write Commands

The tag's memory structure is based on the following read/write commands in accordance with EPC Gen 2 (ISO/IEC 18000-63). See chapter 4.2.3.

Single Read Read-Only Code SF

One attempt is made to read a read-only code (TID). The read-only code is 4, 8, or 12 bytes long, and comprises a 4-byte part number, which denotes the tag type, and optionally a tag with a unique serial number of 4 or 8 bytes. Details see chapter 4.2.3.

Command: SF <ChanNo> <CHCK> <ETX>
 Response: <Status> <ChanNo> <Luii> <Ull> <Length> <Fixcode> <CHCK> <ETX>
 F <ChanNo> 0001 <CHCK> <ETX>

<Length> = Length of the <Fixcode> in ASCII_{hex}

Example:

SF1 reads the read-only code to IDENTControl channel 1.

Enhanced Read Read-Only Code EF

This command continuously attempts to read a read-only code (TID). If a read-only code is read, this is reported once to the control interface. If there is no tag in the measurement range, or if the tag leaves the measurement range, a status 5 message is reported to the control interface.

Command: EF <ChanNo> <CHCK> <ETX>
 Response: <Status> <ChanNo> <Luii> <Ull> <Length> <Fixcode> <CHCK> <ETX>

<Length> = Length of the <Fixcode> in ASCII_{hex}

Example:

EF1 continuously reads the read-only code to IDENTControl channel 1

Single Read Special Read-Only Code SS

This command reads the Ull segment from tags according to EPC Gen2 (ISO/IEC 18000-63).

Command: SS <ChanNo> 0 <CHCK> <ETX>
 Response: <Status> <ChanNo> <Length> <SpecialFixcode> <CHCK> <ETX>
 F <ChanNo> 0001 <CHCK> <ETX>

Example:

SS10 reads the entire Ull segment.

The tag type determines the maximum length of the Ull/EPC. The actual length of the Ull/EPC is defined via the protocol control word <PC>. The data is structured as follows:

<Length> = Length of the <SpecialFixcode> in ASCII_{hex}

<SpecialFixcode> = <PC> & <Ull/EPC>

<PC> corresponds to the protocol control word in accordance with EPC Gen 2 (ISO/IEC 18000-63), 2 bytes long.

<Ull/EPC> contains the usage data.



Note!

Ull/EPC

If there are multiple tags in the measurement range with the same Ull/EPC, the identical tags are reported with Status A.

Enhanced Read Special Read-Only Code ES

This command continuously attempts to read the Ull segment from tags according to EPC Gen2 (ISO/IEC 18000-63). If the <SpecialFixcode> of a tag is read, this is reported once to the control interface. If there is no tag in the measurement range, or if the tag leaves the measurement range, a status 5 is reported to the control interface.

Command: ES <ChanNo> 0 <CHCK> <ETX>

Response: <Status> <ChanNo> <Length> <SpecialFixcode> <CHCK> <ETX>

Example:

ES10 continuously reads the Ull segment.

The tag type determines the maximum length of the Ull/EPC. The actual length of the Ull/EPC is defined via the protocol control word <PC>. The data is structured as follows:

<Length> = Length of the <SpecialFixcode> in ASCII_{hex}

<SpecialFixcode> = <PC> & <Ull/EPC>

<PC> corresponds to the protocol control word in accordance with EPC Gen 2 (ISO/IEC 18000-63), 2 bytes long.

<Ull/EPC> contains the usage data.



Note!

Ull/EPC

If there are multiple tags in the measurement range with the same Ull/EPC, the identical tags are reported with Status A.

Single Write Special Read-Only Code SP

This command writes a <Length> octet long Ull/EPC code to tags according to EPC Gen 2 (ISO/IEC 18000-63).

Command: SP <ChanNo> <Length> <SpecialFixcode> <CHCK> <ETX>

Response: <Status> <ChanNo> <NUL> <Length> <SpecialFixcode> <CHCK> <ETX> F
<ChanNo> 0001 <CHCK> <ETX>

The data length <Length> must be a whole number multiple of 2 octets because in accordance with EPC Gen 2 (ISO/IEC 18000-63), <Ull/EPC> must be written in 16-bit words. Only the lengths 2_{dec}, 4_{dec}, ... 14_{dec} (= 2_{ASCII}, 4_{ASCII}, ..., E_{ASCII}) are permissible. The length is shown in hexadecimal format, and includes the length of PC and Ull/EPC. If a Ull/EPC of 96 bits is written, this results in 2 + 12 = 14 octets = E_{ASCII} octet.

<Length> = Length of the <SpecialFixcode> in ASCII_{hex}

<SpecialFixcode> = <PC> & <Ull/EPC>



<PC> corresponds to the protocol control word in accordance with EPC Gen 2 (ISO/IEC 18000-63), 2 octets long.

<UII/EPC> contains the usage data.

Example:

SP1E.30.00.30.14.F7.33.7C.00.1F.00.00.03.1C.6E writes the value ".30.00" for <PC>, and the UII/EPC code ".30.14.F7.33.7C.00.1F.00.00.03.1C.6E" with a length of 2 + 12 octets = 14 octets to IDENTControl channel 1.

When using this command, make sure that the protocol control word contains the correct length of the following UII/EPC. If this is not executed correctly, the complete data is not output on the subsequent read operation because the command SS uses the length in the protocol control word for the output.

In accordance with EPC Gen 2 (ISO/IEC 18000-63), the protocol control word consists of two octets. The five highest value bits denote the length of the <UII/EPC> in words (= 16 bit):

00000 _{bin}	No word	0 bits
00001 _{bin}	One word	16 bits
00010 _{bin}	Two words	32 bits
...
11111 _{bin}	31 words	496 bits

The meaning of the remaining bits is described in EPC Gen 2 (ISO/IEC 18000-63). If a UII/EPC has the length 12 octets, i.e., 6 words (00110_{bin}), and all other bits are equal to 0, the protocol control word corresponds to 00110000 00000000_{bin} or 3000_{hex}. If some of the other bits are not equal to 0, this produces a different protocol control word.



Note!

Several Tags in the Measurement Range

If there is more than one tag in the measurement range when this command is run, the UII is written to the first tag only. Status A is output for all other tags.

Single Read Words SR

One attempt is made to read <WordNum> 32-bit words from address <WordAddr>.

Command: SR <ChanNo> <WordAddr> <WordNum> <CHCK> <ETX>
 Response: <Status><ChanNo><Luii><UII><Ldata><Data><CHCK> <ETX>
 F <ChanNo> 0001<CHCK> <ETX>

Example:

SR1000101 reads a 4-byte word from memory address "0001."



Note!

The memory bank (MB) parameter defines the bank accessed by this command. see "Memory Module for Tag Accesses to the "Memory Bank" MB" on page 53.

Enhanced Read Words ER

Continuous attempts are made to read <WordNum> 32-bit words from the address <WordAddr>. Only changing data is transferred via the interface. When a read/write tag leaves the read range, status 5 is output.

Command: ER <ChanNo> <WordAddr> <WordNum> <CHCK> <ETX>
 Response: <Status><ChanNo><Luii><UII><Ldata><Data><CHCK> <ETX>

Example:

ER1000101 continuously reads a 4-byte word from memory address "0001".



Note!

The memory bank (**MB**) parameter defines the bank accessed by this command. see "Memory Module for Tag Accesses to the "Memory Bank" MB" on page 53.

Single Write Words SW

One attempt is made to write <WordNum> 32-bit words from the address <WordAddr>.

Command: SW <ChanNo> <WordAddr> <WordNum> <Data> <CHCK> <ETX>
 Response: <Status> <ChanNo> <Luii> <UII> <CHCK> <ETX>
 F <ChanNo> 0001 <CHCK> <ETX>

Example:

SW1000101ABCD writes the 4-byte-long word "ABCD" from memory address "0001".



Note!

The memory bank (**MB**) parameter defines the bank accessed by this command. see "Memory Module for Tag Accesses to the "Memory Bank" MB" on page 53.



Note!

When writing to the UII/EPC area (MB = 1), note that it is not possible to write to the CRC. The first writable address is 0x0001. The protocol control word <PC> begins at this address. Use the command #SW.

Enhanced Write Words EW

This command continuously attempts to write <WordNum> 32-bit words from the address <WordAddr>. If the command was executed successfully, a status 0 is reported to the control interface. If there is no tag in the measurement range, or if the tag leaves the measurement range, a status 5 is reported to the control interface.

Command: EW <ChanNo> <WordAddr> <WordNum> <Data> <CHCK> <ETX>
 Response: <Status> <ChanNo> <Luii> <UII><CHCK> <ETX>

Example:

EW1000101ABCD continuously writes the 4-byte long word "ABCD" from memory address "0001".



Note!

The memory bank (**MB**) parameter defines the bank accessed by this command. see "Memory Module for Tag Accesses to the "Memory Bank" MB" on page 53.



Note!

16-Bit Read/Write Commands

The read/write commands SR, ER, SW, and EW are interpreted as 16-bit versions by means of a preceding # symbol.

The 16-bit read/write commands behave in the same way as the 32-bit versions.

- 16-bit commands write or read a word with a length of 2 bytes.
- 32-bit commands write or read a word with a length of 4 bytes.

Example:

#SW1000202ABCD corresponds to SW1000101ABCD

Kill UHF Tag KI

This command sets a UHF tag to a state where no further access is possible. The command can be executed only if a valid password has previously been set in segment Bank 00 via the command SW. See chapter 4.2.3. The password must have at least 1 non-zero bit.

Command: KI <ChanNo>.30.30 <UllLength>< UllData> <PassWord> <RecomBits>
 <CHCK> <ETX>

Response: <Status> <ChanNo> <Luii> <Ull> <CHCK> <ETX>
 F <ChanNo> 0001 <CHCK> <ETX>

<UllLength> = Mask length for the Ull/EPC in bits, values: 00 ... FF, always begins at Address 0. The information is entered as 2 hex_{ASCII} characters.

<UllData> = Specification of the mask for the Ull, in octets

<PassWord> = Password for killing a UHF tag, 4 octets

<RecomBits> = Recommission bits, always set to zero

Example:

KI10018.E2.00.90abcd.00 kills a UHF tag with a Ull starting ".E2.00.90" and using the password "abcd."

7.5 Filter Commands

Each read or write command can access one, several, or all tags in a measurement range. The process is controlled by filter masks, which are managed via the commands Set Filter Mask (FI) and Activate/Deactivate Filter (MF). These commands allow you to detect specific tags in the measurement range. see chapter 7.5.

Set Filter Mask FI

Using command FI, you can define a filter mask for accessing the tags located in the box. You can define up to 3 filters (0-2). The following syntax is used:

Command: FI <ChanNo> <FilterNumber> <MemBank> <Negate> <LogicalOperation>
 0 <StartAddress> <MaskLength> <MaskData> <CHCK> <ETX>

Response: <Status> <ChanNo> <CHCK> <ETX>

<MemBank> = Memory segment to which the filter is to be applied. The information is entered as one hex_{ASCII} character.

<StartAddress> = Address of the bit at which the filter mask begins. Specified in hex_{ASCII}. Values: 0000 ... FFFF

<MaskLength> = Length of the mask in bits. The information is entered as 2 hex_{ASCII} characters.

<MaskData> = Defines the actual filter mask

Example:

There are three tags in the measurement range of the read/write head. Each tag has a unique identifier of <PC> & <UII/EPC>:

	<PC> & <UII/EPC>
1st Tag	.34.00.E2.00.92.01.20.51.70.00.00.00.02.76
2nd Tag	.34.00.E2.00.92.01.20.51.70.00.00.00.02.66
3rd Tag	.34.00.E2.00.90.51.33.02.00.92.18.20.56.15

If you want to detect the 3rd tag, the filter mask is: **F1101000001028.34.00.E2.00.90**

Meaning of Bits

Command	FI	= Command
<ChanNo>	1	= Channel 1
<FilterNumber>	0	= First filter used, filter number = 0
<MemBank>	1	= Memory bank 01; should be filtered to UII/EPC
<Negate>	0	= Not negated
<LogicalOperation>	0	= OR link not relevant here because only one filter is set
0	0	= Value is always 0
<StartAddress>	0010	= Start address 10 _{hex} or bit 16
<MaskLength>	28	= Mask length, 28 _{hex} = 40 _{dec} , i.e., 40 bits
<MaskData>	34.00.E2.00.90	= Actual Mask

Owing to the structure of the memory bank for UII/EPC (→ see image on page 12), the start address is located at bit 16. The CRC-16 value occupies the memory position from bit 0 through bit 15; the PC starts at bit 16.

If you activate the filter with the command MF, and then execute command SS10, you receive only one response from the corresponding tag even if other tags are located in the measurement range:

.34.00.E2.00.90.51.33.02.00.92.18.20.56.15

The value <Negate> controls the mask comparison. 0 = not negated, 1 = negated. If you negate the filtering by setting the value <Negate> in the command F1101000001028.34.00.E2.00.90, you receive a response from the tags that does not match the filter:

.34.00.E2.00.92.01.20.51.70.00.00.00.02.76

.34.00.E2.00.92.01.20.51.70.00.00.00.02.66

If you prefer to filter only at the start of <UII/EPC>, and ignore the <PC>, send the command F110100000**2018**.E2.00.90. The start address is 20_{hex}, the mask length has 24 bits, and the mask is .E2.00.90.

The value <LogicalOperation> logically links several filters with each other and is evaluated only if more than one filter is used. If only one filter is used, this value is ignored. 0 = OR, 1 = AND

Other examples include:

F110200000018.**E2.00.10** sets filter 0 so that all tags with a TID beginning with .E2.00.10 are detected.



FI111100002008.22 sets filter 1 so that all tags whose UII/EPC do not begin .22 are detected.

FI1010100010700.00123456789012 sets filter 0 so that the tag with the SpecialFixcode (PC+UII/EPC) 0.00123456789012 is detected.

The letter x can be used as a wildcard for the channel and filter number. Command Flxx000000000 resets the three filters for all IDENTControl channels.

Activate/Deactivate Filter MF

Command MF activates or deactivates the filter masks.

Command: MF<ChanNo><Value><CHCK><ETX>

Response: <Status><ChanNo><CHCK><ETX>

The following values are possible:

0 = Deactivate filter masks

1 = Activate filter masks - mode 1

2 = Activate filter masks - mode 2

Example:

MF11 activates the filter masks for IDENTControl channel 1

Command MF - Mode 1

In total, there are 15 tags in the measurement range of the read/write head, with three groups of five marked as either A, B, or C. The filter is now set to "B" by the command FI.

If you execute command MF11 (Activate Filter - Mode 1), this command affects all subsequent commands.

If a write command is executed next, all "B" tags in the measurement range are selected and are assigned a 'Selected' flag. The write command is executed only for tags with a Selected flag.

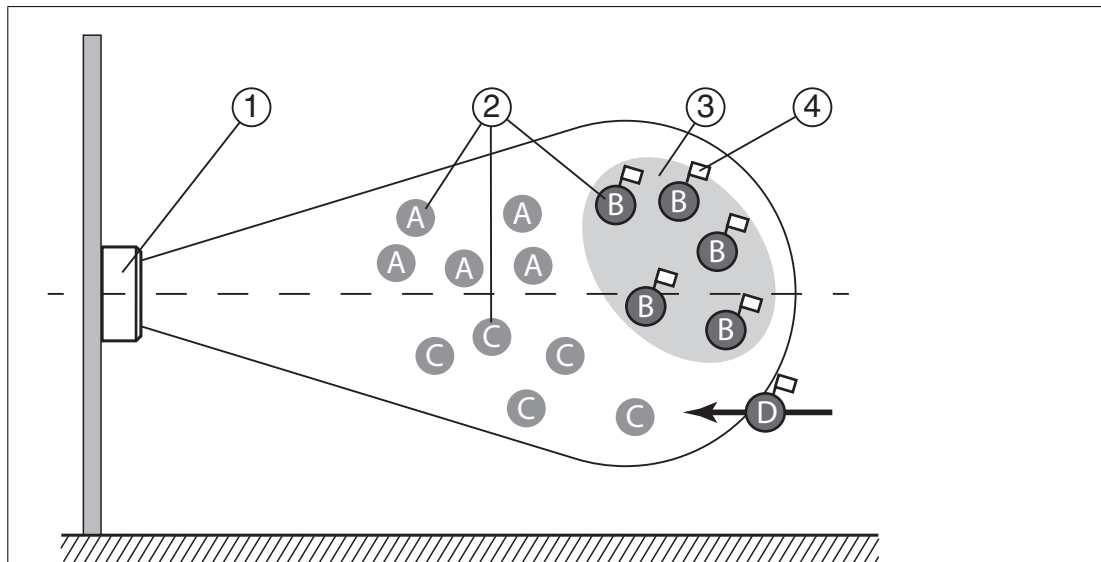

When the filter is set to "B", command MF11 (Filter Activated - Mode 1) selects all "B" tags; the following commands address the selected "B" tags.

- ① Read/write head
- ② Tags "A", "B", "C"
- ③ Filter mask
- ④ Selected flag

Command MF - Mode 2

In total, there are 15 tags in the measurement range of the read/write head, with three groups of five marked as either A, B, or C. The filter is set to "B" by command FI.

If you execute command MF12 (Activate Filter - Mode 2), this command affects all subsequent commands.

If a write command is executed next, all tags in the measurement range that are not "B" tags are selected. These tags are assigned a 'Selected' flag. The write command is executed only for tags with no Selected flag.

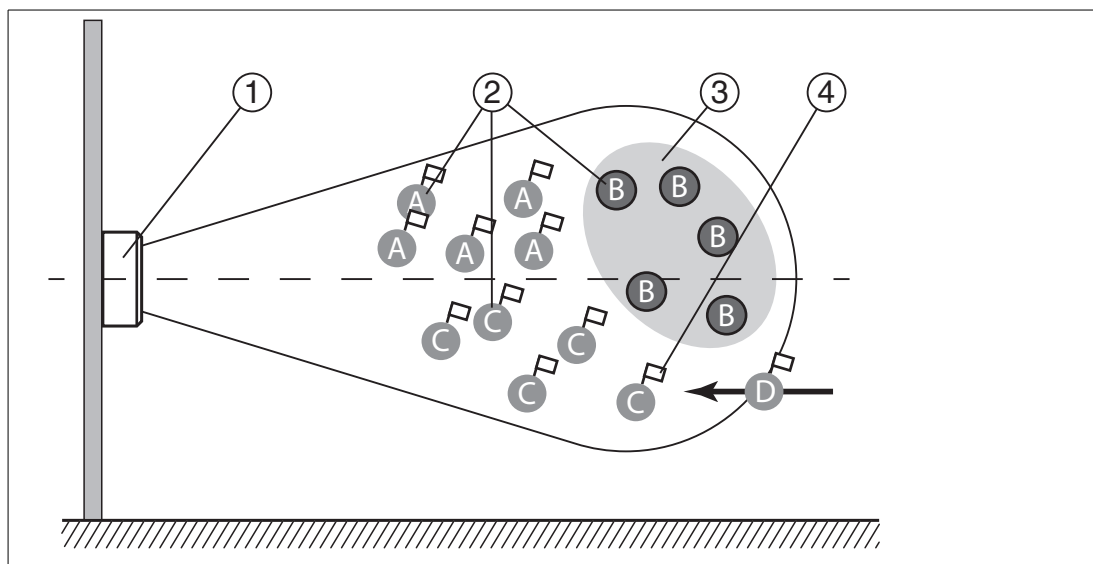

When the filter is set to "B," command MF12 (Filter Activated - Mode 2) selects all "A" and "C" tags, and the following commands address the **unselected** "B" tags.

- ① Read/write head
- ② Tags "A", "B", "C"
- ③ Filter mask inverted
Selected flag

Difference Between Command MF - Mode 1 and Command MF - Mode 2

In both cases, the subsequent commands are applied only to the "B" tags in the measurement range.

With MF11, "B" tags are assigned a Selected flag. With MF12, "B" tags are not assigned a Selected flag.

If a "D" tag with a Selected flag from the operation of a different read/write head enters the measurement range, this "D" tag will execute the subsequent commands if MF11 is activated. If MF12 is activated, this "D" tag will not execute the subsequent commands.

7.6 Configuration Commands

The response to a configuration command is a status message from the read/write head. During the read operation, a status message and the corresponding data are received as the response.

7.6.1 ChangeTag Command

This command tells the R/W system with which tag type to communicate.

Command: CT <ChanNo> <TagType> <CHCK> <ETX>

Response: <Status> <ChanNo> <CHCK> <ETX>

Default: 80

4

Example:

CT180 sets the tag type for IDENTControl channel 1 to IUC80

CT180 sets a generally valid tag type, which allows the read-only code to be read out for each tag, and therefore provides information about the chip type of the tag.



Note!

The read/write head uses only tag type 80.

Tag Types, UHF

Tag type	Chip		Pepperl+Fuchs designation	Bank 00 [bit]	Ull/EPC [bit]	TID		User data [octet]
	Type	Designation				Type	Unique?	
72	EPC Class 1 Gen 2	NXP UCode-EPC-G2XM	IUC72	32 + 32	240	E2006003 _{hex} + seq. no.	Yes	64
76	EPC Class 1 Gen 2	Alien Higgs-3	IUC76	32 + 32	96 – 480 ²⁾	E2003412 _{hex} + seq. no.	Yes	8 – 64 ²⁾
77	EPC Class 1 Gen 2	Impinj Monza 4QT	IUC77	32 + 32	128	E2801105 _{hex} + seq. no.	Yes	64
78	EPC Class 1 Gen 2	Impinj Monza 5	IUC78	32 + 32	128	E2801130 _{hex} + seq. no.	Yes	4
79	EPC Class 1 Gen 2	NXP UCode G2iM	IUC79	32 + 32	256	E2800680A _{hex} + seq. no.	Yes	64
80	EPC Class 1 Gen 2	Read/write tag conforms with Class 1 Gen 2	IUC80	1)	1)	E2xxxxxx _{hex} + seq. no.	1)	1)

Table 7.1 Tag types

1) = depending on the tag type

2) = EPC expandable to max. 480 bits. If a 480 bit EPC format is used, the user data is reduced from 64 octets to 8 octets.

7.6.2 Read and Write Parameters

With the read parameter (**RP**) and write parameter (**WP**) configuration commands, you can read/write the following parameters:

Abbreviation	Page	Parameter IUH-F192-V1-FR*
AP	See "Antenna Polarization AP" on page 51	Readable/writeable
CD	See "CD Transmission Channels" on page 51	Readable/writeable for RC = 1, 4, 5, 6, 8 Readable for RC = 2, 3, 7, 9, 10, 11, 12, 13, 14
E5	See "Number of Unsuccessful Attempts until Status 5 "Enhanced Status 5" E5" on page 51	Readable/writeable
FL	See "Read Out Filter Mask "Filter List" FL" on page 52	Readable
IF	See "Output Additional Information, "Information" IF" on page 52	Readable/writeable
MB	See "Memory Module for Tag Accesses to the "Memory Bank" MB" on page 53	Readable/writeable
MD	See "Retrieve Additional Information MD" on page 53	Readable
MF	See "Measurement of Reflected Transmitting Power "Measure Reflection" MF" on page 54	Readable
NC	See "Number of Channels NC" on page 54	Readable/writeable for RC = 2, 3, 7, 9, 10, 11, 12, 13, 14 Readable for RC = 1, 4, 5, 6, 8
NT	See "Search Algorithm Cancellation Criteria "number of tags to find" NT" on page 55	Readable/writeable
PT	See "Transmission Power "Power Transmit" PT" on page 55	Readable/writeable
QV	See "Protocol Mode QV" on page 56	Readable/writeable
QW	See "Q Value QW" on page 57	Readable/writeable
RC	See "Country Identifier, "Region Code" RC" on page 58	Readable/writeable ¹
RD	See "Reset to Default, RD" on page 58	Writeable
SM	See "Transmission Pauses in "Sensing Mode" SM" on page 59	Readable/writeable
TA	See "Number of Attempts "Tries Allowed" TA" on page 59	Readable/writeable

1. Readable only for IUH-F192-V1-FR2-02

The parameters are saved in the read/write head as nonvolatile.



Read Parameters

The RP command reads configuration parameters from the read/write head.

Command: RP <ChanNo> <SystemCode> <ParamTyp> <DataLength> <Data>
 <CHCK> <ETX>

Response: <Status> <ChanNo> <Data> <CHCK> <ETX>

<SystemCode> = U_{ASCII} for IUH-*

<ParamTyp> = 2 bytes ASCII

<DataLength> = Length of <Data> in command, 2 bytes binary

<Data> = Optional additional information

Example:

RP1UE5.00.00 outputs the number of unsuccessful read attempts until status 5.

Write Parameters

Command WP writes configuration parameters to the read/write head.

Command: WP <ChanNo> <SystemCode> <ParamTyp> <DataLength> <Data>
 <CHCK> <ETX>

Response: <Status> <ChanNo> <CHCK> <ETX>

<SystemCode> = U_{ASCII} for IUH-*

<ParamTyp> = 2 bytes ASCII

<DataLength> = Length of <Data>, 2 bytes binary

<Data> = Optional additional information

Example:

WP1UE5.00.01.05 sets the number of unsuccessful read attempts to status 5 on 5 attempts.

7.6.3 Parameters

Antenna Polarization AP

This parameter switches polarization to horizontally linear, vertically linear, or combined mode, or reads out the polarization currently set.

ParamTyp:	AP
Default:	AP = C
Value range:	C = combined ¹ H = Horizontally linear V = Vertically linear

1. Combined horizontally linear and vertically linear for each read/write attempt

Example:

WP1UAP.00.01H switches the polarization to horizontally linear
 WP1UAP.00.01C switches the polarization to combined mode
 RP1UAP.00.00 reads out the set polarization

Set the polarization to combined mode if the tag's orientation is not known. In combined mode, horizontal polarization and then vertical polarization is used for each read/write attempt. This achieves the same results as when circular polarization is used. The duration of the read/write operation is extended in combined mode.

CD Transmission Channels

Programmable frequency list frequency access method:

This parameter sets the number and sequence of transmission channels or reads out the number and sequence of transmission channels.

Frequency hopping spread spectrum frequency access method:

This parameter reads out the number and sequence of transmission channels for the frequency hopping spread spectrum.

ParamTyp:	CD
Default:	Depends on the country identifier set, see chapter 4.3.
Value range:	Depends on the country identifier set, see chapter 4.3.

Example:

WP1UCD.00.04.07.0A.04.0D defines the sequence 7, 10, 4, and 13 as the permitted transmission channels
 WP1UCD.00.01.0A allows the read/write head to use only transmission channel 10
 RP1UCD.00.00 reads out the sequence of permitted transmission channels



Tip

If you have parameterized several transmission channels with the parameter CD, the read/write head executes each write or read command on all defined transmission channels sequentially according to the defined sequence. If several additional transmission power values are parameterized (), all set transmission powers are executed on each transmission channel for each read or write command. See chapter 7.2.

Number of Unsuccessful Attempts until Status 5 "Enhanced Status 5" E5

This parameter sets the number of unsuccessful read/write attempts until a status 5 is output for an enhanced command, or outputs the number.

Status 0 and status A depend on this parameter, and are output immediately.



ParamTyp: E5
 Default: E5 = 5
 Value range: 0 ... 252

Example:

WP1UE5.00.01.05 sets the number to 5 unsuccessful read/write attempts until a status 5 is output

RP1UE5.00.00 outputs the number

If the number of read/write attempts is reduced:

- ⊕ Faster response time in enhanced mode.
- ⊖ Status 5 messages in the event of unstable tag reading.

Read Out Filter Mask "Filter List" FL

Parameter FL contains the current configuration of the filter masks as set during execution of command FI. The output format corresponds to the data input format of command FI without the filter number. The parameter can only be read, but not set.

ParamTyp: FL
 Value range: 0 ... 2

Example:

RP1UFL.00.01.02 outputs the current configuration of filter 2

Response: <Status><ChanNo><MemBank><Negate><LogicalOperation>0<Start Address><MaskLength><MaskData><CHCK><ETX>

Output Additional Information, "Information" IF

Parameter IF allows you to output additional information providing that the reading was successful and the multiframe protocol is activated. See "Protocol Mode QV" on page 56. The additional information is the RSSI value of the reading, the transmission channel used, and transmitting power of this reading.

ParamTyp: IF
 Default: IF = 0
 Value range: 0, 1

Example:

WP1UIF.00.01.01 prompts the read/write head to output additional information after each successful reading.

RP1UIF.00.00 outputs the value of parameter IF.

The additional information is output in the following format:

B<ChanNo> <InfoTyp> <RSSI> <TxChannel> <TxPower>

To distinguish the additional information from the standard outputs, the output begins with the status B as the first ASCII character, followed by the IDENT*Control* channel. This is followed by the <InfoTyp>, which indicates that this is a type .01 information frame. The output ends with the RSSI value (1 byte), the transmission channel used (1 byte), and the power used (2 bytes). The RSSI value is between 0 (= low) and 100 (= high).



Meaning of the bytes in response .42.31.01.1A.0D.00.14

- .42 = Status B_{ASCII} to identify the additional information
- .31 = 1_{ASCII}, IDENT*Control* channel 1
- .01 = The information type
- .1A = 26_{dec}, RSSI value
- .0D = 13_{dec}, tag access to transmission channel 13
- .00.14 = 20_{dec}, transmission power 20 mW

Memory Module for Tag Accesses to the "Memory Bank" MB

This parameter specifies the bank accessed by the read/write commands SR, ER, SW, and EW. See chapter 4.2.3.

- ParamTyp: MB
- Default: MB = .03 = User Memory
- Value range:
 - .00 = reserved (password area)
 - .01 = U/I/EPC
 - .02 = TID
 - .03 = User Memory

Example:

WP1UMB.00.01.03 sets the bank to User Memory

Retrieve Additional Information MD

This parameter allows you to retrieve information about the last successful tag access. This returns the RSSI value with a length of 1 byte, the transmission channel used with a length of 1 byte, and the transmitting power with a length of 2 bytes. The RSSI value may be between 0 (= low) and 100 (= high).

Parameter MD allows the same data to be accessed in the single-frame protocol as is available in the multiframe protocol with parameter IF. See "Protocol Mode QV" on page 56 and see "Output Additional Information, "Information" IF" on page 52.

- ParamTyp: MD

Example:

RP1UMD.00.01.01 returns the response .30.01.13.04.00.32

Explanation of the response:

- <Status> = 0
- <ChanNo> = 1
- <RSSI> = . 13 = 19_{dec}
- <TXChannel> = . 04
- <TXPower> = .00.32 = 50_{dec} mW



Measurement of Reflected Transmitting Power "Measure Reflection" MF

This parameter measures the reflected transmitting power of the antenna and the environment.

The results are output as one byte per transmission channel. The transmission channels depend on the country identifier set (parameter RC), .

To obtain the reflected power in dBm, subtract the value 100 from the return value in decimal notation.

ParamTyp: MF
Value range: -18 .. +21 dBm¹

¹1.0 or 255 is returned for values outside the value range

Example:

If the country identifier RC = 01 (= 4 channels), RP1UMF.00.00 returns the response 01.63.64.67.65

Explanation of the response:

<Status> = 0

<ChanNo> = 1

<PCh04> = .63 = 99_{dec} results in 99 - 100 = -1 dBm

<PCh07> = .64 = 100_{dec} results in 100 - 100 = 0 dBm

<PCh10> = .67 = 103_{dec} results in 103 - 100 = +3 dBm

<PCh13> = .65 = 101_{dec} results in 101 - 100 = +1 dBm

Number of Channels NC

Frequency hopping spread spectrum frequency access method:

Parameter NC indicates the number of channels on which a write or read attempt is performed. If the value 4 is set, the read/write head attempts to read the tag on 4 different frequencies when a read command is given. The parameter can be read and written.

Programmable frequency list frequency access method:

The parameter can be read only. The parameter specifies the number of transmission channels on which parameter CD is set.

ParamTyp: NC
Default setting: NC = 4
Value range: 1 ... 50

Example:

WP1UNC.00.01.02 allows two channels for a read attempt.

RP1URC.00.00 reads out the permitted number of channels set.

Search Algorithm Cancellation Criteria "number of tags to find" NT

Parameter NT specifies the number of tags in the measurement range that the read/write head searches for. Each command is repeated in accordance with the parameters Transmission Power (PT), Transmission Channel (CD) or Number of Channels (NC), and Number of Attempts (TA) (see chapter 7.2). If the number of tags found during the repeat operations reaches or exceeds the NT value, all further runs are canceled. The command is canceled, and the data is output.

If the number of tags is set to 255 (= .FF), the function is deactivated. This parameter does not affect "enhanced" commands, but only "single" commands.

ParamTyp: NT
 Default: NT = 255
 Value range: 0 ... 254, 255 = off

Example:

The value WP1UNT.00.01.05 sets the number of tags in the measurement range for which the read/write head searches to 5.

RP1UNT.00.00 outputs the set value.

Transmission Power "Power Transmit" PT

This parameter sets the transmission power in mW or reads out the transmission power set.

ParamTyp: PT
 Default: Depends on the country identifier set, see chapter 4.3.
 Value range: Depends on the country identifier set, see chapter 4.3.

Example:

WP1UPT.00.02.00.32 sets the transmission power to 50 mW
 RP1UPT.00.00 reads out the transmission power currently set

- ⊕ Higher detection range if you increase the transmission power.
- ⊖ Possible excessive detection ranges if you increase the transmission power.
- ⊖ Lower detection range in reflective environments if you increase the transmission power.
- ⊖ Adjacent read/write heads might be affected due to increased detection range.



Note!

You can operate the IUH-F192-V1-^{*} read/write head only with internally specified transmission power. You can use the command WP1UPT.00.02.xx.xx in the software to enter any transmission power within the specified range of values. The read/write head automatically sets the transmission power to the next lowest value available. Any entries outside the specified value range are returned as errors. Command RP1UPT.00.00 allows you to read out the power value that is currently set.



Tip

You can parameterize the read/write head with several transmission power values: Command WP1UPT.00.06.00.14.00.32.00.64 sets three transmission power values for 20 mW, 50 mW, and 100 mW. Each read and write command is executed in succession for all three transmission power values. If one or more tags are found and successfully read/written for the first transmission power, the command is still executed with all other transmission powers to reach any other tags that may be available.

You can specify a maximum of ten transmission power values. If several additional transmission channels are selected (), all set powers are executed on each transmission channel for each read or write command. See chapter 7.2.

Protocol Mode QV

Parameter QV toggles the output protocol between single frame and multiframe.

In single-frame protocol, the output corresponds to the Pepperl+Fuchs standard in LF and HF systems. If there is more than one tag in the measurement range, status A is output as a warning.

In the multiframe protocol, each tag that responded is output. An output is then issued which begins with status F, contains the number of responses, and completes the full command output.

ParamTyp: QV
 Default: QV = .4D
 Value range: .53 = S for single-frame protocol
 .4D = M for multiframe protocol

Example:

WP1UQV.00.01.4D sets the protocol to multiframe.

RP1UQV.00.00 outputs the set protocol mode.

If QV = M, the following responses are made to a single read command (SR):

Response: 0<ChanNo><Luii><UII1><Ldata><data><CHCK><ETX>
 0<ChanNo><Luii><UII2><Ldata><data><CHCK><ETX>
 0<ChanNo><Luii><UII3><Ldata><data><CHCK><ETX>
 F<ChanNo>0003<CHCK><ETX>

One read command was executed to which three tags responded. For each tag, the status, the IDENTControl channel, the length of the UII, the UII, the length of the data, and the read data are output. Then an output is issued with status F, the IDENTControl channel, and the number of tags that responded.

<Luii> = Length of <UII> in bytes, 2 bytes

<Ldata> = Length of <data> in bytes, 2 bytes

Responses Depending on Protocol Mode QV

Command	Parameter QV	
	Single-frame protocol	Multiframe protocol
	Responses	
SS	No tag: 5<ChanNo> One tag: 0<ChanNo><UII> Two tags: A<ChanNo>	No tag: F<ChanNo>0000 Two tags: 0<ChanNo><LuII><UII1> 0<ChanNo><LuII><UII2> F<ChanNo>0002
SR, #SR SF	No tag: 5<ChanNo> One tag: 0<ChanNo><data> Two tags: A<ChanNo>	No tag: F<ChanNo>0000 Two tags: 0<ChanNo><LuII><UII1><Ldata><data> 0<ChanNo><LuII><UII2><Ldata><data> F<ChanNo>0002
SW, #SW	No tag: 5<ChanNo> One tag: 0<ChanNo> Two tags: A<ChanNo>	No tag: F<ChanNo>0000 Two tags: 0<ChanNo><LuII><UII1> 0<ChanNo><LuII><UII2> F<ChanNo>0002
ES	No tag: 5<ChanNo> One tag added: 0<ChanNo><UII> One tag added: A<ChanNo> One tag removed: 0<ChanNo><UII> All tags removed: 5<ChanNo>	No tag: 5<ChanNo> Two tags added: 0<ChanNo><LuII><UII1> 0<ChanNo><LuII><UII2> Tag 1 removed: 5<ChanNo><LuII><UII1> Tag 3 added: 0<ChanNo><LuII><UII3> Tag 4 added (UII same as tag 2): A<ChanNo><LuII><UII2> All tags removed: 5<ChanNo><LuII><UII2> 5<ChanNo><LuII><UII3> 5<ChanNo><LuII><UII2>
SP	No tag: 5<ChanNo> One tag added: 0<ChanNo> One tag added: A<ChanNo>	No tag: F<ChanNo>0000 One tag added: 0<ChanNo><NUL><LuII><UII1> F<ChanNo>0001 One tag added: 0<ChanNo><NUL><LuII><UII1> A<ChanNo><NUL><LuII><UII2> F<ChanNo>0002

Table 7.2 <CHCK><ETX> omitted at the end of each response due to space requirements

Q Value QW

In accordance with EPC Gen 2 (ISO/IEC 18000-63), the slotted ALOHA principle is used for anticollision. The number of time slots is defined as 2^Q . The parameter QW defines the Q value. As a guide, the number of time slots should roughly correspond to the number of expected tags in the measurement range.

ParamTyp: QW
Default: QW = 2
Value range: 0 ... 7



Example:

WP1UQW.00.01.04 sets the Q value to 4. The read/write head therefore works with $2^4 = 16$ time slots.

RP1UQW.00.00 outputs the set Q value.

Country Identifier, "Region Code" RC

Parameter RC sets a country identifier or reads out the current country identifier.

The country identifier consists of two bytes:

- 1. Byte = 00
You can change the country identifier
- 1. Byte = 80
You cannot change the country identifier

The country identifier can be set to write-protected by the manufacturer only. The first byte is then set to 80. The second byte defines the country identifier. For all the available country identifiers, see chapter 6.2, and for the corresponding technical details, see chapter 4.3.

ParamTyp:	RC
Default setting:	.00.00 (green LED flashes)
Value range:	See chapter 6.2



Note!

Once you have set the country identifier, the read/write head automatically resets all other parameters to their respective default values. When programming or configuring parameters manually, always set the correct country identifier before changing any other parameters.



Note!

The country identifier remains unchanged when the default status is restored.



Note!

The IUH-F192-V1-FR2-02 is supplied ex-works with the country identifier "02" for the USA, Canada, and Mexico. Due to legal regulations, you cannot change this country identifier in the IUH-F192-V1-FR2-02.

Example:

WP1URC.00.02.00.03 sets the country identifier to China.

RP1URC.00.00 reads out the country identifier set.

The serial response .30.31.00.01 indicates the country identifier for Europe, which you can modify.

The serial response .30.31.80.02 indicates the country identifier for the IUH-F192-V1-FR2-02, which is set by the manufacturer. You cannot change this country identifier.

Reset to Default, RD

This parameter returns all settings of the read/write head to the default configuration. The parameter RC remains unchanged.

ParamTyp:	RD
-----------	----

Example:

WP1URD.00.00

Default Value Parameters

Abbreviation	Parameters	Default value
AP	Antenna Polarization AP	Right-handed circular (R)
CD	Transmission Channels	Depends on country identifier,
E5	Number of unsuccessful attempts up to Status 5	5
FL	Read Out Filter Mask	No filter set (0)
IF	Output Additional Information	Off (0)
MB	Memory Bank	User Memory (3)
MD	Retrieve Additional Information MD	Not applicable
MF	Measurement of Reflected Transmission Power	Not applicable
NC	Number of Channels	Depends on country identifier,
NT	Search Algorithm Cancellation Criteria	Off (255)
PT	Power Transmit	Depends on country identifier,
QV	Protocol Mode QV	Multiframe Protocol (M)
QW	Q Value	2
RC	Country Identifier, "Region Code"	Not applicable
RD	Reset to Default	Not applicable
SM	Transmission Pauses in "Sensing Mode"	0
TA	Number of Attempts, "Tries Allowed" TA	2

Transmission Pauses in "Sensing Mode" SM

The parameter SM defines a pause time in milliseconds. This pause time is executed once all runs are complete.

This parameter is especially useful for continuous operation with "enhanced" commands (see chapter 7.4). If you specify transmission pauses, you can operate the read/write head at higher ambient temperatures.

ParamTyp: SM
 Default: SM = .00.00
 Value range: 0 ms ... 65535 ms, 2 bytes

Example:

WP1USM.00.02.27.10 sets the pause time to 10,000 ms = 10 seconds.

RP1USM.00.00 outputs the pause time.

Number of Attempts "Tries Allowed" TA

This parameter sets the permitted number of read or write attempts, or reads out the permitted number of attempts.

ParamTyp: TA
 Default: TA = 1
 Value range: 1 ... 255

Example:

WP1UTA.00.01.01 permits precisely one attempt (= no repeats)

WP1UTA.00.01.03 permits three attempts

RP1UTA.00.00 reads out the permitted number of attempts

If the permitted number of read or write attempts between the read/write head and the tag is increased, this results in:

- ⊕ More reliable reading and writing.
- ⊖ Increased response time.

7.7

Error/Status Messages

Status	Description
0	The command was executed correctly.
1	Reserved
2	Switch-on message, reset was executed.
3	Reserved
4	The command is incorrect or incomplete. The parameter is not in the valid area.
5	No read/write tag in the measurement range.
6	Hardware error, e.g., error during self-test or read/write head defective.
7	Internal device error.
8	Reserved
9	The parameterized tag type is not compatible with the connected read head.
A	Singleframe protocol: there are multiple tags in the measurement range (IUH*). Multiframe protocol: There are multiple tags in the measurement range that have the same UII/EPC (IUH*).
B	Indicates the output of additional information (see "Output Additional Information, "Information" IF" on page 52).
C	Reserved
D	Reserved
E	Internal buffer overflow; execute reset.
F	Indicates the end of an output in the multiframe protocol (see "Protocol Mode QV" on page 56).



8 Service and Maintenance

The device is designed and constructed to function stable over long periods of time. For this reason, regular cleaning or maintenance is unnecessary.



9

Troubleshooting

Problem	Solution
Interference from several read/write heads in the direct vicinity	<ul style="list-style-type: none">■ Change the setting of the transmission channels■ Reduce the transmission power
Status A message	<ul style="list-style-type: none">■ Check whether there are multiple tags in the detection range: Remove the tag from the detection range by placing the tag in a sealed metal container Repeat the read or write operation■ Use filter commands■ Determine whether multiple tags have the same UII/EPC
Device not responding, green LED flashing	<ul style="list-style-type: none">■ Set the correct country identifier. See chapter 6.2 and see chapter 4.3.

10 Appendix
10.1 Dimensions
IUH-F192-V1-*

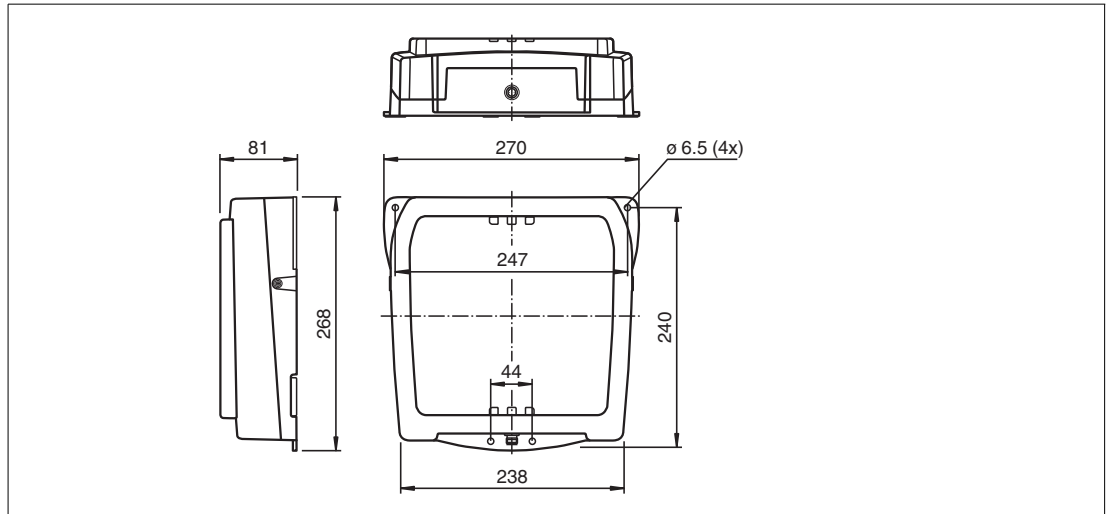

Figure 10.1

10.2 ASCII table

hex	dec	ASCII	hex	dec	ASCII	hex	dec	ASCII	hex	dec	ASCII
00	0	NUL	20	32	Space	40	64	@	60	96	'
01	1	SOH	21	33	!	41	65	A	61	97	a
02	2	STX	22	34	"	42	66	B	62	98	b
03	3	ETX	23	35	#	43	67	C	63	99	c
04	4	EOT	24	36	\$	44	68	D	64	100	d
05	5	ENQ	25	37	%	45	69	E	65	101	e
06	6	ACK	26	38	&	46	70	F	66	102	f
07	7	BEL	27	39	'	47	71	G	67	103	g
08	8	BS	28	40	(48	72	H	68	104	h
09	9	HT	29	41)	49	73	I	69	105	i
0A	10	LF	2A	42	*	4A	74	J	6A	106	j
0B	11	VT	2B	43	+	4B	75	K	6B	107	k
0C	12	FF	2C	44	,	4C	76	L	6C	108	l
0D	13	CR	2D	45	-	4D	77	M	6D	109	m
0E	14	SO	2E	46	.	4E	78	N	6E	110	n
0F	15	SI	2F	47	/	4F	79	O	6F	111	o
10	16	DLE	30	48	0	50	80	P	70	112	p
11	17	DC1	31	49	1	51	81	Q	71	113	q
12	18	DC2	32	50	2	52	82	R	72	114	r
13	19	DC3	33	51	3	53	83	S	73	115	s
14	20	DC4	34	52	4	54	84	T	74	116	t
15	21	NAK	35	53	5	55	85	U	75	117	u
16	22	SYN	36	54	6	56	86	V	76	118	v

hex	dec	ASCII	hex	dec	ASCII	hex	dec	ASCII	hex	dec	ASCII
17	23	ETB	37	55	7	57	87	W	77	119	w
18	24	CAN	38	56	8	58	88	X	78	120	x
19	25	EM	39	57	9	59	89	Y	79	121	y
1A	26	SUB	3A	58	:	5A	90	Z	7A	122	z
1B	27	ESC	3B	59	;	5B	91	[7B	123	{
1C	28	FS	3C	60	<	5C	92	\	7C	124	
1D	29	GS	3D	61	=	5D	93]	7D	125	}
1E	30	RS	3E	62	>	5E	94	^	7E	126	~
1F	31	US	3F	63	?	5F	95	_	7F	127	DEL

10.3 Detection Range

The read/write head has a typical detection range of around 1 meter; this range is determined by the tag used and can be adjusted by selecting the transmission power. Other influencing factors include the setup and installation of the specific application, interference from any materials present (in particular metal), and the ambient conditions. The read and write distances for the relevant tag, which are detailed separately, have been established in a test laboratory under ideal conditions. For this reason, the combination of read/write head and tag must be tested for the intended application under real conditions.

Please note the distance tables. The distance tables and additional information regarding your product can be found at <http://www.pepperl-fuchs.com>. Simply enter the product name or model number in the **Search** box and then click the **Search** key.

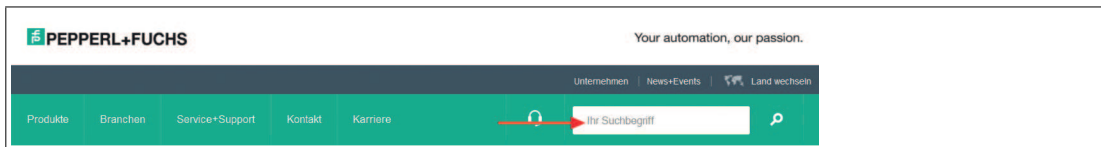

Select your product from the list of search results. Click on the information you require in the product information list, e.g., **Technical documents**.



A list of all available documents is displayed.



Antenna Diagram

The antenna diagrams show the electric field strength in the far field depending on the direction. The front of the read/write head points towards 0°.

IUH-F192-V1-FR1 (865 MHz... 868 MHz) and IUH-F192-V1-FR2 (902 MHz... 928 MHz)

Horizontal Cut¹

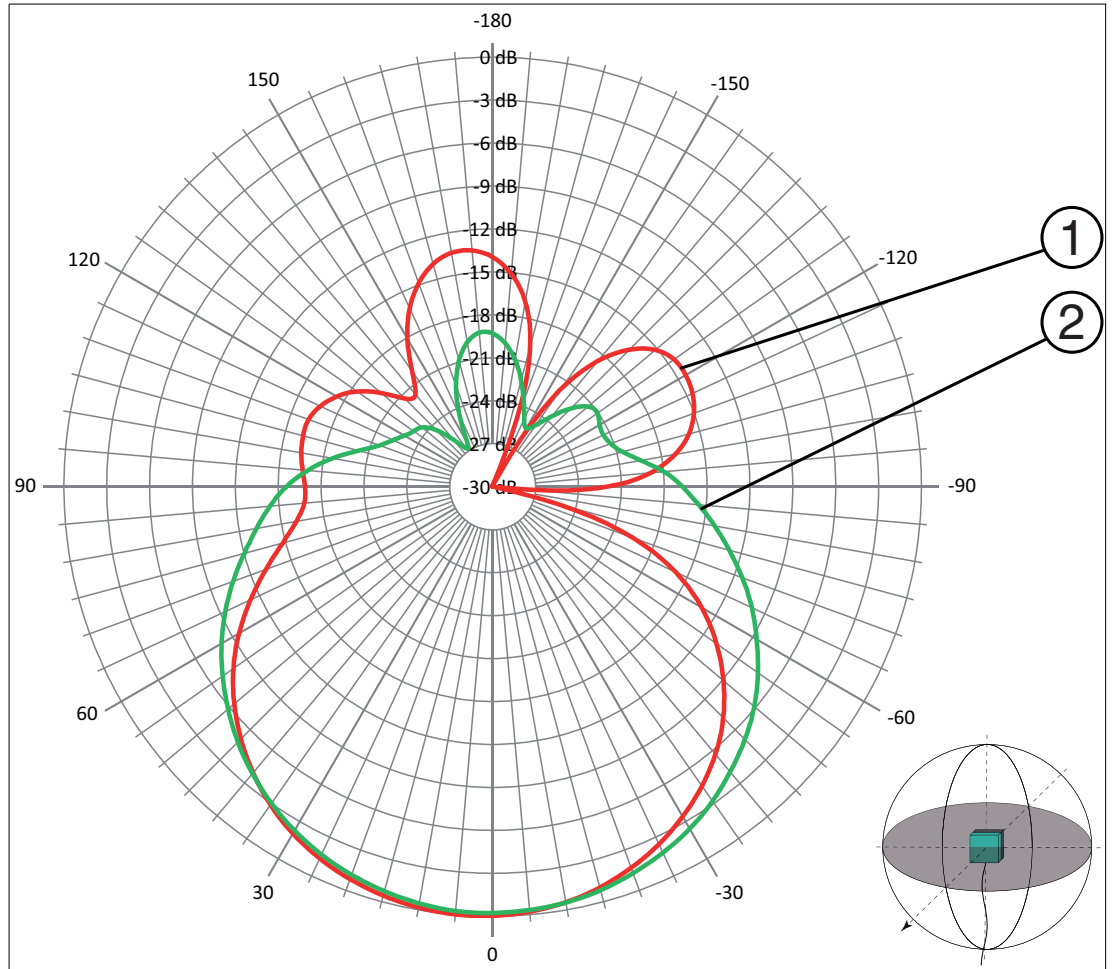

1. Read/write head points towards 0°

Figure 10.2 ① - Horizontal polarization
 ② - Vertical polarization



Vertical Cut¹

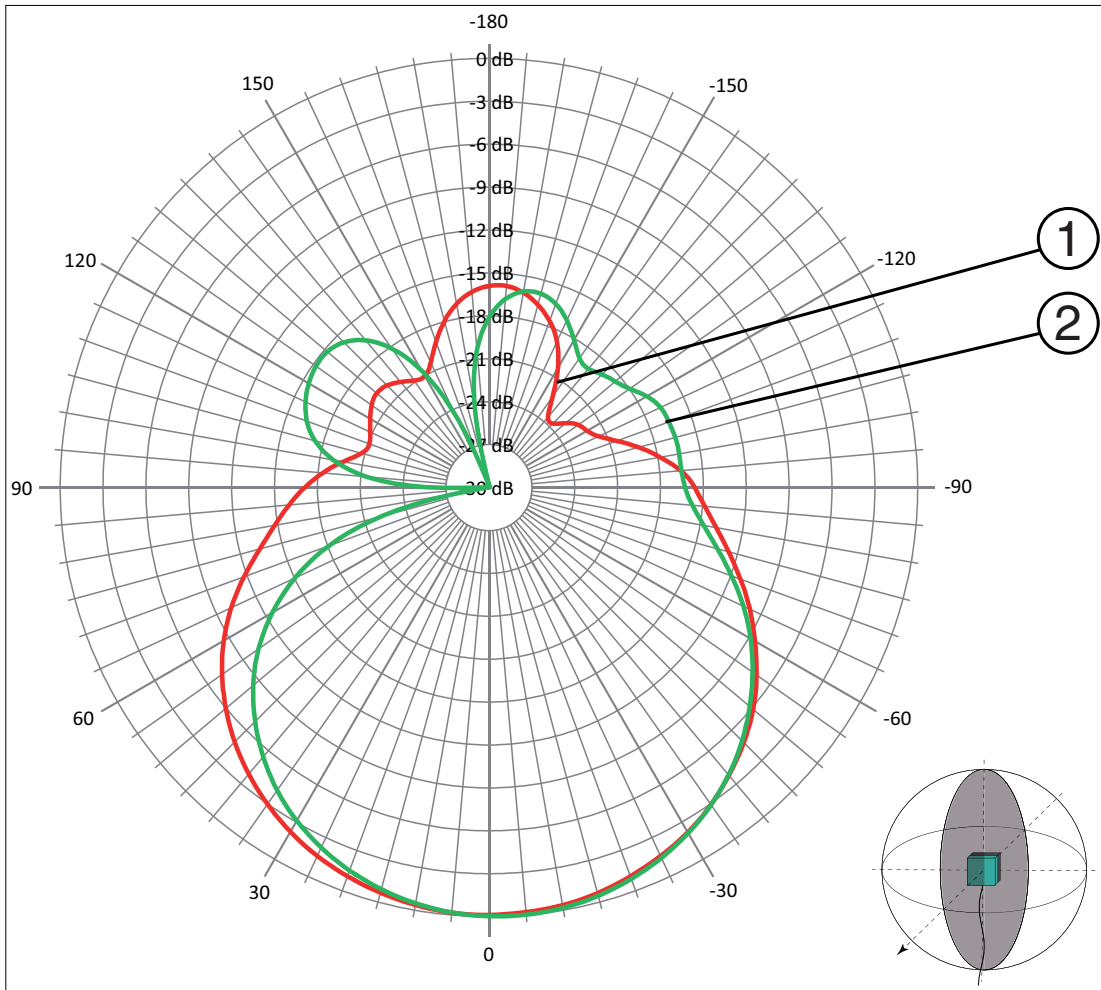

1. Read/write head points towards 0°

Figure 10.3 ① - Horizontal polarization
 ② - Vertical polarization



FACTORY AUTOMATION – SENSING YOUR NEEDS



Worldwide Headquarters

Pepperl+Fuchs GmbH
68307 Mannheim · Germany
Tel. +49 621 776-0
E-mail: info@de.pepperl-fuchs.com

USA Headquarters

Pepperl+Fuchs Inc.
Twinsburg, Ohio 44087 · USA
Tel. +1 330 4253555
E-mail: sales@us.pepperl-fuchs.com

Asia Pacific Headquarters

Pepperl+Fuchs Pte Ltd.
Company Registration No. 199003130E
Singapore 139942
Tel. +65 67799091
E-mail: sales@sg.pepperl-fuchs.com

www.pepperl-fuchs.com

 **PEPPERL+FUCHS**
SENSING YOUR NEEDS