

Königswinkel 10
32825 Blomberg
Germany
Phone +49 5235 9500-0
Fax +49 5235 9500-10

TEST REPORT

Test Report Number: F134117E1

Applicant:
Pepperl & Fuchs GmbH

Manufacturer:
Pepperl & Fuchs GmbH

Equipment under Test:
RFID Reader
IQH1-18GM-V1



Laboratory (CAB) accredited by
Deutsche Akkreditierungsstelle GmbH (DAkks)
in compliance with DIN EN ISO/IEC 17025
under the Reg. No. D-PL-17186-01-02,
FCC Test site registration number 90877 and
Industry Canada Test site registration IC3469A-1

REFERENCES

- [1] **ANSI C63.4:2009** American National Standard for Methods of Measuring of Radio-Noise Emissions from Low-Voltage Electrical and Electronic Equipment in the Range of 9 kHz to 40 GHz.
- [2] **FCC 47 CFR Part 15** Radio Frequency Devices
- [3] **RSS-210 Issue 8 (December 2010)** Low-power Licence-exempt Radiocommunication Devices (All Frequency Bands): Category I Equipment
- [4] **RSS-Gen Issue 3 (December 2010)** General Requirements and Information for the Certification of Radiocommunication Equipment

TEST RESULT

The requirements of the tests performed as shown in the overview (chapter 4 of this test report) were fulfilled by the equipment under test.

The complete test results are presented in the following.

Test engineer:	Michael DINTER <small>Name</small>	 <small>Signature</small>	17 December 2013 <small>Date</small>
Authorized reviewer:	Bernd STEINER <small>Name</small>	 <small>Signature</small>	17 December 2013 <small>Date</small>

RESERVATION

This test report is only valid in its original form.

Any reproduction of its contents in extracts without written permission of the accredited test laboratory PHOENIX TESTLAB GmbH is prohibited.

The test results herein refer only to the tested sample. PHOENIX TESTLAB GmbH is not responsible for any generalisations or conclusions drawn from these test results concerning further samples. Any modification of the tested samples is prohibited and leads to the invalidity of this test report. Each page necessarily contains the PHOENIX TESTLAB Logo and the TEST REPORT NUMBER.

Contents:	Page
1 Identification	4
1.1 Applicant.....	4
1.2 Manufacturer.....	4
1.3 Test laboratory.....	4
1.4 EUT (equipment Under Test)	5
1.5 Technical data of equipment.....	5
1.6 Dates	6
2 Operational states and physical boundaries	7
3 Additional information	8
4 Overview	8
5 Test results	9
5.1 Spectrum mask.....	9
5.1.1 Method of measurement (spectrum mask)	9
5.1.2 Test results (spectrum mask)	10
5.2 20 dB bandwidth	11
5.2.1 Method of measurement (20 dB bandwidth)	11
5.2.2 Test results (20 dB bandwidth)	12
5.3 Frequency tolerance	13
5.3.1 Method of measurement (Frequency tolerance)	13
5.3.2 Test results (Frequency tolerance)	14
5.4 Conducted emission measurement on ac mains (150 kHz to 30 MHz)	15
5.4.1 Method of measurement (conducted emission measurement on ac mains (150 kHz to 30 MHz)).....	15
5.4.2 Test results (conducted emission measurement on ac mains)	16
5.5 Radiated emissions.....	18
5.5.1 Method of measurement (radiated emissions)	18
5.5.2 Preliminary radiated emission tests (9 kHz to 1 GHz)	25
5.5.3 Final radiated emission test (9 kHz to 30 MHz).....	29
5.5.4 Final radiated emission test (30 MHz to 1 GHz).....	30
6 Report history	32
7 Test equipment and ancillaries used for tests.....	32
8 List of annexes	33

1 Identification

1.1 Applicant

Name:	Pepperl+Fuchs Inc.
Address:	1600 Enterprise Parkway USA Twinsburg OH 44087
Country:	USA
Name for contact purposes:	Helmut G. HORNIS
e-mail address:	hhornis@us.pepperl-fuchs.com

1.2 Manufacturer

Name:	Pepperl+Fuchs GmbH
Address:	Lilienthalstr. 200 68307 Mannheim
Country:	Germany
Name for contact purposes:	Sebastian R. STOEBER
Tel:	+49 621 776 1074
Fax:	+49 621 776 1890
e-mail address:	sstoeber@de.pepperl-fuchs.com

1.3 Test laboratory

The tests were carried out at: **PHOENIX TESTLAB GmbH**
Königswinkel 10
32825 Blomberg
Germany

Test Laboratory (CAB) accredited by Deutsche Akkreditierungsstelle GmbH (DAkKS) in compliance with DIN EN ISO/IEC 17025 under the Reg. No. D-PL-17186-01-02, recognized by Bundesnetzagentur under the Reg.-No. BNetzA-CAB-02/21-104. CAB Designation Number DE0004, listed by FCC 31040/SIT1300F2, IC OATS Listing 3469A-1.

The tests were performed at: **PHOENIX TESTLAB GmbH**
Königswinkel 10
32825 Blomberg
Germany

1.4 EUT (Equipment Under Test)

Type of equipment:	RFID Reader
Type designation / model name:	IQH1-18GM-V1
Serial No.:	204622
FCC ID:	IREIQH1-18GM-V1
IC:	-

1.5 Technical data of equipment

Power supply: *	24 V DC		
Supply voltage: *	U _{nom} = 24 V	U _{min} = 20 V	U _{max} = 30 V
Type of modulation: *	amplitude-modulated		
Frequency deviation: *	-		
Operating frequency range: *	13.56 MHz		
Number of channels: *	1		
Antenna type: *	Internal loop antenna		
Antenna area: *	1.3 cm ²		
Duty cycle: *	-		
Rated RF power: *	-		
Data rate: *	26 kBit/s		
Lowest internal frequency: *	484 kHz		
Highest internal frequency: *	20 MHz		
Temperature range: *	-25 ... 70 °C (-13 ... 158 °F)		

* declared by the applicant.

The following external I/O cables were used:

Identification	Connector		Length
	EUT	Ancillary	
Data-/ Power-Line	M12 Plug	M12 Plug	2m
-	-	-	-
-	-	-	-

*: Length during the test if no other specified.

Ancillary equipment

Type of equipment	Identcontrol
Type designation	IC-KP2-2HRX-2V1
Manufacturer	Pepperl + Fuchs
Part No	204980
Power supply	24 V DC via AC Mains AC Adapter (used for conducted tests)
Supply voltage:	24 DC
Highest internal Frequency: *	Below 108 MHz

* as declared by the applicant

Type of equipment	Power Supply
Type designation	Quint PS 100-240 AC / 24 DC / 5 A
Manufacturer	Phoenix Contact
Part No	2938581
Power supply	AC Mains AC Adapter
Supply voltage:	120 VAC 60 Hz
Highest internal Frequency:	Below 108 MHz

Type of equipment	TAG
Type designation	IOC 21 50 P

1.6 Dates

Date of receipt of test sample:	24 September 2013
Start of test:	24 September 2013
End of test:	10 October 2013

2 Operational states and physical boundaries

The tests were carried out with an unmodified test sample, which operates with a test-software. This software sets the EUT in continuous reading transponder mode.

The conducted emission measurement on the power supply line was carried out on the AC/DC adapter, because in this case the EUT was supplied via an IDENTCONTROL UNIT delivered by the applicant. The AC/DC adapter for the IDENTCONTROL was powered by an AC-mains network with 120 V AC / 60 Hz.

For the conducted emission test the Loop antenna was replaced with a dummy load as described in the KDB 174176 Keyword: Section 15.207, C63.4, Suitable Dummy Load, AC Power Line Conducted Measurement.

During the tests the EUT was supplied via the IDENTCONTROL UNIT interface and the TAG information was permanently checked with the help of a LED.

No spurious emission measurement of the receiver was carried out, because the co located transmitter transmits continuously.

During the tests, the EUT was not labelled with a FCC-label.

The physical boundaries of the EUT are shown below.

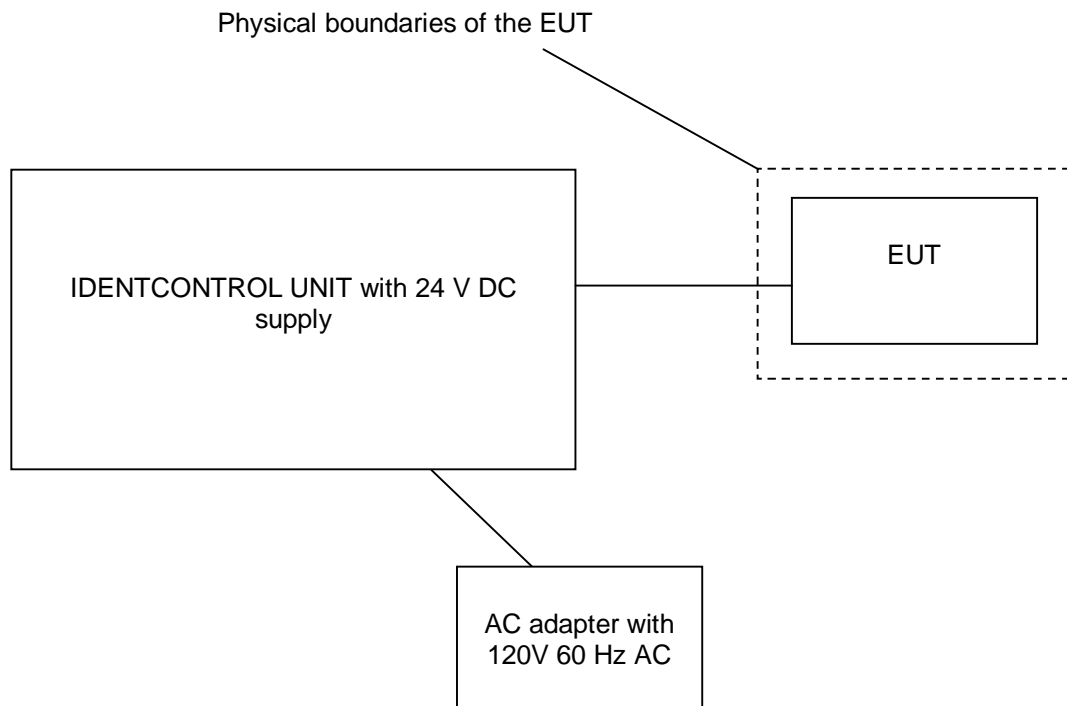

3 Additional information

The following ancillary equipment was used for the tests:

AC Adapter: Phoenix Contact Quint PS 100-240 AC / 24 DC / 5 A Order-No.:2938581

TAG: IOC 21 50 P

Interface: IDENTCONTROL UNIT (Pepperl & Fuchs)

During the tests the EUT was sealed and not labelled as required by FCC / IC

4 Overview

Application	Frequency range [MHz]	FCC 47 CFR Part 15 section [2]	RSS 210, Issue 8 [3] or RSS-Gen, Issue 3 [4]	Status	Refer page
Radiated emissions	13.110 to 14.110	15.225 (a) – (d)	A 2.6 [3]	Passed	10 et seq.
20 dB bandwidth	13.560 MHz	15.225 (e)	-	Passed	11 et seq.
Frequency tolerance	13.560 MHz	15.225 (e)	A 2.6 [3]	Passed	13 et seq.
Radiated emissions	0.009 - 1,000	15.205 (a) 15.209 (a)	2.5 [3] 7.2.2 [4] 7.2.5 [4]	Passed	18 et seq.
Conducted emissions on supply line	0.15 - 30	15.207 (a)	7.2.4 [4]	Passed	16 et seq.
99 % bandwidth	13.560 MHz	-	4.6.1 [4]	Passed	Annex D

5 Test results

5.1 Spectrum mask

5.1.1 Method of measurement (spectrum mask)

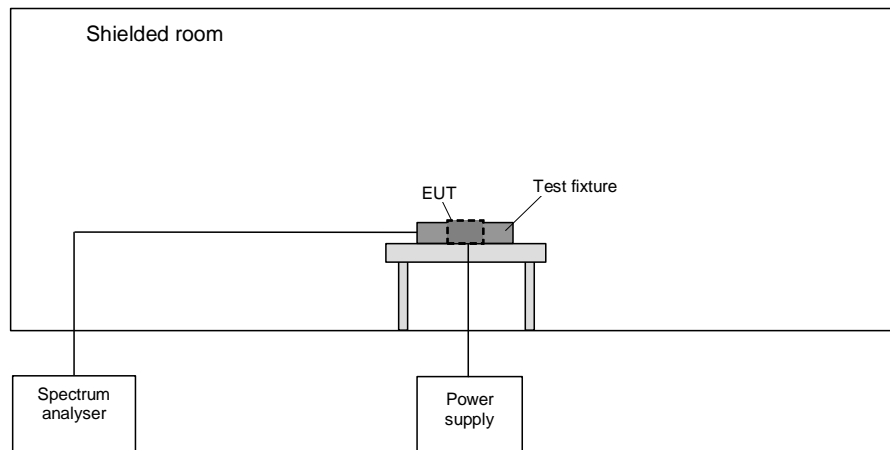

The following procedure will be used for the spectrum mask measurement:

- 1) Place the EUT in the test fixture and switch it on.
- 2) Use the following spectrum analyser settings: $RWB = VBW = 1 \text{ kHz}$, Span = wide enough to capture the whole 13 MHz band including the frequency ranges were the 15.209 limit applies, Trace mode = MaxHold, select the limit line 15225spc
- 3) After trace stabilisation, set the marker to the signal peak.
- 4) The Reference level will be calculated by the amount of the margin of the wanted signal to its 30 m emission limit plus the marker value.
- 5) The whole signal trace has to be below the limit line.

5.1.2 Test results (spectrum mask)

Ambient temperature	21 °C	Relative humidity	55 %
---------------------	-------	-------------------	------

Supply voltage: The EUT was supplied with 24 V DC.

Test record: The test was carried out while the EUT was reading an IOC 21 50 P - TAG.

The Reference level in the plot below was calculated with the following formular:

$$\text{Relevel} = (\text{Limit}_{\text{OATS}(30\text{m})} - \text{Level}_{\text{OATS}(\text{calculated to } 30\text{m})})$$

Where $\text{Limit}_{\text{OATS}} = 84.0 \text{ dB}\mu\text{V}/\text{m}$, $\text{Level}_{\text{OATS}} = 40.5 \text{ dB}\mu\text{V}/\text{m}$.

134117_SPEC.wmf: Spectrum mask:

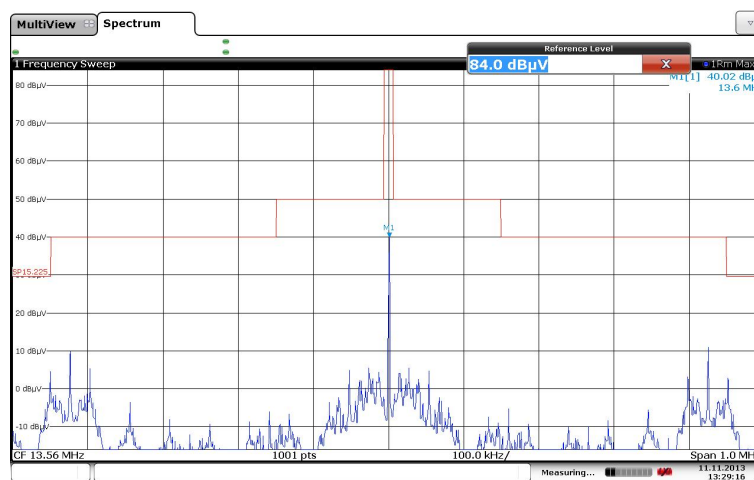

Test result: Passed

Test equipment used for the test:

58, 62

5.2 20 dB Bandwidth

5.2.1 Method of measurement (20 dB Bandwidth)

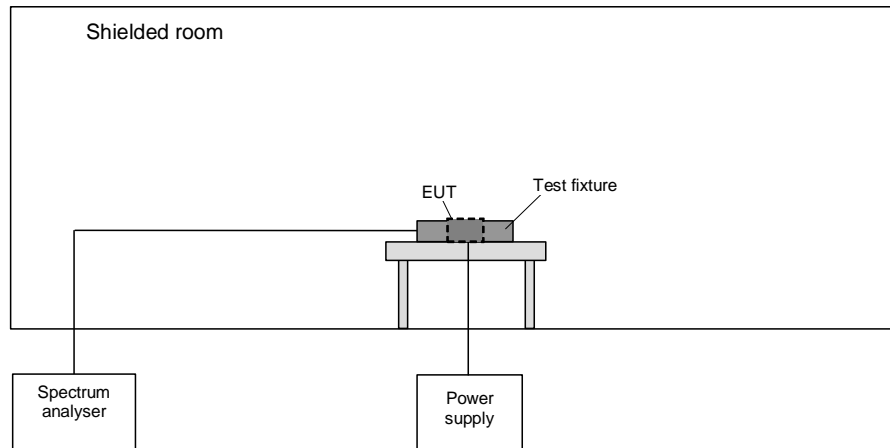

The following procedure will be used for the occupied bandwidth measurement:

- 1) Place the EUT in the test fixture and switch it on.
- 2) Use the following spectrum analyser settings: RWB = VBW = 10 kHz, Span = wide enough to capture app. 1.5 times the 20 dB bandwidth, Trace mode = MaxHold.
- 3) After trace stabilisation, set the first marker and the first display line to the signal peak. Set the second display line 20 dB below the first display line. The second marker and its delta marker shall be set to cross points of the spectrum line and the second display line and note these frequencies.
- 4) Alternatively the 20 dB down function of the analyser could be used, if this function will be applicable to the displayed spectrum.

5.2.2 Test results (20 dB Bandwidth)

Ambient temperature	21 °C	Relative humidity	55 %
---------------------	-------	-------------------	------

Supply voltage: The EUT was supplied with 24 V DC.

Test record: The test was carried out while the EUT was reading an IOC 21 50 P - TAG.

134117_20dB.wmf: 20 dB Bandwidth:



f_L	f_U	BW ($f_U - f_L$)
13.548 MHz	13.574 MHz	26 kHz
Measurement uncertainty		$< \pm 1 \cdot 10^{-7}$

Test equipment used for the test:

58, 62

5.3 Frequency tolerance

5.3.1 Method of measurement (Frequency tolerance)

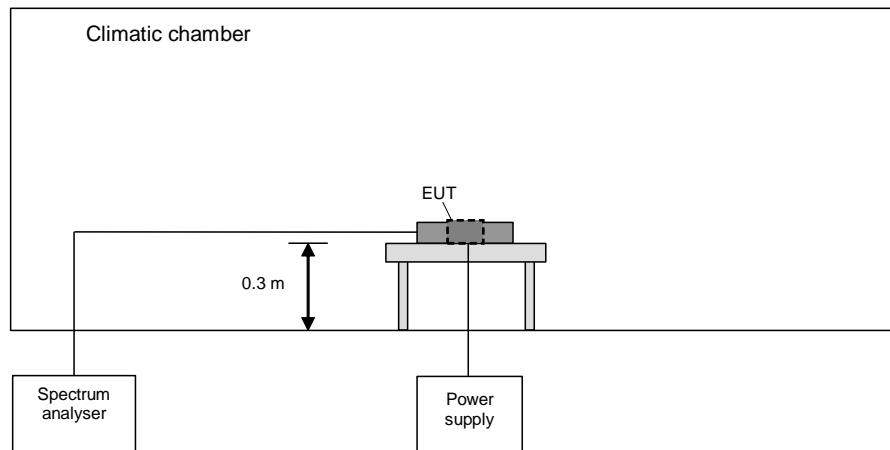

The following procedure will be used:

- 1) Place the EUT in the climatic chamber.
- 2) Switch on the EUT and check the correct function and the settings of the spectrum analyser.
- 3) Switch off the EUT and tune the climatic chamber to a temperature of 50 °C. Wait until the thermal balance is obtained.
- 4) Switch the EUT on and record the frequencies at start-up and 2, 5 and 10 minutes after powering on.
- 5) Repeat 4) with the minimum and the maximum of the supply voltage.
- 6) Switch off the EUT and tune the climatic chamber to a temperature range of 50 °C to –20 °C to in ten-degree steps. Wait until the thermal balance is obtained for every step.
- 7) Switch the EUT on and record the frequencies at start-up and 2, 5 and 10 minutes after powering on.
- 8) Repeat 7) with the minimum and the maximum of the supply voltage at 20 °C.
- 9) Repeat 6) with the next temperature step until –20 °C were reached.

5.3.2 Test results (Frequency tolerance)

Ambient temperature	21 °C	Relative humidity	55 %
---------------------	-------	-------------------	------

Test set-up: For this test the EUT was fixed on a wooden table inside the climatic chamber.

Cable guide: For further information of the cable guide refer to the pictures in annex A of this test report.

Temperature	Supply voltage	Minutes after switch on	Frequency MHz	Allowed tolerance	Measured tolerance Hz	Result
50 °C	24 VDC	0	13.560742	±1.356 kHz	1	Passed
	24 V DC	2	13.560737	±1.356 kHz	-4	Passed
	24 V DC	5	13.560742	±1.356 kHz	1	Passed
	24 V DC	10	13.560752	±1.356 kHz	11	Passed
40 °C	24 V DC	0	13.56076	±1.356 kHz	19	Passed
	24 V DC	2	13.560742	±1.356 kHz	1	Passed
	24 V DC	5	13.560743	±1.356 kHz	2	Passed
	24 V DC	10	13.560743	±1.356 kHz	2	Passed
30 °C	24 V DC	0	13.560778	±1.356 kHz	37	Passed
	24 V DC	2	13.560759	±1.356 kHz	18	Passed
	24 V DC	5	13.560749	±1.356 kHz	8	Passed
	24 V DC	10	13.560743	±1.356 kHz	2	Passed
20 °C	20 V DC (U_{min})	0	13.560781	±1.356 kHz	40	Passed
	24 V DC (U_{nom})		13.560788	±1.356 kHz	47	Passed
	30 V DC (U_{max})		13.560785	±1.356 kHz	44	Passed
	20 V DC (U_{min})	2	13.560777	±1.356 kHz	36	Passed
	24 V DC (U_{nom})		13.560772	±1.356 kHz	31	Passed
	30 V DC (U_{max})		13.560773	±1.356 kHz	32	Passed
	20 V DC (U_{min})	5	13.560768	±1.356 kHz	27	Passed
	24 V DC (U_{nom})		13.560764	±1.356 kHz	23	Passed
	30 V DC (U_{max})		13.560769	±1.356 kHz	28	Passed
	20 V DC (U_{min})	10	13.560743	±1.356 kHz	2	Passed
	24 V DC (U_{nom})		13.560741	-	0	Reference
	30 V DC (U_{max})		13.560744	±1.356 kHz	3	Passed
10 °C	24 V DC	0	13.560817	±1.356 kHz	76	Passed
	24 V DC	2	13.560802	±1.356 kHz	61	Passed
	24 V DC	5	13.560792	±1.356 kHz	51	Passed
	24 V DC	10	13.560791	±1.356 kHz	50	Passed
0 °C	24 V DC	0	13.560832	±1.356 kHz	91	Passed
	24 V DC	2	13.560822	±1.356 kHz	81	Passed
	24 V DC	5	13.560812	±1.356 kHz	71	Passed
	24 V DC	10	13.560806	±1.356 kHz	65	Passed
-10 °C	24 V DC	0	13.560827	±1.356 kHz	86	Passed
	24 V DC	2	13.560827	±1.356 kHz	86	Passed
	24 V DC	5	13.560827	±1.356 kHz	86	Passed
	24 V DC	10	13.560827	±1.356 kHz	86	Passed
-20 °C	24 V DC	0	13.560792	±1.356 kHz	51	Passed
	24 V DC	2	13.560832	±1.356 kHz	91	Passed
	24 V DC	5	13.560832	±1.356 kHz	91	Passed
	24 V DC	10	13.560832	±1.356 kHz	91	Passed
Measurement uncertainty				$< \pm 1 \cdot 10^{-7}$		

Test result: Passed

Test equipment used for the test:

58, 61,62

5.4 Conducted emission measurement on ac mains (150 kHz to 30 MHz)

5.4.1 Method of measurement (conducted emission measurement on ac mains (150 kHz to 30 MHz))

This test will be carried out in a shielded chamber. Tabletop devices will set up on a non-conducting support with a size of 1 m by 1.5 m and a height of 80 cm above the ground plane. Floor-standing devices will be placed directly on the ground plane. The setup of the Equipment under test will be in accordance to ANSI C63.4-2009 [1].

The frequency range 150 kHz to 30 MHz will be measured with an EMI Receiver set to MAX Hold mode with peak and average detector and a resolution bandwidth of 9 kHz. A scan will be carried out on the phase (or plus pole in case of DC powered devices) of the AC mains network. If levels detected 10 dB below the appropriate limit, this emission will be measured with the average and quasi-peak detector on all lines.

Frequency range	Resolution bandwidth
150 kHz to 30 MHz	9 kHz

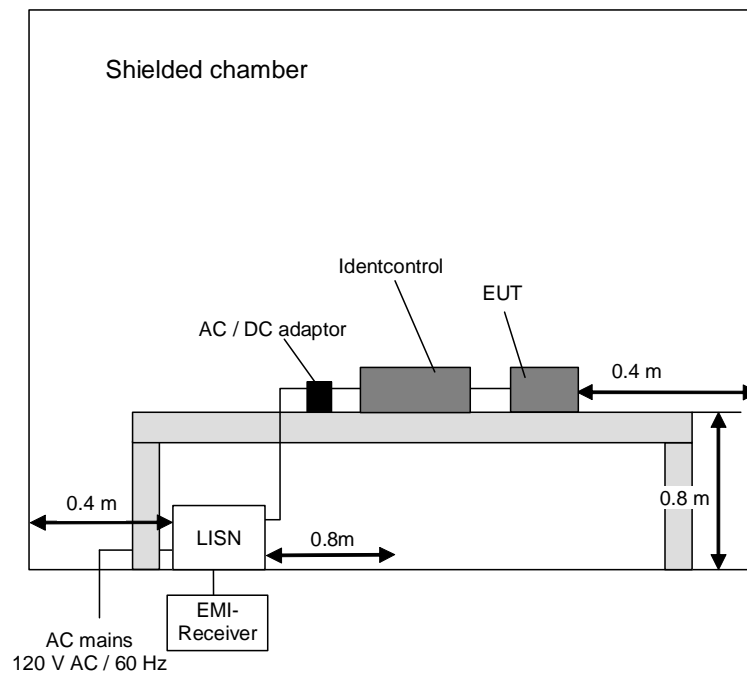

5.4.2 Test results (conducted emission measurement on ac mains)

Ambient temperature:	20 °C	Relative humidity:	45 %
----------------------	-------	--------------------	------

- Position of EUT: The EUT was set-up on a wooden table of a height of 0.8 m.
- Cable guide: The cable of the EUT was fixed on the wooden table. For further information of the cable guide refer to the pictures in annex A of this test report.
- Test record: For the conducted emission test the Loop antenna was replaced with a dummy load as described in the KDB 174176 Keyword: Section 15.207, C63.4, Suitable Dummy Load, AC Power Line Conducted Measurement. All results are shown in the following.
- Power supply: During this test the EUT was powered via AC DC adapter from an AC-mains network with 120 V AC / 60 Hz.
- Operation states: As described in chapter 2.

The curves in the diagram only represent for each frequency point the maximum measured value of all preliminary measurements which were made for each power supply line. The top measured curve represents the peak measurement and the bottom measured curve the average measurement. The quasi-peak measured points are marked by "x" and the average measured points by "+".

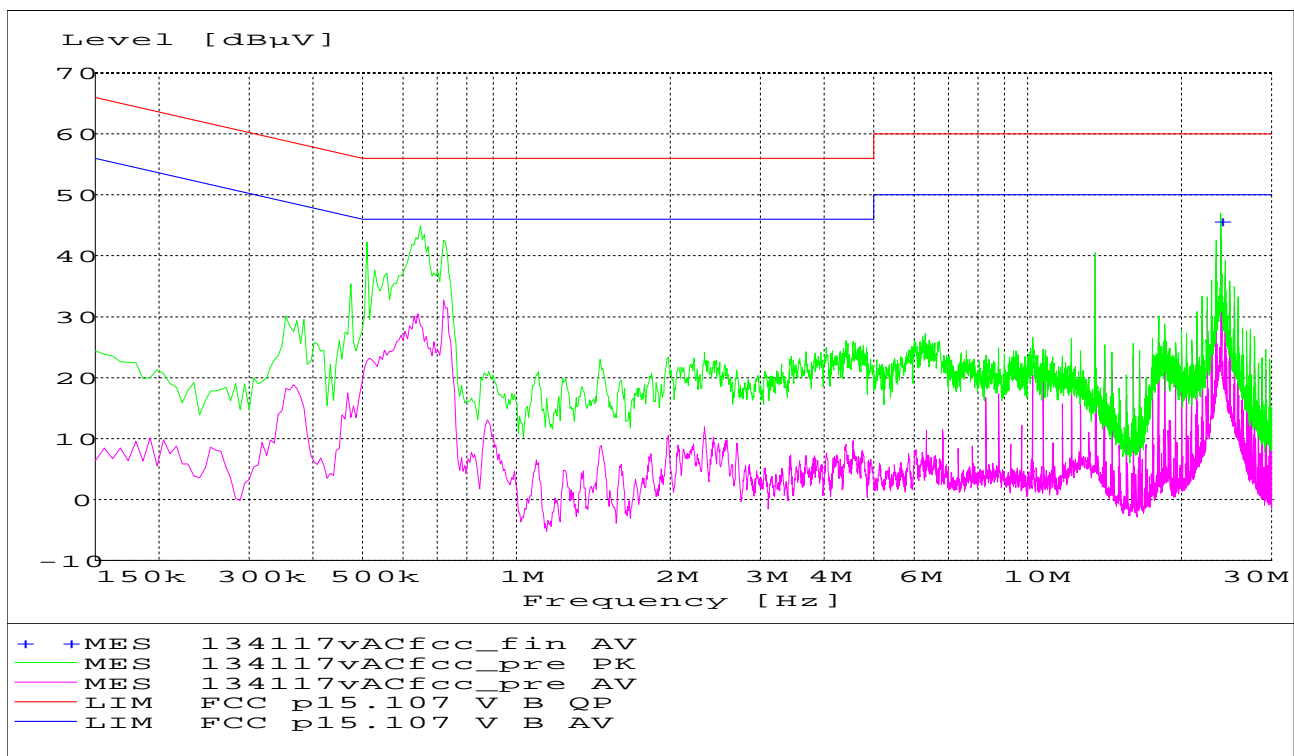

Data record name: 134117vACfcc

Result measured with the average detector (marked by a +):

Frequency MHz	Level dB μ V	Transducer dB	Limit dB μ V	Margin dB	Line	PE
23.883000	45.70	2.8	50.0	4.3	N	GND

Test: Passed

Test equipment used for the test:

1 - 3, 5, 6

5.5 Radiated emissions

5.5.1 Method of measurement (radiated emissions)

The radiated emission measurement is subdivided into five stages.

- A preliminary measurement carried out in a fully anechoic chamber with a fixed antenna height in the frequency range 9 kHz to 1 GHz.
- A final measurement carried out on an outdoor test side without reflecting ground plane and a fixed antenna height in the frequency range 9 kHz to 30 MHz.
- A final measurement carried out on an open area test side with reflecting ground plane and various antenna height in the frequency range 30 MHz to 1 GHz.
- A preliminary measurement carried out in a fully anechoic chamber with a variable antenna distance and height in the frequency range 1 GHz to 110 GHz.
- A final measurement carried out in a fully anechoic chamber with a fixed antenna height in the frequency range 1 GHz to 110 GHz.

All measurements will be carried out with the EUT working on the middle and upper and lower edge of the assigned frequency band.

Preliminary measurement (9 kHz to 30 MHz):

In the first stage a preliminary measurement will be performed in a shielded room with a measuring distance of 3 meters. Tabletop devices will set up on a non-conducting support with a size of 1 m by 1.5 m and a height of 80 cm. Floor-standing devices will be placed directly on the turntable/ground plane. The set up of the Equipment under test will be in accordance to ANSI C63.4-2009 [1].

The frequency range 9 kHz to 30 MHz will be monitored with a spectrum analyser while the system and its cables will be manipulated to find out the configuration with the maximum emission levels if applicable. The EMI Receiver will be set to MAX Hold mode. The EUT and the measuring antenna will be rotated around their vertical axis to found the maximum emissions.

The resolution bandwidth of the spectrum analyser will be set to the following values:

Frequency range	Resolution bandwidth
9 kHz to 150 kHz	200 Hz
150 kHz to 30 MHz	10 kHz

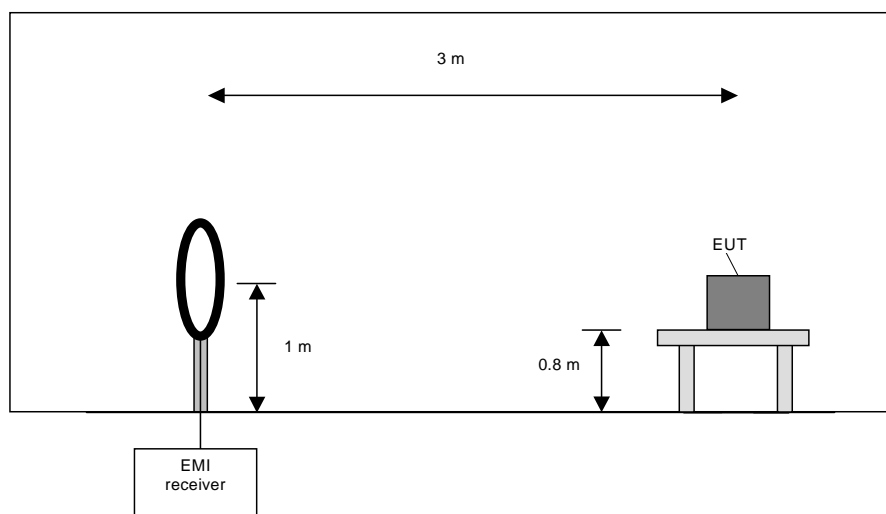

Preliminary measurement procedure:

Prescans were performed in the frequency range 9 kHz to 150 kHz and 150 kHz to 30 MHz.

The following procedure will be used:

- 1) Monitor the frequency range at horizontal polarisation and a EUT azimuth of 0 °.
- 2) Manipulate the system cables within the range to produce the maximum level of emission.
- 3) Rotate the EUT by 360 ° to maximize the detected signals.
- 4) Make a hardcopy of the spectrum.
- 5) Measure the frequencies of highest detected emission with a lower span and resolution bandwidth to increase the accuracy and note the frequency value.
- 6) Repeat steps 1) to 5) with the other orthogonal axes of the EUT (because of EUT is a module and might be used in a handheld equipment application).
- 7) Rotate the measuring antenna and repeat steps 1) to 5).

Final measurement (9 kHz to 30 MHz):

In the second stage a final measurement will be performed on an open area test site with no conducting ground plane in a measuring distances of 3 m, 10 m and 30 m. In the case where larger measuring distances are required the results will be extrapolated based on the values measured on the closer distances according to Section 15.31 (f) (2) [2]. The final measurement will be performed with a EMI Receiver set to Quasi Peak detector except for the frequency bands 9 kHz to 90 kHz and 110 kHz to 490 kHz where an average detector will be used according Section 15.209 (d) [2].

On the during the preliminary measurement detected frequencies the final measurement will be performed while rotating the EUT and the measuring antenna in the range of 0 ° to 360 ° around their vertical axis until the maximum value is found.

The resolution bandwidth of the EMI Receiver will be set to the following values:

Frequency range	Resolution bandwidth
9 kHz to 150 kHz	200 Hz
150 kHz to 30 MHz	9 kHz

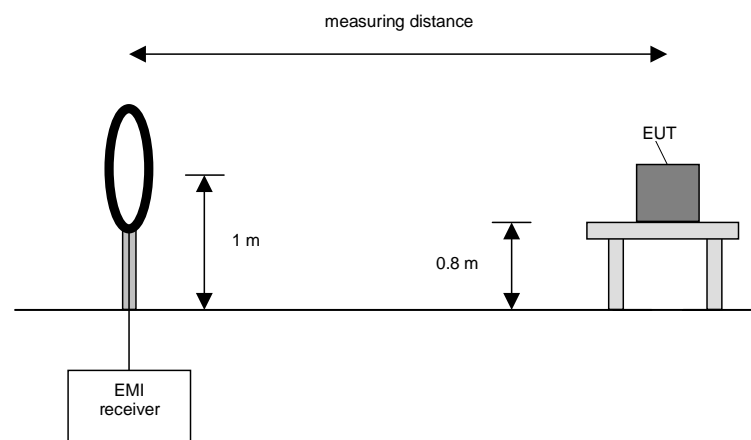

Final measurement procedure:

The following procedure will be used:

- 1) Monitor the frequency range with the measuring antenna at vertical orientation parallel to the EUT at an azimuth of 0 °.
- 2) Rotate the EUT by 360 ° to maximize the detected signals and note the azimuth and orientation.
- 3) Rotate the measuring antenna to find the maximum and note the value.
- 4) Rotate the measuring antenna and repeat steps 1) to 3) until the maximum value is found.
- 5) Repeat steps 1) to 4) with the other orthogonal axes of the EUT (because of EUT is a module and might be used in a handheld equipment application).

Preliminary measurement (30 MHz to 1 GHz)

In the first stage a preliminary measurement will be performed in a fully anechoic chamber with a measuring distance of 3 meter. Tabletop devices will set up on a non-conducting support with a size of 1 m by 1.5 m and a height of 80 cm. Floor-standing devices will be placed directly on the turntable/ground plane. The set up of the Equipment under test will be in accordance to ANSI C63.4-2009 [1].

The frequency range 30 MHz to 1 GHz will be measured with an EMI Receiver set to MAX Hold mode and a resolution bandwidth of 100 kHz. The measurement will be performed in horizontal and vertical polarisation of the measuring antenna and while rotating the EUT in its vertical axis in the range of 0 ° to 360 °.

The resolution bandwidth of the EMI Receiver will be set to the following values:

Frequency range	Resolution bandwidth
30 MHz to 230 MHz	100 kHz
230 MHz to 1 GHz	100 kHz

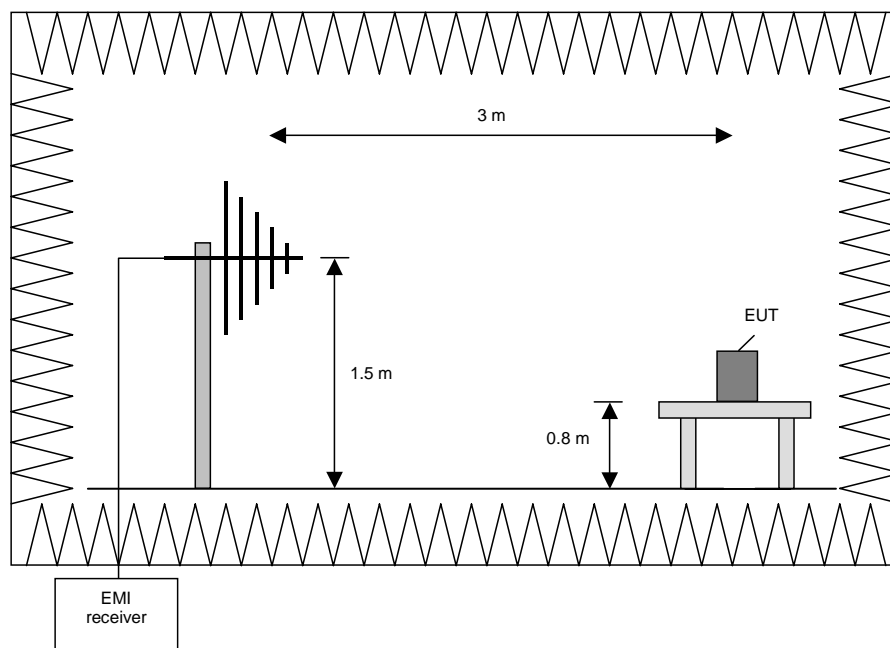

Procedure preliminary measurement:

Prescans were performed in the frequency range 30 MHz to 230 MHz and 230 MHz to 1 GHz.

The following procedure will be used:

1. Monitor the frequency range at horizontal polarisation and a EUT azimuth of 0 °.
2. Manipulate the system cables within the range to produce the maximum level of emission.
3. Rotate the EUT by 360 ° to maximize the detected signals.
4. Make a hardcopy of the spectrum.
5. Measure the frequency of the detected emissions with a lower span and resolution bandwidth to increase the accuracy and note the frequency value.
6. Repeat 1) to 4) with the other orthogonal axes of the EUT (because of EUT is a module and might be used in a handheld equipment application).
7. Repeat 1) to 5) with the vertical polarisation of the measuring antenna.

Final measurement (30 MHz to 1 GHz)

A final measurement on an open area test site will be performed on selected frequencies found in the preliminary measurement. During this test the EUT will be rotated in the range of 0 ° to 360 °, the measuring antenna will be set to horizontal and vertical polarisation and raised and lowered in the range from 1 m to 4 m to find the maximum level of emissions.

The resolution bandwidth of the EMI Receiver will be set to the following values:

Frequency range	Resolution bandwidth
30 MHz to 1 GHz	120 kHz

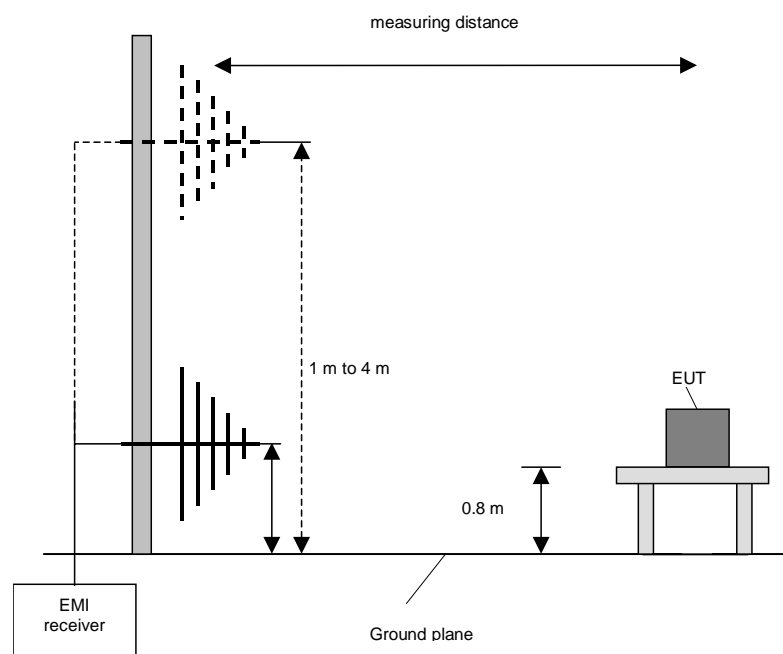

Procedure final measurement:

The following procedure will be used:

- 1) Measure on the selected frequencies at an antenna height of 1 m and a EUT azimuth of 23 °.
- 2) Move the antenna from 1 m to 4 m and note the maximum value at each frequency.
- 3) Rotate the EUT by 45 ° and repeat 2) until an azimuth of 337 ° is reached.
- 4) Repeat 1) to 3) for the other orthogonal antenna polarization.
- 5) Move the antenna and the turntable to the position where the maximum value is detected.
- 6) Measure while moving the antenna slowly +/- 1 m.
- 7) Set the antenna to the position where the maximum value is found.
- 8) Measure while moving the turntable +/- 45 °.
- 9) Set the turntable to the azimuth where the maximum value is found.
- 10) Measure with Final detector (QP and AV) and note the value.
- 11) Repeat 5) to 10) for each frequency.
- 12) Repeat 1) to 11) for each orthogonal axes of the EUT (because of EUT is a module and might be used in a handheld equipment application).

Preliminary and final measurement (1 GHz to 110 GHz)

This measurement will be performed in a fully anechoic chamber. Tabletop devices will set up on a non-conducting support with a size of 1 m by 1.5 m and a height of 80 cm. Floor-standing devices will be placed directly on the turntable/ground plane. The set up of the Equipment under test will be in accordance to ANSI C63.4-2009 [1].

Preliminary measurement (1 GHz to 110 GHz)

The frequency range will be divided into different sub ranges depending of the frequency range of the used horn antenna. The spectrum analyser set to MAX Hold mode and a resolution bandwidth of 100 kHz. The measurement will be performed in horizontal and vertical polarisation of the measuring antenna, the antenna close to the EUT and while moving the antenna over all sides of the EUT. With the spectrum analyser in CLEAR / WRITE mode the cone of the emission should be found and than the measuring distance will be set to 3 m with the receiving antenna moving in this cone of emission. At this position the final measurement will be carried out.

The resolution bandwidth of the EMI Receiver will be set to the following values:

Frequency range	Resolution bandwidth
1 GHz to 4 GHz	100 kHz
4 GHz to 12 GHz	100 kHz
12 GHz to 18 GHz	100 kHz
18 GHz to 26.5 GHz	100 kHz
26.5 GHz to 40 GHz	100 kHz
40 GHz to 60 GHz	100 kHz
50 GHz to 75 GHz	100 kHz
75 GHz to 110 GHz	100 kHz

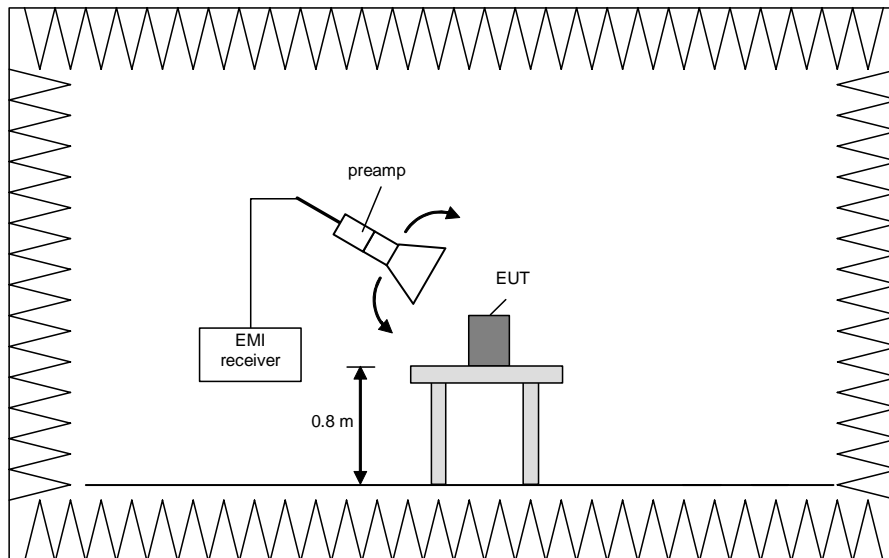

Final measurement (1 GHz to 110 GHz)

The frequency range will be divided into different sub ranges depending of the frequency range of the used horn antenna. The EMI Receiver set to peak and average mode and a resolution bandwidth of 1 MHz. The measurement will be performed in horizontal and vertical polarisation of the measuring antenna and while rotating the EUT in its vertical axis in the range of 0 ° to 360 ° in order to have the antenna inside the cone of radiation.

The resolution bandwidth of the EMI Receiver will be set to the following values:

Frequency range	Resolution bandwidth
1 GHz to 4 GHz	1 MHz
4 GHz to 12 GHz	1 MHz
12 GHz to 18 GHz	1 MHz
18 GHz to 26.5 GHz	1 MHz
26.5 GHz to 40 GHz	1 MHz
40 GHz to 60 GHz	1 MHz
50 GHz to 75 GHz	1 MHz
75 GHz to 110 GHz	1 MHz

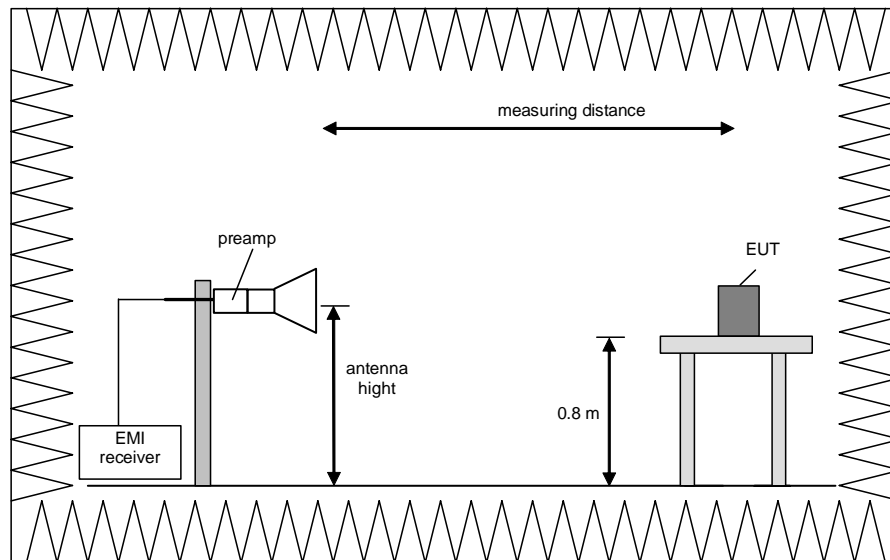

Procedure of measurement:

The measurements were performed in the frequency range 1 GHz to 4 GHz, 4 GHz to 12 GHz, 12 GHz to 18 GHz, 18 GHz to 26.5 GHz, 26.5 GHz to 40 GHz, 40 GHz to 60 GHz, 60 GHz to 75 GHz and 75 GHz to 110 GHz. The following procedure will be used:

- 1) Monitor the frequency range at horizontal polarisation and move the antenna over all sides of the EUT (if necessary move the EUT to another orthogonal axis).
- 2) Change the antenna polarisation and repeat 1) with vertical polarisation.
- 3) Make a hardcopy of the spectrum.
- 4) Measure the frequency of the detected emissions with a lower span and resolution bandwidth to increase the accuracy and note the frequency value.
- 5) Change the analyser mode to Clear / Write and found the cone of emission.
- 6) Rotate and move the EUT, so that the measuring distance can be enlarged to 3 m and the antenna will be still inside the cone of emission.
- 7) Measure the level of the detected frequency with the correct resolution bandwidth, with the antenna polarisation and azimuth and the peak and average detector, which causes the maximum emission.
- 8) Repeat steps 1) to 7) for the next antenna spot if the EUT is larger than the antenna beamwidth.

Step 1) to 6) are defined as preliminary measurement.

5.5.2 Preliminary radiated emission tests (9 kHz to 1 GHz)

Ambient temperature:	20 °C	Relative humidity:	45 %
----------------------	-------	--------------------	------

- Position of EUT: The EUT was set-up on a wooden table of a height of 0.8 m.
- Cable guide: The cable of the EUT was fixed on the wooden table. For further information of the cable guide refer to the pictures in annex A of this test report.
- Test record: The test was carried out in normal operation mode of the EUT(reading a TAG). All results are shown in the following.
- Power supply: During this test the EUT was powered with 24 V DC.

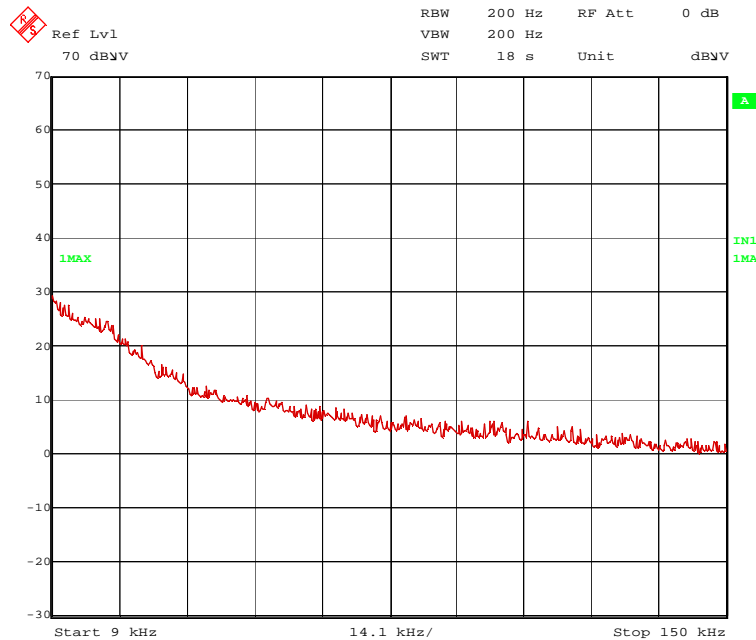

134117a.wmf: Spurious emissions from 9 kHz to 150 kHz

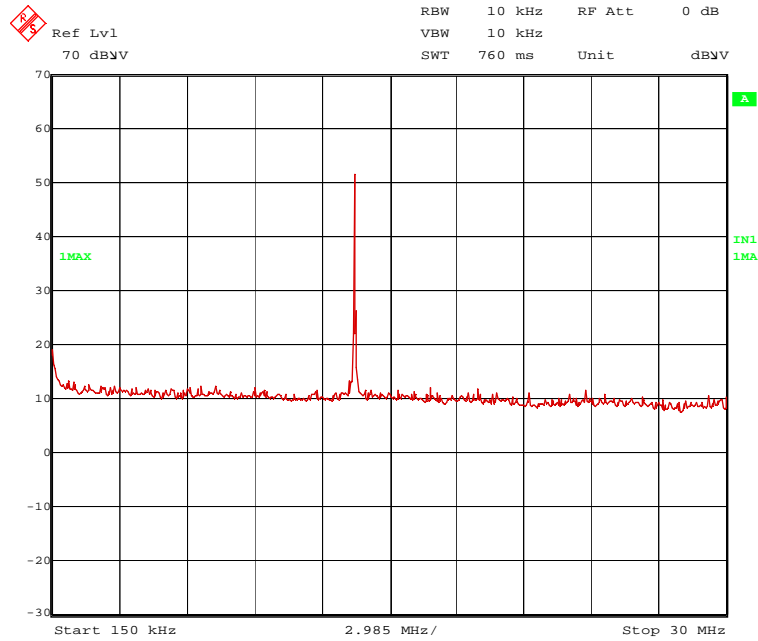

134117b.wmf: Spurious emissions from 150 kHz to 30 MHz

The following emission was found according to FCC 47 CFR Part 15 section 15.209 (a) and 15.225.

13.560 MHz (wanted signal is according to FCC 47 CFR Part 15 section 15.225)

This frequency has to be measured on the outdoor test site. The results were presented in the following.

Title: Emissionmeasurement according FCC
EMI Test receiver ESI Rohde & Schwarz
EUT: IQH1-18GM-V1
Manufacturer: Pepperl & Fuchs
Operating Condition: Reading TAG
Test site: fully anechoic chamber M20; PHOENIX TEST LAB GmbH
Operator: M. DINTER
Test Specification: 24 VDC

The limit line and measurement curve shown in the diagram below refer to the preliminary measurements. Here, it must be noted that because of the reduced measuring distance and because of the floor absorbers, the measured values do not comply with the values of the above mentioned standard; they only serve as orientation in determining which frequencies must be measured on the open area test site.

The limit line is achieved with the applied standard by converting to a 3 m measurement distance (+ 10 dB) and the correction for the free space in which in the "worst case" the reflected floor wave is missing entirely (- 6 dB). Therefore 4 dB is added to the limit line of the standard concerned.

The curves in the diagram only represent the maximum measured value for each frequency point of all preliminary measurements, which were carried out with the EUT in various positions.

The top measured curve represents the peak measurement. The measured points marked with "x" are frequency points for which later measurements with a quasi-peak detector were carried out. These values are indicated in the following table. The bottom measured curve represents average values (marked with "+"), which are only required for control purposes.

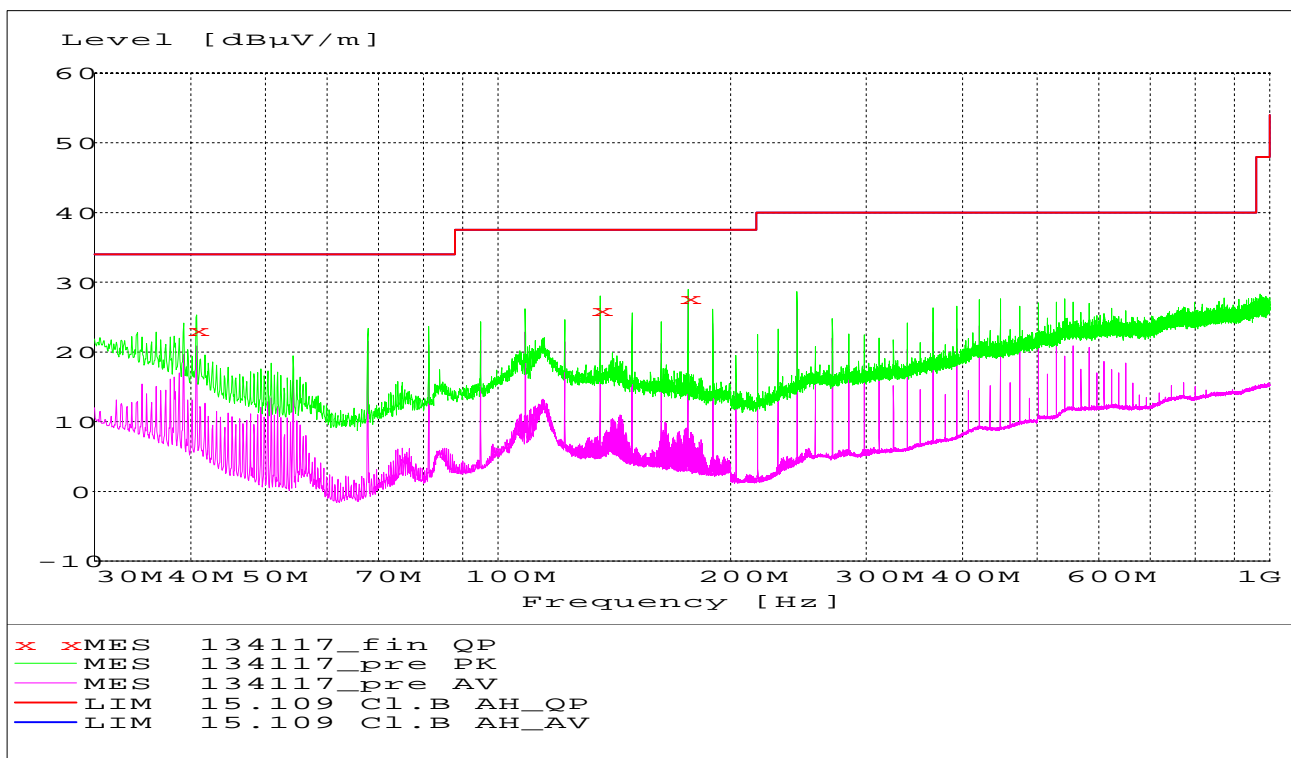

Data record name: 134117

The following frequencies were found during the preliminary radiated emission test:

Frequency MHz
108.480
135.588
244.080

The following frequencies were found inside the restricted bands:

Frequency MHz
40.680
176.292
447.520

These frequencies have to be measured on the open area test site. The results were presented in the following.

Test equipment used the test:

29, 31 – 33, 43, 54, 56

5.5.3 Final radiated emission test (9 kHz to 30 MHz)

Ambient temperature:	15 °C	Relative humidity:	56 %
----------------------	-------	--------------------	------

- Position of EUT:** The EUT was set-up on a non-conducting table of a height of 0.8 m. The distance between EUT and antenna was 3 m, 10 m and 30 m.
- Cable guide:** The cable of the EUT was fixed on the non-conducting table. For further information of the cable guide refer to the pictures in annex A of this test report.
- Test record:** The test was carried out in normal operation mode of the EUT (reading a TAG). All results are shown in the following.
- Power supply:** During this test the EUT was powered with 24 V DC.
- Test results:** The test results were calculated with the following formula:

$$\text{Result [dB}\mu\text{V/m]} = \text{reading [dB}\mu\text{V]} + \text{antenna factor [dB/m]}$$

Results with measuring distance of 3 m						
Frequency	Result dB μ V/m	Limit(* dB μ V/m)	Margin dB	Detector	Readings dB μ V	Antenna factor * dB/m
13.560	66.3	124.0	57.7	QP	46.3	20.0
Results with measuring distance of 10 m						
Frequency MHz	Result dB μ V/m	Limit(* dB μ V/m)	Margin dB	Detector	Readings dB μ V	Antenna factor * dB/m
13.560	59.3	104.0	44.7	QP	46	20.0
Results with measuring distance of 30 m						
Frequency MHz	Result dB μ V/m	Limit(* dB μ V/m)	Margin dB	Detector	Readings dB μ V	Antenna factor * dB/m
13.560	39.3*)	84	44.7	QP	-	20.0
Signal was below the noise floor of the measuring system						
Measurement uncertainty			+2.2 dB / -3.6 dB			

*: Cable loss included

(*):Limits according to 15.225

*) :Level extrapolated with a factor (40dB/decade) from the result at 10m according to Part 15.31 (f)(2)

Test: Passed

Test equipment used for the test:

56 – 57

5.5.4 Final radiated emission test (30 MHz to 1 GHz)

Ambient temperature:	20 °C	Relative humidity:	47 %
----------------------	-------	--------------------	------

- Position of EUT: The EUT was set-up on a wooden table of a height of 0.8 m.
- Cable guide: The cable of the EUT was fixed on the wooden table. For further information of the cable guide refer to the pictures in annex A of this test report.
- Test record: The test was carried out in normal operation mode of the EUT(reading a TAG). All results are shown in the following.
- Power supply: During this test the EUT was powered with 24 V DC.
- Test results: The test results were calculated with the following formula:

$$\text{Result [dB}\mu\text{V/m]} = \text{reading [dB}\mu\text{V]} + \text{cable loss [dB]} + \text{antenna factor [dB/m]}$$

The measured points and the limit line in the following diagram refer to the standard measurement of the emitted interference in compliance with the above mentioned standard. The measured points marked with x are the measured results of the standard subsequent measurement on the open area test site.

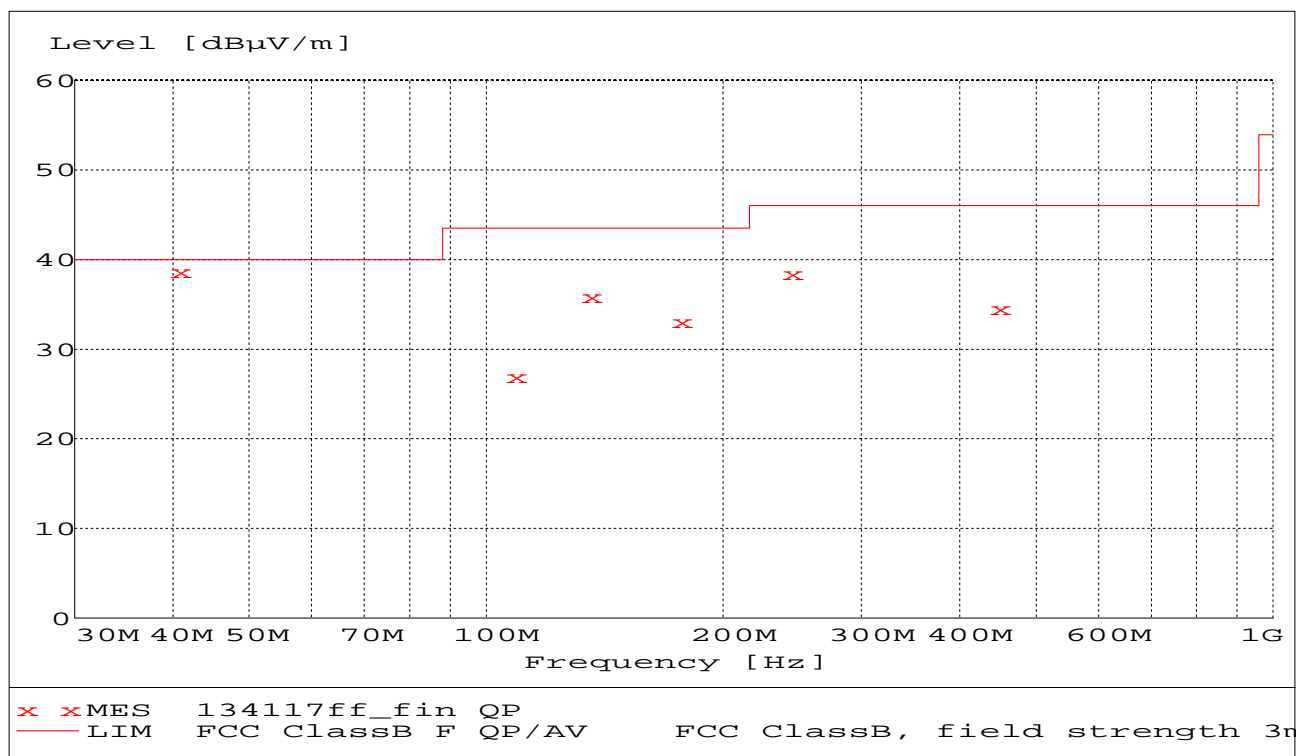

Data record name: 134117ff

The results of the standard subsequent measurement on the open area test site are indicated in the table below. The limits as well as the measured results (levels) refer to the above mentioned standard while taking account of the specified requirements for a 3 m measuring distance.

Result measured with the quasipeak detector:

(These values are marked in the above diagram by an x)

Spurious emissions in restricted bands									
Frequency	Result	Limit	Margin	Readings	Antenna factor	Cable loss	Height	Azimuth	Pol.
MHz	dB μ V/m	dB μ V/m	dB	dB μ V	dB/m	dB	cm	deg	
108.480	26.9	43.5	16.6	14.2	11.6	1.1	250	96	horizontal
135.588	35.9	43.5	7.6	22.7	11.9	1.3	233	256	horizontal
244.080	38.4	46.0	7.6	25.0	11.7	1.7	124	107	horizontal
Spurious emissions outside restricted bands									
Frequency	Result	Limit	Margin	Readings	Antenna factor	Cable loss	Height	Azimuth	Pol.
MHz	dB μ V/m	dB μ V/m	dB	dB μ V	dB/m	dB	cm	deg	
40.680	38.7	40.0	1.3	23.7	14.3	0.7	100	271	vertical
176.292	33.1	43.5	10.4	21.8	9.8	1.5	150	260	horizontal
447.520	34.5	46.0	11.5	15.5	16.6	2.4	192	216	horizontal
Measurement uncertainty				+2.2 dB / -3.6 dB					

The test results were calculated with the following formula:

$$\text{Result [dB}\mu\text{V/m]} = \text{reading [dB}\mu\text{V]} + \text{cable loss [dB]} + \text{antenna factor [dB/m]}$$

Test: Passed

Test equipment used for the test:

14 – 20

6 Report history

Report Number	Date	Comment
F134117E1	7 November 2013	Document created

7 Test equipment and ancillaries used for tests

No.	Test equipment	Type	Manufacturer	Serial No.	PM. No.	Cal. Date	Cal. due
1	Shielded chamber M4	-	Siemens	B83117S1-X158	480088	Weekly verification (system cal.)	
2	Measuring receiver	ESIB 26	Rohde & Schwarz	100292	481182	09/03/2012	03/2014
3	LISN	NSLK8128	Schwarzbeck	8128155	480058	04/05/2012	05/2014
5	AC-filter	B84299-D87-E3	Siemens	930262292	480097	Weekly verification (system cal.)	
6	EMI-Software	ES-K1	Rohde & Schwarz	-	480111	-	-
14	Open area test site	-	Phoenix Test-Lab	-	480085	Weekly verification (system cal.)	
15	Measuring receiver	ESIB7	Rohde & Schwarz	100304	480521	15/02/2012	02/2014
16	Controller	HD100	Deisel	100/670	480139	-	-
17	Turntable	DS420HE	Deisel	420/620/80	480087	-	-
18	Antenna support	AS615P	Deisel	615/310	480086	-	-
19	Antenna	CBL6111 D	Chase	25761	480894	28/09/2011	09/2014
20	EMI Software	ES-K1	Rohde & Schwarz	-	480111	-	-
29	Fully anechoic chamber M20	-	Albatross Projects	B83107-E2439-T232	480303	Weekly verification (system cal.)	
31	Measuring receiver	ESI 40	Rohde & Schwarz	100064	480355	13/02/2012	02/2014
32	Controller	HD100	Deisel	100/670	480326	-	-
33	Turntable	DS420HE	Deisel	420/620/80	480315	-	-
34	Antenna support	AS615P	Deisel	615/310	480187	-	-
35	Antenna	CBL6112 B	Chase	2688	480328	21/04/2011	04/2014
43	RF-cable No. 30	RTK 081	Rosenberger	-	410141	Weekly verification (system cal.)	
56	Loop antenna	HFH2-Z2	Rohde & Schwarz	832609/014	480059	16/02/2012	02/2014
57	EMI test receiver	ESPC	Rohde & Schwarz	843756/006	480150	09/02/2012	02/2014
58	Loop Antenna Ø = 225 mm	-	Phoenix Test-Lab	-	410085	Weekly verification	
59	RF-cable No. 10	RG223	Phoenix-Test-Lab	-	410102	Weekly verification	
60	Outdoor test site	-	Phoenix-Test-Lab	-	480293	-	
61	Climatic Chamber	MK 240	WTB Binder Labortechnik GmbH	05-79022	480462	25/04/2012	04/2014
62	Spectrum analyser	FSW43	Rohde & Schwarz	100586	481720	10/09/2013	09/2015

8 List of annexes

ANNEX A	Photographs of the test set-ups:	5 pages
	Test set-up conducted emissions	13411xa.jpg
	Test set-up conducted emissions	134117m.jpg
	Test set-up preliminary radiated emissions (E-Field)	134117a.jpg
	Test set-up preliminary radiated emissions (E-Field)	134117b.jpg
	Test set-up preliminary radiated emissions (H-Field)	134117d.jpg
	Test set-up preliminary radiated emissions (H-Field)	134117e.jpg
	Test set-up final radiated emissions (E-Field)	134117k.jpg
	Test set-up final radiated emissions (E-Field)	134117l.jpg
	Test set-up outdoor test site	134117n.jpg
	Test set-up outdoor test site	134117o.jpg
	Test set-up climatic chamber	134117q.jpg
ANNEX B	External photographs of the test sample:	3 pages
	IQH1-18GM-V1, 3-D front view	134117eut1.jpg
	IQH1-18GM-V1, 3-D rear view	134117eut2.jpg
	IQH1-18GM-V1, Type plate	134117eut3.jpg
	Identcontrol, Type plate	13411xb.jpg
	TAG, Type plate	13411xd.jpg
ANNEX C	Internal photographs of the test sample:	2 pages
	PCB top view modified with antenna termination	13411xeut1.jpg
	PCB bottom view modified with antenna termination	13411xeut2.jpg
	PCB top view	134117pcb1.jpg
	PCB bottom view	134117pcb2.jpg
ANNEX D	Additional measurement results for industry Canada:	2 pages