



MEASUREMENT REPORT (Class II Change) FCC PART 15.247 Bluetooth

FCC ID: IR5RK12
APPLICANT: MilDef Crete Inc.
Application Type: Certification
Product: Intel® Dual Band Wireless-AC 8265
Model No.: 8265NGW
FCC Classification: (DSS) FCC Part 15 Spread Spectrum Transmitter
FCC Rule Part(s): Part 15.247
Test Procedure(s): ANSI C63.10-2013, DA 00-705
Test Date: July 27~ August 27, 2018

Tested By : *Peter Syu*

(Peter Syu)

Reviewed By : *Paddy Chen*

(Paddy Chen)

Approved By : *Chenz Ker*

(Chenz Ker)



The test results only relate to the tested sample.

This equipment has been shown to be capable of compliance with the applicable technical standards as indicated in the measurement report and was tested in accordance with the measurement procedures specified in ANSI C63.4-2014. Test results reported herein relate only to the item(s) tested.

The test report shall not be reproduced except in full without the written approval of MRT Technology (Taiwan) Co., Ltd.

Revision History

Report No.	Version	Description	Issue Date	Note
1807TW5601-U2	1.0	Original Report	2018-09-19	

CONTENTS

Description	Page
1. INTRODUCTION	7
1.1. Scope	7
1.2. MRT Test Location	7
2. PRODUCT INFORMATION	8
2.1. Equipment Description	8
2.2. Product Specification Subjective to this Standard	9
2.3. Test Mode	9
2.4. Operation Frequency / Channel List	10
2.5. Test Configuration	11
2.6. Test Software	11
2.7. EMI Suppression Device(s)/Modifications	11
2.8. Labeling Requirements	11
3. DESCRIPTION of TEST	12
3.1. Evaluation Procedure	12
3.2. AC Line Conducted Emissions	12
3.3. Radiated Emissions	13
4. ANTENNA REQUIREMENTS	14
5. TEST EQUIPMENT CALIBRATION DATE	15
6. MEASUREMENT UNCERTAINTY	16
7. TEST RESULT	17
7.1. Summary	17
7.2. 20dB Bandwidth Measurement	18
7.2.1. Test Limit	18
7.2.2. Test Procedure used	18
7.2.3. Test Setting	18
7.2.4. Test Setup	18
7.2.5. Test Result	19
7.3. Output Power Measurement	20
7.3.1. Test Limit	20
7.3.2. Test Procedure Used	20
7.3.3. Test Setting	21

7.3.4.	Test Setup	21
7.3.5.	Test Result.....	22
7.4.	Carrier Frequency Separation Measurement	23
7.4.1.	Test Limit	23
7.4.2.	Test Procedure Used	23
7.4.3.	Test Setting.....	23
7.4.4.	Test Setup	23
7.4.5.	Test Result.....	24
7.5.	Number of Hopping Channels Measurement	25
7.5.1.	Test Limit	25
7.5.2.	Test Procedure Used	25
7.5.3.	Test Setting.....	25
7.5.4.	Test Setup	25
7.5.5.	Test Result.....	26
7.6.	Time of Occupancy Measurement	27
7.6.1.	Test Limit	27
7.6.2.	Test Procedure Used	27
7.6.3.	Test Setting.....	27
7.6.4.	Test Setup	27
7.6.5.	Test Result.....	28
7.7.	Out-of-Band Spurious Emissions Emissions Measurement	29
7.7.1.	Test Limit	29
7.7.2.	Test Procedure Used	29
7.7.3.	Test Setting.....	30
7.7.4.	Test Setup	30
7.7.5.	Test Result.....	31
7.8.	Radiated Spurious Emission Measurement	32
7.8.1.	Test Limit	32
7.8.2.	Test Procedure Used	32
7.8.3.	Test Setting.....	32
7.8.4.	Test Setup	34
7.8.5.	Test Result.....	36
7.9.	Radiated Restricted Band Edge Measurement	50
7.9.1.	Test Limit	50
7.9.2.	Test Procedure Used	50
7.9.3.	Test Setting.....	50
7.9.4.	Test Setup	52
7.9.5.	Test Result.....	53

7.10. AC Conducted Emissions Measurement	63
7.10.1. Test Limit	63
7.10.2. Test Setup	63
7.10.3. Test Result.....	64
8. CONCLUSION	66

§2.1033 General Information

Applicant	MilDef Crete Inc.
Applicant Address	7F, No. 250, Sec 3, Pei Shen Rd, Shen Keng District, New Taipei City, Taiwan (R.O.C.)
Manufacturer	MilDef Crete Inc.
Manufacturer Address	7F, No. 250, Sec 3, Pei Shen Rd, Shen Keng District, New Taipei City, Taiwan (R.O.C.)
Test Site	MRT Technology (Taiwan) Co., Ltd
Test Site Address	No. 38, Fuxing Second Rd., Guishan Dist., Taoyuan City 333, Taiwan (R.O.C)
MRT FCC Registration No.	291082
FCC Rule Part(s)	Part 15.247
Model No.	8265NGW
Test Device Serial No.	N/A <input type="checkbox"/> Production <input checked="" type="checkbox"/> Pre-Production <input type="checkbox"/> Engineering

Test Facility / Accreditations

1. MRT facility is a FCC registered (Reg. No. 291082) test facility with the site description report on file and is designated by the FCC as an Accredited Test Film.
2. MRT facility is an IC registered (MRT Reg. No. 21723) test laboratory with the site description on file at Industry Canada.
3. MRT Lab is accredited to ISO 17025 by the Taiwan Accreditation Foundation (TAF Cert. No. 3261) in EMC, Telecommunications and Radio testing for FCC (Designation Number: TW3261), Industry Taiwan, EU and TELEC Rules.

1. INTRODUCTION

1.1. Scope

Measurement and determination of electromagnetic emissions (EMC) of radio frequency devices including intentional and/or unintentional radiators for compliance with the technical rules and regulations of the Federal Communications Commission and the Industry Canada Certification and Engineering Bureau.

1.2. MRT Test Location

The map below shows the location of the MRT LABORATORY, its proximity to the Taoyuan City. These measurement tests were conducted at the MRT Technology (Taiwan) Co., Ltd. Facility located at No.38, Fuxing 2nd Rd., Guishan Dist., Taoyuan City 33377, Taiwan (R.O.C).

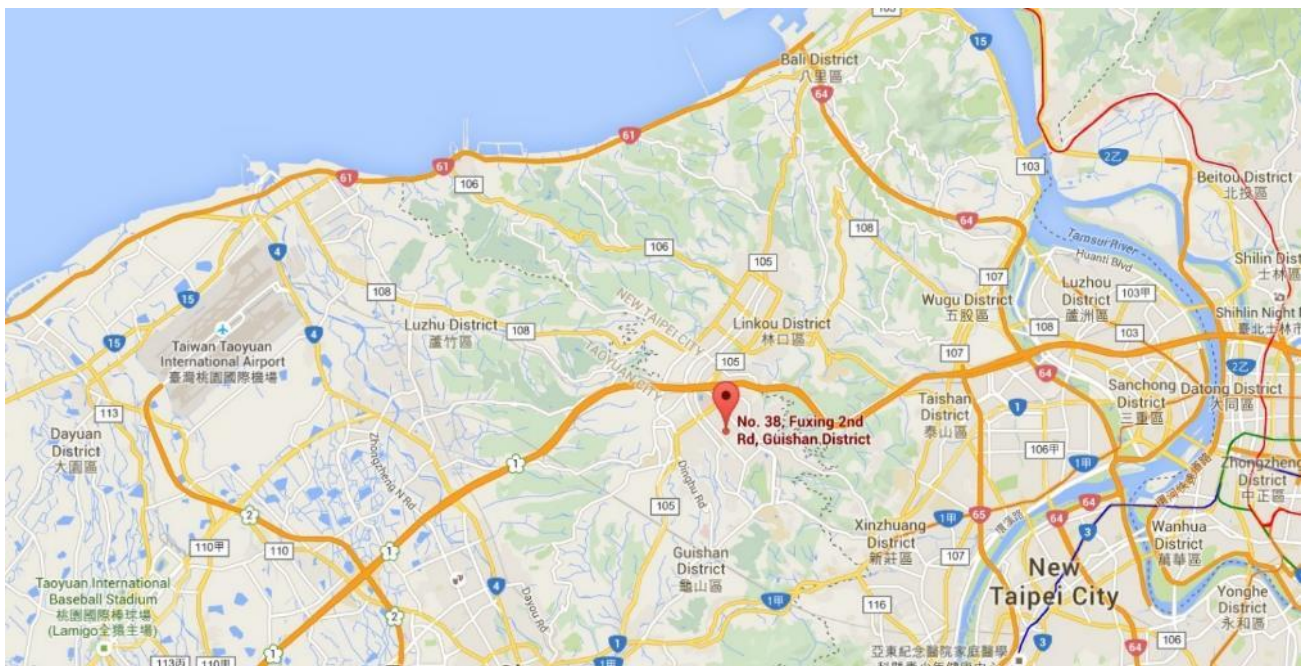

2. PRODUCT INFORMATION

2.1. Equipment Description

Product Name	Intel® Dual Band Wireless-AC 8265
Model No.	8265NGW
Supports Radios Spec.	WLAN: 2.4G: 802.11b/g/n-20/n-40; 5G: 802.11a/n-20/ac-20/n-40/ac-40/ac-80, Band 1,4 Bluetooth Dual Mode: V2.1+EDR/ V4.2 LE
Bluetooth Specification	Dual Mode; V2.1+EDR/ V4.2 LE
Maximum Output Power	10.314dBm
Adapter	MRF: ADAPTER TECH. Model No: ATS090-P190 Input: AC 100-240V~1.2A, 50-60Hz Output: DC 19V, 4.74A DC Cable Output: Non-Shielding, 1.5m with Core*1

Note: This case is to update the motherboard, so the C2PC (Radiated Spurious Emission, Conducted Output Power, AC Conducted Emissions Measurement) is executed. (Original Grant Date: 2018/9/20, FCC ID: IR5RK12)

2.2. Product Specification Subjective to this Standard

Operating Frequency	2402~2480MHz
Type of modulation	FHSS (GFSK, $\pi/4$ DQPSK, 8DPSK)
Data Rate	1Mbps (GFSK), 2Mbps ($\pi/4$ DQPSK), 3Mbps (8DPSK)

2.3. Test Mode

Test Mode	Mode 1: Transmit - 1Mbps (GFSK) Mode 2: Transmit - 3Mbps (8DPSK)
-----------	---

Note:

1. Regarding to the operation frequency, the lowest, middle and highest frequency are selected to perform the test.
2. Bluetooth operation was evaluated at both 1Mbps and 3Mbps data rates. Through pre-testing 2Mbps data rate was found, to produce emissions like those for 3Mbps.

2.4. Operation Frequency / Channel List

Channel	Frequency	Channel	Frequency	Channel	Frequency
00	2402 MHz	01	2403 MHz	02	2404 MHz
03	2405 MHz	04	2406 MHz	05	2407 MHz
06	2408 MHz	07	2409 MHz	08	2410 MHz
09	2411 MHz	10	2412 MHz	11	2413 MHz
12	2414 MHz	13	2415 MHz	14	2416 MHz
15	2417 MHz	16	2418 MHz	17	2419 MHz
18	2420 MHz	19	2421 MHz	20	2422 MHz
21	2423 MHz	22	2424 MHz	23	2425 MHz
24	2426 MHz	25	2427 MHz	26	2428 MHz
27	2429 MHz	28	2430 MHz	29	2431 MHz
30	2432 MHz	31	2433 MHz	32	2434 MHz
33	2435 MHz	34	2436 MHz	35	2437 MHz
36	2438 MHz	37	2439 MHz	38	2440 MHz
39	2441 MHz	40	2442 MHz	41	2443 MHz
42	2444 MHz	43	2445 MHz	44	2446 MHz
45	2447 MHz	46	2448 MHz	47	2449 MHz
48	2450 MHz	49	2451 MHz	50	2452 MHz
51	2453 MHz	52	2454 MHz	53	2455 MHz
54	2456 MHz	55	2457 MHz	56	2458 MHz
57	2459 MHz	58	2460 MHz	59	2461 MHz
60	2462 MHz	61	2463 MHz	62	2464 MHz
63	2465 MHz	64	2466 MHz	65	2467 MHz
66	2468 MHz	67	2469 MHz	68	2470 MHz
69	2471 MHz	70	2472 MHz	71	2473 MHz
72	2474 MHz	73	2475 MHz	74	2476 MHz
75	2477 MHz	76	2478 MHz	77	2479 MHz
78	2480 MHz	N/A	N/A	N/A	N/A

2.5. Test Configuration

This device was tested per the guidance of ANSI C63.10-2013 and DA 00-705. ANSI C63.10-2013 was used to reference the appropriate EUT setup for radiated spurious emissions testing and AC line conducted testing.

2.6. Test Software

The test utility software used during testing was “DRTU”.

2.7. EMI Suppression Device(s)/Modifications

No EMI suppression device(s) were added and/or no modifications were made during testing.

2.8. Labeling Requirements

Per 2.1074 & 15.19; Docket 95-19

The label shall be permanently affixed at a conspicuous location on the device; instruction manual or pamphlet supplied to the user and be readily visible to the purchaser at the time of purchase. However, when the device is so small wherein placement of the label with specified statement is not practical, only the FCC ID must be displayed on the device per Section 15.19(a)(5). Please see attachment for FCC ID label and label location.

3. DESCRIPTION of TEST

3.1. Evaluation Procedure

The measurement procedures described in the American National Standard for Testing Unlicensed Wireless Devices (ANSI C63.10-2013) were used in the measurement of the **Intel® Dual Band Wireless-AC 8265**.

Deviation from measurement procedure.....None

3.2. AC Line Conducted Emissions

The line-conducted facility is located inside an 9'x4'x3' shielded enclosure. A 1m x 2m wooden table 80cm high is placed 40cm away from the vertical wall and 80cm away from the sidewall of the shielded room. Two 10kHz-30MHz, 50Ω/50uH Line-Impedance Stabilization Networks (LISNs) are bonded to the shielded room floor. Power to the LISNs is filtered by external high-current high-insertion loss power line filters. These filters attenuate ambient signal noise from entering the measurement lines. These filters are also bonded to the shielded enclosure.

The EUT is powered from one LISN and the support equipment is powered from the second LISN. All interconnecting cables more than 1 meter were shortened to a 1 meter length by non-inductive bundling (serpentine fashion) and draped over the back edge of the test table. All cables were at least 40cm above the horizontal reference ground-plane. Power cables for support equipment were routed down to the second LISN while ensuring that that cables were not draped over the second LISN.

Sufficient time for the EUT, support equipment, and test equipment was allowed in order for them to warm up to their normal operating condition. The RF output of the LISN was connected to the receiver and exploratory measurements were made to determine the frequencies producing the maximum emission from the EUT. The receiver was scanned from 150kHz to 30MHz. The detector function was set to peak mode for exploratory measurements while the bandwidth of the analyzer was set to 9kHz. The EUT, support equipment, and interconnecting cables were arranged and manipulated to maximize each emission. Each emission was also maximized by varying: power lines, the mode of operation or data exchange speed, or support equipment whichever determined the worst-case emission. Once the worst case emissions have been identified, the one EUT cable configuration/arrangement and mode of operation that produced these emissions were used for final measurements on the same test site. The analyzer is set to CISPR quasi-peak and average detectors with a 9kHz resolution bandwidth for final measurements.

An extension cord was used to connect to a single LISN which powered by EUT. The extension cord was calibrated with LISN, the impedance and insertion loss are compliance with the requirements as stated in ANSI C63.10-2013.

Line conducted emissions test results are shown in Section 7.10.

3.3. Radiated Emissions

The radiated test facilities consisted of an indoor 3 meter semi-anechoic chamber used for final measurements and exploratory measurements, when necessary. The measurement area is contained within the semi-anechoic chamber which is shielded from any ambient interference. For measurements above 1GHz absorbers are arranged on the floor between the turn table and the antenna mast in such a way so as to maximize the reduction of reflections. For measurements below 1GHz, the absorbers are removed. An MF Model 210SS turntable is used for radiated measurement. It is a continuously rotatable, remote controlled, metallic turntable and 2 meters (6.56 ft.) in diameter. The turn table is flush with the raised floor of the chamber in order to maintain its function as a ground plane. An 80cm high PVC support structure is placed on top of the turntable. For all measurements, the spectrum was scanned through all EUT azimuths and from 1 to 4 meter receive antenna height using a broadband antenna from 30MHz up to the upper frequency shown in 15.33(b)(1) depending on the highest frequency generated or used in the device or on which the device operates or tunes. For frequencies above 1GHz, linearly polarized double ridge horn antennas were used. For frequencies below 30MHz, a calibrated loop antenna was used. When exploratory measurements were necessary, they were performed at 1 meter test distance inside the semi-anechoic chamber using broadband antennas, broadband amplifiers, and spectrum analyzers to determine the frequencies and modes producing the maximum emissions. Sufficient time for the EUT, support equipment, and test equipment was allowed in order for them to warm up to their normal operating condition. The test set-up for frequencies below 1GHz was placed on top of the 0.8 meter high, 1 x 1.5 meter table; and test set-up for frequencies 1-40GHz was placed on top of the 1.5 meter high, 1 x 1.5 meter table. The EUT, support equipment, and interconnecting cables were arranged and manipulated to maximize each emission. Appropriate precaution was taken to ensure that all emissions from the EUT were maximized and investigated. The system configuration, clock speed, mode of operation or video resolution, if applicable, turntable azimuth, and receive antenna height was noted for each frequency found.

Final measurements were made in the semi-anechoic chamber using calibrated, linearly polarized broadband and horn antennas. The test setup was configured to the setup that produced the worst case emissions. The spectrum analyzer was set to investigate all frequencies required for testing to compare the highest radiated disturbances with respect to the specified limits. The turntable containing the EUT was rotated through 360 degrees and the height of the receive antenna was varied 1 to 4 meters and stopped at the azimuth and height producing the maximum emission. Each emission was maximized by changing the orientation of the EUT through three orthogonal planes and changing the polarity of the receive antenna, whichever produced the worst-case emissions. According to 3dB Beamwidth of horn antenna, the horn antenna should be always directed to the EUT when rising height.

Radiated emissions test results are shown in Section 7.8 & 7.9

4. ANTENNA REQUIREMENTS

Excerpt from §15.203 of the FCC Rules/Regulations:

“An intentional radiator antenna shall be designed to ensure that no antenna other than that furnished by the responsible party can be used with the device. The use of a permanently attached antenna or of an antenna that uses a unique coupling to the intentional radiator shall be considered sufficient to comply with the provisions of this section.”

- The antenna of the Intel® Dual Band Wireless-AC 8265, is permanently attached.
- There are no provisions for connection to an external antenna.

Conclusion:

The EUT unit complies with the requirement of §15.203.

Antenna List

No.	Manufacturer	Part No.	Antenna Type	Peak Gain
1	Maoxun Computer Co., Ltd.	PK12	PIFA	0.49dBi

5. TEST EQUIPMENT CALIBRATION DATE

Conducted Emissions – SR2

Instrument	Manufacturer	Type No.	Asset No.	Cali. Interval	Cali. Due Date
Two-Line V-Network	R&S	ENV216	MRTTWA00019	1 year	2019/3/20
Cable	Rosnol	N1C50-RG400- B1C50-500CM	MRTTWE00013	1 year	2019/5/18
EMI Test Receiver	R&S	ESR3	MRTTWA00009	1 year	2019/3/19

Radiated Emissions – AC1

Instrument	Manufacturer	Type No.	Asset No.	Cali. Interval	Cali. Due Date
Broadband TRILOG Antenna	SCHWARZBECK	VULB 9162	MRTTWA00001	1 year	2019/5/22
EMI Test Receiver	R&S	ESR3	MRTTWA00009	1 year	2019/3/19
Active Loop Antenna	Schwarzbeck	FMZB 1519B	MRTTWA00002	1 year	2019/4/24
Broadband Horn antenna	SCHWARZBECK	BBHA 9120D	MRTTWA00003	1 year	2019/4/24
Breitband Hornantenna	Schwarzbeck	BBHA 9170	MRTTWA00004	1 year	2019/4/23
Broadband Amplifier	Schwarzbeck	BBV 9721	MRTTWA00006	1 year	2019/4/23
Broadband Preamplifier	SCHWARZBECK	BBV 9718	MRTTWA00005	1 year	2019/4/23
Cable	HUBERSUHNER	SF106	MRTTWA00010	1 year	2019/5/18
Cable	Rosnol	K1K50-UP0264- K1K50-4M	MRTTWA00012	1 year	2019/7/30

Conducted Test Equipment – SR2

Instrument	Manufacturer	Type No.	Asset No.	Cali. Interval	Cali. Due Date
Spectrum Analyzer	KEYSIGHT	N9010A	MRTTWA00012	1 year	2019/7/30
USB Wideband Power Sensor	KEYSIGHT	U2021XA	MRTTWA00015	1 year	2019/3/20

Test Software

Software	Version	Function
e3	9.160520a	EMI Test Software
EMI	V3	EMI Test Software

6. MEASUREMENT UNCERTAINTY

Where relevant, the following test uncertainty levels have been estimated for tests performed on the EUT as specified in CISPR 16-4-2. This uncertainty represents an expanded uncertainty expressed at approximately the 95% confidence level using a coverage factor of $k = 2$.

AC Conducted Emission Measurement – SR2
Measuring Uncertainty for a Level of Confidence of 95% ($U=2Uc(y)$): 150kHz~30MHz: 2.42dB
Conducted Measurement– SR1
Measuring Uncertainty for a Level of Confidence of 95% ($U=2Uc(y)$): 1.3dB
Radiated Emission Measurement – AC1
Measuring Uncertainty for a Level of Confidence of 95% ($U=2Uc(y)$): Horizontal: 9K~30MHz: 4.14dB 30MHz~1GHz: 4.22dB 1GHz~40GHz: 4.05dB Vertical: 9K~30MHz: 4.14dB 30MHz~1GHz: 3.37dB 1GHz~40GHz: 4.08dB

7. TEST RESULT

7.1. Summary

Product Name: Intel® Dual Band Wireless-AC 8265
FCC Classification: (DSS) FCC Part 15 Spread Spectrum Transmitter

FCC Part Section(s)	Test Description	Test Limit	Test Condition	Test Result	Reference
15.247(a)(1)	20dB Bandwidth	N/A	Conducted	N/A	N/A
15.247(b)(1)	Output Power	<1 Watt if > 75 non-overlapping channels used		PASS	Section 7.3
15.247(a)(1)	Carrier Frequency Separation	25KHz or 2/3 of 20 dB BW for systems with Output Power < 125mW		N/A	N/A
15.247(a)(1)(iii)	Number of Hopping Channels	> 15 Channels		N/A	N/A
15.247(a)(1)(iii)	Time of Occupancy	< 0.4 sec in 31.6 sec period		N/A	N/A
15.247(d)	Out-of-Band Emissions	Conducted \geq 20dBc		N/A	N/A
15.205 15.209	Spurious Emission	< FCC 15.209 limits	Radiated	PASS	Section 7.8
15.205 15.209	Band Edge Measurement	\leq 74dBuV/m(Peak) \leq 54dBuV/m(Average)		PASS	Section 7.9
15.207	AC Conducted Emissions 150kHz - 30MHz	< FCC 15.207 limits	Line Conducted	PASS	Section 7.10

Note:

- 1) All modes of operation and data rates were investigated. For radiated emission test, every axis (X, Y, Z) was also verified. The test results shown in the following sections represent the worst case emissions.
- 2) The analyzer plots shown in this section were all taken with a correction table loaded into the analyzer. The correction table was used to account for the losses of the cables and attenuators used as part of the system to connect the EUT to the analyzer at all frequencies of interest.
- 3) All antenna port conducted emissions testing was performed on a test bench with the antenna port of the EUT connected to the spectrum analyzer through calibrated cables and attenuators.

7.2. 20dB Bandwidth Measurement

7.2.1. Test Limit

N/A

7.2.2. Test Procedure used

ANSI C63.10-2013 - Section 6.9.2

7.2.3. Test Setting

1. Set RBW $\geq 1\%$ of the 20dB bandwidth
2. VBW $\geq 3 \times$ RBW
3. Span = approximately 2 to 5 times the 20dB bandwidth, centered on a hopping channel
4. Detector = Peak
5. Trace mode = max hold
6. Sweep = auto couple
7. Allow the trace to stabilize
8. Measure the maximum width of the emission that is constrained by the frequencies associated with the two outermost amplitude points (upper and lower frequencies) that are attenuated by 20 dB relative to the maximum level measured in the fundamental emission.

7.2.4. Test Setup

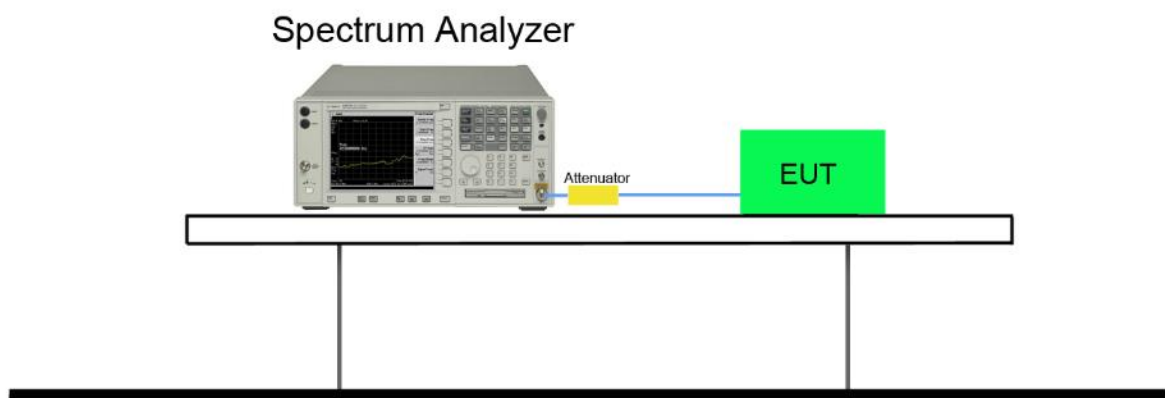

7.2.5. Test Result

Note: Refer to Original Report, Grant Date: 2018/9/20, FCC ID: IR5RK12.

7.3. Output Power Measurement

7.3.1. Test Limit

The maximum out power permissible output power is 1 Watt for all other frequency hopping systems operating in the 2400-2483.5 MHz band employing at least 75 non-overlapping hopping channels.

For FHSs operating in the band 2400-2483.5 MHz, the maximum peak conducted output power shall not exceed 1.0 W and the e.i.r.p. shall not exceed 4 W if the hopset uses 75 or more hopping channels.

7.3.2. Test Procedure Used

ANSI C63.10-2013 - Section 7.8.5

7.3.3. Test Setting

1. Set RBW \geq the 20 dB bandwidth of the emission being measured.
2. VBW $\geq 3 \times$ RBW
3. Span = approximately 2 to 3 times the 20dB bandwidth, centered on a hopping channel
4. Detector = Peak
5. Trace mode = max hold
6. Sweep = auto couple
7. Allow the trace to stabilize, Use the marker-to-peak function to set the marker to the peak of the emission. The indicated level is the peak output power (don't forget added the external attenuation and cable loss)
8. Note: A peak responding power meter may be used, where the power meter and sensor system video bandwidth is greater than the occupied bandwidth of the unlicensed wireless device, rather than a spectrum analyzer.

7.3.4. Test Setup

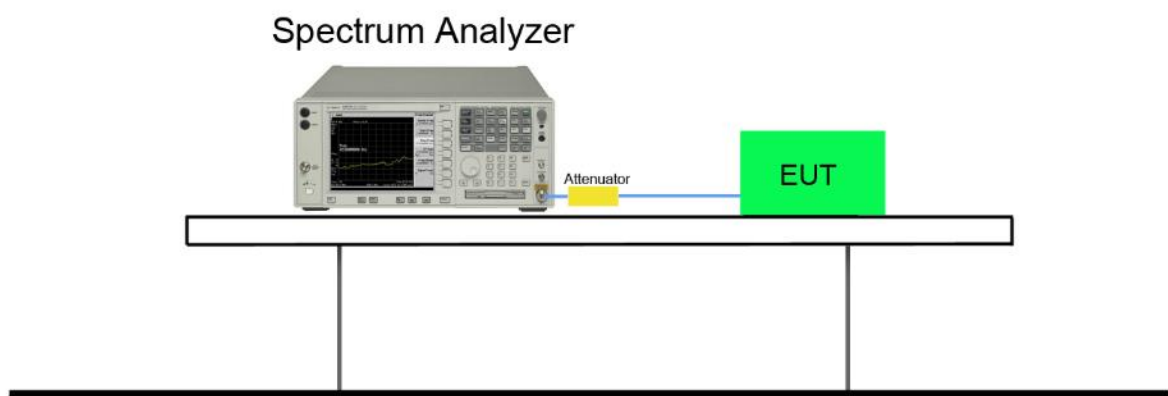

7.3.5. Test Result

Test Mode	Channel No.	Frequency (MHz)	Peak Power (dBm)	EIRP (dBm)	Peak Power Limit (dBm)	EIRP Limit (dBm)
DH5	00	2402	11.13	11.62	< 30	< 36
DH5	39	2441	11.38	11.87	< 30	< 36
DH5	78	2480	11.49	11.98	< 30	< 36
2DH5	00	2402	10.87	11.36	< 30	< 36
2DH5	39	2441	11.08	11.57	< 30	< 36
2DH5	78	2480	11.15	11.64	< 30	< 36
3DH5	00	2402	10.59	11.08	< 30	< 36
3DH5	39	2441	10.77	11.26	< 30	< 36
3DH5	78	2480	10.92	11.41	< 30	< 36

Note:

1. The peak power of all test modes is less than 21dBm(125mW).
2. Peak Power Output Value =Reading value on power meter + cable loss

7.4. Carrier Frequency Separation Measurement

7.4.1. Test Limit

The minimum permissible channel separation for this system is 2/3 the value of the 20dB BW.

7.4.2. Test Procedure Used

ANSI C63.10-2013 - Section 7.8.2

7.4.3. Test Setting

1. Span = wide enough to capture the peaks of two adjacent channels.
2. RBW \geq 1 % of the span
3. VBW \geq RBW
4. Detector = peak
5. Sweep time = auto couple
6. Trace mode = max hold
7. Trace was allowed to stabilize

7.4.4. Test Setup

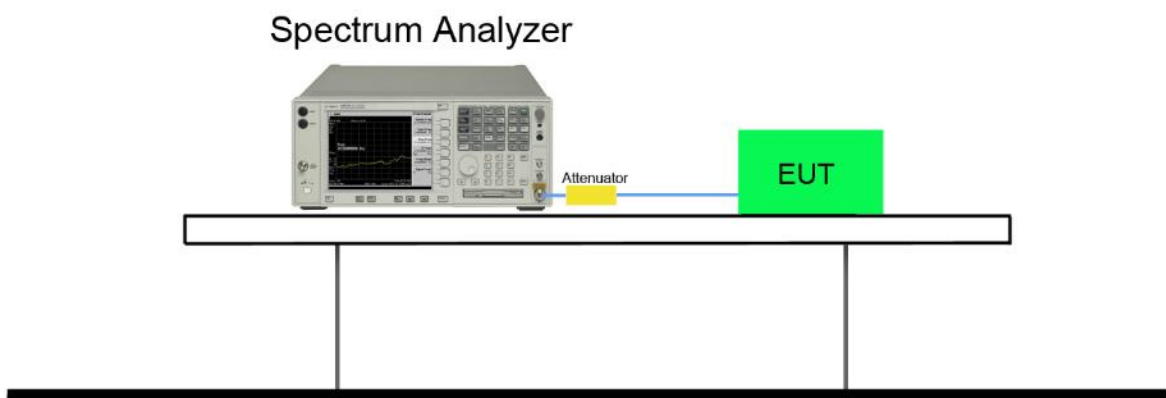

7.4.5. Test Result

Note: Refer to Original Report, Grant Date: 2018/9/20, FCC ID: IR5RK12.

7.5. Number of Hopping Channels Measurement

7.5.1. Test Limit

This frequency hopping system must employ a minimum of 15 hopping channels.

7.5.2. Test Procedure Used

ANSI C63.10-2013 - Section 7.8.3

7.5.3. Test Setting

1. Span = the frequency band of operation.
2. RBW \geq 1 % of the span
3. VBW \geq RBW
4. Detector = Peak
5. Trace mode = max hold
6. Sweep time = auto couple
7. The trace was allowed to stabilize

7.5.4. Test Setup

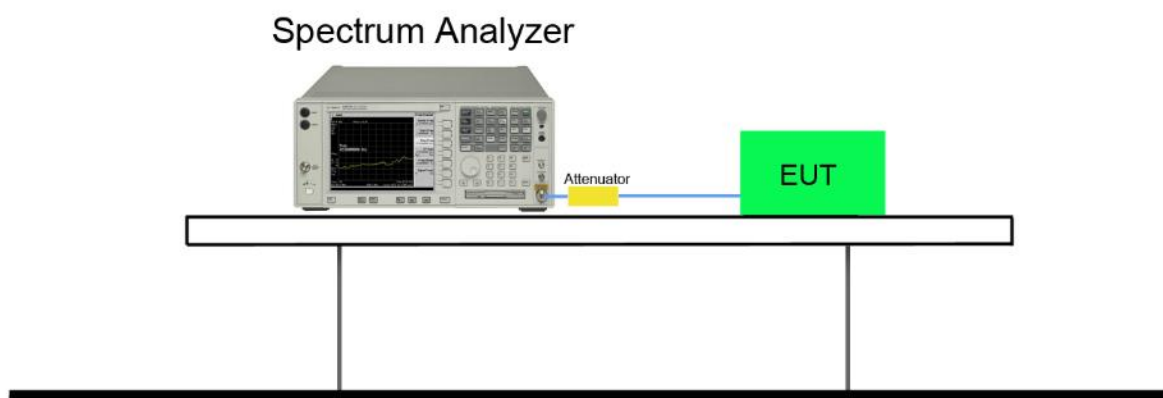

7.5.5. Test Result

Note: Refer to Original Report, Grant Date: 2018/9/20, FCC ID: IR5RK12.

7.6. Time of Occupancy Measurement

7.6.1. Test Limit

The maximum permissible time of occupancy is 400ms within a period of 400ms multiplied by the number of hopping channels employed.

7.6.2. Test Procedure Used

ANSI C63.10-2013 - Section 7.8.4

7.6.3. Test Setting

1. Span = zero span, centered on a hopping channel.
2. RBW = 1MHz
3. VBW \geq RBW
4. Sweep time = as necessary to capture the entire dwell time per hopping channel
5. Detector = Peak
6. Trace mode = max hold

If possible, use the marker-delta function to determine the dwell time. If this value varies with different modes of operation (data rate, modulation format, etc.), repeat this test for each variation. An oscilloscope may be used instead of a spectrum analyzer. The EUT shall show compliance with the appropriate regulatory limit for the number of hopping channels. A plot of the data shall be included in the test report.

7.6.4. Test Setup

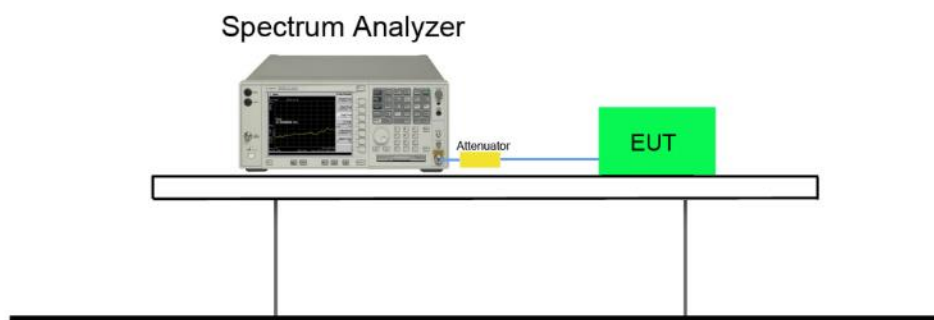

7.6.5. Test Result

Note: Refer to Original Report, Grant Date: 2018/9/20, FCC ID: IR5RK12.

7.7. Out-of-Band Spurious Emissions Emissions Measurement

7.7.1. Test Limit

In any 100 kHz bandwidth outside the frequency band in which the spread spectrum or digitally modulated intentional radiator is operating, the radio frequency power that is produced by the intentional radiator shall be at least 20 dB below that in the 100 kHz bandwidth within the band that contains the highest level of the desired power, based on either an RF conducted or a radiated measurement, provided the transmitter demonstrates compliance with the peak conducted or a radiated measurement, provided the transmitter demonstrates compliance with the peak conducted power limits. If the transmitter complies with the conducted power limits based on the use of RMS averaging over a time interval, the attenuation required under this paragraph shall be 30 dB instead of 20 dB.

7.7.2. Test Procedure Used

ANSI C63.10-2013 - Section 7.8.8

7.7.3. Test Setting

1. Span = wide enough to capture the peak level of the in-band emission and all spurious emissions (e.g., harmonics) from the lowest frequency generated in the EUT up through the 10th harmonic. Typically, several plots are required to cover this entire span.
2. RBW = 100 KHz
3. VBW \geq RBW
4. Detector = peak
5. Sweep time = auto couple
6. Trace mode = max hold
7. Trace was allowed to stabilize

Set the marker on the peak of any spurious emission recorded. The level displayed must comply with the limit specified in this section.

7.7.4. Test Setup

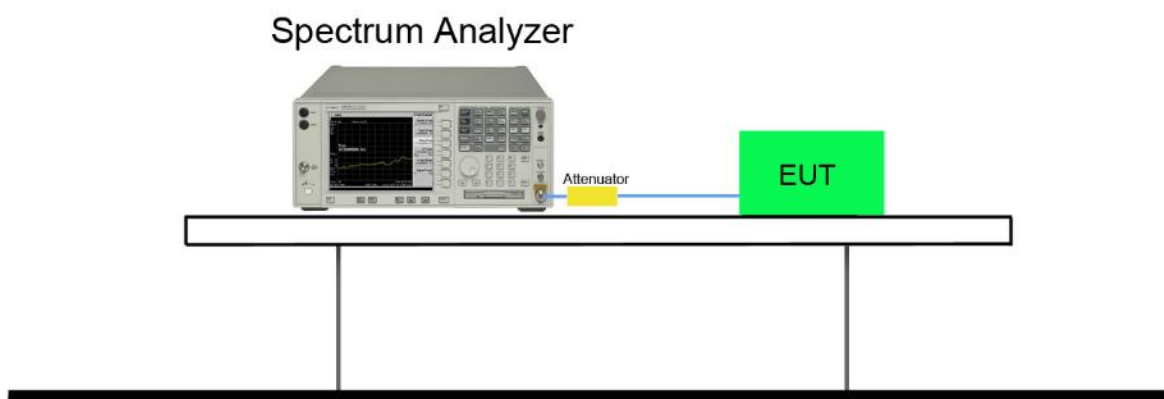

7.7.5. Test Result

Note: Refer to Original Report, Grant Date: 2018/9/20, FCC ID: IR5RK12.

7.8. Radiated Spurious Emission Measurement

7.8.1. Test Limit

All out of band emissions appearing in a restricted band as specified in Section 15.205 of the Title 47 CFR must not exceed the limits shown in Table per Section 15.209.

FCC Part 15 Subpart C Paragraph 15.209		
Frequency [MHz]	Field Strength [V/m]	Measured Distance [Meters]
0.009 - 0.490	2400/F (kHz)	300
0.490 - 1.705	24000/F (kHz)	30
1.705 – 30	30	30
30 – 88	100	3
88 – 216	150	3
216 – 960	200	3
Above 960	500	3

7.8.2. Test Procedure Used

ANSI C63.10-2013 - Section 11.12.1

7.8.3. Test Setting

Peak Field Strength Measurements

1. Analyzer center frequency was set to the frequency of the radiated spurious emission of interest
2. RBW = as specified in Table 1
3. VBW = 3 * RBW
4. Detector = peak
5. Sweep time = auto couple
6. Trace mode = max hold

- Trace was allowed to stabilize

Table 1 - RBW as a function of frequency

Frequency	RBW
9 ~ 150 kHz	200 ~ 300 Hz
0.15 ~ 30 MHz	9 ~ 10 kHz
30 ~ 1000 MHz	100 ~ 120 kHz
> 1000 MHz	1 MHz

Average Field Strength Measurements

- Analyzer center frequency was set to the frequency of the radiated spurious emission of interest
- RBW = 1MHz
- VBW $\geq 1/T$
- De As an alternative, the instrument may be set to linear detector mode. Ensure that video filtering is applied in linear voltage domain (rather than in a log or dB domain). Some instruments require linear display mode in order to accomplish this. Others have a setting for Average-VBW Type, which can be set to "Voltage" regardless of the display mode
- Detector = Peak
- Sweep time = auto
- Trace mode = max hold
- Allow max hold to run for at least 50 times (1/duty cycle) traces

7.8.4. Test Setup

9kHz ~ 30MHz Test Setup:

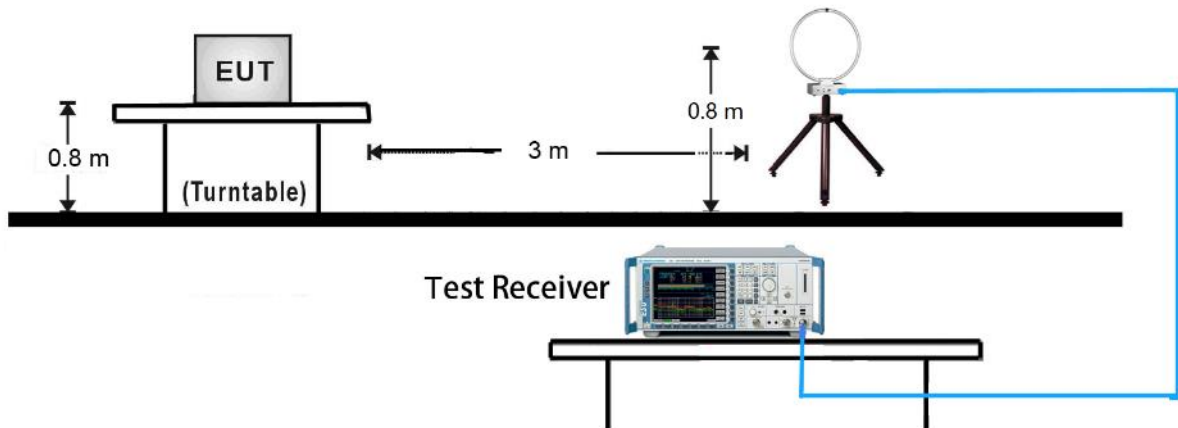

30MHz ~ 1GHz Test Setup:

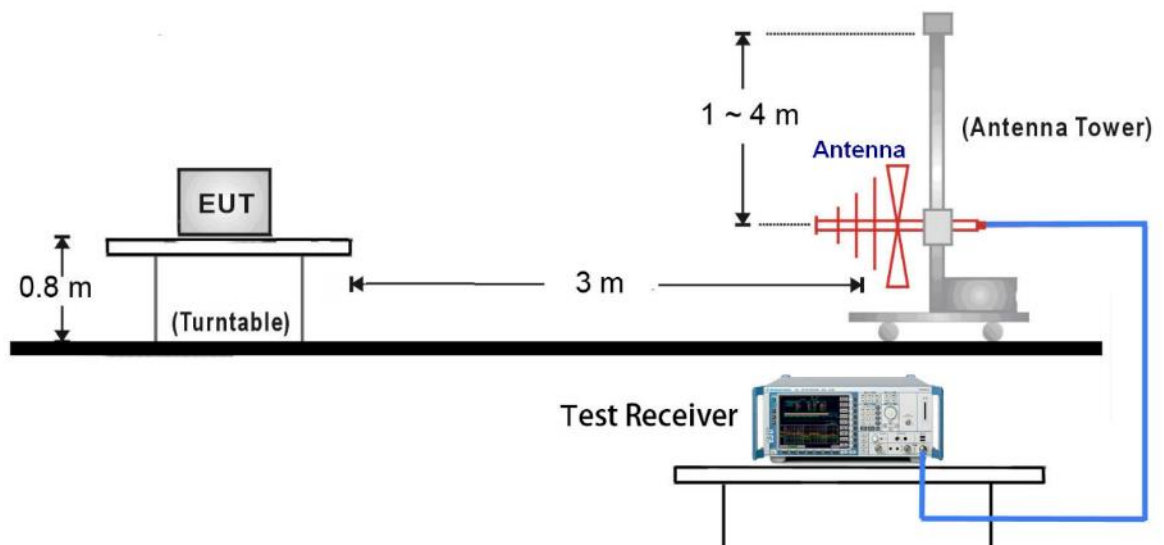

1GHz ~ 18GHz Test Setup:

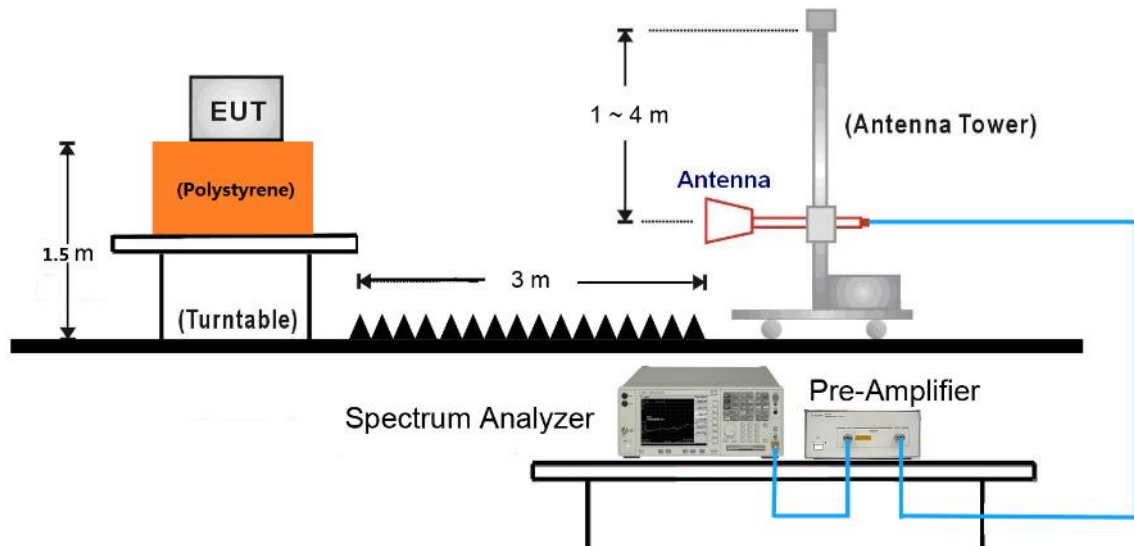

18GHz ~40GHz Test Setup:

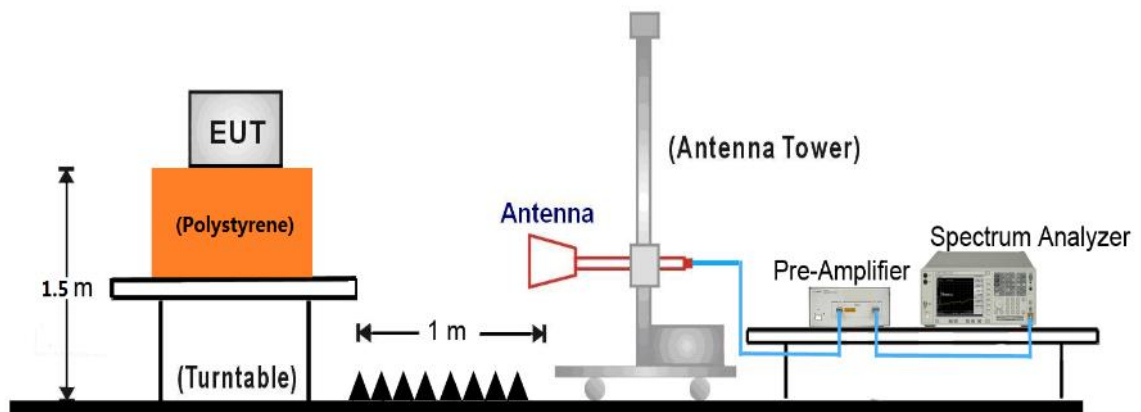

7.8.5. Test Result

EUT	Intel® Dual Band Wireless-AC 8265	Test Date	2018/8/2
Factor	VULB 9162 (30MHz~8GHz)	Temp. / Humidity	25°C / 60%
Polarity	Horizontal	Site / Engineer	AC1 / Peter
Test Mode	MODE1-DH5_CH39	Test Voltage	AC 120V/60Hz

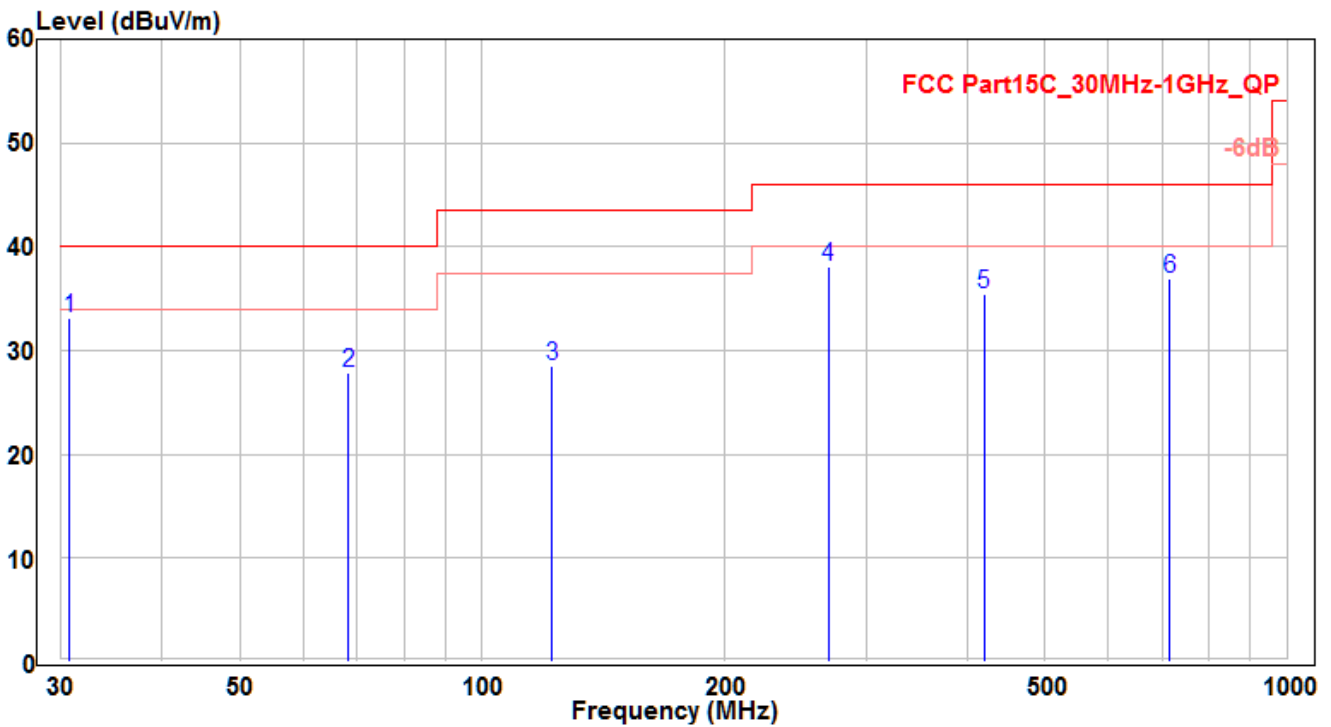

No		Frequency (MHz)	Reading (dBuV)	C.F (dB)	Measurement (dBuV/m)	Margin (dB)	Limit (dBuV/m)	Height (cm)	Angle (deg)	Remark (QP/PK/AV)
1	*	30.728	15.13	17.96	33.09	-6.91	40	185	145	QP
2		68.315	11.5	16.42	27.92	-12.08	40	100	250	QP
3		122.211	10.98	17.6	28.58	-14.92	43.5	185	190	QP
4		269.196	17.35	20.69	38.04	-7.96	46	145	-40	QP
5		420.183	11.32	24.17	35.49	-10.51	46	175	175	QP
6		714.759	7.56	29.43	36.99	-9.01	46	155	240	QP

Note:

1. " * " means this data is the worst emission level.
2. C.F (Correction Factor) = Antenna Factor (dB)+ Cable Loss (dB).
3. Measurement (dBuV/m) = Reading(dBuV) + C.F (Correction Factor).

EUT	Intel® Dual Band Wireless-AC 8265	Test Date	2018/8/2
Factor	VULB 9162 (30MHz~8GHz)	Temp. / Humidity	25°C / 60%
Polarity	Vertical	Site / Engineer	AC1 / Peter
Test Mode	MODE1- DH5_CH39	Test Voltage	AC 120V/60Hz

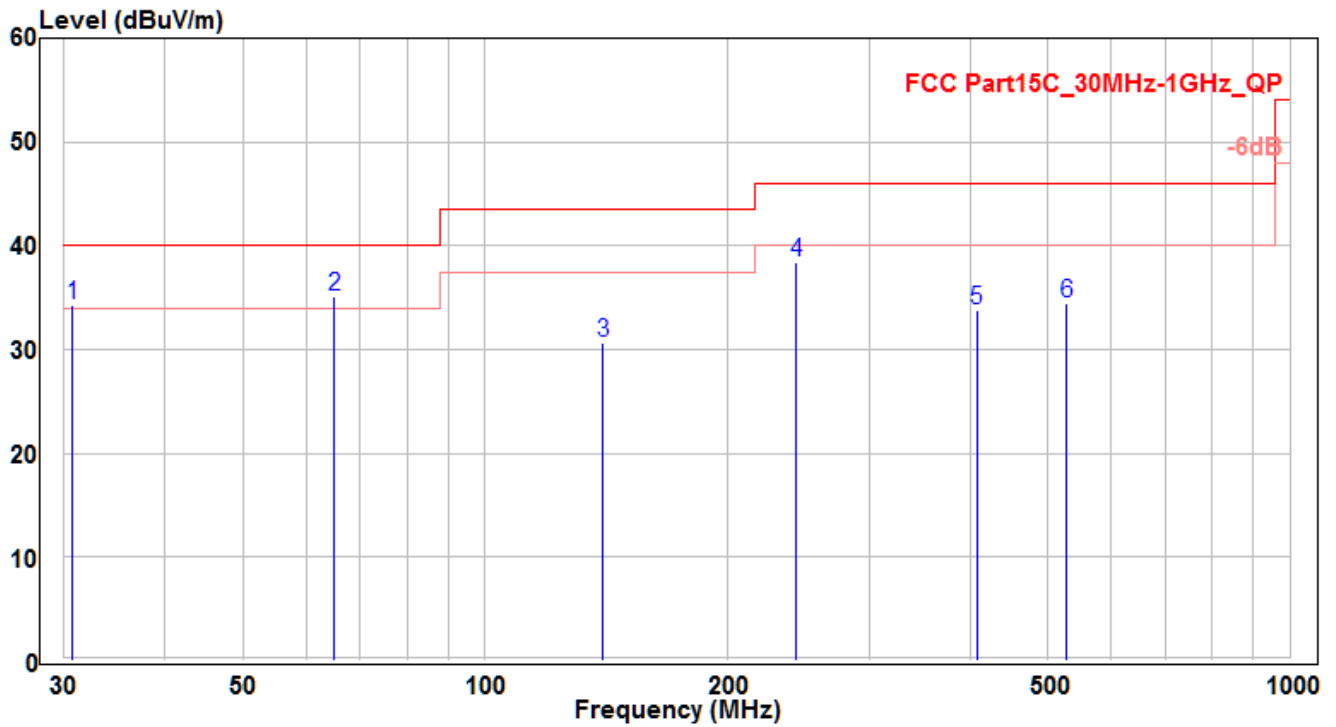

No	Frequency (MHz)	Reading (dBuV)	C.F (dB)	Measurement (dBuV/m)	Margin (dB)	Limit (dBuV/m)	Height (cm)	Angle (deg)	Remark (QP/PK/AV)
1	30.758	16.34	17.97	34.31	-5.69	40	150	250	QP
2	* 64.981	17.23	17.9	35.13	-4.87	40	115	200	QP
3	140.247	15.07	15.63	30.7	-12.8	43.5	190	60	QP
4	243.4	18.42	20.05	38.47	-7.53	46	150	-40	QP
5	408.058	9.78	24.04	33.82	-12.18	46	100	400	QP
6	528.004	8.14	26.29	34.43	-11.57	46	185	50	QP

Note:

1. " * " means this data is the worst emission level.
2. C.F (Correction Factor) = Antenna Factor (dB)+ Cable Loss (dB).
3. Measurement (dBuV/m) = Reading(dBuV) + C.F (Correction Factor).

EUT	Intel® Dual Band Wireless-AC 8265	Test Date	2018/8/27
Factor	BBHA 9120D (1GHz~18GHz)	Temp. / Humidity	25°C / 60%
Polarity	Horizontal	Site / Engineer	AC1 / Peter
Test Mode	MODE1-DH5_CH00	Test Voltage	AC 120V/60Hz

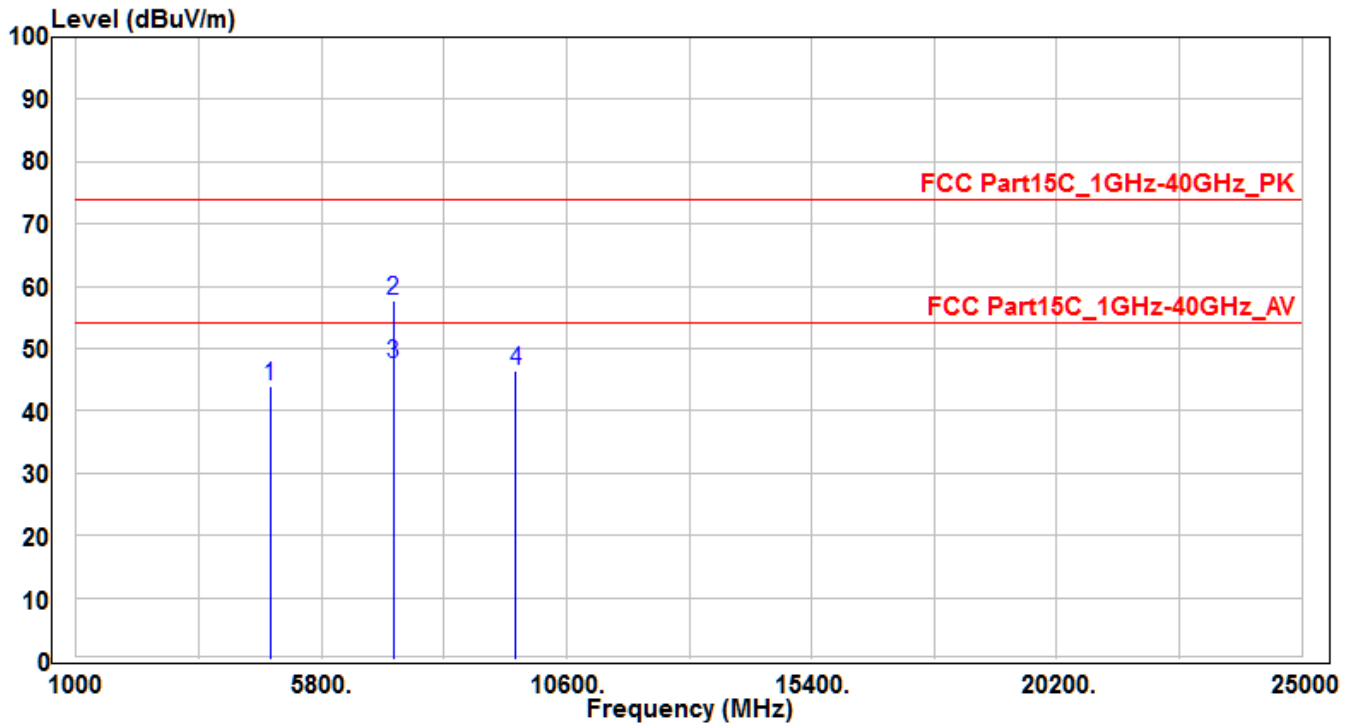

No	Frequency (MHz)	Reading (dBuV)	C.F (dB)	Measurement (dBuV/m)	Margin (dB)	Limit (dBuV/m)	Height (cm)	Angle (deg)	Remark (QP/PK/AV)	
1	4804	40.54	3.32	43.86	-30.14	74	150	400	Peak	
2	*	7206	45.75	11.88	57.63	-16.37	74	115	160	Peak
3	*	7206	35.58	11.88	47.46	-6.54	54	115	160	Average
4		9608	31.67	14.86	46.53	-27.47	74	150	400	Peak

Note:

- "*" means this data is the worst emission level.
- C.F (Correction Factor) = Antenna Factor (dB)+ Cable Loss (dB) – Pre-amplifier(dB).
- Measurement (dBuV/m) = Reading(dBuV) + C.F (Correction Factor).

EUT	Intel® Dual Band Wireless-AC 8265	Test Date	2018/8/27
Factor	BBHA 9120D (1GHz~18GHz)	Temp. / Humidity	25°C / 60%
Polarity	Vertical	Site / Engineer	AC1 / Peter
Test Mode	MODE1- DH5_CH00	Test Voltage	AC 120V/60Hz

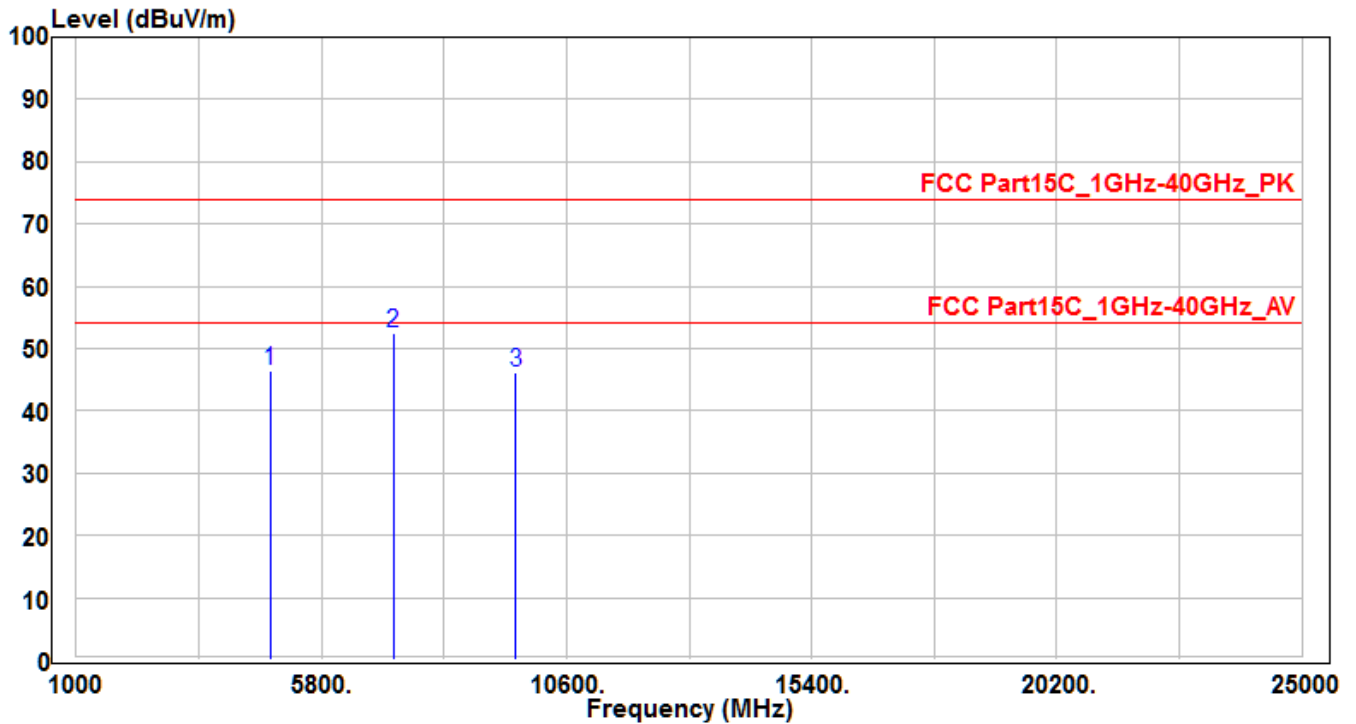

No	Frequency (MHz)	Reading (dBuV)	C.F (dB)	Measurement (dBuV/m)	Margin (dB)	Limit (dBuV/m)	Height (cm)	Angle (deg)	Remark (QP/PK/AV)
1	4804	43.14	3.32	46.46	-27.54	74	150	400	Peak
2	* 7206	40.62	11.88	52.5	-21.5	74	150	400	Peak
3	9608	31.25	14.86	46.11	-27.89	74	150	400	Peak

Note:

1. " * " means this data is the worst emission level.
2. C.F (Correction Factor) = Antenna Factor (dB)+ Cable Loss (dB) – Preamplifier(dB).
3. Measurement (dBuV/m) = Reading(dBuV) + C.F (Correction Factor).

EUT	Intel® Dual Band Wireless-AC 8265	Test Date	2018/8/27
Factor	BBHA 9120D (1GHz~18GHz)	Temp. / Humidity	25°C / 60%
Polarity	Horizontal	Site / Engineer	AC1 / Peter
Test Mode	MODE1- DH5_CH39	Test Voltage	AC 120V/60Hz

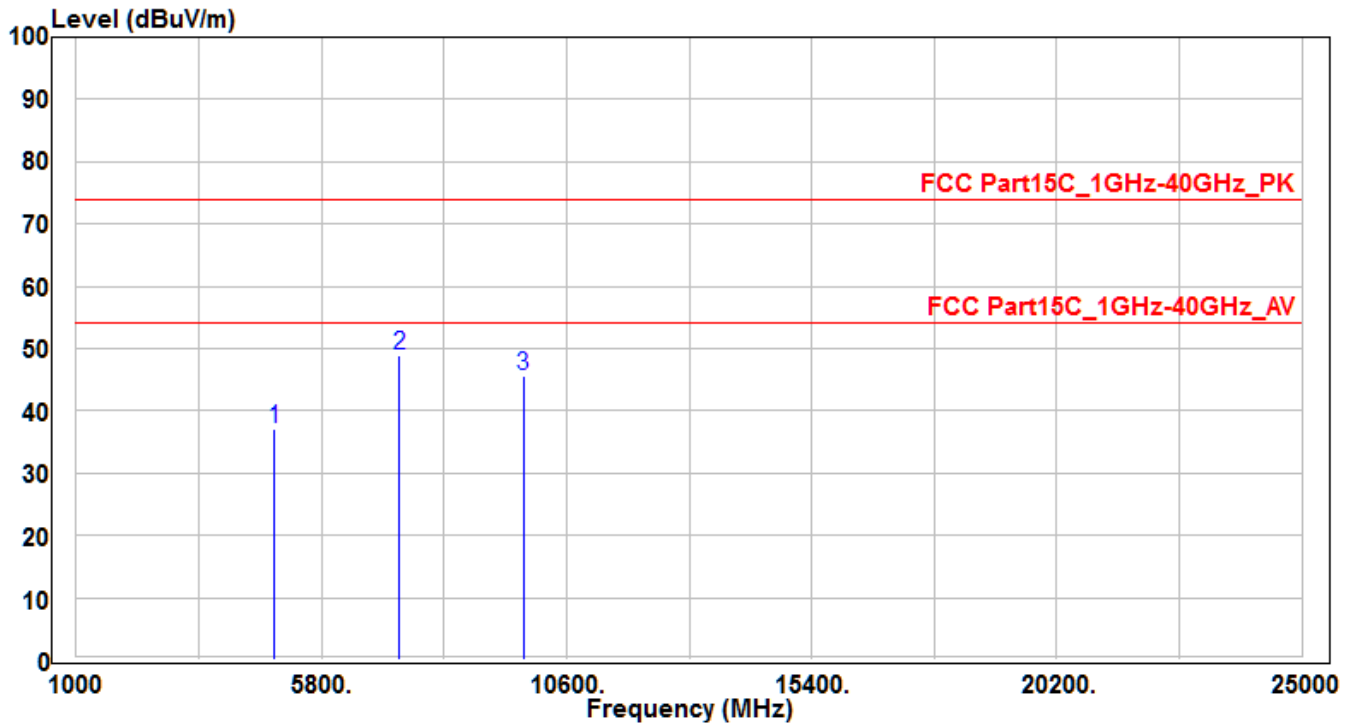

No	Frequency (MHz)	Reading (dBuV)	C.F (dB)	Measurement (dBuV/m)	Margin (dB)	Limit (dBuV/m)	Height (cm)	Angle (deg)	Remark (QP/PK/AV)
1	4882	33.61	3.49	37.1	-36.9	74	150	400	Peak
2	* 7323	36.82	12.22	49.04	-24.96	74	150	400	Peak
3	9764	30.36	15.23	45.59	-28.41	74	150	400	Peak

Note:

- "*" means this data is the worst emission level.
- C.F (Correction Factor) = Antenna Factor (dB)+ Cable Loss (dB) – Preamplifier(dB).
- Measurement (dBuV/m) = Reading(dBuV) + C.F (Correction Factor).

EUT	Intel® Dual Band Wireless-AC 8265	Test Date	2018/8/27
Factor	BBHA 9120D (1GHz~18GHz)	Temp. / Humidity	25°C / 60%
Polarity	Vertical	Site / Engineer	AC1 / Peter
Test Mode	MODE1- DH5_CH39	Test Voltage	AC 120V/60Hz

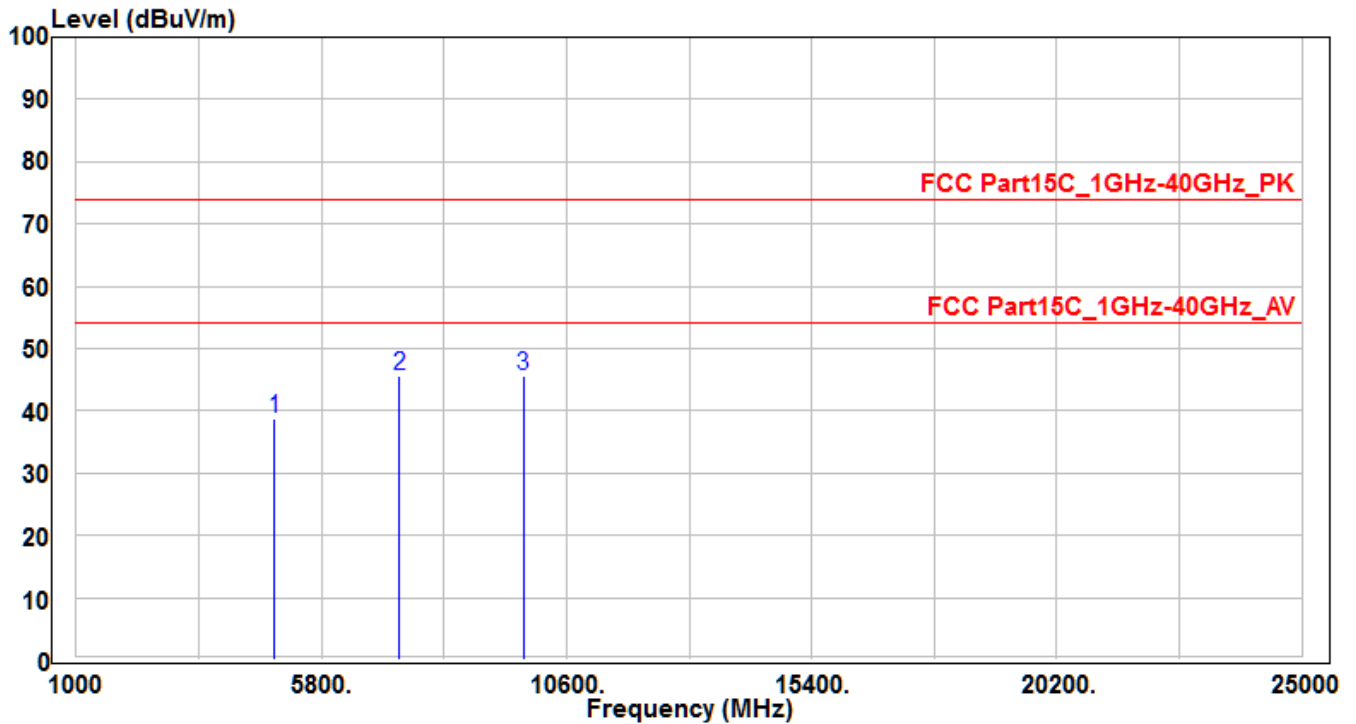

No	Frequency (MHz)	Reading (dBuV)	C.F (dB)	Measurement (dBuV/m)	Margin (dB)	Limit (dBuV/m)	Height (cm)	Angle (deg)	Remark (QP/PK/AV)
1	4882	35.36	3.49	38.85	-35.15	74	150	400	Peak
2	7323	33.28	12.22	45.5	-28.5	74	150	400	Peak
3	*	9764	30.43	45.66	-28.34	74	150	400	Peak

Note:

1. " * " means this data is the worst emission level.
2. C.F (Correction Factor) = Antenna Factor (dB)+ Cable Loss (dB) – Preamplifier(dB).
3. Measurement (dBuV/m) = Reading(dBuV) + C.F (Correction Factor).

EUT	Intel® Dual Band Wireless-AC 8265	Test Date	2018/8/27
Factor	BBHA 9120D (1GHz~18GHz)	Temp. / Humidity	25°C / 60%
Polarity	Horizontal	Site / Engineer	AC1 / Peter
Test Mode	MODE1- DH5_CH78	Test Voltage	AC 120V/60Hz

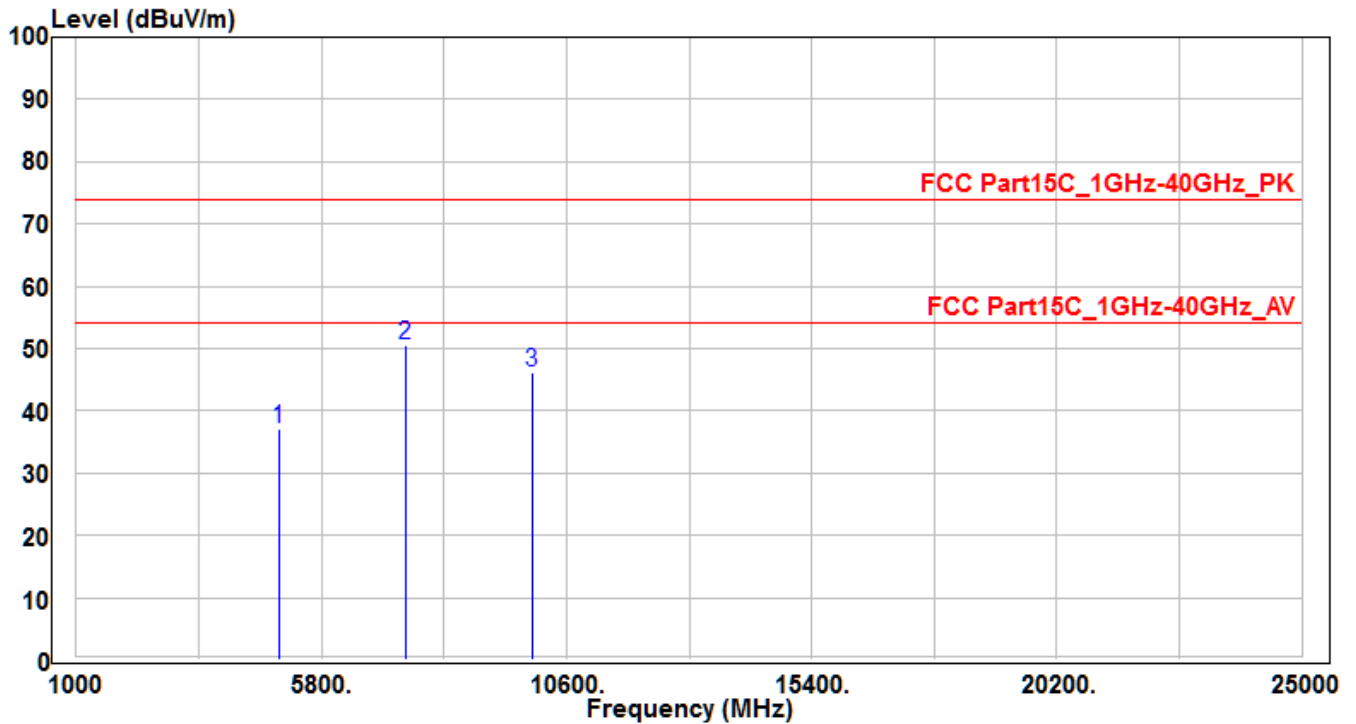

No	Frequency (MHz)	Reading (dBuV)	C.F (dB)	Measurement (dBuV/m)	Margin (dB)	Limit (dBuV/m)	Height (cm)	Angle (deg)	Remark (QP/PK/AV)
1	4960	33.3	3.67	36.97	-37.03	74	150	400	Peak
2	* 7440	38.09	12.55	50.64	-23.36	74	150	400	Peak
3	9920	30.7	15.57	46.27	-27.73	74	150	400	Peak

Note:

- "*" means this data is the worst emission level.
- C.F (Correction Factor) = Antenna Factor (dB)+ Cable Loss (dB) – Preamplifier(dB).
- Measurement (dBuV/m) = Reading(dBuV) + C.F (Correction Factor).

EUT	Intel® Dual Band Wireless-AC 8265	Test Date	2018/8/27
Factor	BBHA 9120D (1GHz~18GHz)	Temp. / Humidity	25°C / 60%
Polarity	Vertical	Site / Engineer	AC1 / Peter
Test Mode	MODE1- DH5_CH78	Test Voltage	AC 120V/60Hz

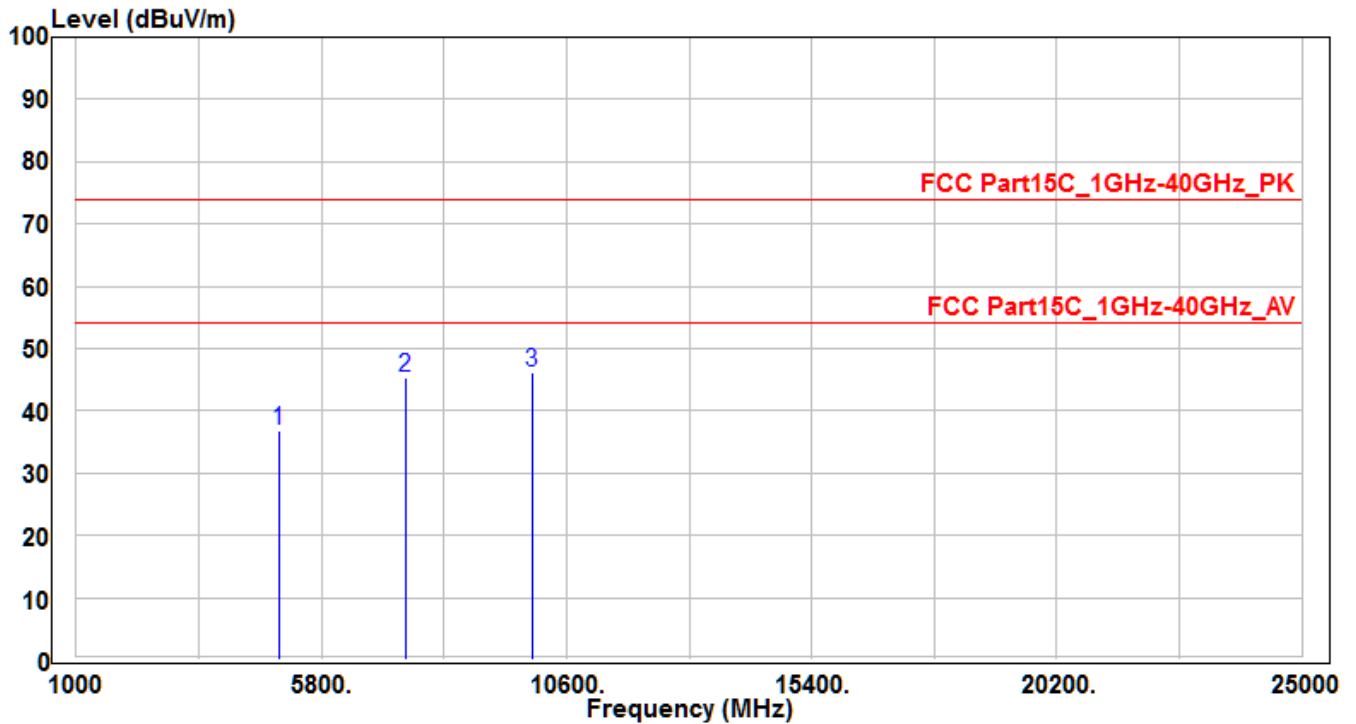

No	Frequency (MHz)	Reading (dBuV)	C.F (dB)	Measurement (dBuV/m)	Margin (dB)	Limit (dBuV/m)	Height (cm)	Angle (deg)	Remark (QP/PK/AV)
1	4960	33.29	3.67	36.96	-37.04	74	150	400	Peak
2	7440	32.66	12.55	45.21	-28.79	74	150	400	Peak
3	* 9920	30.65	15.57	46.22	-27.78	74	150	400	Peak

Note:

- "*" means this data is the worst emission level.
- C.F (Correction Factor) = Antenna Factor (dB)+ Cable Loss (dB) – Preamplifier(dB).
- Measurement (dBuV/m) = Reading(dBuV) + C.F (Correction Factor).

EUT	Intel® Dual Band Wireless-AC 8265	Test Date	2018/8/27
Factor	BBHA 9120D (1GHz~18GHz)	Temp. / Humidity	25°C / 60%
Polarity	Horizontal	Site / Engineer	AC1 / Peter
Test Mode	MODE2- 3-DH5_CH00	Test Voltage	AC 120V/60Hz

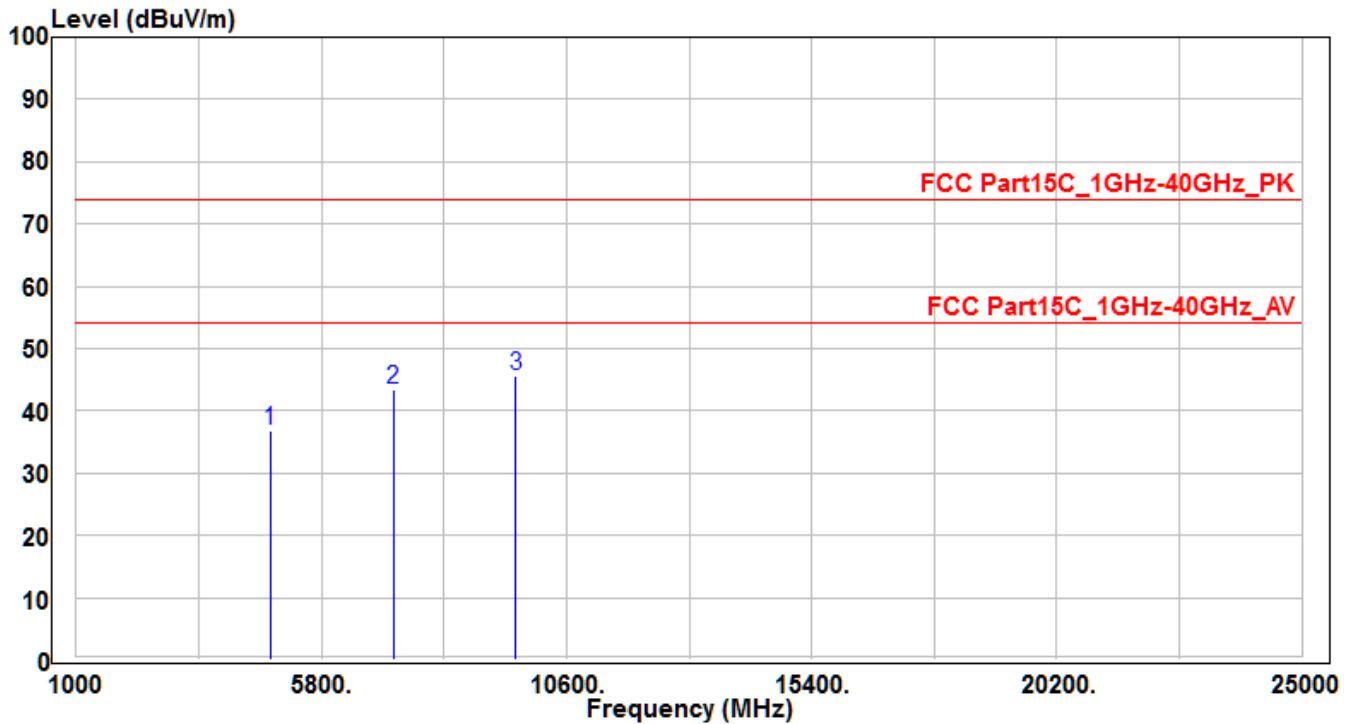

No	Frequency (MHz)	Reading (dBuV)	C.F (dB)	Measurement (dBuV/m)	Margin (dB)	Limit (dBuV/m)	Height (cm)	Angle (deg)	Remark (QP/PK/AV)
1	4804	33.42	3.32	36.74	-37.26	74	150	400	Peak
2	7206	31.59	11.88	43.47	-30.53	74	150	400	Peak
3	*	9608	30.68	45.54	-28.46	74	150	400	Peak

Note:

1. " * " means this data is the worst emission level.
2. C.F (Correction Factor) = Antenna Factor (dB)+ Cable Loss (dB) – Preamplifier(dB).
3. Measurement (dBuV/m) = Reading(dBuV) + C.F (Correction Factor).

EUT	Intel® Dual Band Wireless-AC 8265	Test Date	2018/8/27
Factor	BBHA 9120D (1GHz~18GHz)	Temp. / Humidity	25°C / 60%
Polarity	Vertical	Site / Engineer	AC1 / Peter
Test Mode	MODE2- 3-DH5_CH00	Test Voltage	AC 120V/60Hz

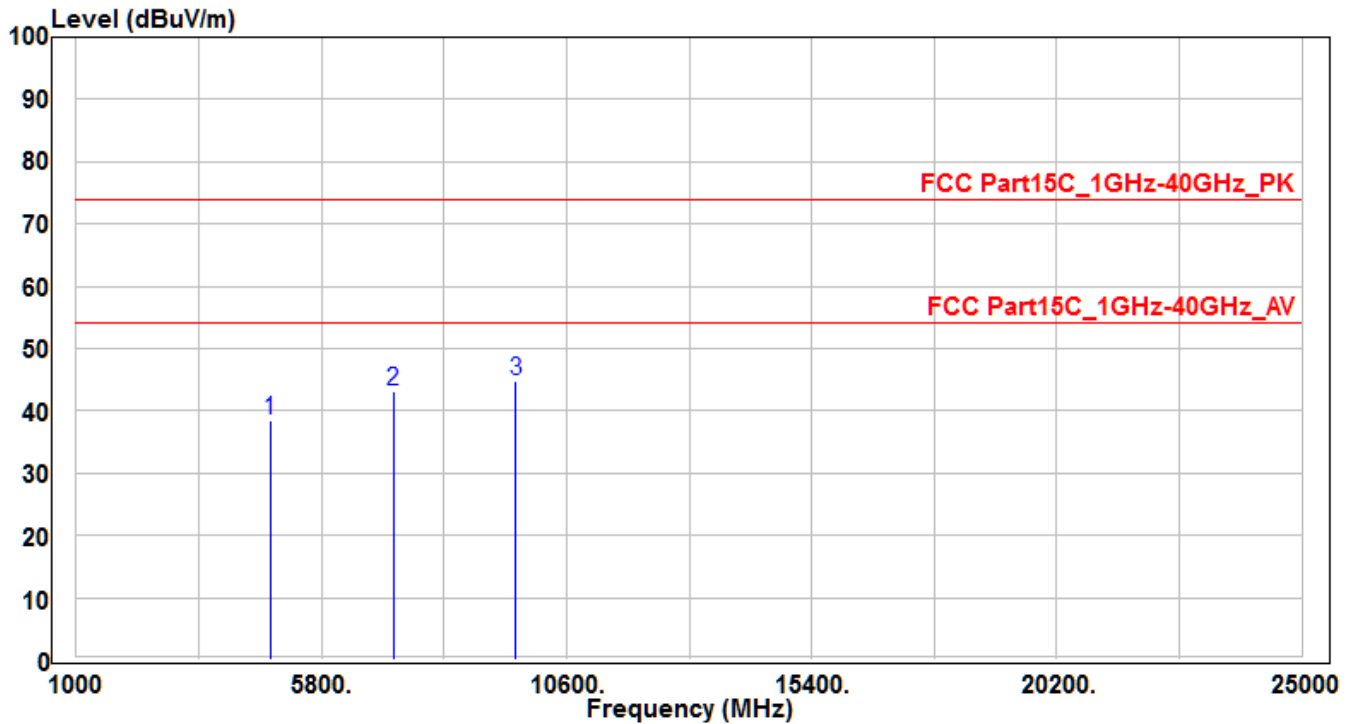

No	Frequency (MHz)	Reading (dBuV)	C.F (dB)	Measurement (dBuV/m)	Margin (dB)	Limit (dBuV/m)	Height (cm)	Angle (deg)	Remark (QP/PK/AV)
1	4804	35.06	3.32	38.38	-35.62	74	150	400	Peak
2	7206	31.33	11.88	43.21	-30.79	74	150	400	Peak
3	* 9608	29.99	14.86	44.85	-29.15	74	150	400	Peak

Note:

1. " * " means this data is the worst emission level.
2. C.F (Correction Factor) = Antenna Factor (dB)+ Cable Loss (dB) – Preamplifier(dB).
3. Measurement (dBuV/m) = Reading(dBuV) + C.F (Correction Factor).

EUT	Intel® Dual Band Wireless-AC 8265	Test Date	2018/8/27
Factor	BBHA 9120D (1GHz~18GHz)	Temp. / Humidity	25°C / 60%
Polarity	Horizontal	Site / Engineer	AC1 / Peter
Test Mode	MODE2- 3-DH5_CH39	Test Voltage	AC 120V/60Hz

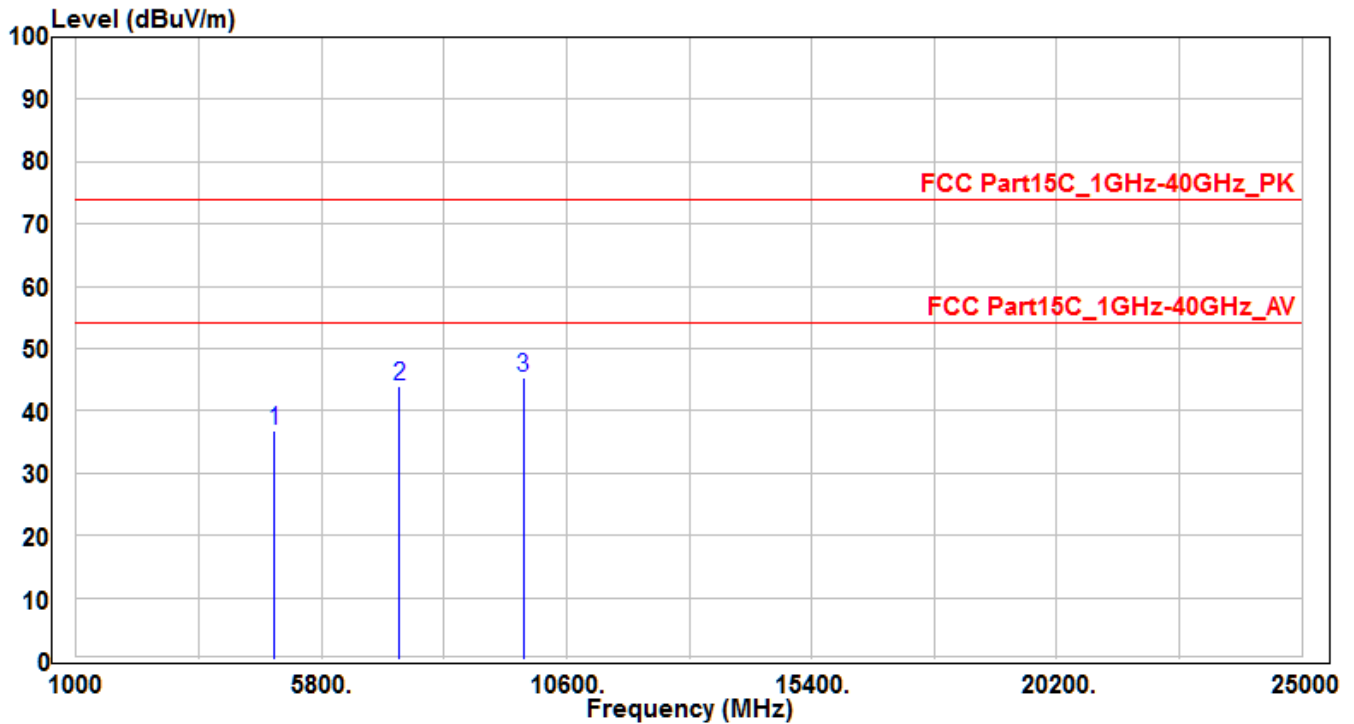

No	Frequency (MHz)	Reading (dBuV)	C.F (dB)	Measurement (dBuV/m)	Margin (dB)	Limit (dBuV/m)	Height (cm)	Angle (deg)	Remark (QP/PK/AV)
1	4882	33.23	3.49	36.72	-37.28	74	150	400	Peak
2	7323	31.85	12.22	44.07	-29.93	74	150	400	Peak
3	*	9764	30.18	45.41	-28.59	74	150	400	Peak

Note:

1. " * " means this data is the worst emission level.
2. C.F (Correction Factor) = Antenna Factor (dB)+ Cable Loss (dB) – Preamplifier(dB).
3. Measurement (dBuV/m) = Reading(dBuV) + C.F (Correction Factor).

EUT	Intel® Dual Band Wireless-AC 8265	Test Date	2018/8/27
Factor	BBHA 9120D (1GHz~18GHz)	Temp. / Humidity	25°C / 60%
Polarity	Vertical	Site / Engineer	AC1 / Peter
Test Mode	MODE2- 3-DH5_CH39	Test Voltage	AC 120V/60Hz

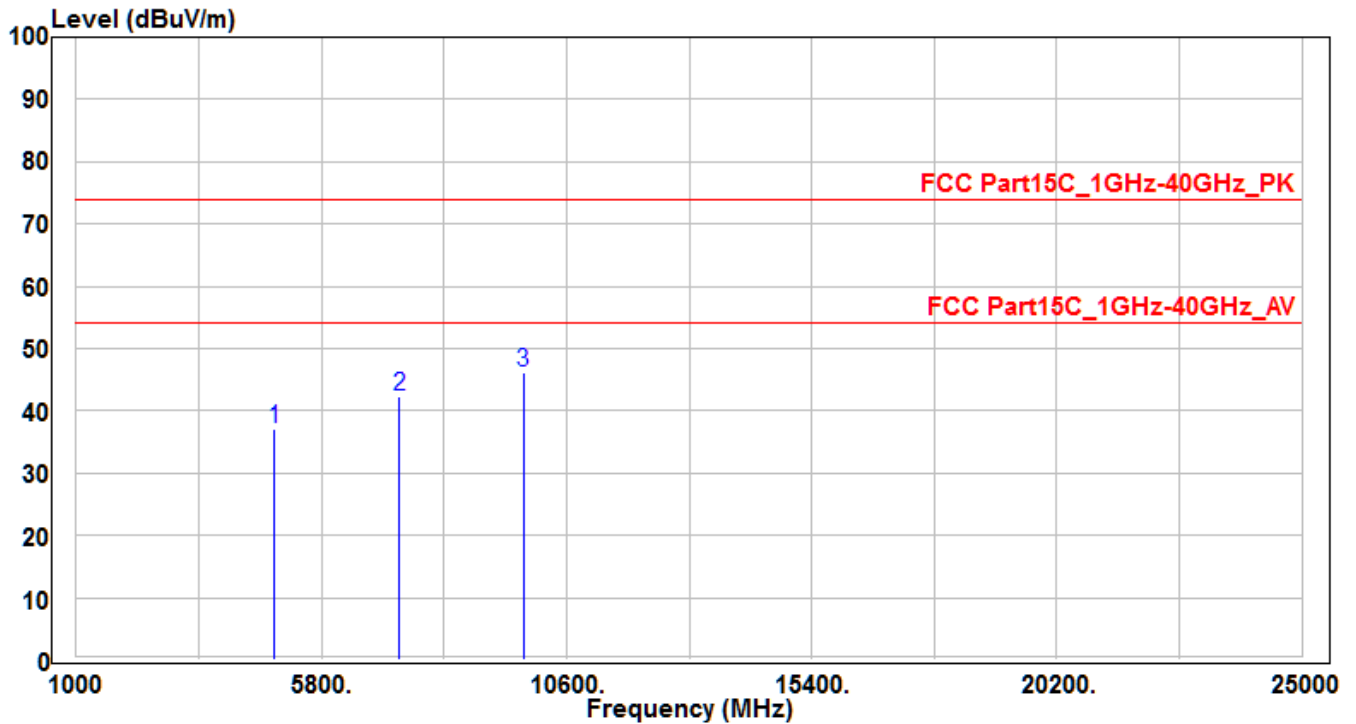

No	Frequency (MHz)	Reading (dBuV)	C.F (dB)	Measurement (dBuV/m)	Margin (dB)	Limit (dBuV/m)	Height (cm)	Angle (deg)	Remark (QP/PK/AV)
1	4882	33.66	3.49	37.15	-36.85	74	150	400	Peak
2	7323	30.15	12.22	42.37	-31.63	74	150	400	Peak
3	* 9764	30.81	15.23	46.04	-27.96	74	150	400	Peak

Note:

- "*" means this data is the worst emission level.
- C.F (Correction Factor) = Antenna Factor (dB)+ Cable Loss (dB) – Preamplifier(dB).
- Measurement (dBuV/m) = Reading(dBuV) + C.F (Correction Factor).

EUT	Intel® Dual Band Wireless-AC 8265	Test Date	2018/8/27
Factor	BBHA 9120D (1GHz~18GHz)	Temp. / Humidity	25°C / 60%
Polarity	Horizontal	Site / Engineer	AC1 / Peter
Test Mode	MODE2- 3-DH5_CH78	Test Voltage	AC 120V/60Hz

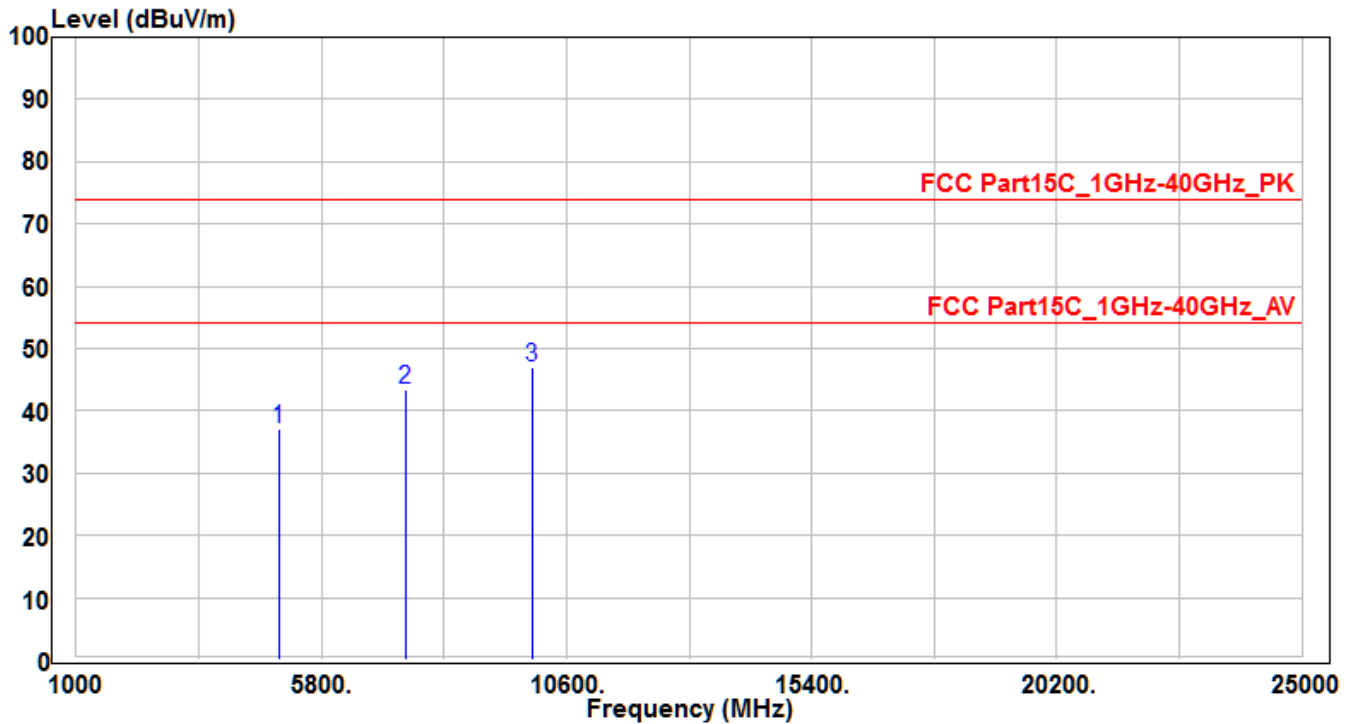

No	Frequency (MHz)	Reading (dBuV)	C.F (dB)	Measurement (dBuV/m)	Margin (dB)	Limit (dBuV/m)	Height (cm)	Angle (deg)	Remark (QP/PK/AV)
1	4960	33.4	3.67	37.07	-36.93	74	150	400	Peak
2	7440	30.83	12.55	43.38	-30.62	74	150	400	Peak
3	* 9920	31.36	15.57	46.93	-27.07	74	150	400	Peak

Note:

1. " * " means this data is the worst emission level.
2. C.F (Correction Factor) = Antenna Factor (dB)+ Cable Loss (dB) – Preamplifier(dB).
3. Measurement (dBuV/m) = Reading(dBuV) + C.F (Correction Factor).

EUT	Intel® Dual Band Wireless-AC 8265	Test Date	2018/8/27
Factor	BBHA 9120D (1GHz~18GHz)	Temp. / Humidity	25°C / 60%
Polarity	Vertical	Site / Engineer	AC1 / Peter
Test Mode	MODE2- 3-DH5_CH78	Test Voltage	AC 120V/60Hz

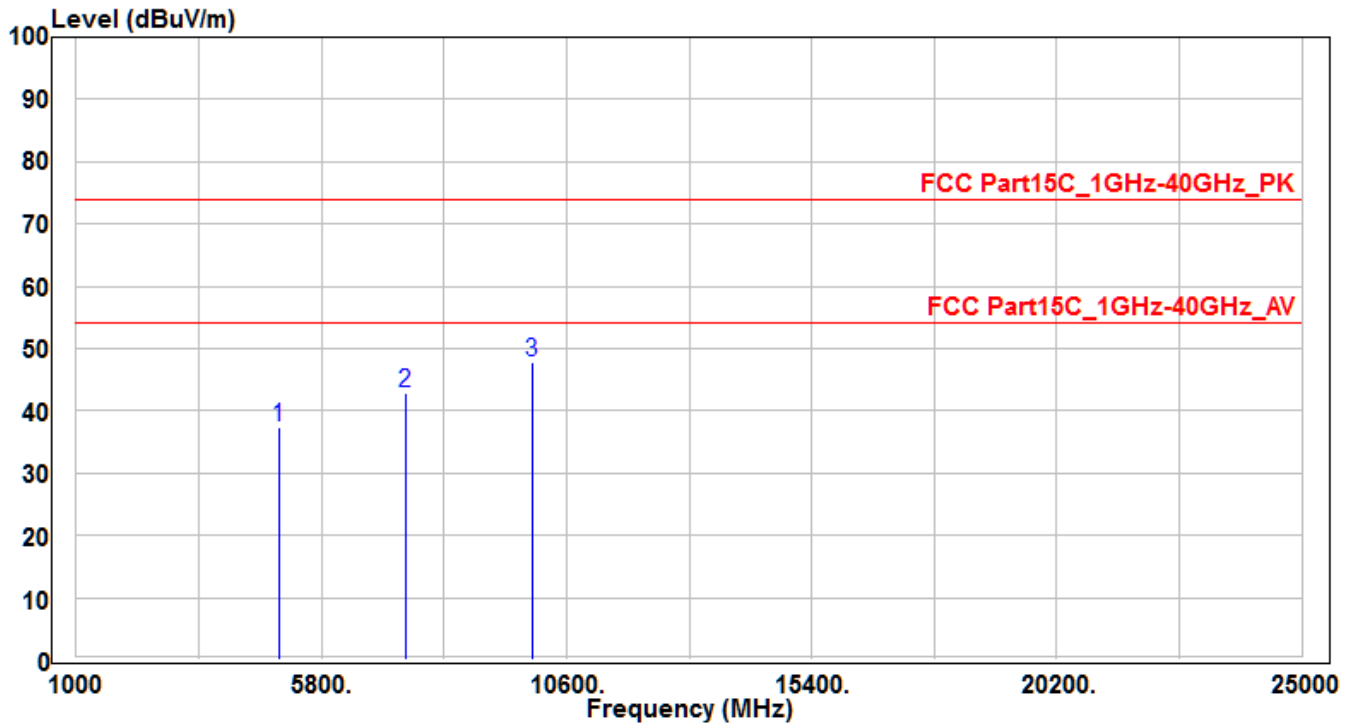

No	Frequency (MHz)	Reading (dBuV)	C.F (dB)	Measurement (dBuV/m)	Margin (dB)	Limit (dBuV/m)	Height (cm)	Angle (deg)	Remark (QP/PK/AV)
1	4960	33.72	3.67	37.39	-36.61	74	150	400	Peak
2	7440	30.28	12.55	42.83	-31.17	74	150	400	Peak
3	*	32.35	15.57	47.92	-26.08	74	150	400	Peak

Note:

1. " * " means this data is the worst emission level.
2. C.F (Correction Factor) = Antenna Factor (dB)+ Cable Loss (dB) – Preamplifier(dB).
3. Measurement (dBuV/m) = Reading(dBuV) + C.F (Correction Factor).

7.9. Radiated Restricted Band Edge Measurement

7.9.1. Test Limit

All out of band emissions appearing in a restricted band as specified in Section 15.205 of the Title 47 CFR must not exceed the limits shown in Table per Section 15.209.

FCC Part 15 Subpart C Paragraph 15.209		
Frequency [MHz]	Field Strength [V/m]	Measured Distance [Meters]
0.009 - 0.490	2400/F (kHz)	300
0.490 - 1.705	24000/F (kHz)	30
1.705 – 30	30	30
30 – 88	100	3
88 – 216	150	3
216 – 960	200	3
Above 960	500	3

7.9.2. Test Procedure Used

ANSI C63.10-2013 - Section 11.12.1

7.9.3. Test Setting

Peak Field Strength Measurements

1. Analyzer center frequency was set to the frequency of the radiated spurious emission of interest
2. RBW = as specified in Table 1
3. VBW = 3 * RBW
4. Detector = peak
5. Sweep time = auto couple
6. Trace mode = max hold

- Trace was allowed to stabilize

Table 1 - RBW as a function of frequency

Frequency	RBW
9 ~ 150 kHz	200 ~ 300 Hz
0.15 ~ 30 MHz	9 ~ 10 kHz
30 ~ 1000 MHz	100 ~ 120 kHz
> 1000 MHz	1 MHz

Average Field Strength Measurements

- Analyzer center frequency was set to the frequency of the radiated spurious emission of interest
- RBW = 1MHz
- VBW $\geq 1/T$
- De As an alternative, the instrument may be set to linear detector mode. Ensure that video filtering is applied in linear voltage domain (rather than in a log or dB domain). Some instruments require linear display mode in order to accomplish this. Others have a setting for Average-VBW Type, which can be set to "Voltage" regardless of the display mode
- Detector = Peak
- Sweep time = auto
- Trace mode = max hold
- Allow max hold to run for at least 50 times (1/duty cycle) traces

7.9.4. Test Setup

1GHz ~ 18GHz Test Setup:

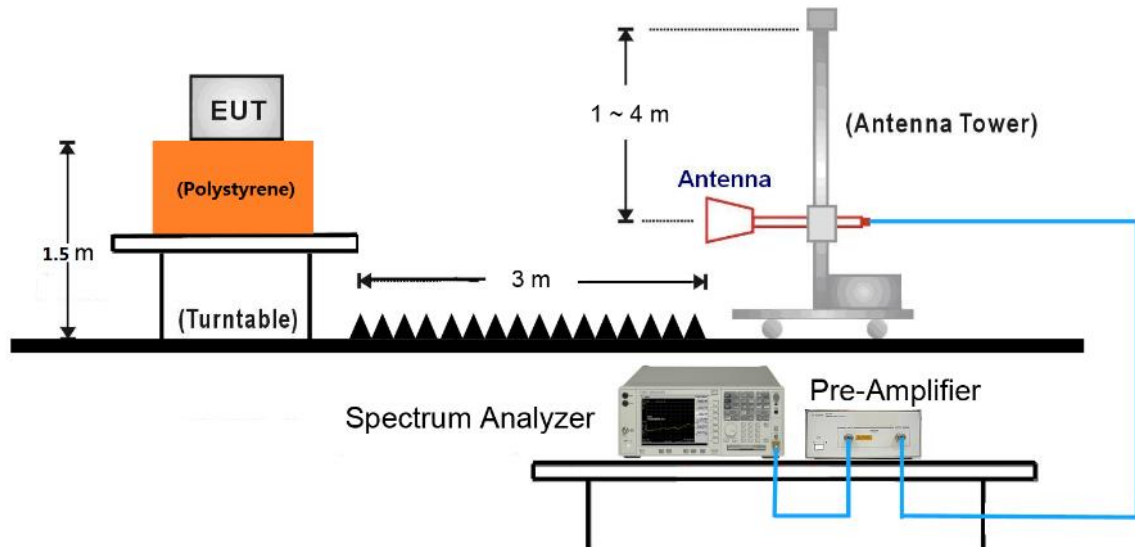

18GHz ~40GHz Test Setup:

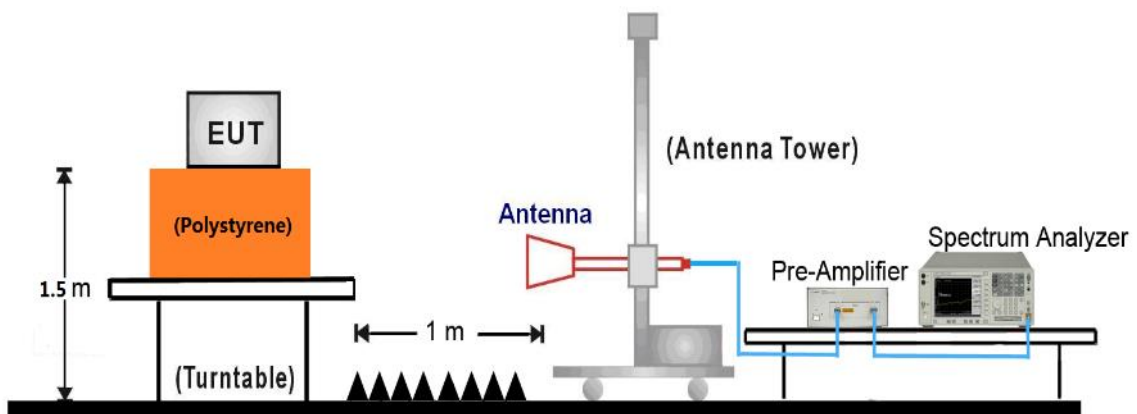

7.9.5. Test Result

EUT	Intel® Dual Band Wireless-AC 8265	Test Date	2018/8/27
Factor	BBHA 9120D (1GHz~18GHz)	Temp. / Humidity	21°C / 57%
Polarity	Horizontal	Site / Engineer	AC1 / Peter
Test Mode	MODE1-DH5_CH00	Test Voltage	AC 120V/60Hz

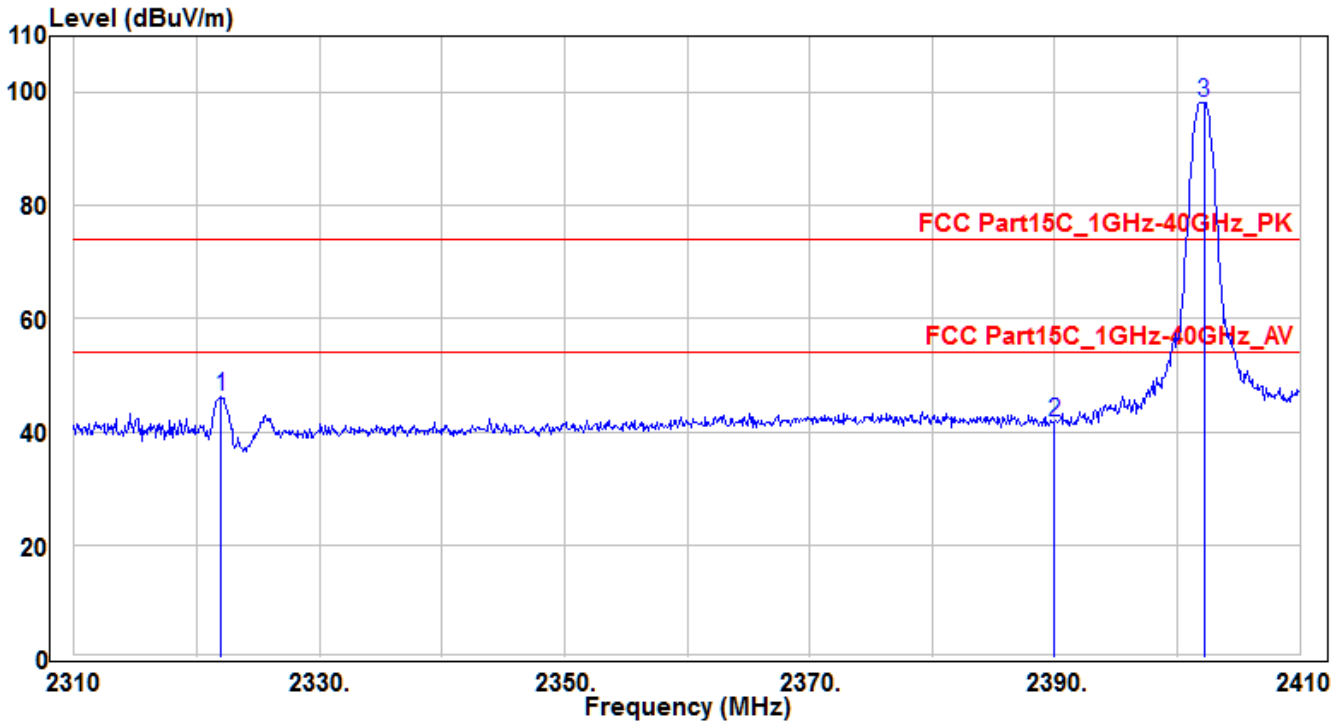

No	Frequency (MHz)	Reading (dBUV)	C.F (dB)	Measurement (dBUV/m)	Margin (dB)	Limit (dBUV/m)	Height (cm)	Angle (deg)	Remark (QP/PK/AV)	
1	*	2322	48.84	-2.62	46.22	-27.78	74	160	195	Peak
2		2390	44.13	-2.36	41.77	-32.23	74	160	195	Peak
3		2402.2	100.55	-2.31	98.24	24.24	74	160	195	Peak

Note:

- "*" means this data is the worst emission level.
- C.F (Correction Factor) = Antenna Factor (dB)+ Cable Loss (dB) – Preamplifier(dB).
- Measurement (dBUV/m) = Reading(dBUV) + C.F (Correction Factor).

EUT	Intel® Dual Band Wireless-AC 8265	Test Date	2018/8/27
Factor	BBHA 9120D (1GHz~18GHz)	Temp. / Humidity	21°C / 57%
Polarity	Vertical	Site / Engineer	AC1 / Peter
Test Mode	MODE1- DH5_CH00	Test Voltage	AC 120V/60Hz

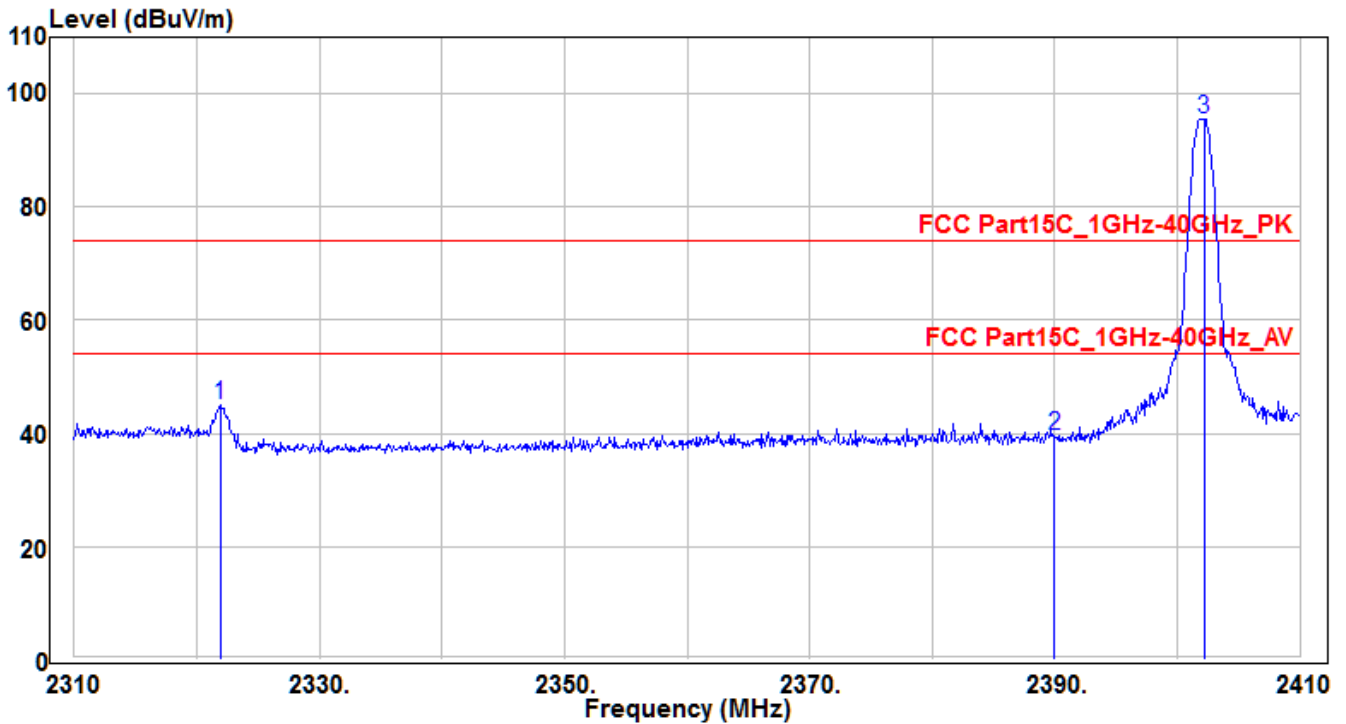

No		Frequency (MHz)	Reading (dBUV)	C.F (dB)	Measurement (dBUV/m)	Margin (dB)	Limit (dBUV/m)	Height (cm)	Angle (deg)	Remark (QP/PK/AV)
1	*	2321.9	47.59	-2.62	44.97	-29.03	74	150	240	Peak
2		2390	41.96	-2.36	39.6	-34.4	74	150	240	Peak
3		2402.2	97.81	-2.31	95.5	21.5	74	150	240	Peak

Note:

1. " * " means this data is the worst emission level.
2. C.F (Correction Factor) = Antenna Factor (dB)+ Cable Loss (dB) – Preamplifier(dB).
3. Measurement (dBUV/m) = Reading(dBUV) + C.F (Correction Factor).

EUT	Intel® Dual Band Wireless-AC 8265	Test Date	2018/8/27
Factor	BBHA 9120D (1GHz~18GHz)	Temp. / Humidity	21°C / 57%
Polarity	Horizontal	Site / Engineer	AC1 / Peter
Test Mode	MODE1- DH5_CH78	Test Voltage	AC 120V/60Hz

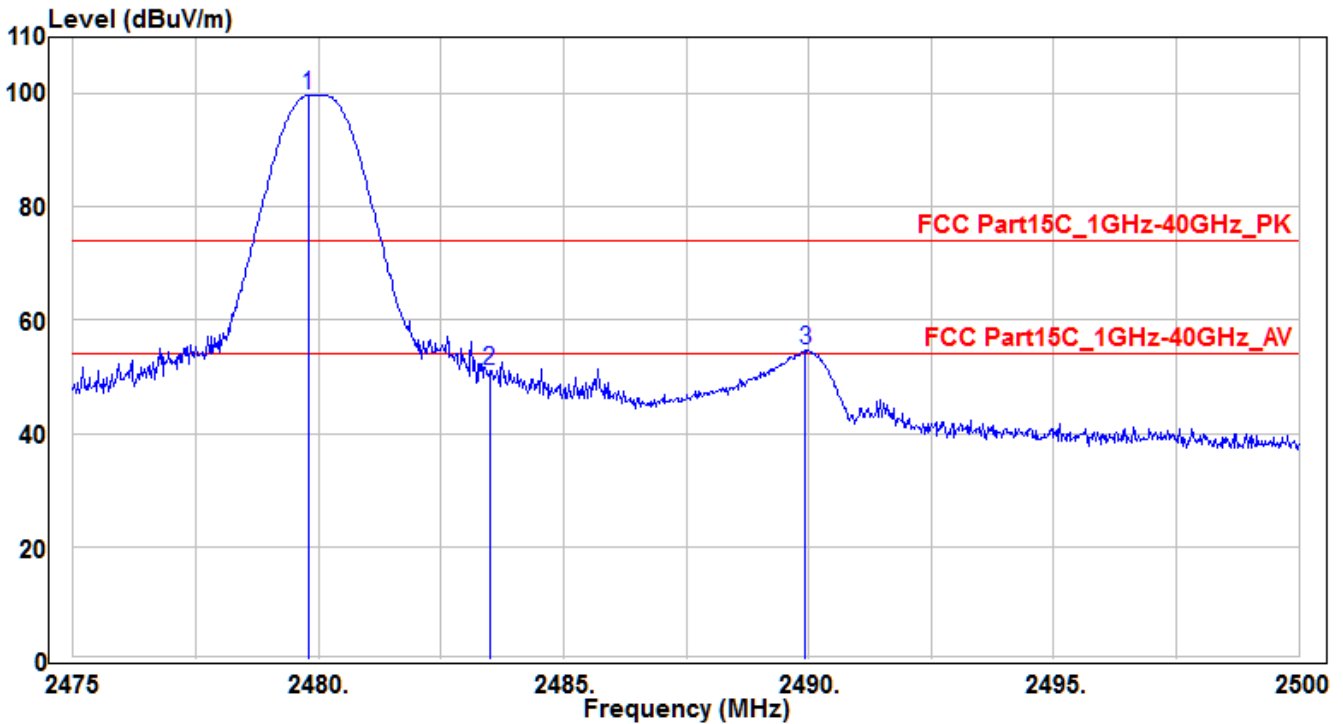

No	Frequency (MHz)	Reading (dBUV)	C.F (dB)	Measurement (dBUV/m)	Margin (dB)	Limit (dBUV/m)	Height (cm)	Angle (deg)	Remark (QP/PK/AV)
1	2479.8	101.73	-2	99.73	25.73	74	180	190	Peak
2	2483.5	52.97	-1.99	50.98	-23.02	74	180	190	Peak
3	* 2489.925	56.68	-1.96	54.72	-19.28	74	180	190	Peak

Note:

1. " * " means this data is the worst emission level.
2. C.F (Correction Factor) = Antenna Factor (dB)+ Cable Loss (dB) – Preamplifier(dB).
3. Measurement (dBUV/m) = Reading(dBUV) + C.F (Correction Factor).

EUT	Intel® Dual Band Wireless-AC 8265	Test Date	2018/8/27
Factor	BBHA 9120D (1GHz~18GHz)	Temp. / Humidity	21°C / 57%
Polarity	Horizontal	Site / Engineer	AC1 / Peter
Test Mode	MODE1- DH5_CH78	Test Voltage	AC 120V/60Hz

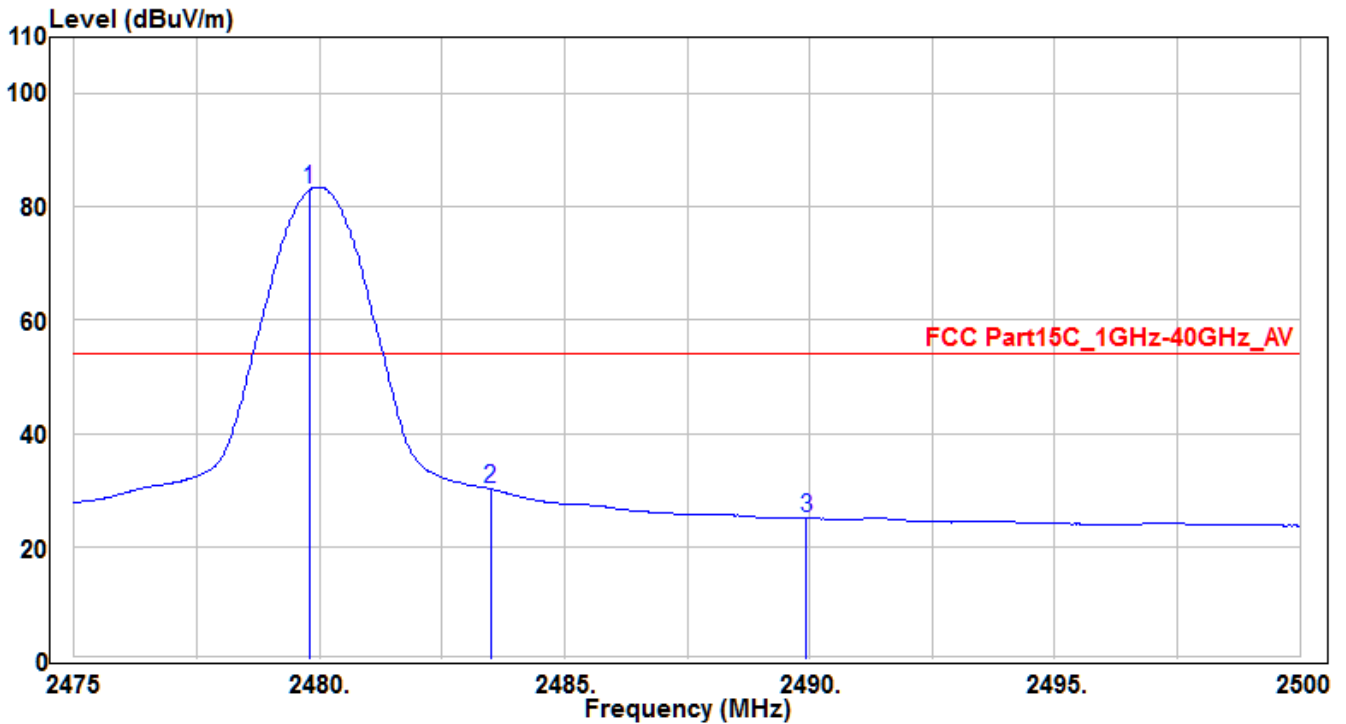

No	Frequency (MHz)	Reading (dBUV)	C.F (dB)	Measurement (dBUV/m)	Margin (dB)	Limit (dBUV/m)	Height (cm)	Angle (deg)	Remark (QP/PK/AV)
1	2479.8	84.97	-2	82.97	28.97	54	180	190	Average
2	* 2483.5	32.23	-1.99	30.24	-23.76	54	180	190	Average
3	2489.925	26.95	-1.96	24.99	-29.01	54	180	190	Average

Note:

1. " * " means this data is the worst emission level.
2. C.F (Correction Factor) = Antenna Factor (dB)+ Cable Loss (dB) – Preamplifier(dB).
3. Measurement (dBUV/m) = Reading(dBUV) + C.F (Correction Factor).

EUT	Intel® Dual Band Wireless-AC 8265	Test Date	2018/8/27
Factor	BBHA 9120D (1GHz~18GHz)	Temp. / Humidity	21°C / 57%
Polarity	Vertical	Site / Engineer	AC1 / Peter
Test Mode	MODE1- DH5_CH78	Test Voltage	AC 120V/60Hz

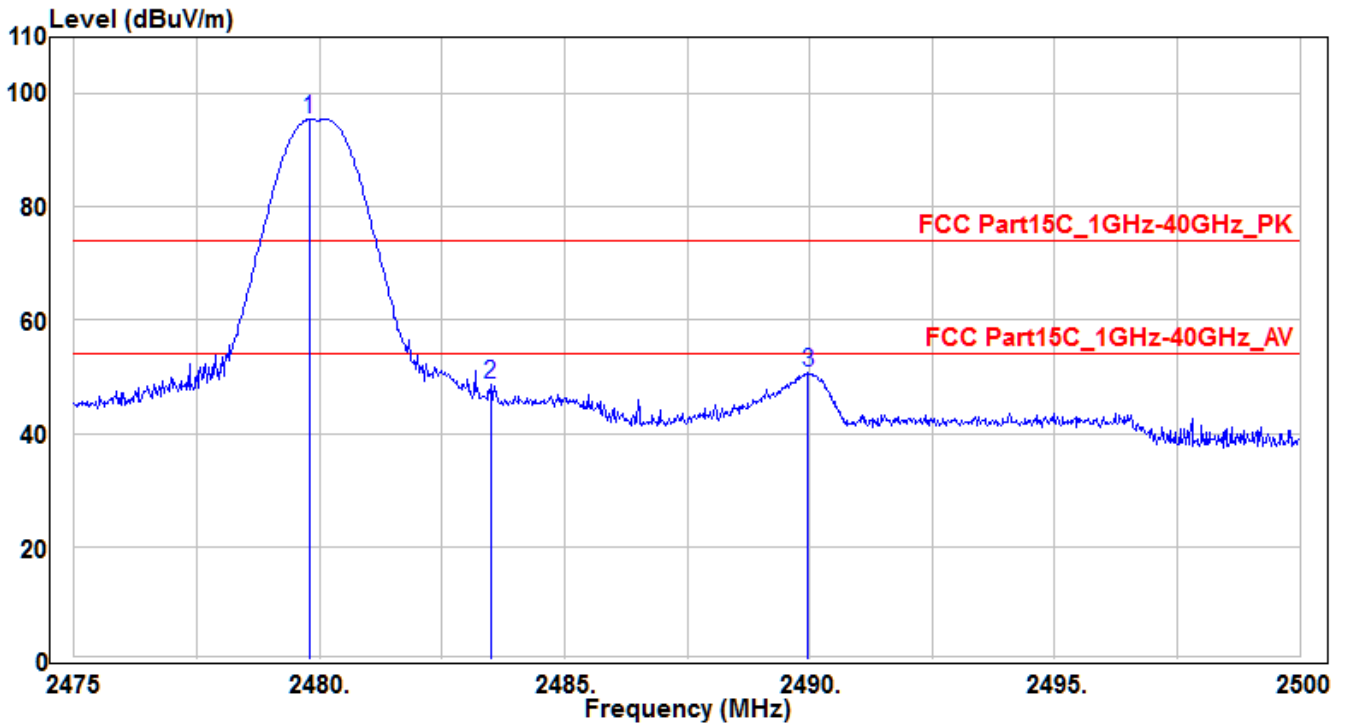

No	Frequency (MHz)	Reading (dBuV)	C.F (dB)	Measurement (dBuV/m)	Margin (dB)	Limit (dBuV/m)	Height (cm)	Angle (deg)	Remark (QP/PK/AV)
1	2479.8	97.46	-2	95.46	21.46	74	165	195	Peak
2	2483.5	50.57	-1.99	48.58	-25.42	74	165	195	Peak
3	* 2489.975	52.59	-1.96	50.63	-23.37	74	165	195	Peak

Note:

1. " * " means this data is the worst emission level.
2. C.F (Correction Factor) = Antenna Factor (dB)+ Cable Loss (dB) – Preamplifier(dB).
3. Measurement (dBuV/m) = Reading(dBuV) + C.F (Correction Factor).

EUT	Intel® Dual Band Wireless-AC 8265	Test Date	2018/8/27
Factor	BBHA 9120D (1GHz~18GHz)	Temp. / Humidity	21°C / 57%
Polarity	Horizontal	Site / Engineer	AC1 / Peter
Test Mode	MODE2- 3DH5_CH00	Test Voltage	AC 120V/60Hz

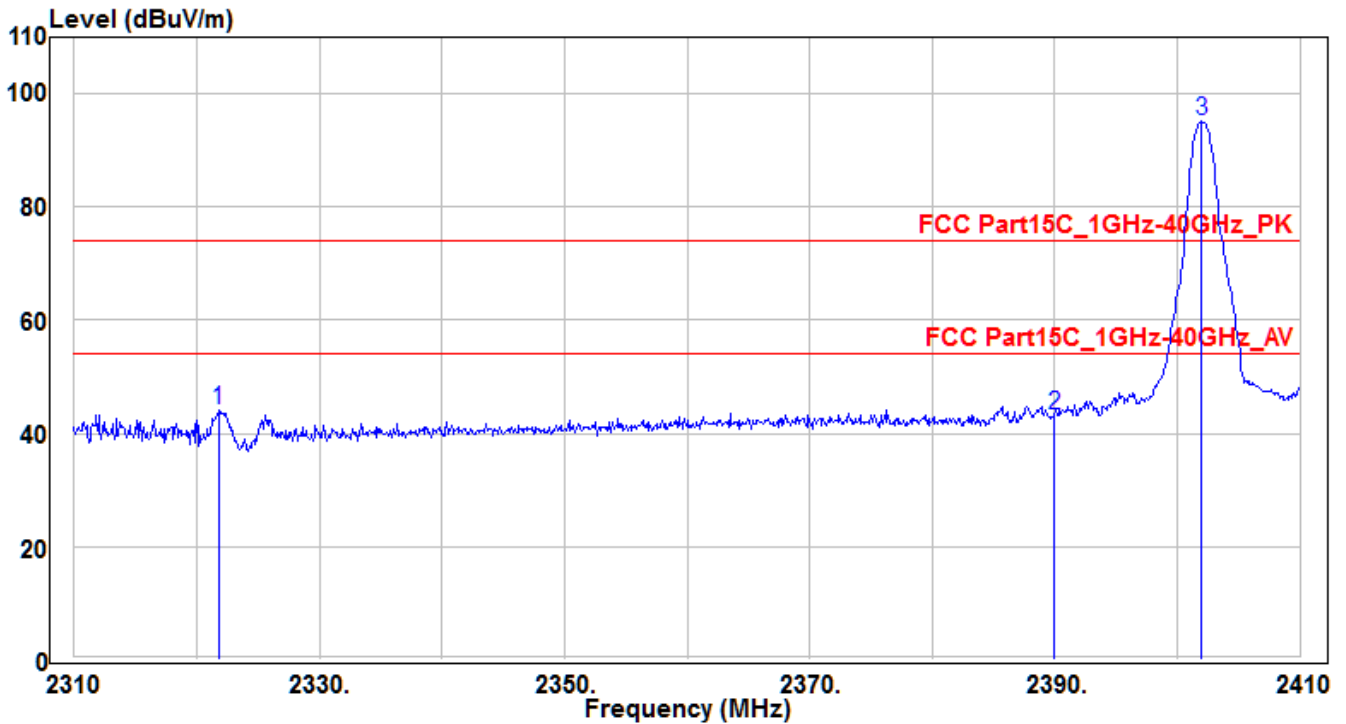

No		Frequency (MHz)	Reading (dBuV)	C.F (dB)	Measurement (dBuV/m)	Margin (dB)	Limit (dBuV/m)	Height (cm)	Angle (deg)	Remark (QP/PK/AV)
1	*	2321.8	46.78	-2.62	44.16	-29.84	74	190	195	Peak
2		2390	45.65	-2.36	43.29	-30.71	74	190	195	Peak
3		2402	97.39	-2.31	95.08	21.08	74	190	195	Peak

Note:

1. " * " means this data is the worst emission level.
2. C.F (Correction Factor) = Antenna Factor (dB)+ Cable Loss (dB) – Preamplifier(dB).
3. Measurement (dBuV/m) = Reading(dBuV) + C.F (Correction Factor).

EUT	Intel® Dual Band Wireless-AC 8265	Test Date	2018/8/27
Factor	BBHA 9120D (1GHz~18GHz)	Temp. / Humidity	21°C / 57%
Polarity	Vertical	Site / Engineer	AC1 / Peter
Test Mode	MODE2- 3DH5_CH00	Test Voltage	AC 120V/60Hz

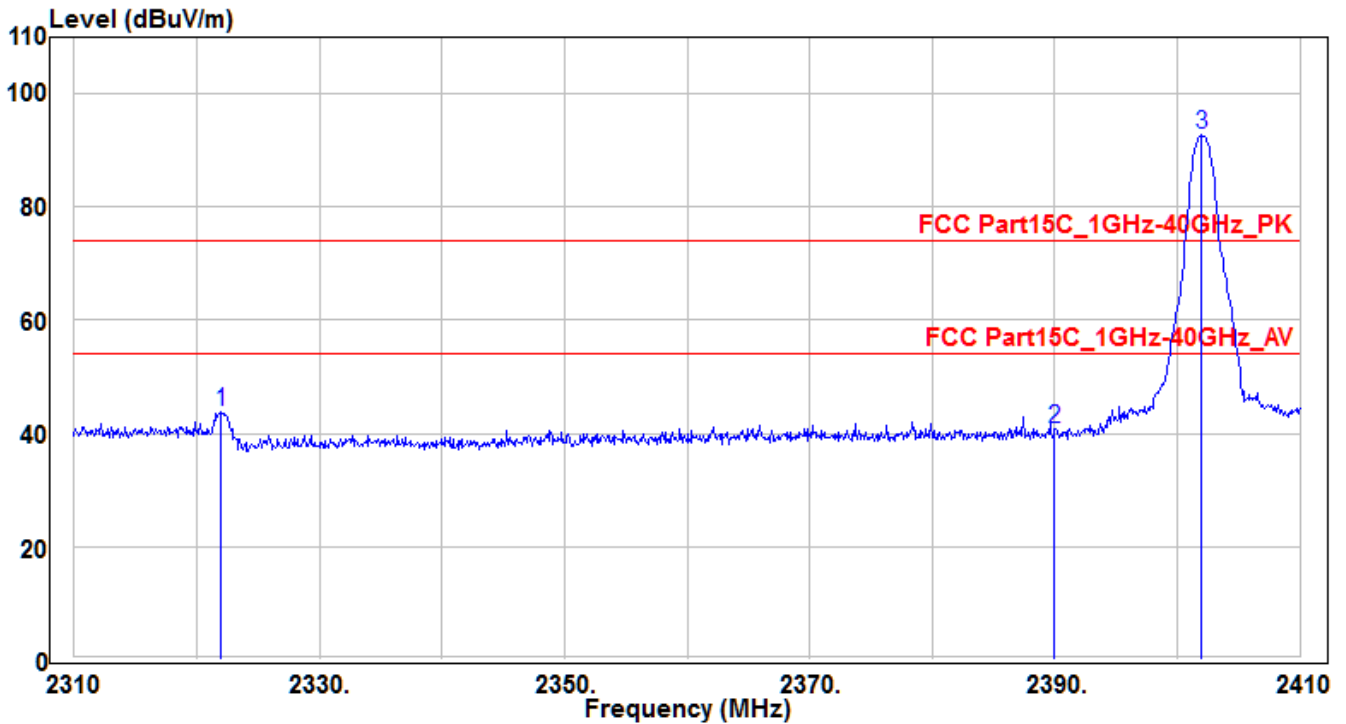

No	Frequency (MHz)	Reading (dBuV)	C.F (dB)	Measurement (dBuV/m)	Margin (dB)	Limit (dBuV/m)	Height (cm)	Angle (deg)	Remark (QP/PK/AV)	
1	*	2322	46.53	-2.62	43.91	-30.09	74	100	215	Peak
2		2390	43.25	-2.36	40.89	-33.11	74	100	215	Peak
3		2402	94.95	-2.31	92.64	18.64	74	100	215	Peak

Note:

1. " * " means this data is the worst emission level.
2. C.F (Correction Factor) = Antenna Factor (dB)+ Cable Loss (dB) – Preamplifier(dB).
3. Measurement (dBuV/m) = Reading(dBuV) + C.F (Correction Factor).

EUT	Intel® Dual Band Wireless-AC 8265	Test Date	2018/8/27
Factor	BBHA 9120D (1GHz~18GHz)	Temp. / Humidity	21°C / 57%
Polarity	Horizontal	Site / Engineer	AC1 / Peter
Test Mode	MODE2- 3DH5_CH78	Test Voltage	AC 120V/60Hz

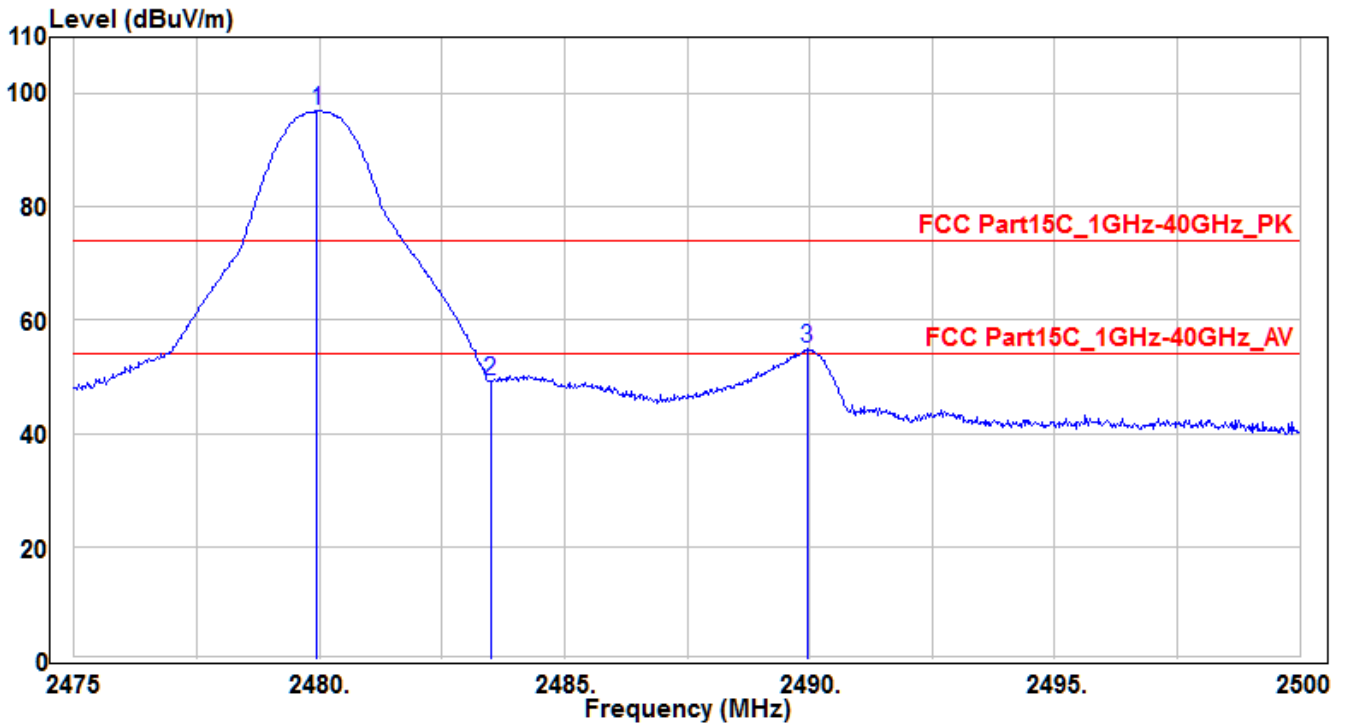

No	Frequency (MHz)	Reading (dBUV)	C.F (dB)	Measurement (dBUV/m)	Margin (dB)	Limit (dBUV/m)	Height (cm)	Angle (deg)	Remark (QP/PK/AV)
1	2479.95	98.99	-2	96.99	22.99	74	175	195	Peak
2	2483.5	51.38	-1.99	49.39	-24.61	74	175	195	Peak
3	* 2489.95	56.88	-1.96	54.92	-19.08	74	175	195	Peak

Note:

1. " * " means this data is the worst emission level.
2. C.F (Correction Factor) = Antenna Factor (dB)+ Cable Loss (dB) – Preamplifier(dB).
3. Measurement (dBUV/m) = Reading(dBUV) + C.F (Correction Factor).

EUT	Intel® Dual Band Wireless-AC 8265	Test Date	2018/8/27
Factor	BBHA 9120D (1GHz~18GHz)	Temp. / Humidity	21°C / 57%
Polarity	Horizontal	Site / Engineer	AC1 / Peter
Test Mode	MODE2- 3DH5_CH78	Test Voltage	AC 120V/60Hz

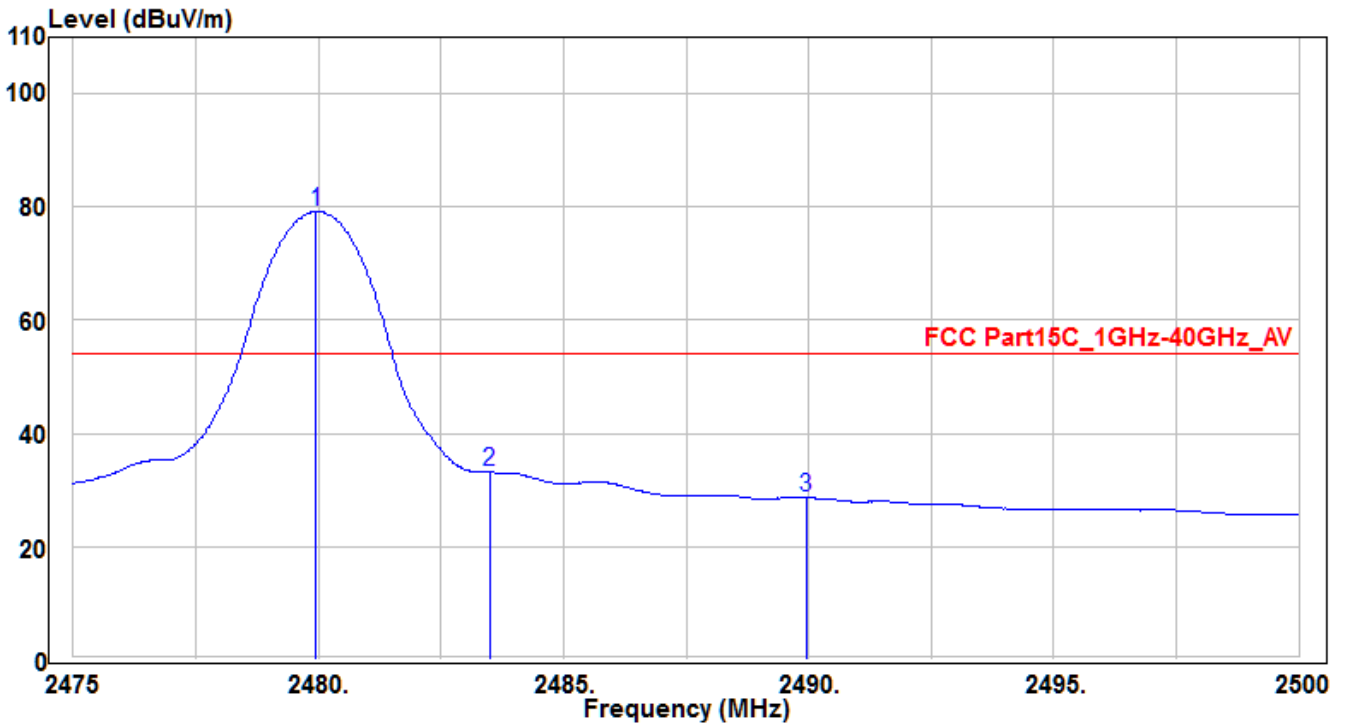

No	Frequency (MHz)	Reading (dBUV)	C.F (dB)	Measurement (dBUV/m)	Margin (dB)	Limit (dBUV/m)	Height (cm)	Angle (deg)	Remark (QP/PK/AV)
1	2479.95	81.13	-2	79.13	25.13	54	175	195	Average
2	* 2483.5	35.19	-1.99	33.2	-20.8	54	175	195	Average
3	2489.95	30.6	-1.96	28.64	-25.36	54	175	195	Average

Note:

1. " * " means this data is the worst emission level.
2. C.F (Correction Factor) = Antenna Factor (dB)+ Cable Loss (dB) – Preamplifier(dB).
3. Measurement (dBUV/m) = Reading(dBUV) + C.F (Correction Factor).

EUT	Intel® Dual Band Wireless-AC 8265	Test Date	2018/8/27
Factor	BBHA 9120D (1GHz~18GHz)	Temp. / Humidity	21°C / 57%
Polarity	Vertical	Site / Engineer	AC1 / Peter
Test Mode	MODE2- 3DH5_CH78	Test Voltage	AC 120V/60Hz

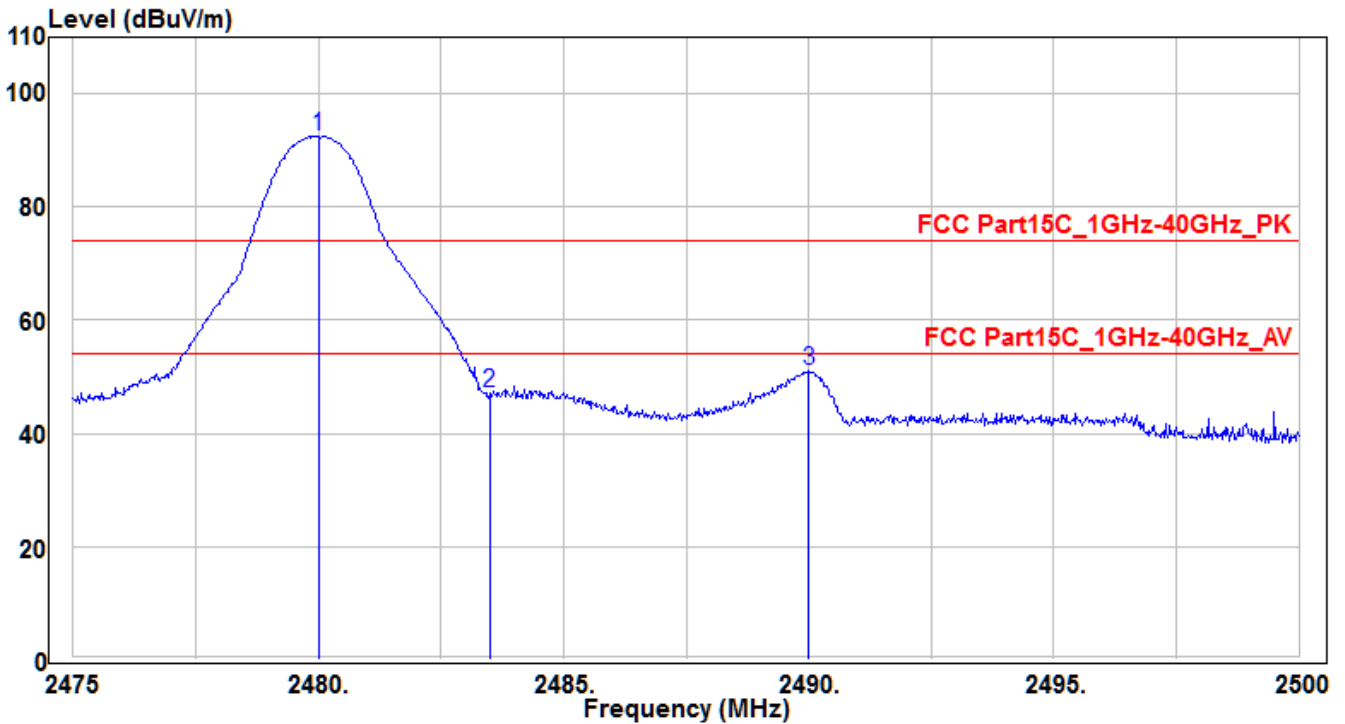

No	Frequency (MHz)	Reading (dBuV)	C.F (dB)	Measurement (dBuV/m)	Margin (dB)	Limit (dBuV/m)	Height (cm)	Angle (deg)	Remark (QP/PK/AV)
1	2480	94.57	-2	92.57	18.57	74	150	195	Peak
2	2483.5	49.15	-1.99	47.16	-26.84	74	150	195	Peak
3	* 2490	52.92	-1.96	50.96	-23.04	74	150	195	Peak

Note:

- "*" means this data is the worst emission level.
- C.F (Correction Factor) = Antenna Factor (dB)+ Cable Loss (dB) – Preamplifier(dB).
- Measurement (dBuV/m) = Reading(dBuV) + C.F (Correction Factor).

7.10. AC Conducted Emissions Measurement

7.10.1. Test Limit

FCC Part 15 Subpart C Paragraph 15.207 / RSS-Gen Limits		
Frequency (MHz)	QP (dB μ V)	Average (dB μ V)
0.15 - 0.50	66 - 56	56 - 46
0.50 - 5.0	56	46
5.0 - 30	60	50

Note 1: The lower limit shall apply at the transition frequencies.

Note 2: The limit decreases linearly with the logarithm of the frequency in the range 0.15MHz to 0.5MHz.

7.10.2. Test Setup

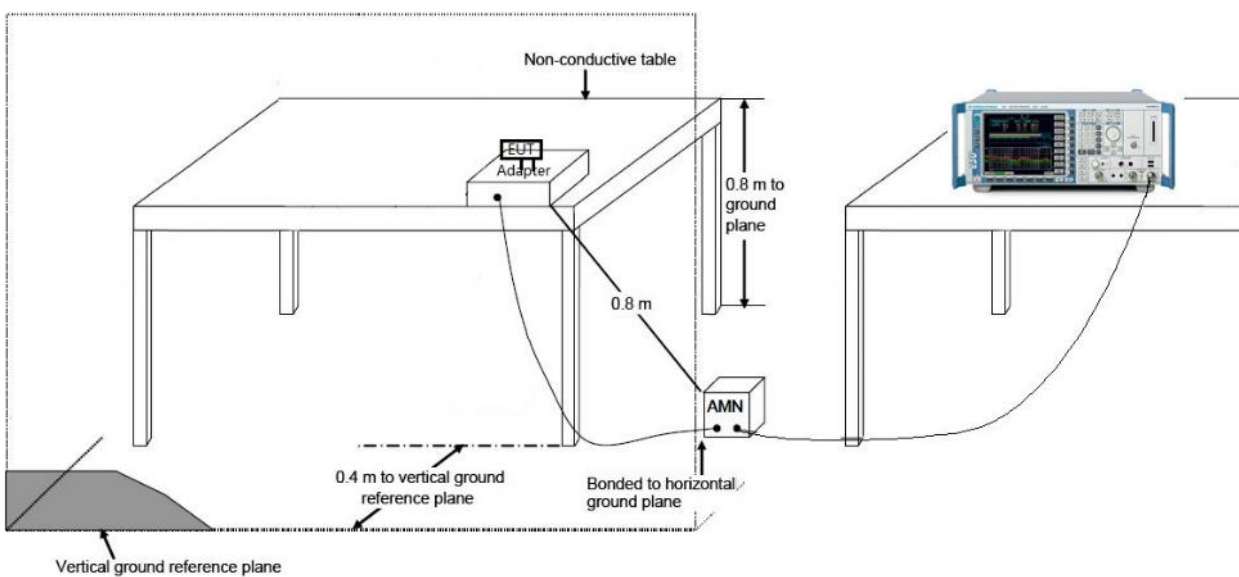

7.10.3. Test Result

EUT	Intel® Dual Band Wireless-AC 8265	Test Date	2018/8/27
Factor	CE_ENV216-L1 (Filter ON)	Temp. / Humidity	24°C / 55%
Polarity	Line1	Site / Engineer	SR2 / Peter
Test Mode	MODE1-CH39	Test Voltage	AC120V/60Hz

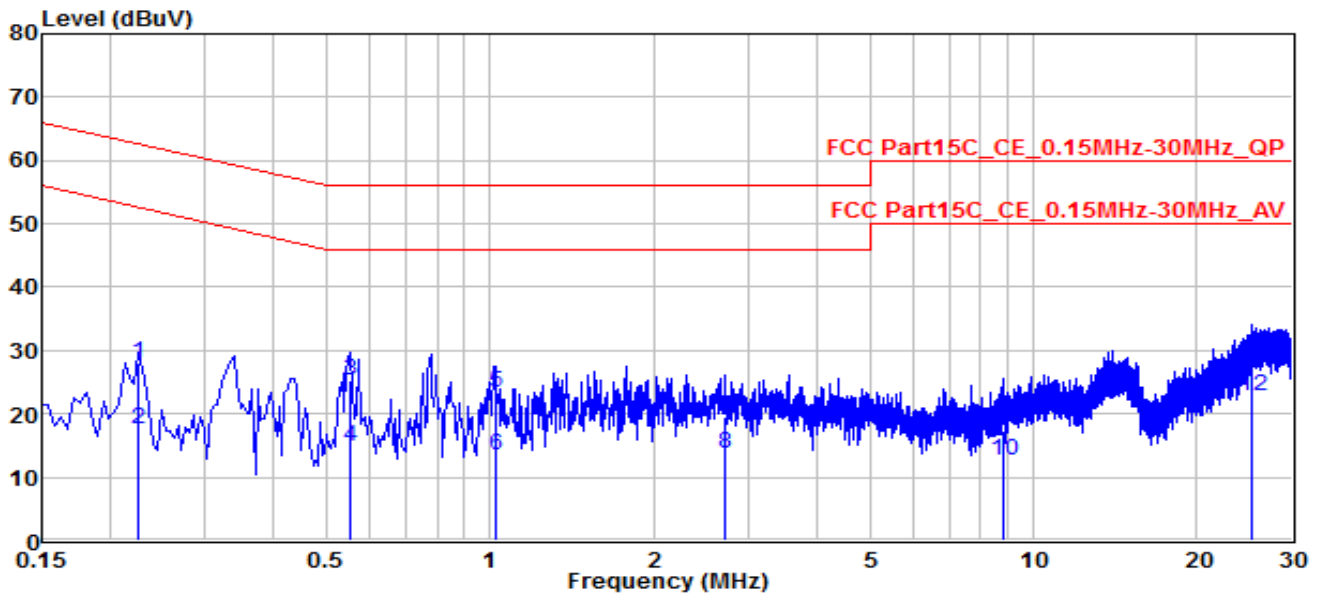

No	Frequency (MHz)	Reading (dBuV)	C.F (dB)	Measurement (dBuV)	Margin (dB)	Limit (dBuV)	Remark (QP/PK/AV)
1	0.22649	18.06	9.94	28	-34.58	62.58	QP
2	0.22649	7.72	9.94	17.66	-34.92	52.58	Average
3	* 0.55496	15.16	10.08	25.24	-30.76	56	QP
4	0.55496	4.77	10.08	14.85	-31.15	46	Average
5	1.023	13.46	9.89	23.35	-32.65	56	QP
6	1.023	3.58	9.89	13.47	-32.53	46	Average
7	2.719	9.79	9.84	19.63	-36.37	56	QP
8	2.719	3.82	9.84	13.66	-32.34	46	Average
9	8.848	7.55	9.83	17.38	-42.62	60	QP
10	8.848	2.77	9.83	12.6	-37.4	50	Average
11	25.32	17.97	10.04	28.01	-31.99	60	QP
12	* 25.32	12.71	10.04	22.75	-27.25	50	Average

Note:

- "*", means this data is the worst emission level.
- C.F (Correction Factor) = Factor (dB)+ Cable Loss (dB).
- Measurement (dBuV) = Reading(dBuV)+ C.F (Correction Factor).

EUT	Intel® Dual Band Wireless-AC 8265	Test Date	2018/8/27
Factor	CE_ENV216-N (Filter ON)	Temp. / Humidity	24°C / 55%
Polarity	Neutral	Site / Engineer	SR2 / Peter
Test Mode	MODE1-CH39	Test Voltage	AC120V/60Hz

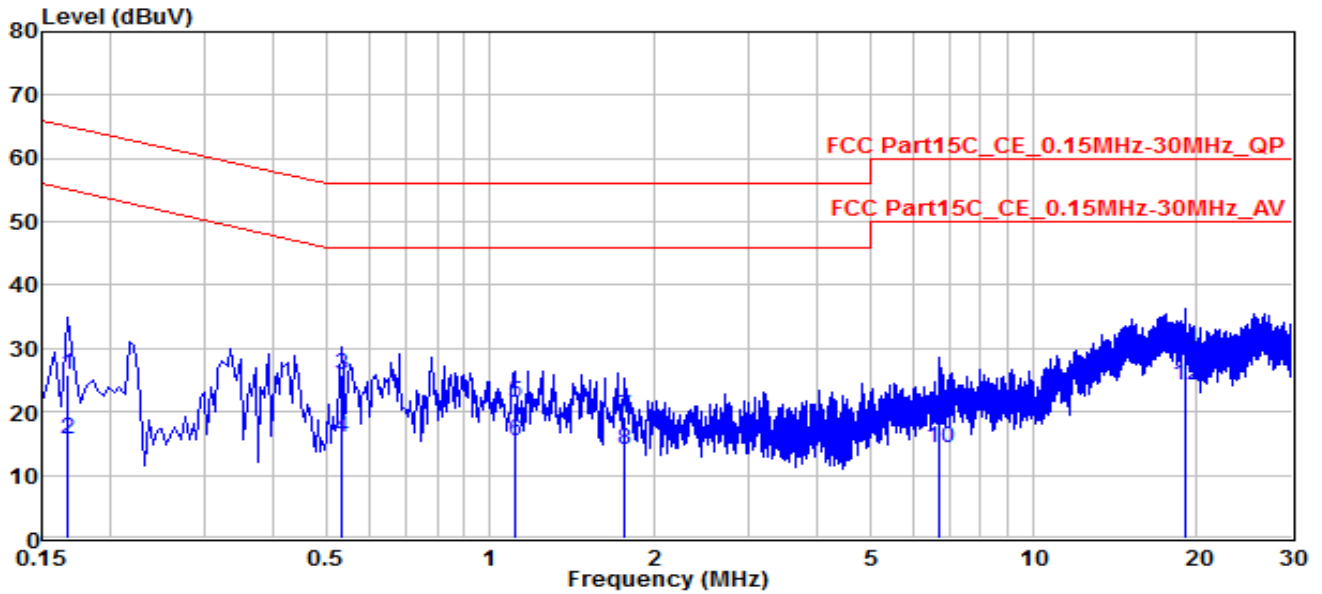

No	Frequency (MHz)	Reading (dBUV)	C.F (dB)	Measurement (dBUV)	Margin (dB)	Limit (dBUV)	Remark (QP/PK/AV)
1	0.168	15.71	10.11	25.82	-39.24	65.06	QP
2	0.168	5.5	10.11	15.61	-39.45	55.06	Average
3	* 0.53246	15.83	10.11	25.94	-30.06	56	QP
4	0.53246	5.81	10.11	15.92	-30.08	46	Average
5	1.113	11.46	9.88	21.34	-34.66	56	QP
6	1.113	5.63	9.88	15.51	-30.49	46	Average
7	1.774	9.46	9.87	19.33	-36.67	56	QP
8	1.774	4.18	9.87	14.05	-31.95	46	Average
9	6.71	9.48	9.77	19.25	-40.75	60	QP
10	6.71	4.5	9.77	14.27	-35.73	50	Average
11	19.071	19.66	10.04	29.7	-30.3	60	QP
12	* 19.071	14.26	10.04	24.3	-25.7	50	Average

Note:

- " * ", means this data is the worst emission level.
- C.F (Correction Factor) = Factor (dB)+ Cable Loss (dB).
- Measurement (dBUV) = Reading(dBUV)+ C.F (Correction Factor).

8. CONCLUSION

The data collected relate only the item(s) tested and show that the **Intel® Dual Band Wireless-AC 8265** is in compliance with Part 15C of the FCC Rules.

————— The End —————