

FCC SAR Test Report (Class II Permissive Change)

Product Name : Intel® Wireless-AC 9260
Model No. : 9260NGW

Applicant : MilDef Crete Inc.
Address : 7F, No.250, Sec.3, Pei Shen Rd., Shen Keng
District, New Taipei City Taiwan R.O.C.

Date of Receipt : 2019/06/27
Issued Date : 2019/07/19
Report No. : 1960424R-SAUSP19V00
Report Version : V1.0



The test results relate only to the samples tested.

The test results shown in the test report are traceable to the national/international standard through the calibration of the equipment and evaluated measurement uncertainty herein.

This report must not be used to claim product endorsement by TAF or any agency of the government.

The test report shall not be reproduced without the written approval of DEKRA Testing and Certification Co., Ltd.

Test Report

Issued Date: 2019/07/19

Report No.: 1960424R-SAUSP19V00



Product Name : Intel® Wireless-AC 9260
Applicant : MilDef Crete Inc.
Address : 7F, No.250, Sec.3, Pei Shen Rd., Shen Keng District, New Taipei City Taiwan R.O.C.
Manufacturer : MilDef Crete Inc.
Model No. : 9260NGW
Trade Name : Intel
FCC ID : IR5DT13
Applicable Standard : 47CFR § 2.1093
KDB 447498 D01 v06
Measurement : KDB 248227 D01 v02r02
procedures : KDB 616217 D04 V01r02
KDB 865664 D01 V01r04
Test Result : Max. SAR Measurement (1g)
2.4GHz: **0.645** W/kg
5 GHz: **0.694** W/kg
Application Type : Certification

The above equipment has been tested by DEKRA, and found compliance with the requirement of the above standards. The test record, data evaluation & Equipment Under Test (EUT) configurations represented herein are true and accurate accounts of the measurements of the sample's SAR characteristics under the conditions specified in this report.

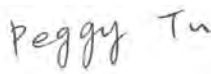
Documented By : 

(Adm. Assistant / Peggy Tu)

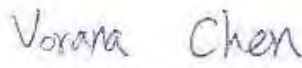
Tested By : 

(Senior Engineer / Vorana Chen)

Approved By : 

(Director / Vincent Lin)

TABLE OF CONTENTS

Description	Page
1. General Information.....	4
1.1 EUT Description.....	4
1.2 Antenna List.....	4
1.3 SAR Test Exclusion Calculation.....	5
1.4 Test Environment.....	7
2. SAR Measurement System.....	8
2.1 DASY5 System Description.....	8
2.1.1 Applications.....	9
2.1.2 Area Scans.....	9
2.1.3 Zoom Scan (Cube Scan Averaging).....	9
2.1.4 Uncertainty of Inter-/Extrapolation and Averaging.....	9
2.2 DASY5 E-Field Probe.....	10
2.2.1 Isotropic E-Field Probe Specification.....	10
2.3 Boundary Detection Unit and Probe Mounting Device.....	11
2.4 DATA Acquisition Electronics (DAE) and Measurement Server.....	11
2.5 Robot.....	12
2.6 Light Beam Unit.....	12
2.7 Device Holder.....	13
2.8 SAM Twin Phantom.....	13
3. Tissue Simulating Liquid.....	14
3.1 The composition of the tissue simulating liquid.....	14
3.2 Tissue Calibration Result.....	14
3.3 Tissue Dielectric Parameters for Head and Body Phantoms.....	16
4. SAR Measurement Procedure.....	17
4.1 SAR System Check.....	17
4.1.1 Dipoles.....	17
4.1.2 System Check Result.....	17
4.2 SAR Measurement Procedure.....	19
5. SAR Exposure Limits.....	20
6. Test Equipment List.....	21
7. Measurement Uncertainty.....	24
8. Conducted Power Measurement (Including tolerance allowed for production unit).....	26
9. Test Results.....	29
9.1 SAR Test Results Summary.....	29
9.2 Simultaneous Transmission.....	31
9.2.1 Simultaneous transmission of MIMO in 802.11 test exclusion considerations.....	31
9.2.2 simultaneous transmission of Wi-Fi and other wireless technologies.....	32
10. SAR measurement variability.....	33
Appendix	
Appendix A. SAR System Check Data	
Appendix B. SAR measurement Data	
Appendix C. Test Setup Photographs & EUT Photographs	
Appendix D. Probe Calibration Data	
Appendix E. Dipole Calibration Data	

1. General Information

1.1 EUT Description

Product Name	Intel® Wireless-AC 9260				
Trade Name	Intel				
Model No.	9260NGW				
FCC ID	IR5DT13				
TX Frequency	802.11b/g/n-20MHz:2412MHz~2472MHz 802.11n-40MHz: 2422MHz~2462MHz 802.11a/n-20:5180-5240MHz, 5745-5825MHz 802.11n-40/MHz: 5190-5230MHz, 5755-5795MHz 802.11ac-80MHz: 5210, 5775MHz BT : 2402 – 2480MHz				
Channel separation	802.11b/g/n-20MHz: 5 MHz, 802.11a/n-20MHz: 20MHz 802.11n-40MHz: 40MHz, 802.11ac-80MHz: 80MHz BT : 1MHz , BLE : 2MHz				
Number of Channels	802.11b/g/n-20MHz: 13, n-40MHz: 9 802.11a/n-20MHz: 9; 802.11n-40MHz:4,802.11ac-80MHz: 2 BT : 79 , BLE : 40				
Data Rate	802.11b: 1-11Mbps, 802.11a/g: 6-54Mbps, 802.11n: up to 300Mbps 802.11ac-80MHz: up to 866.7Mbps BT : 3Mbps , BLE : 1Mbps				
Type of Modulation	DSSS/OFDM/BPSK/QPSK/16QAM/64QAM/256QAM FHSS: GFSK(1Mbps) / π /4DQPSK(2Mbps) / 8DPSK(3Mbps)				
Antenna Type	PIFA				
Device Category	Portable				
RF Exposure Environment	Uncontrolled				
Summary of test result –Reported 1g SAR (W/Kg)					
Test configuration	DTS(Main)	DTS(Aux)	U-NII(Main)	U-NII(Aux)	DTS(BT)
Body-Standalone	0.587	0.645	0.660	0.694	0.243
Body-Simultaneous	DTS (Main + Aux)		U-NII (Main + Aux)		BT + U-NII (Main+Aux)
	1.232		1.354		1.597
When BT and WIFI transmitter does simultaneously transmitter, WIFI will transmit on Main and BT will transmit on Aux					

* Note: (1) This is to request a Class II permissive change for FCC ID: IR5DT13, originally granted on 06/20/2019

The major change filed under this application is:

Change #1: Additional Chassis added, MilDef Crete, model number: DT13.

#2: Reduce the Output Power through firmware, and SAR measurement were evaluated. (Only reduce Wi-Fi Output Power, Bluetooth Output Power haven't changes).

#3: Turn off the WLAN 5G U-NII-2A and U-NII-2C through firmware.

#4: Addition one antennas, the antenna type is same, the antenna gain is lower than the original application.

1.2 Antenna List

No.	Manufacturer	Part No.(Vendor)	Antenna Type	Peak Gain
1.	N/A	N/A	PIFA Antenna	-0.34dBi in 2.4GHz -0.74dBi for 5.15~5.25GHz -2.14dBi For 5.725~5.850GHz

1.3 SAR Test Exclusion Calculation

According to KDB Publication 447498 D01, section 4.3.1, per the calculations of item 1 $(Power(mW)/separation(mm) \cdot \sqrt{f(GHz)} \leq 3.0)$, SAR is required as shown in the table below where calculated values are greater than 3.0 :

SAR exclusion calculations for WiFi-SISO and Bluetooth for antenna < 50mm from the user :

Antenna	Tx	Frequency (MHz)	Output Power		Separation distances (mm)						Calculated Threshold Value (≤ 3.0 SAR is not required)					
			dBm	mW	Back	Right	Left	Top	Bottom	Front	Back	Right	Left	Top	Bottom	Front
Main	WiFi	2462	14	25	8	215	15	3	185	8	4.9	>50mm	2.6	7.9	>50mm	4.9
Main	WiFi	5240	13	20	8	215	15	3	185	8	5.7	>50mm	3.0	9.1	>50mm	5.7
Main	WiFi	5825	13	20	8	215	15	3	185	8	6.0	>50mm	3.2	9.6	>50mm	6.0

SAR exclusion calculations for WiFi-SISO and Bluetooth for antenna > 50mm from the user :

Antenna	Tx	Frequency (MHz)	Output Power		Separation distances (mm)						Calculated Threshold Value (SAR test exclusion power,mW)					
			dBm	mW	Back	Right	Left	Top	Bottom	Front	Back	Right	Left	Top	Bottom	Front
Main	WiFi	2462	14	25	8	215	15	3	185	8	<50mm	1745.6	<50mm	<50mm	1445.6	<50mm
Main	WiFi	5240	13	20	8	215	15	3	185	8	<50mm	1715.5	<50mm	<50mm	1415.5	<50mm
Main	WiFi	5825	13	20	8	215	15	3	185	8	<50mm	1715.0	<50mm	<50mm	1415.0	<50mm

SAR exclusion calculations for WiFi-SISO and Bluetooth for antenna < 50mm from the user :

Antenna	Tx	Frequency (MHz)	Output Power		Separation distances (mm)						Calculated Threshold Value (≤ 3.0 SAR is not required)					
			dBm	mW	Back	Right	Left	Top	Bottom	Front	Back	Right	Left	Top	Bottom	Front
Aux	WiFi	2462	14	25	8	3	245	12	160	8	4.9	7.9	>50mm	3.3	>50mm	4.9
Aux	WiFi	5240	13	20	8	3	245	12	160	8	5.7	9.1	>50mm	3.8	>50mm	5.7
Aux	WiFi	5825	13	20	8	3	245	12	160	8	6.0	9.6	>50mm	4.0	>50mm	6.0
Aux	BT	2480	11	13	8	3	245	12	160	8	2.5	4.0	>50mm	1.7	>50mm	2.5

SAR exclusion calculations for WiFi-SISO and Bluetooth for antenna > 50mm from the user :

Antenna	Tx	Frequency (MHz)	Output Power		Separation distances (mm)						Calculated Threshold Value (SAR test exclusion power,mW)					
			dBm	mW	Back	Right	Left	Top	Bottom	Front	Back	Right	Left	Top	Bottom	Front
Aux	WiFi	2462	14	25	8	3	245	12	160	8	<50mm	<50mm	2045.6	<50mm	1195.6	<50mm
Aux	WiFi	5240	13	20	8	3	245	12	160	8	<50mm	<50mm	2015.5	<50mm	1165.5	<50mm
Aux	WiFi	5825	13	20	8	3	245	12	160	8	<50mm	<50mm	2012.2	<50mm	1162.2	<50mm
Aux	BT	2480	11	13	8	3	245	12	160	8	<50mm	<50mm	2045.3	<50mm	1195.3	<50mm

1.4 Test Environment

Ambient conditions in the laboratory:

Test Date: Jul. 12, 2019

Items	Required	Actual
Temperature (°C)	18-25	22.5± 2
Humidity (%RH)	30-70	54

Test Date: Jul. 16, 2019

Items	Required	Actual
Temperature (°C)	18-25	23.4± 2
Humidity (%RH)	30-70	54

The related certificate for our laboratories about the test site and management system can be downloaded

from DEKRA Testing and Certification Co., Ltd. Web Site:

<http://www.dekra.com.tw/english/about/certificates.aspx?bval=5>

The address and introduction of DEKRA Testing and Certification Co., Ltd. laboratories can be founded in our Web site: http://www.dekra.com.tw/index_en.aspx

Site Description: Accredited by TAF
Accredited Number: 3023

Site Name: DEKRA Testing and Certification Co., Ltd
Site Address: No.5-22, Ruishukeng, Linkou Dist., New Taipei City 24451,
Taiwan, R.O.C.
TEL : 886-2-8601-3788 / FAX : 886-2-8601-3789
E-Mail : info.tw@dekra.com

2. SAR Measurement System

2.1 DASY5 System Description

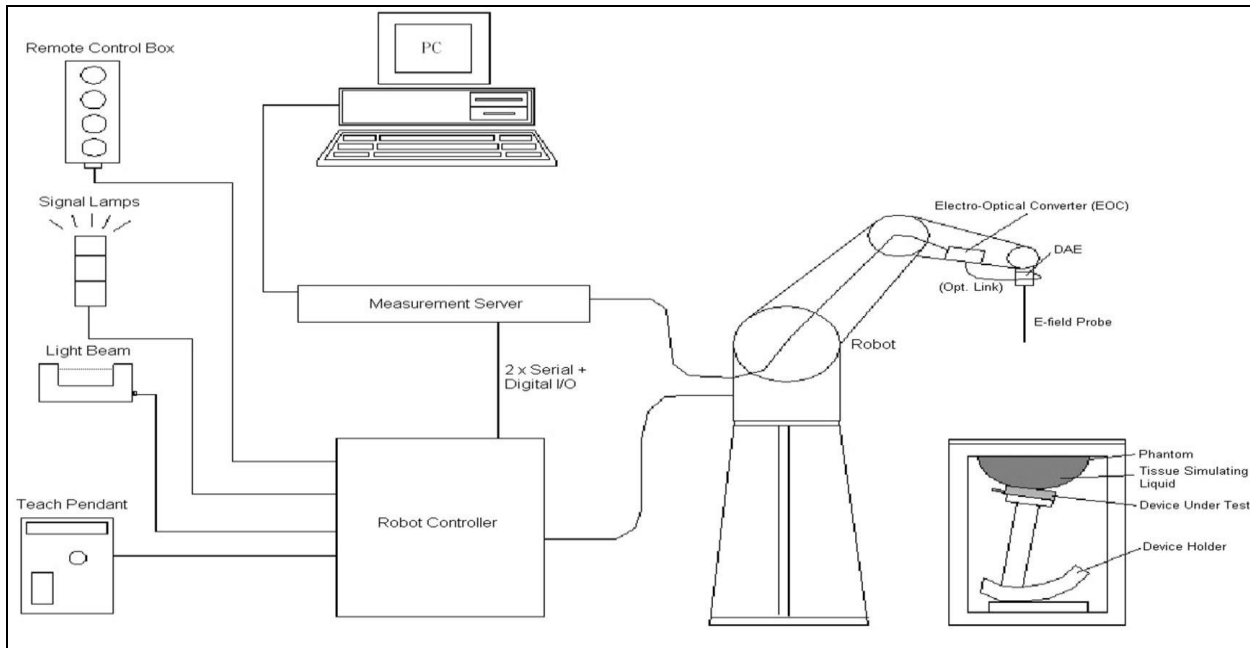

The DASY5 system for performing compliance tests consists of the following items:

- A standard high precision 6-axis robot with controller, teach pendant and software. An arm extension for accommodating the data acquisition electronics (DAE).
- A data acquisition electronics (DAE) which performs the signal amplification, signal multiplexing, AD-conversion, offset measurements, mechanical surface detection, collision detection, etc. The unit is battery powered with standard or rechargeable batteries. The signal is optically transmitted to the EOC.
- The Electro-optical converter (EOC) performs the conversion from optical to electrical signals for the digital communication to the DAE. To use optical surface detection, a special version of the EOC is required. The EOC signal is transmitted to the measurement server.
- The Light Beam used is for probe alignment. This improves the (absolute) accuracy of the probe positioning.
- A computer running WinXP and the DASY5 software.
- Remote control and teach pendant as well as additional circuitry for robot safety such as warning lamps, etc.
- The phantom, the device holder and other accessories according to the targeted measurement.

2.1.1 Applications

Predefined procedures and evaluations for automated compliance testing with all worldwide standards, e.g., IEEE 1528, OET 65, IEC 62209-1, IEC 62209-2, EN 50360, EN 50383 and others.

2.1.2 Area Scans

Area scans are defined prior to the measurement process being executed with a user defined variable spacing between each measurement point (integral) allowing low uncertainty measurements to be conducted. Scans defined for FCC applications utilize a 10mm² step integral, with 1mm interpolation used to locate the peak SAR area used for zoom scan assessments.

When an Area Scan has measured all reachable points, it computes the field maxima found in the scanned area, within a range of the global maximum. The range (in dB) is specified in the standards for compliance testing. For example, a 2 dB range is required in IEEE 1528-2013, EN 50361 and IEC 62209 standards, whereby 3 dB is a requirement when compliance is assessed in accordance with the ARIB standard (Japan).

2.1.3 Zoom Scan (Cube Scan Averaging)

Zoom Scans are used to assess the peak spatial SAR values within a cubic averaging volume containing 1 g and 10 g of simulated tissue. A density of 1000 kg/m³ is used to represent the head and body tissue density and not the phantom liquid density, in order to be consistent with the definition of the liquid dielectric properties, i.e. the side length of the 1 g cube is 10mm, with the side length of the 10 g cube 21,5mm.

The zoom scan integer steps can be user defined so as to reduce uncertainty, but normal practice for typical test applications (including FCC) utilize a physical step of 5x5x7 (8mmx8mmx5mm) providing a volume of 32mm in the X & Y axis, and 30mm in the Z axis.

2.1.4 Uncertainty of Inter-/Extrapolation and Averaging

In order to evaluate the uncertainty of the interpolation, extrapolation and averaged SAR calculation algorithms of the Postprocessor, DASY5 allows the generation of measurement grids which are artificially predefined by analytically based test functions. Therefore, the grids of area scans and zoom scans can be filled with uncertainty test data, according to the SAR benchmark functions of IEEE 1528. The three analytical functions shown in equations as below are used to describe the possible range of the expected SAR distributions for the tested handsets. The field gradients are covered by the spatially flat

distribution f_1 , the spatially steep distribution f_3 and f_2 accounts for H-field cancellation on the phantom/tissue surface.

$$f_1(x, y, z) = Ae^{-\frac{z}{2a}} \cos^2 \left(\frac{\pi \sqrt{x'^2 + y'^2}}{2 \cdot 5a} \right)$$

$$f_2(x, y, z) = Ae^{-\frac{z}{a}} \frac{a^2}{a^2 + x'^2} \left(3 - e^{-\frac{2z}{a}} \right) \cos^2 \left(\frac{\pi y'}{2 \cdot 3a} \right)$$

$$f_3(x, y, z) = A \frac{a^2}{\frac{a^2}{4} + x'^2 + y'^2} \left(e^{-\frac{2z}{a}} + \frac{a^2}{2(a + 2z)^2} \right)$$

2.2 DASY5 E-Field Probe

The SAR measurement is conducted with the dosimetric probe manufactured by SPEAG. The probe is specially designed and calibrated for use in liquid with high permittivity. The dosimetric probe has special calibration in liquid at different frequency.

SPEAG conducts the probe calibration in compliance with international and national standards (e.g. IEEE 1528, EN 62209-1, IEC 62209, etc.) under ISO 17025. The calibration data are in Appendix D.

2.2.1 Isotropic E-Field Probe Specification

Model	Ex3DV4	
Construction	Symmetrical design with triangular core Built-in shielding against static charges PEEK enclosure material (resistant to organic solvents, e.g., DGBE)	
Frequency	10 MHz to 6 GHz Linearity: ± 0.2 dB (30 MHz to 6 GHz)	
Directivity	± 0.3 dB in HSL (rotation around probe axis) ± 0.5 dB in tissue material (rotation normal to probe axis)	
Dynamic Range	10 μ W/g to 100 mW/g Linearity: ± 0.2 dB (noise: typically < 1 μ W/g)	
Dimensions	Overall length: 330 mm (Tip: 20 mm) Tip diameter: 2.5 mm (Body: 12 mm) Typical distance from probe tip to dipole centers: 1 mm	
Application	High precision dosimetric measurements in any exposure scenario (e.g., very strong gradient fields). Only probe which enables compliance testing for frequencies up to 6 GHz with precision of better 30%.	

2.3 Boundary Detection Unit and Probe Mounting Device

The DASY probes use a precise connector and an additional holder for the probe, consisting of a plastic tube and a flexible silicon ring to center the probe. The connector at the DAE is flexibly mounted and held in the default position with magnets and springs. Two switching systems in the connector mount detect frontal and lateral probe collisions and trigger the necessary software response.



2.4 DATA Acquisition Electronics (DAE) and Measurement Server

The data acquisition electronics (DAE) consists of a highly sensitive electrometer-grade preamplifier with auto-zeroing, a channel and gain-switching multiplexer, a fast 16 bit AD-converter and a command decoder and control logic unit.

Transmission to the measurement server is accomplished through an optical downlink for data and status information as well as an optical uplink for commands and the clock.

The input impedance of the DAE4 is 200M Ohm; the inputs are symmetrical and floating. Common mode rejection is above 80dB.



The DASY5 measurement server is based on a PC/104 CPU board with a 400MHz intel ULV Celeron, 128MB chipdisk and 128MB RAM. The necessary circuits for communication with the DAE electronics box, as well as the 16 bit AD converter system for optical detection and digital I/O interface are contained on the DASY5 I/O board, which is directly connected to the PC/104 bus of the CPU board.



2.5 Robot

The DASY5 system uses the high precision robots TX90 XL type out of the newer series from Stäubli SA (France). For the 6-axis controller DASY5 system, the CS8C robot controller version from Stäubli is used.

The XL robot series have many features that are important for our application:

- High precision (repeatability 0.02 mm)
- High reliability (industrial design)
- Jerk-free straight movements
- Low ELF interference (the closed metallic construction shields against motor control fields)
- 6-axis controller



2.6 Light Beam Unit

The light beam switch allows automatic "tooling" of the probe. During the process, the actual position of the probe tip with respect to the robot arm is measured, as well as the probe length and the horizontal probe offset. The software then corrects all movements, such that the robot coordinates are valid for the probe tip.

The repeatability of this process is better than 0.1 mm. If a position has been taught with an aligned probe, the same position will be reached with another aligned probe within 0.1 mm, even if the other probe has different dimensions. During probe rotations, the probe tip will keep its actual position.



2.7 Device Holder

The DASY5 device holder is designed to cope with different positions given in the standard. It has two scales for the device rotation (with respect to the body axis) and the device inclination (with respect to the line between the ear reference points). The rotation center for both scales is the ear reference point (EPR).

Thus the device needs no repositioning when changing the angles.

The DASY5 device holder has been made out of low-loss POM material having the following dielectric parameters: relative permittivity $\epsilon_r = 3$ and loss tangent $\delta = 0.02$. The amount of dielectric material has been reduced in the closest vicinity of the device, since measurements have suggested that the influence of the clamp on the test results could thus be lowered.



2.8 SAM Twin Phantom

The SAM twin phantom is a fiberglass shell phantom with 2mm shell thickness (except the ear region where shell thickness increases to 6mm). It has three measurement areas:

- Left head
- Right head
- Flat phantom



The bottom plate contains three pair of bolts for locking the device holder. The device holder positions are adjusted to the standard measurement positions in the three sections. A white cover is provided to tap the phantom during off-periods to prevent water evaporation and changes in the liquid parameters. On the phantom top, three reference markers are provided to identify the phantom position with respect to the robot.

3. Tissue Simulating Liquid

3.1 The composition of the tissue simulating liquid

INGREDIENT (% Weight)	2450MHz Body	5200MHz Body	5800MHz Body
Water	73.2	76	75.68
Salt	0.04	0.00	0.00
Sugar	0.00	0.00	0.00
HEC	0.00	0.00	0.00
Preventol	0.00	0.00	0.00
DGBE	26.76	4.44	4.42
Triton X-100	0.00	19.56	19.47

3.2 Tissue Calibration Result

The dielectric parameters of the liquids were verified prior to the SAR evaluation using APREL Dielectric Probe Kit and Agilent E5071C Vector Network Analyzer.

Body Tissue Simulate Measurement				
Frequency [MHz]	Description	Dielectric Parameters		Tissue Temp. [°C]
		ϵ_r	σ [s/m]	
2450 MHz	Reference result $\pm 5\%$ window	52.7 50.07 to 55.34	1.95 1.85 to 2.05	N/A
	12-Jul-19	53.15	1.99	21.6°C
2412 MHz	Low Channel	53.64	1.94	21.6°C
2437 MHz	Mid Channel	53.35	1.96	21.6°C
2480 MHz	High Channel	52.81	2.03	21.6°C

Body Tissue Simulate Measurement				
Frequency [MHz]	Description	Dielectric Parameters		Tissue Temp. [°C]
		ϵ_r	σ [s/m]	
5200MHz	Reference result $\pm 5\%$ window	49.01 46.56 to 51.47	5.3 5.03 to 5.56	N/A
	16-Jul-19	49.76	5.34	22.2°C
5210 MHz	Channel 42	49.72	5.35	22.2°C

Body Tissue Simulate Measurement				
Frequency [MHz]	Description	Dielectric Parameters		Tissue Temp. [°C]
		ϵ_r	σ [s/m]	
5800MHz	Reference result $\pm 5\%$ window	48.2 45.79 to 50.61	6 5.7 to 6.3	N/A
	16-Jul-19	48.11	6.27	22.2°C
5775 MHz	Channel 155	48.23	6.24	22.2°C

3.3 Tissue Dielectric Parameters for Head and Body Phantoms

The head tissue dielectric parameters recommended by the IEEE SCC-34/SC-2 in P1528 have been incorporated in the following table. These head parameters are derived from planar layer models simulating the highest expected SAR for the dielectric properties and tissue thickness variations in a human head. Other head and body tissue parameters that have not been specified in P1528 are derived from the tissue dielectric parameters computed from the 4-Cole-Cole equations described in Reference [12] and extrapolated according to the head parameters specified in P1528.

Target Frequency (MHz)	Head		Body	
	ϵ_r	σ (S/m)	ϵ_r	σ (S/m)
150	52.3	0.76	61.9	0.80
300	45.3	0.87	58.2	0.92
450	43.5	0.87	56.7	0.94
835	41.5	0.90	55.2	0.97
900	41.5	0.97	55.0	1.05
915	41.5	0.98	55.0	1.06
1450	40.5	1.20	54.0	1.30
1610	40.3	1.29	53.8	1.40
1800 – 2000	40.0	1.40	53.3	1.52
2450	39.2	1.80	52.7	1.95
3000	38.5	2.40	52.0	2.73
5800	35.3	5.27	48.2	6.00

(ϵ_r = relative permittivity, σ = conductivity and $\rho = 1000 \text{ kg/m}^3$)

4. SAR Measurement Procedure

4.1 SAR System Check

4.1.1 Dipoles

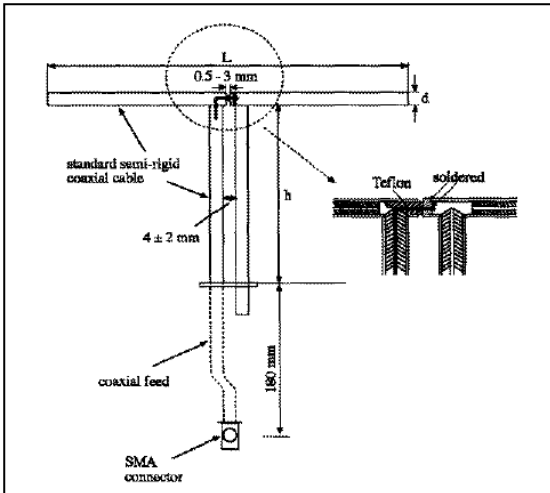

The dipoles used is based on the IEEE-1528 standard, and is complied with mechanical and electrical specifications in line with the requirements of both IEEE and FCC Supplement C. the table below provides details for the mechanical and electrical specifications for the dipoles.

Frequency	L (mm)	h (mm)	d (mm)
2450MHz	51.5	30.4	3.6
5200M~5800MHz	20.6	40.3	3.6

4.1.2 System Check Result

System Performance Check at 2450MHz				
Dipole Kit: D2450V2				
Frequency [MHz]	Description	SAR [w/kg] 1g	SAR [w/kg] 10g	Tissue Temp. [°C]
2450 MHz	Reference result ± 10% window	50.6 45.54 to 55.66	23.9 21.51 to 26.29	N/A
	12-Jul-19	50.4	23.48	21.6°C
Note: (1) The power level is used 250mW (2) All SAR values are normalized to 1W forward power. (3) The reference result is from Appendix E.				

System Performance Check at 5200MHz				
Dipole Kit: D5GHzV2				
Frequency [MHz]	Description	SAR [w/kg] 1g	SAR [w/kg] 10g	Tissue Temp. [°C]
5200 MHz	Reference result ± 10% window	74.7 67.23 to 82.17	21.0 18.90 to 23.10	N/A
	16-Jul-19	81.8	22.8	22.2°C
Note: (1) The power level is used 100mW (2) All SAR values are normalized to 1W forward power. (3) The reference result is from Appendix E.				

System Performance Check at 5800MHz				
Dipole Kit: D5GHzV2				
Frequency [MHz]	Description	SAR [w/kg] 1g	SAR [w/kg] 10g	Tissue Temp. [°C]
5800 MHz	Reference result ± 10% window	78.3 70.47 to 86.13	21.7 19.53 to 23.87	N/A
	16-Jul-19	81.9	22.7	22.2°C
Note: (1) The power level is used 100mW (2) All SAR values are normalized to 1W forward power. (3) The reference result is from Appendix E.				

4.2 SAR Measurement Procedure

The Dasy5 calculates SAR using the following equation,

$$SAR = \frac{\sigma |E|^2}{\rho}$$

σ : represents the simulated tissue conductivity

ρ : represents the tissue density

The EUT is set to transmit at the required power in line with product specification, at each frequency relating to the LOW, MID, and HIGH channel settings.

Pre-scans are made on the device to establish the location for the transmitting antenna, using a large area scan in either air or tissue simulation fluid.

The EUT is placed against the Universal Phantom where the maximum area scan dimensions are larger than the physical size of the resonating antenna. When the scan size is not large enough to cover the peak SAR distribution, it is modified by either extending the area scan size in both the X and Y directions, or the device is shifted within the predefined area.

The area scan is then run to establish the peak SAR location (interpolated resolution set at 1mm²) which is then used to orient the center of the zoom scan. The zoom scan is then executed and the 1g and 10g averages are derived from the zoom scan volume (interpolated resolution set at 1mm³).

5. SAR Exposure Limits

SAR assessments have been made in line with the requirements of IEEE-1528, FCC Supplement C, and comply with ANSI/IEEE C95.1-1992 “Uncontrolled Environments” limits. These limits apply to a location which is deemed as “Uncontrolled Environment” which can be described as a situation where the general public may be exposed to an RF source with no prior knowledge or control over their exposure.

Limits for General Population/Uncontrolled Exposure (W/kg)

Type Exposure	Uncontrolled Environment Limit
Spatial Peak SAR (1g cube tissue for brain or body)	1.60 W/kg
Spatial Average SAR (whole body)	0.08 W/kg
Spatial Peak SAR (10g for hands, feet, ankles and wrist)	4.00 W/kg

6. Test Equipment List

Instrument	Manufacturer	Model No.	Serial No.	Last Calibration	Next Calibration
Stäubli Robot TX60L	Stäubli	TX60L	F09/5BL1A1/A06	2009/05/18	only once
Controller	Speag	CS8c	N/A	2009/05/18	only once
Reference Dipole 2450MHz	Speag	D2450V2	930	2016/11/15	2019/11/14
Reference Dipole 5GHz	Speag	D5GHzV2	1041	2017/05/26	2020/05/25
SAM Twin Phantom	Speag	QD000 P40 CA	Tp 1515	N/A	N/A
Device Holder	Speag	N/A	N/A	N/A	N/A
Data Acquisition Electronic	Speag	DAE4	1425	2018/11/16	2019/11/15
E-Field Probe	Speag	EX3DV4	3979	2018/11/22	2019/11/21
SAR Software	Speag	DASY52	V52.10.0.1446	N/A	N/A
Apral Dipole Spaccer	Apral	ALS-DS-U	QTK-295	N/A	N/A
Power Amplifier	Mini-Circuit	ZHL-42	D051404-20	N/A	N/A
Directional Coupler	Agilent	87300C	MY44300353	N/A	N/A
Vector Network	Agilent	E5071C	MY46106342	2018/09/05	2019/09/04
Signal Generator	Anritsu	MG3694A	041902	2018/08/27	2019/08/26
Power Meter	Anritsu	ML2487A	6K00001447	2018/10/23	2019/10/22
Wide Bandwidth Sensor	Anritsu	MA2411B	1339194	2018/10/23	2019/10/22
Temperature	WISEWIND	1710	1710	2019/06/18	2020/06/17

Note:

Per KDB 865664 D01 requirements for dipole calibration, the following are recommended FCC procedures for SAR dipole calibration.

1. After a dipole is damaged and properly repaired to meet required specifications
2. When the measured SAR deviates from the calibrated SAR value by more than 10% due to changes in physical, mechanical, electrical or other relevant dipole conditions;
3. When the most recent return-loss, measured at least annually, deviates by more than 20% from the previous measurement (i.e. 0.2 of the dB value) or not meeting the required -20 dB return-loss specification

	Frequency	Tissue	Return loss	Limit	Verified Date
Calibration	2450	Body	-27.98dB	Within 20%	2016.11.15
Measurement	2450	Body	-28.02dB		2017.11.16
Measurement	2450	Body	-27.79dB		2018.11.13

	Frequency	Tissue	Return loss	Limit	Verified Date
Calibration	5200	Body	-24.00dB	Within 20%	2017.05.26
Measurement	5200	Body	-23.68dB		2018.05.25
Measurement	5200	Body	-21.18dB		2019.05.25

	Frequency	Tissue	Return loss	Limit	Verified Date
Calibration	5300	Body	-31.47dB	Within 20%	2017.05.26
Measurement	5300	Body	-28.08dB		2018.05.25
Measurement	5300	Body	-30.66dB		2019.05.25

	Frequency	Tissue	Return loss	Limit	Verified Date
Calibration	5600	Body	-24.25dB	Within 20%	2017.05.26
Measurement	5600	Body	-26.47dB		2018.05.25
Measurement	5600	Body	-22.06dB		2019.05.25

	Frequency	Tissue	Return loss	Limit	Verified Date
Calibration	5800	Body	-24.72dB	Within 20%	2017.05.26
Measurement	5800	Body	-23.63dB		2018.05.25
Measurement	5800	Body	-20.87dB		2019.05.25

4. When the most recent measurement of the real or imaginary parts of the impedance, measured at least annually, deviates by more than 5 Ω from the previous measurement

	Frequency	Tissue	Impedance	Limit	Verified Date
Calibration	2450	Body	50.03	Within 5 Ω	2016.11.15
Measurement	2450	Body	50.22		2017.11.16
Measurement	2450	Body	50.56		2018.11.13

	Frequency	Tissue	Impedance	Limit	Verified Date
Calibration	5200	Body	49.02	Within 5 Ω	2017.05.26
Measurement	5200	Body	49.79		2018.05.25
Measurement	5200	Body	48.00		2019.05.25

	Frequency	Tissue	Impedance	Limit	Verified Date
Calibration	5300	Body	48.43	Within 5 Ω	2017.05.26
Measurement	5300	Body	51.83		2018.05.25
Measurement	5300	Body	47.36		2019.05.25

	Frequency	Tissue	Impedance	Limit	Verified Date
Calibration	5600	Body	56.52	Within 5 Ω	2017.05.26
Measurement	5600	Body	52.87		2018.05.25
Measurement	5600	Body	52.19		2019.05.25

	Frequency	Tissue	Impedance	Limit	Verified Date
Calibration	5800	Body	56.16	Within 5 Ω	2017.05.26
Measurement	5800	Body	56.49		2018.05.25
Measurement	5800	Body	53.00		2019.05.25

7. Measurement Uncertainty

DASY5 Uncertainty (According to IEEE 1528-2013)								
Measurement uncertainty for 30 MHz to 3 GHz								
Error Description	Uncert. value	Prob. Dist.	Div.	(ci) 1g	(ci) 10g	Std. Unc. (1g)	Std. Unc. (10g)	(vi) V _{eff}
Measurement System								
Probe Calibration	±6%	N	1	1	1	±6.0%	±6.0%	∞
Axial Isotropy	±4.7%	R	$\sqrt{3}$	0.7	0.7	±1.9%	±1.9%	∞
Hemispherical Isotropy	±9.6%	R	$\sqrt{3}$	0.7	0.7	±3.9%	±3.9%	∞
Boundary Effects	±1.0%	R	$\sqrt{3}$	1	1	±0.6%	±0.6%	∞
Linearity	±4.7%	R	$\sqrt{3}$	1	1	±2.7%	±2.7%	∞
System Detection Limits	±1.0%	R	$\sqrt{3}$	1	1	±0.6%	±0.6%	∞
Modulation Response	±2.4%	R	$\sqrt{3}$	1	1	±1.4%	±1.4%	∞
Readout Electronics	±0.3%	N	1	1	1	±0.3%	±0.3%	∞
Response Time	±0.8%	R	$\sqrt{3}$	1	1	±0.5%	±0.5%	∞
Integration Time	±2.6%	R	$\sqrt{3}$	1	1	±1.5%	±1.5%	∞
RF Ambient Noise	±3.0%	R	$\sqrt{3}$	1	1	±1.7%	±1.7%	∞
RF Ambient Reflections	±3.0%	R	$\sqrt{3}$	1	1	±1.7%	±1.7%	∞
Probe Positioner	±0.4%	R	$\sqrt{3}$	1	1	±0.2%	±0.2%	∞
Probe Positioning	±2.9%	R	$\sqrt{3}$	1	1	±1.7%	±1.7%	∞
Max. SAR Eval.	±4.0%	R	$\sqrt{3}$	1	1	±1.2%	±1.2%	∞
Test Sample Related								
Device Positioning	±2.9%	N	1	1	1	±2.9%	±2.9%	145
Device Holder	±3.6%	N	1	1	1	±3.6%	±3.6%	5
Power Drift	±5.0%	R	$\sqrt{3}$	1	1	±2.9%	±2.9%	∞
Power Scaling	±0%	R	$\sqrt{3}$	1	1	±0.0%	±0.0%	
Phantom and Setup								
Phantom Uncertainty	±6.1%	R	$\sqrt{3}$	1	1	±3.5%	±3.5%	∞
SAR correction	±1.9%	R	$\sqrt{3}$	1	0.84	±1.1%	±0.9%	∞
Liquid Conductivity (meas.)	±2.5%	R	$\sqrt{3}$	0.78	0.71	±1.1%	±1.0%	∞
Liquid Permittivity (meas.)	±2.5%	R	$\sqrt{3}$	0.26	0.26	±0.3%	±0.4%	∞
Temp. unc. - Conductivity	±3.4%	R	$\sqrt{3}$	0.78	0.71	±1.5%	±1.4%	∞
Temp. unc. - Permittivity	±0.4%	R	$\sqrt{3}$	0.23	0.26	±0.1%	±0.1%	∞
Combined Std. Uncertainty						±11.2%	±11.1%	361
Expanded STD Uncertainty						±22.3%	±22.2%	

DASY5 Uncertainty (According to IEEE 1528-2013)								
Measurement uncertainty for 3GHz to 6 GHz								
Error Description	Uncert. value	Prob. Dist.	Div.	(ci) 1g	(ci) 10g	Std. Unc. (1g)	Std. Unc. (10g)	(vi) V _{eff}
Measurement System								
Probe Calibration	±6.55%	N	1	1	1	±6.55%	±6.55%	∞
Axial Isotropy	±4.7%	R	$\sqrt{3}$	0.7	0.7	±1.9%	±1.9%	∞
Hemispherical Isotropy	±9.6%	R	$\sqrt{3}$	0.7	0.7	±3.9%	±3.9%	∞
Boundary Effects	±2.0%	R	$\sqrt{3}$	1	1	±1.2%	±1.2%	∞
Linearity	±4.7%	R	$\sqrt{3}$	1	1	±2.7%	±2.7%	∞
System Detection Limits	±1.0%	R	$\sqrt{3}$	1	1	±0.6%	±0.6%	∞
Modulation Response	±2.4%	R	$\sqrt{3}$	1	1	±1.4%	±1.4%	∞
Readout Electronics	±0.3%	N	1	1	1	±0.3%	±0.3%	∞
Response Time	±0.8%	R	$\sqrt{3}$	1	1	±0.5%	±0.5%	∞
Integration Time	±2.6%	R	$\sqrt{3}$	1	1	±1.5%	±1.5%	∞
RF Ambient Noise	±3.0%	R	$\sqrt{3}$	1	1	±1.7%	±1.7%	∞
RF Ambient Reflections	±3.0%	R	$\sqrt{3}$	1	1	±1.7%	±1.7%	∞
Probe Positioner	±0.8%	R	$\sqrt{3}$	1	1	±0.5%	±0.5%	∞
Probe Positioning	±6.7%	R	$\sqrt{3}$	1	1	±3.9%	±3.9%	∞
Post-processing	±4.0%	R	$\sqrt{3}$	1	1	±2.3%	±2.3%	∞
Test Sample Related								
Device Positioning	±2.9%	N	1	1	1	±2.9%	±2.9%	145
Device Holder	±3.6%	N	1	1	1	±3.6%	±3.6%	5
Power Drift	±5.0%	R	$\sqrt{3}$	1	1	±2.9%	±2.9%	∞
Power Scaling	±0%	R	$\sqrt{3}$	1	1	±0.0%	±0.0%	
Phantom and Setup								
Phantom Uncertainty	±6.6%	R	$\sqrt{3}$	1	1	±3.8%	±3.8%	∞
SAR correction	±1.9%	R	$\sqrt{3}$	1	1	±1.1%	±0.9%	∞
Liquid Conductivity (meas.)	±2.5%	R	$\sqrt{3}$	1	0.84	±1.1%	±1.0%	∞
Liquid Permittivity (meas.)	±2.5%	R	$\sqrt{3}$	0.26	0.26	±0.3%	±0.4%	∞
Temp. unc. - Conductivity	±3.4%	R	$\sqrt{3}$	0.78	0.71	±1.5%	±1.4%	∞
Temp. unc. - Permittivity	±0.4%	R	$\sqrt{3}$	0.23	0.26	±0.1%	±0.1%	∞
Combined Std. Uncertainty						±12.3%	±12.2%	748
Expanded STD Uncertainty						±24.6%	±24.5%	

8. Conducted Power Measurement (Including tolerance allowed for production unit)

WLAN 2.4G 2TX SISO

DSSS/OFDM mode specified maximum output power at an antenna port	Frequency	Mode	BW	SISO-Main(TX1)				SISO-Aux(TX2)			
				CH	PK Power	AV Power	AV Target	CH	PK Power	AV Power	AV Target
	WLAN 2.4GHz	b	20	1	16.01	13.90	14	1	15.77	13.83	14
			6	15.87	13.84	14	6	15.88	13.89	14	
			11	15.86	13.87	14	11	15.89	13.90	14	
			12	15.89	13.85	14	12	15.72	13.82	14	
			13	15.92	13.88	14	13	15.89	13.93	14	
	g	20	1	19.12	13.87	14	1	19.02	13.81	14	
			6	19.08	13.79	14	6	19.09	13.87	14	
			11	19.05	13.72	14	11	19.23	13.93	14	
			12	18.61	13.32	13.5	12	18.40	13.33	13.5	
			13	5.51	-5.54	-5.5	13	1.85	-5.61	-5.5	
	n(HT)	20	1	19.68	14.00	14	1	19.05	13.74	14	
			6	19.54	13.91	14	6	19.28	13.82	14	
			11	19.47	13.89	14	11	19.33	13.91	14	
			12	18.74	13.24	13.5	12	18.72	13.48	13.5	
			13	5.45	-6.26	-6	13	1.53	-6.38	-6	
		40	3	20.14	13.94	14	3	18.85	13.42	13.5	
			6	20.07	13.86	14	6	19.76	13.82	14	
			9	20.03	13.82	14	9	19.67	13.86	14	
			10	21.19	13.29	11	10	17.39	10.96	11	
			11	11.31	2.76	3	11	10.80	2.85	3	

WLAN 5G 2TX SISO

OFDM mode specified maximum output power at an antenna port	Frequency	Mode	BW	SISO-Main(TX1)			SISO-Aux(TX2)			Frequency	Mode	BW	SISO-Main(TX1)			SISO-Aux(TX2)					
				CH	AV	AV	CH	AV	AV				CH	AV	AV	CH	AV	AV	CH	AV	AV
					Power	Target		Power	Target					Power	Target		Power	Target		Power	Target
U-NII-1 (5150~5250MHz)	a	20	36	12.74	13	36	12.94	13	U-NII-2A (5250~5350MHz)	a	20	52	N/A	N/A	52	N/A	N/A				
			40	12.84	13	40	12.98	13				56	N/A	N/A	56	N/A	N/A				
			44	12.80	13	44	12.96	13				60	N/A	N/A	60	N/A	N/A				
			48	12.91	13	48	12.98	13				64	N/A	N/A	64	N/A	N/A				
	n(HT)	20	36	12.90	13	36	12.81	13		n(HT)	20	52	N/A	N/A	52	N/A	N/A				
			40	12.76	13	40	12.95	13				56	N/A	N/A	56	N/A	N/A				
			44	12.95	13	44	12.85	13				60	N/A	N/A	60	N/A	N/A				
			48	12.86	13	48	12.84	13				64	N/A	N/A	64	N/A	N/A				
		40	38	13.00	13	38	12.89	13		40	54	N/A	N/A	54	N/A	N/A					
			46	12.84	13	46	12.73	13			62	N/A	N/A	62	N/A	N/A					
	ac	80	42	12.82	13	42	12.93	13		ac	80	58	N/A	N/A	58	N/A	N/A				
	U-NII-1 + U-NII-2A										ac	160	50	N/A	N/A	50	N/A	N/A			
	U-NII-2C (5470~5650MHz)	a	20	100	N/A	N/A	100	N/A	N/A	5.65 GHz & U-NII-3 (5725~5850MHz)	a	20	149	12.90	13	149	12.92	13			
				112	N/A	N/A	112	N/A	N/A				157	13.00	13	157	12.97	13			
				116	N/A	N/A	116	N/A	N/A				165	12.89	13	165	12.82	13			
128				N/A	N/A	128	N/A	N/A	n(HT)				20	149	12.97	13	149	12.76	13		
n(HT)		20	100	N/A	N/A	100	N/A	N/A			157	12.99		13	157	12.82	13				
			112	N/A	N/A	112	N/A	N/A			165	12.81		13	165	12.78	13				
			116	N/A	N/A	116	N/A	N/A			40	134		N/A	N/A	134	N/A	N/A			
			128	N/A	N/A	128	N/A	N/A	151			12.97	13	151	12.92	13					
40		102	N/A	N/A	102	N/A	N/A	ac	80		159	12.94	13	159	12.90	13					
		110	N/A	N/A	110	N/A	N/A				20	144	N/A	N/A	144	N/A	N/A				
		118	N/A	N/A	118	N/A	N/A	40			142	N/A	N/A	142	N/A	N/A					
		126	N/A	N/A	126	N/A	N/A	138			N/A	N/A	138	N/A	N/A						
ac		80	106	N/A	N/A	106	N/A	N/A	80	155	12.80	13	155	12.90	13						
			122	N/A	N/A	122	N/A	N/A													
		160	114	N/A	N/A	114	N/A	N/A													

BT Only Support Aux

Bluetooth mode maximum output power	Frequency	Mode	Modulation	SISO-Main(TX1)				SISO-Aux(TX2)			
				CH	PK Power	AV Power	AV Target	CH	PK Power	AV Power	AV Target
BT 2.4GHz		BR	GFSK	0	N/A	N/A	N/A	0	9.03	7.65	11.00
				39	N/A	N/A	N/A	39	9.69	8.38	11.00
				78	N/A	N/A	N/A	78	10.28	8.67	11.00
		EDR	8DPSK	0	N/A	N/A	N/A	0	8.66	6.24	10.00
				39	N/A	N/A	N/A	39	9.19	6.69	10.00
				78	N/A	N/A	N/A	78	9.69	7.02	10.00
		BLE	GFSK	0	N/A	N/A	N/A	0	7.74	5.05	8.00
				19	N/A	N/A	N/A	19	8.02	5.48	8.00
				39	N/A	N/A	N/A	39	8.24	5.66	8.00

9. Test Results

9.1 SAR Test Results Summary

SAR MEASUREMENT								
Ambient Temperature (°C) : 22.5 ±2					Relative Humidity (%): 49			
Liquid Temperature (°C) : .21.6 ±2					Depth of Liquid (cm):>15			
Test Position Body	Antenna Position	Frequency		Conducted Power (dBm)		SAR 1g (W/kg)		Limit (W/kg)
		Channel	MHz	Measurement	Tune-up Limit	Measurement	Tune-up Scaled	
Test Mode: 802.11b – Main Antenna								
Top	Fixed	1	2412	13.90	14	0.574	0.587	1.6
Left-side	Fixed	1	2412	13.90	14	0.049	0.050	1.6
Back	Fixed	1	2412	13.90	14	0.140	0.143	1.6
Test Mode: 802.11b – Aux Antenna								
Top	Fixed	13	2472	13.93	14	0.153	0.155	1.6
Right-side	Fixed	13	2472	13.93	14	0.635	0.645	1.6
Back	Fixed	13	2472	13.93	14	0.154	0.157	1.6
Test Mode: BT -1M – Aux Antenna								
Right-side	Fixed	78	2480	8.67	11	0.142	0.243	1.6
<p>Note : 1. When the highest reported SAR for DSSS is adjusted by the ratio of OFDM to DSSS specified maximum output power and the adjusted SAR is ≤ 1.2 W/kg, SAR is not required.</p> <p>2. When the reported SAR of the highest measured maximum output power channel for the exposure configuration is ≤ 0.8 W/kg, no further SAR testing is required for 802.11b DSSS in that exposure configuration.</p> <p>3. Duty cycle 100%.</p>								

SAR MEASUREMENT								
Ambient Temperature (°C) : 23.4 ±2				Relative Humidity (%) : 50				
Liquid Temperature (°C) : 22.2 ±2				Depth of Liquid (cm) : >15				
Test Position Body	Antenna Position	Frequency		Conducted Power (dBm)		SAR 1g (W/kg)		Limit (W/kg)
		Channel	MHz	Measurement	Tune-up Limit	Measurement	Tune-up Scaled	
Test Mode: 802.11ac - 80M Main Antenna								
Top	Fixed	42	5210	12.82	13	0.633	0.660	1.6
Top	Fixed	155	5775	12.80	13	0.364	0.381	1.6
Back	Fixed	42	5210	12.82	13	0.222	0.231	1.6
Left-side	Fixed	42	5210	12.82	13	0.051	0.053	1.6
Test Mode: 802.11ac - 80M Aux Antenna								
Top	Fixed	42	5210	12.93	13	0.071	0.072	1.6
Back	Fixed	42	5210	12.93	13	0.120	0.122	1.6
Right-side	Fixed	42	5210	12.93	13	0.683	0.694	1.6
Right-side	Fixed	155	5775	12.9	13	0.462	0.473	1.6
Note : 1. When multiple transmission modes (802.11 n) have the same specified maximum output power, largest channel bandwidth, lowest order modulation and lowest data rate, the lowest order 802.11 mode is selected 2. When the reported SAR of the highest measured maximum output power channel for the exposure configuration is ≤ 0.8 W/kg, no further SAR testing is required in that exposure configuration. 3. Duty cycle 100%.								

9.2 Simultaneous Transmission

Simultaneous Transmission Configurations	
1	WLAN 2.4GHz Main + WLAN 2.4GHz Aux
2	WLAN 2.4GHz Main + BT Aux
3	WLAN 5GHz Main + BT Aux
4	WLAN 5GHz Main + WLAN 5GHz Aux
5	WLAN 5GHz Main + WLAN 5GHz Aux + BT Aux

9.2.1 Simultaneous transmission of MIMO in 802.11 test exclusion considerations

Frequency (GHz)	Test Position (Body)	WLAN Main SAR (W/Kg)	WLAN Aux SAR W/Kg)	Simultaneous Transmission (W/Kg)	Antenna pair in mm	Peak location separation ratio
2.4	Top/Right	0.587	0.645	1.232	N/A	N/A
5	Top/Right	0.660	0.694	1.354	N/A	N/A

Note : The sum of value is less than 1.6W/Kg or the ratio is determined by $(SAR1 + SAR2)^{1.5}/R_i$, rounded to two decimal digits, and must be ≤ 0.04 for all antenna pairs in the configuration to qualify for SAR test exclusion.

9.2.2 simultaneous transmission of Wi-Fi and other wireless technologies

When the sum of SAR is larger than the limit, The ratio is determined by $(SAR1 + SAR2)^{1.5/R_i}$, rounded to two decimal digits, and must be ≤ 0.04 for all antenna pairs in the configuration to qualify for 1-g SAR test exclusion. The estimation result as below:

For DTS Band:

Mode	WLAN Main SAR (W/Kg)	BT SAR (W/Kg)	Simultaneous Transmission (W/Kg)	Antenna pair in mm	Peak location separation ratio
Top/Right	0.587	0.243	0.830	N/A	N/A

The sum of value is less than 1.6W/Kg, thus simultaneous SAR testing is not needed.

For U-NII Band:

Mode	WLAN Main SAR (W/Kg)	BT SAR (W/Kg)	Simultaneous Transmission (W/Kg)	Antenna pair in mm	Peak location separation ratio
Right	0.694	0.243	0.937	N/A	N/A

The sum of value is less than 1.6W/Kg, thus simultaneous SAR testing is not needed.

Mode	WLAN Main SAR (W/Kg)	WLAN Aux SAR (W/Kg)	BT SAR (W/Kg)	Simultaneous Transmission (W/Kg)	Antenna pair in mm	Peak location separation ratio
Top/Right	0.660	0.694	0.243	1.597	N/A	N/A

The ratio of value is less than 0.04, thus simultaneous SAR testing is not needed.

10. SAR measurement variability

- 1) Repeated measurement is not required when the original highest measured SAR is < 0.80 W/kg; steps 2) through 4) do not apply.
- 2) When the original highest measured SAR is ≥ 0.80 W/kg, repeat that measurement once.
- 3) Perform a second repeated measurement only if the ratio of largest to smallest SAR for the original and first repeated measurements is > 1.20 or when the original or repeated measurement is ≥ 1.45 W/kg (~ 10% from the 1-g SAR limit).
- 4) Perform a third repeated measurement only if the original, first or second repeated measurement is ≥ 1.5 W/kg and the ratio of largest to smallest SAR for the original, first and second repeated measurements is > 1.20 .

Frequency		SAR 1g (W/kg)						
Channel	MHz	Original	First Repeated		Second Repeated		Third Repeated	
			Value	Ratio	Value	Ratio	Value	Ratio
6	2472	0.635	N/A	N/A	N/A	N/A	N/A	N/A
42	5210	0.683	N/A	N/A	N/A	N/A	N/A	N/A

Appendix

Appendix A. SAR System Check Data

Appendix B. SAR measurement Data

Appendix C. Test Setup Photographs & EUT Photographs

Appendix D. Probe Calibration Data

Appendix E. Dipole Calibration Data

Appendix A. SAR System Check Data

Test Laboratory: DEKRA

Date/Time: 2019/07/12

System Performance Check_2450MHz-Body

DUT: Dipole 2450 MHz; Type: D2450V2

Communication System: UID 0, CW; Frequency: 2450 MHz;

Communication System PAR: 0 dB

Medium parameters used: $f = 2450$ MHz; $\sigma = 1.99$ S/m; $\epsilon_r = 53.15$; $\rho = 1000$ kg/m³

Phantom section: Flat Section

Ambient Temperature (°C) : 22.5, Liquid Temperature (°C) : 21.6

Measurement Standard: DASYS (IEEE/IEC/ANSI C63.19-2011)

DASY5 Configuration:

- Probe: EX3DV4 - SN3979; ConvF(7.5, 7.5, 7.5); Calibrated: 2018/11/22;
- Sensor-Surface: 4mm (Mechanical Surface Detection)
- Electronics: DAE4 Sn1425; Calibrated: 2018/11/16
- Phantom: SAM with left table; Type: SAM;
- Measurement SW: DASYS2, Version 52.10 (0); SEMCAD X Version 14.6.10 (7417)

Configuration/2450MHz Body/Area Scan (9x9x1): Measurement grid: dx=12mm, dy=12mm

Maximum value of SAR (measured) = 14.2 W/kg

Configuration/2450MHz Body/Zoom Scan (7x7x7) (7x7x7)/Cube 0:

Measurement grid: dx=5mm, dy=5mm, dz=5mm

Reference Value = 84.92 V/m; Power Drift = 0.09 dB

Peak SAR (extrapolated) = 25.7 W/kg

SAR(1 g) = 12.6 W/kg; SAR(10 g) = 5.87 W/kg

Maximum value of SAR (measured) = 14.4 W/kg

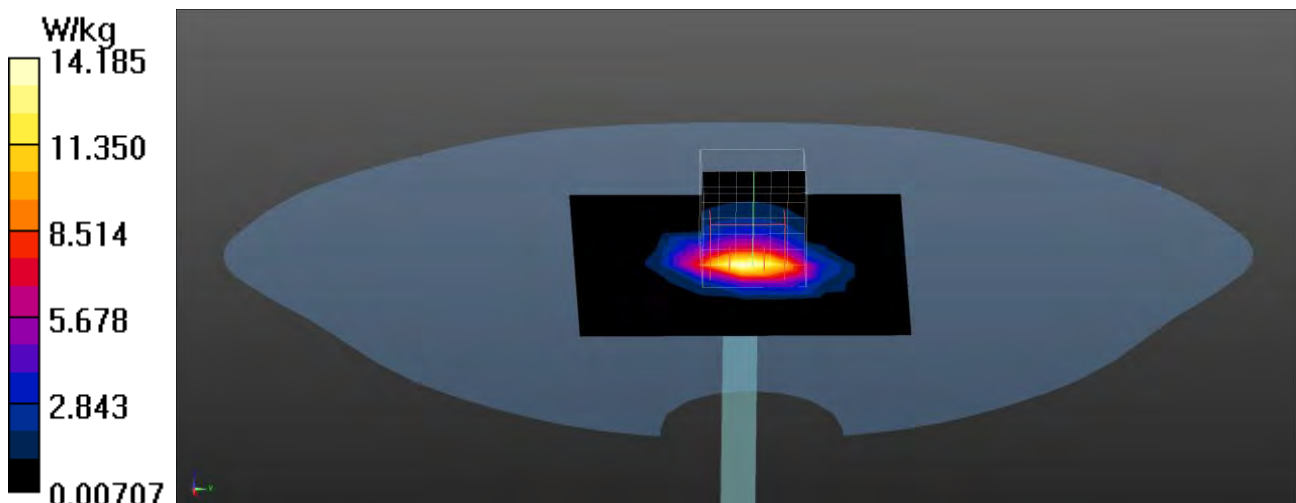

Test Laboratory: DEKRA

Date/Time: 2019/07/16

System Performance Check_5200MHz-Body**DUT: Dipole 5GHz; Type: D5GHzV2**

Communication System: UID 0, CW; Frequency: 5200 MHz;

Communication System PAR: 0 dB

Medium parameters used: $f = 5200$ MHz; $\sigma = 5.34$ S/m; $\epsilon_r = 49.76$; $\rho = 1000$ kg/m³

Phantom section: Flat Section

Ambient Temperature (°C) : 23.4, Liquid Temperature (°C) : 22.2

Measurement Standard: DASYS (IEEE/IEC/ANSI C63.19-2011)

DASY5 Configuration:

- Probe: EX3DV4 - SN3979; ConvF(4.46, 4.46, 4.46); Calibrated: 2018/11/22;
- Sensor-Surface: 1.4mm (Mechanical Surface Detection)
- Electronics: DAE4 Sn1425; Calibrated: 2018/11/16
- Phantom: SAM with right table; Type: SAM;
- Measurement SW: DASYS2, Version 52.10 (0); SEMCAD X Version 14.6.10 (7417)

Configuration/5200MHz-Body/Area Scan (8x8x1): Measurement grid: dx=10mm, dy=10mm

Maximum value of SAR (measured) = 12.4 W/kg

Configuration/5200MHz-Body/Zoom Scan (7x7x12mm), dist=1.4mm**(7x7x12)/Cube 0:** Measurement grid: dx=4mm, dy=4mm, dz=2mm

Reference Value = 70.93 V/m; Power Drift = -0.10 dB

Peak SAR (extrapolated) = 31.8 W/kg

SAR(1 g) = 8.18 W/kg; SAR(10 g) = 2.28 W/kg

Maximum value of SAR (measured) = 21.6 W/kg

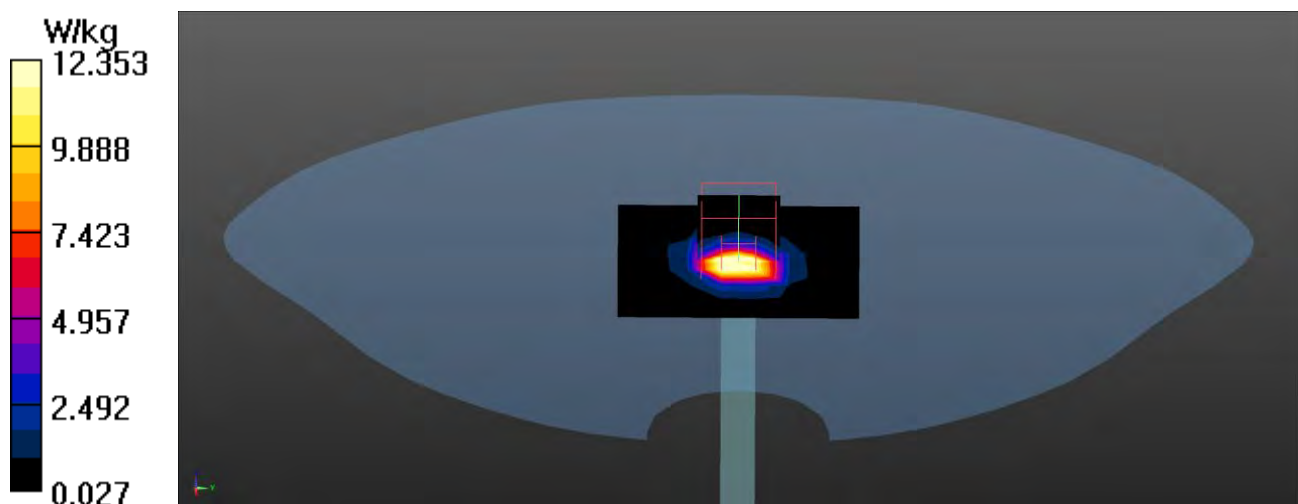

Test Laboratory: DEKRA

Date/Time: 2019/07/16

System Performance Check_5800MHz-Body**DUT: Dipole 5GHz; Type: D5GHzV2**

Communication System: UID 0, CW; Frequency: 5800 MHz;

Communication System PAR: 0 dB

Medium parameters used: $f = 5800$ MHz; $\sigma = 6.27$ S/m; $\epsilon_r = 48.11$; $\rho = 1000$ kg/m³

Phantom section: Flat Section

Ambient Temperature (°C) : 23.4, Liquid Temperature (°C) : 22.2

Measurement Standard: DASYS (IEEE/IEC/ANSI C63.19-2011)

DASY5 Configuration:

- Probe: EX3DV4 - SN3979; ConvF(4.2, 4.2, 4.2); Calibrated: 2018/11/22;
- Sensor-Surface: 1.4mm (Mechanical Surface Detection)
- Electronics: DAE4 Sn1425; Calibrated: 2018/11/16
- Phantom: SAM with right table; Type: SAM;
- Measurement SW: DASYS2, Version 52.10 (0); SEMCAD X Version 14.6.10 (7417)

Configuration/5800MHz-Body/Area Scan (8x8x1): Measurement grid: dx=10mm, dy=10mm

Maximum value of SAR (measured) = 13.4 W/kg

Configuration/5800MHz-Body/Zoom Scan (7x7x12mm), dist=1.4mm**(7x7x12)/Cube 0:** Measurement grid: dx=4mm, dy=4mm, dz=2mm

Reference Value = 67.76 V/m; Power Drift = 0.03 dB

Peak SAR (extrapolated) = 37.4 W/kg

SAR(1 g) = 8.19 W/kg; SAR(10 g) = 2.27 W/kg

Maximum value of SAR (measured) = 22.7 W/kg

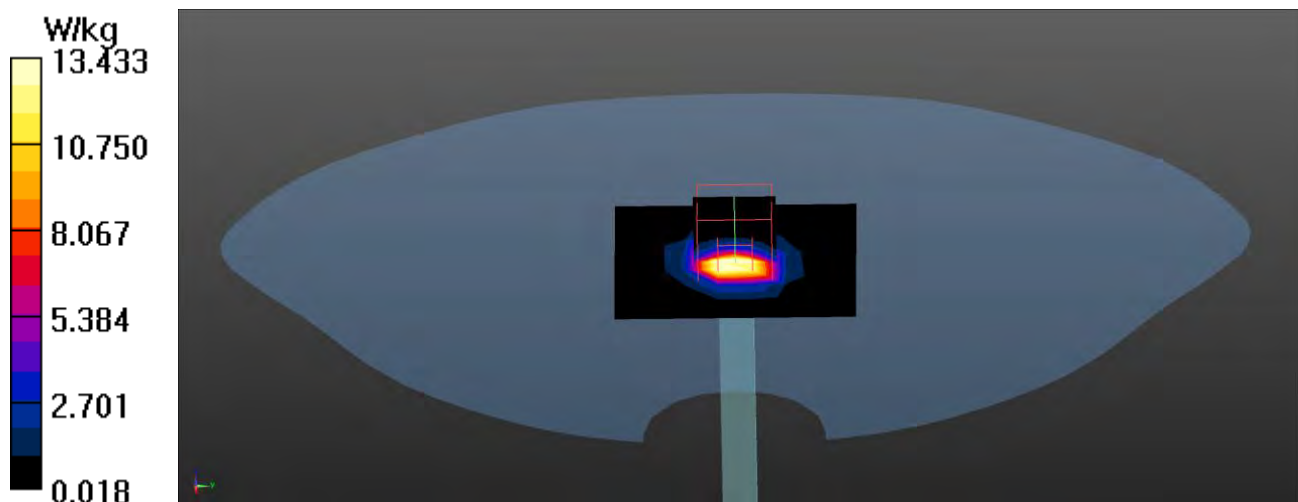

Appendix B. SAR measurement Data

Test Laboratory: DEKRA

Date/Time: 2019/07/12

802.11b_1-Top-Main

DUT: Tablet Computer; Type: DT13

Communication System: UID 0, WLAN 2.4G; Frequency: 2412 MHz;

Communication System PAR: 0 dB

Medium parameters used: $f = 2412$ MHz; $\sigma = 1.94$ S/m; $\epsilon_r = 53.64$; $\rho = 1000$ kg/m³

Phantom section: Flat Section

Ambient Temperature (°C) : 22.5, Liquid Temperature (°C) : 21.6

Measurement Standard: DASYS (IEEE/IEC/ANSI C63.19-2011)

DASY5 Configuration:

- Probe: EX3DV4 - SN3979; ConvF(7.5, 7.5, 7.5); Calibrated: 2018/11/22;
- Sensor-Surface: 3mm (Mechanical Surface Detection)
- Electronics: DAE4 Sn1425; Calibrated: 2018/11/16
- Phantom: SAM with left table; Type: SAM;
- Measurement SW: DASYS2, Version 52.10 (0); SEMCAD X Version 14.6.10 (7417)

Configuration/Body/Area Scan (8x11x1): Measurement grid: dx=12mm, dy=12mm
Maximum value of SAR (measured) = 0.686 W/kg

Configuration/Body/Zoom Scan (7x7x7) (7x7x7)/Cube 0: Measurement grid:
dx=5mm, dy=5mm, dz=5mm
Reference Value = 1.179 V/m; Power Drift = -0.11 dB
Peak SAR (extrapolated) = 1.18 W/kg
SAR(1 g) = 0.574 W/kg; SAR(10 g) = 0.302 W/kg
Maximum value of SAR (measured) = 0.744 W/kg

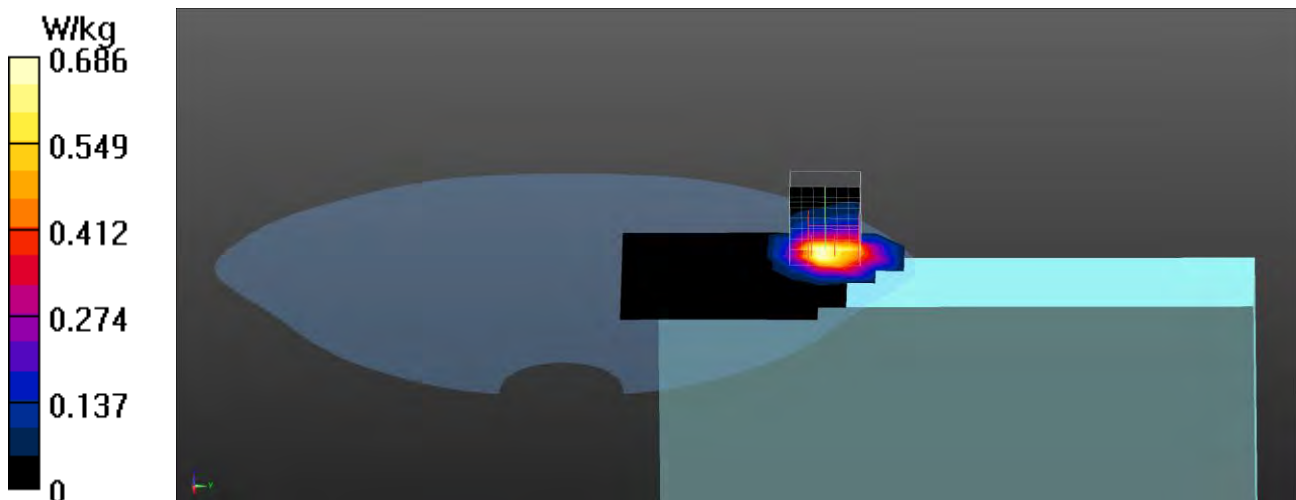

Test Laboratory: DEKRA

Date/Time: 2019/07/12

802.11b_1-Left-Side-Main**DUT: Tablet Computer; Type: DT13**

Communication System: UID 0, WLAN 2.4G; Frequency: 2412 MHz;

Communication System PAR: 0 dB

Medium parameters used: $f = 2412$ MHz; $\sigma = 1.94$ S/m; $\epsilon_r = 53.64$; $\rho = 1000$ kg/m³

Phantom section: Flat Section

Ambient Temperature (°C) : 22.5, Liquid Temperature (°C) : 21.6

Measurement Standard: DASY5 (IEEE/IEC/ANSI C63.19-2011)

DASY5 Configuration:

- Probe: EX3DV4 - SN3979; ConvF(7.5, 7.5, 7.5); Calibrated: 2018/11/22;
- Sensor-Surface: 3mm (Mechanical Surface Detection)
- Electronics: DAE4 Sn1425; Calibrated: 2018/11/16
- Phantom: SAM with left table; Type: SAM;
- Measurement SW: DASY52, Version 52.10 (0); SEMCAD X Version 14.6.10 (7417)

Configuration/Body/Area Scan (7x21x1): Measurement grid: dx=12mm, dy=12mm
Maximum value of SAR (measured) = 0.0572 W/kg

Configuration/Body/Zoom Scan (7x7x7) (7x7x7)/Cube 0: Measurement grid:
dx=5mm, dy=5mm, dz=5mm

Reference Value = 1.654 V/m; Power Drift = 0.14 dB

Peak SAR (extrapolated) = 0.0890 W/kg

SAR(1 g) = 0.049 W/kg; SAR(10 g) = 0.026 W/kg

Maximum value of SAR (measured) = 0.0616 W/kg

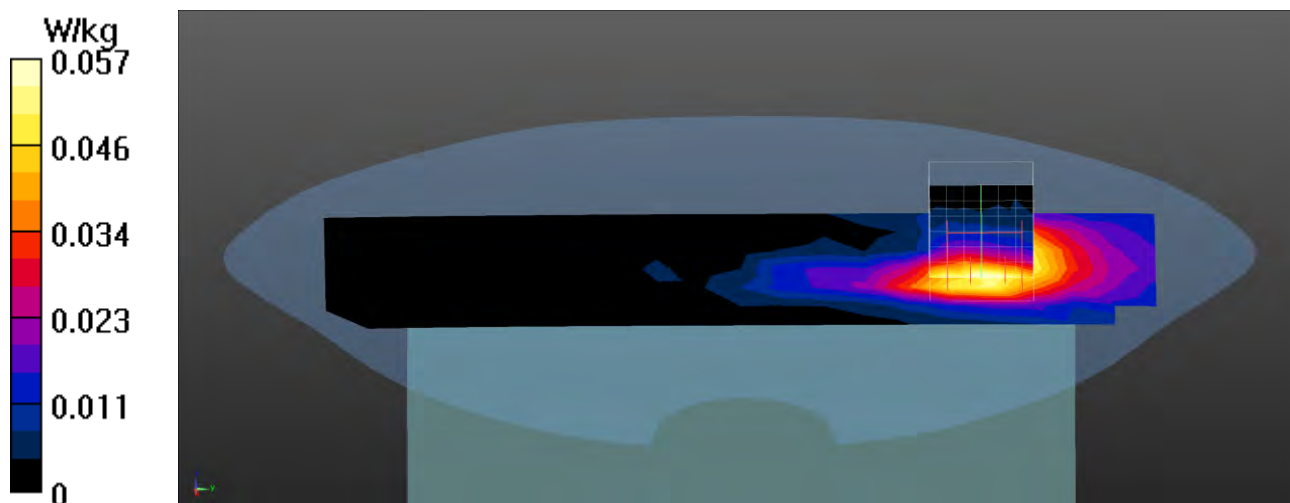

Test Laboratory: DEKRA

Date/Time: 2019/07/12

802.11b_1-Back-Main**DUT: Tablet Computer; Type: DT13**

Communication System: UID 0, WLAN 2.4G; Frequency: 2412 MHz;

Communication System PAR: 0 dB

Medium parameters used: $f = 2412$ MHz; $\sigma = 1.94$ S/m; $\epsilon_r = 53.64$; $\rho = 1000$ kg/m³

Phantom section: Flat Section

Ambient Temperature (°C) : 22.5, Liquid Temperature (°C) : 21.6

Measurement Standard: DASY5 (IEEE/IEC/ANSI C63.19-2011)

DASY5 Configuration:

- Probe: EX3DV4 - SN3979; ConvF(7.5, 7.5, 7.5); Calibrated: 2018/11/22;
- Sensor-Surface: 3mm (Mechanical Surface Detection)
- Electronics: DAE4 Sn1425; Calibrated: 2018/11/16
- Phantom: SAM with left table; Type: SAM;
- Measurement SW: DASY52, Version 52.10 (0); SEMCAD X Version 14.6.10 (7417)

Configuration/Body/Area Scan (9x11x1): Measurement grid: dx=12mm, dy=12mm
Maximum value of SAR (measured) = 0.186 W/kg

Configuration/Body/Zoom Scan (7x7x7) (7x7x7)/Cube 0: Measurement grid:
dx=5mm, dy=5mm, dz=5mm

Reference Value = 7.991 V/m; Power Drift = -0.16 dB

Peak SAR (extrapolated) = 0.292 W/kg

SAR(1 g) = 0.140 W/kg; SAR(10 g) = 0.067 W/kg

Maximum value of SAR (measured) = 0.184 W/kg

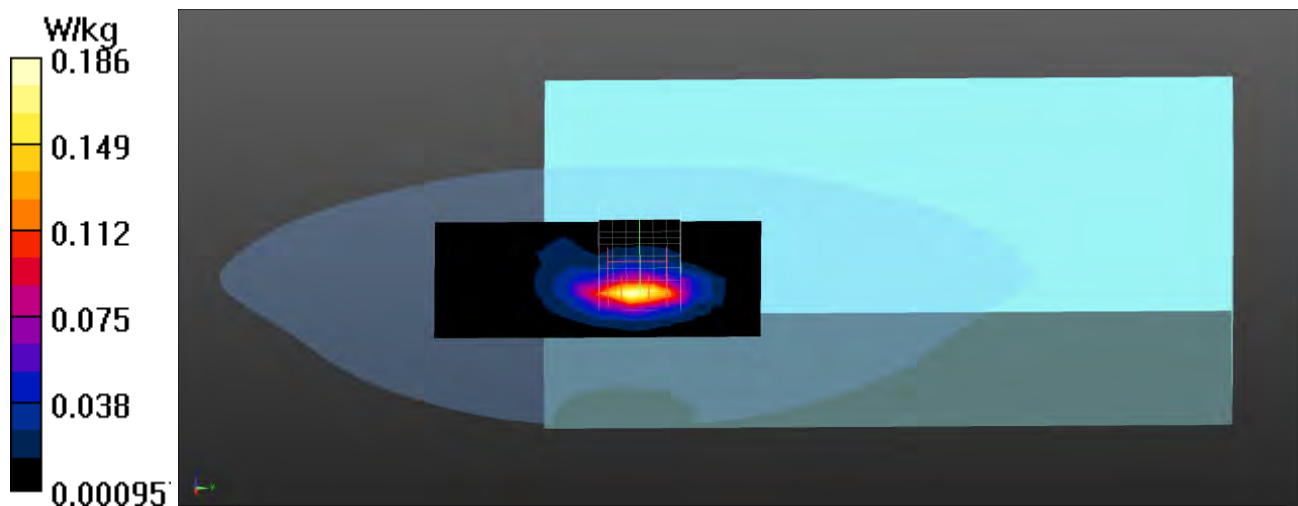

Test Laboratory: DEKRA

Date/Time: 2019/07/12

802.11b_13-Top-Aux**DUT: Tablet Computer; Type: DT13**

Communication System: UID 0, WLAN 2.4G; Frequency: 2472 MHz;

Communication System PAR: 0 dB

Medium parameters used: $f = 2472$ MHz; $\sigma = 2.02$ S/m; $\epsilon_r = 52.92$; $\rho = 1000$ kg/m³

Phantom section: Flat Section

Ambient Temperature (°C) : 22.5, Liquid Temperature (°C) : 21.6

Measurement Standard: DASYS (IEEE/IEC/ANSI C63.19-2011)

DASY5 Configuration:

- Probe: EX3DV4 - SN3979; ConvF(7.5, 7.5, 7.5); Calibrated: 2018/11/22;
- Sensor-Surface: 3mm (Mechanical Surface Detection)
- Electronics: DAE4 Sn1425; Calibrated: 2018/11/16
- Phantom: SAM with left table; Type: SAM;
- Measurement SW: DASY52, Version 52.10 (0); SEMCAD X Version 14.6.10 (7417)

Configuration/Body/Area Scan (8x11x1): Measurement grid: dx=12mm, dy=12mm
Maximum value of SAR (measured) = 0.165 W/kg

Configuration/Body/Zoom Scan (7x7x7) (7x7x7)/Cube 0: Measurement grid:
dx=5mm, dy=5mm, dz=5mm

Reference Value = 1.771 V/m; Power Drift = -0.04 dB

Peak SAR (extrapolated) = 0.307 W/kg

SAR(1 g) = 0.153 W/kg; SAR(10 g) = 0.078 W/kg

Maximum value of SAR (measured) = 0.198 W/kg

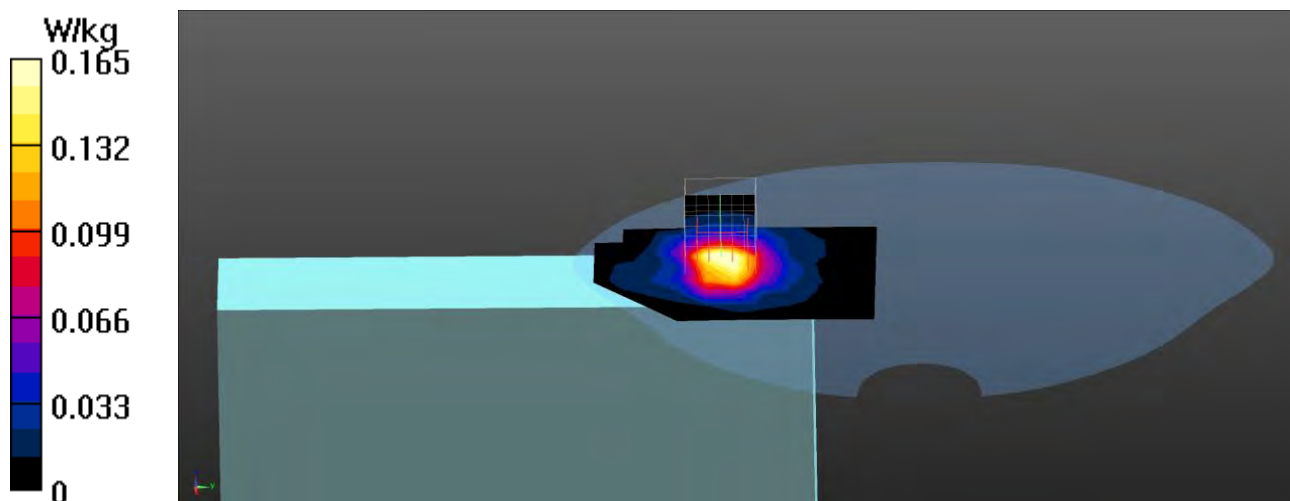

Test Laboratory: DEKRA

Date/Time: 2019/07/12

802.11b_13-Right-Side-Aux**DUT: Tablet Computer; Type: DT13**

Communication System: UID 0, WLAN 2.4G; Frequency: 2472 MHz;

Communication System PAR: 0 dB

Medium parameters used: $f = 2472$ MHz; $\sigma = 2.02$ S/m; $\epsilon_r = 52.92$; $\rho = 1000$ kg/m³

Phantom section: Flat Section

Ambient Temperature (°C) : 22.5, Liquid Temperature (°C) : 21.6

Measurement Standard: DASY5 (IEEE/IEC/ANSI C63.19-2011)

DASY5 Configuration:

- Probe: EX3DV4 - SN3979; ConvF(7.5, 7.5, 7.5); Calibrated: 2018/11/22;
- Sensor-Surface: 3mm (Mechanical Surface Detection)
- Electronics: DAE4 Sn1425; Calibrated: 2018/11/16
- Phantom: SAM with left table; Type: SAM;
- Measurement SW: DASY52, Version 52.10 (0); SEMCAD X Version 14.6.10 (7417)

Configuration/Body/Area Scan (7x13x1): Measurement grid: dx=12mm, dy=12mm
Maximum value of SAR (measured) = 0.741 W/kg

Configuration/Body/Zoom Scan (7x7x7) (7x7x7)/Cube 0: Measurement grid:
dx=5mm, dy=5mm, dz=5mm

Reference Value = 9.921 V/m; Power Drift = 0.02 dB

Peak SAR (extrapolated) = 1.34 W/kg

SAR(1 g) = 0.635 W/kg; SAR(10 g) = 0.318 W/kg

Maximum value of SAR (measured) = 0.838 W/kg

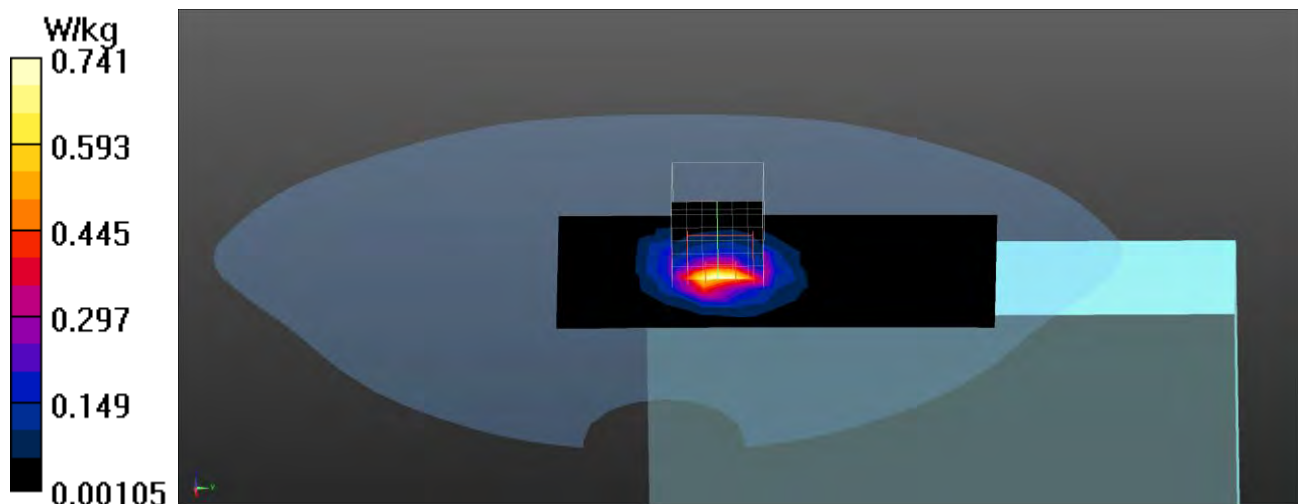

Test Laboratory: DEKRA

Date/Time: 2019/07/12

802.11b_13-Back-Aux**DUT: Tablet Computer; Type: DT13**

Communication System: UID 0, WLAN 2.4G; Frequency: 2472 MHz;

System PAR: 0 dB

Medium parameters used: $f = 2472$ MHz; $\sigma = 2.02$ S/m; $\epsilon_r = 52.92$; $\rho = 1000$ kg/m³

Phantom section: Flat Section

Ambient Temperature (°C) : 22.5, Liquid Temperature (°C) : 21.6

Measurement Standard: DASY5 (IEEE/IEC/ANSI C63.19-2011)

DASY5 Configuration:

- Probe: EX3DV4 - SN3979; ConvF(7.5, 7.5, 7.5); Calibrated: 2018/11/22;
- Sensor-Surface: 3mm (Mechanical Surface Detection)
- Electronics: DAE4 Sn1425; Calibrated: 2018/11/16
- Phantom: SAM with left table; Type: SAM;
- Measurement SW: DASY52, Version 52.10 (0); SEMCAD X Version 14.6.10 (7417)

Configuration/Body/Area Scan (9x11x1): Measurement grid: dx=12mm, dy=12mm
Maximum value of SAR (measured) = 0.158 W/kg

Configuration/Body/Zoom Scan (7x7x7) (7x7x7)/Cube 0: Measurement grid:
dx=5mm, dy=5mm, dz=5mm

Reference Value = 7.646 V/m; Power Drift = -0.01 dB

Peak SAR (extrapolated) = 0.329 W/kg

SAR(1 g) = 0.154 W/kg; SAR(10 g) = 0.073 W/kg

Maximum value of SAR (measured) = 0.206 W/kg

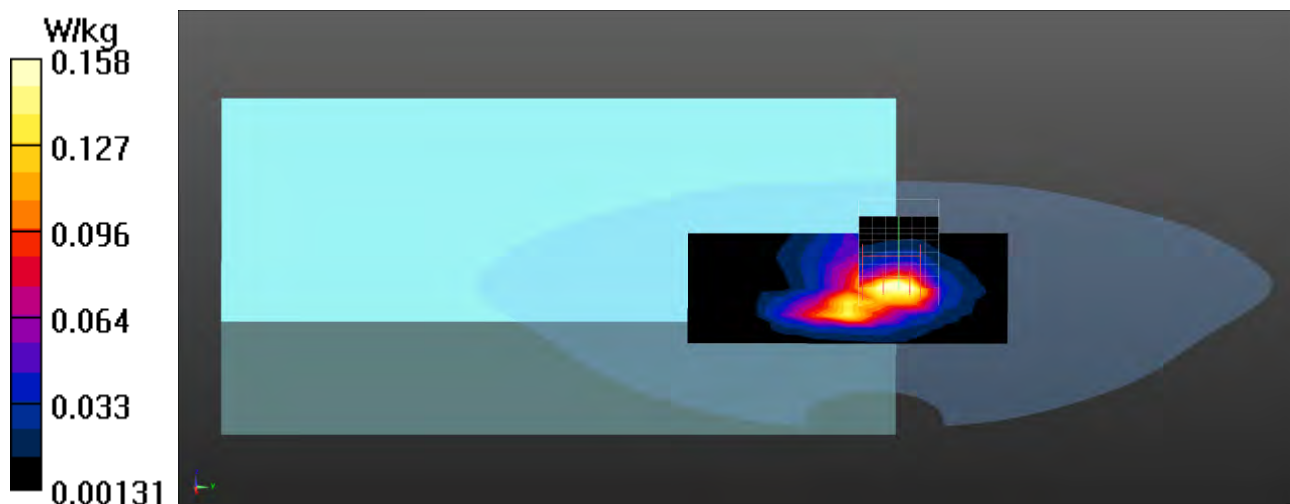

Test Laboratory: DEKRA

Date/Time: 2019/07/12

BT_1M_78-Right-Side-Aux**DUT: Tablet Computer; Type: DT13**

Communication System: UID 0, BT 1M&3M&BLE; Frequency: 2480 MHz;

Communication System PAR: 0 dB

Medium parameters used: $f = 2480$ MHz; $\sigma = 2.03$ S/m; $\epsilon_r = 52.81$; $\rho = 1000$ kg/m³

Phantom section: Flat Section

Ambient Temperature (°C) : 22.5, Liquid Temperature (°C) : 21.6

Measurement Standard: DASY5 (IEEE/IEC/ANSI C63.19-2011)

DASY5 Configuration:

- Probe: EX3DV4 - SN3979; ConvF(7.5, 7.5, 7.5); Calibrated: 2018/11/22;
- Sensor-Surface: 3mm (Mechanical Surface Detection)
- Electronics: DAE4 Sn1425; Calibrated: 2018/11/16
- Phantom: SAM with left table; Type: SAM;
- Measurement SW: DASY52, Version 52.10 (0); SEMCAD X Version 14.6.10 (7417)

Configuration/Body/Area Scan (7x13x1): Measurement grid: dx=12mm, dy=12mm
Maximum value of SAR (measured) = 0.171 W/kg**Configuration/Body/Zoom Scan (7x7x7) (7x7x7)/Cube 0:** Measurement grid:
dx=5mm, dy=5mm, dz=5mm

Reference Value = 7.921 V/m; Power Drift = 0.16 dB

Peak SAR (extrapolated) = 0.320 W/kg

SAR(1 g) = 0.142 W/kg; SAR(10 g) = 0.077 W/kg

Maximum value of SAR (measured) = 0.178 W/kg

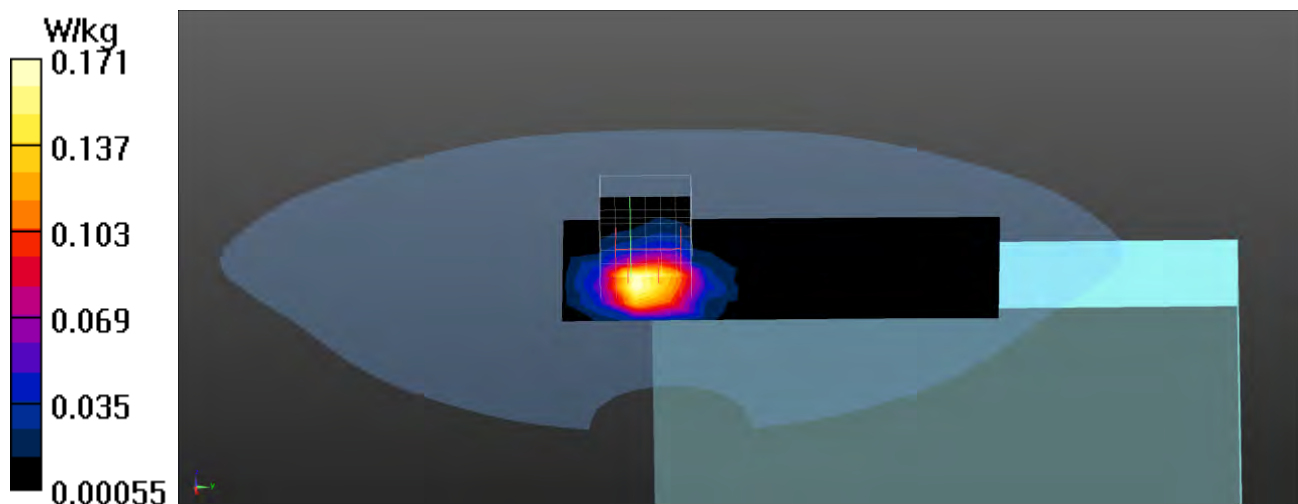

802.11b EUT Right-Side (ACON Aux Antenna) Z-Axis plot
Channel: 13

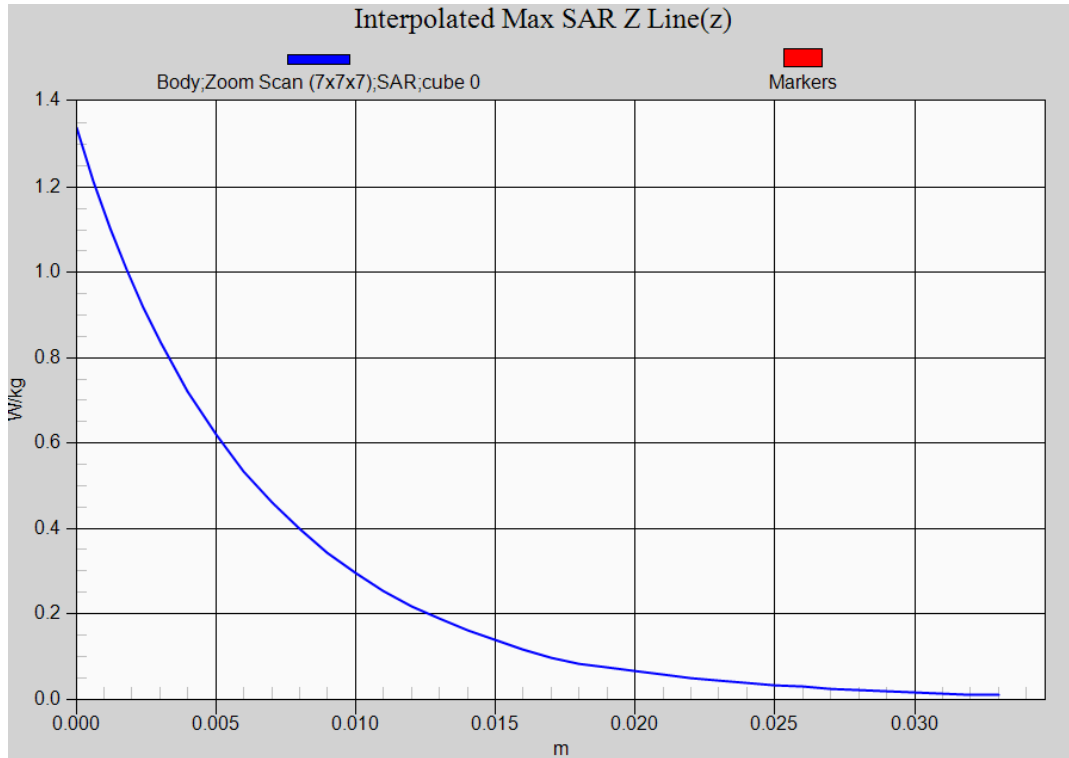

Test Laboratory: DEKRA

Date/Time: 2019/07/16

802.11ac80_42-Top Aux**DUT: Tablet Computer; Type: DT13**

Communication System: UID 0, WLAN 5G; Frequency: 5210 MHz;

Communication System PAR: 0 dB

Medium parameters used: $f = 5210$ MHz; $\sigma = 5.35$ S/m; $\epsilon_r = 49.72$; $\rho = 1000$ kg/m³

Phantom section: Flat Section

Ambient Temperature (°C) : 23.4, Liquid Temperature (°C) : 22.2

Measurement Standard: DASY5 (IEEE/IEC/ANSI C63.19-2011)

DASY5 Configuration:

- Probe: EX3DV4 - SN3979; ConvF(4.46, 4.46, 4.46); Calibrated: 2018/11/22;
- Sensor-Surface: 1.4mm (Mechanical Surface Detection)
- Electronics: DAE4 Sn1425; Calibrated: 2018/11/16
- Phantom: SAM with right table; Type: SAM;
- Measurement SW: DASY52, Version 52.10 (0); SEMCAD X Version 14.6.10 (7417)

Configuration/Body/Area Scan (9x13x1): Measurement grid: dx=10mm, dy=10mm
Maximum value of SAR (measured) = 1.54 W/kg**Configuration/Body/Zoom Scan (7x7x12) (7x7x12)/Cube 0:** Measurement grid:
dx=4mm, dy=4mm, dz=2mm

Reference Value = 1.700 V/m; Power Drift = -0.16 dB

Peak SAR (extrapolated) = 2.98 W/kg

SAR(1 g) = 0.633 W/kg; SAR(10 g) = 0.160 W/kg

Maximum value of SAR (measured) = 1.75 W/kg

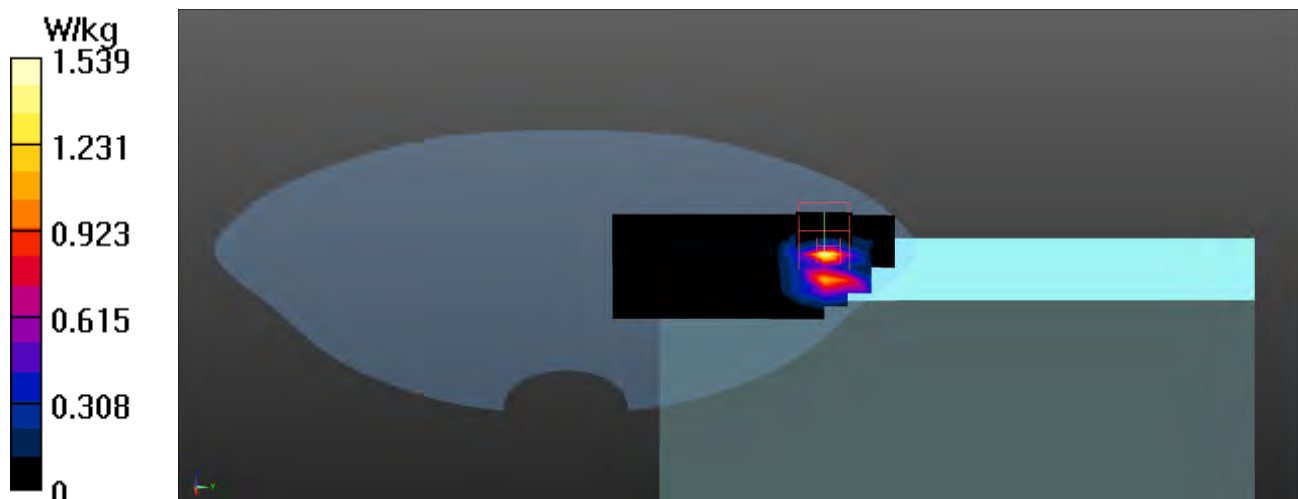

Test Laboratory: DEKRA

Date/Time: 2019/07/16

802.11ac80_155-Top Aux**DUT: Tablet Computer; Type: DT13**

Communication System: UID 0, WLAN 5G; Frequency: 5775 MHz;

Communication System PAR: 0 dB

Medium parameters used: $f = 5775$ MHz; $\sigma = 6.24$ S/m; $\epsilon_r = 48.23$; $\rho = 1000$ kg/m³

Phantom section: Flat Section

Ambient Temperature (°C) : 23.4, Liquid Temperature (°C) : 22.2

Measurement Standard: DASY5 (IEEE/IEC/ANSI C63.19-2011)

DASY5 Configuration:

- Probe: EX3DV4 - SN3979; ConvF(4.2, 4.2, 4.2); Calibrated: 2018/11/22;
- Sensor-Surface: 1.4mm (Mechanical Surface Detection)
- Electronics: DAE4 Sn1425; Calibrated: 2018/11/16
- Phantom: SAM with right table; Type: SAM;
- Measurement SW: DASY52, Version 52.10 (0); SEMCAD X Version 14.6.10 (7417)

Configuration/Body/Area Scan (9x12x1): Measurement grid: dx=10mm, dy=10mm
Maximum value of SAR (measured) = 0.703 W/kg

Configuration/Body/Zoom Scan (7x7x12) (7x7x12)/Cube 0: Measurement grid:
dx=4mm, dy=4mm, dz=2mm

Reference Value = 1.178 V/m; Power Drift = -0.19 dB

Peak SAR (extrapolated) = 2.07 W/kg

SAR(1 g) = 0.364 W/kg; SAR(10 g) = 0.094 W/kg

Maximum value of SAR (measured) = 1.13 W/kg

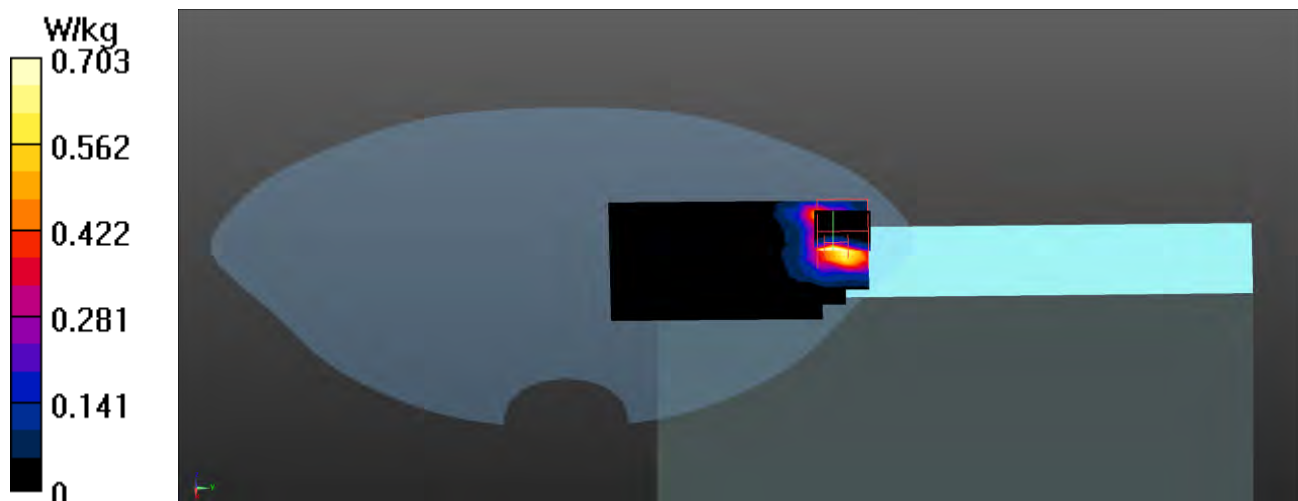

Test Laboratory: DEKRA

Date/Time: 2019/07/16

802.11ac80_42-Back Aux**DUT: Tablet Computer; Type: DT13**

Communication System: UID 0, WLAN 5G; Frequency: 5210 MHz;

Communication System PAR: 0 dB

Medium parameters used: $f = 5210$ MHz; $\sigma = 5.35$ S/m; $\epsilon_r = 49.72$; $\rho = 1000$ kg/m³

Phantom section: Flat Section

Ambient Temperature (°C) : 23.4, Liquid Temperature (°C) : 22.2

Measurement Standard: DASYS (IEEE/IEC/ANSI C63.19-2011)

DASY5 Configuration:

- Probe: EX3DV4 - SN3979; ConvF(4.46, 4.46, 4.46); Calibrated: 2018/11/22;
- Sensor-Surface: 1.4mm (Mechanical Surface Detection)
- Electronics: DAE4 Sn1425; Calibrated: 2018/11/16
- Phantom: SAM with right table; Type: SAM;
- Measurement SW: DASYS2, Version 52.10 (0); SEMCAD X Version 14.6.10 (7417)

Configuration/Body/Area Scan (10x13x1): Measurement grid: dx=10mm, dy=10mm

Maximum value of SAR (measured) = 0.370 W/kg

Configuration/Body/Zoom Scan (7x7x12) (7x7x12)/Cube 0: Measurement grid: dx=4mm, dy=4mm, dz=2mm

Reference Value = 3.241 V/m; Power Drift = -0.04 dB

Peak SAR (extrapolated) = 0.919 W/kg

SAR(1 g) = 0.222 W/kg; SAR(10 g) = 0.101 W/kg

Maximum value of SAR (measured) = 0.490 W/kg

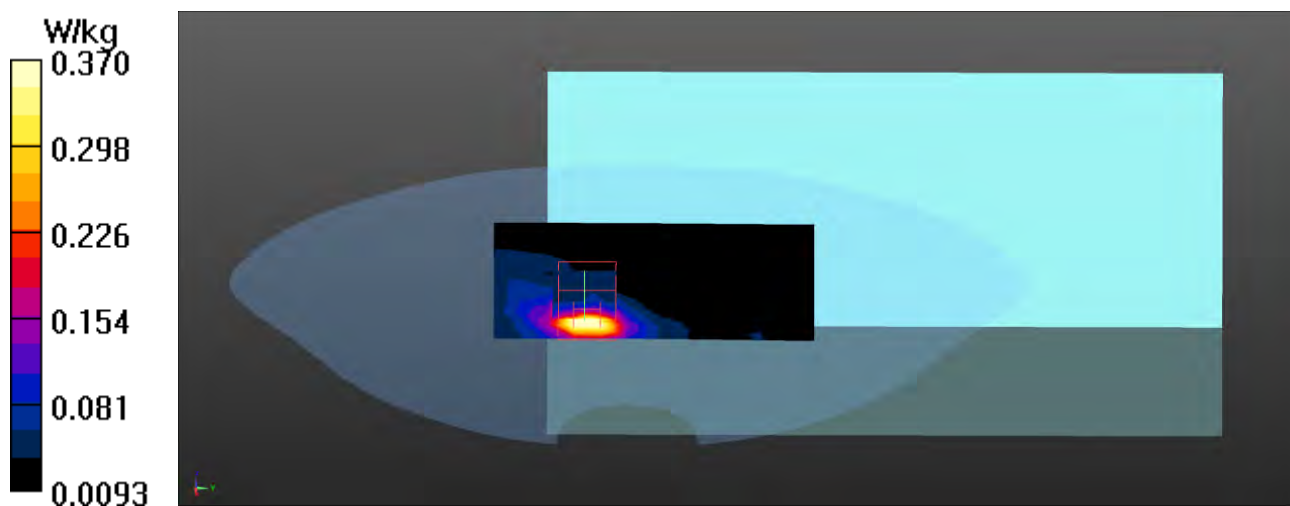

Test Laboratory: DEKRA

Date/Time: 2019/07/16

802.11ac80_42-Left-Side Aux**DUT: Tablet Computer; Type: DT13**

Communication System: UID 0, WLAN 5G; Frequency: 5210 MHz;

Communication System PAR: 0 dB

Medium parameters used: $f = 5210$ MHz; $\sigma = 5.35$ S/m; $\epsilon_r = 49.72$; $\rho = 1000$ kg/m³

Phantom section: Flat Section

Ambient Temperature (°C) : 23.4, Liquid Temperature (°C) : 22.2

Measurement Standard: DASYS (IEEE/IEC/ANSI C63.19-2011)

DASY5 Configuration:

- Probe: EX3DV4 - SN3979; ConvF(4.46, 4.46, 4.46); Calibrated: 2018/11/22;
- Sensor-Surface: 1.4mm (Mechanical Surface Detection)
- Electronics: DAE4 Sn1425; Calibrated: 2018/11/16
- Phantom: SAM with right table; Type: SAM;
- Measurement SW: DASY52, Version 52.10 (0); SEMCAD X Version 14.6.10 (7417)

Configuration/Body/Area Scan (8x23x1): Measurement grid: dx=10mm, dy=10mm
Maximum value of SAR (measured) = 0.0392 W/kg**Configuration/Body/Zoom Scan (7x7x12) (7x7x12)/Cube 0:** Measurement grid:
dx=4mm, dy=4mm, dz=2mm

Reference Value = 0.5490 V/m; Power Drift = 0.15 dB

Peak SAR (extrapolated) = 0.263 W/kg

SAR(1 g) = 0.051 W/kg; SAR(10 g) = 0.018 W/kg

Maximum value of SAR (measured) = 0.122 W/kg

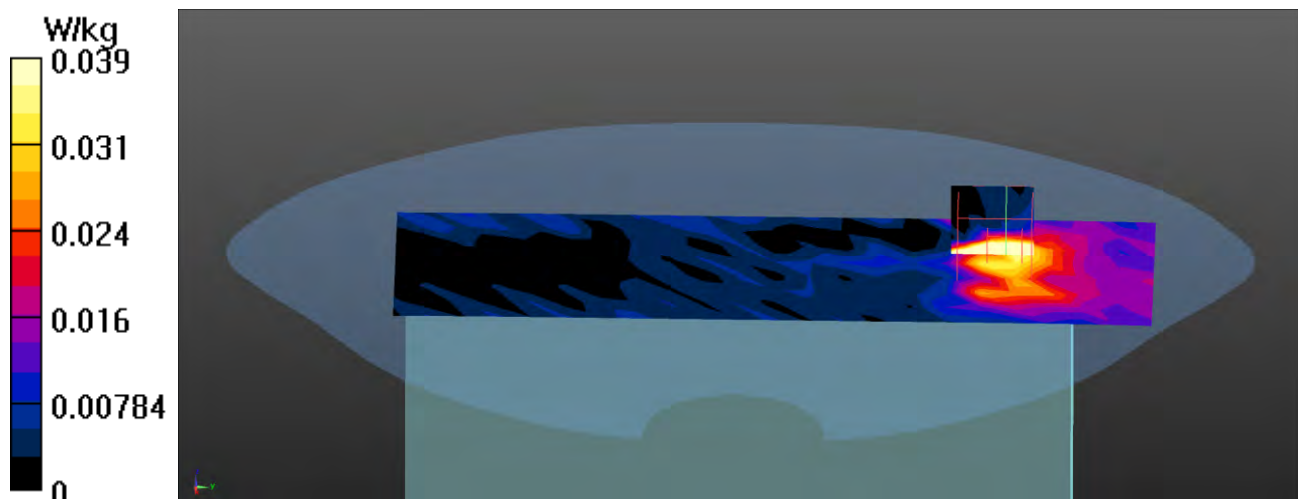

Test Laboratory: DEKRA

Date/Time: 2019/07/16

802.11ac80_42-Top Aux**DUT: Tablet Computer; Type: DT13**

Communication System: UID 0, WLAN 5G; Frequency: 5210 MHz;

Communication System PAR: 0 dB

Medium parameters used: $f = 5210$ MHz; $\sigma = 5.35$ S/m; $\epsilon_r = 49.72$; $\rho = 1000$ kg/m³

Phantom section: Flat Section

Ambient Temperature (°C) : 23.4, Liquid Temperature (°C) : 22.2

Measurement Standard: DASYS (IEEE/IEC/ANSI C63.19-2011)

DASY5 Configuration:

- Probe: EX3DV4 - SN3979; ConvF(4.46, 4.46, 4.46); Calibrated: 2018/11/22;
- Sensor-Surface: 1.4mm (Mechanical Surface Detection)
- Electronics: DAE4 Sn1425; Calibrated: 2018/11/16
- Phantom: SAM with right table; Type: SAM;
- Measurement SW: DASY52, Version 52.10 (0); SEMCAD X Version 14.6.10 (7417)

Configuration/Body/Area Scan (9x13x1): Measurement grid: dx=10mm, dy=10mm
Maximum value of SAR (measured) = 0.123 W/kg**Configuration/Body/Zoom Scan (7x7x12) (7x7x12)/Cube 0:** Measurement grid:
dx=4mm, dy=4mm, dz=2mm

Reference Value = 2.425 V/m; Power Drift = -0.07 dB

Peak SAR (extrapolated) = 0.200 W/kg

SAR(1 g) = 0.071 W/kg; SAR(10 g) = 0.042 W/kg

Maximum value of SAR (measured) = 0.138 W/kg

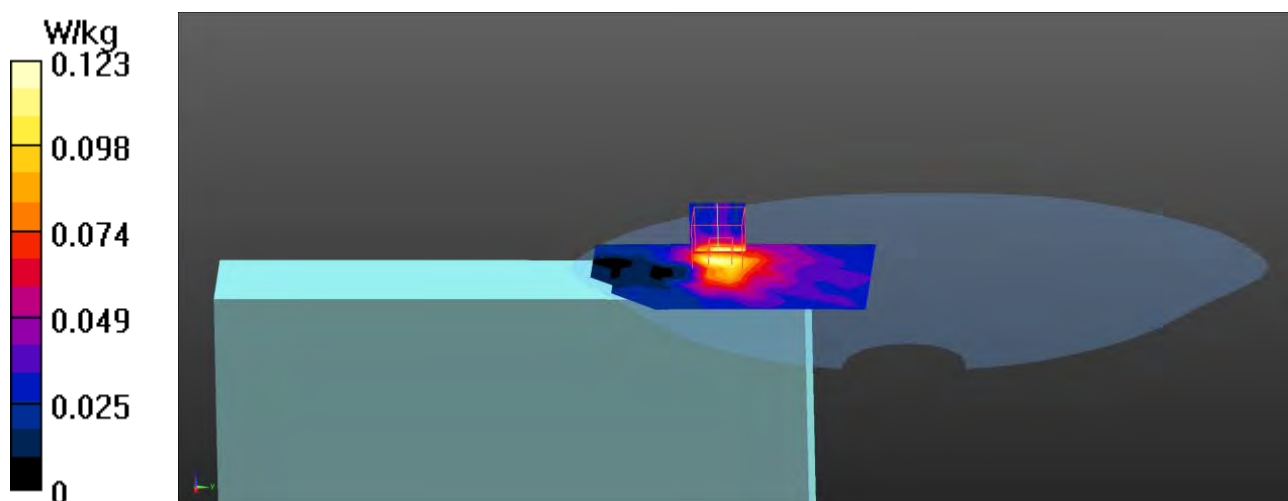

Test Laboratory: DEKRA

Date/Time: 2019/07/16

802.11ac80_42-Back Aux**DUT: Tablet Computer; Type: DT13**

Communication System: UID 0, WLAN 5G; Frequency: 5210 MHz;

Communication System PAR: 0 dB

Medium parameters used: $f = 5210$ MHz; $\sigma = 5.35$ S/m; $\epsilon_r = 49.72$; $\rho = 1000$ kg/m³

Phantom section: Flat Section

Ambient Temperature (°C) : 23.4, Liquid Temperature (°C) : 22.2

Measurement Standard: DASY5 (IEEE/IEC/ANSI C63.19-2011)

DASY5 Configuration:

- Probe: EX3DV4 - SN3979; ConvF(4.46, 4.46, 4.46); Calibrated: 2018/11/22;
- Sensor-Surface: 1.4mm (Mechanical Surface Detection)
- Electronics: DAE4 Sn1425; Calibrated: 2018/11/16
- Phantom: SAM with right table; Type: SAM;
- Measurement SW: DASY52, Version 52.10 (0); SEMCAD X Version 14.6.10 (7417)

Configuration/Body/Area Scan (10x13x1): Measurement grid: dx=10mm, dy=10mm

Maximum value of SAR (measured) = 0.284 W/kg

Configuration/Body/Zoom Scan (7x7x12) (7x7x12)/Cube 0: Measurement grid:

dx=4mm, dy=4mm, dz=2mm

Reference Value = 7.310 V/m; Power Drift = -0.02 dB

Peak SAR (extrapolated) = 0.611 W/kg

SAR(1 g) = 0.120 W/kg; SAR(10 g) = 0.039 W/kg

Maximum value of SAR (measured) = 0.334 W/kg

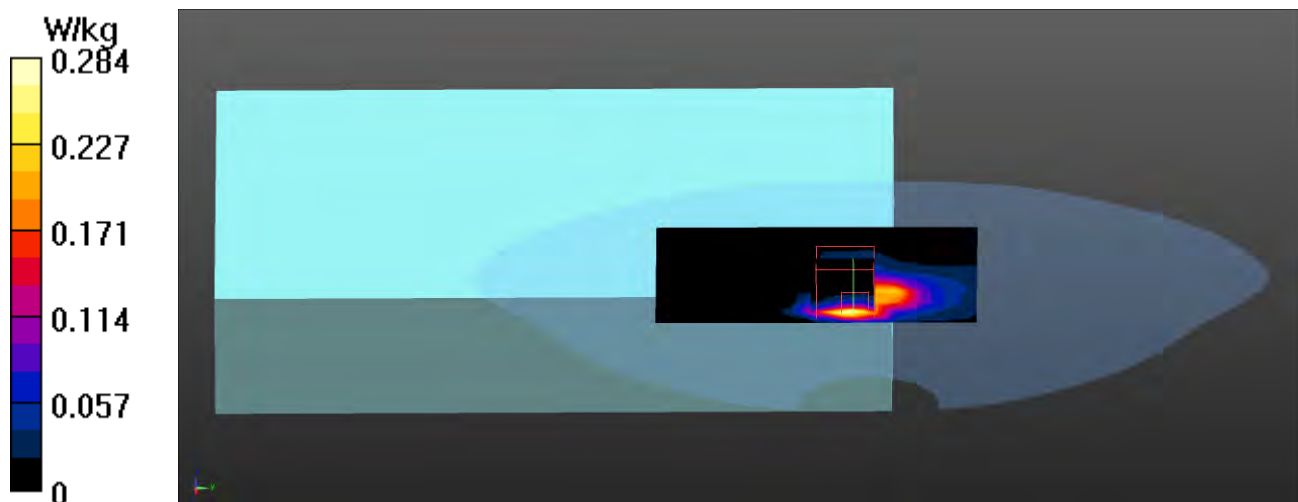

Test Laboratory: DEKRA

Date/Time: 2019/07/16

802.11ac80_42-Right-Sild Aux**DUT: Tablet Computer; Type: DT13**

Communication System: UID 0, WLAN 5G; Frequency: 5210 MHz;

Communication System PAR: 0 dB

Medium parameters used: $f = 5210$ MHz; $\sigma = 5.35$ S/m; $\epsilon_r = 49.72$; $\rho = 1000$ kg/m³

Phantom section: Flat Section

Ambient Temperature (°C) : 23.4, Liquid Temperature (°C) : 22.2

Measurement Standard: DASYS (IEEE/IEC/ANSI C63.19-2011)

DASY5 Configuration:

- Probe: EX3DV4 - SN3979; ConvF(4.46, 4.46, 4.46); Calibrated: 2018/11/22;
- Sensor-Surface: 1.4mm (Mechanical Surface Detection)
- Electronics: DAE4 Sn1425; Calibrated: 2018/11/16
- Phantom: SAM with right table; Type: SAM;
- Measurement SW: DASY52, Version 52.10 (0); SEMCAD X Version 14.6.10 (7417)

Configuration/Body/Area Scan (8x15x1): Measurement grid: dx=10mm, dy=10mm
Maximum value of SAR (measured) = 1.10 W/kg**Configuration/Body/Zoom Scan (7x7x12) (7x7x12)/Cube 0:** Measurement grid:
dx=4mm, dy=4mm, dz=2mm

Reference Value = 7.952 V/m; Power Drift = -0.14 dB

Peak SAR (extrapolated) = 3.02 W/kg

SAR(1 g) = 0.683 W/kg; SAR(10 g) = 0.182 W/kg

Maximum value of SAR (measured) = 1.71 W/kg

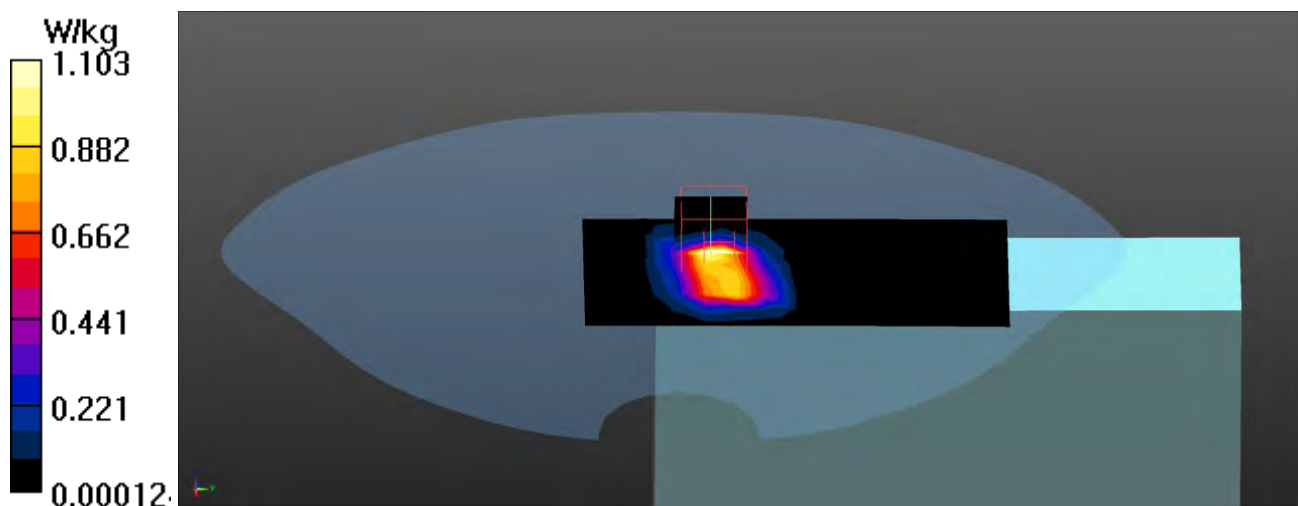

Test Laboratory: DEKRA

Date/Time: 2019/07/16

802.11ac80_155-Right-Sild Aux**DUT: Tablet Computer; Type: DT13**

Communication System: UID 0, WLAN 5G; Frequency: 5775 MHz;

Communication System PAR: 0 dB

Medium parameters used: $f = 5775$ MHz; $\sigma = 6.24$ S/m; $\epsilon_r = 48.23$; $\rho = 1000$ kg/m³

Phantom section: Flat Section

Ambient Temperature (°C) : 23.4, Liquid Temperature (°C) : 22.2

Measurement Standard: DASY5 (IEEE/IEC/ANSI C63.19-2011)

DASY5 Configuration:

- Probe: EX3DV4 - SN3979; ConvF(4.2, 4.2, 4.2); Calibrated: 2018/11/22;
- Sensor-Surface: 1.4mm (Mechanical Surface Detection)
- Electronics: DAE4 Sn1425; Calibrated: 2018/11/16
- Phantom: SAM with right table; Type: SAM;
- Measurement SW: DASY52, Version 52.10 (0); SEMCAD X Version 14.6.10 (7417)

Configuration/Body/Area Scan (8x11x1): Measurement grid: dx=10mm, dy=10mm
Maximum value of SAR (measured) = 0.998 W/kg

Configuration/Body/Zoom Scan (7x7x12) (7x7x12)/Cube 0: Measurement grid:
dx=4mm, dy=4mm, dz=2mm

Reference Value = 3.667 V/m; Power Drift = -0.17 dB

Peak SAR (extrapolated) = 2.57 W/kg

SAR(1 g) = 0.462 W/kg; SAR(10 g) = 0.122 W/kg

Maximum value of SAR (measured) = 1.35 W/kg

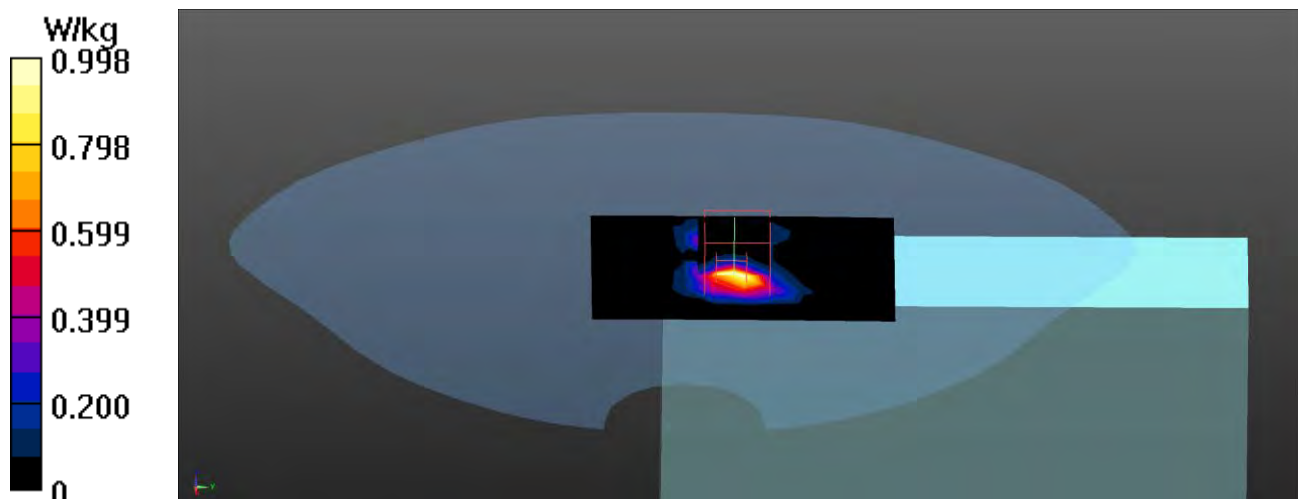

802.11ac (80M) EUT Right-Sild (ACON Aux Antenna), Z-Axis plot
Channel: 42

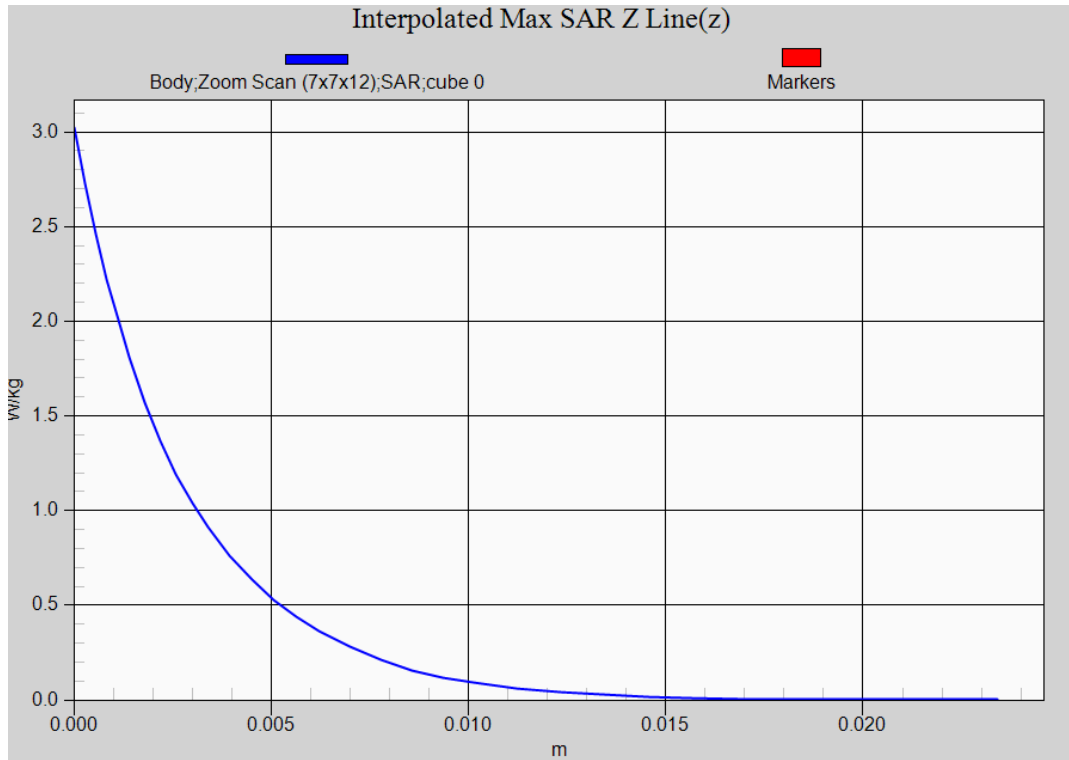

Appendix C. Test Setup Photographs & EUT Photographs

Test Setup Photographs

EUT Top-Main



EUT Top-AUX



EUT Back-Main

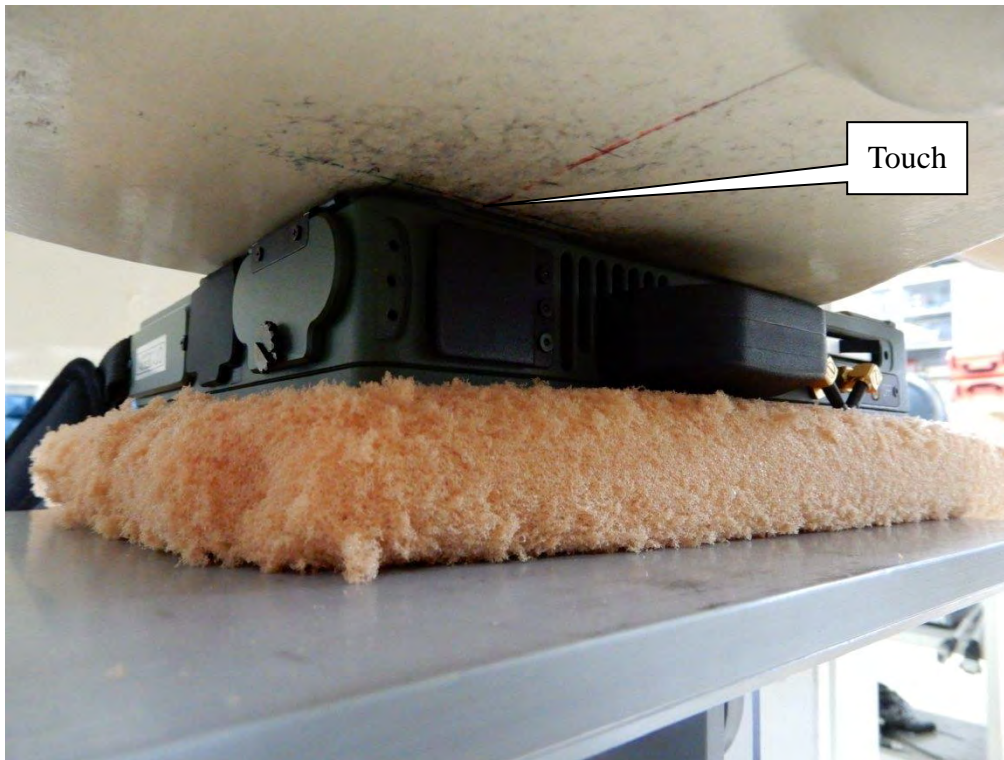

EUT Back-Aux

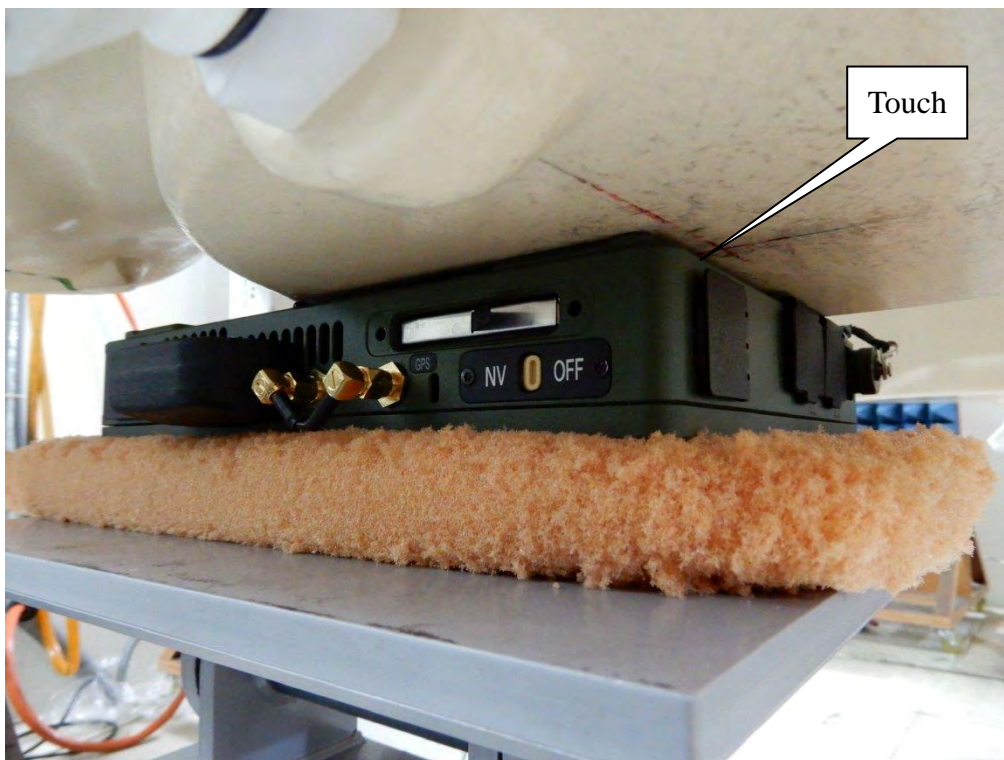

EUT Left-Side-Main



EUT Right-side-Axu

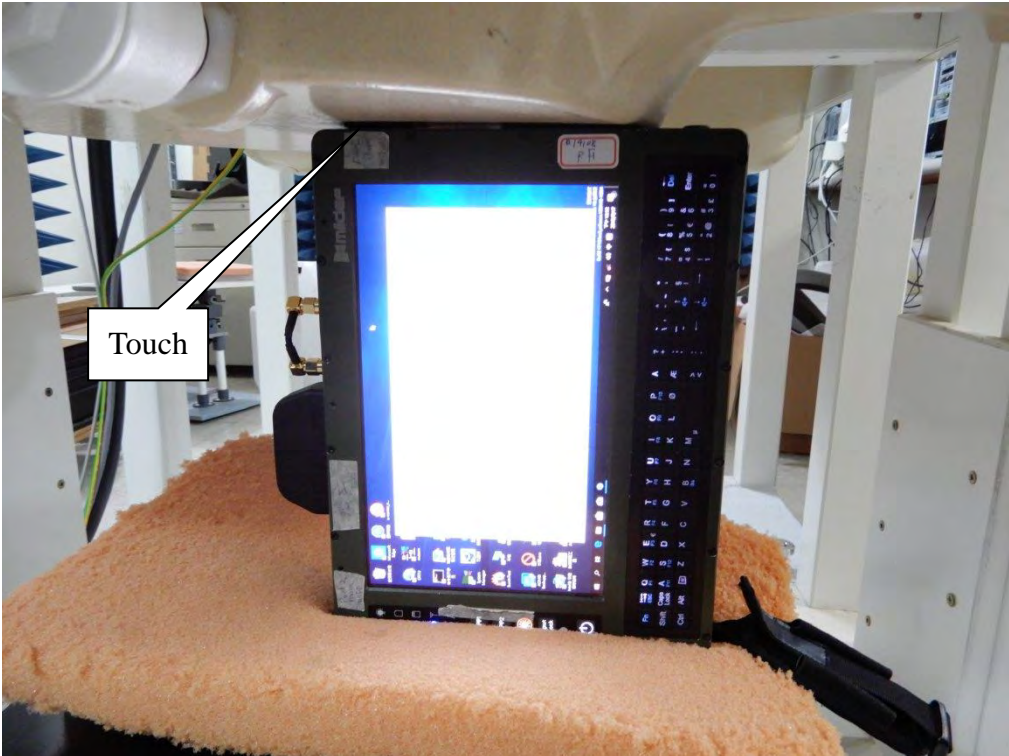

Depth of the liquid in the phantom-Zoom In (2.4GHz)



Depth of the liquid in the phantom-Zoom In (5GHz)

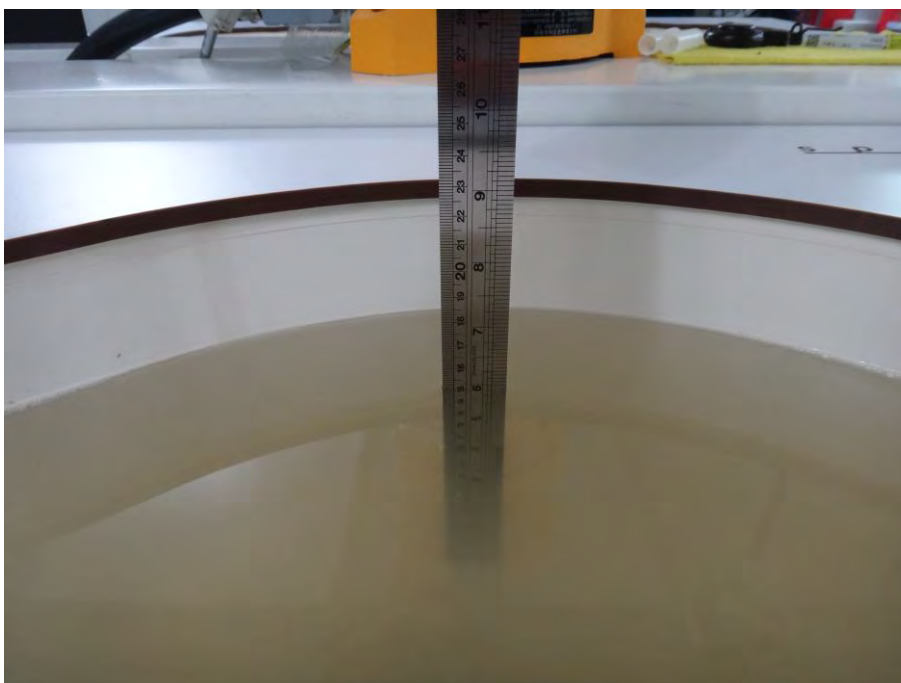

Note: The positions used in the measurements were according to IEEE 1528-2013.

EUT Photographs

