

A Test Lab Techno Corp.

Changan Lab : No. 140 -1, Changan Street, Bade City, Taoyuan County, Taiwan R.O.C.

Tel : 886-3-271-0188 / Fax : 886-3-271-0190



SAR EVALUATION REPORT

Test Report No.	: 1408FS17
Applicant	: MilDef Crete Inc.
Product Type	: Notebook computer
Trade Name	: MilDef Crete Inc.
Model Number	: DT10
Date of Received	: Aug. 07, 2014
Test Period	: Aug. 13 ~ Aug 29, 2014
Date of Issued	: Sep. 02, 2014
Test Environment	: Ambient Temperature : 22 ± 2 ° C Relative Humidity : 40 - 70 %
Standard	: KDB 865664 D01 SAR Measurement 100 MHz to 6 GHz v01r03 KDB 865664 D02 RF Exposure Reporting v01r01 ANSI/IEEE C95.1-1999 IEEE Std. 1528-2013 IEEE Std. 1528a-2005 47 CFR Part §2.1093; KDB 447498 D01 KDB 248227 D01
Max. Reported SAR	: 0.504 W/kg Body SAR
Test Lab Location	: Chang-an Lab



1. The test operations have to be performed with cautious behavior, the test results are as attached.
2. The test results are under chamber environment of A Test Lab Techno Corp. A Test Lab Techno Corp. does not assume responsibility for any conclusions and generalizations drawn from the test results with regard to other specimens or samples.
3. The measurement report has to be written approval of A Test Lab Techno Corp. It may only be reproduced or published in full. This report shall not be reproduced except in full, without the written approval of A Test Lab Techno Corp. The test results in the report only apply to the tested sample.

Approved By :

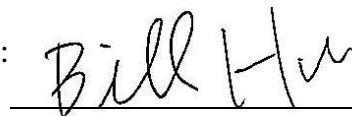

(Bill Hu)

Tested By :

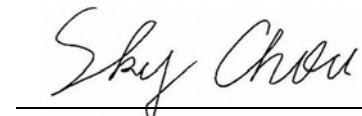

(Sky Chou)



Contents

1. Description of Equipment under Test (EUT)	3
2. Introduction.....	5
2.1 SAR Definition	5
3. SAR Measurement Setup	6
3.1 DASY E-Field Probe System.....	7
3.2 Data Acquisition Electronic (DAE) System.....	10
3.3 Robot.....	10
3.4 Measurement Server.....	10
3.5 Device Holder.....	11
3.6 Phantom - SAM v4.0	11
3.7 Oval Flat Phantom - ELI 4.0.....	12
3.8 Data Storage and Evaluation.....	12
4. Tissue Simulating Liquids.....	15
4.1 Ingredients.....	16
4.2 Recipes.....	16
4.3 Liquid Depth	17
5. SAR Testing with RF Transmitters	18
5.1 SAR Testing with 802.11 Transmitters.....	18
5.2 General Device Setup	18
5.3 Conducted Power.....	20
5.4 Antenna location.....	23
5.5 Stand-alone SAR Evaluate.....	26
5.6 Simultaneous Transmitting Evaluate.....	30
5.7 SAR test reduction according to KDB	32
6. System Verification and Validation	33
6.1 Symmetric Dipoles for System Verification	33
6.2 Liquid Parameters	34
6.3 Verification Summary	35
6.4 Validation Summary	35
7. Test Equipment List.....	36
8. Measurement Uncertainty	37
9. Measurement Procedure.....	39
9.1 Spatial Peak SAR Evaluation	39
9.2 Area & Zoom Scan Procedures	40
9.3 Volume Scan Procedures.....	40
9.4 SAR Averaged Methods.....	40
9.5 Power Drift Monitoring.....	40
10. SAR Test Results Summary	41
10.1 Head Measurement SAR	41
10.2 Body Measurement SAR.....	41
10.3 Extremity Measurement SAR.....	41
10.4 SAR Measurement Variability.....	41
10.5 Std. C95.1-1999 RF Exposure Limit.....	42
11. Conclusion.....	43
12. References	43
13. SAR Measurement Guidance	43
Appendix A - System Performance Check.....	44
Appendix B - SAR Measurement Data	48
Appendix C - Calibration.....	62



1. Description of Equipment under Test (EUT)

Applicant	MilDef Crete Inc.	
Applicant Address	7F, No. 250, Sec.3, Peishen Rd., Shenkeng District, New Taipei City, Taiwan	
Manufacture	MilDef Crete Inc.	
Manufacture Address	7F, No. 250, Sec.3, Peishen Rd., Shenkeng District, New Taipei City, Taiwan	
Product Type	Notebook computer	
Trade Name	MilDef Crete Inc.	
Model Number	DT10	
FCC ID	IR5DT10	
RF Function	IEEE 802.11b / 802.11g / 802.11n (2.4GHz) 20MHz IEEE 802.11n (2.4GHz) 40MHz IEEE 802.11a IEEE 802.11n (5GHz) 20MHz IEEE 802.11n (5GHz) 40MHz Bluetooth v3.0 Bluetooth v4.0 LE	
Tx Frequency	Band	Operate Frequency (MHz)
	IEEE 802.11b / IEEE 802.11g	2412.0 - 2462.0
	IEEE 802.11n (2.4GHz) 20MHz	2412.0 - 2462.0
	IEEE 802.11n (2.4GHz) 40MHz	2422.0 - 2452.0
	IEEE 802.11a U-NII Band I	5180.0 - 5240.0
	IEEE 802.11a U-NII Band III	5745.0 - 5825.0
	IEEE 802.11n (5GHz) 20MHz U-NII Band I	5180.0 - 5240.0
	IEEE 802.11n (5GHz) 20MHz U-NII Band III	5745.0 - 5825.0
	IEEE 802.11n (5GHz) 40MHz U-NII Band I	5190.0 - 5230.0
	IEEE 802.11n (5GHz) 40MHz U-NII Band III	5755.0 - 5795.0
	Bluetooth v3.0	2402.0 - 2480.0
	Bluetooth v4.0 LE	2402.0 - 2480.0
RF Conducted Power (Avg.)	Band	Power (W / dBm)
	IEEE 802.11b	0.050 / 16.98
	IEEE 802.11g	0.027 / 14.30
	IEEE 802.11n (2.4GHz) 20MHz	0.037 / 15.62
	IEEE 802.11n (2.4GHz) 40MHz	0.017 / 12.22
	IEEE 802.11a U-NII Band I	0.015 / 11.66
	IEEE 802.11a U-NII Band III	0.015 / 11.88
	IEEE 802.11n (5GHz) 20MHz U-NII Band I	0.014 / 11.52
	IEEE 802.11n (5GHz) 20MHz U-NII Band III	0.017 / 12.25
	IEEE 802.11n (5GHz) 40MHz U-NII Band I	0.008 / 9.29
	IEEE 802.11n (5GHz) 40MHz U-NII Band III	0.011 / 10.29
	Bluetooth v3.0	0.005 / 6.56
Bluetooth v4.0 LE	0.003 / 4.67	
Max. Reported SAR	0.504 W/kg Body SAR	



Antenna Used	Band	Antenna Port	Type	Max. Gain
	2.4G WLAN	Antenna 1 (MAIN)	PIFA Antenna	0.55 dBi
		Antenna 2 (AUX)		1.81 dBi
	5G WLAN Band I	Antenna 1 (MAIN)	PIFA Antenna	1.68 dBi
		Antenna 2 (AUX)		-6.17 dBi
	5G WLAN Band III	Antenna 1 (MAIN)	PIFA Antenna	1.27 dBi
		Antenna 2 (AUX)		-0.14 dBi
Bluetooth	Antenna 2 (AUX)	PIFA Antenna	1.81 dBi	
Device Category	Portable Device			
RF Exposure Environment	General Population / Uncontrolled			
Application Type	Certification			

This wireless portable device has been shown to be capable of compliance for localized specific absorption rate (SAR) for uncontrolled environment / general population exposure limits specified in Standard C95.1-1999 and had been tested in accordance with the measurement procedures specified in IEEE Std. 1528-2013 and IEEE Std. 1528a-2005.



2. Introduction

The A Test Lab Techno Corp. has performed measurements of the maximum potential exposure to the user of **MilDef Crete Inc. Trade Name : MilDef Crete Inc. Model(s) : DT10**. The test procedures, as described in American National Standards, Institute C95.1-1999 [1] were employed and they specify the maximum exposure limit of 1.6mW/g as averaged over any 1 gram of tissue for portable devices being used within 20cm between user and EUT in the uncontrolled environment. A description of the product and operating configuration, detailed summary of the test results, methodology and procedures used in the equipment used are included within this test report.

2.1 SAR Definition

Specific Absorption Rate (SAR) is defined as the time derivative (rate) of the incremental energy (dw) absorbed by (dissipated in) an incremental mass (dm) contained in a volume element (dv) of a given density (ρ). It is also defined as the rate of RF energy absorption per unit mass at a point in an absorbing body (see Figure 2).

$$\text{SAR} = \frac{d}{dt} \left(\frac{dw}{dm} \right) = \frac{d}{dt} \left(\frac{dw}{\rho dv} \right)$$

Figure 2. SAR Mathematical Equation

SAR is expressed in units of Watts per kilogram (W/kg)

$$\text{SAR} = \frac{\sigma E^2}{\rho}$$

Where :

σ = conductivity of the tissue (S/m)

ρ = mass density of the tissue (kg/m³)

E = RMS electric field strength (V/m)

*Note :

The primary factors that control rate of energy absorption were found to be the wavelength of the incident field in relations to the dimensions and geometry of the irradiated organism, the orientation of the organism in relation to the polarity of field vectors, the presence of reflecting surfaces, and whether conductive contact is made by the organism with a ground plane [2]

3. SAR Measurement Setup

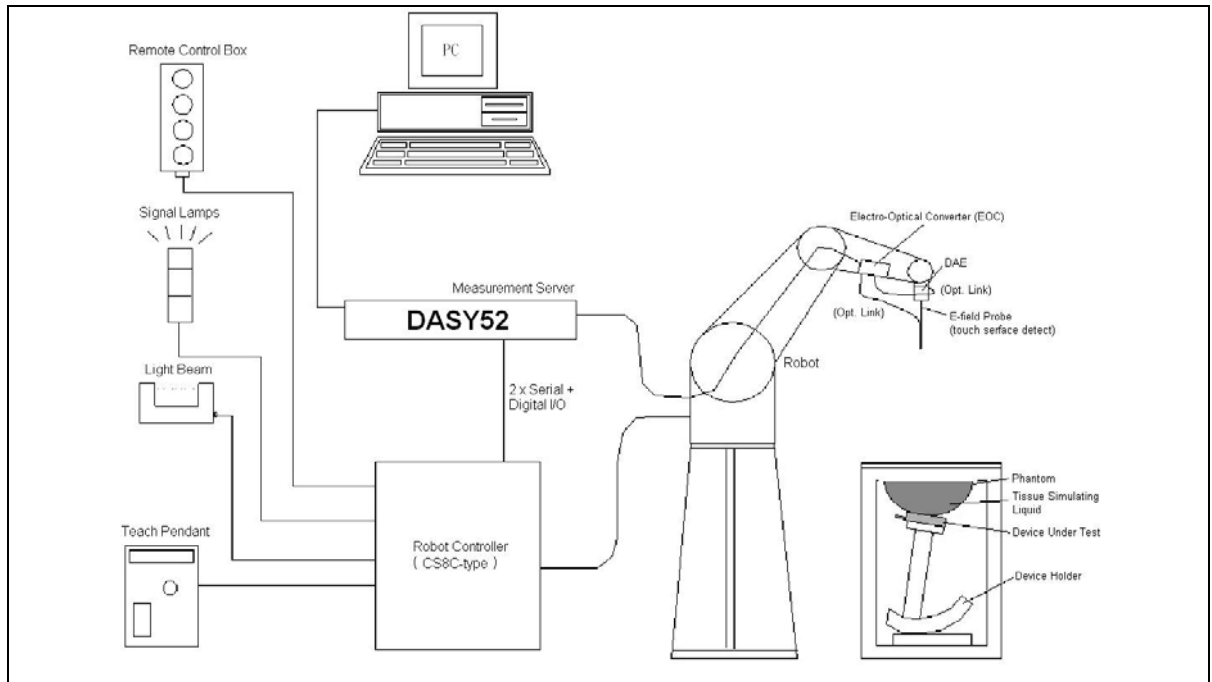

The DASY52 system for performing compliance tests consists of the following items:

1. A standard high precision 6-axis robot (Stäubli TX family) with controller, teach pendant and software. An arm extension for accommodating the data acquisition electronics (DAE).
2. A dosimetric probe, i.e., an isotropic E-field probe optimized and calibrated for usage in tissue simulating liquid. The probe is equipped with an optical surface detector system.
3. A data acquisition electronics (DAE) which performs the signal amplification, signal multiplexing, AD-conversion, offset measurements, mechanical surface detection, collision detection, etc. The unit is battery powered with standard or rechargeable batteries. The signal is optically transmitted to the EOC.
4. The function of the measurement server is to perform the time critical tasks such as signal filtering, control of the robot operation and fast movement interrupts.
5. A probe alignment unit which improves the (absolute) accuracy of the probe positioning.
6. A computer operating Windows 2000 or Windows XP.
7. DASY52 software.
8. Remote controls with teach pendant and additional circuitry for robot safety such as warning lamps, etc.
9. The SAM twin phantom enabling testing left-hand and right-hand usage.
10. The device holder for handheld mobile phones.
11. Tissue simulating liquid mixed according to the given recipes.
12. Validation dipole kits allowing validating the proper functioning of the system.



3.1 DASYS E-Field Probe System

The SAR measurements were conducted with the dosimetric probe (manufactured by SPEAG), designed in the classical triangular configuration [3] and optimized for dosimetric evaluation. The probe is constructed using the thick film technique; with printed resistive lines on ceramic substrates. The probe is equipped with an optical multi-fiber line ending at the front of the probe tip. It is connected to the EOC box on the robot arm and provides an automatic detection of the phantom surface. Half of the fibers are connected to a pulsed infrared transmitter, the other half to a synchronized receiver. As the probe approaches the surface, the reflection from the surface produces a coupling from the transmitting to the receiving fibers. This reflection increases first during the approach, reaches maximum and then decreases. If the probe is flatly touching the surface, the coupling is zero. The distance of the coupling maximum to the surface is independent of the surface reflectivity and largely independent of the surface to probe angle. The DASYS software reads the reflection during a software approach and looks for the maximum using a 2nd order fitting. The approach is stopped when reaching the maximum.

3.1.1 E-Field Probe Specification

Construction	<p>Symmetrical design with triangular core</p> <p>Built-in optical fiber for surface detection System</p> <p>Built-in shielding against static charges</p> <p>PEEK enclosure material (resistant to organic solvents, e.q., glycol)</p>
Calibration	<p>In air from 10 MHz to 6 GHz</p> <p>In brain and muscle simulating tissue at frequencies of 2450MHz, 5200MHz and 5800MHz (accuracy $\pm 8\%$)</p> <p>Calibration for other liquids and frequencies upon request</p>
Frequency	± 0.2 dB (30 MHz to 6 GHz)
Directivity	<p>± 0.3 dB in brain tissue (rotation around probe axis)</p> <p>± 0.5 dB in brain tissue (rotation normal probe axis)</p> <p>Dynamic Range 10μW/g to > 100mW/g; Linearity: ± 0.2dB</p>
Dimensions	<p>Overall length: 337mm</p> <p>Tip length: 9mm</p> <p>Body diameter: 10mm</p> <p>Tip diameter: 2.5mm</p> <p>Distance from probe tip to dipole centers: 1.0mm</p>
Application	<p>General dosimetry up to 6GHz</p> <p>Compliance tests of mobile phones</p> <p>Fast automatic scanning in arbitrary phantoms</p>



Figure 3. E-field Probe



Figure 4. Probe setup on robot



3.1.2 E-Field Probe Calibration process

Dosimetric Assessment Procedure

Each E-Probe/Probe Amplifier combination has unique calibration parameters. A TEM cell calibration procedure is conducted to determine the proper amplifier settings to enter in the probe parameters. The amplifier settings are determined for a given frequency by subjecting the probe to a known E-field density (1 mW/cm²) using an RF Signal generator, TEM cell, and RF Power Meter.

Free Space Assessment

The free space E-field from amplified probe outputs is determined in a test chamber. This calibration can be performed in a TEM cell if the frequency is below 1 GHz and in a waveguide or other methodologies above 1 GHz for free space. For the free space calibration, the probe is placed in the volumetric center of the cavity and at the proper orientation with the field. The probe is rotated 360 degrees until the three channels show the maximum reading. The power density readings equates to 1 mW/cm².

Temperature Assessment

E-field temperature correlation calibration is performed in a flat phantom filled with the appropriate simulated head tissue. The E-field in the medium correlates with the temperature rise in the dielectric medium. For temperature correlation calibration a RF transparent thermistor-based temperature probe is used in conjunction with the E-field probe.

$$SAR = C \frac{\Delta T}{\Delta t}$$

Where :

- Δt = Exposure time (30 seconds),
- C = Heat capacity of tissue (head or body),
- ΔT = Temperature increase due to RF exposure.

$$\text{Or } SAR = \frac{|E|^2 \sigma}{\rho}$$

Where :

- σ = Simulated tissue conductivity,
- ρ = Tissue density (kg/m³).



3.2 Data Acquisition Electronic (DAE) System

Cell Controller

Processor : Intel Core(TM)2 CPU
Clock Speed : @ 1.86GHz
Operating System : Windows XP Professional

Data Converter

Features : Signal Amplifier, multiplexer, A/D converter, and control logic
Software : DASY52 v52.8 (7) & SEMCAD X Version 14.6.10 (7164)
Connecting Lines : Optical downlink for data and status info
Optical uplink for commands and clock

3.3 Robot

Positioner : Stäubli Unimation Corp. Robot Model: TX90XL
Repeatability : ± 0.02 mm
No. of Axis : 6

3.4 Measurement Server

Processor : PC/104 with a 400MHz intel ULV Celeron
I/O-board : Link to DAE4 (or DAE3)
16-bit A/D converter for surface detection system
Digital I/O interface
Serial link to robot
Direct emergency stop output for robot

3.5 Device Holder

The DASY device holder is constructed of low-loss POM material having the following dielectric parameters: relative permittivity $\epsilon=3$ and loss tangent $\delta=0.02$. The amount of dielectric material has been reduced in the closest vicinity of the device, since measurements have suggested that the influence of the clamp on the test results could thus be lowered.

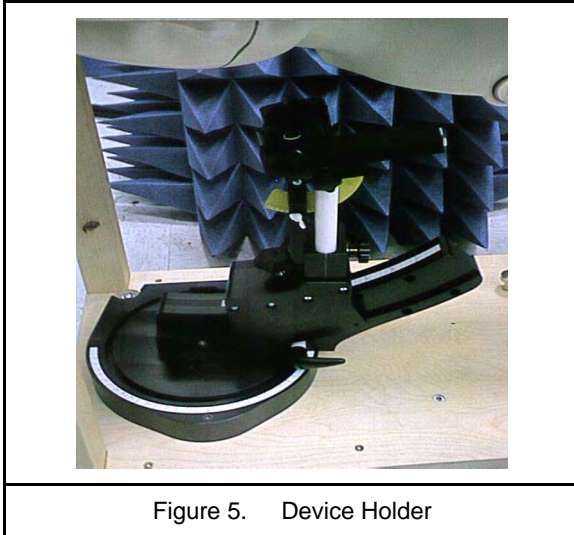

3.6 Phantom - SAM v4.0

The shell corresponds to the specifications of the Specific Anthropomorphic Mannequin (SAM) phantom defined in IEEE 1528 and IEC 62209. It enables the dosimetric evaluation of left and right hand phone usage as well as body mounted usage at the flat phantom region. A cover prevents evaporation of the liquid. Reference markings on the phantom allow the complete setup of all predefined phantom positions and measurement grids by manually teaching three points with the robot.

Shell Thickness	2 ±0.2 mm
Filling Volume	Approx. 25 liters
Dimensions	1000x500 mm (LxW)
Table 1. Specification of SAM v4.0	



Figure 6. SAM Twin Phantom

3.7 Oval Flat Phantom - ELI 4.0

The shell corresponds to the specifications of the Specific Anthropomorphic Mannequin (Oval Flat) phantom defined in IEEE 1528-2013, IEEE Std. 1528a-2005, CENELEC 50361 and IEC 62209. It enables the dosimetric evaluation of wireless portable device usage as well as body mounted usage at the flat phantom region. A cover prevents evaporation of the liquid. Reference markings on the phantom allow the complete setup of all predefined phantom positions and measurement grids by manually teaching three points with the robot.

Shell Thickness	2 ±0.2 mm
Filling Volume	Approx. 30 liters
Dimensions	190×600×400 mm (H×L×W)
Table 2. Specification of ELI 4.0	

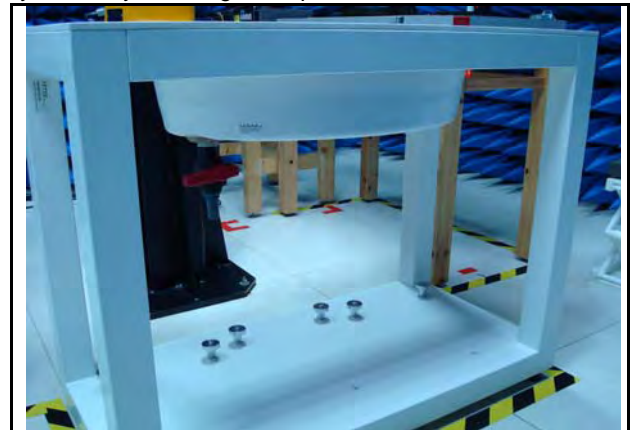

Figure 7. Oval Flat Phantom

3.8 Data Storage and Evaluation

3.8.1 Data Storage

The DASY software stores the assessed data from the data acquisition electronics as raw data (in microvolt readings from the probe sensors), together with all the necessary software parameters for the data evaluation (probe calibration data, liquid parameters and device frequency and modulation data) in measurement files with the extension DA4 or DA5. The post processing software evaluates the desired unit and format for output each time the data is visualized or exported. This allows verification of the complete software setup even after the measurement and allows correction of erroneous parameter settings. For example, if a measurement has been performed with an incorrect crest factor parameter in the device setup, the parameter can be corrected afterwards and the data can be reevaluated.



3.8.2 Data Evaluation

The DASY post processing software (SEMCAD) automatically executes the following procedures to calculate the field units from the microvolt readings at the probe connector. The parameters used in the evaluation are stored in the configuration modules of the software :

- Probe parameters : - Sensitivity $Norm_i, ai0, ai1, ai2$
- Conversion factor $ConvFi$
- Diode compression point dcp_i
- Device parameters : - Frequency f
- Crest factor cf
- Media parameters : - Conductivity σ
- Density ρ

These parameters must be set correctly in the software. They can be found in the component documents or they can be imported into the software from the configuration files issued for the DASY components. In the direct measuring mode of the multimeter option, the parameters of the actual system setup are used. In the scan visualization and export modes, the parameters stored in the corresponding document files are used.

The first step of the evaluation is a linearization of the filtered input signal to account for the compression characteristics of the detector diode. The compensation depends on the input signal, the diode type and the DC-transmission factor from the diode to the evaluation electronics. If the exciting field is pulsed, the crest factor of the signal must be known to correctly compensate for peak power. The formula for each channel can be given as :

$$V_i = U_i + U_i^2 \cdot \frac{cf}{dcp_i}$$

- With V_i = compensated signal of channel i (i = x, y, z)
 U_i = input signal of channel i (i = x, y, z)
 cf = crest factor of exciting field (DASY parameter)
 dcp_i = diode compression point (DASY parameter)

From the compensated input signals the primary field data for each channel can be evaluated :

E-field probes :
$$E_i = \sqrt{\frac{V_i}{Norm_i \cdot ConvF}}$$



$$H_i = \sqrt{V_i} \cdot \frac{a_{i0} + a_{i1}f + a_{i2}f^2}{f}$$

H-field probes :

- with V_i = compensated signal of channel i (i = x, y, z)
Normi = sensor sensitivity of channel i (i = x, y, z)
 $\mu V/(V/m)^2$ for E-field Probes
ConvF = sensitivity enhancement in solution
 a_{ij} = sensor sensitivity factors for H-field probes
 f = carrier frequency [GHz]
 E_i = electric field strength of channel i in V/m
 H_i = magnetic field strength of channel i in A/m

The RSS value of the field components gives the total field strength (Hermitian magnitude) :

$$E_{tot} = \sqrt{E_x^2 + E_y^2 + E_z^2}$$

The primary field data are used to calculate the derived field units.

$$SAR = E_{tot}^2 \cdot \frac{\sigma}{\rho \cdot 1000}$$

- with SAR = local specific absorption rate in mW/g
 E_{tot} = total field strength in V/m
 σ = conductivity in [mho/m] or [Siemens/m]
 ρ = equivalent tissue density in g/cm³

* Note : That the density is set to 1, to account for actual head tissue density rather than the density of the tissue simulating liquid.

The power flow density is calculated assuming the excitation field to be a free space field.

$$P_{pwe} = \frac{E_{tot}^2}{3770} \quad \text{or} \quad P_{pwe} = \frac{H_{tot}^2}{37.7}$$

- with P_{pwe} = equivalent power density of a plane wave in mW/cm²
 E_{tot} = total electric field strength in V/m
 H_{tot} = total magnetic field strength in A/m



4. Tissue Simulating Liquids

The mixture is calibrated to obtain proper dielectric constant (permittivity) and conductivity of the tissue.

The dielectric parameters of the liquids were verified prior to the SAR evaluation using an 85070C Dielectric Probe Kit and an E5071B Network Analyzer.

IEEE SCC-34/SC-2 in 1528 recommended Tissue Dielectric Parameters

The head tissue dielectric parameters recommended by the IEEE SCC-34/SC-2 in 1528 have been incorporated in the following table. These head parameters are derived from planar layer models simulating the highest expected SAR for the dielectric properties and tissue thickness variations in human head. Other head and body tissue parameters that have not been specified in 1528 are derived from the tissue dielectric parameters computed from the 4-Cole-Cole equation and extrapolated according to the head parameter specified in 1528.

Target Frequency	Head		Body	
(MHz)	ϵ_r	σ (S/m)	ϵ_r	σ (S/m)
150	52.3	0.76	61.9	0.80
300	45.3	0.87	58.2	0.92
450	43.5	0.87	56.7	0.94
835	41.5	0.90	55.2	0.97
900	41.5	0.97	55.0	1.05
915	41.5	0.98	55.0	1.06
1450	40.5	1.20	54.0	1.30
1610	40.3	1.29	53.8	1.40
1800 - 2000	40.0	1.40	53.3	1.52
2450	39.2	1.80	52.7	1.95
3000	38.5	2.40	52.0	2.73
5800	35.3	5.27	48.2	6.00
(ϵ_r = relative permittivity, σ = conductivity and $\rho = 1000$ kg/m ³)				

Table 3. Tissue dielectric parameters for head and body phantoms



4.1 Ingredients

The following ingredients are used:

- Water: deionized water (pure H₂O), resistivity $\geq 16 \text{ M } \Omega$ -as basis for the liquid
- Sugar: refined white sugar (typically 99.7 % sucrose, available as crystal sugar in food shops)
-to reduce relative permittivity
- Salt: pure NaCl -to increase conductivity
- Cellulose: Hydroxyethyl-cellulose, medium viscosity (75-125 mPa.s, 2% in water, 20 °C), CAS # 54290 -to increase viscosity and to keep sugar in solution.
- Preservative: Preventol D-7 Bayer AG, D-51368 Leverkusen, CAS # 55965-84-9 -to prevent the spread of bacteria and molds
- DGBE: Diethylenglycol-monobutyl ether (DGBE), Fluka Chemie GmbH, CAS # 112-34-5 -to reduce relative permittivity

4.2 Recipes

The following tables give the recipes for tissue simulating liquids to be used in different frequency bands.

Note: The goal dielectric parameters (at 22 °C) must be achieved within a tolerance of $\pm 5\%$ for ϵ and $\pm 5\%$ for σ .

Ingredients (% by weight)	Frequency (MHz)											
	750		835		1750		1900		2450		2600	
Tissue Type	Head	Body	Head	Body	Head	Body	Head	Body	Head	Body	Head	Body
Water	39.28	51.30	41.45	52.40	54.50	40.20	54.90	40.40	62.70	73.20	60.30	71.40
Salt (NaCl)	1.47	1.42	1.45	1.50	0.17	0.49	0.18	0.50	0.50	0.10	0.60	0.20
Sugar	58.15	46.18	56.00	45.00	0.00	0.00	0.00	0.00	0.00	0.00	0.00	0.00
HEC	1.00	1.00	1.00	1.00	0.00	0.00	0.00	0.00	0.00	0.00	0.00	0.00
Bactericide	0.10	0.10	0.10	0.10	0.00	0.00	0.00	0.00	0.00	0.00	0.00	0.00
Triton X-100	0.00	0.00	0.00	0.00	0.00	0.00	0.00	0.00	0.00	0.00	0.00	0.00
DGBE	0.00	0.00	0.00	0.00	45.33	59.31	44.92	59.10	36.80	26.70	39.10	28.40
Dielectric Constant	41.88	54.60	42.54	56.10	40.10	53.60	39.90	54.00	39.80	52.50	39.80	52.50
Conductivity (S/m)	0.90	0.97	0.91	0.95	1.39	1.49	1.42	1.45	1.88	1.78	1.88	1.78

Salt: 99% Pure Sodium Chloride

Sugar: 98% Pure Sucrose

Water: De-ionized, $16 \text{ M } \Omega^+$ resistivity

HEC: Hydroxyethyl Cellulose

DGBE: 99% Di(ethylene glycol) butyl ether, [2-(2-butoxyethoxy)ethanol]

Triton X-100 (ultra pure): Polyethylene glycol mono [4-(1,1, 3, 3-tetramethylbutyl)phenyl]ether

4.3 Liquid Depth

According to KDB865664 ,the depth of tissue-equivalent liquid in a phantom must be ≥ 15.0 cm with $\leq \pm 0.5$ cm variation for SAR measurements ≤ 3 GHz and ≥ 10.0 cm with $\leq \pm 0.5$ cm variation for measurements > 3 GHz.

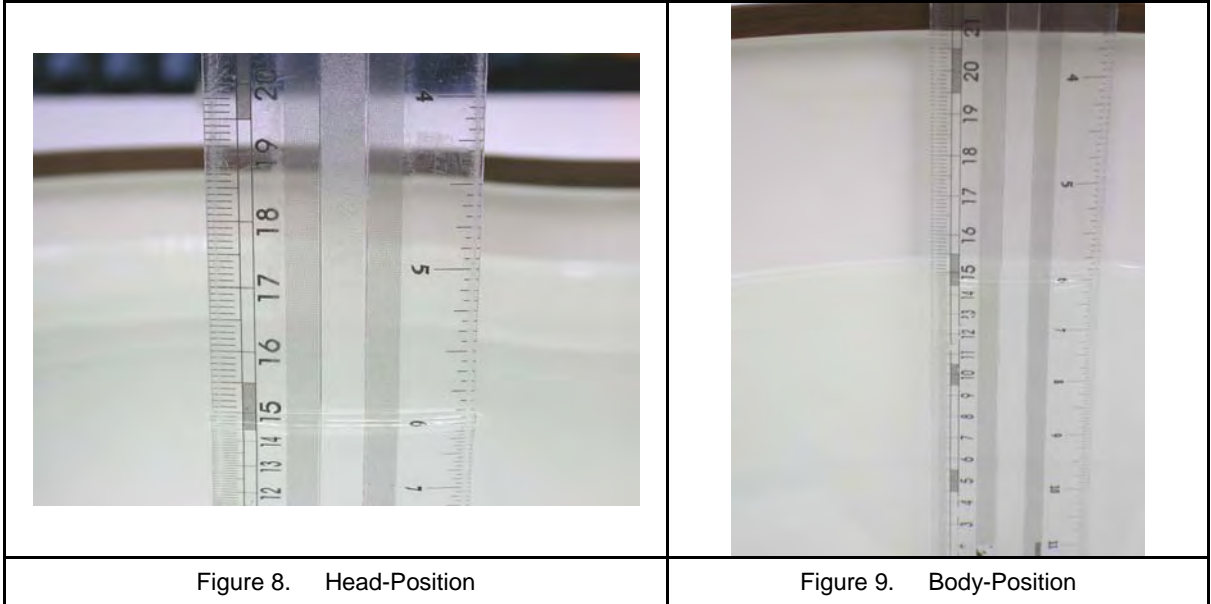



5. SAR Testing with RF Transmitters

5.1 SAR Testing with 802.11 Transmitters

Normal network operating configurations are not suitable for measuring the SAR of 802.11 b/g transmitters. Unpredictable fluctuations in network traffic and antenna diversity conditions can introduce undesirable variations in SAR results. The SAR for these devices should be measured using chipset based test mode software to ensure the results are consistent and reliable.

5.2 General Device Setup

Chipset based test mode software is hardware dependent and generally varies among manufacturers. The device operating parameters established in test mode for SAR measurements must be identical to those programmed in production units, including output power levels, amplifier gain settings and other RF performance tuning parameters. The test frequencies should correspond to actual channel frequencies defined for domestic use. SAR for devices with switched diversity should be measured with only one antenna transmitting at a time during each SAR measurement, according to a fixed modulation and data rate. The same data pattern should be used for all measurements.

Frequency Channel Configurations

802.11 a/b/g and 4.9 GHz operating modes are tested independently according to the service requirements in each frequency band. 802.11 b/g modes are tested on channels 1, 6 and 11. 802.11a is tested for UNII operations on channels 36 and 48 in the 5.15-5.25 GHz band; channels 52 and 64 in the 5.25-5.35 GHz band; channels 104, 116, 124 and 136 in the 5.470-5.725 GHz band; and channels 149 and 161 in the 5.8 GHz band. When 5.8 GHz §15.247 is also available, channels 149, 157 and 165 should be tested instead of the UNII channels. 4.9 GHz is tested on channels 1, 10 and 5 or 6, whichever has the higher output power, for 5 MHz channels; channels 11, 15 and 19 for 10 MHz channels; and channels 21 and 25 for 20 MHz channels. These are referred to as the “default test channels”. 802.11g mode was evaluated only if the output power was 0.25 dB higher than the 802.11b mode.



IEEE 802.11 Test Channels per FCC Requirement								
Mode	GHz	Channel	Turbo Channel	Default Test "Channels"				
				§15.247		UNII		
				802.11b	802.11g			
IEEE 802.11 b/g	2412	1 [#]		✓	▽			
	2437	6	6	✓	▽			
	2462	11 [#]		✓	▽			
IEEE 802.11a	UNII	5.18	36				✓	
		5.20	40	42 (5.21 GHz)				*
		5.22	44					*
		5.24	48	50 (5.25 GHz)			✓	
		5.26	52				✓	
		5.28	56	58 (5.29 GHz)				*
		5.30	60					*
		5.32	64				✓	
		5.500	100	Unknown				*
		5.520	104				✓	
		5.540	108					*
		5.560	112					*
		5.580	116				✓	
		5.660	132					*
		5.680	136				✓	
		5.700	140					*
		UNII or §15.247	5.745	149		✓		✓
	5.765		153	152 (5.76 GHz)		*		*
	5.785		157		✓			*
	5.805		161	160 (5.80 GHz)		*	✓	
§15.247	5.825	165		✓				

✓ = "default test channels"

* = possible 802.11a channels with maximum average output > the "default test channels"

▽ = possible 802.11g channels with maximum average output ¼ dB ≥ the "default test channels"

= when output power is reduced for channel 1 and/or 11 to meet restricted band requirements the



5.3 Conducted Power

Band	Data Rate	CH	Frequency (MHz)	Average Power (dBm)	
				ANT 1	ANT 2
IEEE 802.11b	1 M	1	2412.0	16.95	16.93
		6	2437.0	16.93	16.98
		11	2462.0	16.64	16.52
	2 M	6	2437.0	16.59	16.68
	5.5 M	6	2437.0	16.81	16.83
	11 M	6	2437.0	16.59	16.76
IEEE 802.11g	6 M	1	2412.0	13.20	14.22
		6	2437.0	13.72	14.30
		11	2462.0	13.70	14.13
	9 M	6	2437.0	13.57	14.24
	12 M	6	2437.0	13.67	14.28
	18 M	6	2437.0	13.63	14.16
	24 M	6	2437.0	13.66	14.26
	36 M	6	2437.0	13.67	14.12
	48 M	6	2437.0	13.69	14.19
	54 M	6	2437.0	13.67	14.22

Band	Data Rate	CH	Frequency (MHz)	Average Power (dBm)		
				ANT 1	ANT 2	ANT 1 + 2
IEEE 802.11n 20MHz (2.4 GHz)	6.5 M	1	2412.0	12.17	12.79	15.50
		6	2437.0	11.91	13.22	15.62
		11	2462.0	12.18	12.98	15.61
	13.0 M	6	2437.0	11.79	13.09	15.50
	19.5 M	6	2437.0	11.81	13.12	15.52
	26.0 M	6	2437.0	11.90	12.52	15.23
	39.0 M	6	2437.0	11.86	13.13	15.55
	52.0 M	6	2437.0	11.67	13.01	15.40
	58.5 M	6	2437.0	11.86	13.09	15.53
	65.0 M	6	2437.0	11.66	13.14	15.47
IEEE 802.11n 40MHz (2.4 GHz)	13.5 M	3	2422.0	9.03	9.04	12.05
		6	2437.0	9.00	9.39	12.21
		9	2452.0	8.76	9.61	12.22
	27M	6	2437.0	8.54	9.28	11.94
	40.5M	6	2437.0	8.64	9.30	11.99
	54M	6	2437.0	8.68	8.99	11.85
	81M	6	2437.0	8.70	8.98	11.85
	108M	6	2437.0	7.57	8.51	11.08
	121.5M	6	2437.0	7.69	8.47	11.11
	135M	6	2437.0	7.77	8.16	10.98



Band	Data Rate	CH	Frequency (MHz)	Average Power (dBm)	
				ANT 1	ANT 2
IEEE 802.11a	6 M	36	5180.0	10.51	11.66
		40	5200.0	10.33	11.64
		44	5220.0	10.39	11.40
		48	5240.0	10.06	10.98
	54 M	36	5180.0	9.83	11.63
		40	5200.0	9.75	11.61
		44	5220.0	9.78	11.39
		48	5240.0	9.73	10.97
	6 M	149	5745.0	11.11	11.14
		153	5765.0	10.83	11.32
		157	5785.0	11.01	11.88
		161	5805.0	10.51	11.81
	54 M	165	5825.0	10.10	11.64
		149	5745.0	11.05	10.06
		153	5765.0	10.78	10.10
		157	5785.0	10.71	10.18
		161	5805.0	10.48	10.02
		165	5825.0	10.03	10.14

Band	Data Rate	CH	Frequency (MHz)	Average Power (dBm)		
				ANT 1	ANT 2	ANT 1 + 2
IEEE 802.11n 20MHz (5 GHz)	13 M	36	5180.0	7.35	8.92	11.22
		40	5200.0	7.47	8.70	11.14
		44	5220.0	7.64	9.23	11.52
		48	5240.0	7.53	9.20	11.46
	130 M	36	5180.0	7.30	8.90	11.18
		40	5200.0	7.37	8.66	11.07
		44	5220.0	7.53	9.18	11.44
		48	5240.0	7.41	9.15	11.38
	13 M	149	5745.0	8.36	8.78	11.59
		153	5765.0	8.60	8.34	11.48
		157	5785.0	9.21	9.26	12.25
		161	5805.0	8.91	8.83	11.88
		165	5825.0	8.79	8.72	11.77
	130 M	149	5745.0	8.24	8.75	11.51
		153	5765.0	8.51	8.29	11.41
		157	5785.0	7.95	9.10	11.57
		161	5805.0	8.85	8.33	11.61
		165	5825.0	8.75	8.63	11.70



Band	Data Rate	CH	Frequency (MHz)	Average Power (dBm)		
				ANT 1	ANT 2	ANT 1 + 2
IEEE 802.11n 40MHz (5 GHz)	27 M	38	5190.0	5.38	7.02	9.29
		46	5230.0	5.28	6.98	9.22
	270 M	38	5190.0	5.18	6.38	8.83
		46	5230.0	5.13	6.57	8.92
	27 M	151	5755.0	6.76	7.08	9.93
		159	5795.0	6.84	7.67	10.29
	270 M	151	5755.0	6.42	6.97	9.71
		159	5795.0	6.51	7.62	10.11

Band	CH	Frequency (MHz)	Packet Type	Average Power (dBm)
Bluetooth v3.0 GFSK	0	2402	DH1	4.04
			DH3	5.49
			DH5	5.72
	39	2441	DH1	3.23
			DH3	4.71
			DH5	4.93
	78	2480	DH1	4.88
			DH3	6.33
			DH5	6.56
Bluetooth v3.0 $\pi/4$ -DQPSK	0	2402	DH1	-0.10
			DH3	1.00
			DH5	1.18
	39	2441	DH1	-0.22
			DH3	0.87
			DH5	1.04
	78	2480	DH1	2.05
			DH3	3.15
			DH5	3.31
Bluetooth v3.0 8DPSK	0	2402	DH1	-0.12
			DH3	0.93
			DH5	1.11
	39	2441	DH1	-0.22
			DH3	0.86
			DH5	1.03
	78	2480	DH1	2.06
			DH3	3.13
			DH5	3.32
Bluetooth v4.0 LE	0	2402	---	3.75
	19	2440	---	3.05
	39	2480	---	4.67



5.4 Antenna location

Antenna-User			
Distance of Antenna 1 (WLAN) to edge		Distance of Antenna 2 (WLAN & Bluetooth) to edge	
WLAN to Side 1	26mm	WLAN & Bluetooth to Side 1	0mm
WLAN to Side 2	19mm	WLAN & Bluetooth to Side 2	42mm
WLAN to Side 3	29mm	WLAN & Bluetooth to Side 3	108mm
WLAN to Side 4	190mm	WLAN & Bluetooth to Side 4	114mm
WLAN to Side 5	22mm	WLAN & Bluetooth to Side 5	242mm
WLAN to Side 6	232mm	WLAN & Bluetooth to Side 6	14mm
Antenna-Antenna			
Antenna account		Distance (mm)	
Antenna 1 to Antenna 2		232	

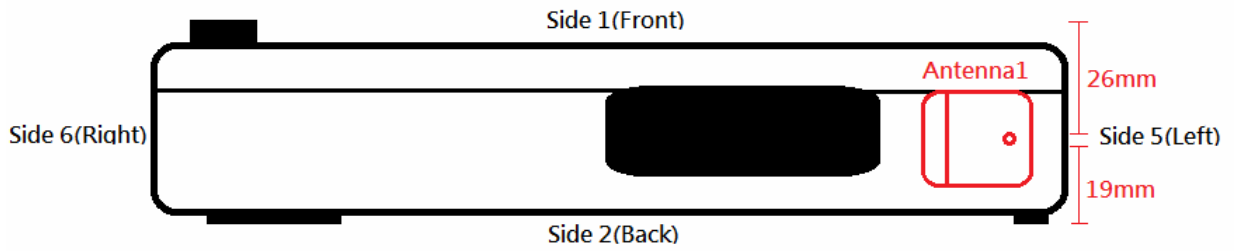
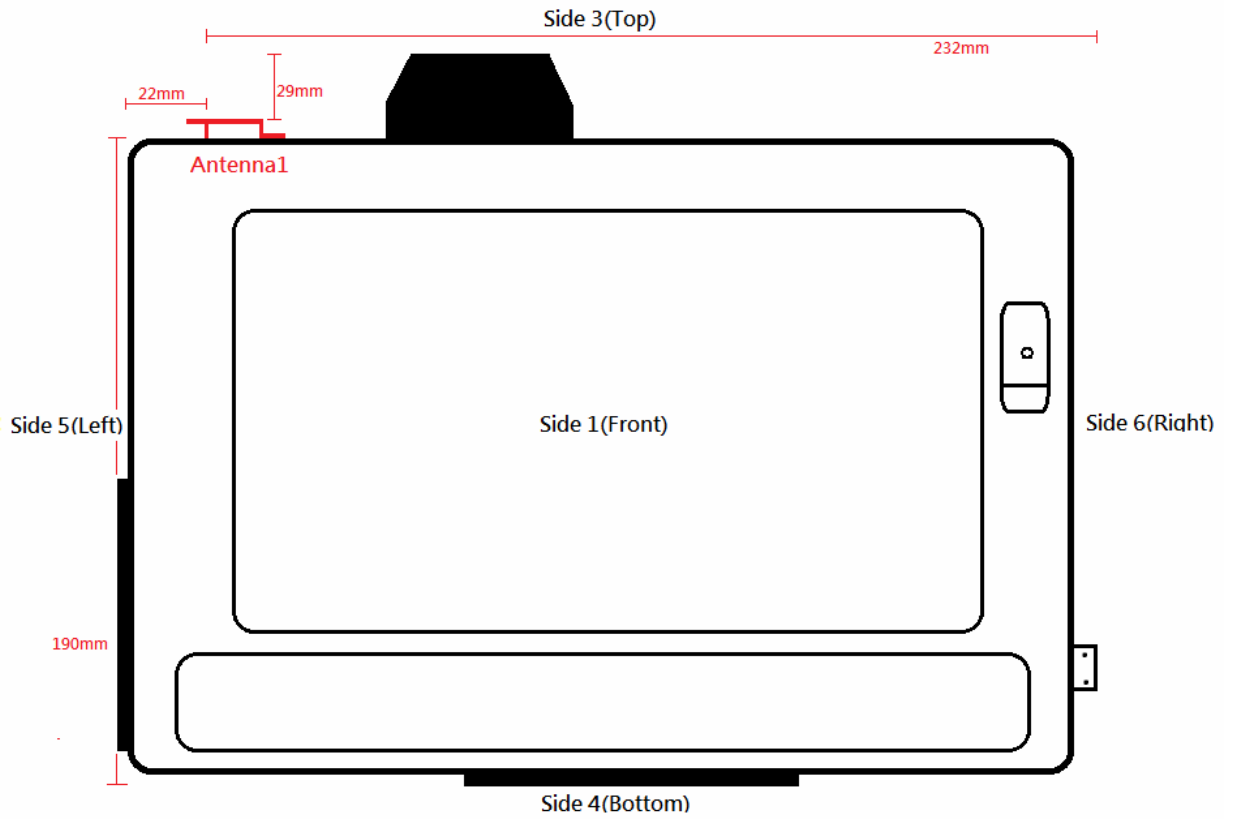

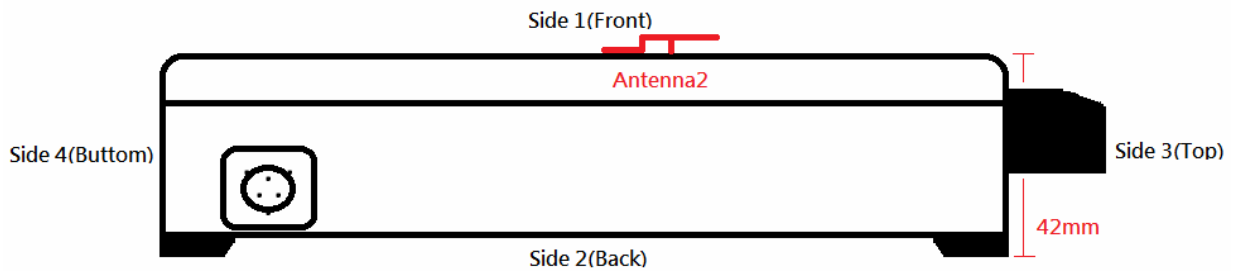
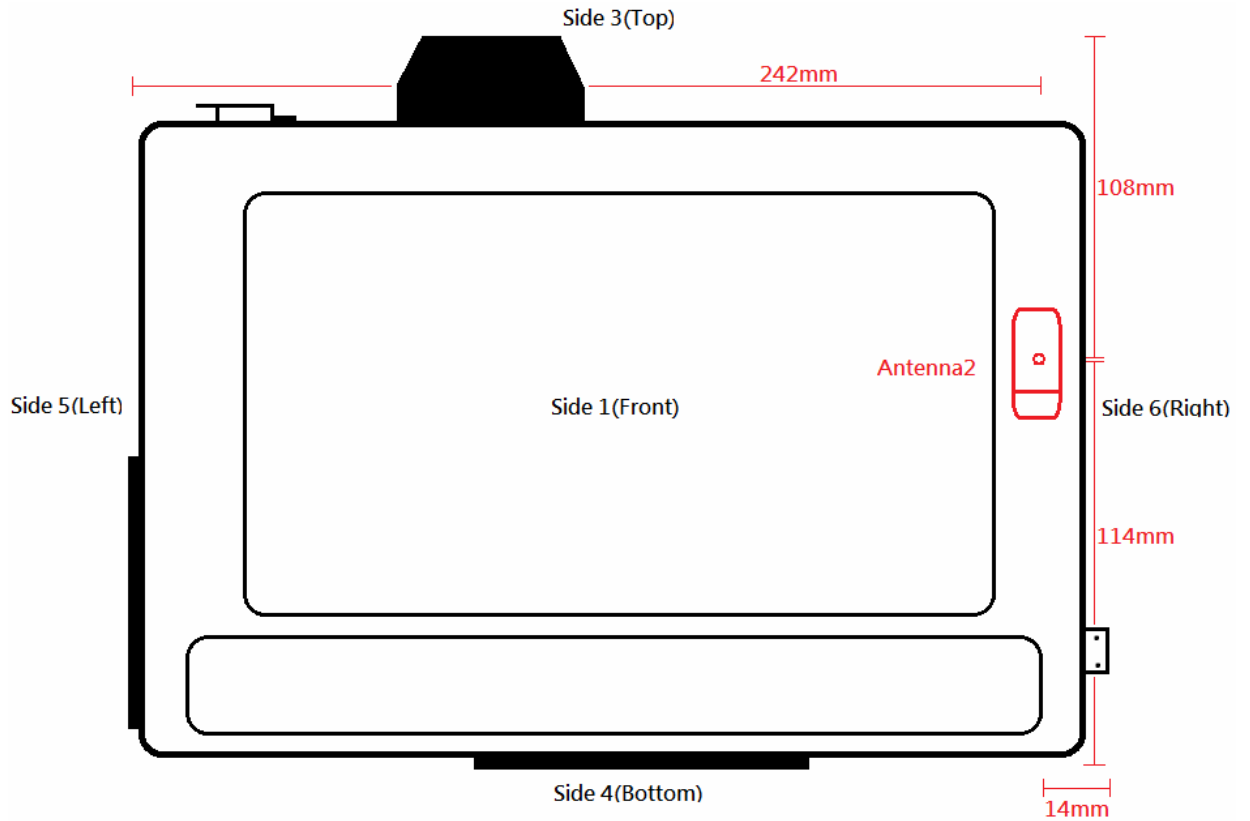

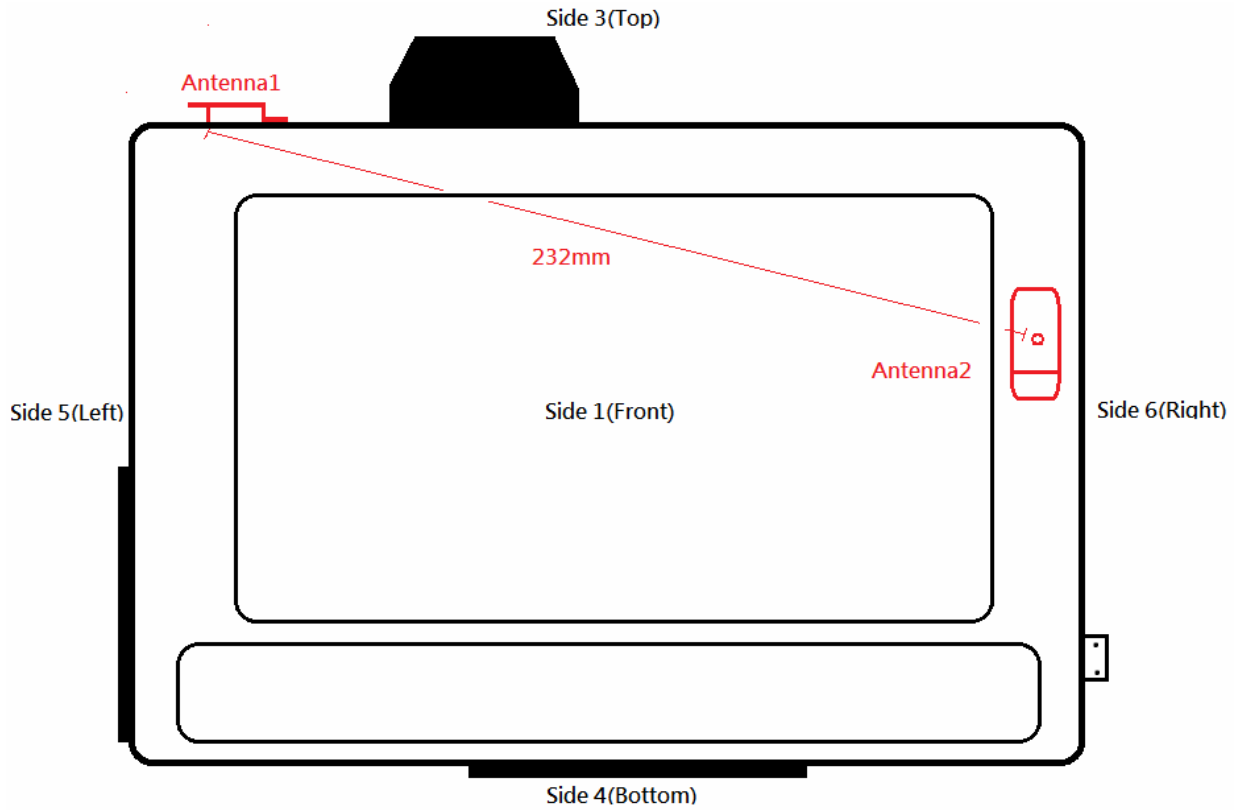

5.5 Stand-alone SAR Evaluate

Transmitter and antenna implementation as below:

Band	Antenna 1	Antenna 2
WLAN	V	V
Bluetooth	-	V



< 50 mm

Antenna	Side	Band	Channel	Power (dBm)	Frequency (GHz)	Distance (mm)	Power (mW)	Result	Limit	Exclusion Considerations SAR ^{1g}
Antenna 1 (WLAN)	1	IEEE 802.11b	1	17.0	2.412	26	50	3.0	3	SAR is not required
		IEEE 802.11a	36	11.5	5.180	26	14	1.2	3	SAR is not required
		IEEE 802.11a	44	11.5	5.220	26	14	1.2	3	SAR is not required
		IEEE 802.11a	149	11.5	5.745	26	14	1.3	3	SAR is not required
		IEEE 802.11a	157	11.5	5.785	26	14	1.3	3	SAR is not required
Antenna 2 (WLAN & Bluetooth)		IEEE 802.11b	6	17.0	2.437	5	50	15.6	3	SAR is required
		IEEE 802.11a	36	12.0	5.180	5	16	7.3	3	SAR is required
		IEEE 802.11a	40	12.0	5.200	5	16	7.3	3	SAR is required
		IEEE 802.11a	157	12.0	5.785	5	16	7.7	3	SAR is required
		IEEE 802.11a	161	12.0	5.805	5	16	7.7	3	SAR is required
		Bluetooth v3.0	78	7.0	2.480	5	5	1.6	3	SAR is not required
MIMO	Bluetooth v4.0 LE	39	5.0	2.480	5	3	0.9	3	SAR is not required	
	IEEE 802.11n 20 (5GHz)	44	12.5	5.220	5	18	8.2	3	SAR is required	
	IEEE 802.11n 20 (5GHz)	48	12.5	5.240	5	18	8.2	3	SAR is required	
	IEEE 802.11n 20 (5GHz)	157	12.5	5.785	5	18	8.7	3	SAR is required	
Antenna 1 (WLAN)	2	IEEE 802.11b	1	17.0	2.412	19	50	4.1	3	SAR is required
		IEEE 802.11a	36	11.5	5.180	19	14	1.7	3	SAR is not required
		IEEE 802.11a	44	11.5	5.220	19	14	1.7	3	SAR is not required
		IEEE 802.11a	149	11.5	5.745	19	14	1.8	3	SAR is not required
		IEEE 802.11a	157	11.5	5.785	19	14	1.8	3	SAR is not required
Antenna 2 (WLAN & Bluetooth)		IEEE 802.11b	6	17.0	2.437	42	50	1.9	3	SAR is not required
		IEEE 802.11a	36	12.0	5.180	42	16	0.9	3	SAR is not required
		IEEE 802.11a	40	12.0	5.200	42	16	0.9	3	SAR is not required
		IEEE 802.11a	157	12.0	5.785	42	16	0.9	3	SAR is not required
		IEEE 802.11a	161	12.0	5.805	42	16	0.9	3	SAR is not required
		Bluetooth v3.0	78	7.0	2.480	42	5	0.2	3	SAR is not required
MIMO		Bluetooth v4.0 LE	39	5.0	2.480	42	3	0.1	3	SAR is not required
		IEEE 802.11n 20 (5GHz)	44	12.5	5.220	19	18	2.2	3	SAR is not required
		IEEE 802.11n 20 (5GHz)	48	12.5	5.240	19	18	2.2	3	SAR is not required
	IEEE 802.11n 20 (5GHz)	157	12.5	5.785	19	18	2.3	3	SAR is not required	
		IEEE 802.11n 20 (5GHz)	161	12.5	5.805	19	18	2.3	3	SAR is not required



Antenna	Side	Band	Channel	Power (dBm)	Frequency (GHz)	Distance (mm)	Power (mW)	Result	Limit	Exclusion Considerations SAR ¹⁹
Antenna 1 (WLAN)	3	IEEE 802.11b	1	17.0	2.412	29	50	2.7	3	SAR is not required
		IEEE 802.11a	36	11.5	5.180	29	14	1.1	3	SAR is not required
		IEEE 802.11a	44	11.5	5.220	29	14	1.1	3	SAR is not required
		IEEE 802.11a	149	11.5	5.745	29	14	1.2	3	SAR is not required
		IEEE 802.11a	157	11.5	5.785	29	14	1.2	3	SAR is not required
MIMO		IEEE 802.11n 20 (5GHz)	44	12.5	5.220	29	18	1.4	3	SAR is not required
		IEEE 802.11n 20 (5GHz)	48	12.5	5.240	29	18	1.4	3	SAR is not required
		IEEE 802.11n 20 (5GHz)	157	12.5	5.785	29	18	1.5	3	SAR is not required
		IEEE 802.11n 20 (5GHz)	161	12.5	5.805	29	18	1.5	3	SAR is not required
Antenna 1 (WLAN)		5	IEEE 802.11b	1	17.0	2.412	22	50	3.5	3
	IEEE 802.11a		36	11.5	5.180	22	14	1.4	3	SAR is not required
	IEEE 802.11a		44	11.5	5.220	22	14	1.5	3	SAR is not required
	IEEE 802.11a		149	11.5	5.745	22	14	1.5	3	SAR is not required
	IEEE 802.11a		157	11.5	5.785	22	14	1.5	3	SAR is not required
MIMO	IEEE 802.11n 20 (5GHz)		44	12.5	5.220	22	18	1.9	3	SAR is not required
	IEEE 802.11n 20 (5GHz)		48	12.5	5.240	22	18	1.9	3	SAR is not required
	IEEE 802.11n 20 (5GHz)		157	12.5	5.785	22	18	2.0	3	SAR is not required
	IEEE 802.11n 20 (5GHz)		161	12.5	5.805	22	18	2.0	3	SAR is not required
Antenna 2 (WLAN & Bluetooth)	6	IEEE 802.11b	6	17.0	2.437	14	50	5.6	3	SAR is required
		IEEE 802.11a	36	12.0	5.180	14	16	2.6	3	SAR is not required
		IEEE 802.11a	40	12.0	5.200	14	16	2.6	3	SAR is not required
		IEEE 802.11a	157	12.0	5.785	14	16	2.7	3	SAR is not required
		IEEE 802.11a	161	12.0	5.805	14	16	2.8	3	SAR is not required
		Bluetooth v3.0	78	7.0	2.480	14	5	0.6	3	SAR is not required
Bluetooth v4.0 LE		39	5.0	2.480	14	3	0.3	3	SAR is not required	
MIMO		IEEE 802.11n 20 (5GHz)	44	12.5	5.220	14	18	2.9	3	SAR is not required
		IEEE 802.11n 20 (5GHz)	48	12.5	5.240	14	18	2.9	3	SAR is not required
		IEEE 802.11n 20 (5GHz)	157	12.5	5.785	14	18	3.1	3	SAR is required
	IEEE 802.11n 20 (5GHz)	161	12.5	5.805	14	18	3.1	3	SAR is required	



> 50 mm <200mm

Antenna	Side	Band	Channel	Power (dBm)	Frequency (GHz)	Distance (mm)	Power (mW)	Power Thresholds SAR ¹⁹ (mW)	Exclusion Considerations SAR ¹⁹
Antenna 2 (WLAN & Bluetooth)	3	IEEE 802.11b	6	17.0	2.437	108	50	676	SAR is not required
		IEEE 802.11a	36	12.0	5.180	108	16	646	SAR is not required
		IEEE 802.11a	40	12.0	5.200	108	16	646	SAR is not required
		IEEE 802.11a	157	12.0	5.785	108	16	642	SAR is not required
		IEEE 802.11a	161	12.0	5.805	108	16	642	SAR is not required
		Bluetooth v3.0	78	7.0	2.480	108	5	675	SAR is not required
MIMO	3	Bluetooth v4.0 LE	39	5.0	2.480	108	3	675	SAR is not required
		IEEE 802.11n 20 (5GHz)	44	12.5	5.220	108	18	646	SAR is not required
		IEEE 802.11n 20 (5GHz)	48	12.5	5.240	108	18	646	SAR is not required
		IEEE 802.11n 20 (5GHz)	157	12.5	5.785	108	18	642	SAR is not required
Antenna 1 (WLAN)	4	IEEE 802.11n 20 (5GHz)	161	12.5	5.805	108	18	642	SAR is not required
		IEEE 802.11b	1	17.0	2.412	190	50	1497	SAR is not required
		IEEE 802.11a	36	11.5	5.180	190	14	1466	SAR is not required
		IEEE 802.11a	44	11.5	5.220	190	14	1466	SAR is not required
		IEEE 802.11a	149	11.5	5.745	190	14	1463	SAR is not required
Antenna 2 (WLAN & Bluetooth)	4	IEEE 802.11a	157	11.5	5.785	190	14	1462	SAR is not required
		IEEE 802.11b	6	17.0	2.437	114	50	736	SAR is not required
		IEEE 802.11a	36	12.0	5.180	114	16	706	SAR is not required
		IEEE 802.11a	40	12.0	5.200	114	16	706	SAR is not required
		IEEE 802.11a	157	12.0	5.785	114	16	702	SAR is not required
		IEEE 802.11a	161	12.0	5.805	114	16	702	SAR is not required
		Bluetooth v3.0	78	7.0	2.480	114	5	735	SAR is not required
MIMO	4	Bluetooth v4.0 LE	39	5.0	2.480	114	3	735	SAR is not required
		IEEE 802.11n 20 (5GHz)	44	12.5	5.220	114	18	706	SAR is not required
		IEEE 802.11n 20 (5GHz)	48	12.5	5.240	114	18	706	SAR is not required
		IEEE 802.11n 20 (5GHz)	157	12.5	5.785	114	18	702	SAR is not required
IEEE 802.11n 20 (5GHz)	161	12.5	5.805	114	18	702	SAR is not required		



5.6 Simultaneous Transmitting Evaluate

Simultaneous transmission configurations as below:

Condition	Side	Frequency Band	
		Antenna 1 (WLAN)	Antenna 2 (WLAN & Bluetooth)
1	1	V	V
2	2	V	V
3	3	V	V
4	4	V	V
5	5	V	V
6	6	V	V

5.6.1 Estimated SAR

Estimated SAR for test separation distances ≤ 50 mm

Antenna	Side	Band	Channel	Power-Tune up (dBm)	Frequency (GHz)	Distance (mm)	Power (mW)	Estimated SAR ¹⁹ (W/Kg)
Antenna 1	1	IEEE 802.11b	1	17.0	2.412	26	50	0.398
		IEEE 802.11a	36	11.5	5.180	26	14	0.163
		IEEE 802.11a	44	11.5	5.220	26	14	0.164
		IEEE 802.11a	149	11.5	5.745	26	14	0.172
		IEEE 802.11a	157	11.5	5.785	26	14	0.173
Antenna 2 (WLAN & Bluetooth)	1	Bluetooth v3.0	78	7.0	2.480	5	5	0.210
		Bluetooth v4.0 LE	39	5.0	2.480	5	3	0.126
Antenna 2 (WLAN & Bluetooth)	2	IEEE 802.11b	6	17.0	2.437	42	50	0.248
		IEEE 802.11a	36	12.0	5.180	42	16	0.116
		IEEE 802.11a	40	12.0	5.200	42	16	0.116
		IEEE 802.11a	157	12.0	5.785	42	16	0.122
		IEEE 802.11a	161	12.0	5.805	42	16	0.122
		Bluetooth v3.0	78	7.0	2.480	42	5	0.025
		Bluetooth v4.0 LE	39	5.0	2.480	42	3	0.015

Estimated SAR for test separation distances > 50 mm

Phanton Position		Band	Channel	Estimated SAR ^{1g} (W/Kg)
Antenna 2 (WLAN & Bluetooth)	5	IEEE 802.11b	6	0.4
		IEEE 802.11a	36	0.4
		IEEE 802.11a	40	0.4
		IEEE 802.11a	157	0.4
		IEEE 802.11a	161	0.4
		Bluetooth v3.0	78	0.4
		Bluetooth v4.0 LE	39	0.4
Antenna 1 (WLAN)	6	IEEE 802.11b	1	0.4
		IEEE 802.11a	36	0.4
		IEEE 802.11a	44	0.4
		IEEE 802.11a	149	0.4
		IEEE 802.11a	157	0.4
Antenna 2 (WLAN & Bluetooth)		Bluetooth v3.0	78	0.4
		Bluetooth v4.0 LE	39	0.4

5.6.2 Sum of 1-g SAR of all simultaneously transmitting

When the sum of 1-g SAR of all simultaneously transmitting antennas in and operating mode and exposure condition combination is within the SAR limit, SAR test exclusion applies to that simultaneous transmission configuration.

Sum of 1-g SAR of summary as below:

Phantom Position	Spacing (mm)	ASSY	Wi-Fi Antenna 1		Wi-Fi Antenna 2		MIMO		Bluetooth		Σ SAR ^{1g} (W/Kg)	Event	
			Band	SAR ^{1g} (W/Kg)	Band	SAR ^{1g} (W/Kg)	Band	SAR ^{1g} (W/Kg)	Band	SAR ^{1g} (W/Kg)			
Flat	Side 1	0	N/A	WLAN	*0.398	WLAN	0.504	WLAN	---	Bluetooth	*0.21	1.112	<1.6
		0	N/A	WLAN	---	WLAN	---	WLAN	0.476	Bluetooth	*0.21	0.686	<1.6
Flat	Side 2	0	N/A	WLAN	0.448	WLAN	*0.248	WLAN	---	Bluetooth	*0.025	0.721	<1.6
	Side 5	0	N/A	WLAN	0.113	WLAN	**0.4	WLAN	---	Bluetooth	**0.4	0.913	<1.6
	Side 6	0	N/A	WLAN	**0.4	WLAN	0.461	WLAN	---	Bluetooth	**0.4	1.261	<1.6
		0	N/A	WLAN	---	WLAN	---	WLAN	0.065	Bluetooth	**0.4	0.465	<1.6

*=Estimated SAR

**The Estimated SAR 0.4W/Kg for 1g SAR when the Antenna2 (Bluetooth) for side 5.6 test separation distances is > 50 mm.

Note 1: The device LCD (side1) can not rotation, but the user's hand can touch the antenna 2. Therefore the device is required to test side1.

Note 2: The test results meet the body and limbs SAR limit.



5.6.3 SAR to peak location separation ratio (SPLSR)

When the sum of SAR is larger than the limit, SAR test exclusion is determined by the SAR to peak location separation ratio. The ratio is determined by $(SAR1 + SAR2)^{1.5}/R_i$, rounded to two decimal digits, and must be ≤ 0.04 for all antenna pairs in the configuration to qualify for 1-g SAR test exclusion.

All of sum of SAR < 1.6 W/Kg, therefore SPLSR is not required.

5.7 SAR test reduction according to KDB

General:

- The test data reported are the worst-case SAR value with the position set in a typical configuration. Test procedures used were according to FCC, Supplement C [June 2001], IEEE1528-2013 and IEEE Std. 1528a-2005.
- All modes of operation were investigated, and worst-case results are reported.
- Tissue parameters and temperatures are listed on the SAR plots.
- Batteries are fully charged for all readings.
- When the Channel's SAR 1g of maximum conducted power is > 0.8 mW/g, low, middle and high channel are supposed to be tested.

KDB 447498:

- The test data reported are the worst-case SAR value with the position set in a typical configuration. Test procedures used were according to IEEE1528-2013 and IEEE Std. 1528a-2005.

KDB 865664:

- Repeated measurement is not required when the original highest measured SAR is < 0.80 W/kg.
- When the original highest measured SAR is ≥ 0.80 W/kg, repeat that measurement once.
- Perform a second repeated measurement only if the ratio of largest to smallest SAR for the original and first repeated measurements is > 1.20 or when the original or repeated measurement is ≥ 1.45 W/kg.
- Perform a third repeated measurement only if the original, first or second repeated measurement is ≥ 1.5 W/kg and the ratio of largest to smallest SAR for the original, first and second repeated measurements is > 1.20.

KDB 248227:

- If the conducted power of (802.11g and 802.11n) are higher than 802.11b 0.25dB,(802.11g and 802.11n) are supposed to be tested.

6. System Verification and Validation

6.1 Symmetric Dipoles for System Verification

Construction	Symmetrical dipole with 1/4 balun enables measurement of feed point impedance with NWA matched for use near flat phantoms filled with head simulating solutions Includes distance holder and tripod adaptor Calibration Calibrated SAR value for specified position and input power at the flat phantom in head simulating solutions.
Frequency	2450, 5200 and 5800 MHz
Return Loss	> 20 dB at specified verification position
Power Capability	> 100 W (f < 1GHz); > 40 W (f > 1GHz)
Options	Dipoles for other frequencies or solutions and other calibration conditions are available upon request
Dimensions	D2450V2: dipole length 51.5 mm; overall height 300 mm D5GHzV2: dipole length 20.6 mm; overall height 300 mm

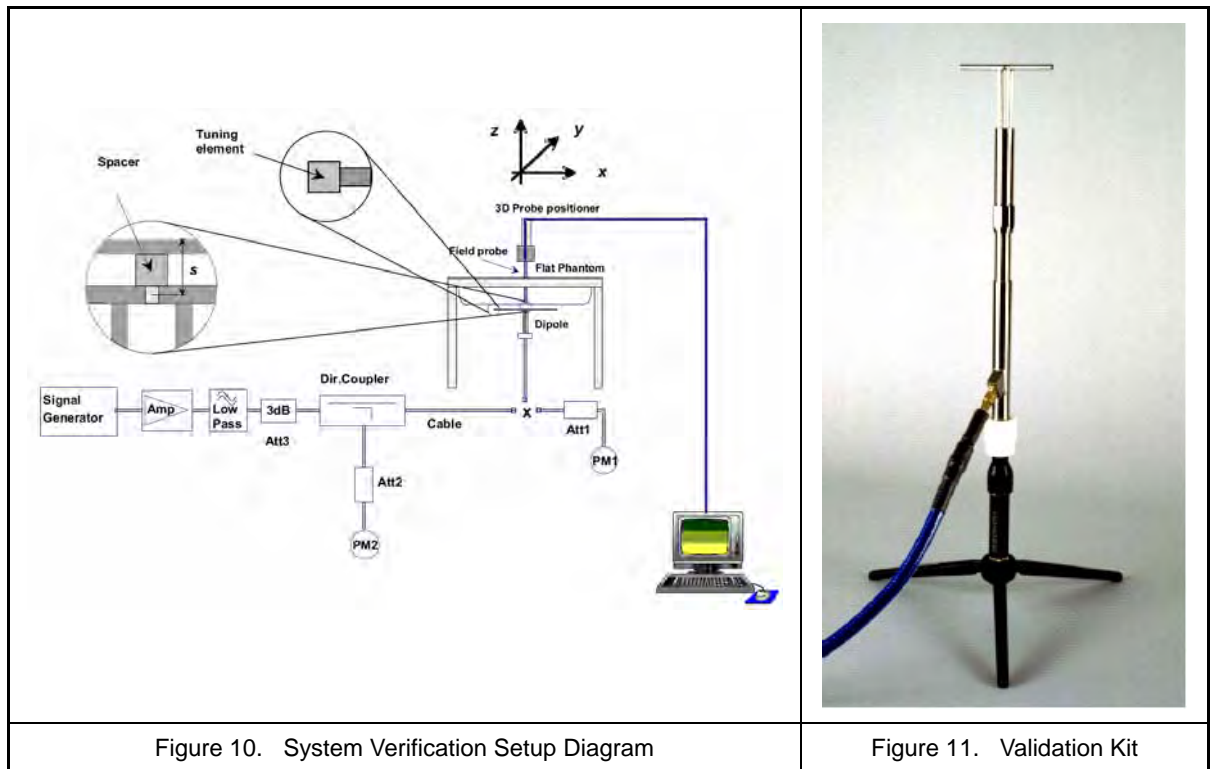

Figure 10. System Verification Setup Diagram

Figure 11. Validation Kit



6.2 Liquid Parameters

Liquid Verify								
Ambient Temperature : 22 ± 2 °C ; Relative Humidity : 40 -70%								
Liquid Type	Frequency	Temp (°C)	Parameters	Target Value	Measured Value	Deviation (%)	Limit (%)	Measured Date
2450MHz (Body)	2400MHz	22.0	ϵ_r	52.77	54.02	2.37%	± 5	2014/08/13
			σ	1.902	1.881	-1.10%	± 5	
	2450MHz	22.0	ϵ_r	52.70	54.46	3.34%	± 5	
			σ	1.950	1.980	1.54%	± 5	
	2500MHz	22.0	ϵ_r	52.64	53.61	1.84%	± 5	
			σ	2.021	2.016	-0.25%	± 5	
2450MHz (Body)	2400MHz	22.0	ϵ_r	52.77	54.02	2.37%	± 5	2014/08/28
			σ	1.902	1.881	-1.10%	± 5	
	2450MHz	22.0	ϵ_r	52.70	54.46	3.34%	± 5	
			σ	1.950	1.980	1.54%	± 5	
	2500MHz	22.0	ϵ_r	52.64	53.61	1.84%	± 5	
			σ	2.021	2.016	-0.25%	± 5	
5200MHz (Body)	5150MHz	22.0	ϵ_r	49.08	47.89	-2.43%	± 5	2014/08/28
			σ	5.241	5.460	4.18%	± 5	
	5200MHz	22.0	ϵ_r	49.01	47.76	-2.55%	± 5	
			σ	5.299	5.520	4.17%	± 5	
	5250MHz	22.0	ϵ_r	48.95	47.63	-2.70%	± 5	
			σ	5.358	5.550	3.58%	± 5	
5800MHz (Body)	5750MHz	22.0	ϵ_r	48.27	46.54	-3.58%	± 5	2014/08/28
			σ	5.942	6.210	4.51%	± 5	
	5800MHz	22.0	ϵ_r	48.20	46.40	-3.73%	± 5	
			σ	6.000	6.270	4.50%	± 5	
	5850MHz	22.0	ϵ_r	48.20	46.35	-3.84%	± 5	
			σ	6.000	6.290	4.83%	± 5	

Table 4. Measured Tissue dielectric parameters for body phantoms -1



6.3 Verification Summary

Prior to the assessment, the system validation kit was used to test whether the system was operating within its specifications of $\pm 7\%$. The verification was performed at 2450, 5200 and 5800MHz.

Mixture Type	Frequency (MHz)	Power	SAR _{1g} (W/Kg)	SAR _{10g} (W/Kg)	Drift (dB)	Difference percentage		Probe Model / Serial No.	Dipole Model / Serial No.	1W Target		Date
						1g	10g			SAR _{1g} (W/Kg)	SAR _{10g} (W/Kg)	
Body	2450	250 mW	12.80	5.97	-0.17	1.80%	1.60%	50.30	23.50	-0.17	1.80%	Aug. 13, 2014
		Normalize to 1 Watt	51.20	23.88								
Body	2450	250 mW	12.90	5.98	-0.13	2.60%	1.80%	50.30	23.50	-0.13	2.60%	Aug. 28, 2014
		Normalize to 1 Watt	51.60	23.92								
Body	5200	100 mW	7.39	2.05	-0.12	-0.30%	-0.50%	74.10	20.60	-0.12	-0.30%	Aug. 28, 2014
		Normalize to 1 Watt	73.90	20.50								
Body	5800	100 mW	7.76	2.12	-0.17	4.70%	3.90%	74.10	20.40	-0.17	4.70%	Aug. 28, 2014
		Normalize to 1 Watt	77.60	21.20								

6.4 Validation Summary

Per FCC KDB 865664 D02v01, SAR system validation status should be documented to confirm measurement accuracy. The SAR systems (including SAR probes, system components and software versions) used for this device were validated against its performance specifications prior to the SAR measurements. Reference dipoles were used with the required tissue- equivalent media for system validation, according to the procedures outlined in IEEE 1528-2013 and FCC KDB 865664 D01v01r03. Since SAR probe calibrations are frequency dependent, each probe calibration point was validated at a frequency within the valid frequency range of the probe calibration point, using the system that normally operates with the probe for routine SAR measurements and according to the required tissue-equivalent media.

A tabulated summary of the system validation status including the validation date(s), measurement frequencies, SAR probes and tissue dielectric parameters as below.

Probe Type Model / Serial No.	Prob Cal. Point (MHz)	Head / Body	Cond. ϵ_r	Perm. σ	CW Validation			Mod. Validation			Date
					Sensitivity	Probe	Probe	Mod. Type	Duty Factor	PAR	
			Linearity	Isotropy							
EX3DV4 SN:3977	2450	Body	54.46	1.980	Pass	Pass	Pass	OFDM	N/A	Pass	Aug. 13, 2013
EX3DV4 SN:3977	2450	Body	54.46	1.980	Pass	Pass	Pass	OFDM	N/A	Pass	Aug. 28, 2013
EX3DV4 SN:3977	5200	Body	47.76	5.520	Pass	Pass	Pass	OFDM	N/A	Pass	Aug. 28, 2013
EX3DV4 SN:3977	5800	Body	46.40	6.270	Pass	Pass	Pass	OFDM	N/A	Pass	Aug. 28, 2013



7. Test Equipment List

Manufacturer	Name of Equipment	Type/Model	Serial Number	Calibration	
				Last Cal.	Due Date
SPEAG	2450MHz System Validation Kit	D2450V2	712	Mar. 04, 2014	Mar. 04, 2015
SPEAG	5GHz System Validation Kit	D5GHZV2	1021	Feb. 28, 2014	Feb. 28, 2015
SPEAG	Dosimetric E-Field Probe	EX3DV4	3977	Feb. 17, 2014	Feb. 17, 2015
SPEAG	Data Acquisition Electronics	DAE4	779	Feb. 25, 2014	Feb. 25, 2015
SPEAG	Device Holder	N/A	N/A	NCR	
SPEAG	Measurement Server	SE UMS 011 AA	1025	NCR	
SPEAG	Phantom	ELI V5.0	TP-1133	NCR	
SPEAG	Robot	Staubli TX90XL	F07/564ZA1/C/01	NCR	
SPEAG	Software	DASY52 V52.8 (7)	N/A	NCR	
SPEAG	Software	SEMCAD X V14.6.10 (7164)	N/A	NCR	
Agilent	Dielectric Probe Kit	85070C	US99360094	NCR	
Agilent	ENA Series Network Analyzer	E5071B	MY42404655	Apr. 10, 2014	Apr. 10, 2015
R&S	Power Sensor	NRP-Z22	100179	May 20, 2014	May 20, 2015
Agilent	MXF-G-B RF Vector Signal Generator	N5182B	MY53050382	May 30, 2014	May 30, 2015
Agilent	Dual Directional Coupler	778D	50334	NCR	
Mini-Circuits	Power Amplifier	ZHL-42W-SMA	D111103#5	NCR	
Mini-Circuits	Power Amplifier	ZVE-8G-SMA	D042005 671800514	NCR	
Aisi	Attenuator	IEAT 3dB	N/A	NCR	

Table 5. Test Equipment List



8. Measurement Uncertainty

Measurement uncertainties in SAR measurements are difficult to quantify due to several variables including biological, physiological, and environmental. However, we estimate the measurement uncertainties in SAR to be less than $\pm 19.62\%$ [8] . The frequency range of the measurement uncertainty is 750 ~ 5800MHz $\pm 10.1\%$

According to Std. C95.3 [9] , the overall uncertainties are difficult to assess and will vary with the type of meter and usage situation. However, accuracy's of ± 1 to 3 dB can be expected in practice, with greater uncertainties in near-field situations and at higher frequencies (shorter wavelengths), or areas where large reflecting objects are present. Under optimum measurement conditions, SAR measurement uncertainties of at least ± 2 dB can be expected.



Item	Uncertainty Component	Uncertainty Value	Prob. Dist	Div.	c_i (1g)	c_i (10g)	Std. Unc. (1-g)	Std. Unc. (10-g)	v_i or V_{eff}
Measurement System									
u1	Probe Calibration ($k=1$)	$\pm 5.05\%$	Normal	1	1	1	$\pm 5.05\%$	$\pm 5.05\%$	∞
u2	Probe Isotropy	$\pm 7.6\%$	Rectangular	$\sqrt{3}$	0.7	0.7	$\pm 3.1\%$	$\pm 3.1\%$	∞
u3	Boundary Effect	$\pm 1.0\%$	Rectangular	$\sqrt{3}$	1	1	$\pm 0.6\%$	$\pm 0.6\%$	∞
u4	Linearity	$\pm 4.7\%$	Rectangular	$\sqrt{3}$	1	1	$\pm 2.7\%$	$\pm 2.7\%$	∞
u5	System Detection Limit	$\pm 1.0\%$	Rectangular	$\sqrt{3}$	1	1	$\pm 0.58\%$	$\pm 0.58\%$	∞
u6	Readout Electronics	$\pm 0.3\%$	Normal	1	1	1	$\pm 0.3\%$	$\pm 0.3\%$	∞
u7	Response Time	$\pm 0.8\%$	Rectangular	$\sqrt{3}$	1	1	$\pm 0.5\%$	$\pm 0.5\%$	∞
u8	Integration Time	$\pm 2.6\%$	Rectangular	$\sqrt{3}$	1	1	$\pm 1.5\%$	$\pm 1.5\%$	∞
u9	RF Ambient Conditions	$\pm 0\%$	Rectangular	$\sqrt{3}$	1	1	$\pm 0\%$	$\pm 0\%$	∞
u10	RF Ambient Reflections	$\pm 0\%$	Rectangular	$\sqrt{3}$	1	1	$\pm 0\%$	$\pm 0\%$	∞
u11	Probe Positioner Mechanical Tolerance	$\pm 0.4\%$	Rectangular	$\sqrt{3}$	1	1	$\pm 0.2\%$	$\pm 0.2\%$	∞
u12	Probe Positioning with respect to Phantom Shell	$\pm 2.9\%$	Rectangular	$\sqrt{3}$	1	1	$\pm 1.7\%$	$\pm 1.7\%$	∞
u13	Extrapolation, interpolation and integration Algorithms for Max. SAR Evaluation	$\pm 1.0\%$	Rectangular	$\sqrt{3}$	1	1	$\pm 0.6\%$	$\pm 0.6\%$	∞
Test sample Related									
u14	Test sample Positioning	$\pm 3.6\%$	Normal	1	1	1	$\pm 3.6\%$	$\pm 3.6\%$	89
u15	Device Holder Uncertainty	$\pm 3.5\%$	Normal	1	1	1	$\pm 3.5\%$	$\pm 3.5\%$	5
u16	Output Power Variation - SAR drift measurement	$\pm 5.0\%$	Rectangular	$\sqrt{3}$	1	1	$\pm 2.9\%$	$\pm 2.9\%$	∞
Phantom and Tissue Parameters									
u17	Phantom Uncertainty (shape and thickness tolerances)	$\pm 4.0\%$	Rectangular	$\sqrt{3}$	1	1	$\pm 2.3\%$	$\pm 2.3\%$	∞
u18	Liquid Conductivity - deviation from target values	$\pm 5.0\%$	Rectangular	$\sqrt{3}$	0.64	0.43	$\pm 1.8\%$	$\pm 1.2\%$	∞
u19	Liquid Conductivity - measurement uncertainty	$\pm 1.93\%$	Normal	1	0.64	0.43	$\pm 1.24\%$	$\pm 0.83\%$	69
u20	Liquid Permittivity - deviation from target values	$\pm 5.0\%$	Rectangular	$\sqrt{3}$	0.6	0.49	$\pm 1.7\%$	$\pm 1.4\%$	∞
u21	Liquid Permittivity - measurement uncertainty	$\pm 1.4\%$	Normal	1	0.6	0.49	$\pm 0.84\%$	$\pm 1.69\%$	69
Combined standard uncertainty			RSS				$\pm 9.81\%$	$\pm 9.62\%$	313
Expanded uncertainty (95% CONFIDENCE LEVEL)			$k=2$				$\pm 19.62\%$	$\pm 19.24\%$	

Table 6. Uncertainty Budget of DASYS



9. **Measurement Procedure**

The measurement procedures are as follows:

1. For WLAN function, engineering testing software installed on Notebook can provide continuous transmitting signal.
2. Measure output power through RF cable and power meter
3. Set scan area, grid size and other setting on the DASY software
4. Find out the largest SAR result on these testing positions of each band
5. Measure SAR results for other channels in worst SAR testing position if the SAR of highest power channel is larger than 0.8 W/kg

According to the test standard, the recommended procedure for assessing the peak spatial-average SAR value consists of the following steps:

1. Power reference measurement
2. Area scan
3. Zoom scan
4. Power drift measurement

9.1 **Spatial Peak SAR Evaluation**

The procedure for spatial peak SAR evaluation has been implemented according to the test standard. It can be conducted for 1g and 10g, as well as for user-specific masses. The DASY software includes all numerical procedures necessary to evaluate the spatial peak SAR value.

The base for the evaluation is a "cube" measurement. The measured volume must include the 1g and 10g cubes with the highest averaged SAR values. For that purpose, the center of the measured volume is aligned to the interpolated peak SAR value of a previously performed area scan.

The entire evaluation of the spatial peak values is performed within the post-processing engine (SEMCAD). The system always gives the maximum values for the 1g and 10g cubes. The algorithm to find the cube with highest averaged SAR is divided into the following stages

1. Extraction of the measured data (grid and values) from the Zoom Scan
2. Calculation of the SAR value at every measurement point based on all stored data (A/D values and measurement parameters)
3. Generation of a high-resolution mesh within the measured volume
4. Interpolation of all measured values from the measurement grid to the high-resolution grid
5. Extrapolation of the entire 3-D field distribution to the phantom surface over the distance from sensor to surface
6. Calculation of the averaged SAR within masses of 1g and 10g



9.2 Area & Zoom Scan Procedures

First Area Scan is used to locate the approximate location(s) of the local peak SAR value(s). The measurement grid within an Area Scan is defined by the grid extent, grid step size and grid offset. Next, in order to determine the EM field distribution in a three-dimensional spatial extension, Zoom Scan is required. The Zoom Scan measures points and step size follow as below. The Zoom Scan is performed around the highest E-field value to determine the averaged SAR-distribution over 10 g.

Grid Type	Frequency		Step size (mm)			X*Y*Z (Point)	Cube size			Step size		
			X	Y	Z		X	Y	Z	X	Y	Z
uniform grid	≤ 3GHz	≤ 2GHz	≤ 8	≤ 8	≤ 5	5*5*7	32	32	30	8	8	5
		2G - 3G	≤ 5	≤ 5	≤ 5	7*7*7	30	30	30	5	5	5
	3 - 6GHz	3 - 4GHz	≤ 5	≤ 5	≤ 4	7*7*8	30	30	28	5	5	4
		4 - 5GHz	≤ 4	≤ 4	≤ 3	8*8*10	28	28	27	4	4	3
		5 - 6GHz	≤ 4	≤ 4	≤ 2	8*8*12	28	28	22	4	4	2

(Our measure settings are refer KDB Publication 865664 D01v01)

9.3 Volume Scan Procedures

The volume scan is used for assess overlapping SAR distributions for antennas transmitting in different frequency bands. It is equivalent to an oversized zoom scan used in standalone measurements. The measurement volume will be used to enclose all the simultaneous transmitting antennas. For antennas transmitting simultaneously in different frequency bands, the volume scan is measured separately in each frequency band. In order to sum correctly to compute the 1g aggregate SAR, the DUT remain in the same test position for all measurements and all volume scan use the same spatial resolution and grid spacing. When all volume scan were completed, the software, SEMCAD postprocessor can combine and subsequently superpose these measurement data to calculating the multiband SAR.

9.4 SAR Averaged Methods

In DASYS, the interpolation and extrapolation are both based on the modified Quadratic Shepard's method. The interpolation scheme combines a least-square fitted function method and a weighted average method which are the two basic types of computational interpolation and approximation. Extrapolation routines are used to obtain SAR values between the lowest measurement points and the inner phantom surface. The extrapolation distance is determined by the surface detection distance and the probe sensor offset. The uncertainty increases with the extrapolation distance. To keep the uncertainty within 1% for the 1 g and 10 g cubes, the extrapolation distance should not be larger than 5 mm.

9.5 Power Drift Monitoring

All SAR testing is under the DUT install full charged battery and transmit maximum output power. In DASYS measurement software, the power reference measurement and power drift measurement procedures are used for monitoring the power drift of DUT during SAR test. Both these procedures measure the field at a specified reference position before and after the SAR testing. The software will calculate the field difference in dB. If the power drift more than 5%, the SAR will be retested.



10. SAR Test Results Summary

10.1 Head Measurement SAR

Evaluated head SAR is not available.

10.2 Body Measurement SAR

Index	Position	Band	Ch.	Data Rate or Sub-Test	Side to Phantom	Spacing (mm)	Antenna	SAR _{1g} (W/Kg)	Power Drift	Burst Avg Power	Max tune-up	Reported SAR _{1g} (W/Kg)
#1	Flat	IEEE 802.11b	1	1M	2	0	Antenna 1	0.443	0.00	16.95	17.0	0.448
#2	Flat	IEEE 802.11b	1	1M	5	0	Antenna 1	0.112	-0.11	16.95	17.0	0.113
#3	Flat	IEEE 802.11b	6	1M	1	0	Antenna 2	0.385	0.18	16.98	17.0	0.387
#4	Flat	IEEE 802.11b	6	1M	6	0	Antenna 2	0.459	-0.18	16.98	17.0	0.461
#5	Flat	IEEE 802.11a	36	6M	1	0	Antenna 2	0.455	0.00	11.66	12.0	0.492
#6	Flat	IEEE 802.11a	40	6M	1	0	Antenna 2	0.464	0.00	11.64	12.0	0.504
#7	Flat	IEEE 802.11a	157	6M	1	0	Antenna 2	0.467	0.00	11.88	12.0	0.480
#8	Flat	IEEE 802.11a	161	6M	1	0	Antenna 2	0.453	0.00	11.81	12.0	0.473
#9	Flat	IEEE 802.11n 20 (5GHz)	44	13M	1	0	MIMO	0.154	0.00	11.52	12.5	0.193
#10	Flat	IEEE 802.11n 20 (5GHz)	48	13M	1	0	MIMO	0.173	0.00	11.46	12.5	0.220
#11	Flat	IEEE 802.11n 20 (5GHz)	157	13M	1	0	MIMO	0.441	0.00	12.25	12.5	0.467
#13	Flat	IEEE 802.11n 20 (5GHz)	157	13M	6	0	MIMO	0.056	0.00	12.25	12.5	0.059
#12	Flat	IEEE 802.11n 20 (5GHz)	161	13M	1	0	MIMO	0.413	0.00	11.88	12.5	0.476
#14	Flat	IEEE 802.11n 20 (5GHz)	161	13M	6	0	MIMO	0.056	0.00	11.88	12.5	0.065

- Note: 1. According KDB 447498 D01 V05r02 section 4.1.4, the "Reported" explanation as below:
 "When SAR or MPE is measured at or scaled to the maximum tune-up tolerance limit, the results are referred to as reported."
 2. The conducted power of (IEEE 802.11g / IEEE 802.11n) are not higher than IEEE 802.11b 0.25dB, (IEEE 802.11g / IEEE 802.11n) are not supposed to be tested.

10.3 Extremity Measurement SAR

Evaluated extremity SAR is not available.

10.4 SAR Measurement Variability

SAR Measurement Variability is not available.



10.5 Std. C95.1-1999 RF Exposure Limit

Human Exposure	Population Uncontrolled Exposure (W/kg) or (mW/g)	Occupational Controlled Exposure (W/kg) or (mW/g)
Spatial Peak SAR* (head)	1.60	8.00
Spatial Peak SAR** (Whole Body)	0.08	0.40
Spatial Peak SAR*** (Partial-Body)	1.60	8.00
Spatial Peak SAR**** (Hands / Feet / Ankle / Wrist)	4.00	20.00

Table 7. Safety Limits for Partial Body Exposure

Notes :

- * The Spatial Peak value of the SAR averaged over any 1 gram of tissue.
(defined as a tissue volume in the shape of a cube) and over the appropriate averaging time.
- ** The Spatial Average value of the SAR averaged over the whole – body.
- *** The Spatial Average value of the SAR averaged over the partial – body.
- **** The Spatial Peak value of the SAR averaged over any 10 grams of tissue.
(defined as a tissue volume in the shape of a cube) and over the appropriate averaging time.

Population / Uncontrolled Environments : are defined as locations where there is the exposure of individuals who have no knowledge or control of their exposure.

Occupational / Controlled Environments : are defined as locations where there is exposure that may be incurred by persons who are aware of the potential for exposure, (i.e. as a result of employment or occupation).



11. Conclusion

The SAR test values found for the portable mobile phone **MilDef Crete Inc. Trade Name : MilDef Crete Inc. Model(s) : DT10** is below the maximum recommended level of 1.6 W/kg (mW/g).

12. References

- [1] Std. C95.1-1999, "American National Standard safety levels with respect to human exposure to radio frequency electromagnetic fields, 300KHz to 100GHz", New York.
- [2] NCRP, National Council on Radiation Protection and Measurements, "Biological Effects and Exposure Criteria for Radio frequency Electromagnetic Fields", NCRP report NO. 86, 1986.
- [3] T. Schmid, O. Egger, and N. Kuster, "Automatic E-field scanning system for dosimetric assessments", IEEE Transactions on Microwave Theory and Techniques, vol. 44, pp, 105-113, Jan. 1996.
- [4] K. Pokovi^c, T. Schmid, and N. Kuster, "Robust setup for precise calibration of E-field probes in tissue simulating liquids at mobile communications frequency", in ICECOM'97, Dubrovnik, October 15-17, 1997, pp.120-124.
- [5] K. Pokovi^c, T. Schmid, and N. Kuster, "E-field probe with improved isotropy in brain simulating liquids", in Proceedings of the ELMAR, Zadar, Croatia, 23-25 June, 1996, pp.172-175.
- [6] N. Kuster, and Q. Balzano, "Energy absorption mechanism by biological bodies in the near field of dipole antennas above 300MHz", IEEE Transaction on Vehicular Technology, vol. 41, no. 1, Feb. 1992, pp. 17-23.
- [7] Robert J. Renka, "Multivariate Interpolation Of Large Sets Of Scattered Data", University of North Texas ACM Transactions on Mathematical Software, vol. 14, no. 2, June 1988 , pp. 139-148.
- [8] N. Kuster, R. Kastle, T. Schmid, Dosimetric evaluation of mobile communications equipment with known precision, IEEE Transaction on Communications, vol. E80-B, no. 5, May 1997, pp. 645-652.
- [9] Std. C95.3-1991, "IEEE Recommended Practice for the Measurement of Potentially Hazardous Electromagnetic Fields – RF and Microwave, New York: IEEE, Aug. 1992.
- [10] CENELEC CLC/SC111B, European Prestandard (prENV 50166-2), Human Exposure to Electromagnetic Fields High-frequency: 10KHz-300GHz, Jan. 1995.
- [11] IEEE Std 1528™-2013 - IEEE Recommended Practice for Determining the Peak Spatial-Average Specific Absorption Rate (SAR) in the Human Head From Wireless Communications Devices: Measurement Techniques
- [12] IEEE Std 1528a™-2005 (Amendment to IEEE Std 1528™-2013), IEEE Recommended Practice for Determining the Peak Spatial-Average Specific Absorption Rate (SAR) in the Human Head from Wireless Communications Devices: Measurement Techniques

13. SAR Measurement Guidance

- [1] KDB 865664 D01 SAR measurement 100 MHz to 6 GHz v01r03
- [2] KDB 447498 D01 General RF Exposure Guidance v05r02
- [3] KDB 248227 D01 SAR meas for 802 11 a b g v01r02.



Appendix A - System Performance Check

Test Laboratory: A Test Lab Techno Corp.

Date: 2014/8/13 Time: PM 07:02:16

System Performance Check at 2450MHz_20140813_Body

DUT: Dipole 2450 MHz; Type: D2450V2; Serial: D2450V2 - SN:712

Communication System: UID 0, CW (0); Frequency: 2450 MHz; Duty Cycle: 1:1

Medium parameters used: $f = 2450$ MHz; $\sigma = 1.98$ S/m; $\epsilon_r = 54.458$; $\rho = 1000$ kg/m³

Phantom section: Flat Section

Measurement Standard: DASYS5 (IEEE/IEC/ANSI C63.19-2011)

DASY Configuration:

- Area Scan setting - Find Secondary Maximum Within: 2.0dB and with a peak SAR value greater than 0.5 W/Kg
- Probe: EX3DV4 - SN3977; ConvF(6.97, 6.97, 6.97); Calibrated: 2014/2/17;
- Sensor-Surface: 2mm (Mechanical Surface Detection)
- Electronics: DAE4 Sn779; Calibrated: 2014/2/25
- Phantom: ELI v5.0; Type: QDOVA002AA; Serial: TP:1133
- Measurement SW: DASYS52, Version 52.8 (7); SEMCAD X Version 14.6.10 (7164)

System Performance Check at 2450MHz/Area Scan (61x61x1):

Interpolated grid: $dx=1.500$ mm, $dy=1.500$ mm

Maximum value of SAR (interpolated) = 18.7 W/kg

System Performance Check at 2450MHz/Zoom Scan (7x7x7)/Cube 0:

Measurement grid: $dx=5$ mm, $dy=5$ mm, $dz=5$ mm

Reference Value = 66.879 V/m; Power Drift = -0.17 dB

Peak SAR (extrapolated) = 26.4 W/kg

SAR(1 g) = 12.8 W/kg; SAR(10 g) = 5.97 W/kg

Maximum value of SAR (measured) = 19.5 W/kg

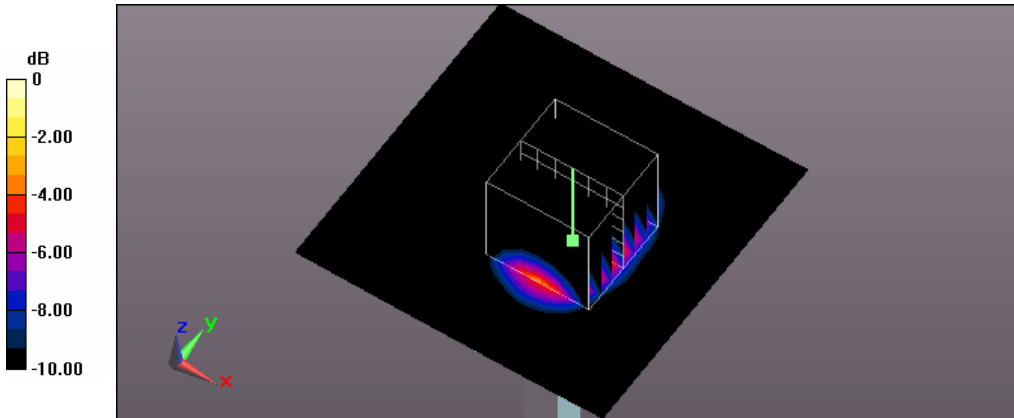

0 dB = 19.5 W/kg = 12.90 dBW/kg

Test Laboratory: A Test Lab Techno Corp.
 Date: 2014/8/28 Time: AM 12:22:47

System Performance Check at 2450MHz_20140828_Body

DUT: Dipole 2450 MHz; Type: D2450V2; Serial: D2450V2 - SN:712

Communication System: UID 0, CW (0); Frequency: 2450 MHz; Duty Cycle: 1:1

Medium parameters used: $f = 2450 \text{ MHz}$; $\sigma = 1.98 \text{ S/m}$; $\epsilon_r = 54.458$; $\rho = 1000 \text{ kg/m}^3$

Phantom section: Flat Section

Measurement Standard: DASY5 (IEEE/IEC/ANSI C63.19-2011)

DASY Configuration:

- Area Scan setting - Find Secondary Maximum Within: 2.0dB and with a peak SAR value greater than 0.5 W/Kg
- Probe: EX3DV4 - SN3977; ConvF(6.97, 6.97, 6.97); Calibrated: 2014/2/17;
- Sensor-Surface: 2mm (Mechanical Surface Detection)
- Electronics: DAE4 Sn779; Calibrated: 2014/2/25
- Phantom: ELI v5.0; Type: QDOVA002AA; Serial: TP:1133
- Measurement SW: DASY52, Version 52.8 (7); SEMCAD X Version 14.6.10 (7164)

System Performance Check at 2450MHz/Area Scan (61x61x1):

Interpolated grid: $dx=1.500 \text{ mm}$, $dy=1.500 \text{ mm}$

Maximum value of SAR (interpolated) = 19.2 W/kg

System Performance Check at 2450MHz/Zoom Scan (7x7x7)/Cube 0:

Measurement grid: $dx=5\text{mm}$, $dy=5\text{mm}$, $dz=5\text{mm}$

Reference Value = 58.226 V/m; Power Drift = -0.13 dB

Peak SAR (extrapolated) = 26.6 W/kg

SAR(1 g) = 12.9 W/kg; SAR(10 g) = 5.98 W/kg

Maximum value of SAR (measured) = 19.6 W/kg

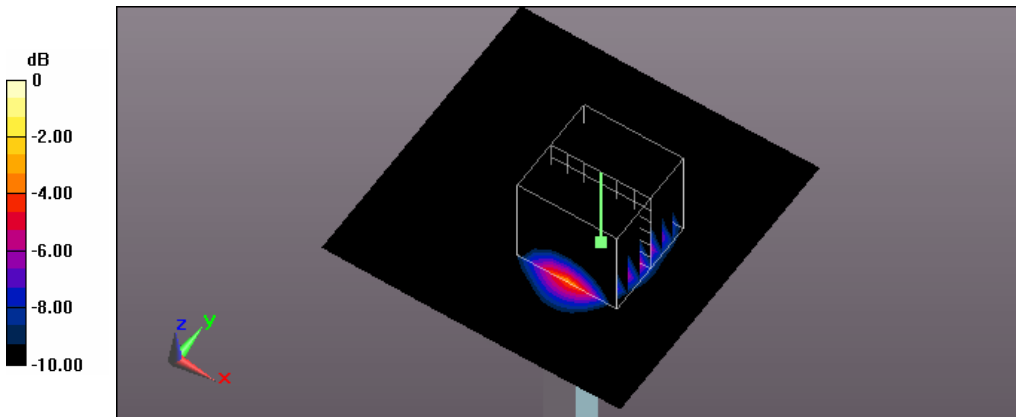

0 dB = 19.6 W/kg = 12.92 dBW/kg

Test Laboratory: A Test Lab Techno Corp.
 Date: 2014/8/28 Time: AM 03:18:52

System Performance Check at 5200MHz_20140828_Body

DUT: Dipole 5GHzV2; Type: D5GHz; Serial: 1021

Communication System: UID 0, CW (0); Frequency: 5200 MHz; Duty Cycle: 1:1

Medium parameters used: $f = 5200$ MHz; $\sigma = 5.52$ S/m; $\epsilon_r = 47.76$; $\rho = 1000$ kg/m³

Phantom section: Flat Section

Measurement Standard: DASYS (IEEE/IEC/ANSI C63.19-2011)

DASY Configuration:

- Area Scan setting - Find Secondary Maximum Within: 2.0dB and with a peak SAR value greater than 0.5 W/Kg
- Probe: EX3DV4 - SN3977; ConvF(4.5, 4.5, 4.5); Calibrated: 2014/2/17;
- Sensor-Surface: 1.4mm (Mechanical Surface Detection)
- Electronics: DAE4 Sn779; Calibrated: 2014/2/25
- Phantom: ELI v5.0; Type: QDOVA002AA; Serial: TP:1133
- Measurement SW: DASYS2, Version 52.8 (7); SEMCAD X Version 14.6.10 (7164)

System Performance Check at 5200MHz/Area Scan (91x91x1):

Interpolated grid: $dx=1.000$ mm, $dy=1.000$ mm

Maximum value of SAR (interpolated) = 18.1 W/kg

System Performance Check at 5200MHz/Zoom Scan (8x8x7)/Cube 0:

Measurement grid: $dx=4$ mm, $dy=4$ mm, $dz=1.4$ mm

Reference Value = 23.532 V/m; Power Drift = -0.12 dB

Peak SAR (extrapolated) = 32.0 W/kg

SAR(1 g) = 7.39 W/kg; SAR(10 g) = 2.05 W/kg

Maximum value of SAR (measured) = 17.9 W/kg

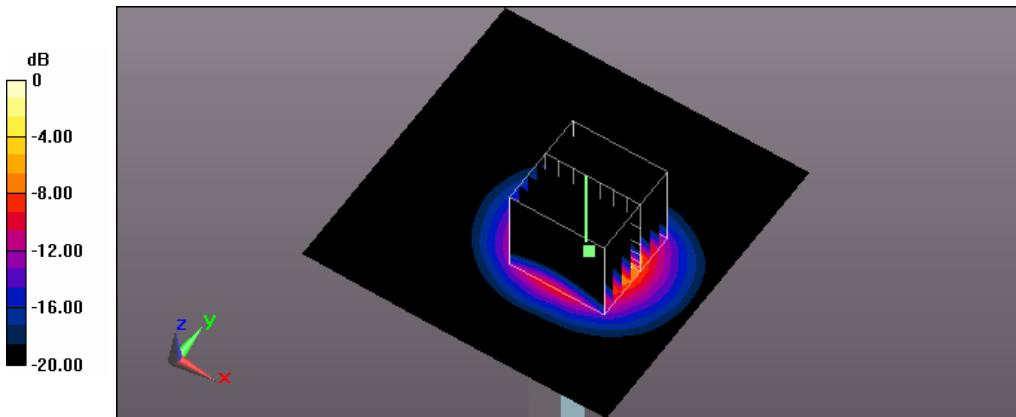

0 dB = 17.9 W/kg = 12.53 dBW/kg

Test Laboratory: A Test Lab Techno Corp.

Date: 2014/8/28 Time: AM 03:54:02

System Performance Check at 5800MHz_20140828_Body

DUT: Dipole 5GHzV2; Type: D5GHz; Serial: 1021

Communication System: UID 0, CW (0); Frequency: 5800 MHz; Duty Cycle: 1:1

Medium parameters used: $f = 5800 \text{ MHz}$; $\sigma = 6.27 \text{ S/m}$; $\epsilon_r = 46.4$; $\rho = 1000 \text{ kg/m}^3$

Phantom section: Flat Section

Measurement Standard: DASYS (IEEE/IEC/ANSI C63.19-2011)

DASY Configuration:

- Area Scan setting - Find Secondary Maximum Within: 2.0dB and with a peak SAR value greater than 0.5 W/Kg
- Probe: EX3DV4 - SN3977; ConvF(4.12, 4.12, 4.12); Calibrated: 2014/2/17;
- Sensor-Surface: 1.4mm (Mechanical Surface Detection)
- Electronics: DAE4 Sn779; Calibrated: 2014/2/25
- Phantom: ELI v5.0; Type: QDOVA002AA; Serial: TP:1133
- Measurement SW: DASYS2, Version 52.8 (7); SEMCAD X Version 14.6.10 (7164)

System Performance Check at 5800MHz/Area Scan (91x91x1):

Interpolated grid: $dx=1.000 \text{ mm}$, $dy=1.000 \text{ mm}$

Maximum value of SAR (interpolated) = 19.4 W/kg

System Performance Check at 5800MHz/Zoom Scan (8x8x7)/Cube 0:

Measurement grid: $dx=4\text{mm}$, $dy=4\text{mm}$, $dz=1.4\text{mm}$

Reference Value = 26.600 V/m; Power Drift = -0.17 dB

Peak SAR (extrapolated) = 38.5 W/kg

SAR(1 g) = 7.76 W/kg; SAR(10 g) = 2.12 W/kg

Maximum value of SAR (measured) = 20.0 W/kg

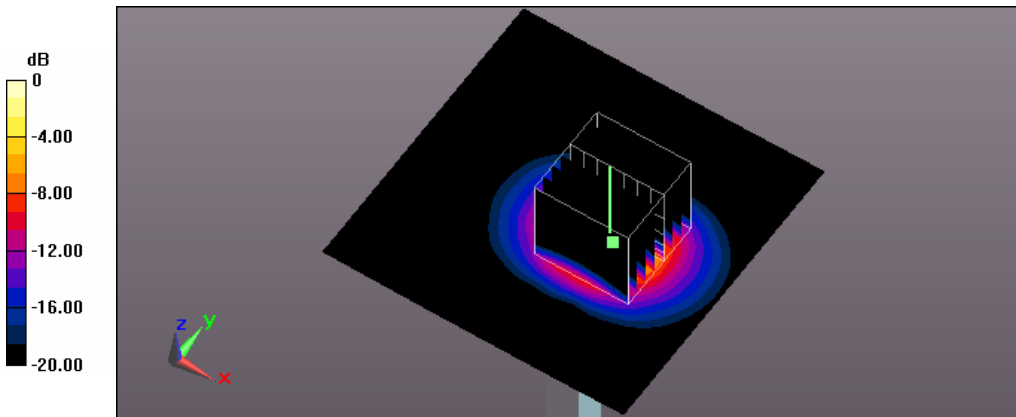

0 dB = 20.0 W/kg = 13.01 dBW/kg

Appendix B - SAR Measurement Data

Test Laboratory: A Test Lab Techno Corp.

Date: 2014/8/13 Time: PM 09:34:18

1_Flat_802.11b CH1_1M_side2 surface to phantom 0mm_Antenna1

DUT: DT10; Type: Notebook computer

Communication System: UID 0, IEEE 802.11b (0); Frequency: 2412 MHz; Duty Cycle: 1:1

Medium parameters used: $f = 2412$ MHz; $\sigma = 1.927$ S/m; $\epsilon_r = 53.982$; $\rho = 1000$ kg/m³

Phantom section: Flat Section

Measurement Standard: DASYS5 (IEEE/IEC/ANSI C63.19-2011)

DASY Configuration:

- Area Scan setting - Find Secondary Maximum Within: 2.0dB and with a peak SAR value greater than 0.5 W/Kg
- Probe: EX3DV4 - SN3977; ConvF(6.97, 6.97, 6.97); Calibrated: 2014/2/17;
- Sensor-Surface: 2mm (Mechanical Surface Detection)
- Electronics: DAE4 Sn779; Calibrated: 2014/2/25
- Phantom: ELI v5.0; Type: QDOVA002AA; Serial: TP:1133
- Measurement SW: DASYS52, Version 52.8 (7); SEMCAD X Version 14.6.10 (7164)

Flat/Area Scan (151x211x1):

Interpolated grid: $dx=1.000$ mm, $dy=1.000$ mm

Maximum value of SAR (interpolated) = 0.691 W/kg

Flat/Zoom Scan (7x7x7)/Cube 0:

Measurement grid: $dx=5$ mm, $dy=5$ mm, $dz=5$ mm

Reference Value = 0 V/m; Power Drift = 0.00 dB

Peak SAR (extrapolated) = 0.959 W/kg

SAR(1 g) = 0.443 W/kg; SAR(10 g) = 0.207 W/kg

Maximum value of SAR (measured) = 0.665 W/kg

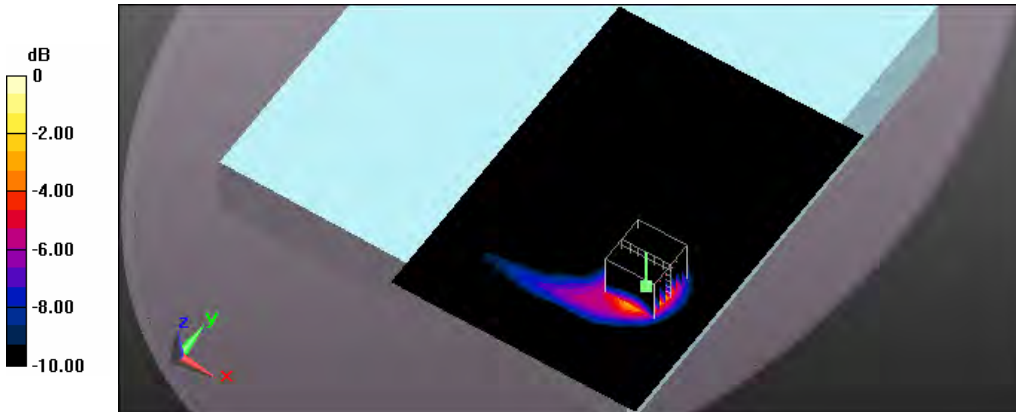

0 dB = 0.665 W/kg = -1.77 dBW/kg

Test Laboratory: A Test Lab Techno Corp.
 Date: 2014/8/13 Time: PM 08:48:28

2_Flat_802.11b CH1_1M_side5 surface to phantom 0mm_Antenna1

DUT: DT10; Type: Notebook computer

Communication System: UID 0, IEEE 802.11b (0); Frequency: 2412 MHz; Duty Cycle: 1:1

Medium parameters used: $f = 2412 \text{ MHz}$; $\sigma = 1.927 \text{ S/m}$; $\epsilon_r = 53.982$; $\rho = 1000 \text{ kg/m}^3$

Phantom section: Flat Section

Measurement Standard: DASY5 (IEEE/IEC/ANSI C63.19-2011)

DASY Configuration:

- Area Scan setting - Find Secondary Maximum Within: 2.0dB and with a peak SAR value greater than 0.5 W/Kg
- Probe: EX3DV4 - SN3977; ConvF(6.97, 6.97, 6.97); Calibrated: 2014/2/17;
- Sensor-Surface: 2mm (Mechanical Surface Detection)
- Electronics: DAE4 Sn779; Calibrated: 2014/2/25
- Phantom: ELI v5.0; Type: QDOVA002AA; Serial: TP:1133
- Measurement SW: DASY52, Version 52.8 (7); SEMCAD X Version 14.6.10 (7164)

Flat/Area Scan (101x151x1):

Interpolated grid: $dx=1.000 \text{ mm}$, $dy=1.000 \text{ mm}$

Maximum value of SAR (interpolated) = 0.150 W/kg

Flat/Zoom Scan (7x7x7)/Cube 0:

Measurement grid: $dx=5\text{mm}$, $dy=5\text{mm}$, $dz=5\text{mm}$

Reference Value = 4.429 V/m; Power Drift = -0.11 dB

Peak SAR (extrapolated) = 0.197 W/kg

SAR(1 g) = 0.112 W/kg; SAR(10 g) = 0.066 W/kg

Maximum value of SAR (measured) = 0.153 W/kg

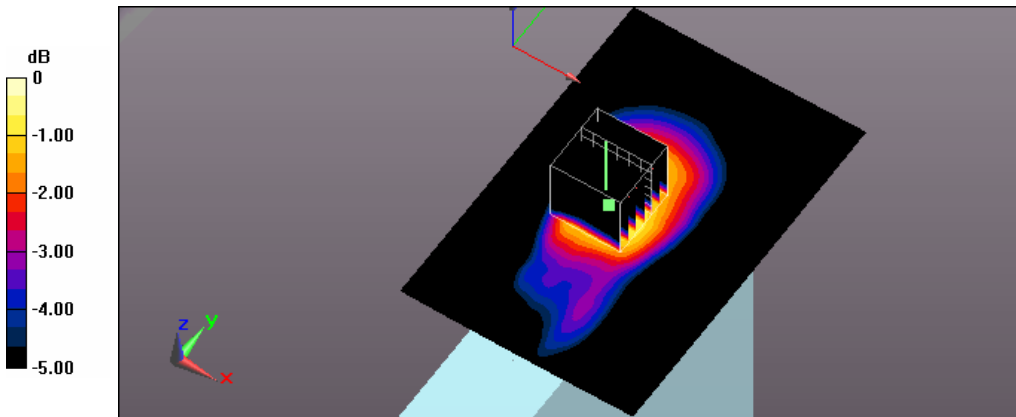

0 dB = 0.153 W/kg = -8.15 dBW/kg

Test Laboratory: A Test Lab Techno Corp.
 Date: 2014/8/14 Time: AM 01:52:02

3_Flat_802.11b CH6_1M_side1 surface to phantom 0mm_Antenna2

DUT: DT10; Type: Notebook computer

Communication System: UID 0, IEEE 802.11b (0); Frequency: 2437 MHz; Duty Cycle: 1:1

Medium parameters used: $f = 2437 \text{ MHz}$; $\sigma = 1.988 \text{ S/m}$; $\epsilon_r = 54.297$; $\rho = 1000 \text{ kg/m}^3$

Phantom section: Flat Section

Measurement Standard: DASYS5 (IEEE/IEC/ANSI C63.19-2011)

DASY Configuration:

- Area Scan setting - Find Secondary Maximum Within: 2.0dB and with a peak SAR value greater than 0.5 W/Kg
- Probe: EX3DV4 - SN3977; ConvF(6.97, 6.97, 6.97); Calibrated: 2014/2/17;
- Sensor-Surface: 2mm (Mechanical Surface Detection)
- Electronics: DAE4 Sn779; Calibrated: 2014/2/25
- Phantom: ELI v5.0; Type: QDOVA002AA; Serial: TP:1133
- Measurement SW: DASYS52, Version 52.8 (7); SEMCAD X Version 14.6.10 (7164)

Flat/Area Scan (211x181x1):

Interpolated grid: $dx=1.000 \text{ mm}$, $dy=1.000 \text{ mm}$

Maximum value of SAR (interpolated) = 0.608 W/kg

Flat/Zoom Scan (7x7x7)/Cube 0:

Measurement grid: $dx=5\text{mm}$, $dy=5\text{mm}$, $dz=5\text{mm}$

Reference Value = 0.563 V/m; Power Drift = 0.18 dB

Peak SAR (extrapolated) = 0.931 W/kg

SAR(1 g) = 0.385 W/kg; SAR(10 g) = 0.172 W/kg

Maximum value of SAR (measured) = 0.583 W/kg

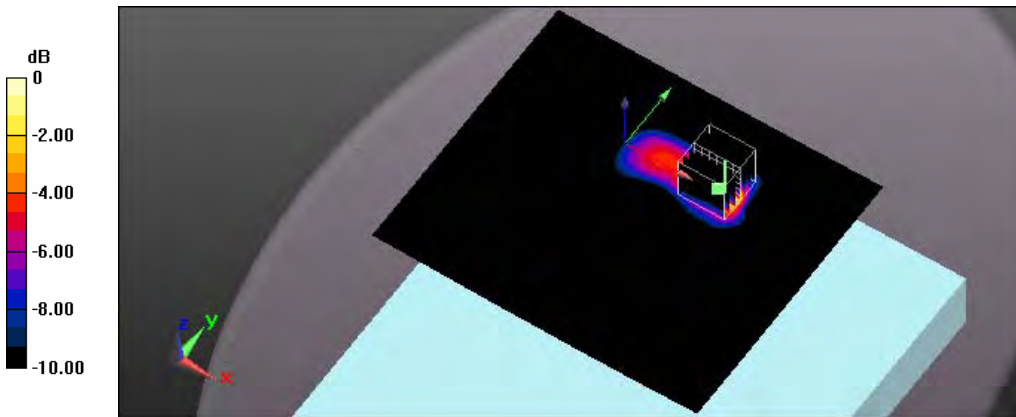

0 dB = 0.583 W/kg = -2.34 dBW/kg

Test Laboratory: A Test Lab Techno Corp.

Date: 2014/8/28 Time: AM 01:16:31

4_Flat_802.11b_CH6_1M_side6 surface to phantom 0mm_Antenna2

DUT: DT10; Type: Notebook computer

Communication System: UID 0, IEEE 802.11b (0); Frequency: 2437 MHz; Duty Cycle: 1:1

Medium parameters used: $f = 2437$ MHz; $\sigma = 1.988$ S/m; $\epsilon_r = 54.297$; $\rho = 1000$ kg/m³

Phantom section: Flat Section

Measurement Standard: DASY5 (IEEE/IEC/ANSI C63.19-2011)

DASY Configuration:

- Area Scan setting - Find Secondary Maximum Within: 2.0dB and with a peak SAR value greater than 0.5 W/Kg
- Probe: EX3DV4 - SN3977; ConvF(6.97, 6.97, 6.97); Calibrated: 2014/2/17;
- Sensor-Surface: 2mm (Mechanical Surface Detection)
- Electronics: DAE4 Sn779; Calibrated: 2014/2/25
- Phantom: ELI v5.0; Type: QDOVA002AA; Serial: TP:1133
- Measurement SW: DASY52, Version 52.8 (7); SEMCAD X Version 14.6.10 (7164)

Flat/Area Scan (101x181x1):

Interpolated grid: $dx=1.000$ mm, $dy=1.000$ mm

Maximum value of SAR (interpolated) = 0.661 W/kg

Flat/Zoom Scan (7x7x7)/Cube 0:

Measurement grid: $dx=5$ mm, $dy=5$ mm, $dz=5$ mm

Reference Value = 6.927 V/m; Power Drift = -0.18 dB

Peak SAR (extrapolated) = 0.990 W/kg

SAR(1 g) = 0.459 W/kg; SAR(10 g) = 0.220 W/kg

Maximum value of SAR (measured) = 0.732 W/kg

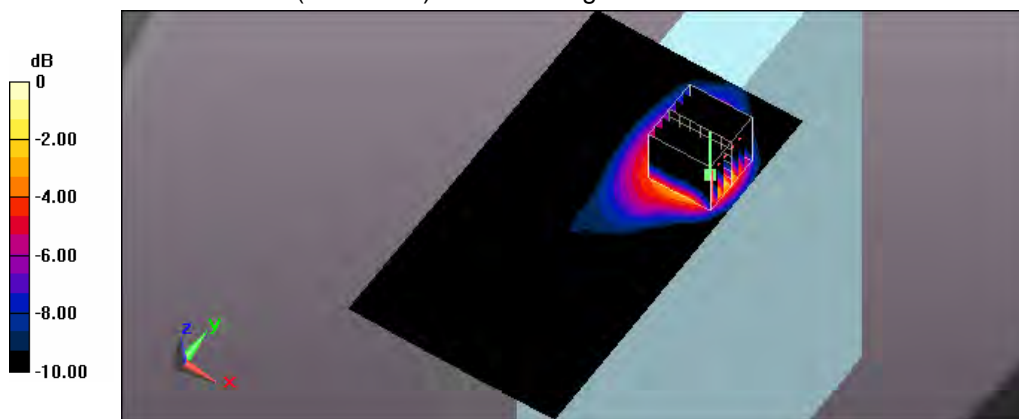

0 dB = 0.732 W/kg = -1.35 dBW/kg

Test Laboratory: A Test Lab Techno Corp.

Date: 2014/8/28 Time: AM 04:33:55

5_Flat_802.11a_CH36_6M_side1 surface to phantom 0mm_Antenna2

DUT: DT10; Type: Notebook computer

Communication System: UID 0, IEEE 802.11a (0); Frequency: 5180 MHz; Duty Cycle: 1:1

Medium parameters used (interpolated): $f = 5180$ MHz; $\sigma = 5.496$ S/m; $\epsilon_r = 47.812$; $\rho = 1000$ kg/m³

Phantom section: Flat Section

Measurement Standard: DASY5 (IEEE/IEC/ANSI C63.19-2011)

DASY Configuration:

- Area Scan setting - Find Secondary Maximum Within: 2.0dB and with a peak SAR value greater than 0.5 W/Kg
- Probe: EX3DV4 - SN3977; ConvF(4.5, 4.5, 4.5); Calibrated: 2014/2/17;
- Sensor-Surface: 2mm (Mechanical Surface Detection)
- Electronics: DAE4 Sn779; Calibrated: 2014/2/25
- Phantom: ELI v5.0; Type: QDOVA002AA; Serial: TP:1133
- Measurement SW: DASY52, Version 52.8 (7); SEMCAD X Version 14.6.10 (7164)

Flat/Area Scan (211x181x1):

Interpolated grid: dx=1.000 mm, dy=1.000 mm

Maximum value of SAR (interpolated) = 0.837 W/kg

Flat/Zoom Scan (8x8x12)/Cube 0:

Measurement grid: dx=4mm, dy=4mm, dz=2mm

Reference Value = 0 V/m; Power Drift = 0.00 dB

Peak SAR (extrapolated) = 1.81 W/kg

SAR(1 g) = 0.455 W/kg; SAR(10 g) = 0.150 W/kg

Maximum value of SAR (measured) = 0.843 W/kg

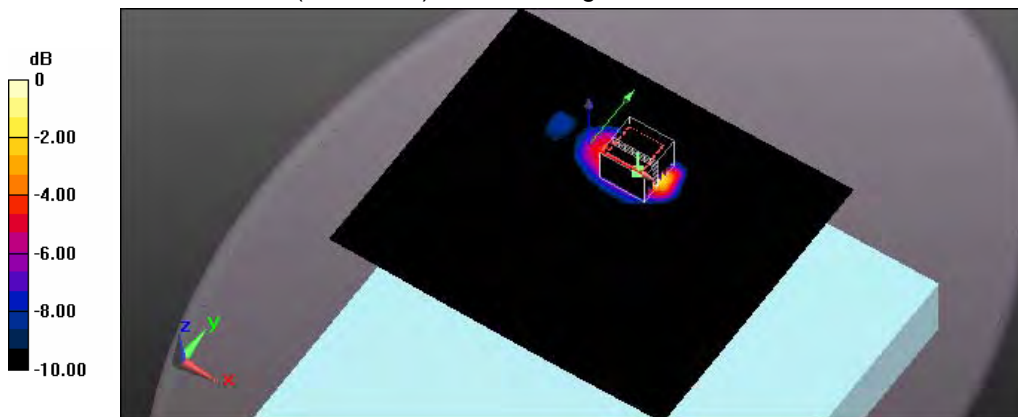

0 dB = 0.843 W/kg = -0.74 dBW/kg

Test Laboratory: A Test Lab Techno Corp.

Date: 2014/8/28 Time: AM 10:12:39

6_Flat_802.11a_CH40_6M_side1 surface to phantom 0mm_Antenna2

DUT: DT10; Type: Notebook computer

Communication System: UID 0, IEEE 802.11a (0); Frequency: 5200 MHz; Duty Cycle: 1:1

Medium parameters used: $f = 5200 \text{ MHz}$; $\sigma = 5.52 \text{ S/m}$; $\epsilon_r = 47.76$; $\rho = 1000 \text{ kg/m}^3$

Phantom section: Flat Section

Measurement Standard: DASY5 (IEEE/IEC/ANSI C63.19-2011)

DASY Configuration:

- Area Scan setting - Find Secondary Maximum Within: 2.0dB and with a peak SAR value greater than 0.5 W/Kg
- Probe: EX3DV4 - SN3977; ConvF(4.5, 4.5, 4.5); Calibrated: 2014/2/17;
- Sensor-Surface: 2mm (Mechanical Surface Detection)
- Electronics: DAE4 Sn779; Calibrated: 2014/2/25
- Phantom: ELI v5.0; Type: QDOVA002AA; Serial: TP:1133
- Measurement SW: DASY52, Version 52.8 (7); SEMCAD X Version 14.6.10 (7164)

Flat/Area Scan (211x161x1):

Interpolated grid: $dx=1.000 \text{ mm}$, $dy=1.000 \text{ mm}$

Maximum value of SAR (interpolated) = 0.796 W/kg

Flat/Zoom Scan (8x8x12)/Cube 0:

Measurement grid: $dx=4\text{mm}$, $dy=4\text{mm}$, $dz=2\text{mm}$

Reference Value = 0 V/m; Power Drift = 0.00 dB

Peak SAR (extrapolated) = 1.85 W/kg

SAR(1 g) = 0.464 W/kg; SAR(10 g) = 0.158 W/kg

Maximum value of SAR (measured) = 0.868 W/kg

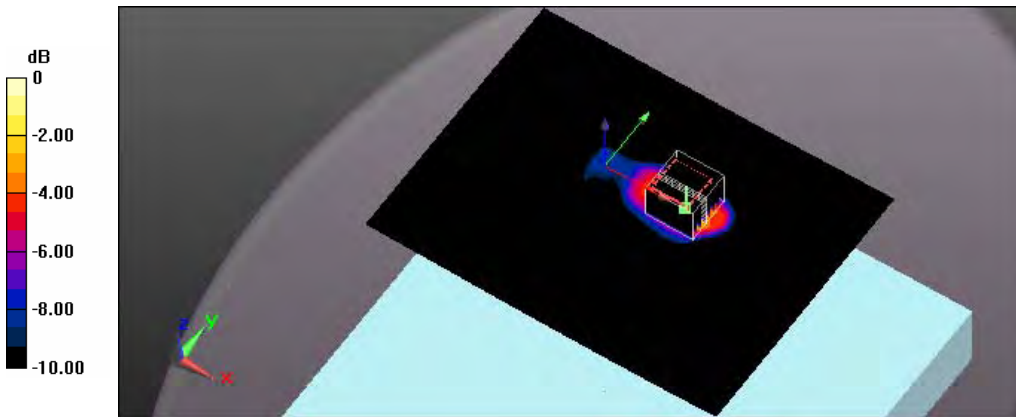

0 dB = 0.868 W/kg = -0.61 dBW/kg

Test Laboratory: A Test Lab Techno Corp.

Date: 2014/8/28 Time: AM 11:26:39

7_Flat_802.11a_CH157_6M_side1 surface to phantom 0mm_Antenna2

DUT: DT10; Type: Notebook computer

Communication System: UID 0, IEEE 802.11a (0); Frequency: 5785 MHz; Duty Cycle: 1:1

Medium parameters used (interpolated): $f = 5785 \text{ MHz}$; $\sigma = 6.252 \text{ S/m}$; $\epsilon_r = 46.442$; $\rho = 1000 \text{ kg/m}^3$

Phantom section: Flat Section

Measurement Standard: DASYS (IEEE/IEC/ANSI C63.19-2011)

DASY Configuration:

- Area Scan setting - Find Secondary Maximum Within: 2.0dB and with a peak SAR value greater than 0.5 W/Kg
- Probe: EX3DV4 - SN3977; ConvF(4.12, 4.12, 4.12); Calibrated: 2014/2/17;
- Sensor-Surface: 2mm (Mechanical Surface Detection)
- Electronics: DAE4 Sn779; Calibrated: 2014/2/25
- Phantom: ELI v5.0; Type: QDOVA002AA; Serial: TP:1133
- Measurement SW: DASYS2, Version 52.8 (7); SEMCAD X Version 14.6.10 (7164)

Flat/Area Scan (211x161x1):

Interpolated grid: $dx=1.000 \text{ mm}$, $dy=1.000 \text{ mm}$

Maximum value of SAR (interpolated) = 1.03 W/kg

Flat/Zoom Scan (8x8x12)/Cube 0:

Measurement grid: $dx=4\text{mm}$, $dy=4\text{mm}$, $dz=2\text{mm}$

Reference Value = 0 V/m; Power Drift = 0.00 dB

Peak SAR (extrapolated) = 2.09 W/kg

SAR(1 g) = 0.467 W/kg; SAR(10 g) = 0.151 W/kg

Maximum value of SAR (measured) = 0.903 W/kg

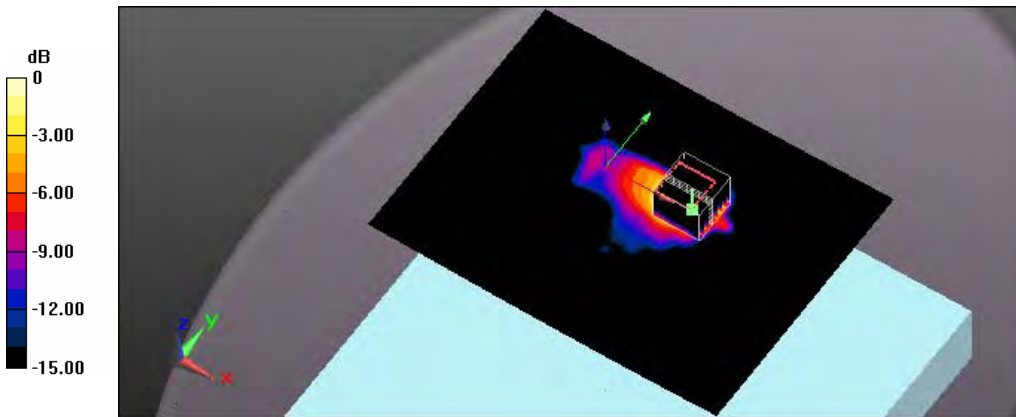

0 dB = 0.903 W/kg = -0.44 dBW/kg

Test Laboratory: A Test Lab Techno Corp.

Date: 2014/8/28 Time: PM 01:15:59

8_Flat_802.11a_CH161_6M_side1 surface to phantom 0mm_Antenna2

DUT: DT10; Type: Notebook computer

Communication System: UID 0, IEEE 802.11a (0); Frequency: 5805 MHz; Duty Cycle: 1:1

Medium parameters used (interpolated): $f = 5805 \text{ MHz}$; $\sigma = 6.272 \text{ S/m}$; $\epsilon_r = 46.395$; $\rho = 1000 \text{ kg/m}^3$

Phantom section: Flat Section

Measurement Standard: DASYS (IEEE/IEC/ANSI C63.19-2011)

DASY Configuration:

- Area Scan setting - Find Secondary Maximum Within: 2.0dB and with a peak SAR value greater than 0.5 W/Kg
- Probe: EX3DV4 - SN3977; ConvF(4.12, 4.12, 4.12); Calibrated: 2014/2/17;
- Sensor-Surface: 2mm (Mechanical Surface Detection)
- Electronics: DAE4 Sn779; Calibrated: 2014/2/25
- Phantom: ELI v5.0; Type: QDOVA002AA; Serial: TP:1133
- Measurement SW: DASYS2, Version 52.8 (7); SEMCAD X Version 14.6.10 (7164)

Flat/Area Scan (211x161x1):

Interpolated grid: $dx=1.000 \text{ mm}$, $dy=1.000 \text{ mm}$

Maximum value of SAR (interpolated) = 0.825 W/kg

Flat/Zoom Scan (8x8x12)/Cube 0:

Measurement grid: $dx=4\text{mm}$, $dy=4\text{mm}$, $dz=2\text{mm}$

Reference Value = 0 V/m; Power Drift = 0.00 dB

Peak SAR (extrapolated) = 1.95 W/kg

SAR(1 g) = 0.453 W/kg; SAR(10 g) = 0.143 W/kg

Maximum value of SAR (measured) = 0.911 W/kg

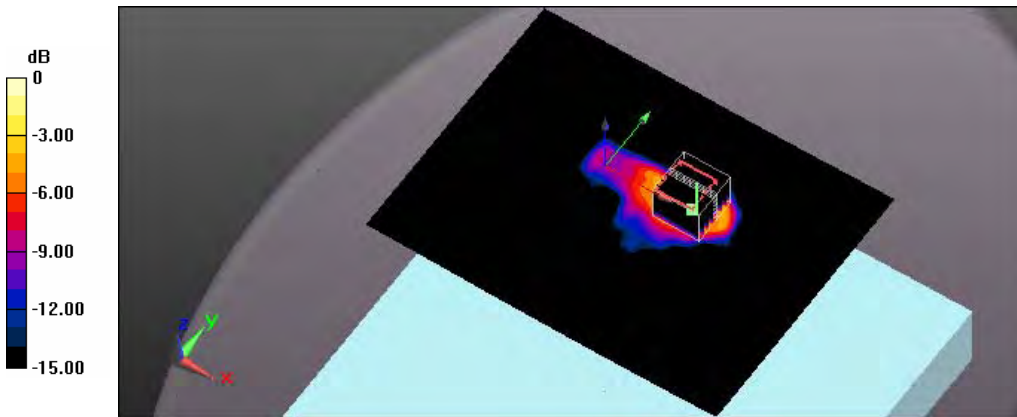

0 dB = 0.911 W/kg = -0.40 dBW/kg

Test Laboratory: A Test Lab Techno Corp.
 Date: 2014/8/28 Time: PM 05:01:10

9_Flat_802.11n HT20(5G) CH44_13M_side1 surface to phantom 0mm_MIMO

DUT: DT10; Type: Notebook computer

Communication System: UID 0, IEEE 802.11n(5GHz)HT20 (0); Frequency: 5220 MHz; Duty Cycle: 1:1

Medium parameters used (interpolated): $f = 5220 \text{ MHz}$; $\sigma = 5.532 \text{ S/m}$; $\epsilon_r = 47.708$; $\rho = 1000 \text{ kg/m}^3$

Phantom section: Flat Section

Measurement Standard: DASYS5 (IEEE/IEC/ANSI C63.19-2011)

DASY Configuration:

- Area Scan setting - Find Secondary Maximum Within: 2.0dB and with a peak SAR value greater than 0.5 W/Kg
- Probe: EX3DV4 - SN3977; ConvF(4.5, 4.5, 4.5); Calibrated: 2014/2/17;
- Sensor-Surface: 2mm (Mechanical Surface Detection)
- Electronics: DAE4 Sn779; Calibrated: 2014/2/25
- Phantom: ELI v5.0; Type: QDOVA002AA; Serial: TP:1133
- Measurement SW: DASYS52, Version 52.8 (7); SEMCAD X Version 14.6.10 (7164)

Flat/Area Scan (211x331x1):

Interpolated grid: $dx=1.000 \text{ mm}$, $dy=1.000 \text{ mm}$

Maximum value of SAR (interpolated) = 0.304 W/kg

Flat/Zoom Scan (8x8x12)/Cube 0:

Measurement grid: $dx=4\text{mm}$, $dy=4\text{mm}$, $dz=2\text{mm}$

Reference Value = 0 V/m; Power Drift = 0.00 dB

Peak SAR (extrapolated) = 0.565 W/kg

SAR(1 g) = 0.154 W/kg; SAR(10 g) = 0.048 W/kg

Maximum value of SAR (measured) = 0.291 W/kg

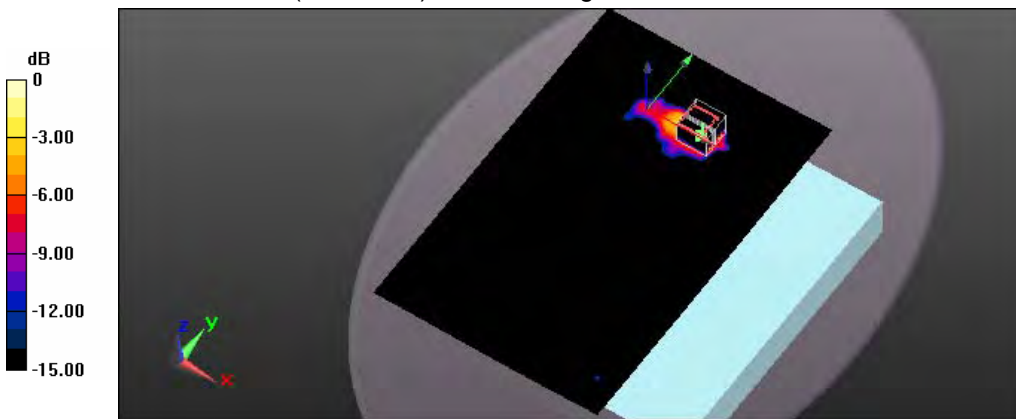

0 dB = 0.291 W/kg = -5.36 dBW/kg

Test Laboratory: A Test Lab Techno Corp.

Date: 2014/8/28 Time: PM 07:05:13

10_Flat_802.11n HT20(5G) CH48_13M_side1 surface to phantom 0mm_MIMO

DUT: DT10; Type: Notebook computer

Communication System: UID 0, IEEE 802.11n(5GHz)HT20 (0); Frequency: 5240 MHz; Duty Cycle: 1:1

Medium parameters used (interpolated): $f = 5240 \text{ MHz}$; $\sigma = 5.544 \text{ S/m}$; $\epsilon_r = 47.656$; $\rho = 1000 \text{ kg/m}^3$

Phantom section: Flat Section

Measurement Standard: DASYS5 (IEEE/IEC/ANSI C63.19-2011)

DASY Configuration:

- Area Scan setting - Find Secondary Maximum Within: 2.0dB and with a peak SAR value greater than 0.5 W/Kg
- Probe: EX3DV4 - SN3977; ConvF(4.5, 4.5, 4.5); Calibrated: 2014/2/17;
- Sensor-Surface: 2mm (Mechanical Surface Detection)
- Electronics: DAE4 Sn779; Calibrated: 2014/2/25
- Phantom: ELI v5.0; Type: QDOVA002AA; Serial: TP:1133
- Measurement SW: DASYS52, Version 52.8 (7); SEMCAD X Version 14.6.10 (7164)

Flat/Area Scan (211x331x1):

Interpolated grid: $dx=1.000 \text{ mm}$, $dy=1.000 \text{ mm}$

Maximum value of SAR (interpolated) = 0.378 W/kg

Flat/Zoom Scan (8x8x12)/Cube 0:

Measurement grid: $dx=4\text{mm}$, $dy=4\text{mm}$, $dz=2\text{mm}$

Reference Value = 0 V/m; Power Drift = 0.00 dB

Peak SAR (extrapolated) = 0.673 W/kg

SAR(1 g) = 0.173 W/kg; SAR(10 g) = 0.052 W/kg

Maximum value of SAR (measured) = 0.327 W/kg

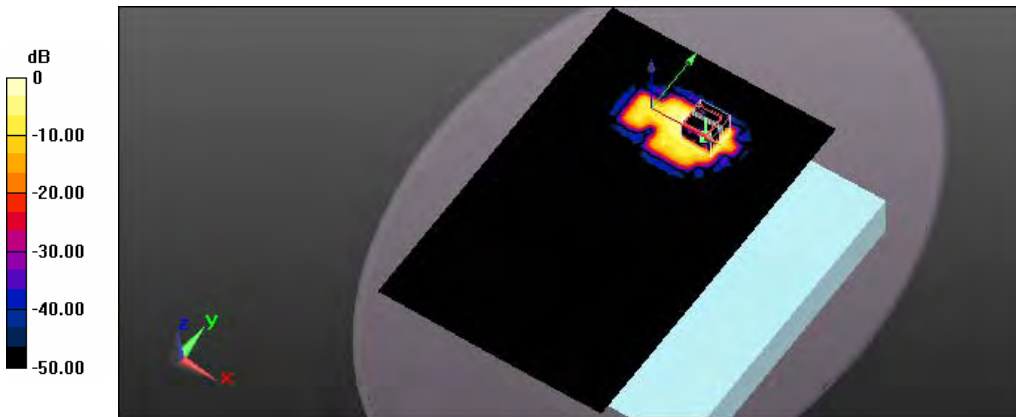

0 dB = 0.327 W/kg = -4.85 dBW/kg

Test Laboratory: A Test Lab Techno Corp.

Date: 2014/8/28 Time: PM 09:00:35

11_Flat_802.11n HT20(5G) CH157_13M_side1 surface to phantom 0mm_MIMO

DUT: DT10; Type: Notebook computer

Communication System: UID 0, IEEE 802.11n(5GHz)HT20 (0); Frequency: 5785 MHz; Duty Cycle: 1:1

Medium parameters used (interpolated): $f = 5785 \text{ MHz}$; $\sigma = 6.252 \text{ S/m}$; $\epsilon_r = 46.442$; $\rho = 1000 \text{ kg/m}^3$

Phantom section: Flat Section

Measurement Standard: DASYS (IEEE/IEC/ANSI C63.19-2011)

DASY Configuration:

- Area Scan setting - Find Secondary Maximum Within: 2.0dB and with a peak SAR value greater than 0.5 W/Kg
- Probe: EX3DV4 - SN3977; ConvF(4.12, 4.12, 4.12); Calibrated: 2014/2/17;
- Sensor-Surface: 2mm (Mechanical Surface Detection)
- Electronics: DAE4 Sn779; Calibrated: 2014/2/25
- Phantom: ELI v5.0; Type: QDOVA002AA; Serial: TP:1133
- Measurement SW: DASYS2, Version 52.8 (7); SEMCAD X Version 14.6.10 (7164)

Flat/Area Scan (211x331x1):

Interpolated grid: $dx=1.000 \text{ mm}$, $dy=1.000 \text{ mm}$

Maximum value of SAR (interpolated) = 0.929 W/kg

Flat/Zoom Scan (8x8x12)/Cube 0:

Measurement grid: $dx=4\text{mm}$, $dy=4\text{mm}$, $dz=2\text{mm}$

Reference Value = 0 V/m; Power Drift = 0.00 dB

Peak SAR (extrapolated) = 1.81 W/kg

SAR(1 g) = 0.441 W/kg; SAR(10 g) = 0.135 W/kg

Maximum value of SAR (measured) = 0.867 W/kg

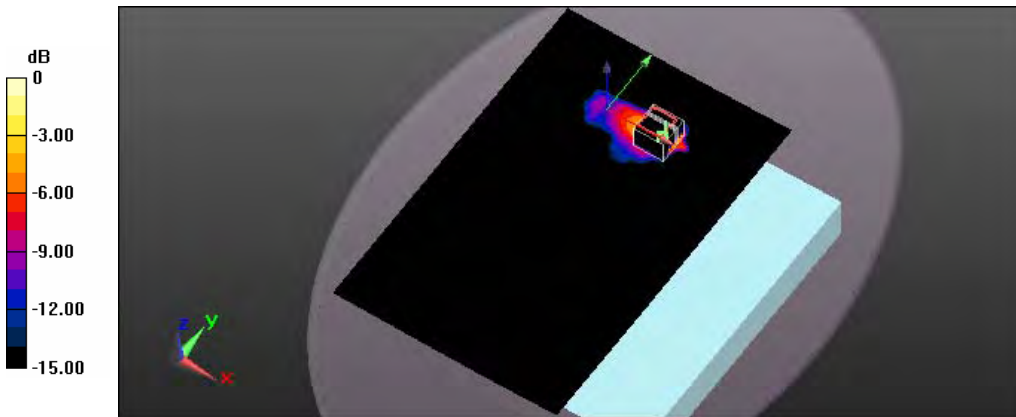

0 dB = 0.867 W/kg = -0.62 dBW/kg

Test Laboratory: A Test Lab Techno Corp.

Date: 2014/8/29 Time: AM 02:15:55

13_Flat_802.11n HT20(5G) CH157_13M_side6 surface to phantom 0mm_MIMO

DUT: DT10; Type: Notebook computer

Communication System: UID 0, IEEE 802.11n(5GHz)HT20 (0); Frequency: 5785 MHz; Duty Cycle: 1:1

Medium parameters used (interpolated): $f = 5785 \text{ MHz}$; $\sigma = 6.252 \text{ S/m}$; $\epsilon_r = 46.442$; $\rho = 1000 \text{ kg/m}^3$

Phantom section: Flat Section

Measurement Standard: DASYS (IEEE/IEC/ANSI C63.19-2011)

DASY Configuration:

- Area Scan setting - Find Secondary Maximum Within: 2.0dB and with a peak SAR value greater than 0.5 W/Kg
- Probe: EX3DV4 - SN3977; ConvF(4.12, 4.12, 4.12); Calibrated: 2014/2/17;
- Sensor-Surface: 2mm (Mechanical Surface Detection)
- Electronics: DAE4 Sn779; Calibrated: 2014/2/25
- Phantom: ELI v5.0; Type: QDOVA002AA; Serial: TP:1133
- Measurement SW: DASYS2, Version 52.8 (7); SEMCAD X Version 14.6.10 (7164)

Flat/Area Scan (121x181x1):

Interpolated grid: $dx=1.000 \text{ mm}$, $dy=1.000 \text{ mm}$

Maximum value of SAR (interpolated) = 0.168 W/kg

Flat/Zoom Scan (8x8x12)/Cube 0:

Measurement grid: $dx=4\text{mm}$, $dy=4\text{mm}$, $dz=2\text{mm}$

Reference Value = 0 V/m; Power Drift = 0.00 dB

Peak SAR (extrapolated) = 0.335 W/kg

SAR(1 g) = 0.056 W/kg; SAR(10 g) = 0.016 W/kg

Maximum value of SAR (measured) = 0.143 W/kg

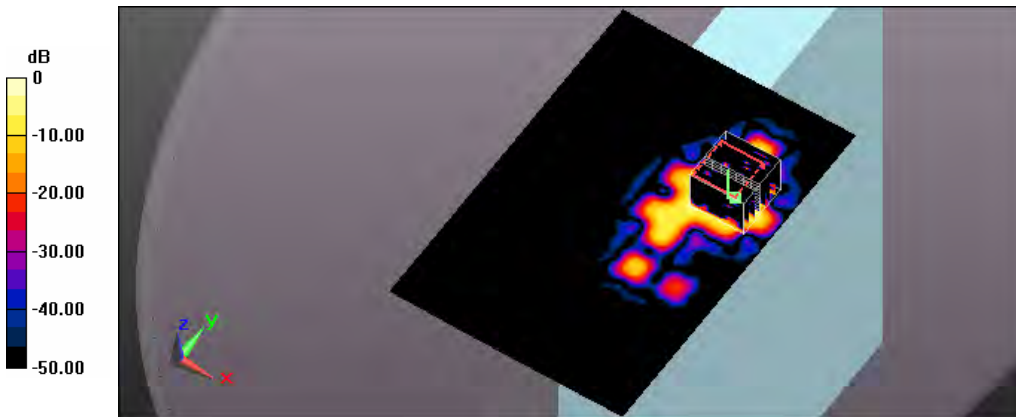

0 dB = 0.143 W/kg = -8.45 dBW/kg

Test Laboratory: A Test Lab Techno Corp.

Date: 2014/8/28 Time: PM 11:25:48

12_Flat_802.11n HT20(5G) CH161_13M_side1 surface to phantom 0mm_MIMO

DUT: DT10; Type: Notebook computer

Communication System: UID 0, IEEE 802.11n(5GHz)HT20 (0); Frequency: 5805 MHz; Duty Cycle: 1:1

Medium parameters used (interpolated): $f = 5805 \text{ MHz}$; $\sigma = 6.272 \text{ S/m}$; $\epsilon_r = 46.395$; $\rho = 1000 \text{ kg/m}^3$

Phantom section: Flat Section

Measurement Standard: DASYS (IEEE/IEC/ANSI C63.19-2011)

DASY Configuration:

- Area Scan setting - Find Secondary Maximum Within: 2.0dB and with a peak SAR value greater than 0.5 W/Kg
- Probe: EX3DV4 - SN3977; ConvF(4.12, 4.12, 4.12); Calibrated: 2014/2/17;
- Sensor-Surface: 2mm (Mechanical Surface Detection)
- Electronics: DAE4 Sn779; Calibrated: 2014/2/25
- Phantom: ELI v5.0; Type: QDOVA002AA; Serial: TP:1133
- Measurement SW: DASYS2, Version 52.8 (7); SEMCAD X Version 14.6.10 (7164)

Flat/Area Scan (211x331x1):

Interpolated grid: $dx=1.000 \text{ mm}$, $dy=1.000 \text{ mm}$

Maximum value of SAR (interpolated) = 0.804 W/kg

Flat/Zoom Scan (8x8x12)/Cube 0:

Measurement grid: $dx=4\text{mm}$, $dy=4\text{mm}$, $dz=2\text{mm}$

Reference Value = 0 V/m; Power Drift = 0.00 dB

Peak SAR (extrapolated) = 1.77 W/kg

SAR(1 g) = 0.413 W/kg; SAR(10 g) = 0.139 W/kg

Maximum value of SAR (measured) = 0.807 W/kg



0 dB = 0.807 W/kg = -0.93 dBW/kg

Test Laboratory: A Test Lab Techno Corp.

Date: 2014/8/29 Time: AM 01:20:05

14_Flat_802.11n HT20(5G) CH161_13M_side6 surface to phantom 0mm_MIMO

DUT: DT10; Type: Notebook computer

Communication System: UID 0, IEEE 802.11n(5GHz)HT20 (0); Frequency: 5805 MHz; Duty Cycle: 1:1

Medium parameters used (interpolated): $f = 5805$ MHz; $\sigma = 6.272$ S/m; $\epsilon_r = 46.395$; $\rho = 1000$ kg/m³

Phantom section: Flat Section

Measurement Standard: DASYS (IEEE/IEC/ANSI C63.19-2011)

DASY Configuration:

- Area Scan setting - Find Secondary Maximum Within: 2.0dB and with a peak SAR value greater than 0.5 W/Kg
- Probe: EX3DV4 - SN3977; ConvF(4.12, 4.12, 4.12); Calibrated: 2014/2/17;
- Sensor-Surface: 2mm (Mechanical Surface Detection)
- Electronics: DAE4 Sn779; Calibrated: 2014/2/25
- Phantom: ELI v5.0; Type: QDOVA002AA; Serial: TP:1133
- Measurement SW: DASYS2, Version 52.8 (7); SEMCAD X Version 14.6.10 (7164)

Flat/Area Scan (121x181x1):

Interpolated grid: dx=1.000 mm, dy=1.000 mm

Maximum value of SAR (interpolated) = 0.200 W/kg

Flat/Zoom Scan (8x8x12)/Cube 0:

Measurement grid: dx=4mm, dy=4mm, dz=2mm

Reference Value = 0 V/m; Power Drift = 0.00 dB

Peak SAR (extrapolated) = 0.356 W/kg

SAR(1 g) = 0.056 W/kg; SAR(10 g) = 0.016 W/kg

Maximum value of SAR (measured) = 0.137 W/kg

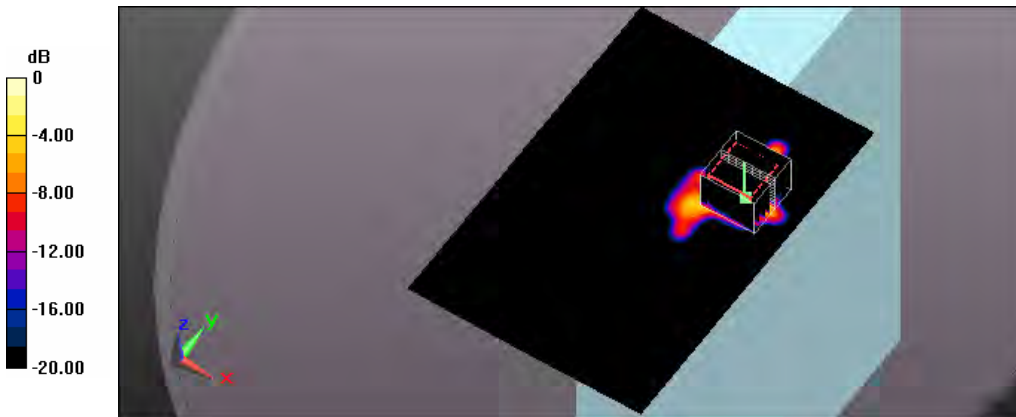

0 dB = 0.137 W/kg = -8.63 dBW/kg



Appendix C - Calibration

All of the instruments Calibration information are listed below.

- Dipole _ D2450V2 SN:712 Calibration No.D2450V2-712_Mar14
- Dipole _ D5GHzV2 SN:1021 Calibration No.D5GHzV2-1021_Feb14
- Probe _ EX3DV4 SN:3977 Calibration No.EX3-3977_Feb14
- DAE _ DAE4 SN:779 Calibration No.DAE4-779_Feb14



Calibration Laboratory of
Schmid & Partner
Engineering AG
 Zeughausstrasse 43, 8004 Zurich, Switzerland



S Schweizerischer Kalibrierdienst
C Service suisse d'étalonnage
S Servizio svizzero di taratura
S Swiss Calibration Service

Accredited by the Swiss Accreditation Service (SAS)
 The Swiss Accreditation Service is one of the signatories to the EA
 Multilateral Agreement for the recognition of calibration certificates

Accreditation No.: **SCS 108**

Client **ATL (Auden)**

Certificate No.: **D2450V2-712_Mar14**

CALIBRATION CERTIFICATE

Object: **D2450V2 - SN: 712**

Calibration procedure(s): **QA CAL-05.v9
 Calibration procedure for dipole validation kits above 700 MHz**

Calibration date: **March 04, 2014**

This calibration certificate documents the traceability to national standards, which realize the physical units of measurements (SI).
 The measurements and the uncertainties with confidence probability are given on the following pages and are part of the certificate.

All calibrations have been conducted in the closed laboratory facility: environment temperature (22 ± 3)°C and humidity < 70%.

Calibration Equipment used (M&TE critical for calibration)

Primary Standards	ID #	Cal Date (Certificate No.)	Scheduled Calibration
Power meter EPM-442A	GB37480704	09-Oct-13 (No. 217-01827)	Oct-14
Power sensor HP 8481A	US37292783	09-Oct-13 (No. 217-01827)	Oct-14
Power sensor HP 8481A	MY41092317	09-Oct-13 (No. 217-01828)	Oct-14
Reference 20 dB Attenuator	SN: 5058 (20k)	04-Apr-13 (No. 217-01736)	Apr-14
Type-N mismatch combination	SN: 5047.3 / 06327	04-Apr-13 (No. 217-01739)	Apr-14
Reference Probe ES3DV3	SN: 3205	30-Dec-13 (No. ES3-3205_Dec13)	Dec-14
DAE4	SN: 601	25-Apr-13 (No. DAE4-601_Apr13)	Apr-14
Secondary Standards	ID #	Check Date (in house)	Scheduled Check
RF generator R&S SMT-06	100005	04-Aug-99 (in house check Oct-13)	In house check: Oct-16
Network Analyzer HP 8753E	US37390585 S4206	18-Oct-01 (in house check Oct-13)	In house check: Oct-14

	Name	Function	Signature
Calibrated by:	Leif Klysner	Laboratory Technician	
Approved by:	Katja Pokovic	Technical Manager	

Issued: March 4, 2014

This calibration certificate shall not be reproduced except in full without written approval of the laboratory.

Calibration Laboratory of
Schmid & Partner
Engineering AG
Zeughausstrasse 43, 8004 Zurich, Switzerland



S Schweizerischer Kalibrierdienst
S Service suisse d'étalonnage
C Servizio svizzero di taratura
S Swiss Calibration Service

Accredited by the Swiss Accreditation Service (SAS)
The Swiss Accreditation Service is one of the signatories to the EA
Multilateral Agreement for the recognition of calibration certificates

Accreditation No.: **SCS 108**

Glossary:

TSL	tissue simulating liquid
ConvF	sensitivity in TSL / NORM x,y,z
N/A	not applicable or not measured

Calibration is Performed According to the Following Standards:

- IEEE Std 1528-2013, "IEEE Recommended Practice for Determining the Peak Spatial-Averaged Specific Absorption Rate (SAR) in the Human Head from Wireless Communications Devices: Measurement Techniques", June 2013
- IEC 62209-1, "Procedure to measure the Specific Absorption Rate (SAR) for hand-held devices used in close proximity to the ear (frequency range of 300 MHz to 3 GHz)", February 2005
- KDB 865664, "SAR Measurement Requirements for 100 MHz to 6 GHz"

Additional Documentation:

- DASY4/5 System Handbook

Methods Applied and Interpretation of Parameters:

- Measurement Conditions:* Further details are available from the Validation Report at the end of the certificate. All figures stated in the certificate are valid at the frequency indicated.
- Antenna Parameters with TSL:* The dipole is mounted with the spacer to position its feed point exactly below the center marking of the flat phantom section, with the arms oriented parallel to the body axis.
- Feed Point Impedance and Return Loss:* These parameters are measured with the dipole positioned under the liquid filled phantom. The impedance stated is transformed from the measurement at the SMA connector to the feed point. The Return Loss ensures low reflected power. No uncertainty required.
- Electrical Delay:* One-way delay between the SMA connector and the antenna feed point. No uncertainty required.
- SAR measured:* SAR measured at the stated antenna input power.
- SAR normalized:* SAR as measured, normalized to an input power of 1 W at the antenna connector.
- SAR for nominal TSL parameters:* The measured TSL parameters are used to calculate the nominal SAR result.

The reported uncertainty of measurement is stated as the standard uncertainty of measurement multiplied by the coverage factor $k=2$, which for a normal distribution corresponds to a coverage probability of approximately 95%.



Measurement Conditions

DASY system configuration, as far as not given on page 1.

DASY Version	DASY5	V52.8.7
Extrapolation	Advanced Extrapolation	
Phantom	Modular Flat Phantom	
Distance Dipole Center - TSL	10 mm	with Spacer
Zoom Scan Resolution	dx, dy, dz = 5 mm	
Frequency	2450 MHz ± 1 MHz	

Head TSL parameters

The following parameters and calculations were applied.

	Temperature	Permittivity	Conductivity
Nominal Head TSL parameters	22.0 °C	39.2	1.80 mho/m
Measured Head TSL parameters	(22.0 ± 0.2) °C	38.1 ± 6 %	1.86 mho/m ± 6 %
Head TSL temperature change during test	< 0.5 °C	----	----

SAR result with Head TSL

SAR averaged over 1 cm ³ (1 g) of Head TSL	Condition	
SAR measured	250 mW input power	13.3 W/kg
SAR for nominal Head TSL parameters	normalized to 1W	52.0 W/kg ± 17.0 % (k=2)

SAR averaged over 10 cm ³ (10 g) of Head TSL	condition	
SAR measured	250 mW input power	6.16 W/kg
SAR for nominal Head TSL parameters	normalized to 1W	24.3 W/kg ± 16.5 % (k=2)

Body TSL parameters

The following parameters and calculations were applied.

	Temperature	Permittivity	Conductivity
Nominal Body TSL parameters	22.0 °C	52.7	1.95 mho/m
Measured Body TSL parameters	(22.0 ± 0.2) °C	50.7 ± 6 %	2.02 mho/m ± 6 %
Body TSL temperature change during test	< 0.5 °C	----	----

SAR result with Body TSL

SAR averaged over 1 cm ³ (1 g) of Body TSL	Condition	
SAR measured	250 mW input power	12.9 W/kg
SAR for nominal Body TSL parameters	normalized to 1W	50.3 W/kg ± 17.0 % (k=2)

SAR averaged over 10 cm ³ (10 g) of Body TSL	condition	
SAR measured	250 mW input power	5.96 W/kg
SAR for nominal Body TSL parameters	normalized to 1W	23.5 W/kg ± 16.5 % (k=2)



Appendix

Antenna Parameters with Head TSL

Impedance, transformed to feed point	54.7 Ω + 3.2 $j\Omega$
Return Loss	- 25.4 dB

Antenna Parameters with Body TSL

Impedance, transformed to feed point	51.3 Ω + 5.0 $j\Omega$
Return Loss	- 25.9 dB

General Antenna Parameters and Design

Electrical Delay (one direction)	1.150 ns
----------------------------------	----------

After long term use with 100W radiated power, only a slight warming of the dipole near the feedpoint can be measured.

The dipole is made of standard semirigid coaxial cable. The center conductor of the feeding line is directly connected to the second arm of the dipole. The antenna is therefore short-circuited for DC-signals. On some of the dipoles, small end caps are added to the dipole arms in order to improve matching when loaded according to the position as explained in the "Measurement Conditions" paragraph. The SAR data are not affected by this change. The overall dipole length is still according to the Standard.

No excessive force must be applied to the dipole arms, because they might bend or the soldered connections near the feedpoint may be damaged.

Additional EUT Data

Manufactured by	SPEAG
Manufactured on	July 05, 2002

DASY5 Validation Report for Head TSL

Date: 04.03.2014

Test Laboratory: SPEAG, Zurich, Switzerland

DUT: Dipole 2450 MHz; Type: D2450V2; Serial: D2450V2 - SN: 712

Communication System: UID 0 - CW; Frequency: 2450 MHz

Medium parameters used: $f = 2450$ MHz; $\sigma = 1.86$ S/m; $\epsilon_r = 38.1$; $\rho = 1000$ kg/m³

Phantom section: Flat Section

Measurement Standard: DASY5 (IEEE/IEC/ANSI C63.19-2007)

DASY52 Configuration:

- Probe: ES3DV3 - SN3205; ConvF(4.53, 4.53, 4.53); Calibrated: 30.12.2013;
- Sensor-Surface: 3mm (Mechanical Surface Detection)
- Electronics: DAE4 Sn601; Calibrated: 25.04.2013
- Phantom: Flat Phantom 5.0 (front); Type: QD000P50AA; Serial: 1001
- DASY52 52.8.7(1137); SEMCAD X 14.6.10(7164)

Dipole Calibration for Head Tissue/Pin=250 mW, d=10mm/Zoom Scan (7x7x7)/Cube 0:

Measurement grid: dx=5mm, dy=5mm, dz=5mm

Reference Value = 99.26 V/m; Power Drift = 0.05 dB

Peak SAR (extrapolated) = 27.5 W/kg

SAR(1 g) = 13.3 W/kg; SAR(10 g) = 6.16 W/kg

Maximum value of SAR (measured) = 17.0 W/kg

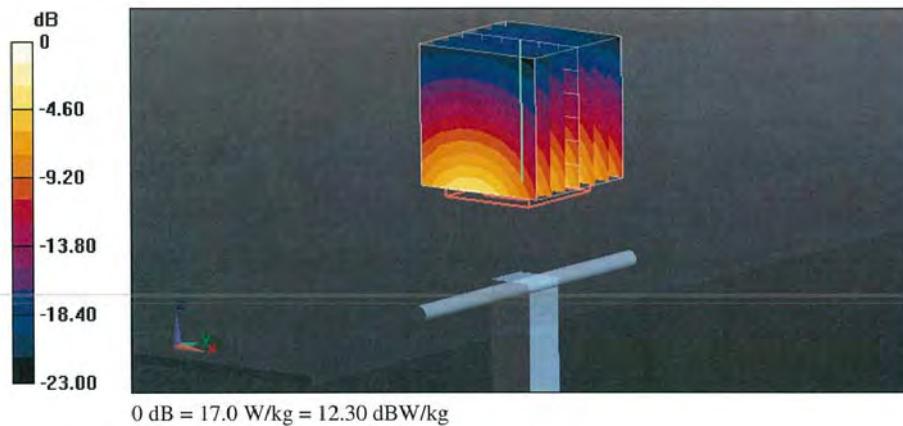



Impedance Measurement Plot for Head TSL

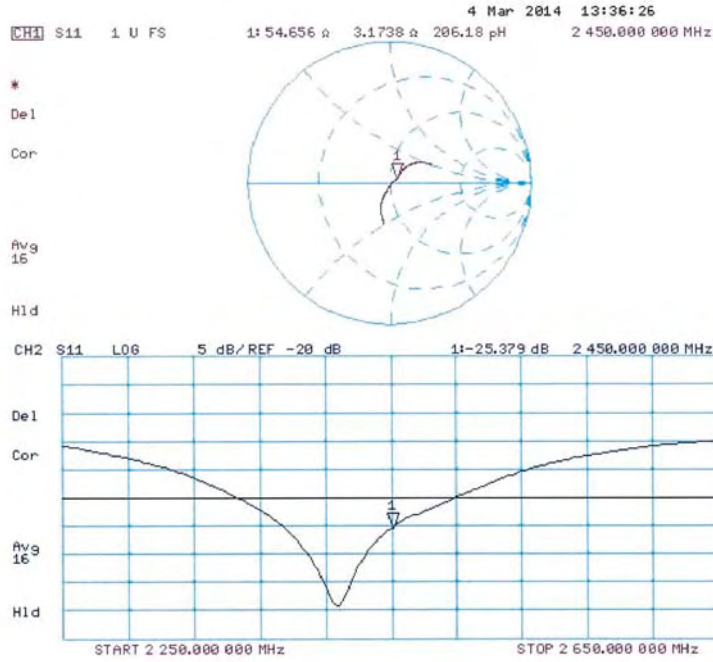

DASY5 Validation Report for Body TSL

Date: 04.03.2014

Test Laboratory: SPEAG, Zurich, Switzerland

DUT: Dipole 2450 MHz; Type: D2450V2; Serial: D2450V2 - SN: 712

Communication System: UID 0 - CW; Frequency: 2450 MHz

Medium parameters used: $f = 2450$ MHz; $\sigma = 2.02$ S/m; $\epsilon_r = 50.7$; $\rho = 1000$ kg/m³

Phantom section: Flat Section

Measurement Standard: DASY5 (IEEE/IEC/ANSI C63.19-2007)

DASY52 Configuration:

- Probe: ES3DV3 - SN3205; ConvF(4.35, 4.35, 4.35); Calibrated: 30.12.2013;
- Sensor-Surface: 3mm (Mechanical Surface Detection)
- Electronics: DAE4 Sn601; Calibrated: 25.04.2013
- Phantom: Flat Phantom 5.0 (back); Type: QD000P50AA; Serial: 1002
- DASY52 52.8.7(1137); SEMCAD X 14.6.10(7164)

Dipole Calibration for Body Tissue/Pin=250 mW, d=10mm/Zoom Scan (7x7x7)/Cube 0:

Measurement grid: dx=5mm, dy=5mm, dz=5mm

Reference Value = 94.771 V/m; Power Drift = 0.01 dB

Peak SAR (extrapolated) = 27.0 W/kg

SAR(1 g) = 12.9 W/kg; SAR(10 g) = 5.96 W/kg

Maximum value of SAR (measured) = 17.1 W/kg

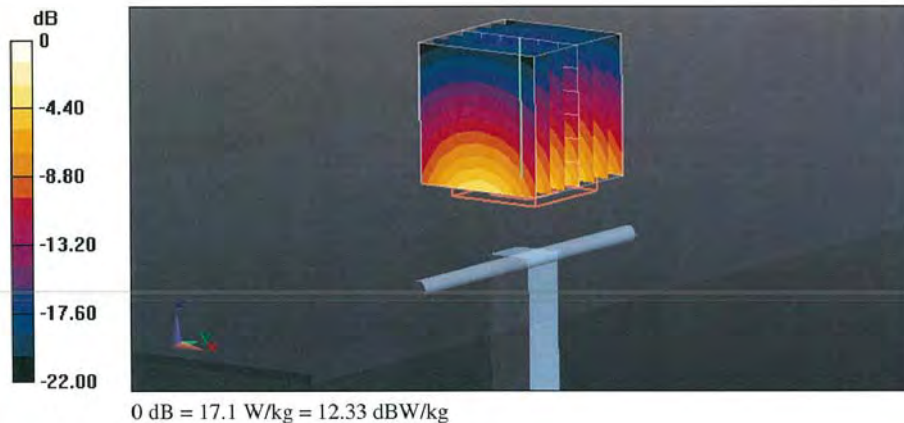



Impedance Measurement Plot for Body TSL

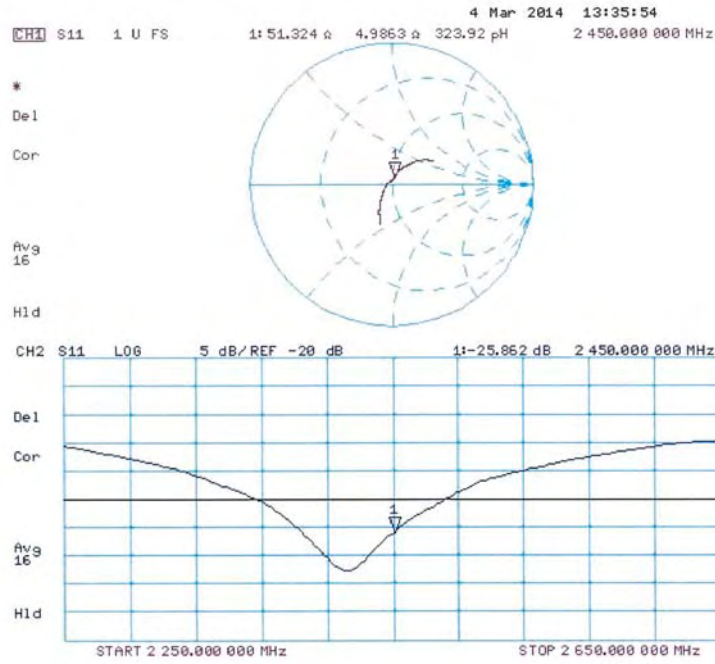



**Calibration Laboratory of
Schmid & Partner
Engineering AG**
Zeughausstrasse 43, 8004 Zurich, Switzerland



S Schweizerischer Kalibrierdienst
C Service suisse d'étalonnage
S Servizio svizzero di taratura
S Swiss Calibration Service

Accredited by the Swiss Accreditation Service (SAS)
The Swiss Accreditation Service is one of the signatories to the EA
Multilateral Agreement for the recognition of calibration certificates

Accreditation No.: **SCS 108**

Client **ATL (Auden)**

Certificate No: **D5GHzV2-1021_Feb14**

CALIBRATION CERTIFICATE

Object: **D5GHzV2 - SN: 1021**

Calibration procedure(s): **QA CAL-22.v2
Calibration procedure for dipole validation kits between 3-6 GHz**

Calibration date: **February 28, 2014**

This calibration certificate documents the traceability to national standards, which realize the physical units of measurements (SI).
The measurements and the uncertainties with confidence probability are given on the following pages and are part of the certificate.

All calibrations have been conducted in the closed laboratory facility: environment temperature (22 ± 3)°C and humidity < 70%.

Calibration Equipment used (M&TE critical for calibration)

Primary Standards	ID #	Cal Date (Certificate No.)	Scheduled Calibration
Power meter EPM-442A	GB37480704	09-Oct-13 (No. 217-01827)	Oct-14
Power sensor HP 8481A	US37292783	09-Oct-13 (No. 217-01827)	Oct-14
Power sensor HP 8481A	MY41092317	09-Oct-13 (No. 217-01828)	Oct-14
Reference 20 dB Attenuator	SN: 5058 (20k)	04-Apr-13 (No. 217-01736)	Apr-14
Type-N mismatch combination	SN: 5047.3 / 06327	04-Apr-13 (No. 217-01739)	Apr-14
Reference Probe EX3DV4	SN: 3503	30-Dec-13 (No. EX3-3503_Dec13)	Dec-14
DAE4	SN: 601	25-Apr-13 (No. DAE4-601_Apr13)	Apr-14
Secondary Standards	ID #	Check Date (in house)	Scheduled Check
RF generator R&S SMT-06	100005	04-Aug-99 (in house check Oct-13)	In house check: Oct-16
Network Analyzer HP 8753E	US37390585 S4206	18-Oct-01 (in house check Oct-13)	In house check: Oct-14

	Name	Function	Signature
Calibrated by:	Jeton Kastrati	Laboratory Technician	
Approved by:	Katja Pokovic	Technical Manager	

Issued: February 28, 2014

This calibration certificate shall not be reproduced except in full without written approval of the laboratory.

Certificate No: D5GHzV2-1021_Feb14

Page 1 of 13



Measurement Conditions

DASY system configuration, as far as not given on page 1.

DASY Version	DASY5	V52.8.7
Extrapolation	Advanced Extrapolation	
Phantom	Modular Flat Phantom V5.0	
Distance Dipole Center - TSL	10 mm	with Spacer
Zoom Scan Resolution	dx, dy = 4.0 mm, dz = 1.4 mm	Graded Ratio = 1.4 (Z direction)
Frequency	5200 MHz ± 1 MHz 5500 MHz ± 1 MHz 5800 MHz ± 1 MHz	

Head TSL parameters at 5200 MHz

The following parameters and calculations were applied.

	Temperature	Permittivity	Conductivity
Nominal Head TSL parameters	22.0 °C	36.0	4.66 mho/m
Measured Head TSL parameters	(22.0 ± 0.2) °C	37.1 ± 6 %	4.52 mho/m ± 6 %
Head TSL temperature change during test	< 0.5 °C	----	----

SAR result with Head TSL at 5200 MHz

SAR averaged over 1 cm³ (1 g) of Head TSL	Condition	
SAR measured	100 mW input power	7.80 W/kg
SAR for nominal Head TSL parameters	normalized to 1W	78.4 W/kg ± 19.9 % (k=2)

SAR averaged over 10 cm³ (10 g) of Head TSL	condition	
SAR measured	100 mW input power	2.23 W/kg
SAR for nominal Head TSL parameters	normalized to 1W	22.4 W/kg ± 19.5 % (k=2)

Head TSL parameters at 5500 MHz

The following parameters and calculations were applied.

	Temperature	Permittivity	Conductivity
Nominal Head TSL parameters	22.0 °C	35.6	4.96 mho/m
Measured Head TSL parameters	(22.0 ± 0.2) °C	36.7 ± 6 %	4.84 mho/m ± 6 %
Head TSL temperature change during test	< 0.5 °C	----	----

SAR result with Head TSL at 5500 MHz

SAR averaged over 1 cm³ (1 g) of Head TSL	Condition	
SAR measured	100 mW input power	8.51 W/kg
SAR for nominal Head TSL parameters	normalized to 1W	85.5 W / kg ± 19.9 % (k=2)

SAR averaged over 10 cm³ (10 g) of Head TSL	condition	
SAR measured	100 mW input power	2.42 W/kg
SAR for nominal Head TSL parameters	normalized to 1W	24.4 W/kg ± 19.5 % (k=2)



Head TSL parameters at 5800 MHz

The following parameters and calculations were applied.

	Temperature	Permittivity	Conductivity
Nominal Head TSL parameters	22.0 °C	35.3	5.27 mho/m
Measured Head TSL parameters	(22.0 ± 0.2) °C	36.3 ± 6 %	5.16 mho/m ± 6 %
Head TSL temperature change during test	< 0.5 °C	----	----

SAR result with Head TSL at 5800 MHz

SAR averaged over 1 cm ³ (1 g) of Head TSL	Condition	
SAR measured	100 mW input power	7.85 W/kg
SAR for nominal Head TSL parameters	normalized to 1W	78.9 W/kg ± 19.9 % (k=2)

SAR averaged over 10 cm ³ (10 g) of Head TSL	condition	
SAR measured	100 mW input power	2.23 W/kg
SAR for nominal Head TSL parameters	normalized to 1W	22.4 W/kg ± 19.5 % (k=2)

**Calibration Laboratory of
Schmid & Partner
Engineering AG**
Zeughausstrasse 43, 8004 Zurich, Switzerland



S Schweizerischer Kalibrierdienst
C Service suisse d'étalonnage
S Servizio svizzero di taratura
S Swiss Calibration Service

Accredited by the Swiss Accreditation Service (SAS)
The Swiss Accreditation Service is one of the signatories to the EA
Multilateral Agreement for the recognition of calibration certificates

Accreditation No.: **SCS 108**

Glossary:

TSL tissue simulating liquid
ConvF sensitivity in TSL / NORM x,y,z
N/A not applicable or not measured

Calibration is Performed According to the Following Standards:

- a) IEC 62209-2, "Evaluation of Human Exposure to Radio Frequency Fields from Handheld and Body-Mounted Wireless Communication Devices in the Frequency Range of 30 MHz to 6 GHz: Human models, Instrumentation, and Procedures"; Part 2: "Procedure to determine the Specific Absorption Rate (SAR) for including accessories and multiple transmitters", March 2010
- b) KDB 865664, "SAR Measurement Requirements for 100 MHz to 6 GHz"
- c) IEEE Std 1528-2013, "IEEE Recommended Practice for Determining the Peak Spatial-Averaged Specific Absorption Rate (SAR) in the Human Head from Wireless Communications Devices: Measurement Techniques", June 2013

Additional Documentation:

- d) DASY4/5 System Handbook

Methods Applied and Interpretation of Parameters:

- *Measurement Conditions:* Further details are available from the Validation Report at the end of the certificate. All figures stated in the certificate are valid at the frequency indicated.
- *Antenna Parameters with TSL:* The dipole is mounted with the spacer to position its feed point exactly below the center marking of the flat phantom section, with the arms oriented parallel to the body axis.
- *Feed Point Impedance and Return Loss:* These parameters are measured with the dipole positioned under the liquid filled phantom. The impedance stated is transformed from the measurement at the SMA connector to the feed point. The Return Loss ensures low reflected power. No uncertainty required.
- *Electrical Delay:* One-way delay between the SMA connector and the antenna feed point. No uncertainty required.
- *SAR measured:* SAR measured at the stated antenna input power.
- *SAR normalized:* SAR as measured, normalized to an input power of 1 W at the antenna connector.
- *SAR for nominal TSL parameters:* The measured TSL parameters are used to calculate the nominal SAR result.

The reported uncertainty of measurement is stated as the standard uncertainty of measurement multiplied by the coverage factor $k=2$, which for a normal distribution corresponds to a coverage probability of approximately 95%.



Body TSL parameters at 5200 MHz

The following parameters and calculations were applied.

	Temperature	Permittivity	Conductivity
Nominal Body TSL parameters	22.0 °C	49.0	5.30 mho/m
Measured Body TSL parameters	(22.0 ± 0.2) °C	47.8 ± 6 %	5.40 mho/m ± 6 %
Body TSL temperature change during test	< 0.5 °C	----	----

SAR result with Body TSL at 5200 MHz

SAR averaged over 1 cm ³ (1 g) of Body TSL	Condition	
SAR measured	100 mW input power	7.44 W/kg
SAR for nominal Body TSL parameters	normalized to 1W	74.1 W/kg ± 19.9 % (k=2)

SAR averaged over 10 cm ³ (10 g) of Body TSL	condition	
SAR measured	100 mW input power	2.07 W/kg
SAR for nominal Body TSL parameters	normalized to 1W	20.6 W/kg ± 19.5 % (k=2)

Body TSL parameters at 5500 MHz

The following parameters and calculations were applied.

	Temperature	Permittivity	Conductivity
Nominal Body TSL parameters	22.0 °C	48.6	5.65 mho/m
Measured Body TSL parameters	(22.0 ± 0.2) °C	47.3 ± 6 %	5.80 mho/m ± 6 %
Body TSL temperature change during test	< 0.5 °C	----	----

SAR result with Body TSL at 5500 MHz

SAR averaged over 1 cm ³ (1 g) of Body TSL	Condition	
SAR measured	100 mW input power	7.97 W/kg
SAR for nominal Body TSL parameters	normalized to 1W	79.3 W/kg ± 19.9 % (k=2)

SAR averaged over 10 cm ³ (10 g) of Body TSL	condition	
SAR measured	100 mW input power	2.21 W/kg
SAR for nominal Body TSL parameters	normalized to 1W	22.0 W/kg ± 19.5 % (k=2)



Body TSL parameters at 5800 MHz

The following parameters and calculations were applied.

	Temperature	Permittivity	Conductivity
Nominal Body TSL parameters	22.0 °C	48.2	6.00 mho/m
Measured Body TSL parameters	(22.0 ± 0.2) °C	46.8 ± 6 %	6.21 mho/m ± 6 %
Body TSL temperature change during test	< 0.5 °C	----	----

SAR result with Body TSL at 5800 MHz

SAR averaged over 1 cm ³ (1 g) of Body TSL	Condition	
SAR measured	100 mW input power	7.44 W/kg
SAR for nominal Body TSL parameters	normalized to 1W	74.1 W/kg ± 19.9 % (k=2)

SAR averaged over 10 cm ³ (10 g) of Body TSL	condition	
SAR measured	100 mW input power	2.05 W/kg
SAR for nominal Body TSL parameters	normalized to 1W	20.4 W/kg ± 19.5 % (k=2)



Appendix

Antenna Parameters with Head TSL at 5200 MHz

Impedance, transformed to feed point	51.3 Ω - 7.7 j Ω
Return Loss	- 22.3 dB

Antenna Parameters with Head TSL at 5500 MHz

Impedance, transformed to feed point	52.7 Ω - 2.3 j Ω
Return Loss	- 29.3 dB

Antenna Parameters with Head TSL at 5800 MHz

Impedance, transformed to feed point	57.8 Ω - 0.4 j Ω
Return Loss	- 22.8 dB

Antenna Parameters with Body TSL at 5200 MHz

Impedance, transformed to feed point	50.3 Ω - 7.4 j Ω
Return Loss	- 22.6 dB

Antenna Parameters with Body TSL at 5500 MHz

Impedance, transformed to feed point	52.1 Ω - 1.3 j Ω
Return Loss	- 32.3 dB

Antenna Parameters with Body TSL at 5800 MHz

Impedance, transformed to feed point	57.8 Ω + 1.1 j Ω
Return Loss	- 22.7 dB

General Antenna Parameters and Design

Electrical Delay (one direction)	1.200 ns
----------------------------------	----------

After long term use with 100W radiated power, only a slight warming of the dipole near the feedpoint can be measured.

The dipole is made of standard semirigid coaxial cable. The center conductor of the feeding line is directly connected to the second arm of the dipole. The antenna is therefore short-circuited for DC-signals. On some of the dipoles, small end caps are added to the dipole arms in order to improve matching when loaded according to the position as explained in the "Measurement Conditions" paragraph. The SAR data are not affected by this change. The overall dipole length is still according to the Standard.

No excessive force must be applied to the dipole arms, because they might bend or the soldered connections near the feedpoint may be damaged.

Additional EUT Data

Manufactured by	SPEAG
Manufactured on	February 05, 2004



DASY5 Validation Report for Head TSL

Date: 28.02.2014

Test Laboratory: SPEAG, Zurich, Switzerland

DUT: Dipole 5GHz; Type: D5GHzV2; Serial: D5GHzV2 - SN: 1021

Communication System: UID 0 - CW; Frequency: 5200 MHz, Frequency: 5500 MHz, Frequency: 5800 MHz
Medium parameters used: $f = 5200$ MHz; $\sigma = 4.52$ S/m; $\epsilon_r = 37.1$; $\rho = 1000$ kg/m³, Medium parameters used: $f = 5500$ MHz; $\sigma = 4.84$ S/m; $\epsilon_r = 36.7$; $\rho = 1000$ kg/m³, Medium parameters used: $f = 5800$ MHz; $\sigma = 5.16$ S/m; $\epsilon_r = 36.3$; $\rho = 1000$ kg/m³
Phantom section: Flat Section
Measurement Standard: DASY5 (IEEE/IEC/ANSI C63.19-2007)

DASY52 Configuration:

- Probe: EX3DV4 - SN3503; ConvF(5.52, 5.52, 5.52); Calibrated: 30.12.2013, ConvF(5.01, 5.01, 5.01); Calibrated: 30.12.2013, ConvF(4.91, 4.91, 4.91); Calibrated: 30.12.2013;
- Sensor-Surface: 1.4mm (Mechanical Surface Detection)
- Electronics: DAE4 Sn601; Calibrated: 25.04.2013
- Phantom: Flat Phantom 5.0 (front); Type: QD000P50AA; Serial: 1001
- DASY52 52.8.7(1137); SEMCAD X 14.6.10(7164)

Dipole Calibration for Head Tissue/Pin=100mW, dist=10mm, f=5200 MHz/Zoom Scan, dist=1.4mm (8x8x7)/Cube 0: Measurement grid: dx=4mm, dy=4mm, dz=1.4mm
Reference Value = 63.152 V/m; Power Drift = 0.03 dB
Peak SAR (extrapolated) = 28.6 W/kg
SAR(1 g) = 7.8 W/kg; SAR(10 g) = 2.23 W/kg
Maximum value of SAR (measured) = 17.7 W/kg

Dipole Calibration for Head Tissue/Pin=100mW, dist=10mm, f=5500 MHz/Zoom Scan, dist=1.4mm (8x8x7)/Cube 0: Measurement grid: dx=4mm, dy=4mm, dz=1.4mm
Reference Value = 64.092 V/m; Power Drift = 0.03 dB
Peak SAR (extrapolated) = 33.5 W/kg
SAR(1 g) = 8.51 W/kg; SAR(10 g) = 2.42 W/kg
Maximum value of SAR (measured) = 19.9 W/kg

Dipole Calibration for Head Tissue/Pin=100mW, dist=10mm, f=5800 MHz/Zoom Scan, dist=1.4mm (8x8x7)/Cube 0: Measurement grid: dx=4mm, dy=4mm, dz=1.4mm
Reference Value = 60.166 V/m; Power Drift = 0.04 dB
Peak SAR (extrapolated) = 32.8 W/kg
SAR(1 g) = 7.85 W/kg; SAR(10 g) = 2.23 W/kg
Maximum value of SAR (measured) = 18.8 W/kg

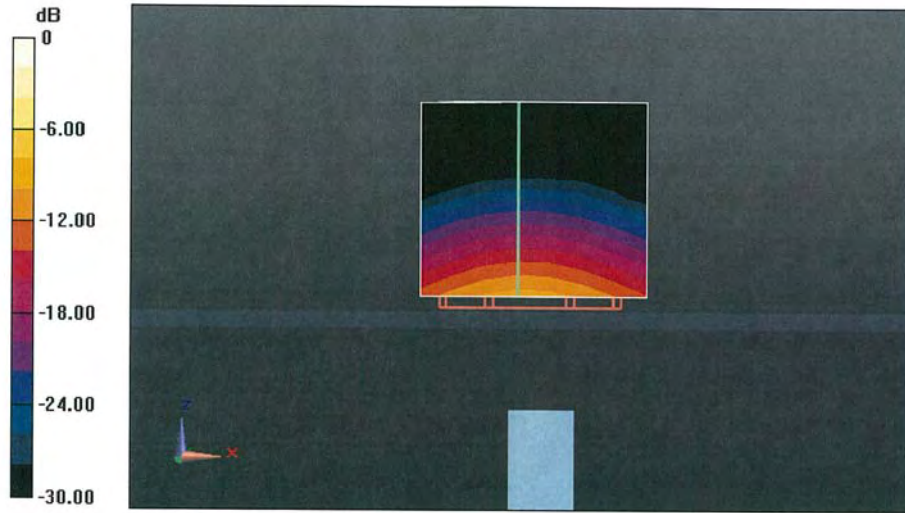

0 dB = 18.8 W/kg = 12.74 dBW/kg



Impedance Measurement Plot for Head TSL

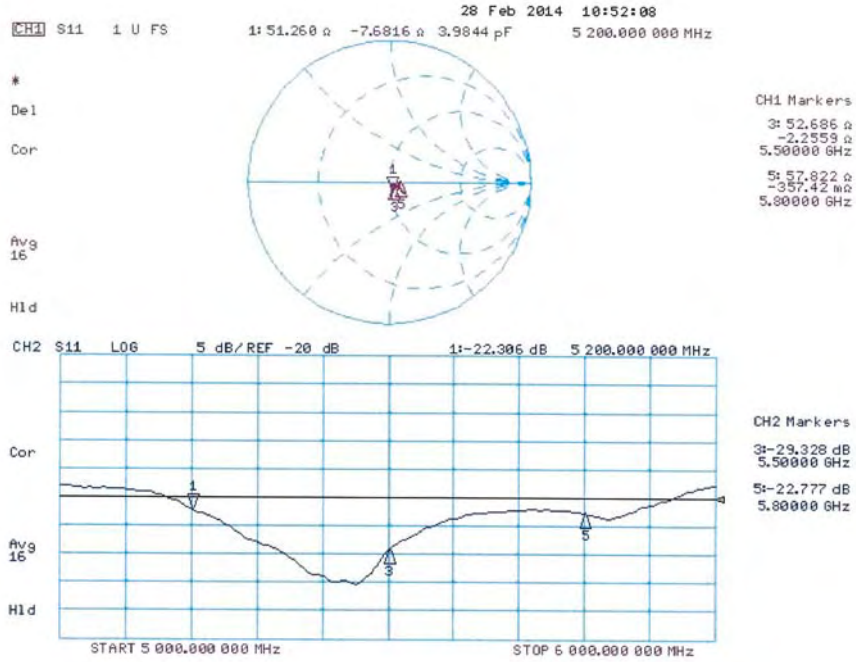



DASY5 Validation Report for Body TSL

Date: 25.02.2014

Test Laboratory: SPEAG, Zurich, Switzerland

DUT: Dipole 5GHz; Type: D5GHzV2; Serial: D5GHzV2 - SN: 1021

Communication System: UID 0 - CW; Frequency: 5200 MHz, Frequency: 5500 MHz, Frequency: 5800 MHz
Medium parameters used: $f = 5200$ MHz; $\sigma = 5.4$ S/m; $\epsilon_r = 47.8$; $\rho = 1000$ kg/m³, Medium parameters used:
 $f = 5500$ MHz; $\sigma = 5.8$ S/m; $\epsilon_r = 47.3$; $\rho = 1000$ kg/m³, Medium parameters used: $f = 5800$ MHz; $\sigma = 6.21$
S/m; $\epsilon_r = 46.8$; $\rho = 1000$ kg/m³
Phantom section: Flat Section
Measurement Standard: DASY5 (IEEE/IEC/ANSI C63.19-2007)

DASY52 Configuration:

- Probe: EX3DV4 - SN3503; ConvF(5.01, 5.01, 5.01); Calibrated: 30.12.2013, ConvF(4.52, 4.52, 4.52); Calibrated: 30.12.2013, ConvF(4.47, 4.47, 4.47); Calibrated: 30.12.2013;
- Sensor-Surface: 1.4mm (Mechanical Surface Detection)
- Electronics: DAE4 Sn601; Calibrated: 25.04.2013
- Phantom: Flat Phantom 5.0 (back); Type: QD000P50AA; Serial: 1002
- DASY52 52.8.7(1137); SEMCAD X 14.6.10(7164)

Dipole Calibration for Body Tissue/Pin=100mW, dist=10mm, f=5200 MHz/Zoom Scan, dist=1.4mm (8x8x7)/Cube 0: Measurement grid: dx=4mm, dy=4mm, dz=1.4mm
Reference Value = 58.426 V/m; Power Drift = -0.01 dB
Peak SAR (extrapolated) = 29.6 W/kg
SAR(1 g) = 7.44 W/kg; SAR(10 g) = 2.07 W/kg
Maximum value of SAR (measured) = 17.3 W/kg

Dipole Calibration for Body Tissue/Pin=100mW, dist=10mm, f=5500 MHz/Zoom Scan, dist=1.4mm (8x8x7)/Cube 0: Measurement grid: dx=4mm, dy=4mm, dz=1.4mm
Reference Value = 58.336 V/m; Power Drift = 0.03 dB
Peak SAR (extrapolated) = 34.5 W/kg
SAR(1 g) = 7.97 W/kg; SAR(10 g) = 2.21 W/kg
Maximum value of SAR (measured) = 18.9 W/kg

Dipole Calibration for Body Tissue/Pin=100mW, dist=10mm, f=5800 MHz/Zoom Scan, dist=1.4mm (8x8x7)/Cube 0: Measurement grid: dx=4mm, dy=4mm, dz=1.4mm
Reference Value = 54.681 V/m; Power Drift = 0.02 dB
Peak SAR (extrapolated) = 34.9 W/kg
SAR(1 g) = 7.44 W/kg; SAR(10 g) = 2.05 W/kg
Maximum value of SAR (measured) = 18.3 W/kg

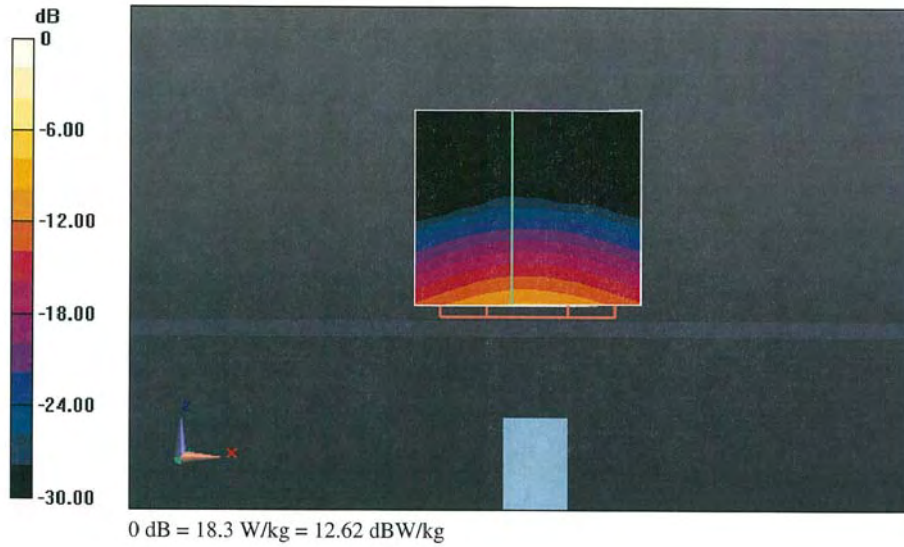



Impedance Measurement Plot for Body TSL

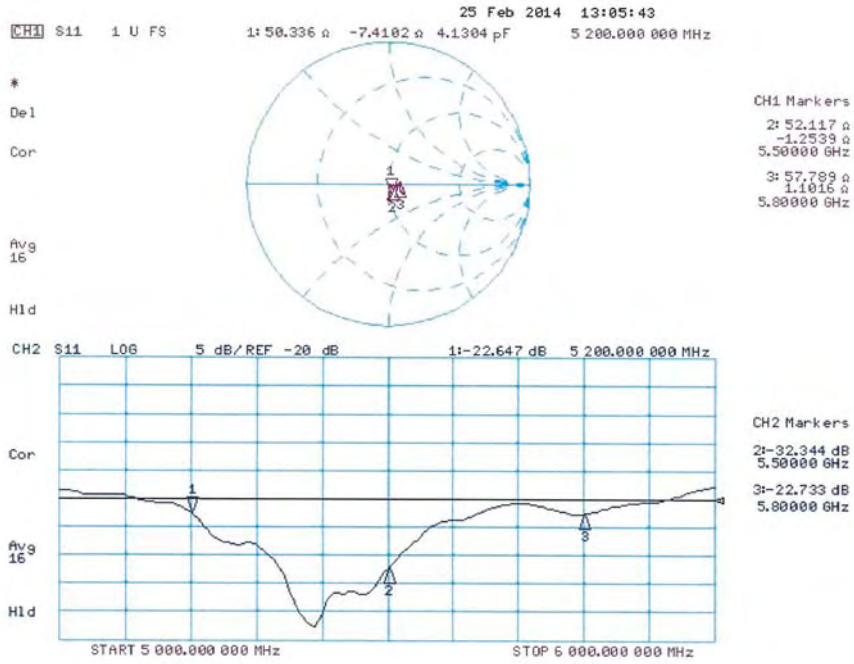



**Calibration Laboratory of
Schmid & Partner
Engineering AG**
Zeughausstrasse 43, 8004 Zurich, Switzerland



S Schweizerischer Kalibrierdienst
C Service suisse d'étalonnage
S Servizio svizzero di taratura
S Swiss Calibration Service

Accredited by the Swiss Accreditation Service (SAS)
The Swiss Accreditation Service is one of the signatories to the EA
Multilateral Agreement for the recognition of calibration certificates

Accreditation No.: **SCS 108**

Client **ATL (Auden)**

Certificate No: **EX3-3977_Feb14**

CALIBRATION CERTIFICATE

Object: **EX3DV4 - SN:3977**

Calibration procedure(s): **QA CAL-01.v9, QA CAL-12.v9, QA CAL-14.v4, QA CAL-23.v5,
QA CAL-25.v6
Calibration procedure for dosimetric E-field probes**

Calibration date: **February 17, 2014**

This calibration certificate documents the traceability to national standards, which realize the physical units of measurements (SI).
The measurements and the uncertainties with confidence probability are given on the following pages and are part of the certificate.

All calibrations have been conducted in the closed laboratory facility: environment temperature (22 ± 3)°C and humidity < 70%.

Calibration Equipment used (M&TE critical for calibration)

Primary Standards	ID	Cal Date (Certificate No.)	Scheduled Calibration
Power meter E4419B	GB41293874	04-Apr-13 (No. 217-01733)	Apr-14
Power sensor E4412A	MY41498087	04-Apr-13 (No. 217-01733)	Apr-14
Reference 3 dB Attenuator	SN: S5054 (3c)	04-Apr-13 (No. 217-01737)	Apr-14
Reference 20 dB Attenuator	SN: S5277 (20x)	04-Apr-13 (No. 217-01735)	Apr-14
Reference 30 dB Attenuator	SN: S5129 (30b)	04-Apr-13 (No. 217-01738)	Apr-14
Reference Probe ES3DV2	SN: 3013	30-Dec-13 (No. ES3-3013_Dec13)	Dec-14
DAE4	SN: 660	13-Dec-13 (No. DAE4-660_Dec13)	Dec-14
Secondary Standards	ID	Check Date (in house)	Scheduled Check
RF generator HP 8648C	US3642U01700	4-Aug-99 (in house check Apr-13)	In house check: Apr-16
Network Analyzer HP 8753E	US37390585	18-Oct-01 (in house check Oct-13)	In house check: Oct-14

	Name	Function	Signature
Calibrated by:	Jeton Kastrati	Laboratory Technician	
Approved by:	Katja Pokovic	Technical Manager	

Issued: February 19, 2014

This calibration certificate shall not be reproduced except in full without written approval of the laboratory.

Calibration Laboratory of
Schmid & Partner
Engineering AG
 Zeughausstrasse 43, 8004 Zurich, Switzerland



S Schweizerischer Kalibrierdienst
C Service suisse d'étalonnage
S Servizio svizzero di taratura
S Swiss Calibration Service

Accredited by the Swiss Accreditation Service (SAS)
 The Swiss Accreditation Service is one of the signatories to the EA
 Multilateral Agreement for the recognition of calibration certificates

Accreditation No.: **SCS 108**

Glossary:

TSL	tissue simulating liquid
NORM _{x,y,z}	sensitivity in free space
ConvF	sensitivity in TSL / NORM _{x,y,z}
DCP	diode compression point
CF	crest factor (1/duty_cycle) of the RF signal
A, B, C, D	modulation dependent linearization parameters
Polarization φ	φ rotation around probe axis
Polarization θ	θ rotation around an axis that is in the plane normal to probe axis (at measurement center), i.e., θ = 0 is normal to probe axis
Connector Angle	information used in DASY system to align probe sensor X to the robot coordinate system

Calibration is Performed According to the Following Standards:

- a) IEEE Std 1528-2013, "IEEE Recommended Practice for Determining the Peak Spatial-Averaged Specific Absorption Rate (SAR) in the Human Head from Wireless Communications Devices: Measurement Techniques", June 2013
- b) IEC 62209-1, "Procedure to measure the Specific Absorption Rate (SAR) for hand-held devices used in close proximity to the ear (frequency range of 300 MHz to 3 GHz)", February 2005

Methods Applied and Interpretation of Parameters:

- *NORM_{x,y,z}*: Assessed for E-field polarization θ = 0 (f ≤ 900 MHz in TEM-cell; f > 1800 MHz: R22 waveguide). *NORM_{x,y,z}* are only intermediate values, i.e., the uncertainties of *NORM_{x,y,z}* does not affect the E²-field uncertainty inside TSL (see below *ConvF*).
- *NORM(f)_{x,y,z}* = *NORM_{x,y,z}* * *frequency_response* (see Frequency Response Chart). This linearization is implemented in DASY4 software versions later than 4.2. The uncertainty of the frequency response is included in the stated uncertainty of *ConvF*.
- *DCP_{x,y,z}*: DCP are numerical linearization parameters assessed based on the data of power sweep with CW signal (no uncertainty required). DCP does not depend on frequency nor media.
- *PAR*: PAR is the Peak to Average Ratio that is not calibrated but determined based on the signal characteristics
- *A_{x,y,z}; B_{x,y,z}; C_{x,y,z}; D_{x,y,z}; VR_{x,y,z}*: A, B, C, D are numerical linearization parameters assessed based on the data of power sweep for specific modulation signal. The parameters do not depend on frequency nor media. VR is the maximum calibration range expressed in RMS voltage across the diode.
- *ConvF and Boundary Effect Parameters*: Assessed in flat phantom using E-field (or Temperature Transfer Standard for f ≤ 800 MHz) and inside waveguide using analytical field distributions based on power measurements for f > 800 MHz. The same setups are used for assessment of the parameters applied for boundary compensation (alpha, depth) of which typical uncertainty values are given. These parameters are used in DASY4 software to improve probe accuracy close to the boundary. The sensitivity in TSL corresponds to *NORM_{x,y,z}* * *ConvF* whereby the uncertainty corresponds to that given for *ConvF*. A frequency dependent *ConvF* is used in DASY version 4.4 and higher which allows extending the validity from ± 50 MHz to ± 100 MHz.
- *Spherical isotropy (3D deviation from isotropy)*: in a field of low gradients realized using a flat phantom exposed by a patch antenna.
- *Sensor Offset*: The sensor offset corresponds to the offset of virtual measurement center from the probe tip (on probe axis). No tolerance required.
- *Connector Angle*: The angle is assessed using the information gained by determining the *NORM_x* (no uncertainty required).



EX3DV4 – SN:3977

February 17, 2014

Probe EX3DV4

SN:3977

Manufactured: November 5, 2013
Calibrated: February 17, 2014

Calibrated for DASY/EASY Systems
(Note: non-compatible with DASY2 system!)



EX3DV4-- SN:3977

February 17, 2014

DASY/EASY - Parameters of Probe: EX3DV4 - SN:3977

Basic Calibration Parameters

	Sensor X	Sensor Y	Sensor Z	Unc (k=2)
Norm ($\mu\text{V}/(\text{V}/\text{m})^2$) ^A	0.54	0.57	0.54	$\pm 10.1 \%$
DCP (mV) ^B	99.5	100.0	99.7	

Modulation Calibration Parameters

UID	Communication System Name		A dB	B dB $\sqrt{\mu\text{V}}$	C	D dB	VR mV	Unc ^E (k=2)
0	CW	X	0.0	0.0	1.0	0.00	133.3	$\pm 3.3 \%$
		Y	0.0	0.0	1.0		134.9	
		Z	0.0	0.0	1.0		146.5	

The reported uncertainty of measurement is stated as the standard uncertainty of measurement multiplied by the coverage factor k=2, which for a normal distribution corresponds to a coverage probability of approximately 95%.

^A The uncertainties of NormX,Y,Z do not affect the E²-field uncertainty inside TSL (see Pages 5 and 6).

^B Numerical linearization parameter: uncertainty not required.

^E Uncertainty is determined using the max. deviation from linear response applying rectangular distribution and is expressed for the square of the field value.



EX3DV4- SN:3977

February 17, 2014

DASY/EASY - Parameters of Probe: EX3DV4 - SN:3977

Calibration Parameter Determined in Head Tissue Simulating Media

f (MHz) ^C	Relative Permittivity ^F	Conductivity (S/m) ^F	ConvF X	ConvF Y	ConvF Z	Alpha ^G	Depth (mm) ^G	Unct. (k=2)
450	43.5	0.87	11.72	11.72	11.72	0.18	1.10	± 13.3 %
750	41.9	0.89	9.98	9.98	9.98	0.36	0.88	± 12.0 %
835	41.5	0.90	9.62	9.62	9.62	0.61	0.69	± 12.0 %
900	41.5	0.97	9.48	9.48	9.48	0.77	0.63	± 12.0 %
1750	40.1	1.37	8.14	8.14	8.14	0.78	0.60	± 12.0 %
1900	40.0	1.40	7.97	7.97	7.97	0.48	0.75	± 12.0 %
2000	40.0	1.40	7.93	7.93	7.93	0.69	0.63	± 12.0 %
2300	39.5	1.67	7.59	7.59	7.59	0.37	0.83	± 12.0 %
2450	39.2	1.80	7.24	7.24	7.24	0.27	1.10	± 12.0 %
2600	39.0	1.96	7.07	7.07	7.07	0.41	0.84	± 12.0 %
5200	36.0	4.66	5.09	5.09	5.09	0.35	1.80	± 13.1 %
5300	35.9	4.76	4.82	4.82	4.82	0.35	1.80	± 13.1 %
5500	35.6	4.96	4.76	4.76	4.76	0.35	1.80	± 13.1 %
5600	35.5	5.07	4.55	4.55	4.55	0.40	1.80	± 13.1 %
5800	35.3	5.27	4.52	4.52	4.52	0.40	1.80	± 13.1 %

^C Frequency validity of ± 100 MHz only applies for DASY v4.4 and higher (see Page 2), else it is restricted to ± 50 MHz. The uncertainty is the RSS of the ConvF uncertainty at calibration frequency and the uncertainty for the indicated frequency band.

^F At frequencies below 3 GHz, the validity of tissue parameters (ϵ and σ) can be relaxed to ± 10% if liquid compensation formula is applied to measured SAR values. At frequencies above 3 GHz, the validity of tissue parameters (ϵ and σ) is restricted to ± 5%. The uncertainty is the RSS of the ConvF uncertainty for indicated target tissue parameters.

^G Alpha/Depth are determined during calibration. SPEAG warrants that the remaining deviation due to the boundary effect after compensation is always less than ± 1% for frequencies below 3 GHz and below ± 2% for frequencies between 3-6 GHz at any distance larger than half the probe tip diameter from the boundary.



EX3DV4- SN:3977

February 17, 2014

DASY/EASY - Parameters of Probe: EX3DV4 - SN:3977

Calibration Parameter Determined in Body Tissue Simulating Media

f (MHz) ^C	Relative Permittivity ^F	Conductivity (S/m) ^F	ConvF X	ConvF Y	ConvF Z	Alpha ^G	Depth (mm) ^G	Unct. (k=2)
450	56.7	0.94	12.47	12.47	12.47	0.11	1.10	± 13.3 %
750	55.5	0.96	9.78	9.78	9.78	0.45	0.86	± 12.0 %
835	55.2	0.97	9.74	9.74	9.74	0.48	0.83	± 12.0 %
900	55.0	1.05	9.46	9.46	9.46	0.41	0.89	± 12.0 %
1750	53.4	1.49	7.69	7.69	7.69	0.41	0.88	± 12.0 %
1900	53.3	1.52	7.37	7.37	7.37	0.34	0.89	± 12.0 %
2000	53.3	1.52	7.41	7.41	7.41	0.24	1.14	± 12.0 %
2300	52.9	1.81	7.12	7.12	7.12	0.66	0.64	± 12.0 %
2450	52.7	1.95	6.97	6.97	6.97	0.80	0.50	± 12.0 %
2600	52.5	2.16	6.68	6.68	6.68	0.80	0.50	± 12.0 %
5200	49.0	5.30	4.50	4.50	4.50	0.45	1.90	± 13.1 %
5300	48.9	5.42	4.28	4.28	4.28	0.45	1.90	± 13.1 %
5500	48.6	5.65	4.02	4.02	4.02	0.45	1.90	± 13.1 %
5600	48.5	5.77	3.87	3.87	3.87	0.45	1.90	± 13.1 %
5800	48.2	6.00	4.12	4.12	4.12	0.50	1.90	± 13.1 %

^C Frequency validity of ± 100 MHz only applies for DASY v4.4 and higher (see Page 2), else it is restricted to ± 50 MHz. The uncertainty is the RSS of the ConvF uncertainty at calibration frequency and the uncertainty for the indicated frequency band.

^F At frequencies below 3 GHz, the validity of tissue parameters (ϵ and σ) can be relaxed to ± 10% if liquid compensation formula is applied to measured SAR values. At frequencies above 3 GHz, the validity of tissue parameters (ϵ and σ) is restricted to ± 5%. The uncertainty is the RSS of the ConvF uncertainty for indicated target tissue parameters.

^G Alpha/Depth are determined during calibration. SPEAG warrants that the remaining deviation due to the boundary effect after compensation is always less than ± 1% for frequencies below 3 GHz and below ± 2% for frequencies between 3-6 GHz at any distance larger than half the probe tip diameter from the boundary.



EX3DV4- SN:3977

February 17, 2014

Frequency Response of E-Field (TEM-Cell:ifi110 EXX, Waveguide: R22)

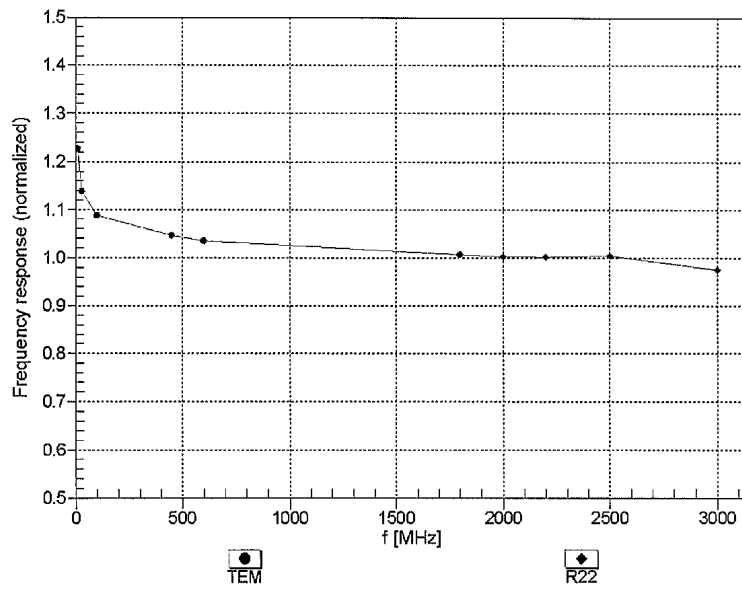

Uncertainty of Frequency Response of E-field: $\pm 6.3\%$ (k=2)

Receiving Pattern (ϕ), $\theta = 0^\circ$

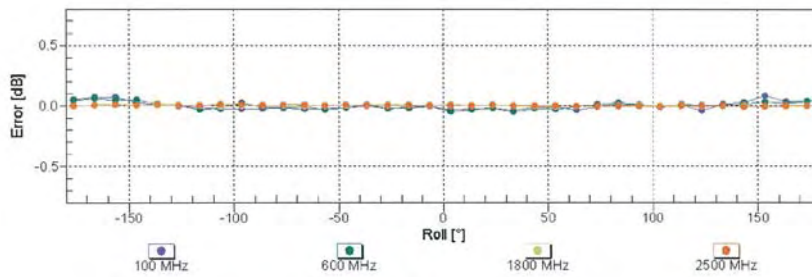
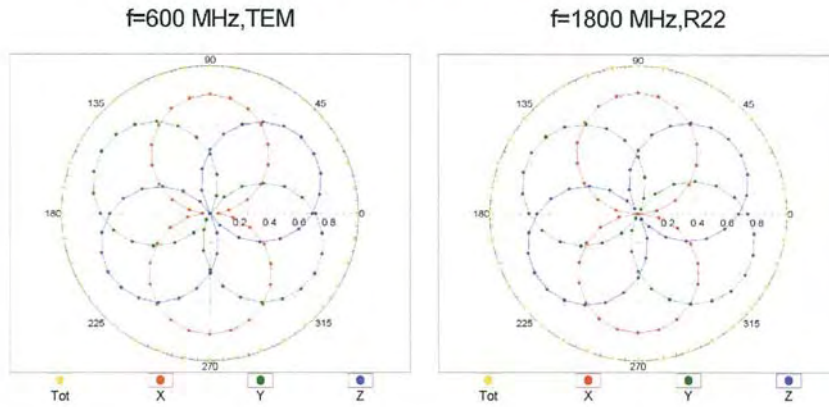

Uncertainty of Axial Isotropy Assessment: $\pm 0.5\%$ ($k=2$)

Dynamic Range f(SAR_{head}) (TEM cell , f_{eval}= 1900 MHz)

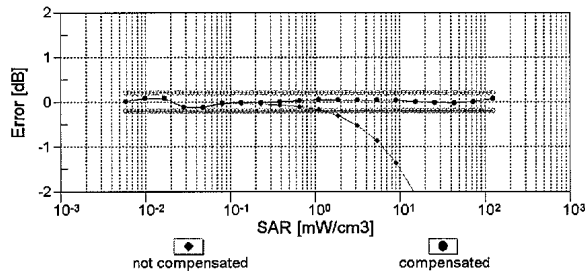
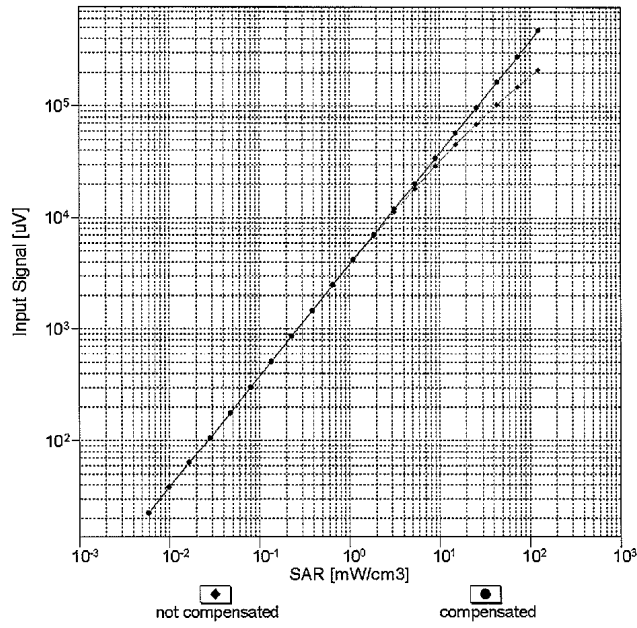

Uncertainty of Linearity Assessment: ± 0.6% (k=2)

Conversion Factor Assessment

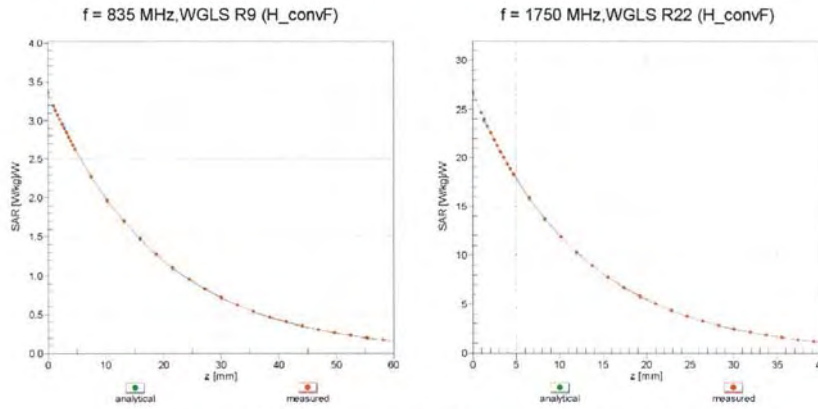

Deviation from Isotropy in Liquid Error (ϕ, θ), f = 900 MHz

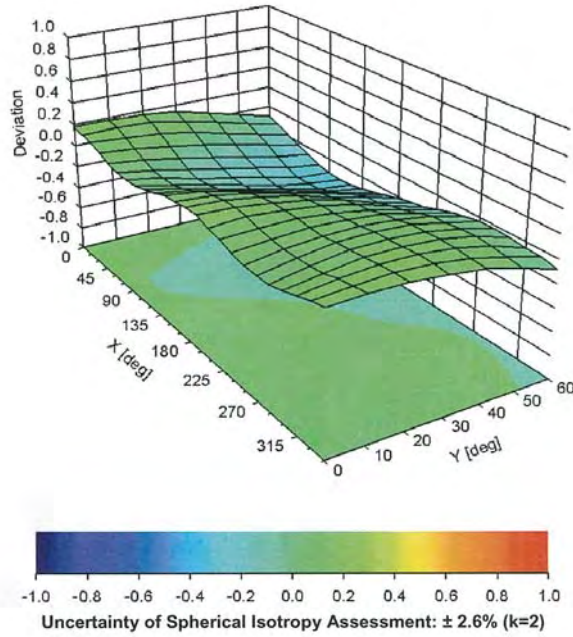



EX3DV4- SN:3977

February 17, 2014

DASY/EASY - Parameters of Probe: EX3DV4 - SN:3977

Other Probe Parameters

Sensor Arrangement	Triangular
Connector Angle (°)	23.6
Mechanical Surface Detection Mode	enabled
Optical Surface Detection Mode	disabled
Probe Overall Length	337 mm
Probe Body Diameter	10 mm
Tip Length	9 mm
Tip Diameter	2.5 mm
Probe Tip to Sensor X Calibration Point	1 mm
Probe Tip to Sensor Y Calibration Point	1 mm
Probe Tip to Sensor Z Calibration Point	1 mm
Recommended Measurement Distance from Surface	2 mm



**Calibration Laboratory of
Schmid & Partner
Engineering AG**
Zeughausstrasse 43, 8004 Zurich, Switzerland



S Schweizerischer Kalibrierdienst
C Service suisse d'étalonnage
S Servizio svizzero di taratura
S Swiss Calibration Service

Accredited by the Swiss Accreditation Service (SAS)
The Swiss Accreditation Service is one of the signatories to the EA
Multilateral Agreement for the recognition of calibration certificates

Accreditation No.: **SCS 108**

Client **ATL (Auden)**

Certificate No: **DAE4-779_Feb14**

CALIBRATION CERTIFICATE

Object: **DAE4 - SD 000 D04 BM - SN: 779**

Calibration procedure(s): **QA CAL-06.v26
Calibration procedure for the data acquisition electronics (DAE)**

Calibration date: **February 25, 2014**

This calibration certificate documents the traceability to national standards, which realize the physical units of measurements (SI).
The measurements and the uncertainties with confidence probability are given on the following pages and are part of the certificate.

All calibrations have been conducted in the closed laboratory facility: environment temperature (22 ± 3)°C and humidity < 70%.

Calibration Equipment used (M&TE critical for calibration)

Primary Standards	ID #	Cal Date (Certificate No.)	Scheduled Calibration
Keithley Multimeter Type 2001	SN: 0810278	01-Oct-13 (No:13976)	Oct-14
Secondary Standards	ID #	Check Date (in house)	Scheduled Check
Auto DAE Calibration Unit	SE UWS 053 AA 1001	07-Jan-14 (in house check)	In house check: Jan-15
Calibrator Box V2.1	SE UMS 006 AA 1002	07-Jan-14 (in house check)	In house check: Jan-15

Calibrated by:	Name	Function	Signature
	R.Mayoraz	Technician	<i>R. Mayoraz</i>
Approved by:	Name	Function	Signature
	Fin Bomholt	Deputy Technical Manager	<i>F. Bomholt</i>

Issued: February 25, 2014

This calibration certificate shall not be reproduced except in full without written approval of the laboratory.

**Calibration Laboratory of
Schmid & Partner
Engineering AG**
Zeughausstrasse 43, 8004 Zurich, Switzerland



S Schweizerischer Kalibrierdienst
C Service suisse d'étalonnage
S Servizio svizzero di taratura
S Swiss Calibration Service

Accredited by the Swiss Accreditation Service (SAS)
The Swiss Accreditation Service is one of the signatories to the EA
Multilateral Agreement for the recognition of calibration certificates

Accreditation No.: **SCS 108**

Glossary

DAE data acquisition electronics
Connector angle information used in DASY system to align probe sensor X to the robot coordinate system.

Methods Applied and Interpretation of Parameters

- *DC Voltage Measurement:* Calibration Factor assessed for use in DASY system by comparison with a calibrated instrument traceable to national standards. The figure given corresponds to the full scale range of the voltmeter in the respective range.
- *Connector angle:* The angle of the connector is assessed measuring the angle mechanically by a tool inserted. Uncertainty is not required.
- The following parameters as documented in the Appendix contain technical information as a result from the performance test and require no uncertainty.
 - *DC Voltage Measurement Linearity:* Verification of the Linearity at +10% and -10% of the nominal calibration voltage. Influence of offset voltage is included in this measurement.
 - *Common mode sensitivity:* Influence of a positive or negative common mode voltage on the differential measurement.
 - *Channel separation:* Influence of a voltage on the neighbor channels not subject to an input voltage.
 - *AD Converter Values with inputs shorted:* Values on the internal AD converter corresponding to zero input voltage
 - *Input Offset Measurement:* Output voltage and statistical results over a large number of zero voltage measurements.
 - *Input Offset Current:* Typical value for information; Maximum channel input offset current, not considering the input resistance.
 - *Input resistance:* Typical value for information: DAE input resistance at the connector, during internal auto-zeroing and during measurement.
 - *Low Battery Alarm Voltage:* Typical value for information. Below this voltage, a battery alarm signal is generated.
 - *Power consumption:* Typical value for information. Supply currents in various operating modes.



DC Voltage Measurement

A/D - Converter Resolution nominal

High Range: 1LSB = 6.1 μ V, full range = -100...+300 mV

Low Range: 1LSB = 61nV, full range = -1.....+3mV

DASY measurement parameters: Auto Zero Time: 3 sec; Measuring time: 3 sec

Calibration Factors	X	Y	Z
High Range	404.515 \pm 0.02% (k=2)	403.757 \pm 0.02% (k=2)	403.978 \pm 0.02% (k=2)
Low Range	3.96916 \pm 1.50% (k=2)	3.98125 \pm 1.50% (k=2)	3.99560 \pm 1.50% (k=2)

Connector Angle

Connector Angle to be used in DASY system	157.5 $^{\circ}$ \pm 1 $^{\circ}$
---	-------------------------------------



Appendix

1. DC Voltage Linearity

High Range	Reading (μV)	Difference (μV)	Error (%)
Channel X + Input	199997.74	1.65	0.00
Channel X + Input	20001.89	1.21	0.01
Channel X - Input	-19997.69	3.10	-0.02
Channel Y + Input	199997.92	2.13	0.00
Channel Y + Input	20001.37	0.80	0.00
Channel Y - Input	-19999.57	1.35	-0.01
Channel Z + Input	199997.09	1.06	0.00
Channel Z + Input	20000.80	0.22	0.00
Channel Z - Input	-19999.23	1.60	-0.01

Low Range	Reading (μV)	Difference (μV)	Error (%)
Channel X + Input	2001.24	0.10	0.01
Channel X + Input	202.08	0.59	0.29
Channel X - Input	-198.10	0.23	-0.11
Channel Y + Input	2001.05	-0.03	-0.00
Channel Y + Input	200.92	-0.52	-0.26
Channel Y - Input	-199.30	-0.92	0.46
Channel Z + Input	2001.25	0.24	0.01
Channel Z + Input	200.66	-0.81	-0.40
Channel Z - Input	-198.77	-0.44	0.22

2. Common mode sensitivity

DASY measurement parameters: Auto Zero Time: 3 sec; Measuring time: 3 sec

	Common mode Input Voltage (mV)	High Range Average Reading (μV)	Low Range Average Reading (μV)
Channel X	200	-3.03	-4.58
	-200	6.11	4.63
Channel Y	200	13.34	13.05
	-200	-15.36	-15.98
Channel Z	200	3.32	2.92
	-200	-3.98	-4.66

3. Channel separation

DASY measurement parameters: Auto Zero Time: 3 sec; Measuring time: 3 sec

	Input Voltage (mV)	Channel X (μV)	Channel Y (μV)	Channel Z (μV)
Channel X	200	-	-1.70	-3.37
Channel Y	200	10.69	-	-1.19
Channel Z	200	7.92	8.10	-



4. AD-Converter Values with inputs shorted

DASY measurement parameters: Auto Zero Time: 3 sec; Measuring time: 3 sec

	High Range (LSB)	Low Range (LSB)
Channel X	15606	14291
Channel Y	15844	15955
Channel Z	16208	16276

5. Input Offset Measurement

DASY measurement parameters: Auto Zero Time: 3 sec; Measuring time: 3 sec

Input 10MΩ

	Average (μV)	min. Offset (μV)	max. Offset (μV)	Std. Deviation (μV)
Channel X	-0.06	-2.42	1.10	0.60
Channel Y	-0.79	-2.62	0.91	0.68
Channel Z	-0.58	-2.53	0.84	0.57

6. Input Offset Current

Nominal Input circuitry offset current on all channels: <25fA

7. Input Resistance (Typical values for information)

	Zeroing (kOhm)	Measuring (MOhm)
Channel X	200	200
Channel Y	200	200
Channel Z	200	200

8. Low Battery Alarm Voltage (Typical values for information)

Typical values	Alarm Level (VDC)
Supply (+ Vcc)	+7.9
Supply (- Vcc)	-7.6

9. Power Consumption (Typical values for information)

Typical values	Switched off (mA)	Stand by (mA)	Transmitting (mA)
Supply (+ Vcc)	+0.01	+6	+14
Supply (- Vcc)	-0.01	-8	-9