

FCC Radio Test Report

FCC ID: IR5DK13

Report No. : BTL-FCCP-1-2004T174
Equipment : Tablet Computer
Model Name : DK13
Brand Name : MilDef Crete Inc.
Applicant : MilDef Crete Inc.
Address : 7F, No. 250, Sec.3, Peishen Rd., Shenkeng District, New Taipei City, Taiwan

Radio Function : Bluetooth EDR

FCC Rule Part(s) : FCC Part15, Subpart C (15.247)
Measurement Procedure(s) : ANSI C63.10-2013

Date of Receipt : 2020/4/30
Date of Test : 2020/4/30 ~ 2020/5/20
Issued Date : 2020/6/12

The above equipment has been tested and found in compliance with the requirement of the above standards by BTL Inc.

Prepared by :

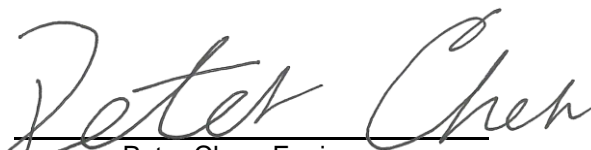
Peter Chen, Engineer

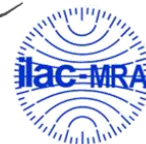

Approved by :

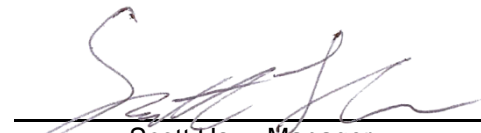
Scott Hsu, Manager

BTL Inc.

No.18, Ln. 171, Sec. 2, Jiuzong Rd., Neihu Dist., Taipei City 114, Taiwan

Tel: +886-2-2657-3299

Fax: +886-2-2657-3331

Web: www.newbtl.com

Declaration

BTL represents to the client that testing is done in accordance with standard procedures as applicable and that test instruments used has been calibrated with standards traceable to international standard(s) and/or national standard(s).

BTL's reports apply only to the specific samples tested under conditions. It is manufacture's responsibility to ensure that additional production units of this model are manufactured with the identical electrical and mechanical components. **BTL** shall have no liability for any declarations, inferences or generalizations drawn by the client or others from **BTL** issued reports.

The report must not be used by the client to claim product certification, approval, or endorsement by NIST, A2LA, or any agency of the U.S. Government.

This report is the confidential property of the client. As a mutual protection to the clients, the public and ourselves, the test report shall not be reproduced, except in full, without our written approval.

BTL's laboratory quality assurance procedures are in compliance with the **ISO/IEC 17025** requirements, and accredited by the conformity assessment authorities listed in this test report.

BTL is not responsible for the sampling stage, so the results only apply to the sample as received.

The information, data and test plan are provided by manufacturer which may affect the validity of results, so it is manufacturer's responsibility to ensure that the apparatus meets the essential requirements of applied standards and in all the possible configurations as representative of its intended use.

Limitation

For the use of the authority's logo is limited unless the Test Standard(s)/Scope(s)/Item(s) mentioned in this test report is (are) included in the conformity assessment authorities acceptance respective.

Please note that the measurement uncertainty is provided for informational purpose only and are not use in determining the Pass/Fail results.

CONTENTS

REPORT ISSUED HISTORY	4
1 SUMMARY OF TEST RESULTS	5
1.1 TEST FACILITY	6
1.2 MEASUREMENT UNCERTAINTY	6
1.3 TEST ENVIRONMENT CONDITIONS	6
2 GENERAL INFORMATION	7
2.1 DESCRIPTION OF EUT	7
2.2 DECLARATION BY THE MANUFACTURER	9
2.3 INFORMATION ABOUT THE FHSS CHARACTERISTICS:	9
2.4 TEST MODES	10
2.5 BLOCK DIAGRAM SHOWING THE CONFIGURATION OF SYSTEM TESTED	11
2.6 SUPPORT UNITS	11
3 AC POWER LINE CONDUCTED EMISSIONS TEST	12
3.1 LIMIT	12
3.2 TEST PROCEDURE	12
3.3 DEVIATION FROM TEST STANDARD	12
3.4 TEST SETUP	13
3.5 TEST RESULT	13
4 RADIATED EMISSIONS TEST	14
4.1 LIMIT	14
4.2 TEST PROCEDURE	15
4.3 DEVIATION FROM TEST STANDARD	15
4.4 TEST SETUP	15
4.5 EUT OPERATING CONDITIONS	16
4.6 TEST RESULT – 30 MHZ TO 1 GHZ	17
4.7 TEST RESULT – ABOVE 1 GHZ	17
5 OUTPUT POWER TEST	18
5.1 APPLIED PROCEDURES / LIMIT	18
5.2 TEST PROCEDURE	18
5.3 DEVIATION FROM STANDARD	18
5.4 TEST SETUP	18
5.5 EUT OPERATION CONDITIONS	18
5.6 TEST RESULTS	18
6 LIST OF MEASURING EQUIPMENTS	19
7 EUT TEST PHOTO	20
8 EUT PHOTOS	20
APPENDIX A AC POWER LINE CONDUCTED EMISSIONS	21
APPENDIX B RADIATED EMISSIONS - 30 MHZ TO 1 GHZ	26
APPENDIX C RADIATED EMISSIONS - ABOVE 1 GHZ	29
APPENDIX D OUTPUT POWER	46

REPORT ISSUED HISTORY

Report Version	Description	Issued Date
R00	Original Issue.	2020/6/12

1 SUMMARY OF TEST RESULTS

Test procedures according to the technical standards.

FCC Part 15, Subpart C (15.247)				
Standard(s) Section	Description	Test Result	Judgement	Remark
15.207	AC Power Line Conducted Emissions	APPENDIX A	Pass	-----
15.205 15.209 15.247(d)	Radiated Emissions	APPENDIX B APPENDIX C	Pass	-----
15.247 (b)(1)	Output Power	APPENDIX D	Pass	-----

NOTE:

- (1) "N/A" denotes test is not applicable in this Test Report.
- (2) The report format version is TP.1.1.1.
- (3) The Equipment under test (EUT) is the Tablet Computer, FCC ID: IR5DK13. The test data contained in this report pertains only to the emission due to the EUT's transmitter. For other test data can be refer report No.: 170524-01.TR05 (This FCC ID is change ID based on Intel Corporation, the original application information follow as model: 9260NGW, FCC ID: PD99260NG, approved on 07/24/2017)
- (4) After spot check, this revision does not change original radio parameters.

1.1 TEST FACILITY

The test facilities used to collect the test data in this report:

No. 68-1, Ln. 169, Sec. 2, Datong Rd., Xizhi Dist., New Taipei City 221, Taiwan

The test sites and facilities are covered under FCC RN: 674415 and DN: TW0659.

- C05 CB08 CB11 CB15 CB16
 SR06

1.2 MEASUREMENT UNCERTAINTY

The reported uncertainty of measurement $y \pm U$, where expanded uncertainty U is based on a standard uncertainty multiplied by a coverage factor of $k = 2$, providing a level of confidence of approximately **95 %**. The measurement instrumentation uncertainty considerations contained in CISPR 16-4-2. The BTL measurement uncertainty is less than the CISPR 16-4-2 U_{cispr} requirement.

A. AC power line conducted emissions test:

Test Site	Method	Measurement Frequency Range	U (dB)
C05	CISPR	150 kHz ~ 30MHz	3.44

B. Field Strength of Spurious Radiation test :

Test Site	Measurement Frequency Range	U,(dB)
CB15	0.03 GHz ~ 0.2 GHz	4.17
	0.2 GHz ~ 1 GHz	4.72
	1 GHz ~ 6 GHz	5.21
	6 GHz ~ 18 GHz	5.51
	18 GHz ~ 26 GHz	3.69
	26 GHz ~ 40 GHz	4.23

C. Conducted test :

Test Item	U,(dB)
Peak Output Power	1.06

NOTE:

Unless specifically mentioned, the uncertainty of measurement has not been taken into account to declare the compliance or non-compliance to the specification.

1.3 TEST ENVIRONMENT CONDITIONS

Test Item	Environment Condition	Test Voltage	Tested by
AC Power Line Conducted Emissions	25 °C, 61 %	AC 120V	William Wei
Radiated emissions below 1 GHz	22 °C, 65 %	AC 120V	Hunter Chiang
Radiated emissions above 1 GHz	22 °C, 65 %	AC 120V	Hunter Chiang
Output Power	24.2 °C, 54 %	AC 120V	Tim Lee

2 GENERAL INFORMATION

2.1 DESCRIPTION OF EUT

Equipment	Tablet Computer
Model Name	DK13
Brand Name	MilDef Crete Inc.
Model Difference	N/A
Power Source	# 1 Supplied from Li-Ion Rechargeable Battery Pack. # 2 DC voltage supplied from External Power Supply.
Power Rating	# 1 DC10.8V, 8700mAh, 94Wh # 2 Input: 100-240V~50-60Hz 1.2A MAX., Output: 19VDC, 4.7A
Products Covered	1 * Adapter: PHIHONG / ATS090-P190 1 * Module: Intel / 9260NGW 1 * Li-Ion Rechargeable Battery Pack: BD73C
Operation Frequency	2402 MHz ~ 2480 MHz
Modulation Type	GFSK, $\pi/4$ -DQPSK, 8DPSK
Modulation Technology	FHSS
Transfer Rate	1/2/3Mbps
Output Power Max.	1 Mbps: 10.80 dBm (0.0120 W) 2 Mbps: 10.23 dBm (0.0105 W) 3 Mbps: 10.24 dBm (0.0106 W)
Test Model	DK13
Sample Status	Engineering Sample
EUT Modification(s)	N/A

NOTE:

- (1) For a more detailed features description, please refer to the manufacturer's specifications or the user's manual.

(2) Channel List:

Channel	Frequency (MHz)	Channel	Frequency (MHz)	Channel	Frequency (MHz)
00	2402	27	2429	54	2456
01	2403	28	2430	55	2457
02	2404	29	2431	56	2458
03	2405	30	2432	57	2459
04	2406	31	2433	58	2460
05	2407	32	2434	59	2461
06	2408	33	2435	60	2462
07	2409	34	2436	61	2463
08	2410	35	2437	62	2464
09	2411	36	2438	63	2465
10	2412	37	2439	64	2466
11	2413	38	2440	65	2467
12	2414	39	2441	66	2468
13	2415	40	2442	67	2469
14	2416	41	2443	68	2470
15	2417	42	2444	69	2471
16	2418	43	2445	70	2472
17	2419	44	2446	71	2473
18	2420	45	2447	72	2474
19	2421	46	2448	73	2475
20	2422	47	2449	74	2476
21	2423	48	2450	75	2477
22	2424	49	2451	76	2478
23	2425	50	2452	77	2479
24	2426	51	2453	78	2480
25	2427	52	2454		
26	2428	53	2455		

(3) Table for Filed Antenna:

Ant.	Brand	Model	Type	Connector	Frequency Range (MHz)	Gain (dBi)
Main	MilDef Crete Inc.	DK13	PIFA Antenna	I-PEX	2400-2500	2.9
					5150-5250	3.2
Aux	MilDef Crete Inc.	DK13	PIFA Antenna	I-PEX	2400-2500	3.01
					5150-5250	3.66

2.2 DECLARATION BY THE MANUFACTURER

Adaptive Frequency Hopping is supported and uses at least 20 channels.

2.3 INFORMATION ABOUT THE FHSS CHARACTERISTICS:

2.3.1 PSEUDORANDOM FREQUENCY HOPPING SEQUENCE

The channel is represented by a pseudo-random hopping sequence hopping through the 79 RF channels. The hopping sequence is unique for the piconet and is determined by the Bluetooth device address of the master; the phase in the hopping sequence is determined by the Bluetooth clock of the master. The channel is divided into time slots where each slot corresponds to an RF hop frequency. Consecutive hops correspond to different RF hop frequencies. The nominal hop rate is 1 600 hops/s.

2.3.2 EQUAL HOPPING FREQUENCY USE

The channels of this system will be used equally over the long-term distribution of the hopsets.

2.3.3 EXAMPLE OF A 79 HOPPING SEQUENCE IN DATA MODE:

02, 05, 31, 24, 20, 10, 43, 36, 30, 23, 40, 06, 21, 50, 44, 09, 71, 78, 01, 13, 73, 07, 70, 72, 35, 62, 42, 11, 41, 08, 16, 29, 60, 15, 34, 61, 58, 04, 67, 12, 22, 53, 57, 18, 27, 76, 39, 32, 17, 77, 52, 33, 56, 46, 37, 47, 64, 49, 45, 38, 69, 14, 51, 26, 79, 19, 28, 65, 75, 54, 48, 03, 25, 66, 05, 16, 68, 74, 59, 63, 55

2.3.4 SYSTEM RECEIVER INPUT BANDWIDTH

Each channel bandwidth is 1 MHz.

The system receivers have input bandwidths that match the hopping channel bandwidths of their corresponding transmitters and shift frequencies in synchronization with the transmitted signals.

2.3.5 EQUIPMENT DESCRIPTION

15.247(a)(1) that the rx input bandwidths shift frequencies in synchronization with the transmitted signals.

15.247(g): In accordance with the Bluetooth Industry Standard, the system is designed to comply with all of the regulations in Section 15.247 when the transmitter is presented with a continuous data (or information) system.

15.247(h): In accordance with the Bluetooth Industry Standard, the system does not coordinate its channels selection/ hopping sequence with other frequency hopping systems for the express purpose of avoiding the simultaneous occupancy of individual hopping frequencies by multiple transmitters.

2.4 TEST MODES

Test Items	Test mode	Channel	Note
AC power line conducted emissions	Normal/Idle	-	-
Transmitter Radiated Emissions (below 1GHz)	1 Mbps	79	-
Transmitter Radiated Emissions (above 1GHz)	1/3 Mbps	00/78	Bandedge
	1/3 Mbps	00/39/78	Harmonic
Peak Output Power	1/2/3 Mbps	00/39/78	-

NOTE:

- (1) The Radiated emissions test was verified based on the worst conducted power and Bandwidth test results reported in the original report.
- (2) For radiated emission band edge test, both Vertical and Horizontal are evaluated, but only the worst case (Horizontal) is recorded.
- (3) All X, Y and Z axes are evaluated, but only the worst case (X axis) is recorded.
- (4) There were no emissions found below 30 MHz within 20 dB of the limit.

2.5 BLOCK DIAGRAM SHOWING THE CONFIGURATION OF SYSTEM TESTED

Equipment letters and Cable numbers refer to item numbers described in the tables of clause 2.6.

AC Power Line Conducted Emissions Test

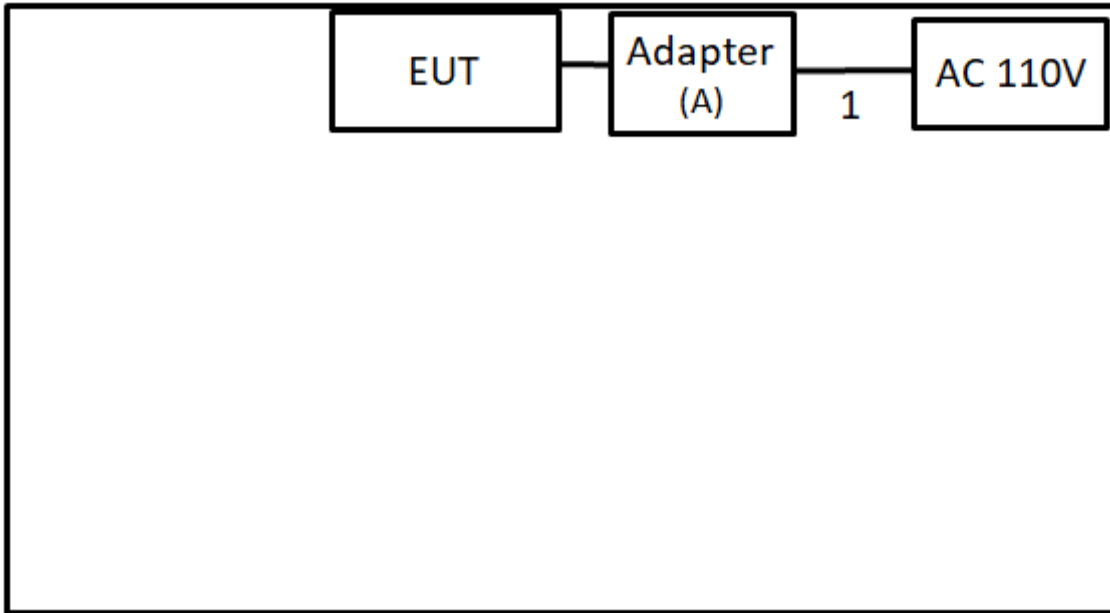

Radiated Emissions Test

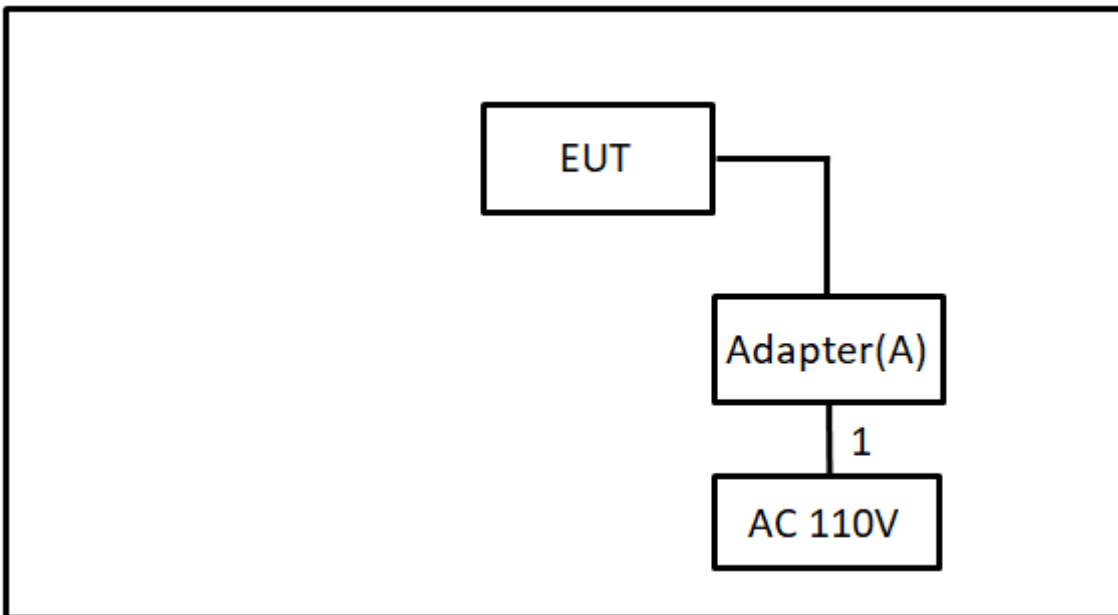

2.6 SUPPORT UNITS

Item	Equipment	Brand	Model No.	Series No.	Remarks
A	Adapter	PHIHONG	ATS090-P190	N/A	Supplied by test requester.

Item	Shielded	Ferrite Core	Length	Cable Type	Remarks
1	NO	NO	1m	Power Cable	Supplied by test requester.

3 AC POWER LINE CONDUCTED EMISSIONS TEST

3.1 LIMIT

Frequency (MHz)	Limit (dB μ V)	
	Quasi-peak	Average
0.15 - 0.5	66 - 56 *	56 - 46 *
0.50 - 5.0	56	46
5.0 - 30.0	60	50

NOTE:

- (1) The tighter limit applies at the band edges.
- (2) The limit of " * " marked band means the limitation decreases linearly with the logarithm of the frequency in the range.
- (3) The test result calculated as following:
 Measurement Value = Reading Level + Correct Factor
 Correct Factor = Insertion Loss + Cable Loss + Attenuator Factor (if use)
 Margin Level = Measurement Value – Limit Value
 Calculation example:

Reading Level		Correct Factor		Measurement Value
38.22	+	3.45	=	41.67

Measurement Value		Limit Value		Margin Level
41.67	-	60	=	-18.33

The following table is the setting of the receiver.

Receiver Parameter	Setting
Attenuation	10 dB
Start Frequency	0.15 MHz
Stop Frequency	30 MHz
IF Bandwidth	9 KHz

3.2 TEST PROCEDURE

- a. The EUT was placed 0.8 m above the horizontal ground plane with the EUT being connected to the power mains through a line impedance stabilization network (LISN).
 All other support equipment were powered from an additional LISN(s).
 The LISN provides 50 Ohm/50uH of impedance for the measuring instrument.
- b. Interconnecting cables that hang closer than 40 cm to the ground plane shall be folded back and forth in the center forming a bundle to keep the cable above 40 cm.
- c. Excess I/O cables that are not connected to a peripheral shall be bundled in the center.
 The end of the cable will be terminated, using the correct terminating impedance.
 The overall length shall not exceed 1 m.
- d. The LISN is spaced at least 80 cm from the nearest part of the EUT chassis.
- e. For the actual test configuration, please refer to the related Item - EUT TEST PHOTO.

NOTE:

- (1) In the results, each reading is marked as Peak, QP or AVG per the detector used.
 BW=9 kHz (6 dB Bandwidth)
- (2) All readings are Peak unless otherwise stated QP or AVG in column of Note. Both the QP and the AVG readings must be less than the limit for compliance.

3.3 DEVIATION FROM TEST STANDARD

No deviation.

3.4 TEST SETUP

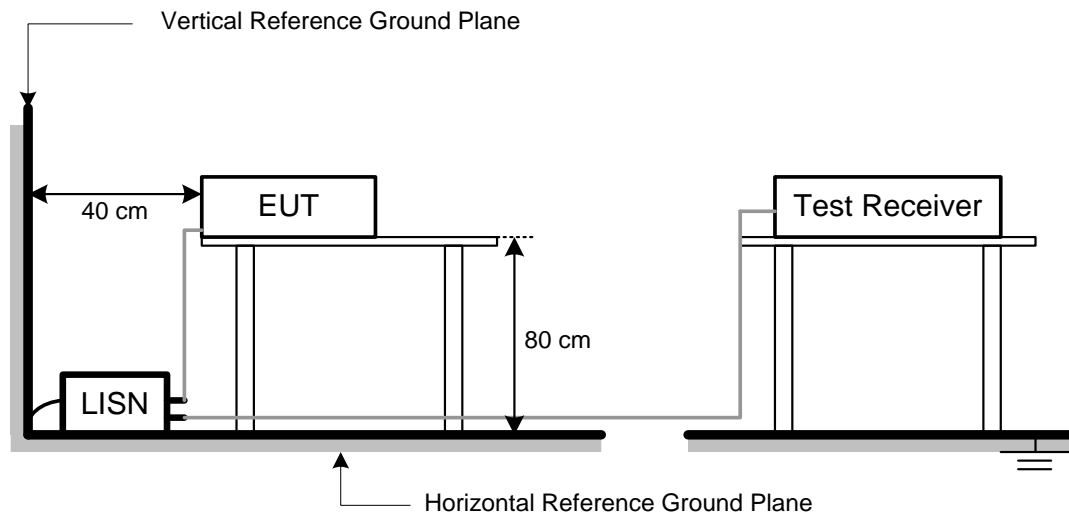

3.5 TEST RESULT

Please refer to the APPENDIX A.

4 RADIATED EMISSIONS TEST

4.1 LIMIT

In case the emission fall within the restricted band specified on 15.205, then the 15.209 limit in the table below has to be followed.

LIMITS OF RADIATED EMISSIONS MEASUREMENT (9 kHz to 1000 MHz)

Frequency (MHz)	Field Strength (microvolts/meter)	Measurement Distance (meters)
0.009~0.490	2400/F(KHz)	300
0.490~1.705	24000/F(KHz)	30
1.705~30.0	30	30
30~88	100	3
88~216	150	3
216~960	200	3
960~1000	500	3

LIMITS OF RADIATED EMISSIONS MEASUREMENT (Above 1000 MHz)

Frequency (MHz)	Radiated Emissions (dBuV/m)		Measurement Distance (meters)
	Peak	Average	
Above 1000	74	54	3

NOTE:

- (1) The limit for radiated test was performed according to FCC Part 15, Subpart C.
- (2) The tighter limit applies at the band edges.
- (3) Emission level (dBuV/m)=20log Emission level (uV/m).
- (4) The test result calculated as following:

Measurement Value = Reading Level + Correct Factor

Correct Factor = Antenna Factor + Cable Loss - Amplifier Gain(if use)

Margin Level = Measurement Value - Limit Value

Calculation example:

Reading Level		Correct Factor		Measurement Value
19.11	+	2.11	=	21.22

Measurement Value		Limit Value		Margin Level
21.22	-	54	=	-32.78

Spectrum Parameter	Setting
Attenuation	Auto
Start Frequency	1000 MHz
Stop Frequency	10th carrier harmonic
RBW / VBW (Emission in restricted band)	1MHz / 3MHz for Peak, 1MHz / 1/T for Average

Spectrum Parameter	Setting
Attenuation	Auto
Start ~ Stop Frequency	9KHz~90KHz for PK/AVG detector
Start ~ Stop Frequency	90KHz~110KHz for QP detector
Start ~ Stop Frequency	110KHz~490KHz for PK/AVG detector
Start ~ Stop Frequency	490KHz~30MHz for QP detector
Start ~ Stop Frequency	30MHz~1000MHz for QP detector

4.2 TEST PROCEDURE

- a. The measuring distance of 3 m shall be used for measurements. The EUT was placed on the top of a rotating table 0.8 meter above the ground at a 3 meter semi-anechoic chamber. The table was rotated 360 degrees to determine the position of the highest radiation.(below 1GHz)
- b. The measuring distance of 3 m shall be used for measurements. The EUT was placed on the top of a rotating table 1.5 meter above the ground at a 3 meter semi-anechoic chamber. The table was rotated 360 degrees to determine the position of the highest radiation.(above 1GHz)
- c. The height of the equipment or of the substitution antenna shall be 0.8 m or 1.5 m, the height of the test antenna shall vary between 1 m to 4 m. Both horizontal and vertical polarizations of the antenna are set to make the measurement.
- d. For each suspected emission, the EUT was arranged to its worst case and then the antenna was tuned to heights find the maximum reading (used Bore sight function).
- e. The receiver system was set to peak and average detect function and specified bandwidth with maximum hold mode when the test frequency is above 1GHz.
- f. The initial step in collecting radiated emission data is a receiver peak detector mode pre-scanning the measurement frequency range. Significant peaks are then marked and then Quasi Peak detector mode re-measured.
- g. All readings are Peak unless otherwise stated QP in column of Note. Peak denotes that the Peak reading compliance with the QP Limits and then QP Mode measurement didn't perform. (below 1GHz)
- h. All readings are Peak Mode value unless otherwise stated AVG in column of Note. If the Peak Mode Measured value compliance with the Peak Limits and lower than AVG Limits, the EUT shall be deemed to meet both Peak & AVG Limits and then only Peak Mode was measured, but AVG Mode didn't perform. (above 1GHz)
- i. For the actual test configuration, please refer to the related Item – EUT TEST PHOTO.

4.3 DEVIATION FROM TEST STANDARD

No deviation.

4.4 TEST SETUP

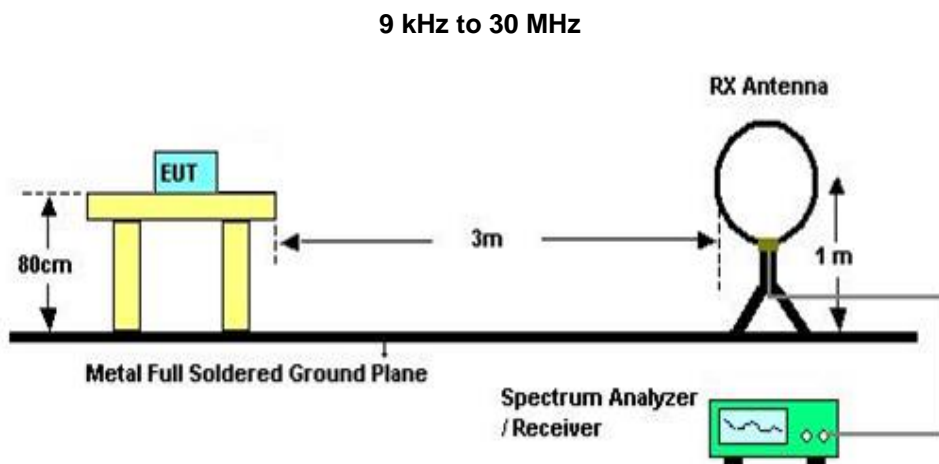

30 MHz to 1 GHz

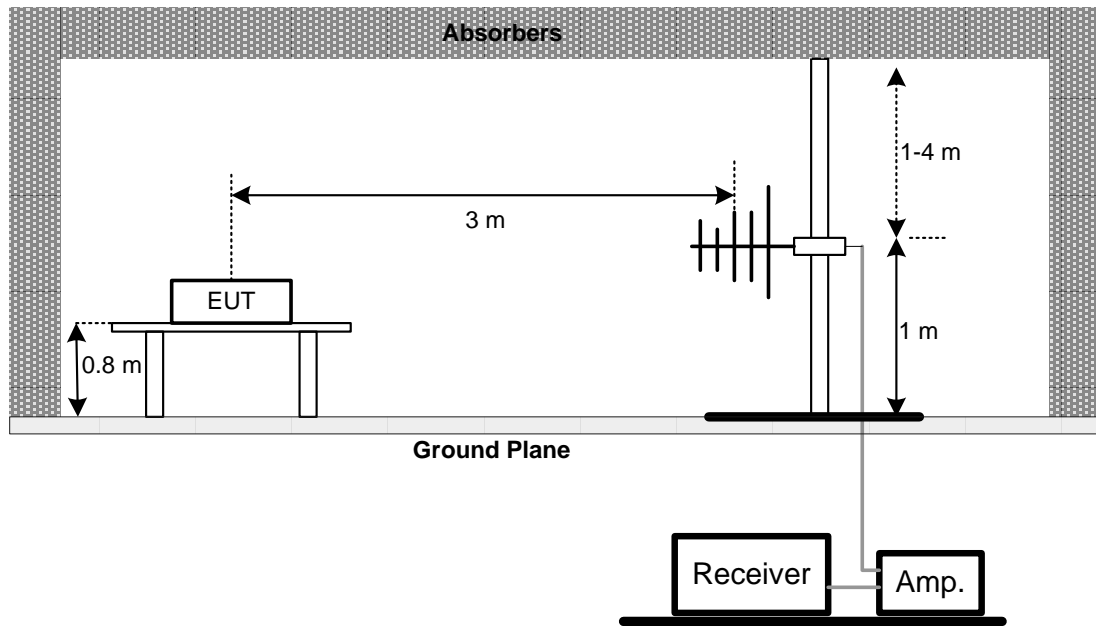

Above 1 GHz

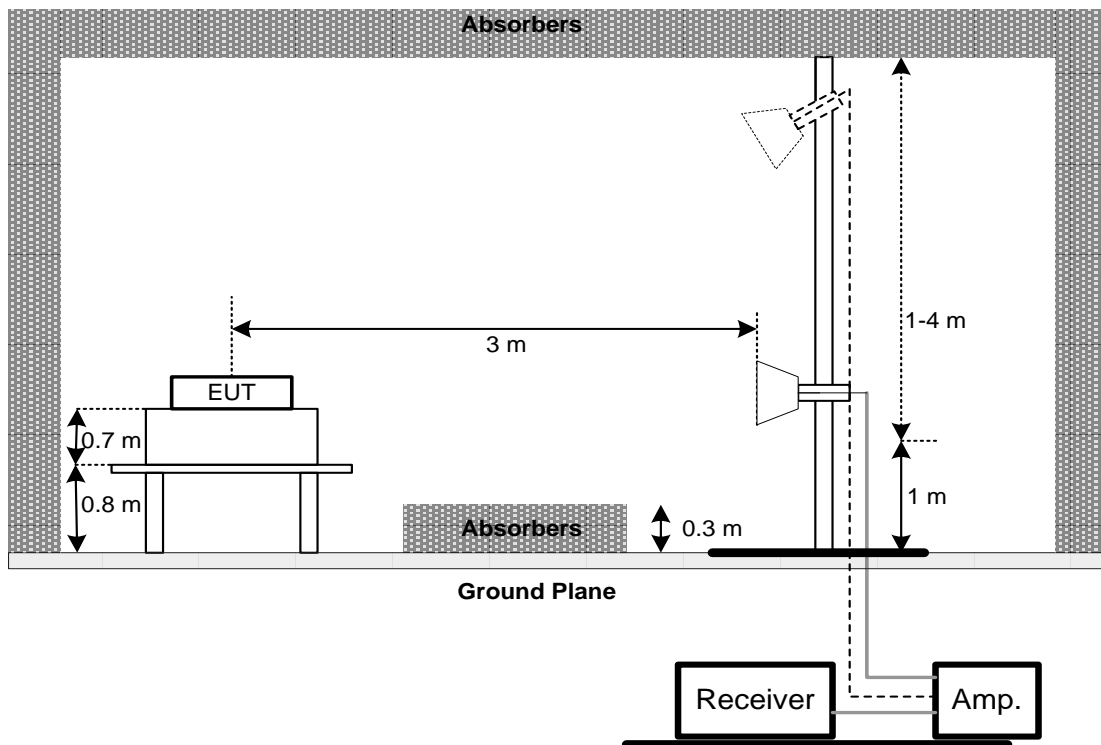

4.5 EUT OPERATING CONDITIONS

The EUT was programmed to be in continuously transmitting mode.

4.6 TEST RESULT – 30 MHZ TO 1 GHZ

Please refer to the APPENDIX B.

4.7 TEST RESULT – ABOVE 1 GHZ

Please refer to the APPENDIX C.

NOTE:

- (1) No limit: This is fundamental signal, the judgment is not applicable.
For fundamental signal judgment was referred to Peak output test.

5 OUTPUT POWER TEST

5.1 APPLIED PROCEDURES / LIMIT

FCC Part15 (15.247) , Subpart C				
Section	Test Item	Limit	Frequency Range (MHz)	Result
15.247(b)(1)	Peak Output Power	1 Watt or 30dBm (hopping channel >75) 0.125Watt or 21dBm (hopping channel <75)	2400-2483.5	PASS

5.2 TEST PROCEDURE

- a. The EUT was directly connected to the spectrum analyzer and antenna output port as show in the block diagram below,
- b. Spectrum Setting: RBW= 3MHz, VBW= 3MHz, Sweep time = Auto.

5.3 DEVIATION FROM STANDARD

No deviation.

5.4 TEST SETUP

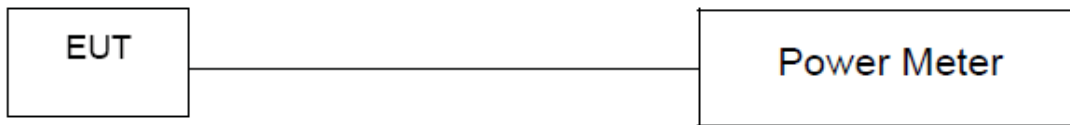

5.5 EUT OPERATION CONDITIONS

The EUT tested system was configured as the statements of 4.1.5 unless otherwise a special operating condition is specified in the follows during the testing.

5.6 TEST RESULTS

Please refer to the APPENDIX D.

6 LIST OF MEASURING EQUIPMENTS

AC Power Line Conducted Emissions						
Item	Kind of Equipment	Manufacturer	Type No.	Serial No.	Calibrated Date	Calibrated Until
1	TWO-LINE V-NETWORK	R&S	ENV216	101050	2019/6/21	2020/6/20
2	Test Cable	EMCI	EMCCFD300-BM-BMR-6000	170715	2019/8/7	2020/8/6
3	EMI Test Receiver	R&S	ESR7	101433	2019/12/11	2020/12/9
4	Measurement Software	EZ	EZ EMC (Version NB-03A)	N/A	N/A	N/A

Radiated Emissions						
Item	Kind of Equipment	Manufacturer	Type No.	Serial No.	Calibrated Date	Calibrated Until
1	Preamplifier	EMCI	EMC001340	980555	2020/4/10	2021/4/9
2	Preamplifier	EMCI	EMC02325B	980217	2020/4/10	2021/4/9
3	Preamplifier	EMCI	EMC012645B	980267	2020/4/10	2021/4/9
4	Preamplifier	EMCI	EMC2654045	980030	2020/1/31	2021/1/30
5	Test Cable	EMCI	EMC104-SM-SM-800	150207	2020/4/10	2021/4/9
6	Test Cable	EMCI	EMC104-SM-SM-3000	151205	2020/4/10	2021/4/9
7	Test Cable	EMCI	EMC-SM-SM-7000	180408	2020/4/10	2021/4/9
8	MXE EMI Receiver	Agilent	N9038A	MY55420127	2020/3/24	2021/3/23
9	Signal Analyzer	Agilent	N9010A	MY56480554	2019/6/6	2020/6/5
10	Loop Ant	EMCO	EMCI-LPA600	274	2019/5/31	2020/5/30
11	Horn Ant	SCHWARZBECK	BBHA 9120D	9120D-1342	2019/6/10	2020/6/9
12	Horn Ant	Schwarzbeck	BBHA 9170	187	2019/12/21	2020/12/20
13	Trilog-Broadband Antenna	Schwarzbeck	VULB 9168	000992	2019/5/29	2020/5/28
14	5dB Attenuator	EMCI	EMCI-N-6-05	AT-N0508	2019/5/29	2020/5/28

Output Power						
Item	Kind of Equipment	Manufacturer	Type No.	Serial No.	Calibrated Date	Calibrated Until
1	Power Meter	Anritsu	ML2487A	6K00004714	2019/6/20	2020/6/19
2	Power Sensor	Anritsu	MA2491A	1725282	2019/6/20	2020/6/19

Remark: "N/A" denotes no model name, no serial no. or no calibration specified.
All calibration period of equipment list is one year.

7 EUT TEST PHOTO

Please refer to document Appendix No.: TP-2004T174-FCCP-1 (APPENDIX-TEST PHOTOS).

8 EUT PHOTOS

Please refer to document Appendix No.: EP-2004T174-1 (APPENDIX-EUT PHOTOS).

APPENDIX A AC POWER LINE CONDUCTED EMISSIONS

Test Mode	Normal	Tested Date	2020/5/13
Test Frequency	-	Phase	Line

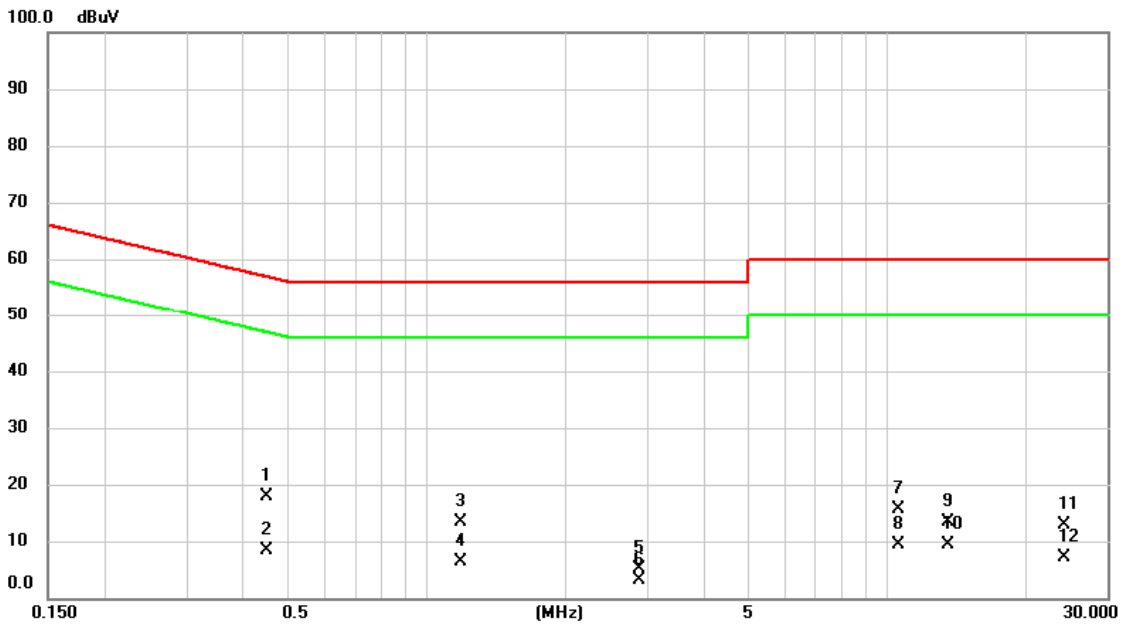

No.	Mk.	Freq. MHz	Reading Level dBuV	Correct Factor dB	Measure- ment dBuV	Limit dBuV	Over dB	Detector	Comment
1		0.4492	8.13	9.68	17.81	56.89	-39.08	QP	
2	*	0.4492	-1.31	9.68	8.37	46.89	-38.52	AVG	
3		1.1805	3.62	9.70	13.32	56.00	-42.68	QP	
4		1.1805	-3.36	9.70	6.34	46.00	-39.66	AVG	
5		2.8815	-4.65	9.75	5.10	56.00	-50.90	QP	
6		2.8815	-6.68	9.75	3.07	46.00	-42.93	AVG	
7		10.5854	5.73	9.90	15.63	60.00	-44.37	QP	
8		10.5854	-0.49	9.90	9.41	50.00	-40.59	AVG	
9		13.5600	3.48	9.91	13.39	60.00	-46.61	QP	
10		13.5600	-0.43	9.91	9.48	50.00	-40.52	AVG	
11		24.2453	2.92	9.88	12.80	60.00	-47.20	QP	
12		24.2453	-2.66	9.88	7.22	50.00	-42.78	AVG	

REMARKS:

- (1) Measurement Value = Reading Level + Correct Factor.
- (2) Margin Level = Measurement Value - Limit Value.

Test Mode	Normal	Tested Date	2020/5/13
Test Frequency	-	Phase	Neutral

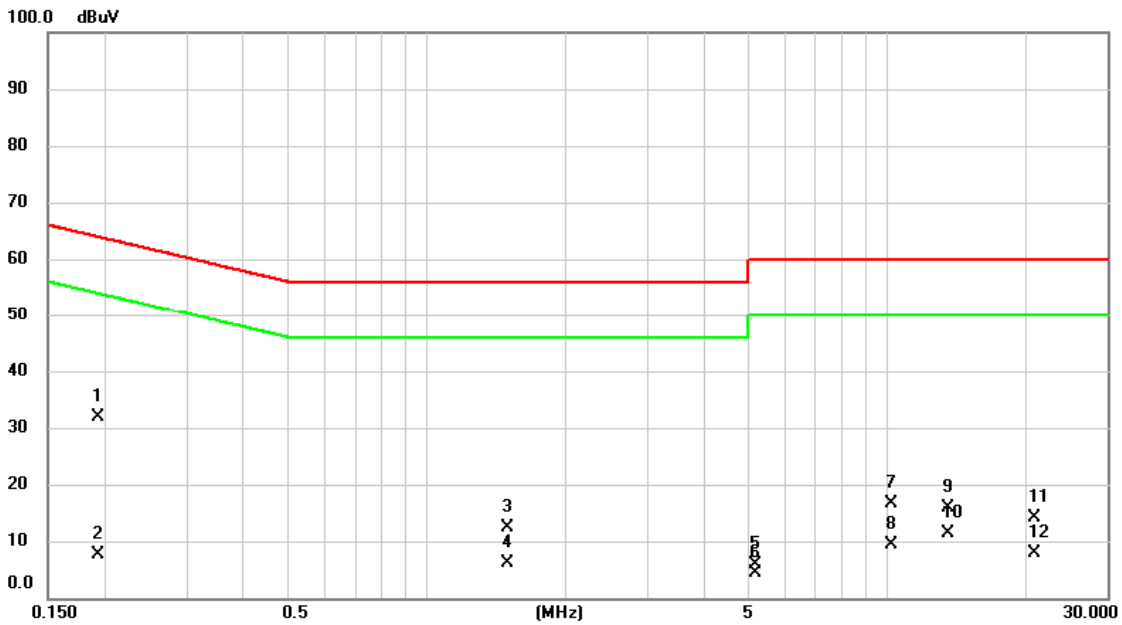

No.	Mk.	Freq. MHz	Reading Level dBuV	Correct Factor dB	Measure- ment dBuV	Limit dBuV	Over dB	Detector	Comment
1	*	0.1934	22.39	9.61	32.00	63.89	-31.89	QP	
2		0.1934	-2.05	9.61	7.56	53.89	-46.33	AVG	
3		1.4910	2.64	9.69	12.33	56.00	-43.67	QP	
4		1.4910	-3.63	9.69	6.06	46.00	-39.94	AVG	
5		5.1968	-3.82	9.80	5.98	60.00	-54.02	QP	
6		5.1968	-5.50	9.80	4.30	50.00	-45.70	AVG	
7		10.1963	6.66	9.92	16.58	60.00	-43.42	QP	
8		10.1963	-0.63	9.92	9.29	50.00	-40.71	AVG	
9		13.5623	5.81	9.97	15.78	60.00	-44.22	QP	
10		13.5623	1.40	9.97	11.37	50.00	-38.63	AVG	
11		20.8635	4.15	10.05	14.20	60.00	-45.80	QP	
12		20.8635	-2.19	10.05	7.86	50.00	-42.14	AVG	

REMARKS:

- (1) Measurement Value = Reading Level + Correct Factor.
- (2) Margin Level = Measurement Value - Limit Value.

Test Mode	Idle	Tested Date	2020/5/13
Test Frequency	-	Phase	Line

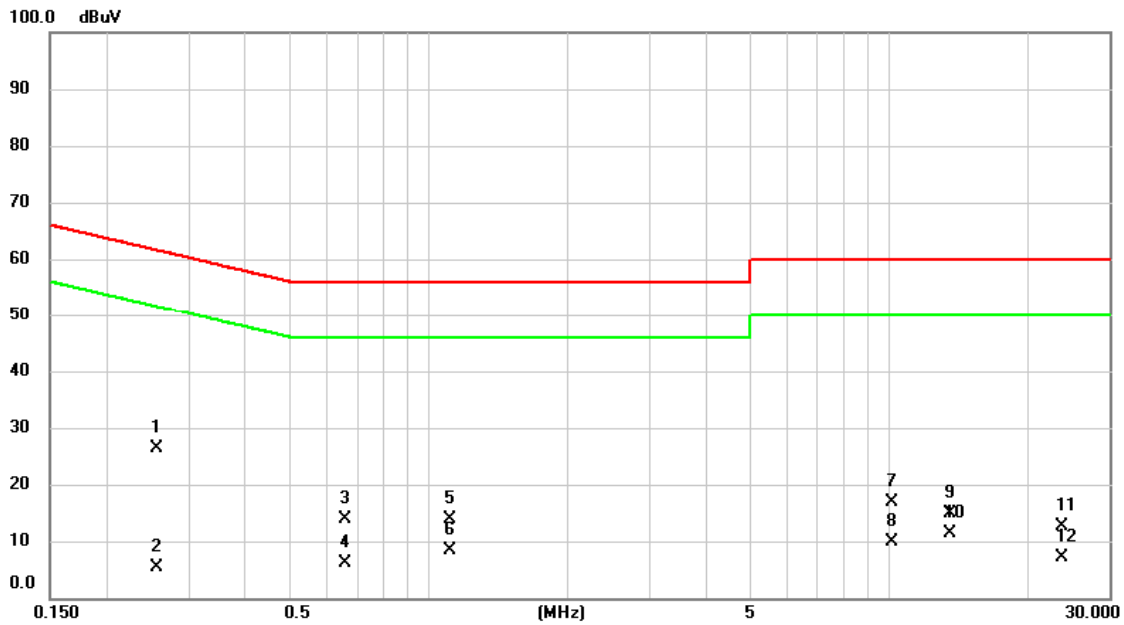

No.	Mk.	Freq. MHz	Reading Level dBuV	Correct Factor dB	Measure- ment dBuV	Limit dBuV	Over dB	Detector	Comment
1	*	0.2558	16.84	9.63	26.47	61.57	-35.10	QP	
2		0.2558	-4.24	9.63	5.39	51.57	-46.18	AVG	
3		0.6607	4.08	9.69	13.77	56.00	-42.23	QP	
4		0.6607	-3.55	9.69	6.14	46.00	-39.86	AVG	
5		1.1085	4.09	9.70	13.79	56.00	-42.21	QP	
6		1.1085	-1.43	9.70	8.27	46.00	-37.73	AVG	
7		10.1693	6.97	9.90	16.87	60.00	-43.13	QP	
8		10.1693	-0.08	9.90	9.82	50.00	-40.18	AVG	
9		13.5600	5.09	9.91	15.00	60.00	-45.00	QP	
10		13.5600	1.38	9.91	11.29	50.00	-38.71	AVG	
11		23.7210	2.71	9.89	12.60	60.00	-47.40	QP	
12		23.7210	-2.85	9.89	7.04	50.00	-42.96	AVG	

REMARKS:

- (1) Measurement Value = Reading Level + Correct Factor.
- (2) Margin Level = Measurement Value - Limit Value.

Test Mode	Idle	Tested Date	2020/5/13
Test Frequency	-	Phase	Neutral

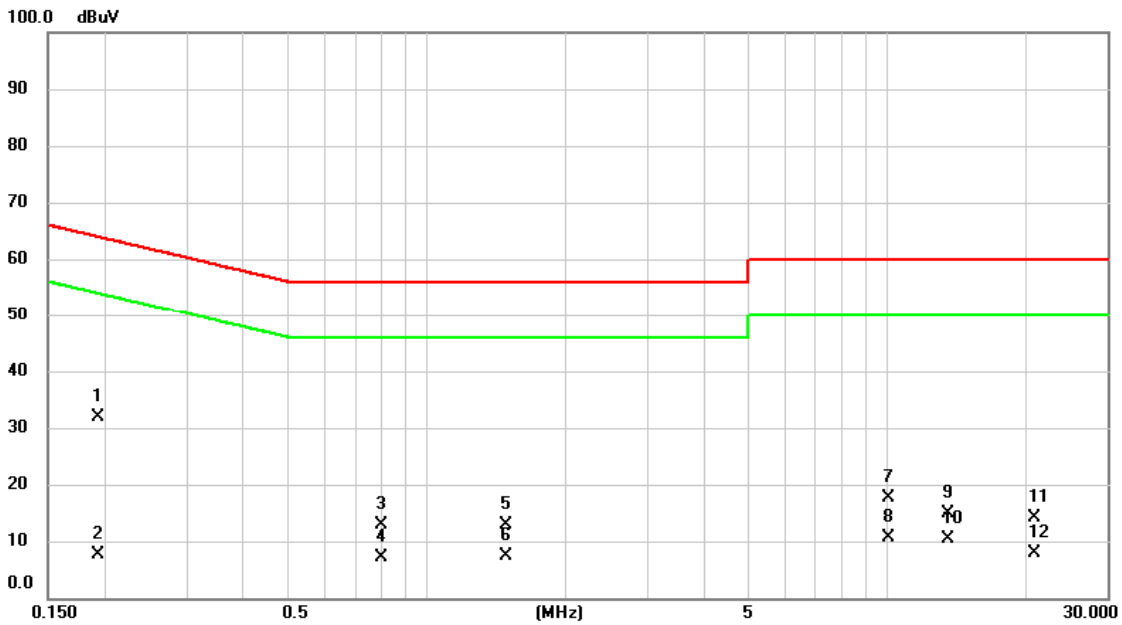

No.	Mk.	Freq. MHz	Reading Level dBuV	Correct Factor dB	Measure- ment dBuV	Limit dBuV	Over dB	Detector	Comment
1	*	0.1934	22.20	9.61	31.81	63.89	-32.08	QP	
2		0.1934	-1.95	9.61	7.66	53.89	-46.23	AVG	
3		0.7980	3.21	9.68	12.89	56.00	-43.11	QP	
4		0.7980	-2.67	9.68	7.01	46.00	-38.99	AVG	
5		1.4888	3.12	9.69	12.81	56.00	-43.19	QP	
6		1.4888	-2.40	9.69	7.29	46.00	-38.71	AVG	
7		10.0477	7.67	9.92	17.59	60.00	-42.41	QP	
8		10.0477	0.66	9.92	10.58	50.00	-39.42	AVG	
9		13.5600	4.98	9.97	14.95	60.00	-45.05	QP	
10		13.5600	0.48	9.97	10.45	50.00	-39.55	AVG	
11		20.9017	4.15	10.05	14.20	60.00	-45.80	QP	
12		20.9017	-2.11	10.05	7.94	50.00	-42.06	AVG	

REMARKS:

- (1) Measurement Value = Reading Level + Correct Factor.
- (2) Margin Level = Measurement Value - Limit Value.

APPENDIX B RADIATED EMISSIONS - 30 MHZ TO 1 GHZ

Test Mode	BT (1 Mbps)	Test Date	2020/5/13
Test Frequency	CH79: 2480 MHz	Polarization	Vertical

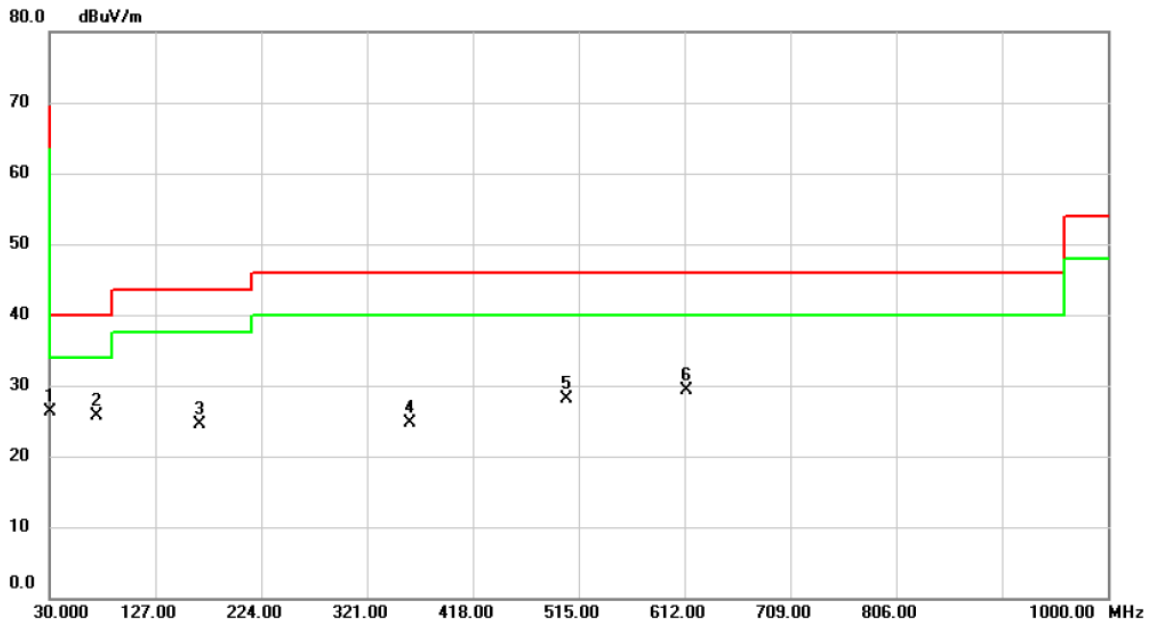

No.	Mk.	Freq. MHz	Reading Level dBuV	Correct Factor dB	Measure- ment dBuV/m	Limit dBuV/m	Over dB	Detector	Comment
1	*	30.9700	35.28	-9.05	26.23	40.00	-13.77	peak	
2		72.6800	36.93	-11.19	25.74	40.00	-14.26	peak	
3		167.7400	33.25	-8.78	24.47	43.50	-19.03	peak	
4		359.8000	30.65	-5.97	24.68	46.00	-21.32	peak	
5		504.3300	31.00	-2.84	28.16	46.00	-17.84	peak	
6		613.9400	29.48	-0.24	29.24	46.00	-16.76	peak	

REMARKS:

- (1) Measurement Value = Reading Level + Correct Factor.
- (2) Margin Level = Measurement Value - Limit Value.

Test Mode	BT (1 Mbps)	Test Date	2020/5/13
Test Frequency	CH79: 2480 MHz	Polarization	Horizontal

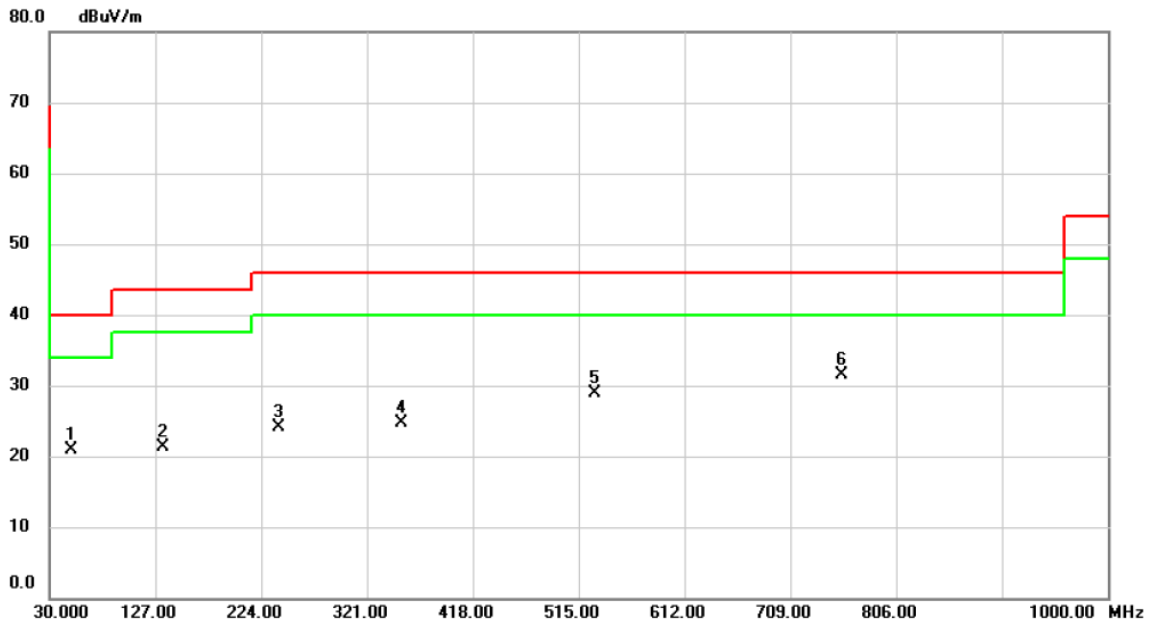

No.	Mk.	Freq. MHz	Reading Level dBuV	Correct Factor dB	Measure- ment dBuV/m	Limit dBuV/m	Over dB	Detector	Comment
1		49.4000	28.92	-8.05	20.87	40.00	-19.13	peak	
2		133.7900	30.84	-9.50	21.34	43.50	-22.16	peak	
3		240.4900	33.17	-9.12	24.05	46.00	-21.95	peak	
4		353.0100	30.92	-6.13	24.79	46.00	-21.21	peak	
5		529.5500	31.29	-2.39	28.90	46.00	-17.10	peak	
6	*	755.5600	29.07	2.41	31.48	46.00	-14.52	peak	

REMARKS:

- (1) Measurement Value = Reading Level + Correct Factor.
- (2) Margin Level = Measurement Value - Limit Value.

APPENDIX C RADIATED EMISSIONS - ABOVE 1 GHZ

Test Mode	BT (1 Mbps)	Test Date	2020/5/13
Test Frequency	CH00: 2402 MHz	Polarization	Horizontal

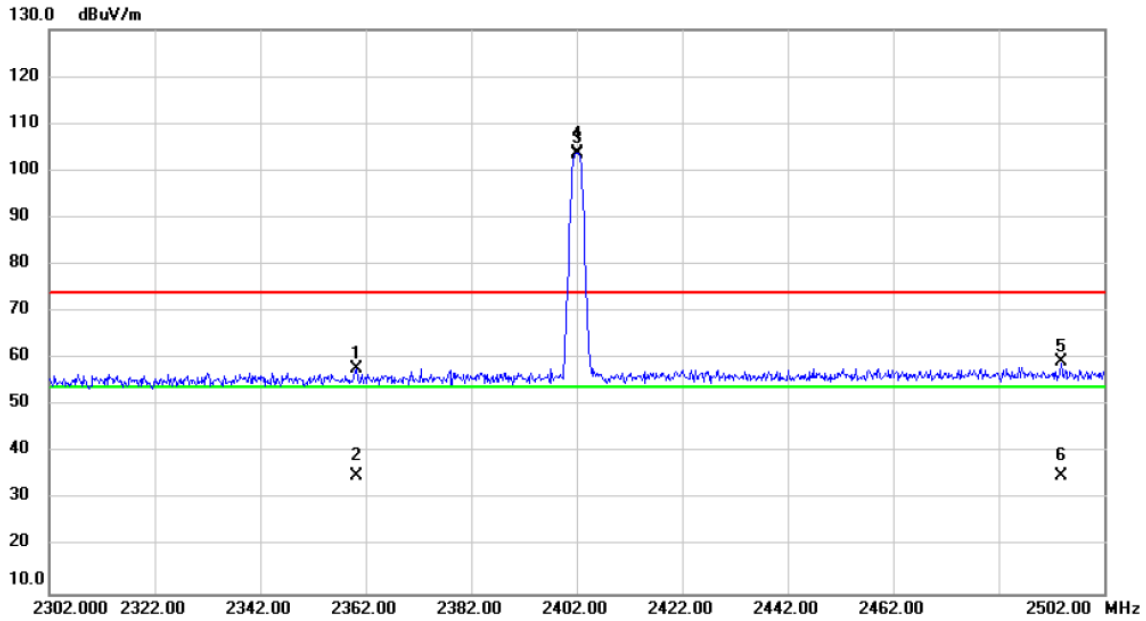

No.	Mk.	Freq.	Reading Level	Correct Factor	Measurement	Limit	Over	Detector	Comment
		MHz	dBuV	dB	dBuV/m	dBuV/m	dB		
1		2360.200	26.59	31.26	57.85	74.00	-16.15	peak	
2		2360.200	3.65	31.26	34.91	54.00	-19.09	AVG	
3	X	2402.000	72.35	31.43	103.78	74.00	29.78	peak	No Limit
4	*	2402.000	72.16	31.43	103.59	54.00	49.59	AVG	No Limit
5		2493.800	27.41	31.79	59.20	74.00	-14.80	peak	
6		2493.800	3.35	31.79	35.14	54.00	-18.86	AVG	

REMARKS:

- (1) Measurement Value = Reading Level + Correct Factor.
- (2) Margin Level = Measurement Value - Limit Value.

Test Mode	BT (1 Mbps)	Test Date	2020/5/13
Test Frequency	CH79: 2480 MHz	Polarization	Horizontal

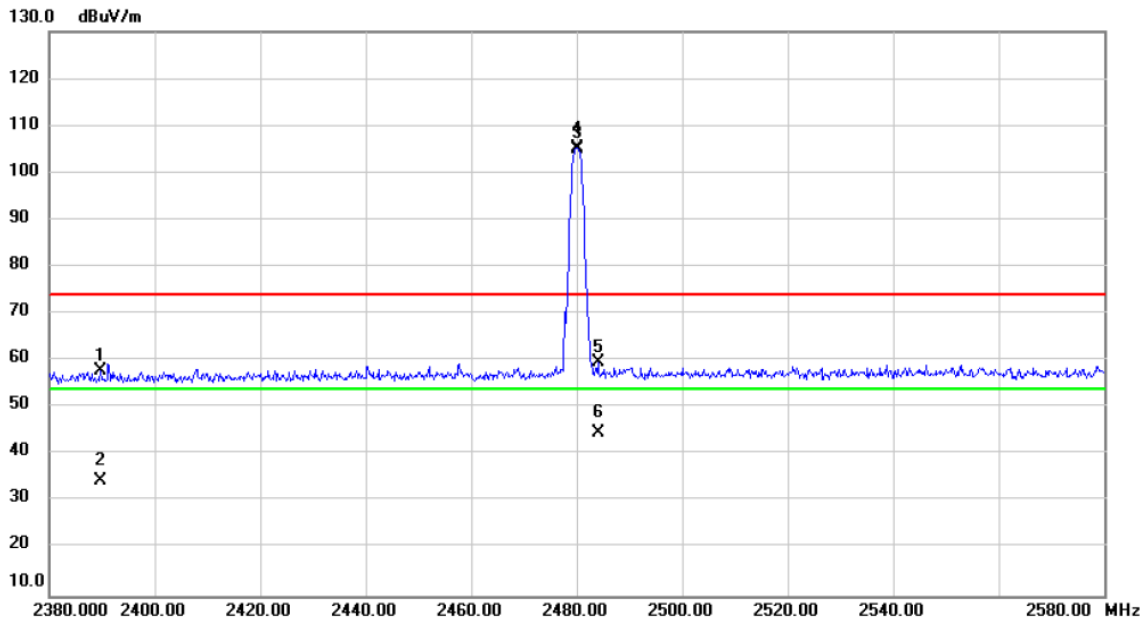

No.	Mk.	Freq.	Reading Level	Correct Factor	Measurement	Limit	Over	Detector	Comment
		MHz	dBuV	dB	dBuV/m	dBuV/m	dB		
1		2389.800	26.40	31.38	57.78	74.00	-16.22	peak	
2		2389.800	3.13	31.38	34.51	54.00	-19.49	AVG	
3	X	2480.000	73.44	31.74	105.18	74.00	31.18	peak	No Limit
4	*	2480.000	73.17	31.74	104.91	54.00	50.91	AVG	No Limit
5		2484.000	27.94	31.76	59.70	74.00	-14.30	peak	
6		2484.000	13.00	31.76	44.76	54.00	-9.24	AVG	

REMARKS:

- (1) Measurement Value = Reading Level + Correct Factor.
- (2) Margin Level = Measurement Value - Limit Value.

Test Mode	BT (3 Mbps)	Test Date	2020/5/13
Test Frequency	CH00: 2402 MHz	Polarization	Horizontal

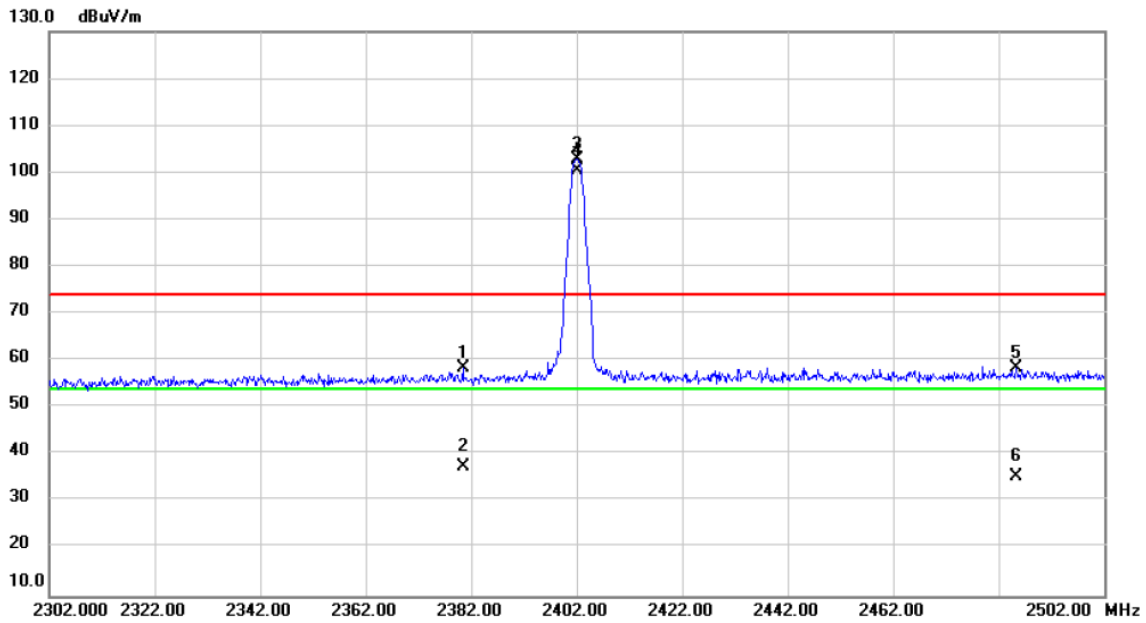

No.	Mk.	Freq.	Reading Level	Correct Factor	Measurement	Limit	Over	Detector	Comment
		MHz	dBuV	dB	dBuV/m	dBuV/m	dB		
1		2380.400	27.00	31.34	58.34	74.00	-15.66	peak	
2		2380.400	6.04	31.34	37.38	54.00	-16.62	AVG	
3	X	2402.000	71.47	31.43	102.90	74.00	28.90	peak	No Limit
4	*	2402.000	69.16	31.43	100.59	54.00	46.59	AVG	No Limit
5		2485.400	26.56	31.76	58.32	74.00	-15.68	peak	
6		2485.400	3.71	31.76	35.47	54.00	-18.53	AVG	

REMARKS:

- (1) Measurement Value = Reading Level + Correct Factor.
- (2) Margin Level = Measurement Value - Limit Value.

Test Mode	BT (3 Mbps)	Test Date	2020/5/13
Test Frequency	CH79: 2480 MHz	Polarization	Horizontal

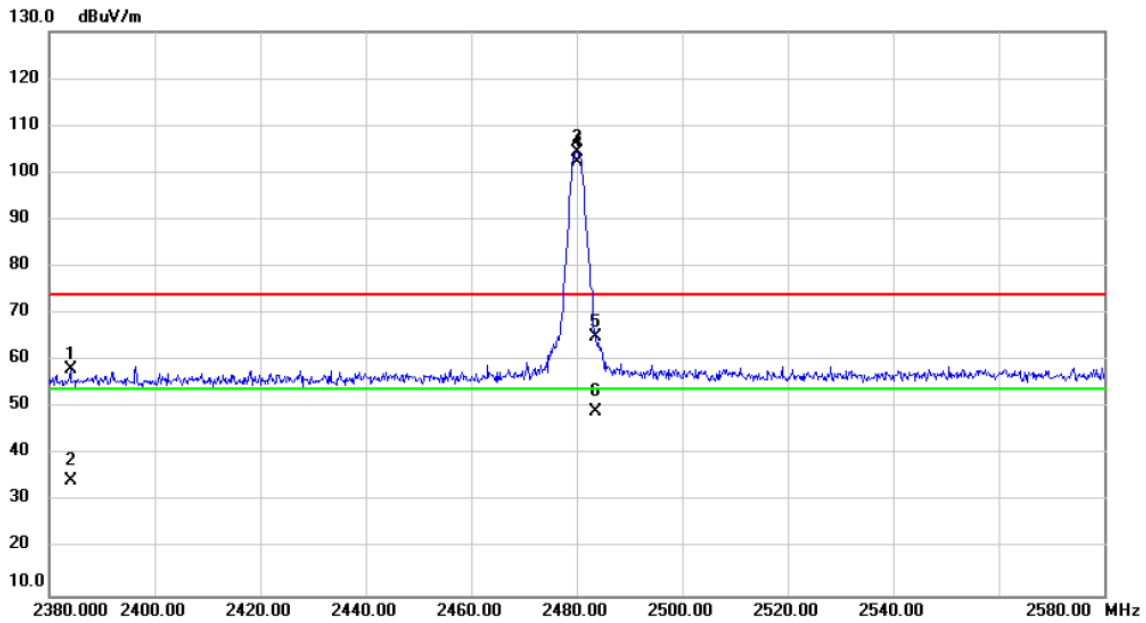

No.	Mk.	Freq.	Reading Level	Correct Factor	Measurement	Limit	Over	Detector	Comment
		MHz	dBuV	dB	dBuV/m	dBuV/m	dB		
1		2384.000	26.75	31.35	58.10	74.00	-15.90	peak	
2		2384.000	3.21	31.35	34.56	54.00	-19.44	AVG	
3	X	2480.000	72.71	31.74	104.45	74.00	30.45	peak	No Limit
4	*	2480.000	70.56	31.74	102.30	54.00	48.30	AVG	No Limit
5		2483.500	33.21	31.76	64.97	74.00	-9.03	peak	
6		2483.500	17.50	31.76	49.26	54.00	-4.74	AVG	

REMARKS:

- (1) Measurement Value = Reading Level + Correct Factor.
- (2) Margin Level = Measurement Value - Limit Value.

Test Mode	BT (1 Mbps)	Test Date	2020/5/13
Test Frequency	CH00: 2402 MHz	Polarization	Vertical

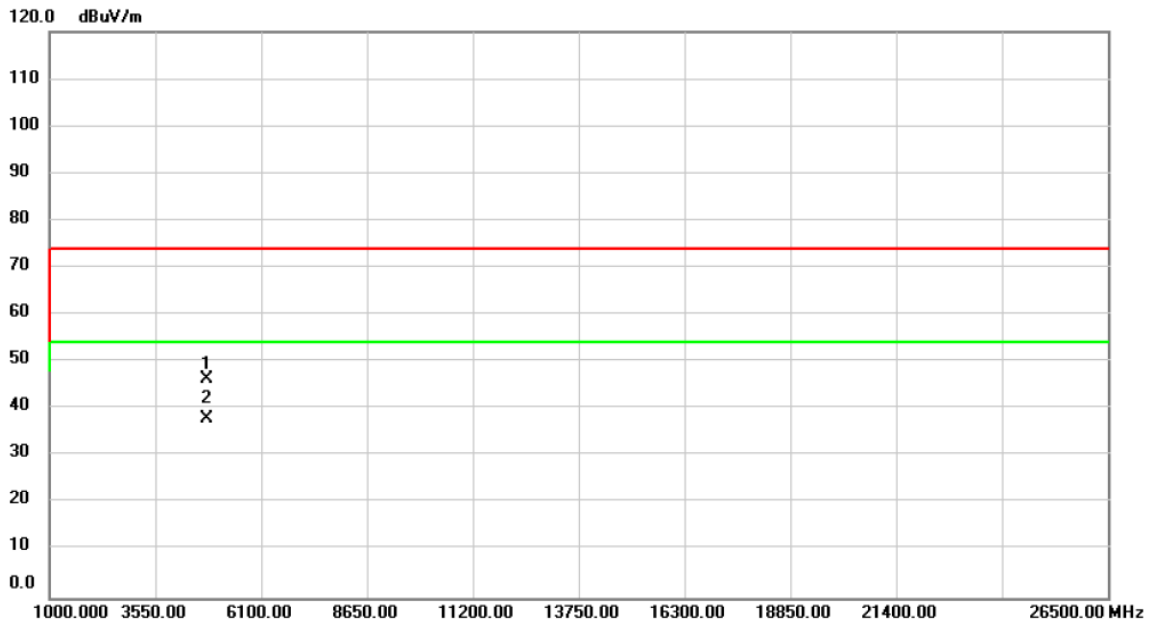

No.	Mk.	Freq.	Reading Level	Correct Factor	Measurement	Limit	Over	Detector	Comment
		MHz	dBuV	dB	dBuV/m	dBuV/m	dB		
1		4804.000	56.12	-9.84	46.28	74.00	-27.72	peak	
2	*	4804.000	47.89	-9.84	38.05	54.00	-15.95	AVG	

REMARKS:

- (1) Measurement Value = Reading Level + Correct Factor.
- (2) Margin Level = Measurement Value - Limit Value.

Test Mode	BT (1 Mbps)	Test Date	2020/5/13
Test Frequency	CH00: 2402 MHz	Polarization	Horizontal

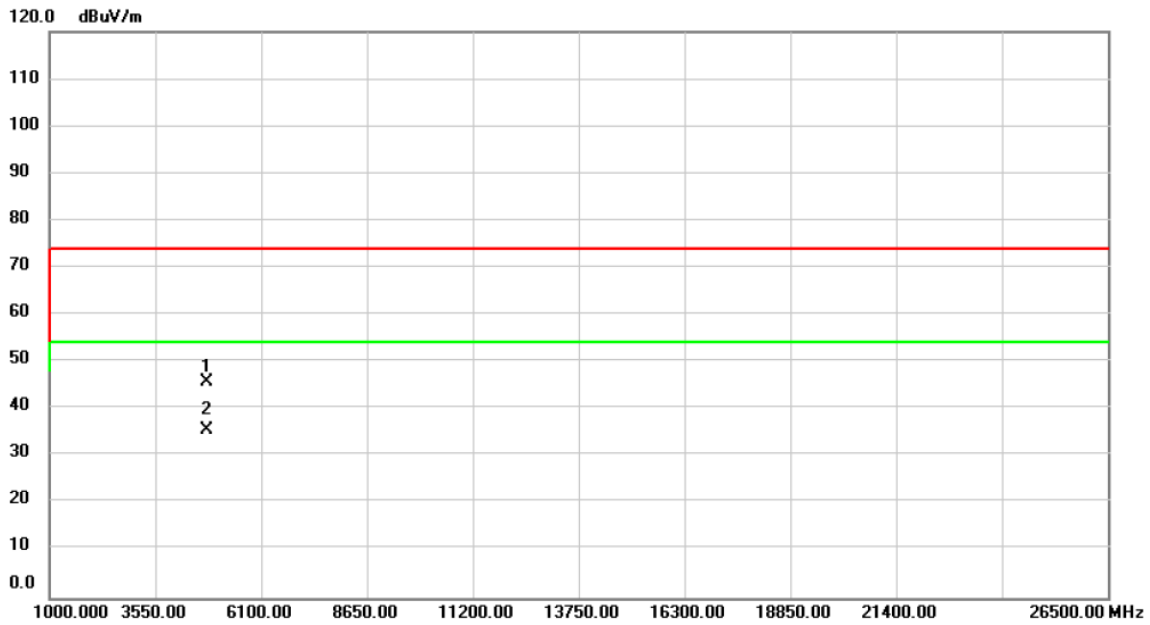

No.	Mk.	Freq.	Reading Level	Correct Factor	Measurement	Limit	Over	Detector	Comment
		MHz	dBuV	dB	dBuV/m	dBuV/m	dB		
1		4804.000	55.52	-9.84	45.68	74.00	-28.32	peak	
2	*	4804.000	45.27	-9.84	35.43	54.00	-18.57	AVG	

REMARKS:

- (1) Measurement Value = Reading Level + Correct Factor.
- (2) Margin Level = Measurement Value - Limit Value.

Test Mode	BT (1 Mbps)	Test Date	2020/5/13
Test Frequency	CH39: 2441 MHz	Polarization	Vertical

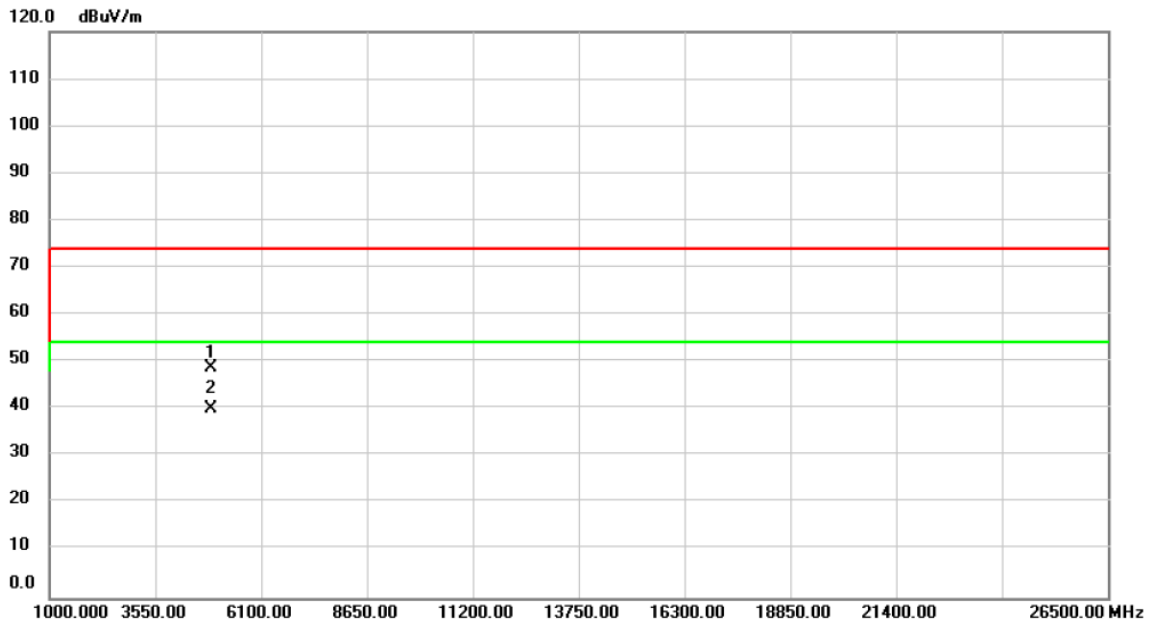

No.	Mk.	Freq.	Reading Level	Correct Factor	Measurement	Limit	Over	Detector	Comment
		MHz	dBuV	dB	dBuV/m	dBuV/m	dB		
1		4882.000	58.42	-9.66	48.76	74.00	-25.24	peak	
2	*	4882.000	49.62	-9.66	39.96	54.00	-14.04	AVG	

REMARKS:

- (1) Measurement Value = Reading Level + Correct Factor.
- (2) Margin Level = Measurement Value - Limit Value.

Test Mode	BT (1 Mbps)	Test Date	2020/5/13
Test Frequency	CH39: 2441 MHz	Polarization	Horizontal

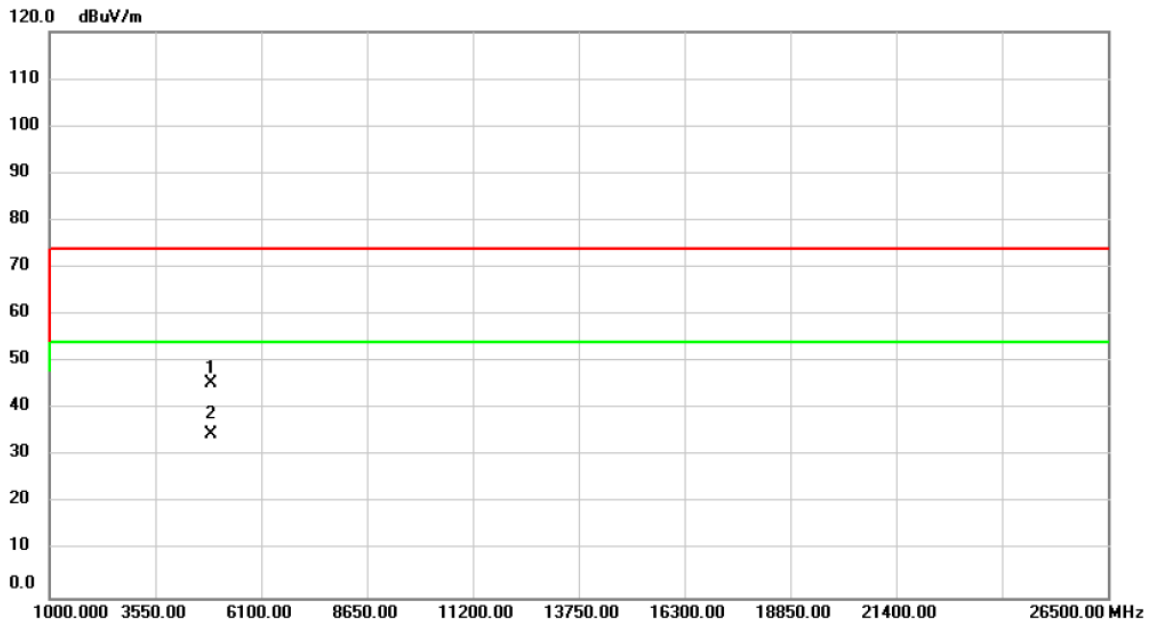

No.	Mk.	Freq.	Reading Level	Correct Factor	Measurement	Limit	Over	Detector	Comment
		MHz	dBuV	dB	dBuV/m	dBuV/m	dB		
1		4882.000	55.26	-9.66	45.60	74.00	-28.40	peak	
2	*	4882.000	44.33	-9.66	34.67	54.00	-19.33	AVG	

REMARKS:

- (1) Measurement Value = Reading Level + Correct Factor.
- (2) Margin Level = Measurement Value - Limit Value.

Test Mode	BT (1 Mbps)	Test Date	2020/5/13
Test Frequency	CH79: 2480 MHz	Polarization	Vertical

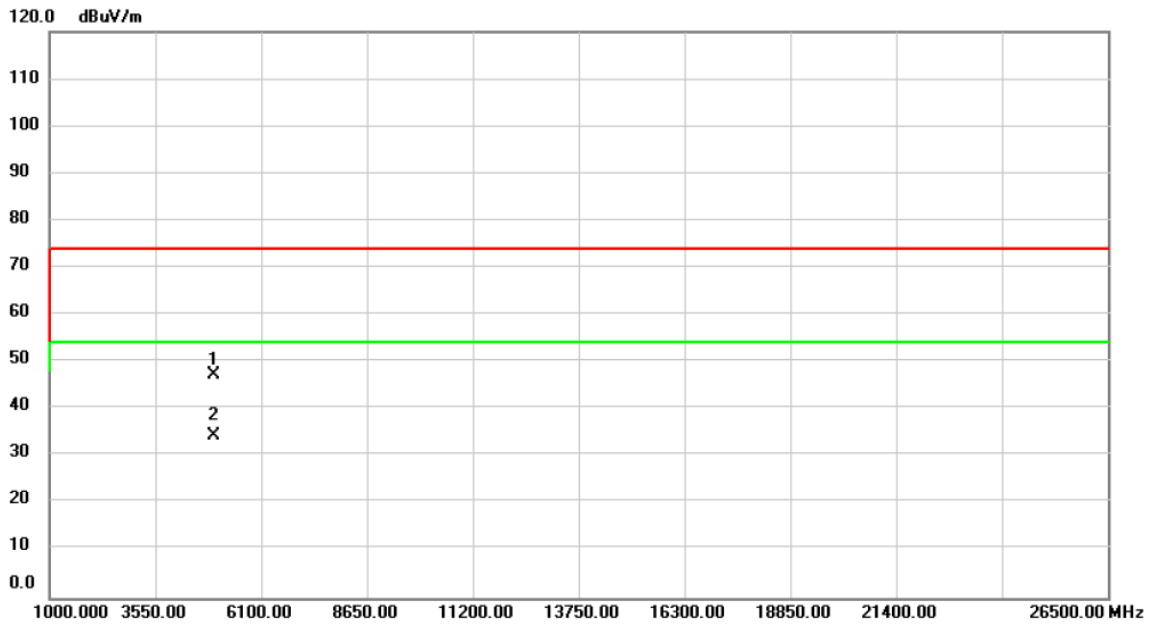

No.	Mk.	Freq.	Reading Level	Correct Factor	Measurement	Limit	Over	Detector	Comment
		MHz	dBuV	dB	dBuV/m	dBuV/m	dB		
1		4960.000	56.84	-9.48	47.36	74.00	-26.64	peak	
2	*	4960.000	43.78	-9.48	34.30	54.00	-19.70	AVG	

REMARKS:

- (1) Measurement Value = Reading Level + Correct Factor.
- (2) Margin Level = Measurement Value - Limit Value.

Test Mode	BT (1 Mbps)	Test Date	2020/5/13
Test Frequency	CH79: 2480 MHz	Polarization	Horizontal

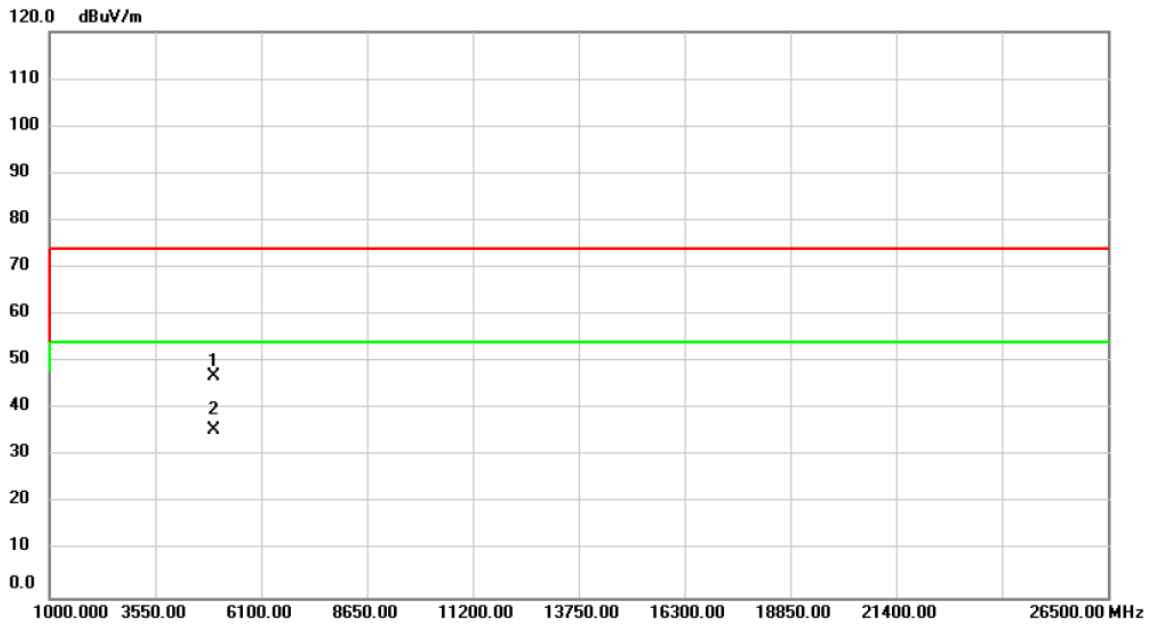

No.	Mk.	Freq.	Reading Level	Correct Factor	Measurement	Limit	Over	Detector	Comment
		MHz	dBuV	dB	dBuV/m	dBuV/m	dB		
1		4960.000	56.39	-9.48	46.91	74.00	-27.09	peak	
2	*	4960.000	44.98	-9.48	35.50	54.00	-18.50	AVG	

REMARKS:

- (1) Measurement Value = Reading Level + Correct Factor.
- (2) Margin Level = Measurement Value - Limit Value.

Test Mode	BT (3 Mbps)	Test Date	2020/5/13
Test Frequency	CH00: 2402 MHz	Polarization	Vertical

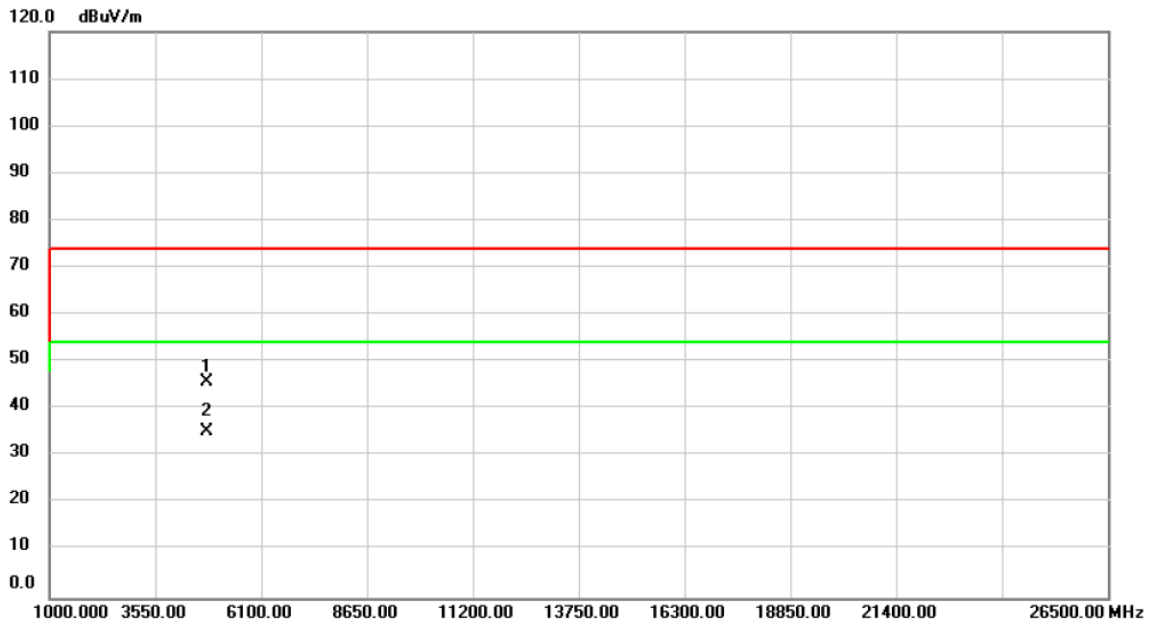

No.	Mk.	Freq.	Reading Level	Correct Factor	Measurement	Limit	Over	Detector	Comment
		MHz	dBuV	dB	dBuV/m	dBuV/m	dB		
1		4804.000	55.71	-9.84	45.87	74.00	-28.13	peak	
2	*	4804.000	45.07	-9.84	35.23	54.00	-18.77	AVG	

REMARKS:

- (1) Measurement Value = Reading Level + Correct Factor.
- (2) Margin Level = Measurement Value - Limit Value.

Test Mode	BT (3 Mbps)	Test Date	2020/5/13
Test Frequency	CH00: 2402 MHz	Polarization	Horizontal

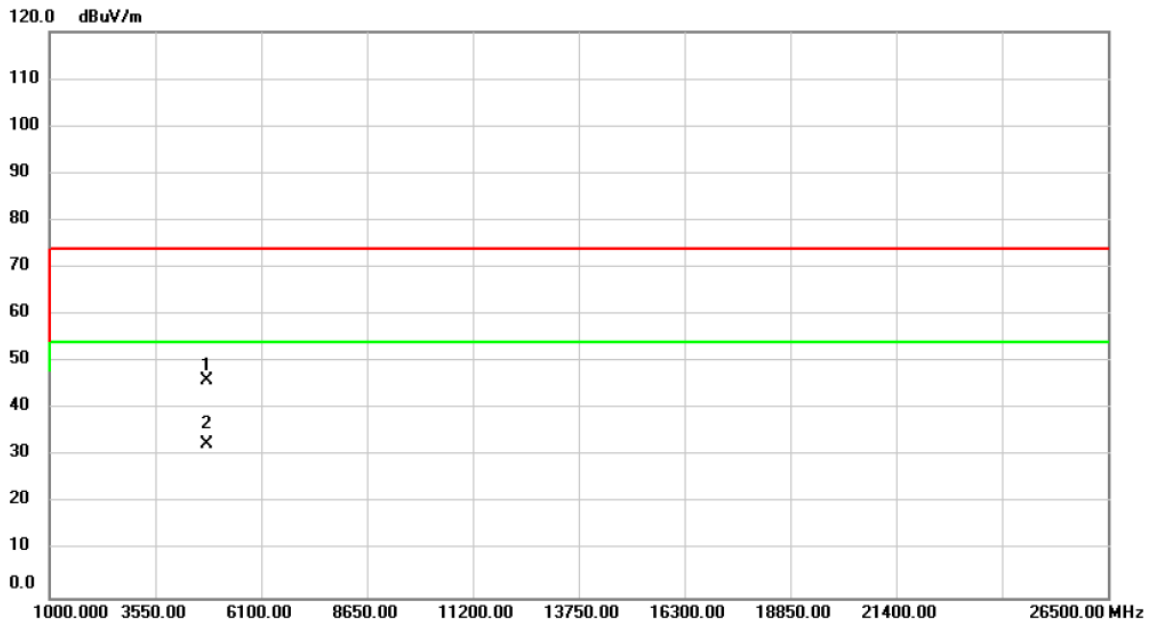

No.	Mk.	Freq.	Reading Level	Correct Factor	Measurement	Limit	Over	Detector	Comment
		MHz	dBuV	dB	dBuV/m	dBuV/m	dB		
1		4804.000	55.81	-9.84	45.97	74.00	-28.03	peak	
2	*	4804.000	42.34	-9.84	32.50	54.00	-21.50	AVG	

REMARKS:

- (1) Measurement Value = Reading Level + Correct Factor.
- (2) Margin Level = Measurement Value - Limit Value.

Test Mode	BT (3 Mbps)	Test Date	2020/5/13
Test Frequency	CH39: 2441 MHz	Polarization	Vertical

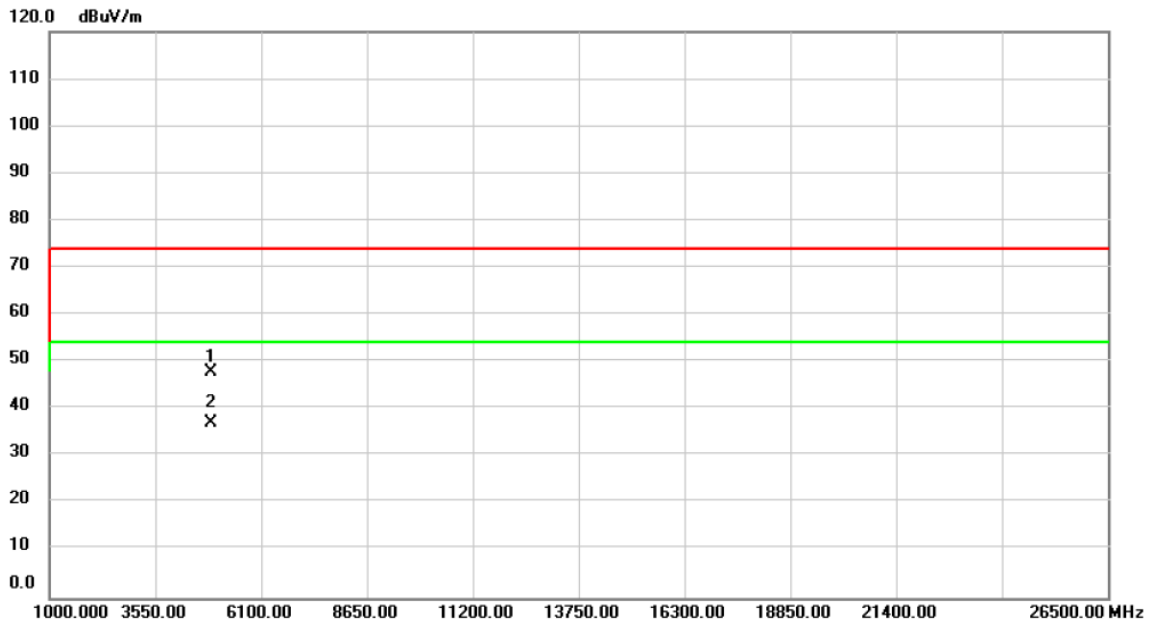

No.	Mk.	Freq.	Reading Level	Correct Factor	Measurement	Limit	Over	Detector	Comment
		MHz	dBuV	dB	dBuV/m	dBuV/m	dB		
1		4882.000	57.51	-9.66	47.85	74.00	-26.15	peak	
2	*	4882.000	46.64	-9.66	36.98	54.00	-17.02	AVG	

REMARKS:

- (1) Measurement Value = Reading Level + Correct Factor.
- (2) Margin Level = Measurement Value - Limit Value.

Test Mode	BT (3 Mbps)	Test Date	2020/5/13
Test Frequency	CH39: 2441 MHz	Polarization	Horizontal

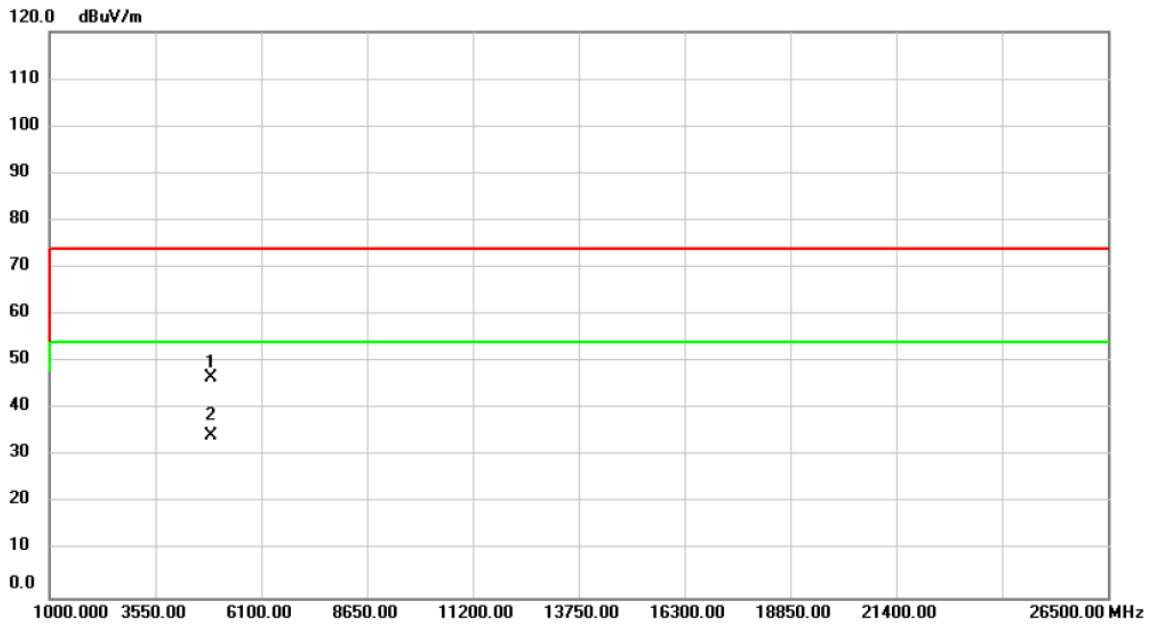

No.	Mk.	Freq.	Reading Level	Correct Factor	Measurement	Limit	Over	Detector	Comment
		MHz	dBuV	dB	dBuV/m	dBuV/m	dB		
1		4882.000	56.21	-9.66	46.55	74.00	-27.45	peak	
2	*	4882.000	44.05	-9.66	34.39	54.00	-19.61	AVG	

REMARKS:

- (1) Measurement Value = Reading Level + Correct Factor.
- (2) Margin Level = Measurement Value - Limit Value.

Test Mode	BT (3 Mbps)	Test Date	2020/5/13
Test Frequency	CH79: 2480 MHz	Polarization	Vertical

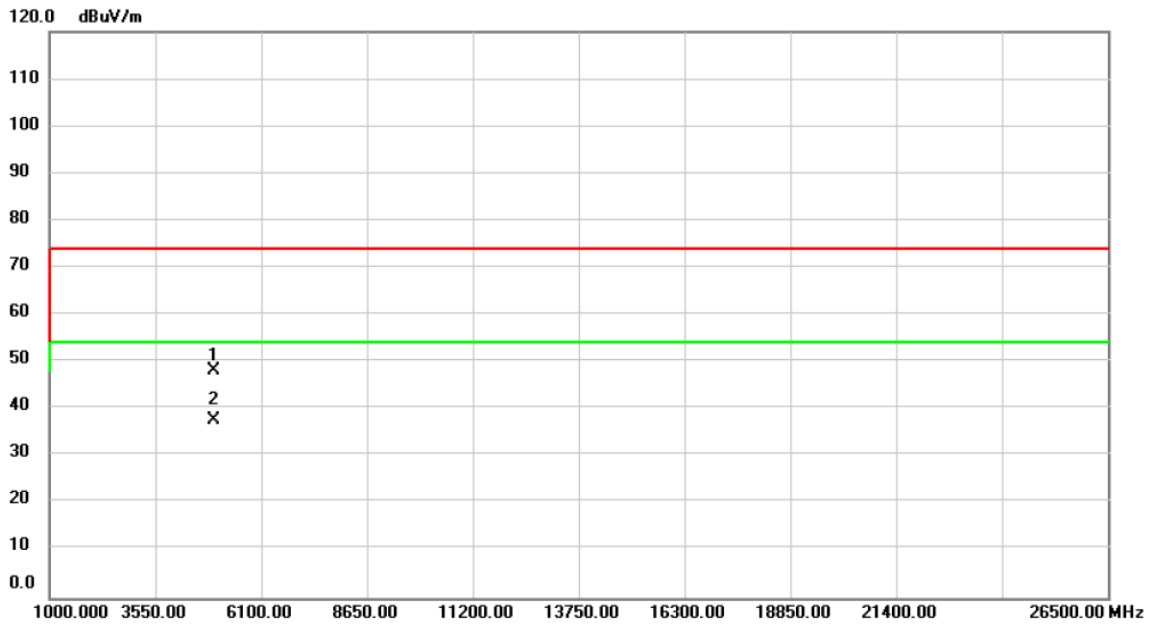

No.	Mk.	Freq.	Reading Level	Correct Factor	Measurement	Limit	Over	Detector	Comment
		MHz	dBuV	dB	dBuV/m	dBuV/m	dB		
1		4960.000	57.77	-9.48	48.29	74.00	-25.71	peak	
2	*	4960.000	47.08	-9.48	37.60	54.00	-16.40	AVG	

REMARKS:

- (1) Measurement Value = Reading Level + Correct Factor.
- (2) Margin Level = Measurement Value - Limit Value.

Test Mode	BT (3 Mbps)	Test Date	2020/5/13
Test Frequency	CH79: 2480 MHz	Polarization	Horizontal

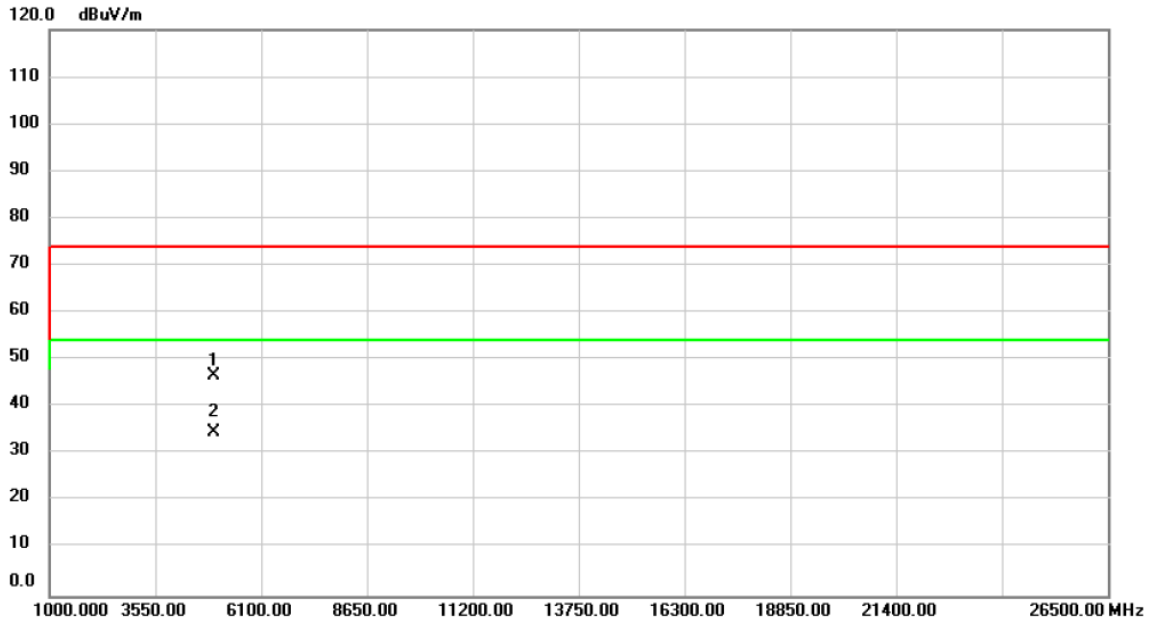

No.	Mk.	Freq.	Reading Level	Correct Factor	Measurement	Limit	Over	Detector	Comment
		MHz	dBuV	dB	dBuV/m	dBuV/m	dB		
1		4960.000	56.13	-9.48	46.65	74.00	-27.35	peak	
2	*	4960.000	44.03	-9.48	34.55	54.00	-19.45	AVG	

REMARKS:

- (1) Measurement Value = Reading Level + Correct Factor.
- (2) Margin Level = Measurement Value - Limit Value.

APPENDIX D OUTPUT POWER

Test Mode :	TX Mode _1Mbps	Tested Date	2020/5/20
-------------	----------------	-------------	-----------

Frequency (MHz)	Conducted Peak Power (dBm)	Conducted Peak Power (W)	Max. Limit (dBm)	Max. Limit (W)	Test Result
2402	9.28	0.0085	21.00	0.1250	Pass
2441	10.15	0.0104	21.00	0.1250	Pass
2480	10.80	0.0120	21.00	0.1250	Pass

Test Mode :	TX Mode _2Mbps	Tested Date	2020/5/20
-------------	----------------	-------------	-----------

Frequency (MHz)	Conducted Peak Power (dBm)	Conducted Peak Power (W)	Max. Limit (dBm)	Max. Limit (W)	Test Result
2402	8.88	0.0077	21.00	0.1250	Pass
2441	9.63	0.0092	21.00	0.1250	Pass
2480	10.23	0.0105	21.00	0.1250	Pass

Test Mode :	TX Mode _3Mbps	Tested Date	2020/5/20
-------------	----------------	-------------	-----------

Frequency (MHz)	Conducted Peak Power (dBm)	Conducted Peak Power (W)	Max. Limit (dBm)	Max. Limit (W)	Test Result
2402	8.90	0.0078	21.00	0.1250	Pass
2441	9.64	0.0092	21.00	0.1250	Pass
2480	10.24	0.0106	21.00	0.1250	Pass

End of Test Report