

# RADIO TEST REPORT

## FCC 47 CFR PART 15 SUBPART C

<b>Test Standard</b>	<b>FCC Part 15.247</b>
<b>Product name</b>	<b>HANDHELD COMPUTER</b>
<b>Brand Name</b>	<b>MilDef</b>
<b>Model No.</b>	<b>DF10</b>
<b>Test Result</b>	<b>Pass</b>
<b>Statements of Conformity</b>	<b>Determination of compliance is based on the results of the compliance measurement, not taking into account measurement instrumentation uncertainty.</b>

The test Result was tested by Compliance Certification Services Inc. The test data, data evaluation, test procedures, and equipment configurations shown in this report were given in ANSI C63.10: 2013 and compliance standards.

The test results of this report relate only to the tested sample (EUT) identified in this report.

The test Report of full or partial shall not copy. Without written approval of Compliance Certification Services Inc. (Wugu Laboratory)

Approved by:

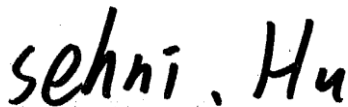

---

Sehni Hu  
 Supervisor

Unless otherwise stated the results shown in this test report refer only to the sample(s) tested and such sample(s) are retained for 90 days only.  
 除非另有說明，此報告結果僅對測試之樣品負責，同時此樣品僅保留90天。本報告未經本公司書面許可，不可部份複製。

This document is issued by the Company subject to its General Conditions of Service printed overleaf, available on request or accessible at <http://www.sgs.com.tw/Terms-and-Conditions> and, for electronic format documents, subject to Terms and Conditions for Electronic Documents at <http://www.sgs.com.tw/Terms-and-Conditions>. Attention is drawn to the limitation of liability, indemnification and jurisdiction issues defined therein. Any holder of this document is advised that information contained hereon reflects the Company's findings at the time of its intervention only and within the limits of client's instruction, if any. The Company's sole responsibility is to its Client and this document does not exonerate parties to a transaction from exercising all their rights and obligations under the transaction documents. This document cannot be reproduced, except in full, without prior written approval of the Company. Any unauthorized alteration, forgery or falsification of the content or appearance of this document is unlawful and offenders may be prosecuted to the fullest extent of the law.

### Revision History

Rev.	Issue Date	Revisions	Effect Page	Revised By
00	October 11, 2022	Initial Issue	ALL	Allison Chen

## Table of contents

1.	GENERAL INFORMATION .....	4
1.1	EUT INFORMATION .....	4
1.2	EUT CHANNEL INFORMATION .....	5
1.3	ANTENNA INFORMATION .....	5
1.4	MEASUREMENT UNCERTAINTY.....	6
1.5	FACILITIES AND TEST LOCATION .....	7
1.6	INSTRUMENT CALIBRATION .....	8
1.7	SUPPORT AND EUT ACCESSORIES EQUIPMENT .....	9
1.8	TEST METHODOLOGY AND APPLIED STANDARDS .....	9
2.	TEST SUMMARY .....	10
3.	DESCRIPTION OF TEST MODES.....	11
3.1	THE WORST MODE OF OPERATING CONDITION .....	11
3.2	THE WORST MODE OF MEASUREMENT .....	12
3.3	EUT DUTY CYCLE.....	13
4.	TEST RESULT .....	14
4.1	AC POWER LINE CONDUCTED EMISSION .....	14
4.2	6DB BANDWIDTH AND OCCUPIED BANDWIDTH (99%) .....	19
4.3	OUTPUT POWER MEASUREMENT .....	25
4.4	POWER SPECTRAL DENSITY.....	28
4.5	CONDUCTED BAND EDGE AND SPURIOUS EMISSION .....	32
4.6	RADIATION BANDEDGE AND SPURIOUS EMISSION .....	39
APPENDIX 1 - PHOTOGRAPHS OF EUT		

## 1. GENERAL INFORMATION

### 1.1 EUT INFORMATION

<b>Applicant</b>	MilDef Crete Inc. 7F, No.250, Sec.3,Pei Shen Rd.,Shen Keng District,New Taipei City, Taiwan
<b>Manufacturer</b>	MilDef Crete Inc. 7F, No.250, Sec.3,Pei Shen Rd.,Shen Keng District,New Taipei City, Taiwan
<b>Equipment</b>	HANDHELD COMPUTER
<b>Model Name</b>	DF10
<b>Model Discrepancy</b>	N/A
<b>Brand Name</b>	MilDef
<b>Received Date</b>	July 13, 2022
<b>Date of Test</b>	August 10~22, 2022
<b>Power Supply</b>	<p>1. Power from Adapter. ADAPTER TECH. / COP060A1-P200 I/P: 100-240Vac, 50-60Hz, 1.5MAX O/P: 5.0Vdc, 3.0A, 15.0W or 9.0Vdc, 3.0A, 27.0W or 12.0Vdc, 3.0A, 36.0W or 15.0Vdc, 3.0A, 45.0W or 20.0Vdc, 3.0A, 60.0W</p> <p>2. Power from Battery. Rating: 3.6VDC, 4040mAh</p>

**Remark:**

- For more details, please refer to the User's manual of the EUT.
- Disclaimer: Antenna information is provided by the applicant, test results of this report are applicable to the sample EUT received.

Report No.: TWMK2209003617KR

## 1.2 EUT CHANNEL INFORMATION

Frequency Range	2402MHz-2480MHz
Modulation Type	GFSK for BLE 1 Mbps GFSK for BLE 2 Mbps
Number of channels	40 Channels

**Remark:**

Refer as ANSI C63.10: 2013 clause 5.6.1 Table 4 for test channels

Number of frequencies to be tested		
Frequency range in which device operates	Number of frequencies	Location in frequency range of operation
<input type="checkbox"/> 1 MHz or less	1	Middle
<input type="checkbox"/> 1 MHz to 10 MHz	2	1 near top and 1 near bottom
<input checked="" type="checkbox"/> More than 10 MHz	3	1 near top, 1 near middle, and 1 near bottom

## 1.3 ANTENNA INFORMATION

Antenna Specification	<input checked="" type="checkbox"/> PIFA <input type="checkbox"/> PCB <input type="checkbox"/> Dipole <input type="checkbox"/> Chip <input type="checkbox"/> Coils
Antenna Gain	Gain: 0.92 dBi
Brand / Model	MilDef Crete Inc. / G980210104

**Notes:**

1.The antenna(s) of the EUT are permanently attached and there are no provisions for connection to an external antenna. So the EUT complies with the requirements of §15.203.

## 1.4 MEASUREMENT UNCERTAINTY

PARAMETER	UNCERTAINTY
AC Powerline Conducted Emission	± 2.1183
Channel Bandwidth	± 2.1863
RF output power (Power Meter + Power sensor)	± 1.2688
Power Spectral density	± 2.1855
Conducted Bandedge	± 2.1866
Conducted Spurious Emission	± 2.1859
Radiated Emission_9kHz-30MHz	± 3.814
Radiated Emission_30MHz-200MHz	± 4.272
Radiated Emission_200MHz-1GHz	± 4.619
Radiated Emission_1GHz-6GHz	± 5.522
Radiated Emission_6GHz-18GHz	± 5.228
Radiated Emission_18GHz-26GHz	± 4.089
Radiated Emission_26GHz-40GHz	± 4.019

**Remark:**

- 1.This uncertainty represents an expanded uncertainty expressed at approximately the 95% confidence level using a coverage factor of k=2
2. ISO/IEC 17025 requires that an estimate of the measurement uncertainties associated with the emissions test results be included in the report.

Report No.: TWMK2209003617KR

## 1.5 FACILITIES AND TEST LOCATION

All measurement facilities used to collect the measurement data are located at No.11, Wugong 6th Rd., Wugu Dist., New Taipei City, Taiwan. (R.O.C.)

CAB identifier: TW1309

Test site	Test Engineer	Remark
AC Conduction Room	Tony Chao	-
Radiation	Ray Li, Tony Chao	-
RF Conducted	Marco Chan	-

**Remark:** The lab has been recognized as the FCC accredited lab. under the KDB 974614 D01 and is listed in the FCC public Access Link (PAL) database, FCC Registration No. :444940, the FCC Designation No.:TW1309

## 1.6 INSTRUMENT CALIBRATION

RF Conducted Test Site					
Name of Equipment	Manufacturer	Model	Serial Number	Calibration Date	Calibration Due
Coaxial Cable	Woken	WC12	CC003	06/27/2022	06/26/2023
Power Meter	Anritsu	ML2496A	2136002	12/06/2021	12/05/2022
Power Seneor	Anritsu	MA2411B	1911386	08/08/2022	08/07/2023
Power Seneor	Anritsu	MA2411B	1911387	08/08/2022	08/07/2023
EXA Signal Analyzer	KEYSIGHT	N9010B	MY55460167	09/07/2021	09/06/2022
<b>Software</b>	Radio Test Software Ver. 21				

AC-line Conduction Test Room					
Name of Equipment	Manufacturer	Model	Serial Number	Calibration Date	Calibration Due
CABLE	EMCI	CFD300-NL	CERF	06/27/2022	06/26/2023
EMI Test Receiver	R&S	ESCI	100064	06/17/2022	06/16/2023
LISN	SCHAFFNER	NNB 41	03/10013	02/15/2022	02/14/2023
<b>Software</b>	EZ-EMC(CCS-3A1-CE-wugu)				

3M 966A Chamber					
Name of Equipment	Manufacturer	Model	Serial Number	Calibration Date	Calibration Due
Band Reject Filters	MICRO TRONICS	BRM 50702	112	11/23/2021	11/22/2022
Bilog Antenna	Sunol Sciences	JB3	A030105	08/03/2022	08/02/2023
Coaxial Cable	HUBER SUHNER	SUCOFLEX 104PEA	20995	02/23/2022	02/22/2023
Coaxial Cable	Woken	J-1099	201709090004	12/23/2021	12/22/2022
Coaxial Cable	EMCI	EMC105	190914+33953	06/15/2022	06/14/2023
Digital Thermo-Hygro Meter	WISEWIND	1206	D07	12/28/2021	12/27/2022
Horn Antenna	ETS LINDGREN	3116	00026370	11/30/2021	11/29/2022
Horn Antenna	MCTD	1209	DRH13M02003	01/25/2022	01/24/2023
K Type Cable	Huber+Suhner	SUCOFLEX 102	29406/2	12/05/2021	12/04/2022
Pre-Amplifier	EMEC	EM330	060609	02/23/2022	02/22/2023
Pre-Amplifier	HP	8449B	3008A00965	12/24/2021	12/23/2022
PSA Series Spectrum Analyzer	Agilent	E4446A	MY46180323	12/06/2021	12/05/2022
Antenna Tower	CCS	CC-A-1F	N/A	N.C.R	N.C.R
Controller	CCS	CC-C-1F	N/A	N.C.R	N.C.R
Turn Table	CCS	CC-T-1F	N/A	N.C.R	N.C.R
<b>Software</b>	e3 210616				

### Remark:

1. Each piece of equipment is scheduled for calibration once a year.
2. N.C.R. = No Calibration Required.



## 1.7 SUPPORT AND EUT ACCESSORIES EQUIPMENT

EUT Accessories Equipment						
No.	Equipment	Brand	Model	Series No.	FCC ID	IC
	N/A					

Support Equipment						
No.	Equipment	Brand	Model	Series No.	FCC ID	IC
	N/A					

## 1.8 TEST METHODOLOGY AND APPLIED STANDARDS

The test methodology, setups and results comply with all requirements in accordance with ANSI C63.10:2013, FCC Part 2, FCC Part 15.247 and KDB 558074 D01.

## 2. TEST SUMMARY

FCC Standard Section	Report Section	Test Item	Result
15.203	1.3	Antenna Requirement	Pass
15.207(a)	4.1	AC Conducted Emission	Pass
15.247(a)(2)	4.2	6 dB Bandwidth	Pass
-	4.2	Occupied Bandwidth (99%)	Pass
15.247(b)(3)	4.3	Output Power Measurement	Pass
15.247(e)	4.4	Power Spectral Density	Pass
15.247(d)	4.5	Conducted Band Edge	Pass
15.247(d)	4.5	Conducted Spurious Emission	Pass
15.247(d)	4.6	Radiation Band Edge	Pass
15.247(d)	4.6	Radiation Spurious Emission	Pass

Report No.: TWMK2209003617KR

### 3. DESCRIPTION OF TEST MODES

#### 3.1 THE WORST MODE OF OPERATING CONDITION

Operation mode	BLE Mode (1Mbps) BLE Mode (2Mbps)
Test Channel Frequencies	1.Lowest Channel : 2402MHz 2.Middle Channel : 2442MHz 3.Highest Channel : 2480MHz

**Remark:**

1. EUT pre-scanned data rate of output power for each mode, the worst data rate were recorded in this report.

Report No.: TWMK2209003617KR

### 3.2 THE WORST MODE OF MEASUREMENT

AC Power Line Conducted Emission	
Test Condition	AC Power line conducted emission for line and neutral
Power supply Mode	Mode 1: EUT power by Adapter
Worst Mode	<input checked="" type="checkbox"/> Mode 1 <input type="checkbox"/> Mode 2 <input type="checkbox"/> Mode 3 <input type="checkbox"/> Mode 4

Remark:

1. The worst mode was record in this test report.
2. AC power line conducted emission and for below 1G radiation emission were performed the EUT transmit at the highest output power channel as worse case.

Radiated Emission Measurement Above 1G	
Test Condition	Radiated Emission Above 1G
Power supply Mode	Mode 1: EUT power by Adapter
Worst Mode	<input checked="" type="checkbox"/> Mode 1 <input type="checkbox"/> Mode 2 <input type="checkbox"/> Mode 3 <input type="checkbox"/> Mode 4
Worst Position	<input type="checkbox"/> Placed in fixed position. <input checked="" type="checkbox"/> Placed in fixed position at X-Plane (E2-Plane) <input type="checkbox"/> Placed in fixed position at Y-Plane (E1-Plane) <input type="checkbox"/> Placed in fixed position at Z-Plane (H-Plane)

Radiated Emission Measurement Below 1G	
Test Condition	Radiated Emission Below 1G
Power supply Mode	Mode 1: EUT power by Adapter
Worst Mode	<input checked="" type="checkbox"/> Mode 1 <input type="checkbox"/> Mode 2 <input type="checkbox"/> Mode 3 <input type="checkbox"/> Mode 4

Remark:

1. The worst mode was record in this test report.
2. EUT pre-scanned in three axis ,X,Y, Z and two polarity, for radiated measurement. The worst case(X-Plane) were recorded in this report

Report No.: TWMK2209003617KR

### 3.3 EUT DUTY CYCLE

Temperature: 25.6°C

Test date: August 10, 2022

Humidity: 46% RH

Tested by: Marco Chan

Duty Cycle				
Configuration	Duty Cycle (%) = Ton / (Ton+Toff)	Duty Factor (dB) =10*log ( 1/Duty Cycle )	1/T (kHz)	VBW setting (kHz)
BLE 1M	61.60	2.10	2.60	3.00
BLE 2M	57.33	2.42	0.93	1.00

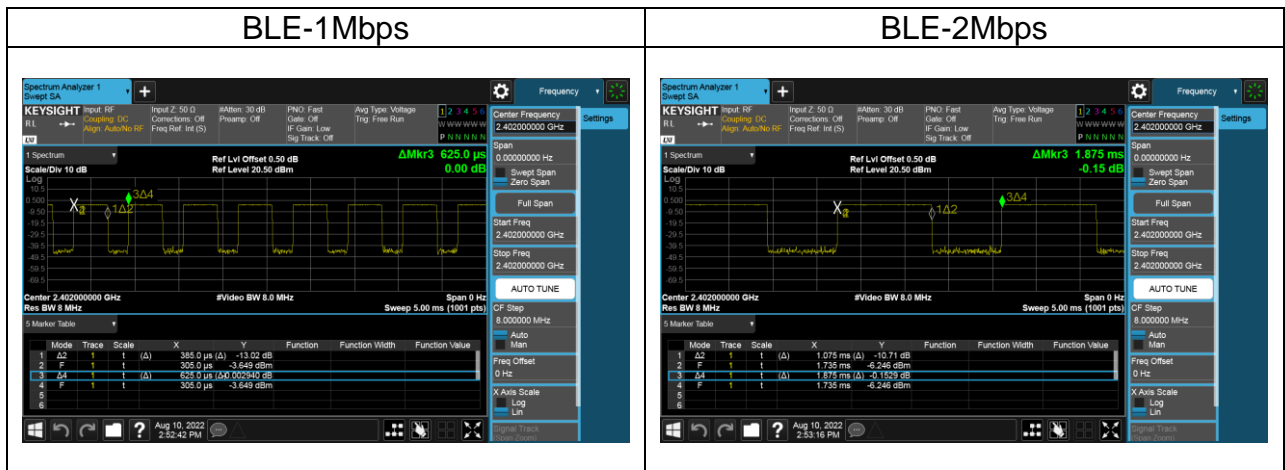

Report No.: TWMK2209003617KR

## 4. TEST RESULT

### 4.1 AC POWER LINE CONDUCTED EMISSION

#### 4.1.1 Test Limit

According to §15.207(a),

Frequency Range (MHz)	Limits(dB $\mu$ V)	
	Quasi-peak	Average
0.15 to 0.50	66 to 56*	56 to 46*
0.50 to 5	56	46
5 to 30	60	50

\* Decreases with the logarithm of the frequency.

#### 4.1.2 Test Procedure

Test method Refer as ANSI C63.10: 2013 clause 6.2,

1. The EUT was placed above horizontal ground plane and 0.4m above vertical ground plane
2. EUT connected to the line impedance stabilization network (LISN)
3. Receiver set RBW of 9kHz and Detector Peak, and note as quasi-peak and average.
4. Maximum procedure was performed on the six highest emissions to ensure EUT compliance.
5. Recorded Line for Neutral and Line.

#### 4.1.3 Test Setup

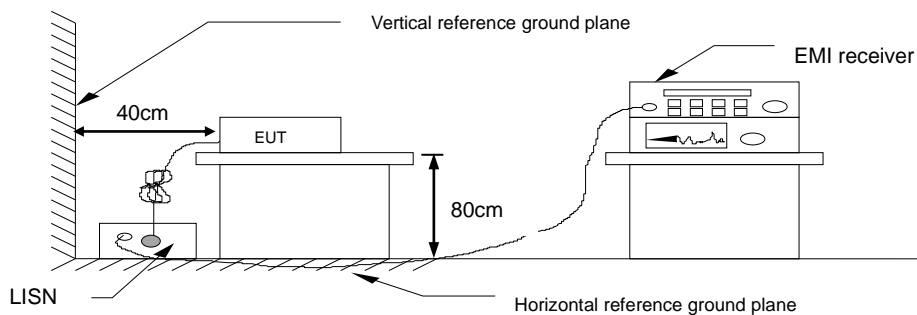

#### 4.1.4 Test Result

Pass.

### Test Data

Test Mode:	BLE 1M	Temp/Hum	24.9(°C)/ 51%RH
Phase:	Line	Test Date	August 17, 2022
Test Voltage:	120Vac, 60Hz	Test Engineer	Tony Chao

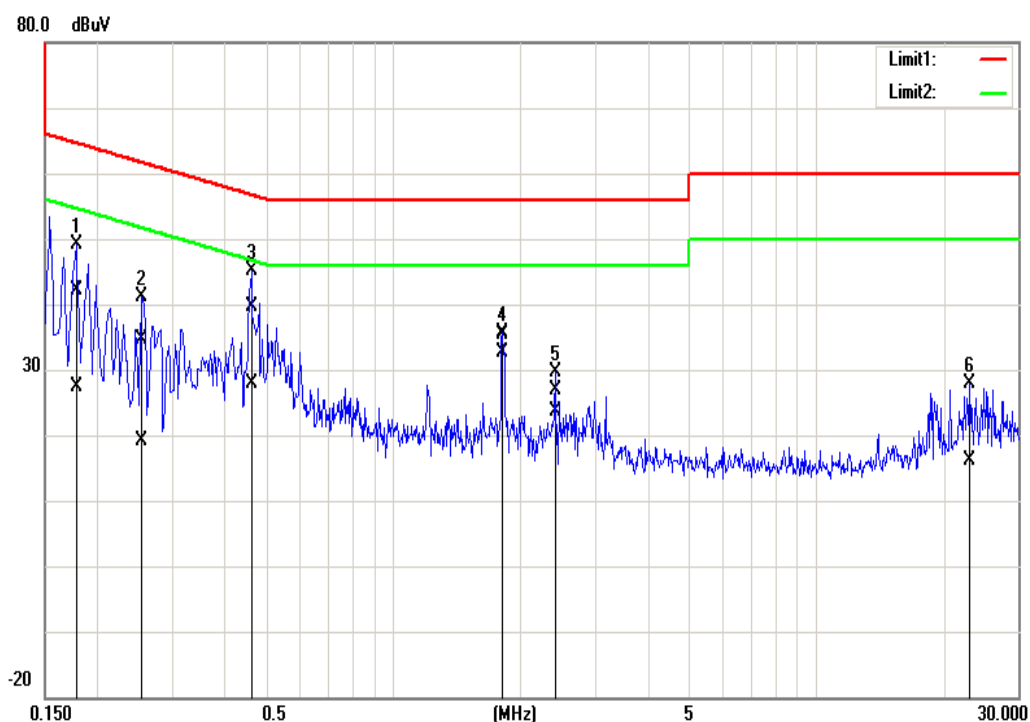

Frequency (MHz)	Quasi Peak reading (dBuV)	Average reading (dBuV)	Correction factor (dB)	Quasi Peak result (dBuV)	Average result (dBuV)	Quasi Peak limit (dBuV)	Average limit (dBuV)	Quasi Peak margin (dB)	Average margin (dB)	Remark
0.1780	31.87	17.22	10.18	42.05	27.40	64.58	54.58	-22.53	-27.18	Pass
0.2540	24.43	9.00	10.18	34.61	19.18	61.63	51.63	-27.02	-32.45	Pass
0.4620	29.41	17.65	10.19	39.60	27.84	56.66	46.66	-17.06	-18.82	Pass
1.8100	25.15	22.49	10.25	35.40	32.74	56.00	46.00	-20.60	-13.26	Pass
2.4100	16.50	13.35	10.26	26.76	23.61	56.00	46.00	-29.24	-22.39	Pass
23.0820	17.51	5.87	10.28	27.79	16.15	60.00	50.00	-32.21	-33.85	Pass

Note: Correction factor = LISN loss + Cable loss.

Test Mode:	BLE 1M	Temp/Hum	24.9(°C)/ 51%RH
Phase:	Neutral	Test Date	August 17, 2022
Test Voltage:	120Vac, 60Hz	Test Engineer	Tony Chao

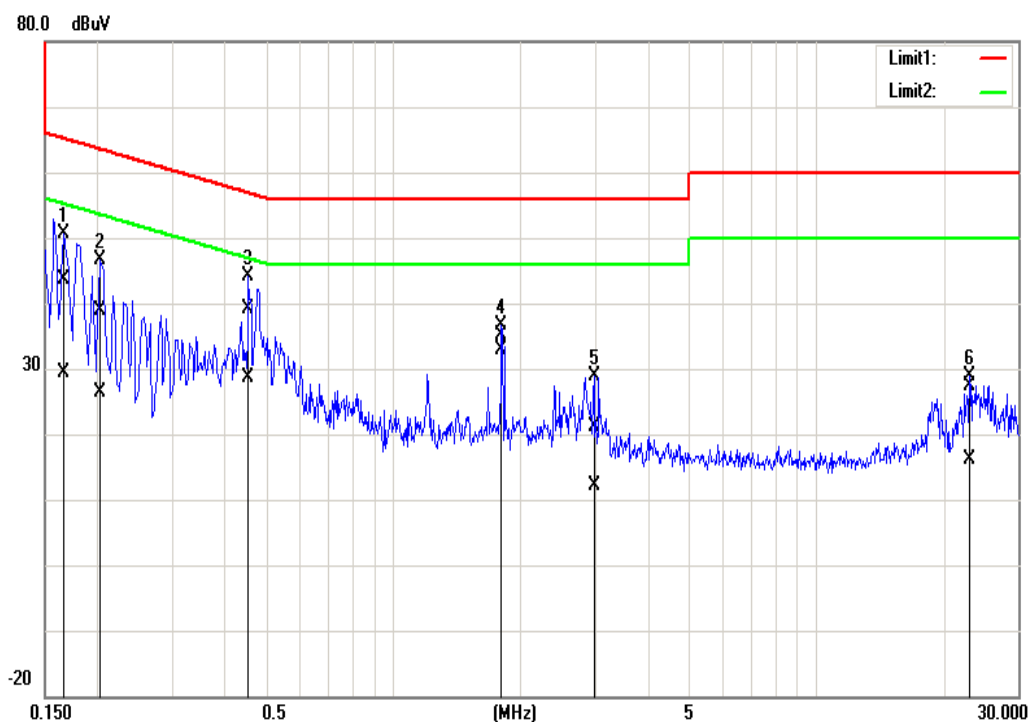

Frequency (MHz)	Quasi Peak reading (dBuV)	Average reading (dBuV)	Correction factor (dB)	Quasi Peak result (dBuV)	Average result (dBuV)	Quasi Peak limit (dBuV)	Average limit (dBuV)	Quasi Peak margin (dB)	Average margin (dB)	Remark
0.1660	33.53	19.30	10.17	43.70	29.47	65.16	55.16	-21.46	-25.69	Pass
0.2020	28.80	16.19	10.17	38.97	26.36	63.53	53.53	-24.56	-27.17	Pass
0.4540	29.01	18.48	10.18	39.19	28.66	56.80	46.80	-17.61	-18.14	Pass
1.8060	24.98	22.76	10.23	35.21	32.99	56.00	46.00	-20.79	-13.01	Pass
2.9860	10.94	1.85	10.26	21.20	12.11	56.00	46.00	-34.80	-33.89	Pass
23.0820	16.85	5.56	10.47	27.32	16.03	60.00	50.00	-32.68	-33.97	Pass

Note: Correction factor = LISN loss + Cable loss.



Test Mode:	BLE 2M	Temp/Hum	24.9(°C)/ 51%RH
Phase:	Line	Test Date	August 17, 2022
Test Voltage:	120Vac, 60Hz	Test Engineer	Tony Chao

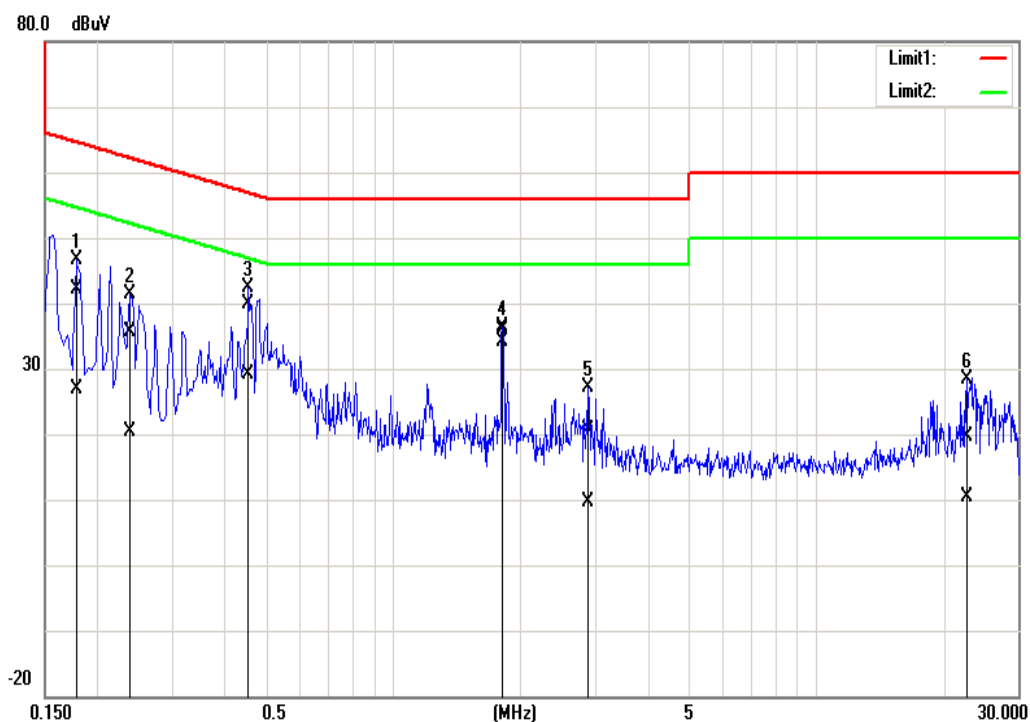

Frequency (MHz)	Quasi Peak reading (dBuV)	Average reading (dBuV)	Correction factor (dB)	Quasi Peak result (dBuV)	Average result (dBuV)	Quasi Peak limit (dBuV)	Average limit (dBuV)	Quasi Peak margin (dB)	Average margin (dB)	Remark
0.1780	32.05	16.73	10.18	42.23	26.91	64.58	54.58	-22.35	-27.67	Pass
0.2380	25.33	10.11	10.18	35.51	20.29	62.17	52.17	-26.66	-31.88	Pass
0.4540	29.59	19.04	10.19	39.78	29.23	56.80	46.80	-17.02	-17.57	Pass
1.8100	25.68	24.00	10.25	35.93	34.25	56.00	46.00	-20.07	-11.75	Pass
2.8940	10.25	-0.63	10.28	20.53	9.65	56.00	46.00	-35.47	-36.35	Pass
22.7460	9.39	0.19	10.29	19.68	10.48	60.00	50.00	-40.32	-39.52	Pass

Note: Correction factor = LISN loss + Cable loss.

Test Mode:	BLE 2M	Temp/Hum	24.9(°C)/ 51%RH
Phase:	Neutral	Test Date	August 17, 2022
Test Voltage:	120Vac, 60Hz	Test Engineer	Tony Chao

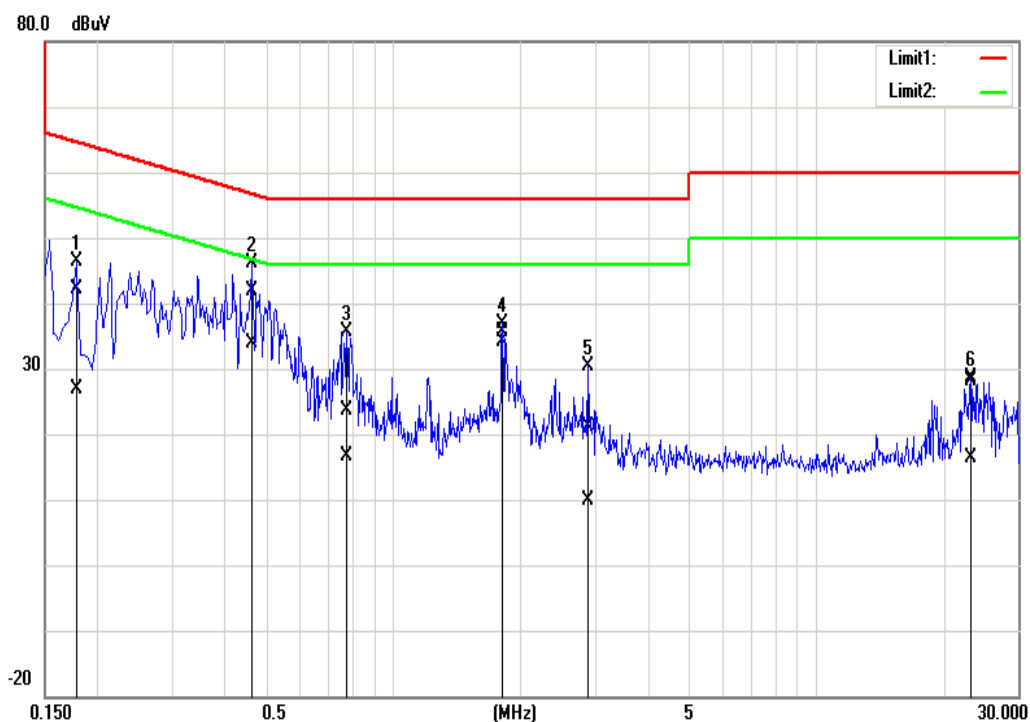

Frequency (MHz)	Quasi Peak reading (dBuV)	Average reading (dBuV)	Correction factor (dB)	Quasi Peak result (dBuV)	Average result (dBuV)	Quasi Peak limit (dBuV)	Average limit (dBuV)	Quasi Peak margin (dB)	Average margin (dB)	Remark
0.1780	31.99	16.68	10.17	42.16	26.85	64.58	54.58	-22.42	-27.73	Pass
0.4620	31.69	23.80	10.18	41.87	33.98	56.66	46.66	-14.79	-12.68	Pass
0.7780	13.51	6.47	10.20	23.71	16.67	56.00	46.00	-32.29	-29.33	Pass
1.8100	25.39	23.94	10.23	35.62	34.17	56.00	46.00	-20.38	-11.83	Pass
2.8940	10.91	-0.47	10.26	21.17	9.79	56.00	46.00	-34.83	-36.21	Pass
23.1740	17.60	5.82	10.47	28.07	16.29	60.00	50.00	-31.93	-33.71	Pass

Note: Correction factor = LISN loss + Cable loss.

Report No.: TWMK2209003617KR

## 4.2 6dB BANDWIDTH AND OCCUPIED BANDWIDTH (99%)

### 4.2.1 Test Limit

According to §15.247(a)(2)

#### 6 dB Bandwidth :

Limit	Shall be at least 500kHz
-------	--------------------------

Occupied Bandwidth(99%) : For reporting purposes only.

### 4.2.2 Test Procedure

Test method Refer as ANSI C63.10: 2013,

1. The EUT RF output connected to the spectrum analyzer by RF cable.
2. Setting maximum power transmit of EUT.
3. SA set RBW =100KHz, VBW = 300KHz and Detector = Peak, to measurement 6dB Bandwidth.
4. SA set RBW = 1% ~ 5% OBW, VBW = three times the RBW and Detector = Peak, to measurement 99% Bandwidth.
5. Measure and record the result of 6 dB Bandwidth and 99% Bandwidth. in the test report.

### 4.2.3 Test Setup

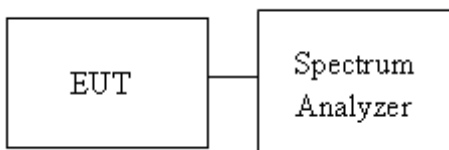

Report No.: TWMK2209003617KR

#### 4.2.4 Test Result

Temperature: 25.6°C

Test date: August 10, 2022

Humidity: 46% RH

Tested by: Marco Chan

Test mode: BLE-1Mbps mode / 2402-2480 MHz				
Channel	Frequency (MHz)	OBW (99%) (MHz)	6dB BW (MHz)	6dB limit (kHz)
Low	2402	1.0365	0.6950	≥500
Mid	2442	1.0368	0.6974	
High	2480	1.0369	0.6997	

Test mode: BLE-2Mbps mode / 2402-2480 MHz				
Channel	Frequency (MHz)	OBW (99%) (MHz)	6dB BW (MHz)	6dB limit (kHz)
Low	2402	2.0665	1.188	≥500
Mid	2442	2.0658	1.190	
High	2480	2.0668	1.188	

Report No.: TWMK2209003617KR

## Test Data

### 6dB BANDWIDTH

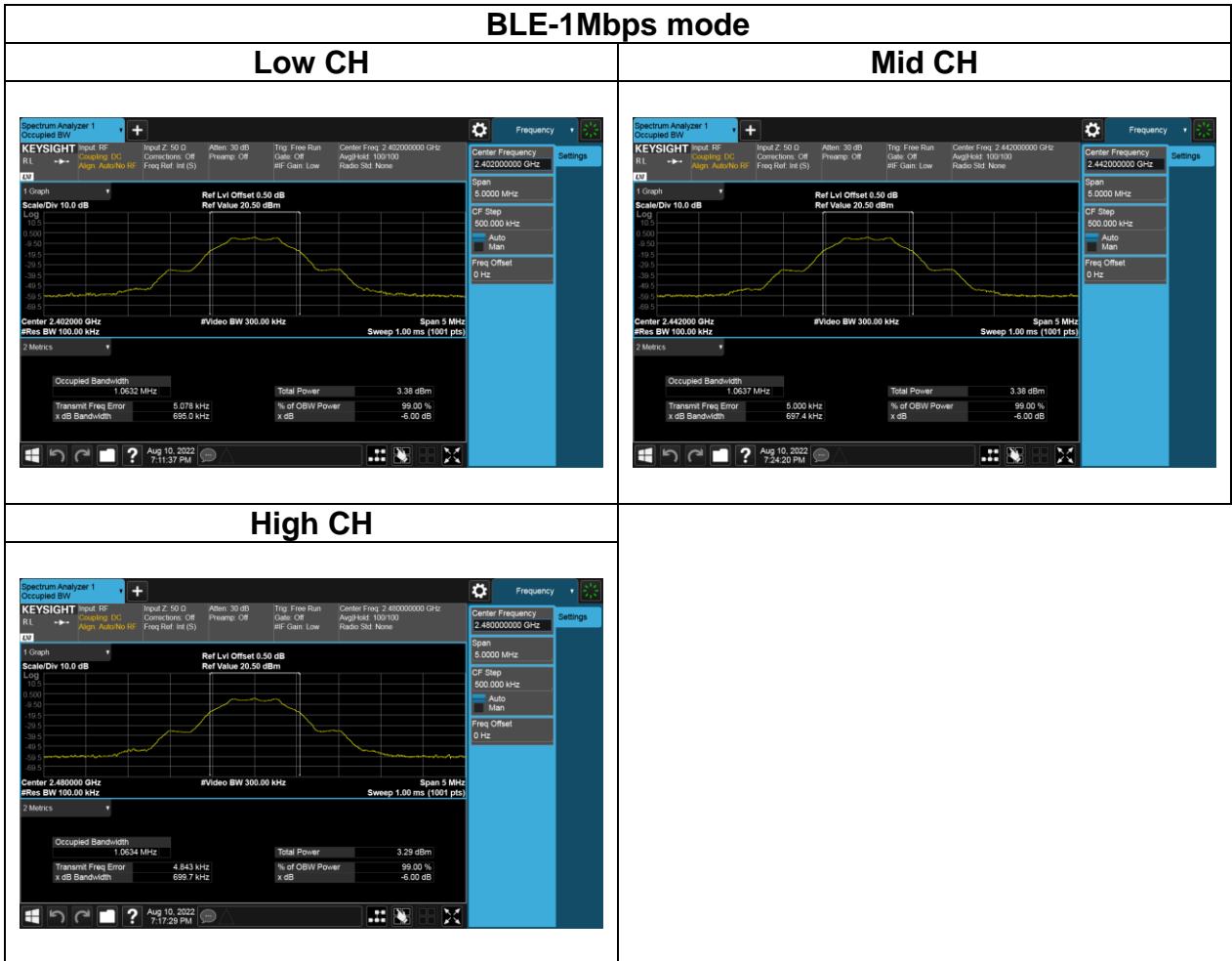

Report No.: TWMK2209003617KR

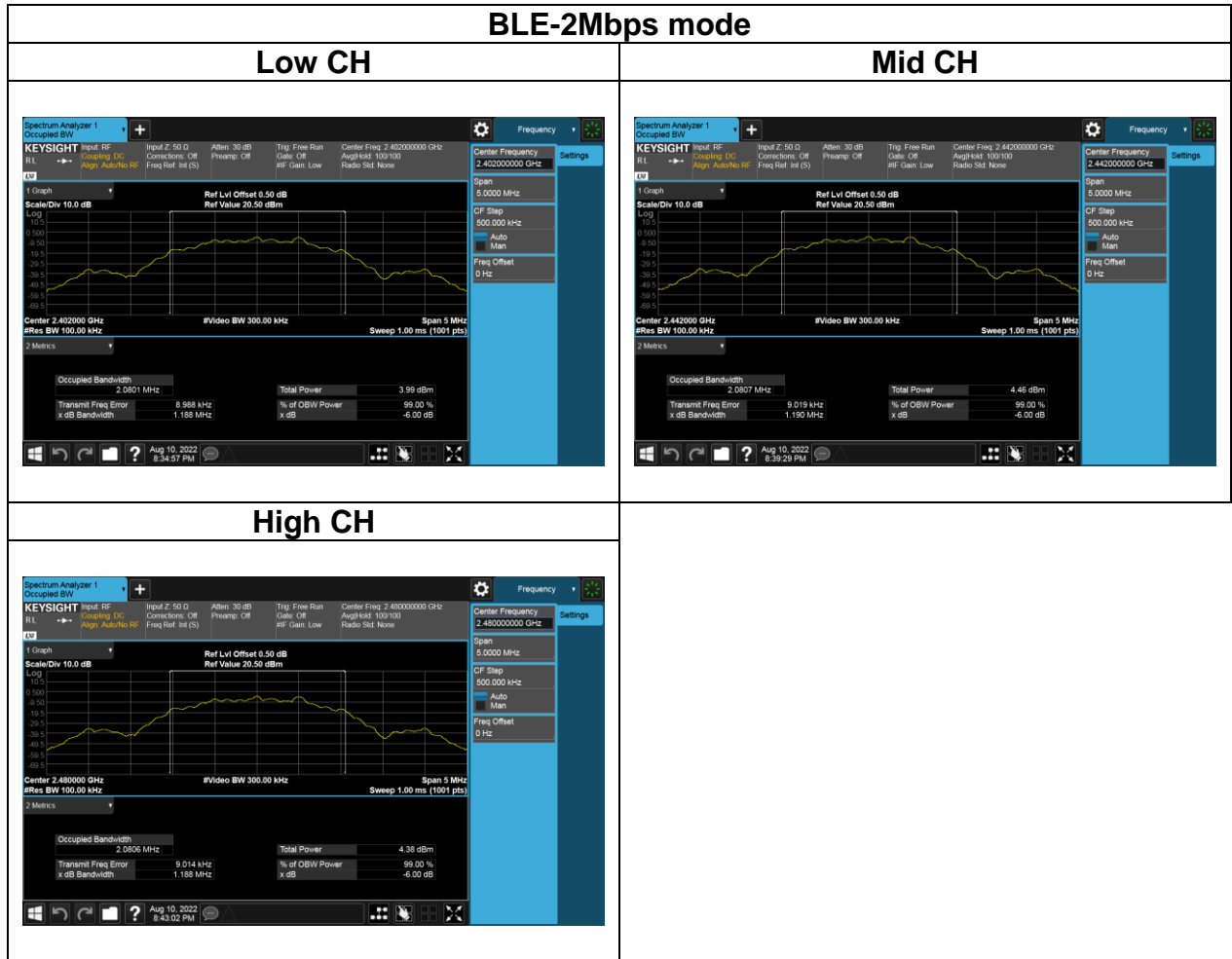

Report No.: TWMK2209003617KR

## Test Data

### BANDWIDTH (99%)

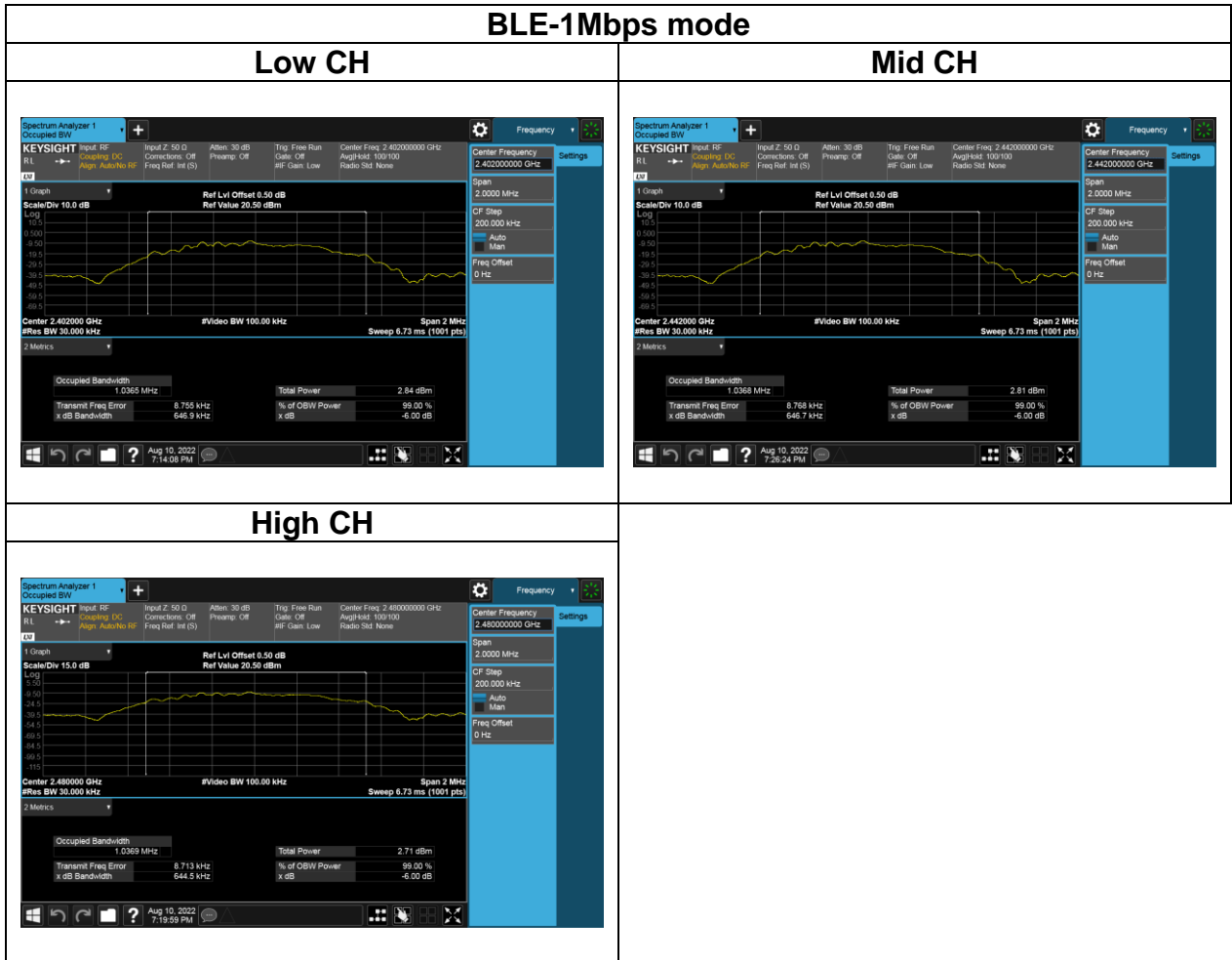

Report No.: TWMK2209003617KR

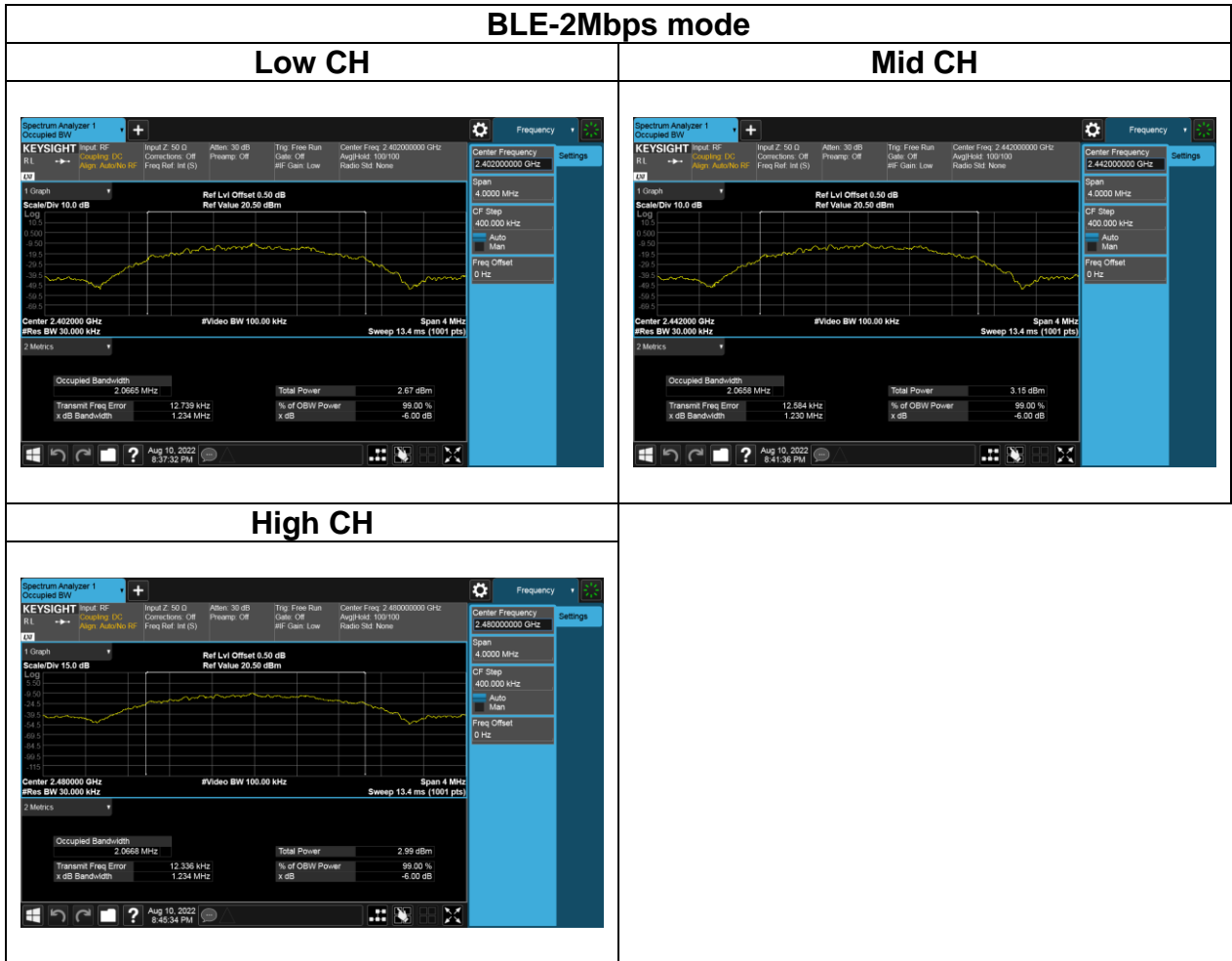



Report No.: TWMK2209003617KR

### 4.3 OUTPUT POWER MEASUREMENT

#### 4.3.1 Test Limit

According to §15.247(b)(3)

**Peak output power :**

**FCC**

For systems using digital modulation in the 902-928 MHz, 2400-2483.5 MHz, and 5725-5850 MHz bands: 1 Watt. As an alternative to a peak power measurement,

Limit	<input checked="" type="checkbox"/> Antenna not exceed 6 dBi : 30dBm <input type="checkbox"/> Antenna with DG greater than 6 dBi [ Limit = 30 – (DG – 6) ] <input type="checkbox"/> Point-to-point operation
-------	---

**Average output power :** For reporting purposes only.

### 4.3.2 Test Procedure

Test method Refer as ANSI C63.10:2013.

1. The EUT RF output connected to the power meter by RF cable.
2. Setting maximum power transmit of EUT.
3. The path loss was compensated to the results for each measurement.
4. Measure and record the result of Peak output power and Average output power. in the test report.

### 4.3.3 Test Setup

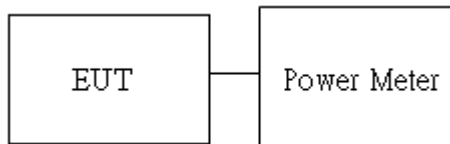

### 4.3.4 Test Result

Temperature: 25.6°C

Test date: August 10, 2022

Humidity: 46% RH

Tested by: Marco Chan

#### Peak output power :

##### BLE 1M mode:

CH	Frequency (MHz)	Power set	Peak Power Output (dBm)	Required Limit (dBm)
Low	2402	default	-3.26	30
Mid	2442	default	-2.96	30
High	2480	default	-3.02	30

##### BLE 2M mode:

CH	Frequency (MHz)	Power set	Peak Power Output (dBm)	Required Limit (dBm)
Low	2402	default	-3.26	30
Mid	2442	default	-2.98	30
High	2480	default	-3.01	30

#### Average output power :

##### BLE 1M mode:

CH	Frequency (MHz)	Power set	Peak Power Output (dBm)	Required Limit (dBm)
Low	2402	default	-3.48	30
Mid	2442	default	-3.18	30
High	2480	default	-3.19	30

##### BLE 2M mode:

CH	Frequency (MHz)	Power set	Peak Power Output (dBm)	Required Limit (dBm)
Low	2402	default	-3.29	30
Mid	2442	default	-3.41	30
High	2480	default	-3.29	30

Report No.: TWMK2209003617KR

## 4.4 POWER SPECTRAL DENSITY

### 4.4.1 Test Limit

According to §15.247(e)

For digitally modulated systems, the power spectral density conducted from the intentional radiator to the antenna shall not be greater than 8 dBm in any 3 kHz band during any time interval of continuous transmission.

Limit	<input checked="" type="checkbox"/> Antenna not exceed 6 dBi : 8dBm <input type="checkbox"/> Antenna with DG greater than 6 dBi [ Limit = 8 – (DG – 6) ] <input type="checkbox"/> Point-to-point operation :
-------	---

### 4.4.2 Test Procedure

Test method Refer as ANSI C63.10:2013.

1. The EUT RF output connected to the spectrum analyzer by RF cable.
2. Setting maximum power transmit of EUT
3. SA set RBW = 3kHz, VBW = 10kHz, Span = 1.5 times DTS Bandwidth (6 dB BW), Detector = Peak, Sweep Time = Auto and Trace = Max hold.
4. The path loss and Duty Factor were compensated to the results for each measurement by SA.
5. Mark the maximum level.
6. Measure and record the result of power spectral density. in the test report.

### 4.4.3 Test Setup

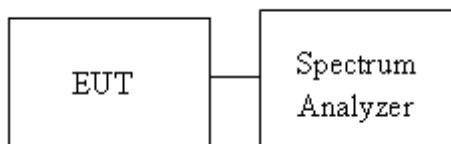

#### 4.4.4 Test Result

**Temperature:** 25.6°C                      **Test date:** August 10, 2022  
**Humidity:** 46% RH                      **Tested by:** Marco Chan

**BLE 1M mode**

Frequency (MHz)	RF Power Density (dBm/3kHz)	Maximum Limit (dBm/3kHz)	Result
2402	-17.89	8	PASS
2442	-17.94	8	PASS
2480	-18.02	8	PASS

**BLE 2M mode**

Frequency (MHz)	RF Power Density (dBm/3kHz)	Maximum Limit (dBm/3kHz)	Result
2402	-22.09	8	PASS
2442	-21.68	8	PASS
2480	-21.75	8	PASS

Report No.: TWMK2209003617KR

## Test Data

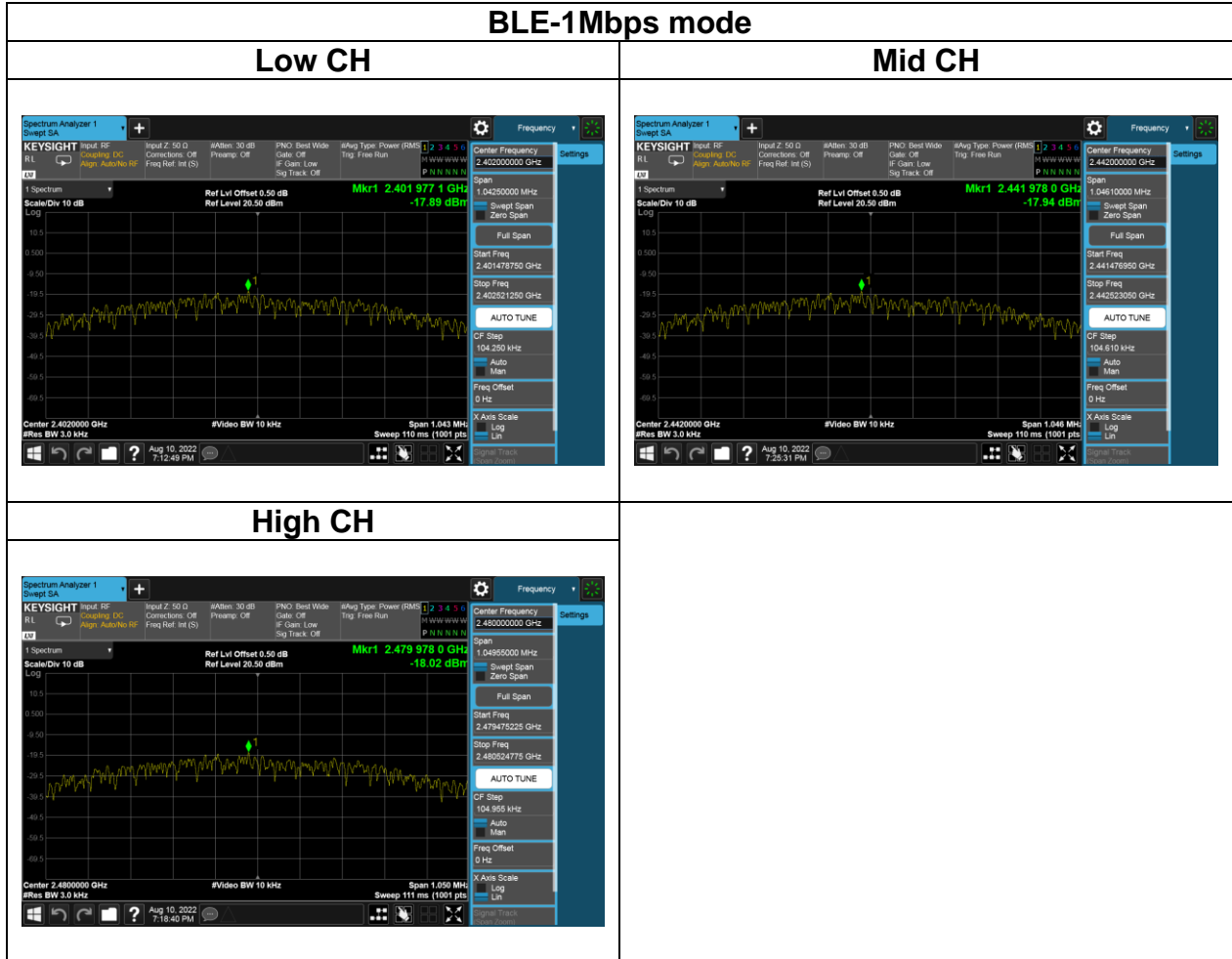

## BLE-2Mbps mode

### Low CH

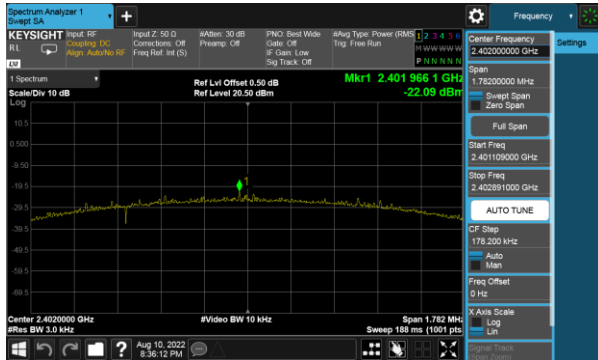

### Mid CH



### High CH



Report No.: TWMK2209003617KR

## 4.5 CONDUCTED BAND EDGE AND SPURIOUS EMISSION

### 4.5.1 Test Limit

According to §15.247(d)

**FCC:** In any 100 kHz bandwidth outside the authorized frequency band,

Non-restricted bands shall be attenuated at least 20 dB/30 dB relative to the maximum PSD level in 100 kHz by RF conducted or a radiated measurement which fall in the restricted bands, as defined in §15.205(a), must also comply with the radiated emission limits specified in §15.209(a).

### 4.5.2 Test Procedure

Test method Refer as ANSI C63.10:2013.

1. EUT RF output port connected to the SA by RF cable, and the path loss was compensated to result.
2. SA setting, RBW=100kHz, VBW=300kHz, Detector=Peak, Trace mode = max hold, SWT = Auto.
3. In any 100 kHz bandwidth outside the authorized frequency band, shall be attenuated at least 20 dB relative to the maximum in-band peak PSD level in 100 kHz when conducted power procedure is used. If the transmitter complies with the conducted power limits based on the use of RMS averaging over a time interval, the attenuation required under this paragraph shall be 30 dB instead of 20 dB.

### 4.5.3 Test Setup

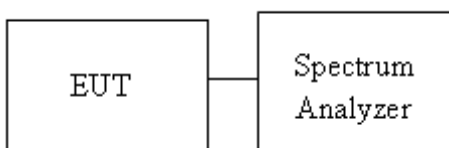



Report No.: TWMK2209003617KR

## 4.5.4 Test Result

### Test Data

Temperature: 25.6°C

Test date: August 10, 2022

Humidity: 46% RH

Tested by: Marco Chan

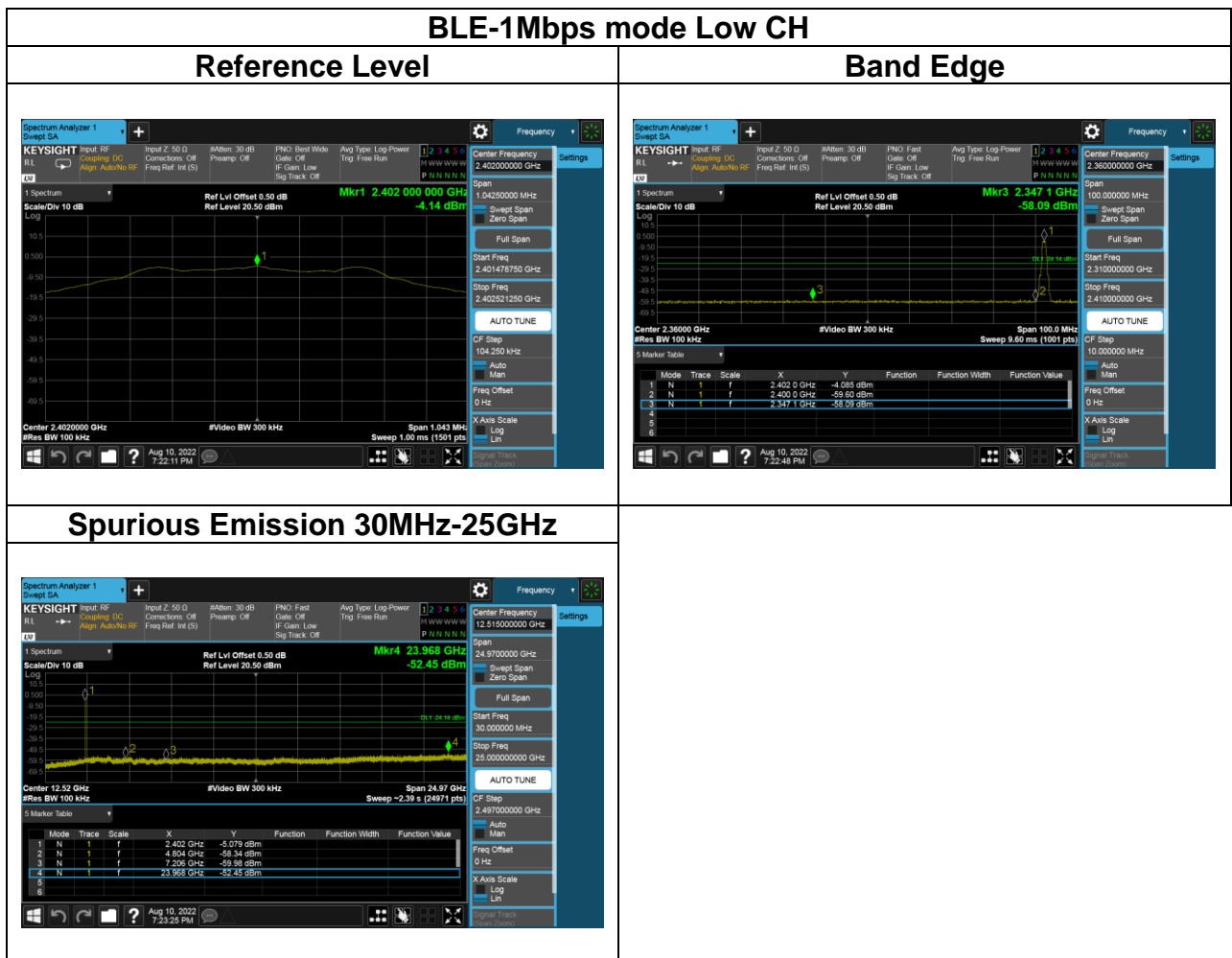

Report No.: TWMK2209003617KR

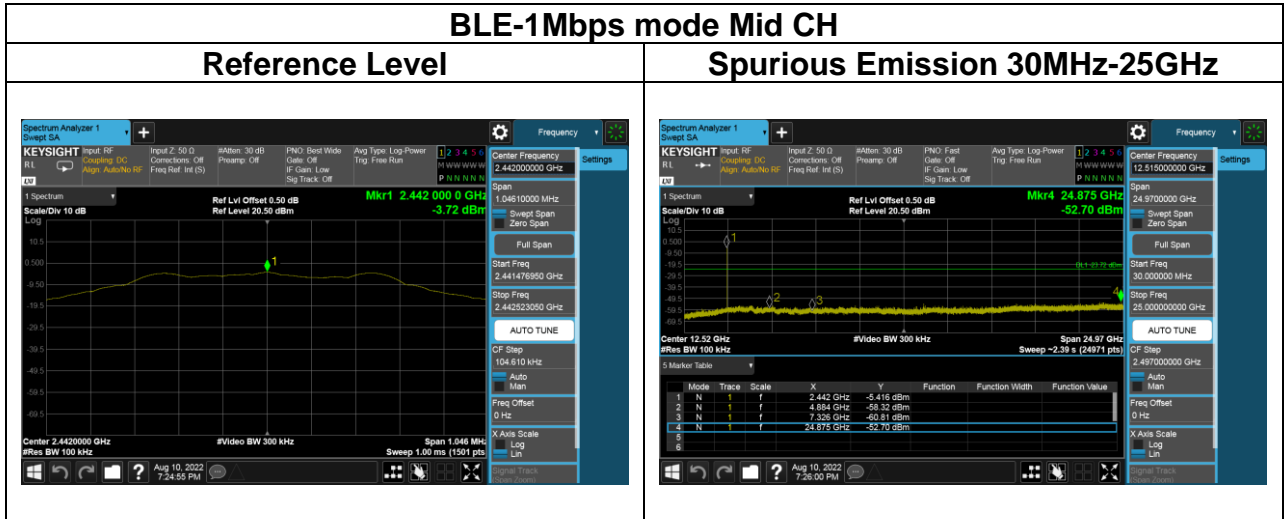

Report No.: TWMK2209003617KR

## BLE-1Mbps mode High CH

### Reference Level

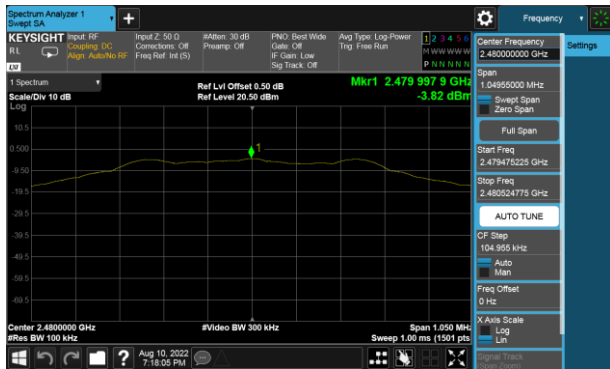

### Band Edge

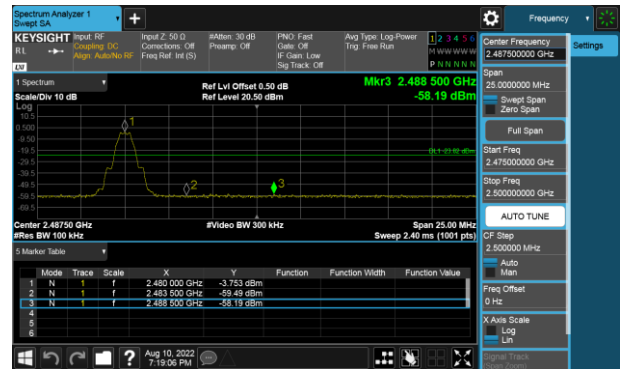

### Spurious Emission 30MHz-25GHz

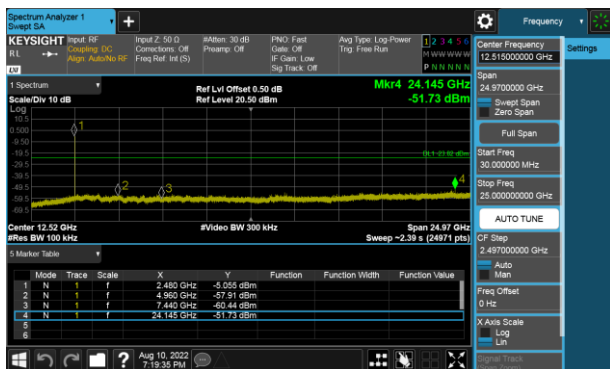

Report No.: TWMK2209003617KR

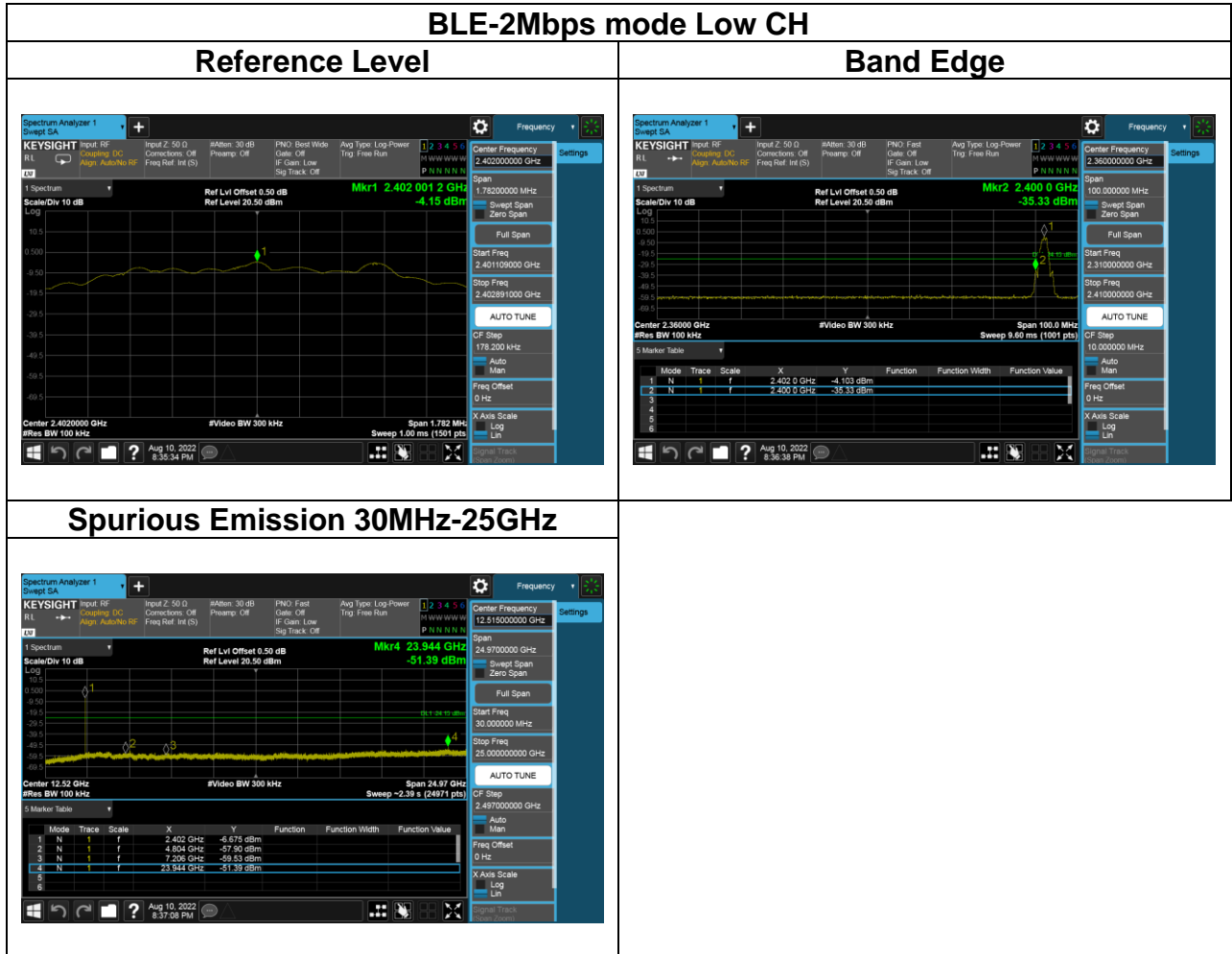

Report No.: TWMK2209003617KR

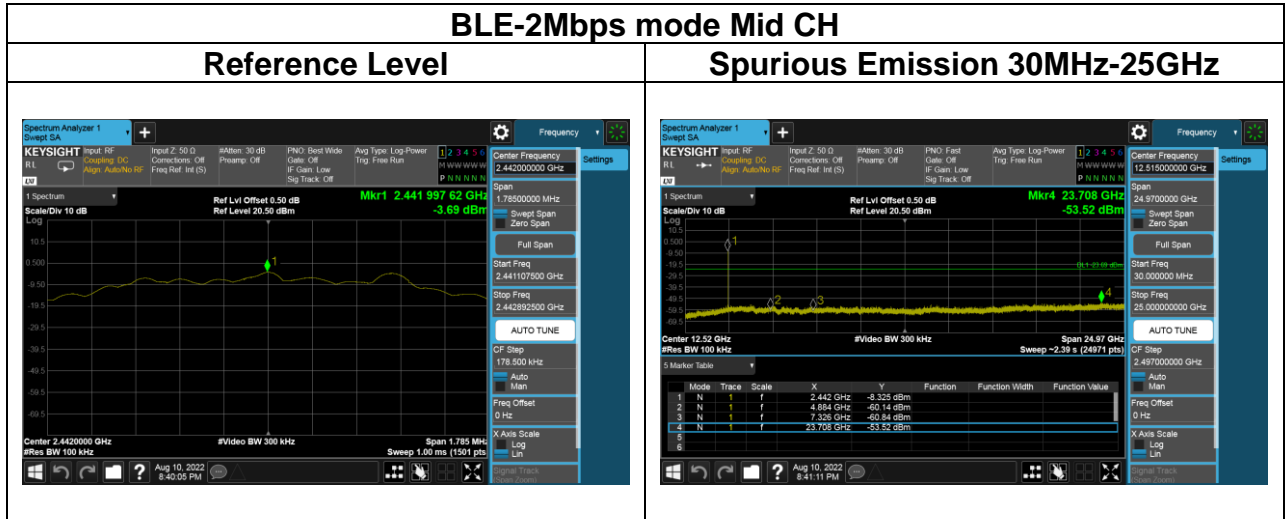

Report No.: TWMK2209003617KR

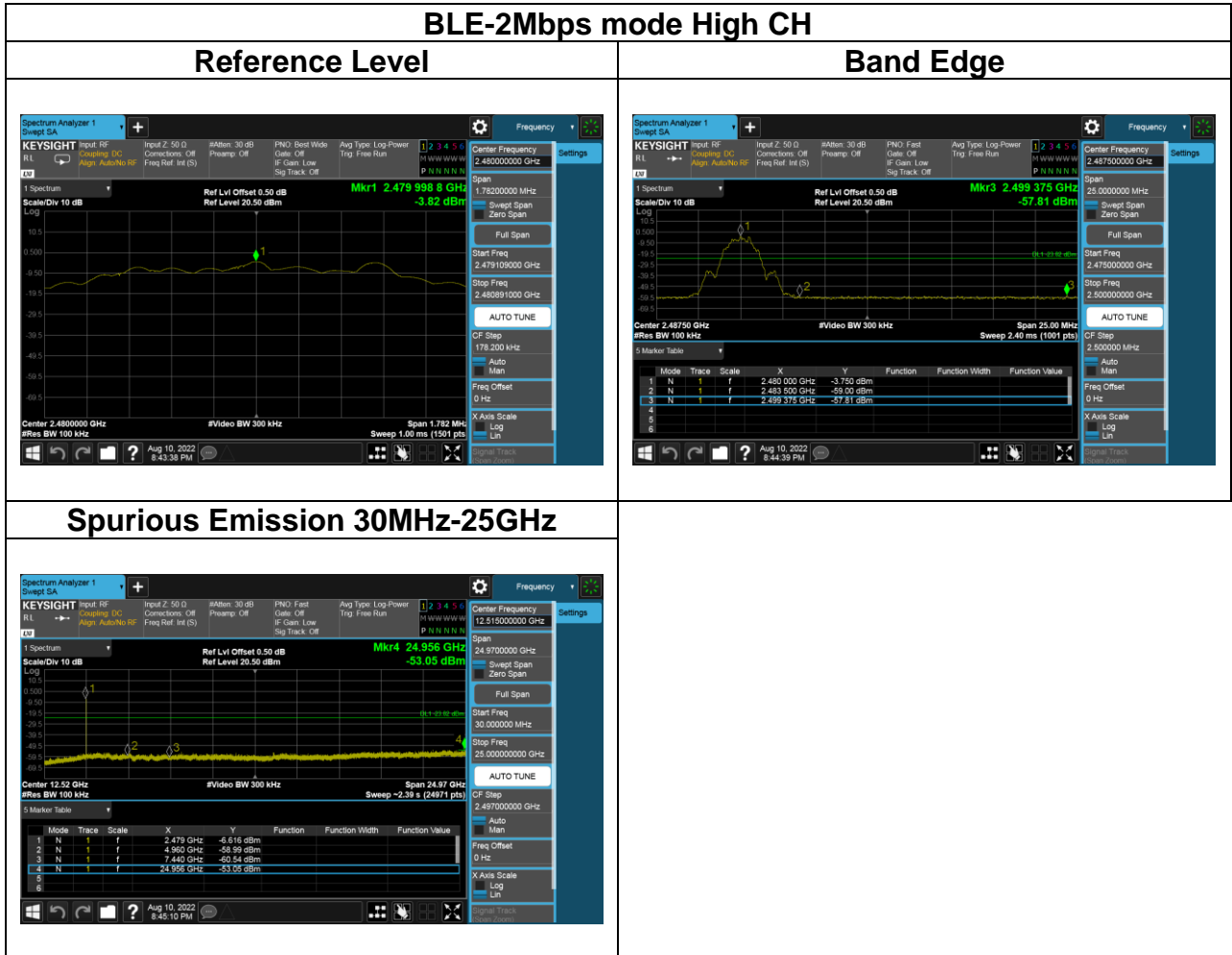

Report No.: TWMK2209003617KR

## 4.6 RADIATION BANDEDGE AND SPURIOUS EMISSION

### 4.6.1 Test Limit

FCC according to §15.247(d), §15.209 and §15.205,

In any 100 kHz bandwidth outside the authorized frequency band, all harmonic and spurious must be least 20 dB below the highest emission level with the authorized frequency band. Radiation emission which fall in the restricted bands must also follow the FCC section 15.209 as below limit in table.

#### Below 30 MHz

Frequency	Field Strength (microvolts/m)	Magnetic H-Field (microamperes/m)	Measurement Distance (metres)
9-490 kHz	2,400/F (F in kHz)	2,400/F (F in kHz)	300
490-1,705 kHz	24,000/F (F in kHz)	24,000/F (F in kHz)	30
1.705-30 MHz	30	N/A	30

#### Above 30 MHz

Frequency (MHz)	Field Strength microvolts/m at 3 metres (watts, e.i.r.p.)	
	Transmitters	Receivers
30-88	100 (3 nW)	100 (3 nW)
88-216	150 (6.8 nW)	150 (6.8 nW)
216-960	200 (12 nW)	200 (12 nW)
Above 960	500 (75 nW)	500 (75 nW)

**Remark:**

Although these tests were performed other than open area test site, adequate comparison measurements were confirmed against 30 m open area test site. Therefore sufficient tests were made to demonstrate that the alternative site produces results that correlate with the ones of tests made in an open field based on KDB 414788.

Report No.: TWMK2209003617KR

## 4.6.2 Test Procedure

Test method Refer as ANSI C63.10:2013.

1. The EUT is placed on a turntable, Above 1 GHz is 1.5m and below 1 GHz is 0.8m above ground plane. The EUT Configuredun accordance with ANSI C63.10: 2013, and the EUT set in a continuous mode.
2. The turntable shall be rotated for 360 degrees to determine the position of maximum emission level. And EUT is set 3m away from the receiving antenna, which is scanned from 1m to 4m above the ground plane to find out the highest emissions. Measurement are made polarized in both the vertical and the horizontal positions with antenna.
3. Span shall wide enough to full capture the emission measured. The SA from 9KHz to 26.5GHz set to the low, Mid and High channels with the EUT transmit.

Remark:

1. Although these tests were performed other than open area test site, adequate comparison measurements were confirmed against 30 m open are test site. Therefore sufficient tests were made to demonstrate that the alternative site produces results that correlate with the ones of tests made in an open field based on KDB 414788.
2. No emission found between lowest internal used/generated frequency to 30MHz (9kHz~30MHz).

3. The SA setting following :

- (1) Below 1G : RBW = 100kHz, VBW  $\geq$  3 RBW, Sweep = Auto, Detector = Peak, Trace = Max hold.
- (2) Above 1G :
  - (2.1) For Peak measurement : RBW = 1MHz, VBW  $\geq$  3 RBW, Sweep = Auto, Detector = Peak, Trace = Max hold.
  - (2.2) For Average measurement : RBW = 1MHz, VBW
    - If Duty Cycle  $\geq$  98%, VBW=10Hz.
    - If Duty Cycle < 98%, VBW=1/T.

4. Data result

Actual FS=Spectrum Reading Level+Factor

Margin=Actual FS- Limit



### 4.6.3 Test Setup

#### 9kHz ~ 30MHz

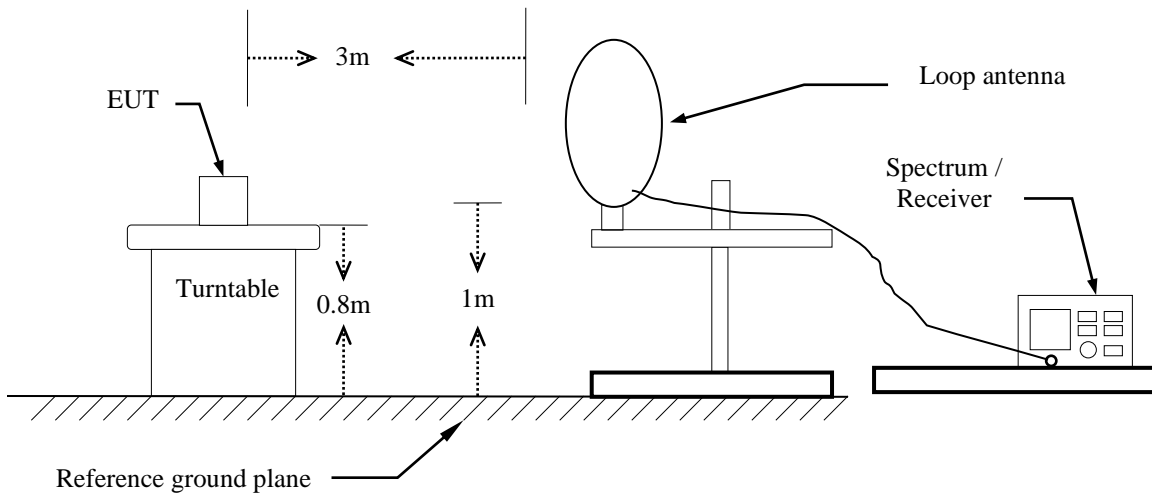

#### 30MHz ~ 1GHz

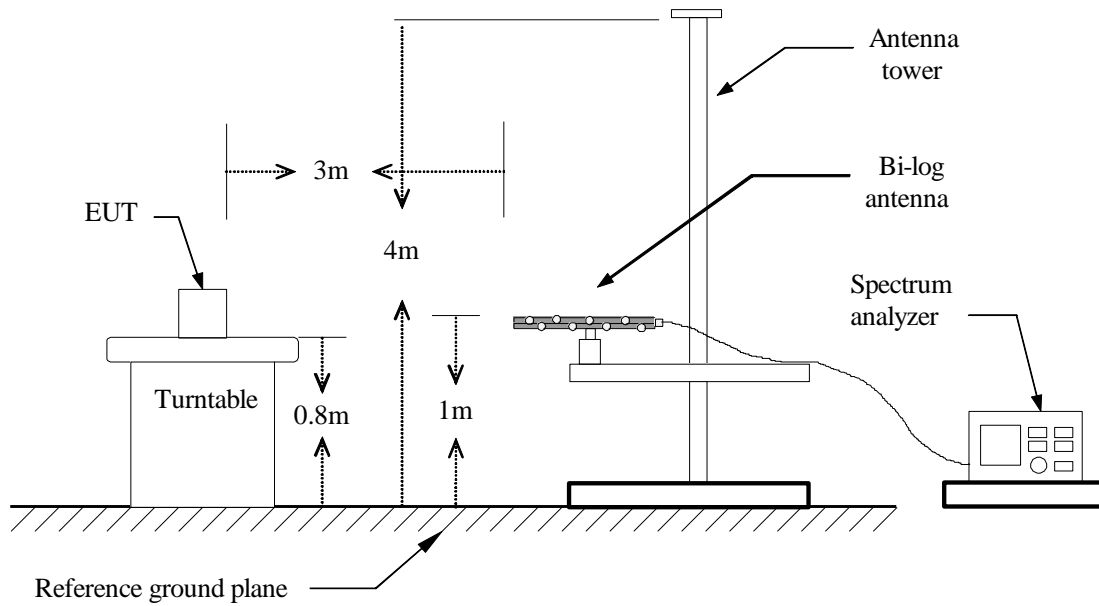

## Above 1 GHz

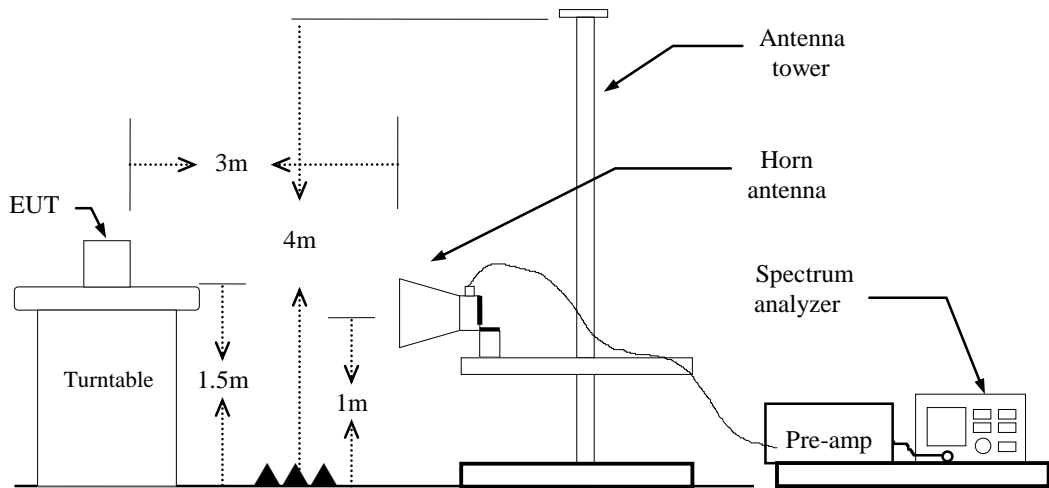

Report No.: TWMK2209003617KR

### 4.6.4 Test Result

#### Band Edge Test Data

Test Mode:	BLE-1Mbps Low CH	Temp/Hum	24.4(°C) / 62%RH
Test Item	Band Edge	Test Date	August 19, 2022
Polarize	Vertical	Test Engineer	Tony Chao
Detector	Peak / Average		

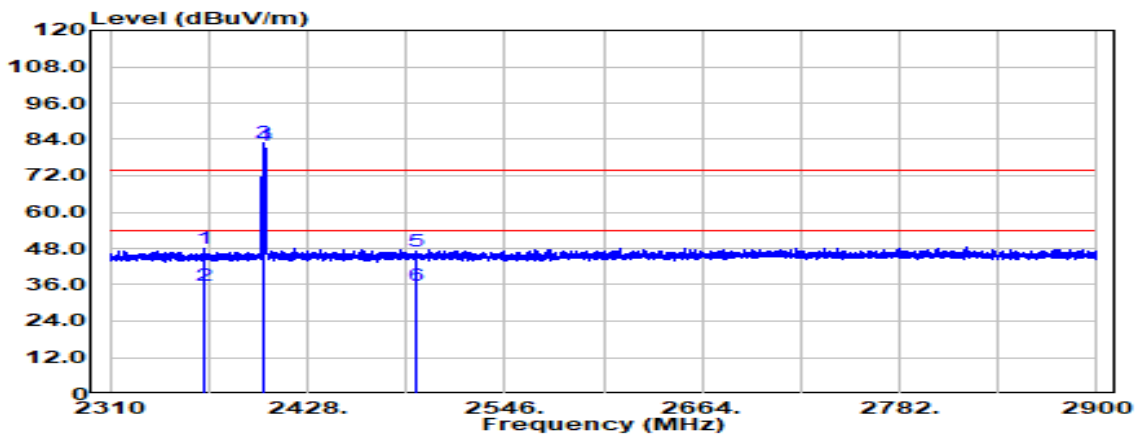

Freq. (MHz)	Detector Mode (PK/QP/AV)	Spectrum Reading Level (dBµV)	Factor (dB)	Actual FS (dBµV/m)	Limit @3m (dBµV/m)	Margin (dB)
2366.640	Peak	40.15	7.69	47.83	74.00	-26.17
2366.640	Average	28.28	7.69	35.97	54.00	-18.03
2402.000	Peak	75.21	7.79	83.00	--	--
2402.000	Average	74.38	7.79	82.18	--	--
2493.136	Peak	39.01	8.31	47.32	74.00	-26.68
2493.136	Average	27.50	8.31	35.81	54.00	-18.19

Test Mode:	BLE-1Mbps Low CH	Temp/Hum	24.4(°C) / 62%RH
Test Item	Band Edge	Test Date	August 19, 2022
Polarize	Horizontal	Test Engineer	Tony Chao
Detector	Peak / Average		

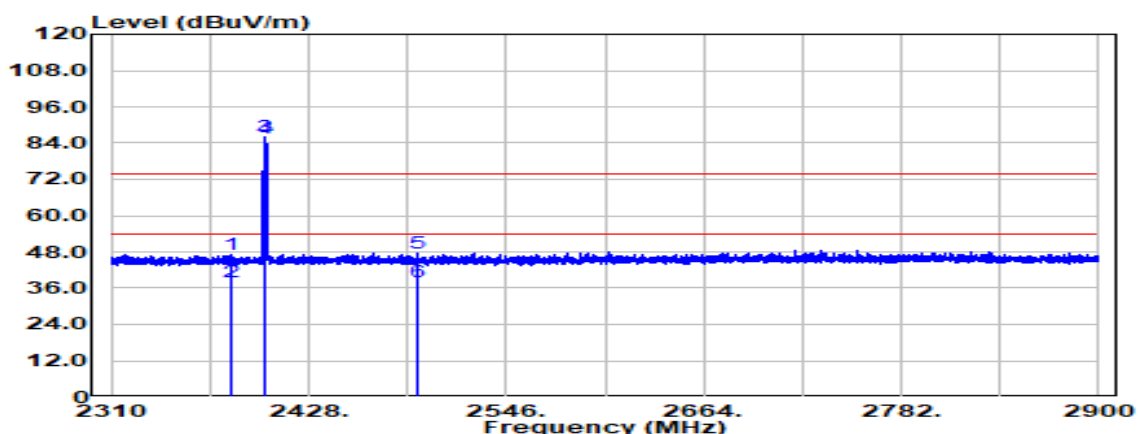

Freq. (MHz)	Detector Mode (PK/QP/AV)	Spectrum Reading Level (dBμV)	Factor (dB)	Actual FS (dBμV/m)	Limit @3m (dBμV/m)	Margin (dB)
2381.154	Peak	39.54	7.73	47.26	74.00	-26.74
2381.154	Average	30.25	7.73	37.97	54.00	-16.03
2402.000	Peak	78.38	7.79	86.17	--	--
2402.000	Average	77.84	7.79	85.63	--	--
2492.310	Peak	39.06	8.30	47.36	74.00	-26.64
2492.310	Average	29.61	8.30	37.91	54.00	-16.09

Test Mode:	BLE-1Mbps High CH	Temp/Hum	24.4(°C) / 62%RH
Test Item	Band Edge	Test Date	August 19, 2022
Polarize	Vertical	Test Engineer	Tony Chao
Detector	Peak / Average		

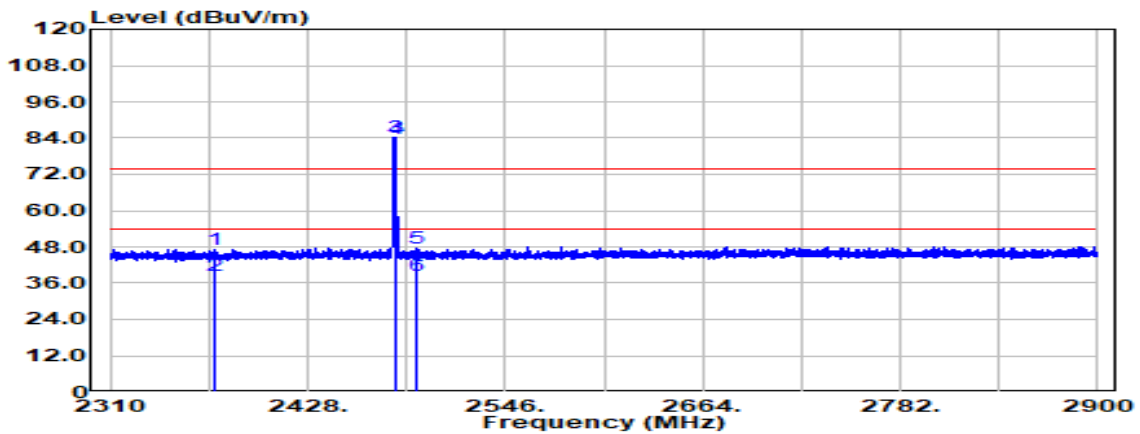

Freq. (MHz)	Detector Mode (PK/QP/AV)	Spectrum Reading Level (dB $\mu$ V)	Factor (dB)	Actual FS (dB $\mu$ V/m)	Limit @3m (dB $\mu$ V/m)	Margin (dB)
2372.304	Peak	39.54	7.70	47.24	74.00	-26.76
2372.304	Average	30.70	7.70	38.40	54.00	-15.60
2480.000	Peak	76.18	8.24	84.43	--	--
2480.000	Average	75.59	8.24	83.83	--	--
2493.254	Peak	39.03	8.31	47.33	74.00	-26.67
2493.254	Average	29.96	8.31	38.27	54.00	-15.73

Test Mode:	BLE-1Mbps High CH	Temp/Hum	24.4(°C) / 62%RH
Test Item	Band Edge	Test Date	August 19, 2022
Polarize	Horizontal	Test Engineer	Tony Chao
Detector	Peak / Average		

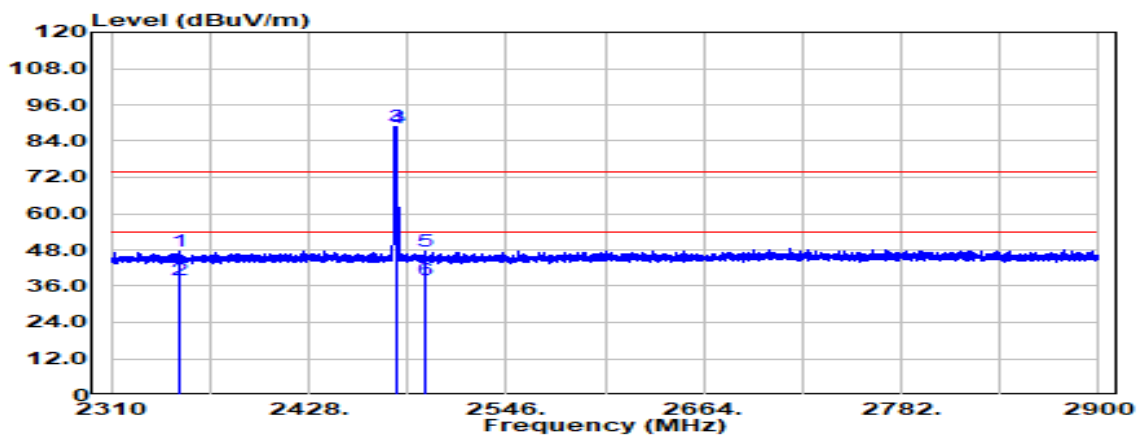

Freq. (MHz)	Detector Mode (PK/QP/AV)	Spectrum Reading Level (dB $\mu$ V)	Factor (dB)	Actual FS (dB $\mu$ V/m)	Limit @3m (dB $\mu$ V/m)	Margin (dB)
2351.182	Peak	40.06	7.64	47.71	74.00	-26.29
2351.182	Average	30.27	7.64	37.92	54.00	-16.08
2480.000	Peak	80.47	8.24	88.71	--	--
2480.000	Average	79.94	8.24	88.19	--	--
2497.738	Peak	39.11	8.33	47.44	74.00	-26.56
2497.738	Average	29.92	8.33	38.25	54.00	-15.75

Test Mode:	BLE-2Mbps Low CH	Temp/Hum	24.4(°C) / 62%RH
Test Item	Band Edge	Test Date	August 19, 2022
Polarize	Vertical	Test Engineer	Tony Chao
Detector	Peak / Average		

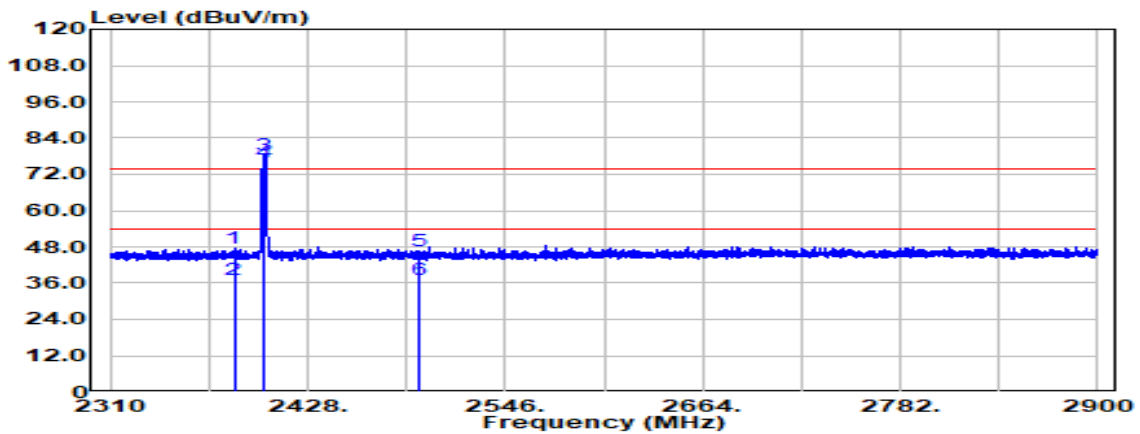

Freq. (MHz)	Detector Mode (PK/QP/AV)	Spectrum Reading Level (dB $\mu$ V)	Factor (dB)	Actual FS (dB $\mu$ V/m)	Limit @3m (dB $\mu$ V/m)	Margin (dB)
2383.986	Peak	39.78	7.74	47.51	74.00	-26.49
2383.986	Average	29.43	7.74	37.17	54.00	-16.83
2402.000	Peak	70.45	7.79	78.25	--	--
2402.000	Average	68.28	7.79	76.08	--	--
2494.434	Peak	38.50	8.31	46.81	74.00	-27.19
2494.434	Average	28.99	8.31	37.31	54.00	-16.69

Report No.: TWMK2209003617KR

Test Mode:	BLE-2Mbps Low CH	Temp/Hum	24.4(°C) / 62%RH
Test Item	Band Edge	Test Date	August 19, 2022
Polarize	Horizontal	Test Engineer	Tony Chao
Detector	Peak / Average		

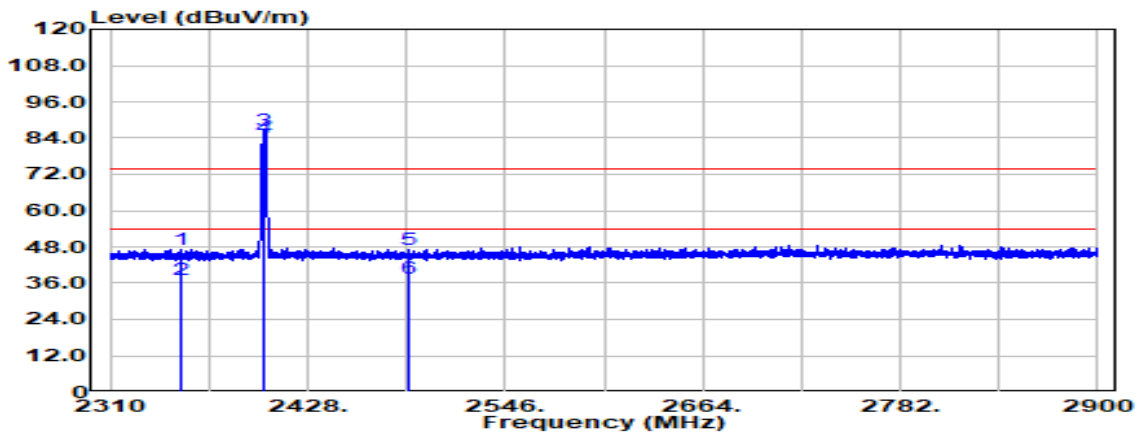

Freq. (MHz)	Detector Mode (PK/QP/AV)	Spectrum Reading Level (dB $\mu$ V)	Factor (dB)	Actual FS (dB $\mu$ V/m)	Limit @3m (dB $\mu$ V/m)	Margin (dB)
2352.834	Peak	39.53	7.65	47.18	74.00	-26.82
2352.834	Average	29.44	7.65	37.08	54.00	-16.92
2402.000	Peak	78.60	7.79	86.39	--	--
2402.000	Average	76.45	7.79	84.24	--	--
2488.180	Peak	38.94	8.28	47.22	74.00	-26.78
2488.180	Average	29.18	8.28	37.46	54.00	-16.54



Report No.: TWMK2209003617KR

Test Mode:	BLE-2Mbps High CH	Temp/Hum	24.4(°C) / 62%RH
Test Item	Band Edge	Test Date	August 19, 2022
Polarize	Vertical	Test Engineer	Tony Chao
Detector	Peak / Average		

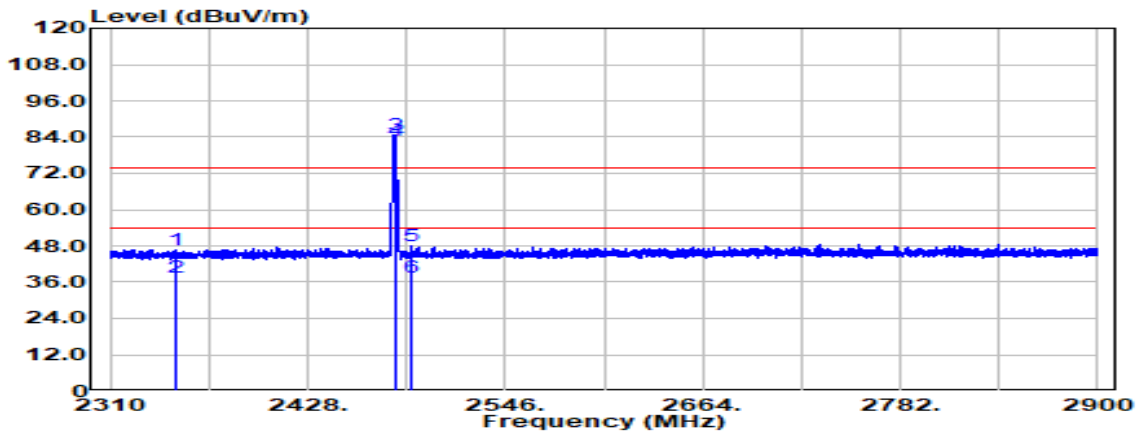

Freq. (MHz)	Detector Mode (PK/QP/AV)	Spectrum Reading Level (dBμV)	Factor (dB)	Actual FS (dBμV/m)	Limit @3m (dBμV/m)	Margin (dB)
2349.884	Peak	39.14	7.64	46.78	74.00	-27.22
2349.884	Average	29.90	7.64	37.54	54.00	-16.46
2480.000	Peak	76.39	8.24	84.63	--	--
2480.000	Average	74.45	8.24	82.69	--	--
2490.186	Peak	39.52	8.29	47.81	74.00	-26.19
2490.186	Average	29.46	8.29	37.76	54.00	-16.24

Report No.: TWMK2209003617KR

Test Mode:	BLE-2Mbps High CH	Temp/Hum	24.4(°C) / 62%RH
Test Item	Band Edge	Test Date	August 19, 2022
Polarize	Horizontal	Test Engineer	Tony Chao
Detector	Peak / Average		

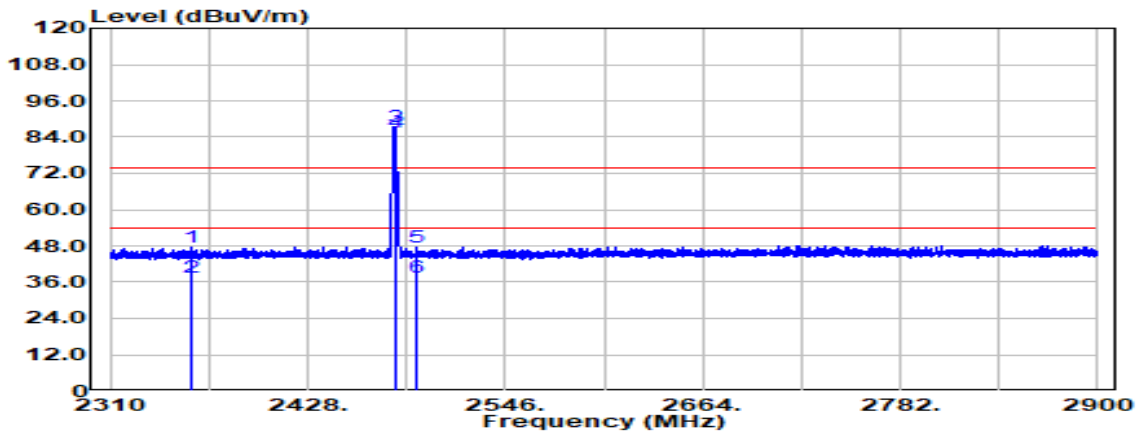

Freq. (MHz)	Detector Mode (PK/QP/AV)	Spectrum Reading Level (dBµV)	Factor (dB)	Actual FS (dBµV/m)	Limit @3m (dBµV/m)	Margin (dB)
2358.734	Peak	39.69	7.66	47.36	74.00	-26.64
2358.734	Average	29.81	7.66	37.48	54.00	-16.52
2480.000	Peak	79.35	8.24	87.59	--	--
2480.000	Average	77.41	8.24	85.65	--	--
2492.546	Peak	39.35	8.30	47.66	74.00	-26.34
2492.546	Average	29.35	8.30	37.66	54.00	-16.34

Report No.: TWMK2209003617KR

**Below 1G Test Data**

Test Mode:	BLE-1Mbps 2480MHz	Temp/Hum	24.4(°C) / 64%RH
Test Item	30MHz-1GHz	Test Date	August 22, 2022
Polarize	Vertical	Test Engineer	Ray Li
Detector	Peak		

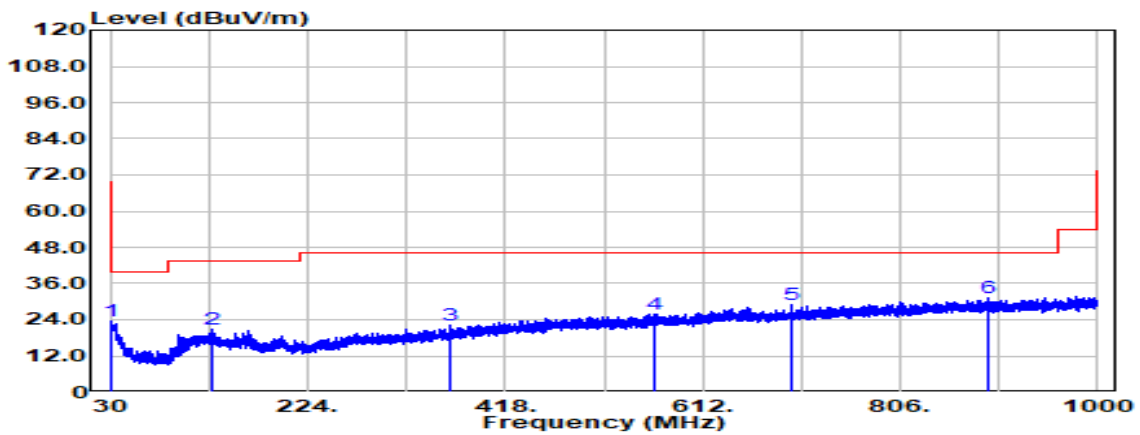

Freq. (MHz)	Detector Mode (PK/QP/AV)	Spectrum Reading Level (dBµV)	Factor (dB)	Actual FS (dBµV/m)	Limit @3m (dBµV/m)	Margin (dB)
30.121	Peak	26.85	-3.31	23.54	40.00	-16.46
131.244	Peak	30.47	-9.44	21.04	43.50	-22.46
362.710	Peak	29.43	-7.34	22.08	46.00	-23.92
564.591	Peak	28.45	-2.56	25.89	46.00	-20.11
700.149	Peak	29.25	-0.44	28.81	46.00	-17.19
892.573	Peak	29.15	2.14	31.30	46.00	-14.70

Note: No emission found between lowest internal used/generated frequency to 30MHz (9kHz~30MHz).

Report No.: TWMK2209003617KR

Test Mode:	BLE-1Mbps 2480MHz	Temp/Hum	24.4(°C) / 64%RH
Test Item	30MHz-1GHz	Test Date	August 22, 2022
Polarize	Horizontal	Test Engineer	Ray Li
Detector	Peak		

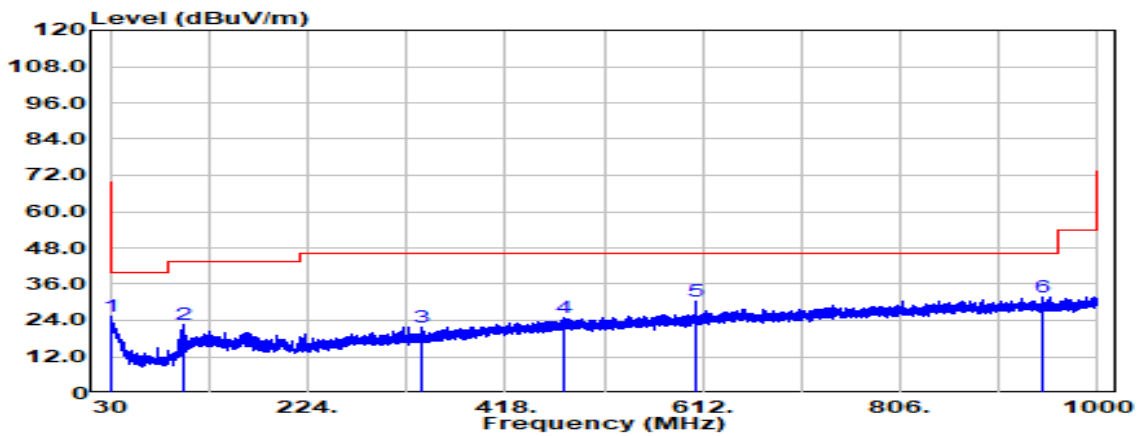

Freq. (MHz)	Detector Mode (PK/QP/AV)	Spectrum Reading Level (dB $\mu$ V)	Factor (dB)	Actual FS (dB $\mu$ V/m)	Limit @3m (dB $\mu$ V/m)	Margin (dB)
31.576	Peak	28.96	-3.81	25.15	40.00	-14.85
101.780	Peak	35.14	-12.47	22.67	43.50	-20.83
336.763	Peak	30.03	-8.17	21.86	46.00	-24.14
476.564	Peak	29.01	-3.90	25.11	46.00	-20.89
606.059	Peak	32.41	-2.30	30.12	46.00	-15.88
946.286	Peak	28.58	3.21	31.79	46.00	-14.21

Note: No emission found between lowest internal used/generated frequency to 30MHz (9kHz~30MHz).

Report No.: TWMK2209003617KR

**Above 1G Test Data**

Test Mode:	BLE-1Mbps Low CH	Temp/Hum	24.4(°C) / 62%RH
Test Item	Harmonic	Test Date	August 19, 2022
Polarize	Vertical	Test Engineer	Tony Chao
Detector	Peak / Average		

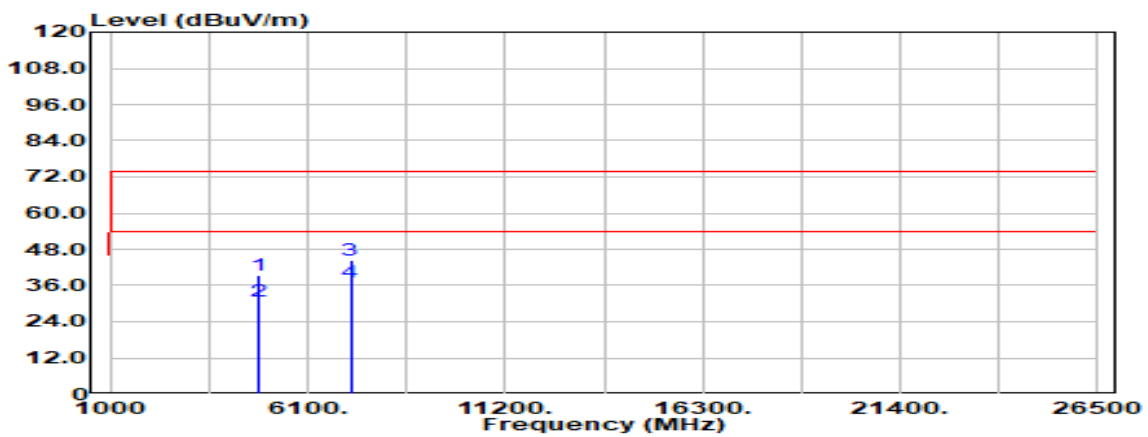

Freq. (MHz)	Detector Mode (PK/QP/AV)	Spectrum Reading Level (dBµV)	Factor (dB)	Actual FS (dBµV/m)	Limit @3m (dBµV/m)	Margin (dB)
4804.000	Peak	34.24	5.87	40.11	74.00	-33.89
4804.000	Average	28.79	5.87	34.66	54.00	-19.34
7206.000	Peak	31.13	13.25	44.38	74.00	-29.62
7206.000	Average	23.83	13.25	37.08	54.00	-16.92
N/A						

**Remark:**

1. Measuring frequencies from 1 GHz to the 10th harmonic of highest fundamental frequency.

Report No.: TWMK2209003617KR

Test Mode:	BLE-1Mbps Low CH	Temp/Hum	24.4(°C) / 62%RH
Test Item	Harmonic	Test Date	August 19, 2022
Polarize	Horizontal	Test Engineer	Tony Chao
Detector	Peak / Average		

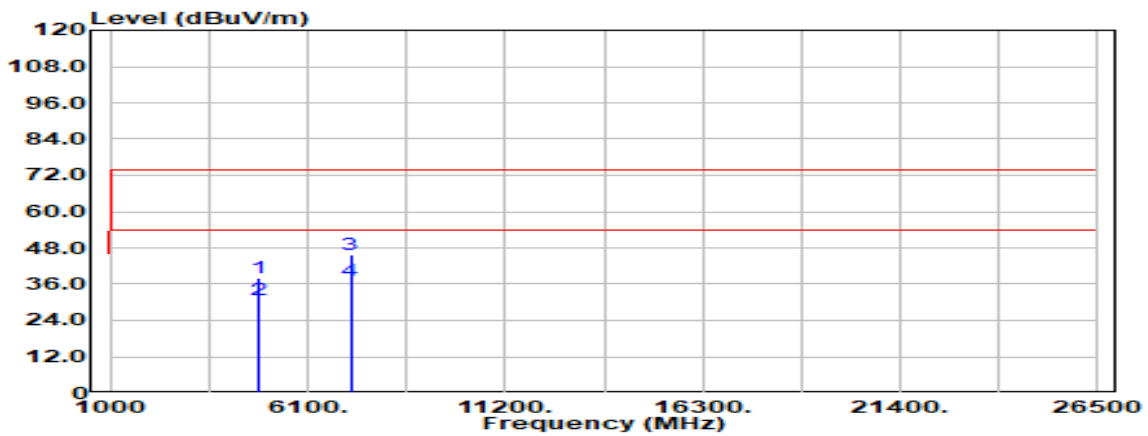

Freq. (MHz)	Detector Mode (PK/QP/AV)	Spectrum Reading Level (dBμV)	Factor (dB)	Actual FS (dBμV/m)	Limit @3m (dBμV/m)	Margin (dB)
4804.000	Peak	32.14	5.87	38.00	74.00	-36.00
4804.000	Average	24.90	5.87	30.77	54.00	-23.23
7206.000	Peak	32.52	13.25	45.77	74.00	-28.23
7206.000	Average	23.99	13.25	37.24	54.00	-16.76
N/A						

**Remark:**

1. Measuring frequencies from 1 GHz to the 10th harmonic of highest fundamental frequency.

Report No.: TWMK2209003617KR

Test Mode:	BLE-1Mbps Mid CH	Temp/Hum	24.4(°C) / 62%RH
Test Item	Harmonic	Test Date	August 19, 2022
Polarize	Vertical	Test Engineer	Tony Chao
Detector	Peak / Average		

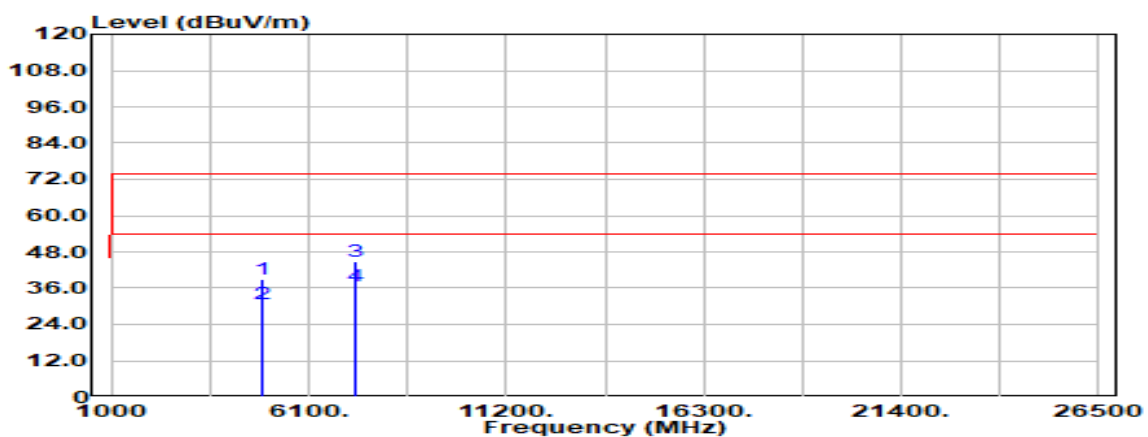

Freq. (MHz)	Detector Mode (PK/QP/AV)	Spectrum Reading Level (dBμV)	Factor (dB)	Actual FS (dBμV/m)	Limit @3m (dBμV/m)	Margin (dB)
4884.000	Peak	33.01	6.15	39.16	74.00	-34.84
4884.000	Average	24.49	6.15	30.64	54.00	-23.36
7326.000	Peak	31.43	13.36	44.79	74.00	-29.21
7326.000	Average	23.14	13.36	36.50	54.00	-17.50
N/A						

**Remark:**

1. Measuring frequencies from 1 GHz to the 10th harmonic of highest fundamental frequency.

Test Mode:	BLE-1Mbps Mid CH	Temp/Hum	24.4(°C) / 62%RH
Test Item	Harmonic	Test Date	August 19, 2022
Polarize	Horizontal	Test Engineer	Tony Chao
Detector	Peak / Average		

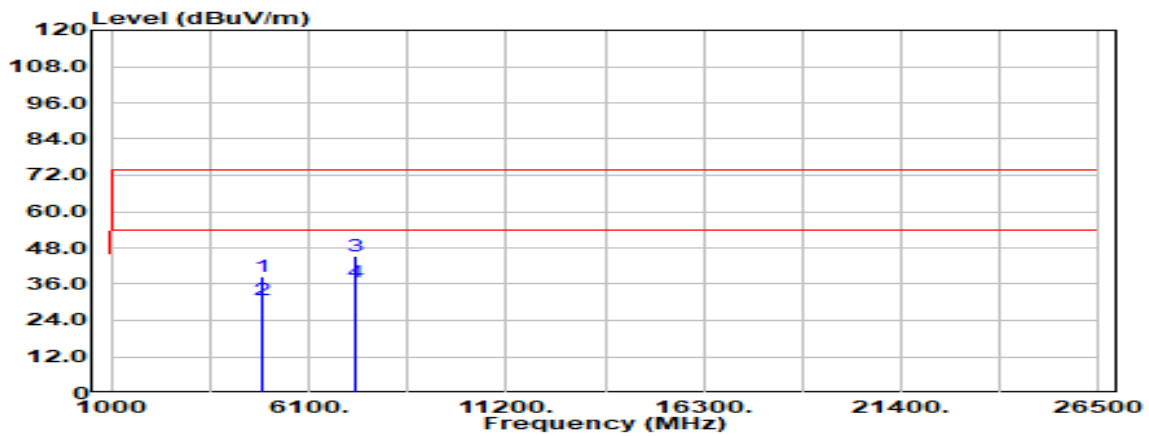

Freq. (MHz)	Detector Mode (PK/QP/AV)	Spectrum Reading Level (dBµV)	Factor (dB)	Actual FS (dBµV/m)	Limit @3m (dBµV/m)	Margin (dB)
4884.000	Peak	32.15	6.15	38.30	74.00	-35.70
4884.000	Average	24.43	6.15	30.58	54.00	-23.42
7326.000	Peak	31.95	13.36	45.32	74.00	-28.68
7326.000	Average	23.11	13.36	36.47	54.00	-17.53
N/A						

**Remark:**

1. Measuring frequencies from 1 GHz to the 10th harmonic of highest fundamental frequency.



Test Mode:	BLE-1Mbps High CH	Temp/Hum	24.4(°C) / 62%RH
Test Item	Harmonic	Test Date	August 19, 2022
Polarize	Vertical	Test Engineer	Tony Chao
Detector	Peak / Average		

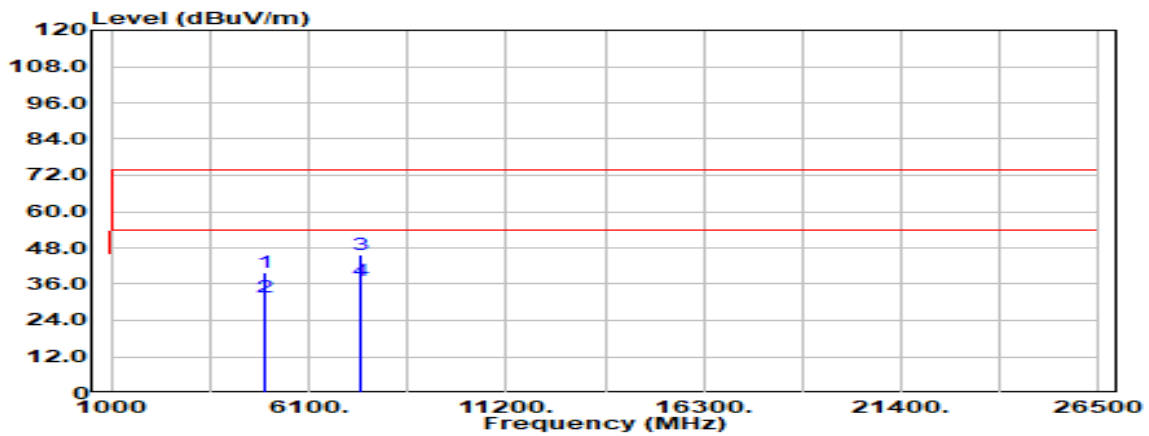

Freq. (MHz)	Detector Mode (PK/QP/AV)	Spectrum Reading Level (dBμV)	Factor (dB)	Actual FS (dBμV/m)	Limit @3m (dBμV/m)	Margin (dB)
4960.000	Peak	33.10	6.91	40.02	74.00	-33.98
4960.000	Average	24.62	6.91	31.53	54.00	-22.47
7440.000	Peak	32.50	13.22	45.72	74.00	-28.28
7440.000	Average	23.99	13.22	37.21	54.00	-16.79
N/A						

**Remark:**

1. Measuring frequencies from 1 GHz to the 10th harmonic of highest fundamental frequency.

Test Mode:	BLE-1Mbps High CH	Temp/Hum	24.4(°C) / 62%RH
Test Item	Harmonic	Test Date	August 19, 2022
Polarize	Horizontal	Test Engineer	Tony Chao
Detector	Peak / Average		

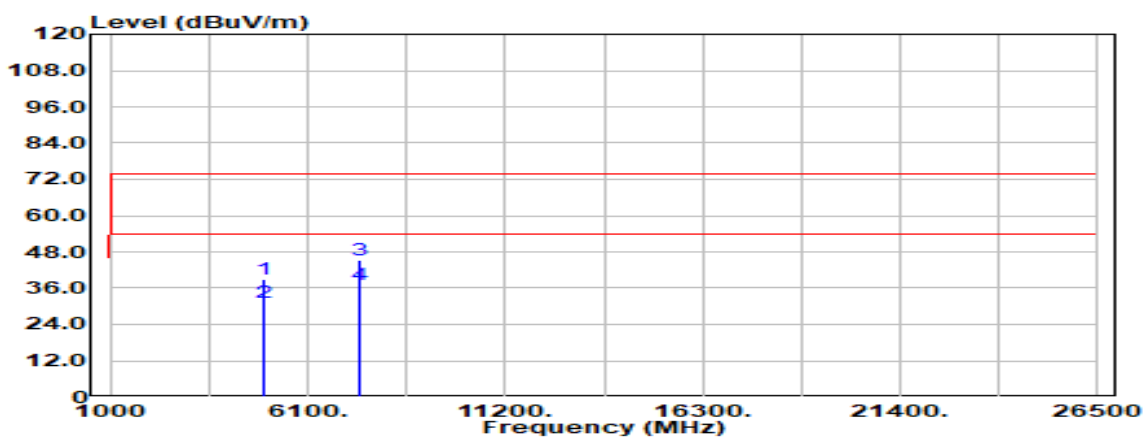

Freq. (MHz)	Detector Mode (PK/QP/AV)	Spectrum Reading Level (dBμV)	Factor (dB)	Actual FS (dBμV/m)	Limit @3m (dBμV/m)	Margin (dB)
4960.000	Peak	32.01	6.91	38.92	74.00	-35.08
4960.000	Average	24.36	6.91	31.27	54.00	-22.73
7440.000	Peak	32.25	13.22	45.47	74.00	-28.53
7440.000	Average	23.99	13.22	37.21	54.00	-16.79
N/A						

**Remark:**

1. Measuring frequencies from 1 GHz to the 10th harmonic of highest fundamental frequency.

Test Mode:	BLE-2Mbps Low CH	Temp/Hum	24.4(°C) / 62%RH
Test Item	Harmonic	Test Date	August 19, 2022
Polarize	Vertical	Test Engineer	Tony Chao
Detector	Peak / Average		

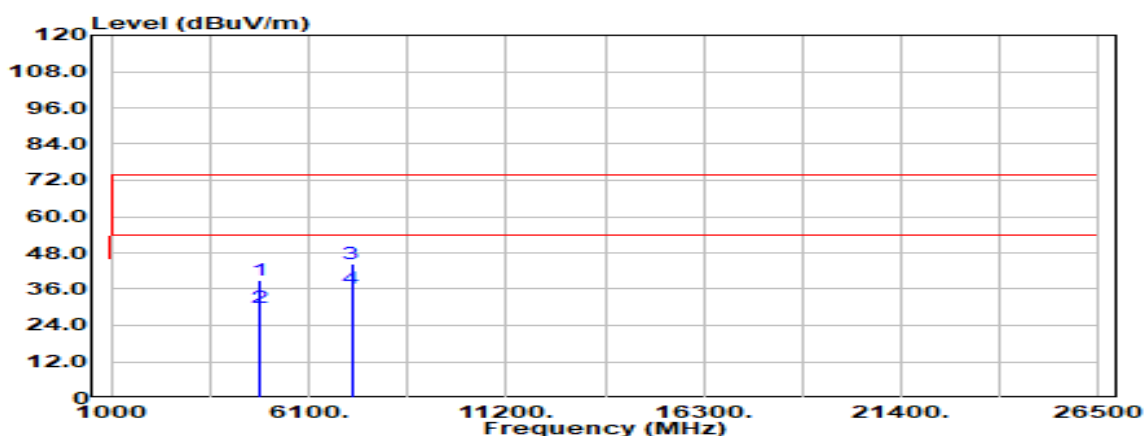

Freq. (MHz)	Detector Mode (PK/QP/AV)	Spectrum Reading Level (dBμV)	Factor (dB)	Actual FS (dBμV/m)	Limit @3m (dBμV/m)	Margin (dB)
4804.000	Peak	33.04	5.87	38.90	74.00	-35.10
4804.000	Average	24.17	5.87	30.04	54.00	-23.96
7206.000	Peak	31.27	13.25	44.52	74.00	-29.48
7206.000	Average	22.75	13.25	36.00	54.00	-18.00
N/A						

**Remark:**

1. Measuring frequencies from 1 GHz to the 10th harmonic of highest fundamental frequency.

Report No.: TWMK2209003617KR

Test Mode:	BLE-2Mbps Low CH	Temp/Hum	24.4(°C) / 62%RH
Test Item	Harmonic	Test Date	August 19, 2022
Polarize	Horizontal	Test Engineer	Tony Chao
Detector	Peak / Average		

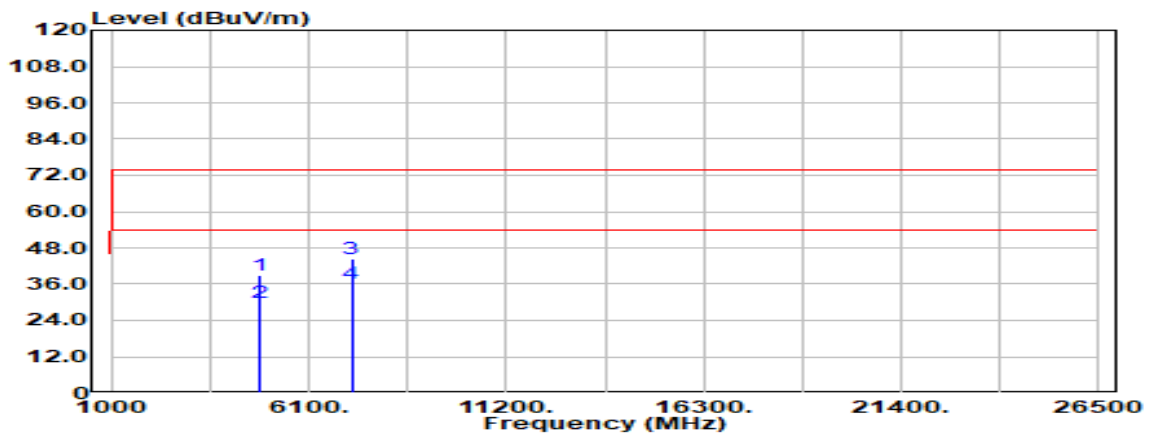

Freq. (MHz)	Detector Mode (PK/QP/AV)	Spectrum Reading Level (dBμV)	Factor (dB)	Actual FS (dBμV/m)	Limit @3m (dBμV/m)	Margin (dB)
4804.000	Peak	33.08	5.87	38.95	74.00	-35.05
4804.000	Average	24.24	5.87	30.11	54.00	-23.89
7206.000	Peak	31.26	13.25	44.51	74.00	-29.49
7206.000	Average	22.75	13.25	36.00	54.00	-18.00
N/A						

**Remark:**

1. Measuring frequencies from 1 GHz to the 10th harmonic of highest fundamental frequency.

Report No.: TWMK2209003617KR

Test Mode:	BLE-2Mbps Mid CH	Temp/Hum	24.4(°C) / 62%RH
Test Item	Harmonic	Test Date	August 19, 2022
Polarize	Vertical	Test Engineer	Tony Chao
Detector	Peak / Average		

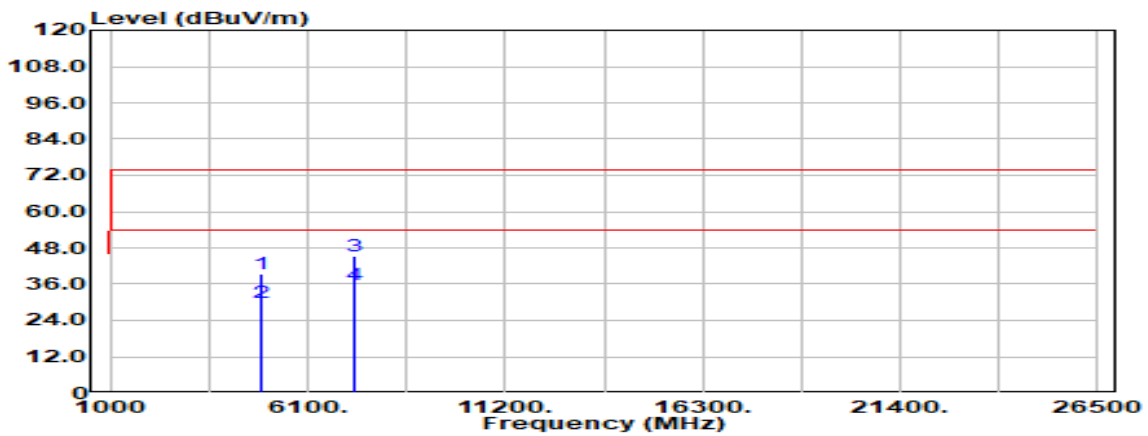

Freq. (MHz)	Detector Mode (PK/QP/AV)	Spectrum Reading Level (dBμV)	Factor (dB)	Actual FS (dBμV/m)	Limit @3m (dBμV/m)	Margin (dB)
4884.000	Peak	33.30	6.15	39.45	74.00	-34.55
4884.000	Average	23.66	6.15	29.81	54.00	-24.19
7326.000	Peak	32.04	13.36	45.40	74.00	-28.60
7326.000	Average	22.47	13.36	35.83	54.00	-18.17
N/A						

**Remark:**

1. Measuring frequencies from 1 GHz to the 10th harmonic of highest fundamental frequency.

Report No.: TWMK2209003617KR

Test Mode:	BLE-2Mbps Mid CH	Temp/Hum	24.4(°C) / 62%RH
Test Item	Harmonic	Test Date	August 19, 2022
Polarize	Horizontal	Test Engineer	Tony Chao
Detector	Peak / Average		

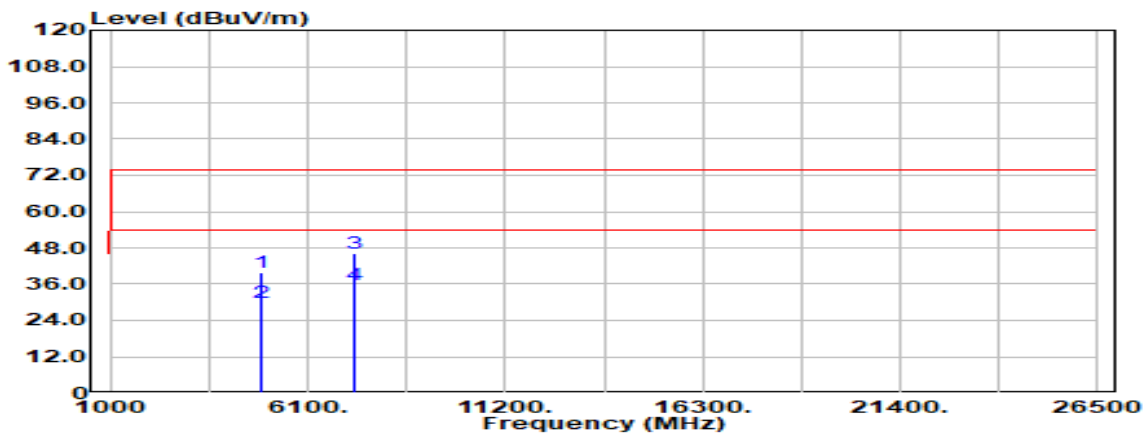

Freq. (MHz)	Detector Mode (PK/QP/AV)	Spectrum Reading Level (dBμV)	Factor (dB)	Actual FS (dBμV/m)	Limit @3m (dBμV/m)	Margin (dB)
4884.000	Peak	33.60	6.15	39.75	74.00	-34.25
4884.000	Average	23.77	6.15	29.92	54.00	-24.08
7326.000	Peak	32.86	13.36	46.22	74.00	-27.78
7326.000	Average	22.51	13.36	35.87	54.00	-18.13
N/A						

**Remark:**

1. Measuring frequencies from 1 GHz to the 10th harmonic of highest fundamental frequency.

Test Mode:	BLE-2Mbps High CH	Temp/Hum	24.4(°C) / 62%RH
Test Item	Harmonic	Test Date	August 19, 2022
Polarize	Vertical	Test Engineer	Ray Li
Detector	Peak / Average		

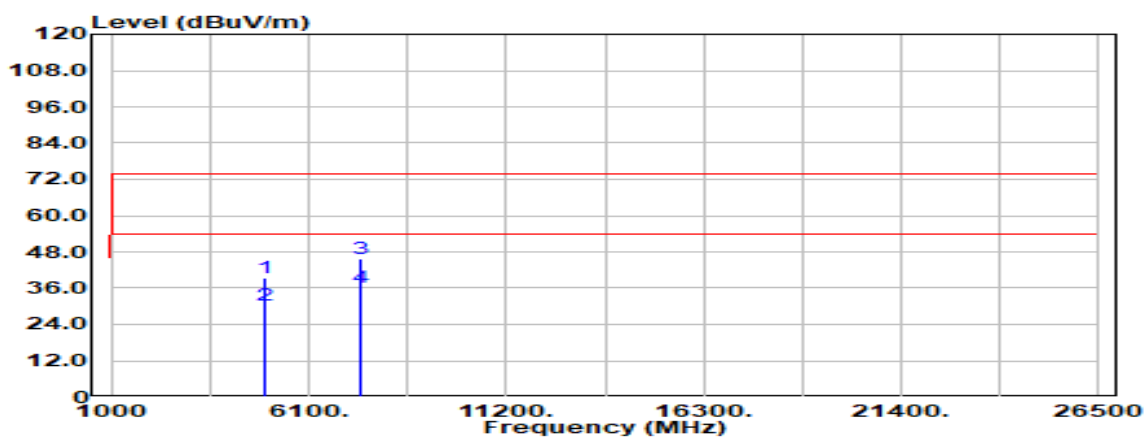

Freq. (MHz)	Detector Mode (PK/QP/AV)	Spectrum Reading Level (dBµV)	Factor (dB)	Actual FS (dBµV/m)	Limit @3m (dBµV/m)	Margin (dB)
4960.000	Peak	32.63	6.91	39.55	74.00	-34.45
4960.000	Average	23.62	6.91	30.54	54.00	-23.46
7440.000	Peak	32.42	13.22	45.64	74.00	-28.36
7440.000	Average	23.18	13.22	36.40	54.00	-17.60
N/A						

**Remark:**

1. Measuring frequencies from 1 GHz to the 10th harmonic of highest fundamental frequency.

Report No.: TWMK2209003617KR

Test Mode:	BLE-2Mbps High CH	Temp/Hum	24.4(°C) / 62%RH
Test Item	Harmonic	Test Date	August 19, 2022
Polarize	Horizontal	Test Engineer	Ray Li
Detector	Peak / Average		

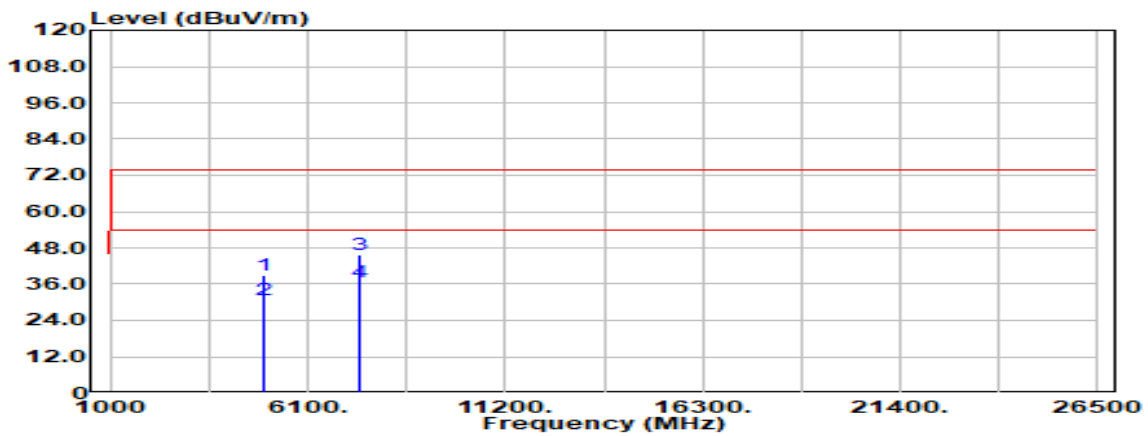

Freq. (MHz)	Detector Mode (PK/QP/AV)	Spectrum Reading Level (dBµV)	Factor (dB)	Actual FS (dBµV/m)	Limit @3m (dBµV/m)	Margin (dB)
4960.000	Peak	32.21	6.91	39.12	74.00	-34.88
4960.000	Average	23.67	6.91	30.58	54.00	-23.42
7440.000	Peak	32.45	13.22	45.67	74.00	-28.33
7440.000	Average	23.25	13.22	36.47	54.00	-17.53
N/A						

**Remark:**

1. Measuring frequencies from 1 GHz to the 10th harmonic of highest fundamental frequency.

**--End of Test Report--**