

Project No: TM-2207000162P
 Report No.: TMWK2207002885KR

FCC ID: IR5FD10

Page: 1 / 83
 Rev.: 00

RADIO TEST REPORT

FCC 47 CFR PART 15 SUBPART C

Test Standard	FCC Part 15.247
Product name	HANDHELD COMPUTER
Brand Name	MilDef
Model No.	DF10
Test Result	Pass
Statements of Conformity	Determination of compliance is based on the results of the compliance measurement, not taking into account measurement instrumentation uncertainty.

The test Result was tested by Compliance Certification Services Inc. The test data, data evaluation, test procedures, and equipment configurations shown in this report were given in ANSI C63.10: 2013 and compliance standards.

The test results of this report relate only to the tested sample (EUT) identified in this report.

The test Report of full or partial shall not copy. Without written approval of Compliance Certification Services Inc. (Wugu Laboratory)

Approved by:

Sehni, Hu

Sehni Hu
 Supervisor

Unless otherwise stated the results shown in this test report refer only to the sample(s) tested and such sample(s) are retained for 90 days only.
 除非另有說明，此報告結果僅對測試之樣品負責，同時此樣品僅保留90天。本報告未經本公司書面許可，不可部份複製。

This document is issued by the Company subject to its General Conditions of Service printed overleaf, available on request or accessible at <http://www.sgs.com.tw/Terms-and-Conditions> and, for electronic format documents, subject to Terms and Conditions for Electronic Documents at <http://www.sgs.com.tw/Terms-and-Conditions>. Attention is drawn to the limitation of liability, indemnification and jurisdiction issues defined therein. Any holder of this document is advised that information contained hereon reflects the Company's findings at the time of its intervention only and within the limits of client's instruction, if any. The Company's sole responsibility is to its Client and this document does not exonerate parties to a transaction from exercising all their rights and obligations under the transaction documents. This document cannot be reproduced, except in full, without prior written approval of the Company. Any unauthorized alteration, forgery or falsification of the content or appearance of this document is unlawful and offenders may be prosecuted to the fullest extent of the law.

Revision History

Rev.	Issue Date	Revisions	Effect Page	Revised By
00	October 11, 2022	Initial Issue	ALL	Allison Chen

Table of contents

1.	GENERAL INFORMATION	4
1.1	EUT INFORMATION.....	4
1.2	INFORMATION ABOUT THE FHSS CHARACTERISTICS.....	5
1.3	EUT CHANNEL INFORMATION	6
1.4	ANTENNA INFORMATION	6
1.5	MEASUREMENT UNCERTAINTY.....	7
1.6	FACILITIES AND TEST LOCATION	8
1.7	INSTRUMENT CALIBRATION	9
1.8	SUPPORT AND EUT ACCESSORIES EQUIPMENT	10
1.9	TEST METHODOLOGY AND APPLIED STANDARDS	10
2.	TEST SUMMARY	11
3.	DESCRIPTION OF TEST MODES.....	12
3.1	THE WORST MODE OF OPERATING CONDITION	12
3.2	THE WORST MODE OF MEASUREMENT	13
3.3	EUT DUTY CYCLE.....	14
4.	TEST RESULT	17
4.1	AC POWER LINE CONDUCTED EMISSION	17
4.2	20DB BANDWIDTH AND OCCUPIED BANDWIDTH (99%)	22
4.3	OUTPUT POWER MEASUREMENT	30
4.4	FREQUENCY SEPARATION	33
4.5	NUMBER OF HOPPING	38
4.6	CONDUCTED BANDEDGE AND SPURIOUS EMISSION.....	41
4.7	TIME OF OCCUPANCY (DWELL TIME)	49
4.8	RADIATION BANDEDGE AND SPURIOUS EMISSION	54
APPENDIX 1 - PHOTOGRAPHS OF EUT		

Report No.: TMWK2207002885KR

1. GENERAL INFORMATION

1.1 EUT INFORMATION

Applicant	MilDef Crete Inc. 7F, No.250, Sec.3,Pei Shen Rd.,Shen Keng District,New Taipei City, Taiwan
Manufacturer	MilDef Crete Inc. 7F, No.250, Sec.3,Pei Shen Rd.,Shen Keng District,New Taipei City, Taiwan
Equipment	HANDHELD COMPUTER
Model Name	DF10
Model Discrepancy	N/A
Brand Name	MilDef
Received Date	July 13, 2022
Date of Test	August 10~22, 2022
Power Supply	<p>1. Power from Adapter. ADAPTER TECH. / COP060A1-P200 I/P: 100-240Vac, 50-60Hz, 1.5MAX O/P: 5.0Vdc, 3.0A, 15.0W or 9.0Vdc, 3.0A, 27.0W or 12.0Vdc, 3.0A, 36.0W or 15.0Vdc, 3.0A, 45.0W or 20.0Vdc, 3.0A, 60.0W</p> <p>2. Power from Battery. Rating: 3.6VDC, 4040mAh</p>

Remark:

- For more details, please refer to the User's manual of the EUT.
- Disclaimer: Antenna information is provided by the applicant, test results of this report are applicable to the sample EUT received.

1.2 INFORMATION ABOUT THE FHSS CHARACTERISTICS

1.2.1 Pseudorandom Frequency Hopping Sequence

The channel is represented by a pseudo-random hopping sequence hopping through the 79 RF channels. The hopping sequence is unique for the piconet and is determined by the Bluetooth device address of the master; the phase in the hopping sequence is determined by the Bluetooth clock of the master. The channel is divided into time slots where each slot corresponds to an RF hop frequency. Consecutive hops correspond to different RF hop frequencies. The nominal hop rate is 1 600 hops/s.

1.2.2 Equal Hopping Frequency Use

The channels of this system will be used equally over the long-term distribution of the hopsets.

1.2.3 Example of a 79 hopping sequence in data mode:

02, 05, 31, 24, 20, 10, 43, 36, 30, 23, 40, 06, 21, 50, 44, 09, 71, 78, 01, 13, 73, 07, 70, 72, 35, 62, 42, 11, 41, 08, 16, 29, 60, 15, 34, 61, 58, 04, 67, 12, 22, 53, 57, 18, 27, 76, 39, 32, 17, 77, 52, 33, 56, 46, 37, 47, 64, 49, 45, 38, 69, 14, 51, 26, 79, 19, 28, 65, 75, 54, 48, 03, 25, 66, 05, 16, 68, 74, 59, 63, 55

1.2.4 System Receiver Input Bandwidth

Each channel bandwidth is 1MHz.

The system receivers have input bandwidths that match the hopping channel bandwidths of their corresponding transmitters and shift frequencies in synchronization with the transmitted signals.

1.2.5 Equipment Description

15.247(a)(1) that the Rx input bandwidths shift frequencies in synchronization with the transmitted signals.

15.247(g): In accordance with the Bluetooth Industry Standard, the system is designed to comply with all of the regulations in Section 15.247 when the transmitter is presented with a continuous data (or information) system.

15.247(h): In accordance with the Bluetooth Industry Standard, the system does not coordinate its channels selection/ hopping sequence with other frequency hopping systems for the express purpose of avoiding the simultaneous occupancy of individual hopping frequencies by multiple transmitters.

Report No.: TMWK2207002885KR

1.3 EUT CHANNEL INFORMATION

Frequency Range	2402MHz-2480MHz
Modulation Type	1. GFSK for BDR-1Mbps 2. $\pi/4$ -DQPSK for EDR-2Mbps 3. 8DPSK for EDR-3Mbps
Number of channel	79 Channels

Remark:

Refer as ANSI C63.10: 2013 clause 5.6.1 Table 4 for test channels

Number of frequencies to be tested		
Frequency range in which device operates	Number of frequencies	Location in frequency range of operation
<input type="checkbox"/> 1 MHz or less	1	Middle
<input type="checkbox"/> 1 MHz to 10 MHz	2	1 near top and 1 near bottom
<input checked="" type="checkbox"/> More than 10 MHz	3	1 near top, 1 near middle, and 1 near bottom

1.4 ANTENNA INFORMATION

Antenna Specification	<input checked="" type="checkbox"/> PIFA <input type="checkbox"/> PCB <input type="checkbox"/> Dipole <input type="checkbox"/> Chip <input type="checkbox"/> Coils
Antenna Gain	Gain: 0.92 dBi
Brand / Model	MilDef Crete Inc. / G980210104

Notes:

1.The antenna(s) of the EUT are permanently attached and there are no provisions for connection to an external antenna. So the EUT complies with the requirements of §15.203.

Report No.: TMWK2207002885KR

1.5 MEASUREMENT UNCERTAINTY

PARAMETER	UNCERTAINTY
AC Powerline Conducted Emission	± 2.1183
Channel Bandwidth	± 2.1863
RF output power (Power Meter + Power sensor)	± 1.2688
Power Spectral density	± 2.1855
Conducted Bandedge	± 2.1866
Conducted Spurious Emission	± 2.1859
Radiated Emission_9kHz-30MHz	± 3.814
Radiated Emission_30MHz-200MHz	± 4.272
Radiated Emission_200MHz-1GHz	± 4.619
Radiated Emission_1GHz-6GHz	± 5.522
Radiated Emission_6GHz-18GHz	± 5.228
Radiated Emission_18GHz-26GHz	± 4.089
Radiated Emission_26GHz-40GHz	± 4.019

Remark:

- 1.This uncertainty represents an expanded uncertainty expressed at approximately the 95% confidence level using a coverage factor of k=2
2. ISO/IEC 17025 requires that an estimate of the measurement uncertainties associated with the emissions test results be included in the report.

1.6 FACILITIES AND TEST LOCATION

All measurement facilities used to collect the measurement data are located at No.11, Wugong 6th Rd., Wugu Dist., New Taipei City, Taiwan. (R.O.C.)
 CAB identifier: TW1309

Test site	Test Engineer	Remark
AC Conduction Room	Tony Chao	-
Radiation	Ray Li, Tony Chao	-
RF Conducted	Marco Chan	-

Remark: The lab has been recognized as the FCC accredited lab. under the KDB 974614 D01 and is listed in the FCC public Access Link (PAL) database, FCC Registration No. :444940, the FCC Designation No.:TW1309.

1.7 INSTRUMENT CALIBRATION

RF Conducted Test Site					
Name of Equipment	Manufacturer	Model	Serial Number	Calibration Date	Calibration Due
Coaxial Cable	Woken	WC12	CC003	06/27/2022	06/26/2023
Power Meter	Anritsu	ML2496A	2136002	12/06/2021	12/05/2022
Power Seneor	Anritsu	MA2411B	1911386	08/08/2022	08/07/2023
Power Seneor	Anritsu	MA2411B	1911387	08/08/2022	08/07/2023
EXA Signal Analyzer	KEYSIGHT	N9010B	MY55460167	09/07/2021	09/06/2022
Software	Radio Test Software Ver. 21				

AC-line Conduction Test Room					
Name of Equipment	Manufacturer	Model	Serial Number	Calibration Date	Calibration Due
CABLE	EMCI	CFD300-NL	CERF	06/27/2022	06/26/2023
EMI Test Receiver	R&S	ESCI	100064	06/17/2022	06/16/2023
LISN	SCHAFFNER	NNB 41	03/10013	02/15/2022	02/14/2023
Software	EZ-EMC(CCS-3A1-CE-wugu)				

3M 966A Chamber					
Name of Equipment	Manufacturer	Model	Serial Number	Calibration Date	Calibration Due
Band Reject Filters	MICRO TRONICS	BRM 50702	112	11/23/2021	11/22/2022
Bilog Antenna	Sunol Sciences	JB3	A030105	08/03/2022	08/02/2023
Coaxial Cable	HUBER SUHNER	SUCOFLEX 104PEA	20995	02/23/2022	02/22/2023
Coaxial Cable	Woken	J-1099	201709090004	12/23/2021	12/22/2022
Coaxial Cable	EMCI	EMC105	190914+33953	06/15/2022	06/14/2023
Digital Thermo-Hygro Meter	WISEWIND	1206	D07	12/28/2021	12/27/2022
Horn Antenna	ETS LINDGREN	3116	00026370	11/30/2021	11/29/2022
Horn Antenna	MCTD	1209	DRH13M02003	01/25/2022	01/24/2023
K Type Cable	Huber+Suhner	SUCOFLEX 102	29406/2	12/05/2021	12/04/2022
Pre-Amplifier	EMEC	EM330	060609	02/23/2022	02/22/2023
Pre-Amplifier	HP	8449B	3008A00965	12/24/2021	12/23/2022
PSA Series Spectrum Analyzer	Agilent	E4446A	MY46180323	12/06/2021	12/05/2022
Antenna Tower	CCS	CC-A-1F	N/A	N.C.R	N.C.R
Controller	CCS	CC-C-1F	N/A	N.C.R	N.C.R
Turn Table	CCS	CC-T-1F	N/A	N.C.R	N.C.R
Software	e3 210616				

Remark:

1. Each piece of equipment is scheduled for calibration once a year.
2. N.C.R. = No Calibration Required.

1.8 SUPPORT AND EUT ACCESSORIES EQUIPMENT

EUT Accessories Equipment						
No.	Equipment	Brand	Model	Series No.	FCC ID	IC
	N/A					

Support Equipment						
No.	Equipment	Brand	Model	Series No.	FCC ID	IC
	N/A					

1.9 TEST METHODOLOGY AND APPLIED STANDARDS

The test methodology, setups and results comply with all requirements in accordance with ANSI C63.10:2013, FCC Part 2, FCC Part 15.247.

2. TEST SUMMARY

FCC Standard Section	Report Section	Test Item	Result
15.203	1.3	Antenna Requirement	Pass
15.207(a)	4.1	AC Conducted Emission	Pass
15.247(a)(1)	4.2	20 dB Bandwidth	Pass
-	4.2	Occupied Bandwidth (99%)	Pass
15.247(b)(1)	4.3	Output Power Measurement	Pass
15.247(a)(1)	4.4	Frequency Separation	Pass
15.247(a)(1)(iii)	4.5	Number of Hopping	Pass
15.247(d)	4.6	Conducted Band Edge	Pass
15.247(d)	4.6	Conducted Spurious Emission	Pass
15.247(a)(1)(iii)	4.7	Time of Occupancy	Pass
15.247(d)	4.8	Radiation Band Edge	Pass
15.247(d)	4.8	Radiation Spurious Emission	Pass

Report No.: TMWK2207002885KR

3. DESCRIPTION OF TEST MODES

3.1 THE WORST MODE OF OPERATING CONDITION

Operation mode	GFSK for BDR-1Mbps (DH5) $\pi/4$ -DQPSK for 2Mbps (2DH5) 8DPSK for EDR-3Mbps (3DH5)
Test Channel Frequencies	<p>GFSK for BDR-1Mbps: 1.Lowest Channel: 2402MHz 2.Middle Channel: 2441MHz 3.Highest Channel: 2480MHz</p> <p>$\pi/4$-DQPSK for 2Mbps: 1.Lowest Channel: 2402MHz 2.Middle Channel: 2441MHz 3.Highest Channel: 2480MHz</p> <p>8DPSK for EDR-3Mbps: 1.Lowest Channel: 2402MHz 2.Middle Channel: 2441MHz 3.Highest Channel: 2480MHz</p>

Remark:

1. EUT pre-scanned data rate of output power for each mode, the worst data rate were recorded in this report.
2. The system support GFSK , $\pi/4$ DQPSK , 8DPSK , the $\pi/4$ DQPSK were reduced since the identical parameters with 8dpsk. In the following test items, frequency hopping, Conducted band edge, radiated band edge and spurious emissions.

Report No.: TMWK2207002885KR

3.2 THE WORST MODE OF MEASUREMENT

AC Power Line Conducted Emission	
Test Condition	AC Power line conducted emission for line and neutral
Power supply Mode	Mode 1: EUT power by Adapter
Worst Mode	<input checked="" type="checkbox"/> Mode 1 <input type="checkbox"/> Mode 2 <input type="checkbox"/> Mode 3 <input type="checkbox"/> Mode 4

Remark:

1. The worst mode was record in this test report.
2. AC power line conducted emission and for below 1G radiation emission were performed the EUT transmit at the highest output power channel as worse case.

Radiated Emission Measurement Above 1G	
Test Condition	Radiated Emission Above 1G
Power supply Mode	Mode 1: EUT power by Adapter
Worst Mode	<input checked="" type="checkbox"/> Mode 1 <input type="checkbox"/> Mode 2 <input type="checkbox"/> Mode 3 <input type="checkbox"/> Mode 4
Worst Position	<input type="checkbox"/> Placed in fixed position. <input checked="" type="checkbox"/> Placed in fixed position at X-Plane (E2-Plane) <input type="checkbox"/> Placed in fixed position at Y-Plane (E1-Plane) <input type="checkbox"/> Placed in fixed position at Z-Plane (H-Plane)

Radiated Emission Measurement Below 1G	
Test Condition	Radiated Emission Below 1G
Power supply Mode	Mode 1: EUT power by Adapter
Worst Mode	<input checked="" type="checkbox"/> Mode 1 <input type="checkbox"/> Mode 2 <input type="checkbox"/> Mode 3 <input type="checkbox"/> Mode 4

Remark:

1. The worst mode was record in this test report.
2. EUT pre-scanned in three axis ,X,Y, Z and two polarity, for radiated measurement. The worst case(X-Plane) were recorded in this report

Report No.: TMWK2207002885KR

3.3 EUT DUTY CYCLE

Temperature: 25.6°C

Test date: August 10, 2022

Humidity: 46% RH

Tested by: Marco Chan

For GFSK (1Mbps)

Duty Cycle				
Configuration	Duty Cycle (%) = Ton / (Ton+Toff)	Duty Factor (dB) =10*log (1/Duty Cycle)	1/T (kHz)	VBW setting (kHz)
DH1	30.40	5.17	2.63	3.00
DH3	65.60	1.83	0.61	1.00
DH5	77.20	1.12	0.35	1.00



Report No.: TMWK2207002885KR

For $\pi/4$ -DQPSK (2Mbps)

Duty Cycle				
Configuration	Duty Cycle (%) = Ton / (Ton+Toff)	Duty Factor (dB) =10*log (1/Duty Cycle)	1/T (kHz)	VBW setting (kHz)
2DH1	30.80	5.11	2.60	3.00
2DH3	65.60	1.83	0.61	1.00
2DH5	76.80	1.15	0.35	1.00



Report No.: TMWK2207002885KR

For 8-DPSK (3Mbps)

Duty Cycle				
Configuration	Duty Cycle (%) = Ton / (Ton+Toff)	Duty Factor (dB) =10*log (1/Duty Cycle)	1/T (kHz)	VBW setting (kHz)
3DH1	30.80	5.11	2.60	3.00
3DH3	65.60	1.83	0.61	1.00
3DH5	77.20	1.12	0.35	1.00



Report No.: TMWK2207002885KR

4. TEST RESULT

4.1 AC POWER LINE CONDUCTED EMISSION

4.1.1 Test Limit

According to §15.207(a),

Frequency Range (MHz)	Limits(dB μ V)	
	Quasi-peak	Average
0.15 to 0.50	66 to 56*	56 to 46*
0.50 to 5	56	46
5 to 30	60	50

* Decreases with the logarithm of the frequency.

4.1.2 Test Procedure

Test method Refer as ANSI C63.10: 2013 clause 6.2,

1. The EUT was placed on a non-conducted table, which is 0.8m above horizontal ground plane and 0.4m above vertical ground plane.
2. EUT connected to the line impedance stabilization network (LISN)
3. Receiver set RBW of 9kHz and Detector Peak, and note as quasi-peak and average.
4. Maximum procedure was performed on the six highest emissions to ensure EUT compliance.
5. Recorded Line for Neutral and Line.

4.1.3 Test Setup

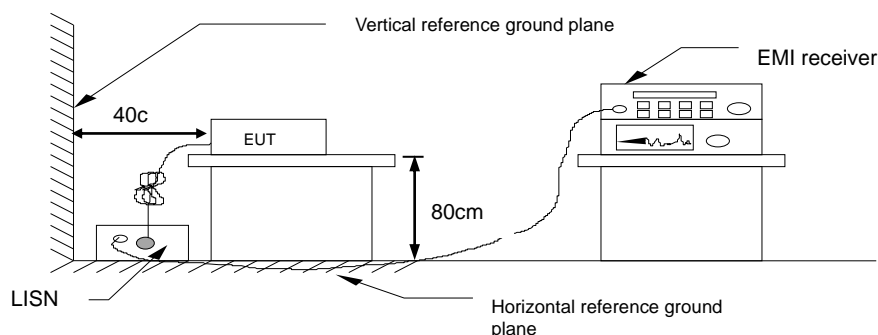

4.1.4 Test Result

Pass.

Report No.: TMWK2207002885KR

Test Data

Test Mode:	BT BR	Temp/Hum	24.9(°C)/ 51%RH
Phase:	Line	Test Date	August 17, 2022
Test Voltage:	120Vac, 60Hz	Test Engineer	Tony Chao

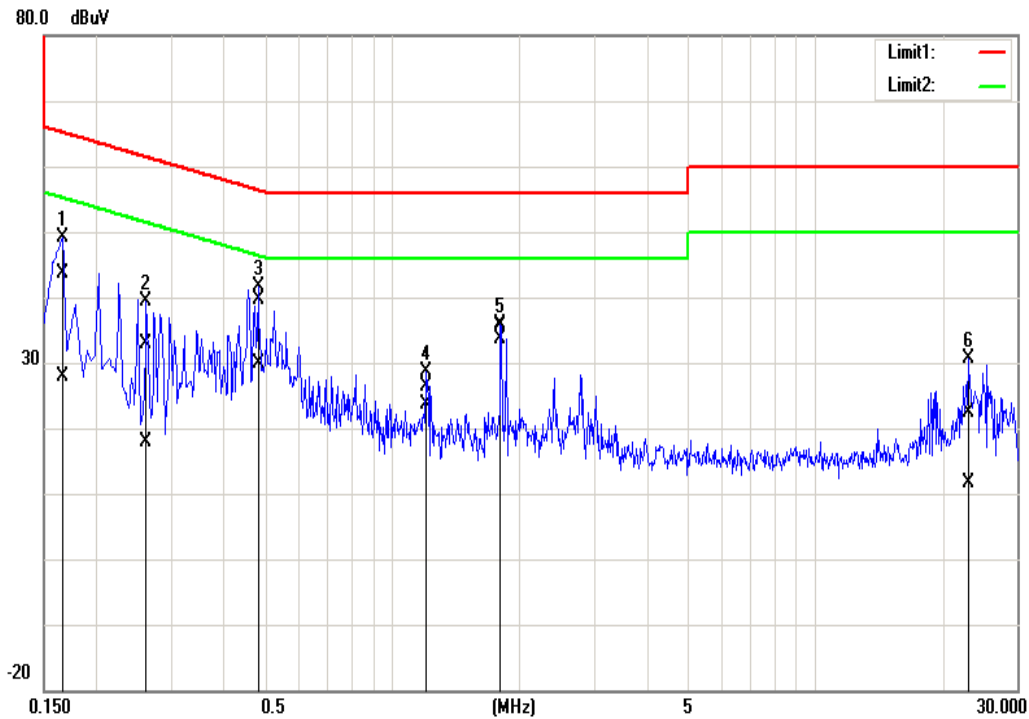

Frequency (MHz)	Quasi Peak reading (dBuV)	Average reading (dBuV)	Correction factor (dB)	Quasi Peak result (dBuV)	Average result (dBuV)	Quasi Peak limit (dBuV)	Average limit (dBuV)	Quasi Peak margin (dB)	Average margin (dB)	Remark
0.1660	33.49	17.74	10.17	43.66	27.91	65.16	55.16	-21.50	-27.25	Pass
0.2620	22.75	7.79	10.18	32.93	17.97	61.37	51.37	-28.44	-33.40	Pass
0.4820	29.41	19.72	10.19	39.60	29.91	56.30	46.30	-16.70	-16.39	Pass
1.2060	16.11	13.52	10.22	26.33	23.74	56.00	46.00	-29.67	-22.26	Pass
1.8060	25.31	23.49	10.25	35.56	33.74	56.00	46.00	-20.44	-12.26	Pass
23.0860	12.10	1.27	10.28	22.38	11.55	60.00	50.00	-37.62	-38.45	Pass

Note: Correction factor = LISN loss + Cable loss.

Report No.: TMWK2207002885KR

Test Mode:	BT BR	Temp/Hum	24.9(°C)/ 51%RH
Phase:	Neutral	Test Date	August 17, 2022
Test Voltage:	120Vac, 60Hz	Test Engineer	Tony Chao

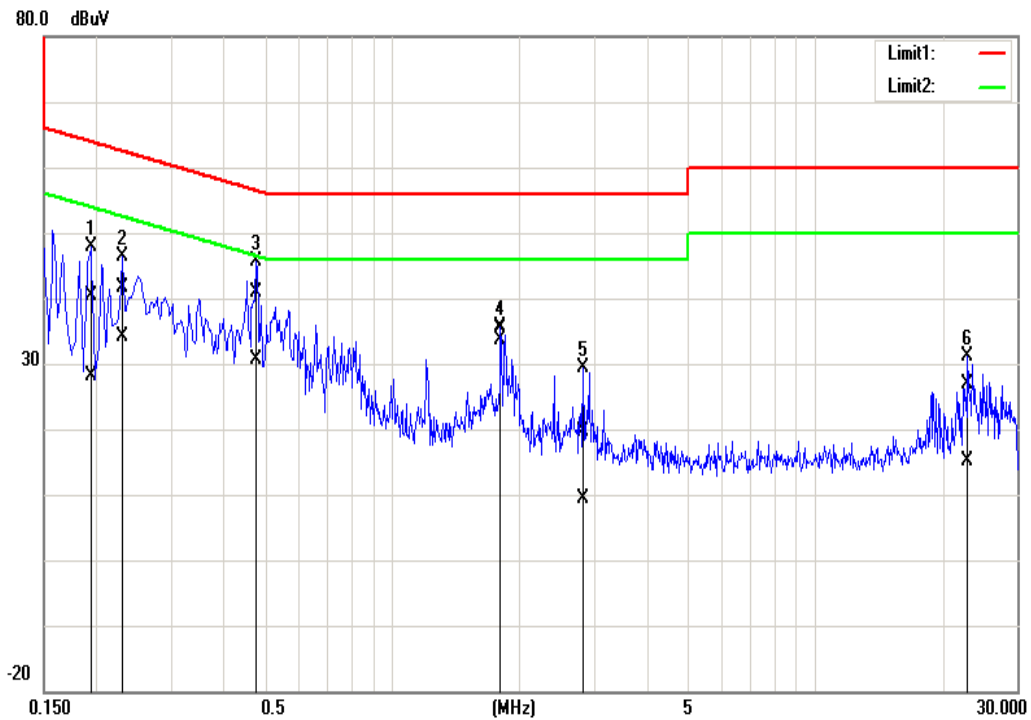

Frequency (MHz)	Quasi Peak reading (dBuV)	Average reading (dBuV)	Correction factor (dB)	Quasi Peak result (dBuV)	Average result (dBuV)	Quasi Peak limit (dBuV)	Average limit (dBuV)	Quasi Peak margin (dB)	Average margin (dB)	Remark
0.1940	30.17	18.06	10.17	40.34	28.23	63.86	53.86	-23.52	-25.63	Pass
0.2300	31.56	23.86	10.17	41.73	34.03	62.45	52.45	-20.72	-18.42	Pass
0.4780	30.64	20.45	10.18	40.82	30.63	56.37	46.37	-15.55	-15.74	Pass
1.8060	25.27	23.52	10.23	35.50	33.75	56.00	46.00	-20.50	-12.25	Pass
2.8260	9.47	-0.83	10.26	19.73	9.43	56.00	46.00	-36.27	-36.57	Pass
22.9980	16.52	4.68	10.47	26.99	15.15	60.00	50.00	-33.01	-34.85	Pass

Note: Correction factor = LISN loss + Cable loss.

Test Mode:	BT EDR	Temp/Hum	24.9(°C)/ 51%RH
Phase:	Line	Test Date	August 17, 2022
Test Voltage:	120Vac, 60Hz	Test Engineer	Tony Chao

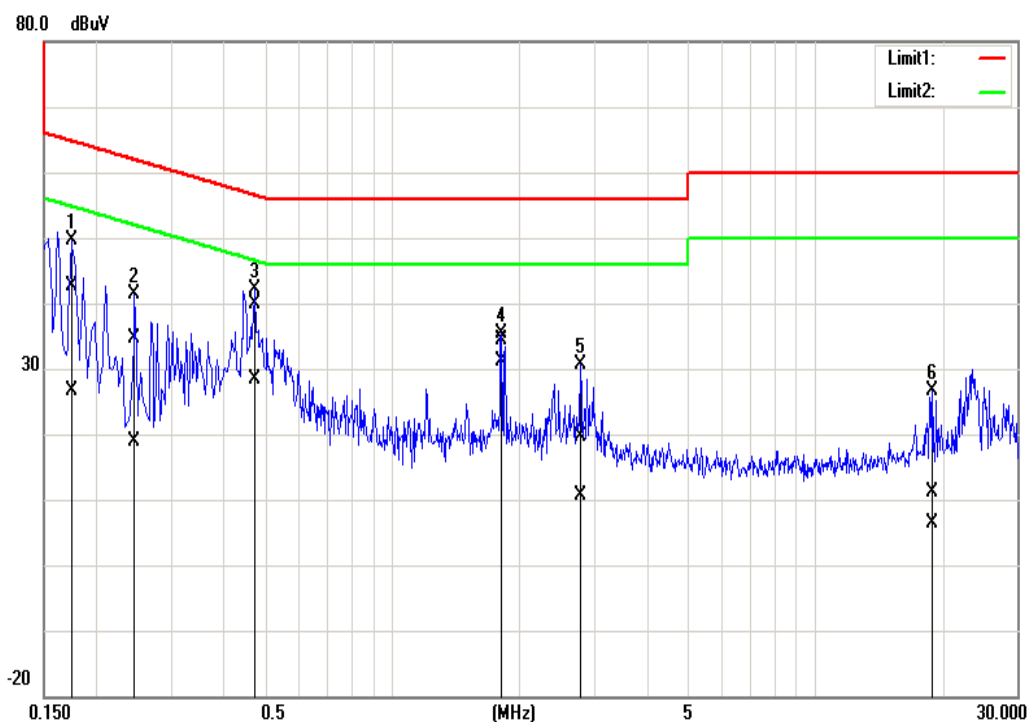

Frequency (MHz)	Quasi Peak reading (dBuV)	Average reading (dBuV)	Correction factor (dB)	Quasi Peak result (dBuV)	Average result (dBuV)	Quasi Peak limit (dBuV)	Average limit (dBuV)	Quasi Peak margin (dB)	Average margin (dB)	Remark
0.1740	32.34	16.46	10.17	42.51	26.63	64.77	54.77	-22.26	-28.14	Pass
0.2460	24.54	8.82	10.18	34.72	19.00	61.89	51.89	-27.17	-32.89	Pass
0.4740	29.71	18.12	10.19	39.90	28.31	56.44	46.44	-16.54	-18.13	Pass
1.8100	24.23	20.90	10.25	34.48	31.15	56.00	46.00	-21.52	-14.85	Pass
2.7900	9.35	0.38	10.28	19.63	10.66	56.00	46.00	-36.37	-35.34	Pass
18.9860	0.84	-4.03	10.37	11.21	6.34	60.00	50.00	-48.79	-43.66	Pass

Note: Correction factor = LISN loss + Cable loss.

Report No.: TMWK2207002885KR

Test Mode:	BT EDR	Temp/Hum	24.9(°C)/ 51%RH
Phase:	Neutral	Test Date	August 17, 2022
Test Voltage:	120Vac, 60Hz	Test Engineer	Tony Chao

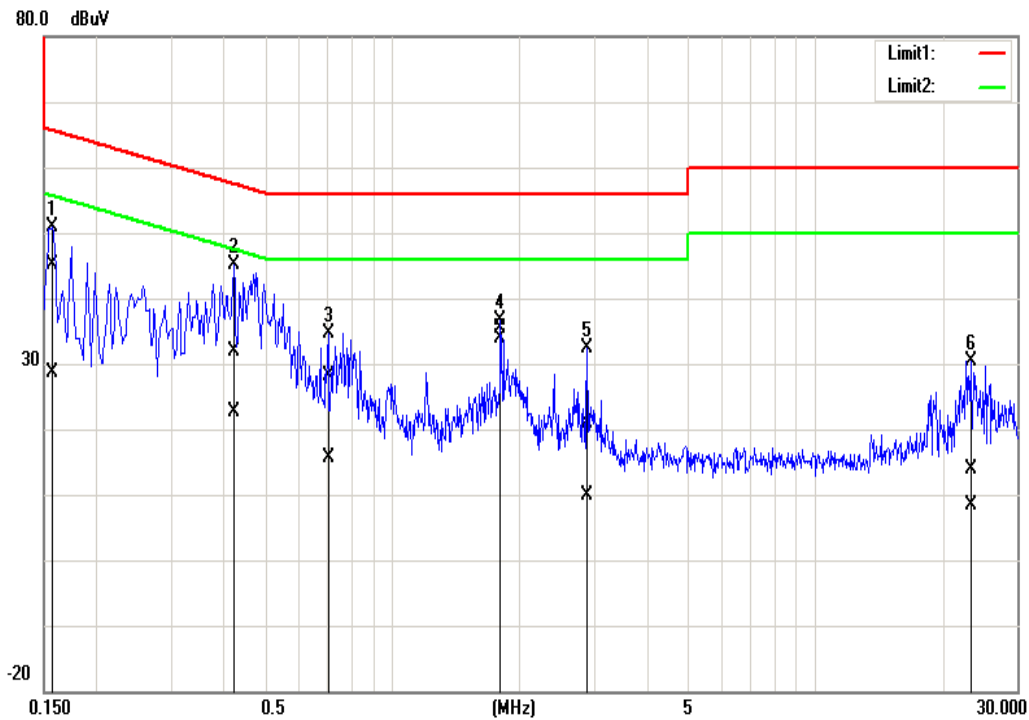

Frequency (MHz)	Quasi Peak reading (dBuV)	Average reading (dBuV)	Correction factor (dB)	Quasi Peak result (dBuV)	Average result (dBuV)	Quasi Peak limit (dBuV)	Average limit (dBuV)	Quasi Peak margin (dB)	Average margin (dB)	Remark
0.1582	34.84	18.38	10.17	45.01	28.55	65.56	55.56	-20.55	-27.01	Pass
0.4220	21.65	12.45	10.18	31.83	22.63	57.41	47.41	-25.58	-24.78	Pass
0.7060	17.94	5.31	10.20	28.14	15.51	56.00	46.00	-27.86	-30.49	Pass
1.8060	25.05	23.58	10.23	35.28	33.81	56.00	46.00	-20.72	-12.19	Pass
2.8900	10.62	-0.43	10.26	20.88	9.83	56.00	46.00	-35.12	-36.17	Pass
23.3300	3.31	-2.20	10.48	13.79	8.28	60.00	50.00	-46.21	-41.72	Pass

Note: Correction factor = LISN loss + Cable loss.

Report No.: TMWK2207002885KR

4.2 20dB BANDWIDTH AND OCCUPIED BANDWIDTH (99%)

4.2.1 Test Limit

According to §15.247(a) (1)

20 dB Bandwidth : For reporting purposes only.

Occupied Bandwidth(99%) : For reporting purposes only.

4.2.2 Test Procedure

Test method Refer as ANSI C63.10: 2013 clause 7.8.7,

1. The EUT RF output connected to the spectrum analyzer by RF cable.
2. Setting maximum power transmit of EUT
3. SA set RBW = 1% ~ 5% OBW, VBW $\geq 3 \times$ RBW and Detector = Peak, to measurement 20 dB Bandwidth.
4. SA set RBW = 1% ~ 5% OBW, VBW \geq three times the RBW and Detector = Peak, to measurement 99% Bandwidth
5. Measure and record the result of 20 dB Bandwidth and 99% Bandwidth. in the test report.

4.2.3 Test Setup

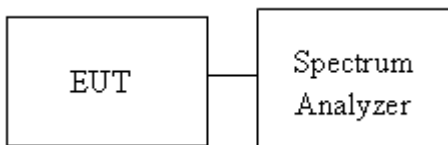

4.2.4 Test Result

Temperature: 25.6°C **Test date:** August 10, 2022
Humidity: 46% RH **Tested by:** Marco Chan

Test mode: GFSK_BDR-1Mbps mode / 2402-2480 MHz			
Channel	Frequency (MHz)	OBW(99%) (MHz)	20dB BW (MHz)
Low	2402	0.74429	0.8516
Mid	2441	0.74398	0.8522
High	2480	0.74397	0.8502

Test mode: $\pi/4$ -DQPSK_2Mbps mode / 2402-2480 MHz			
Channel	Frequency (MHz)	OBW(99%) (MHz)	20dB BW (MHz)
Low	2402	1.1463	1.275
Mid	2441	1.1498	1.275
High	2480	1.1483	1.273

Test mode: 8DPSK_EDR-3Mbps mode / 2402-2480 MHz			
Channel	Frequency (MHz)	OBW(99%) (MHz)	20dB BW (MHz)
Low	2402	1.1515	1.271
Mid	2441	1.1550	1.272
High	2480	1.1538	1.272

Report No.: TMWK2207002885KR

Test Data

20dB BANDWIDTH

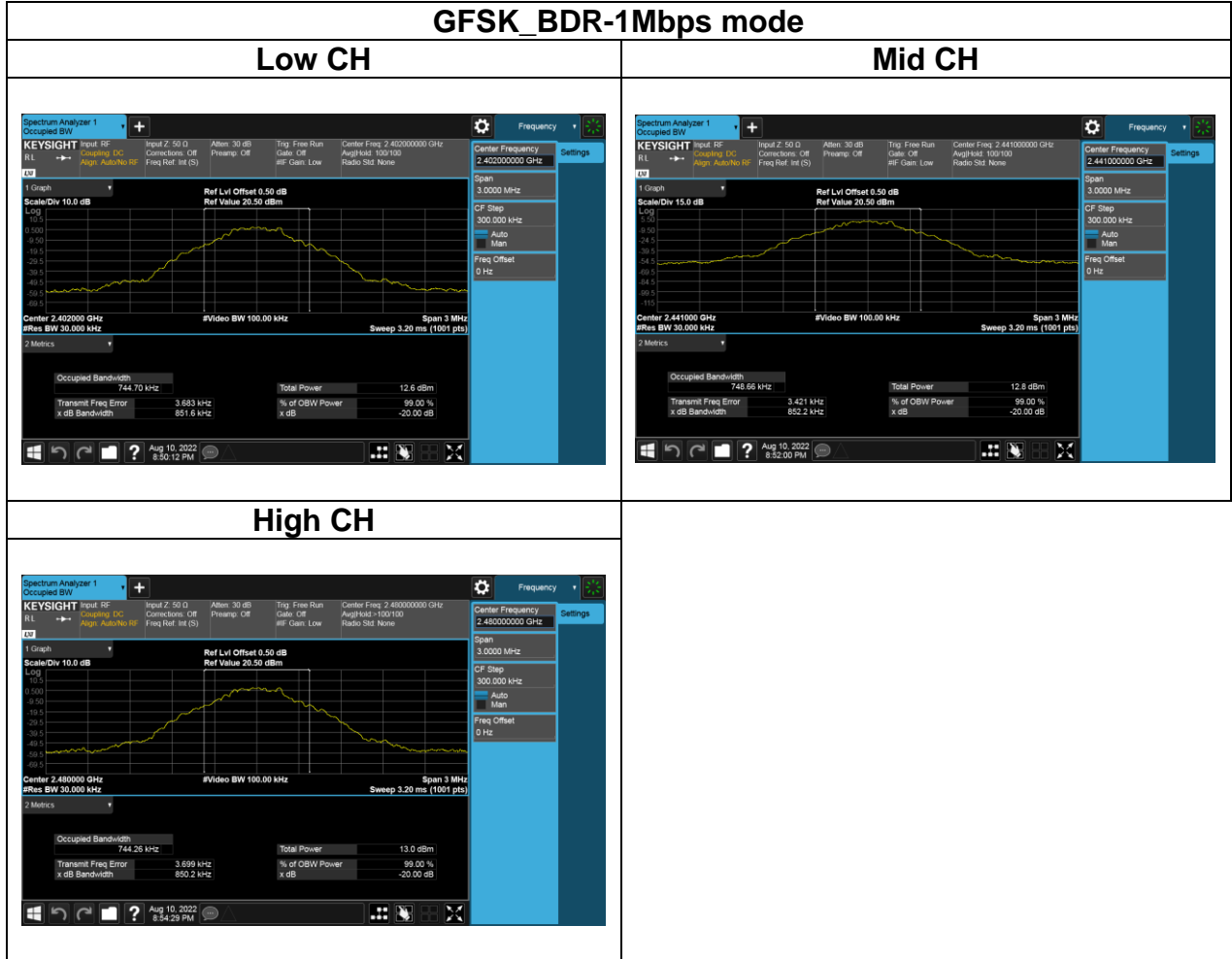

Report No.: TMWK2207002885KR

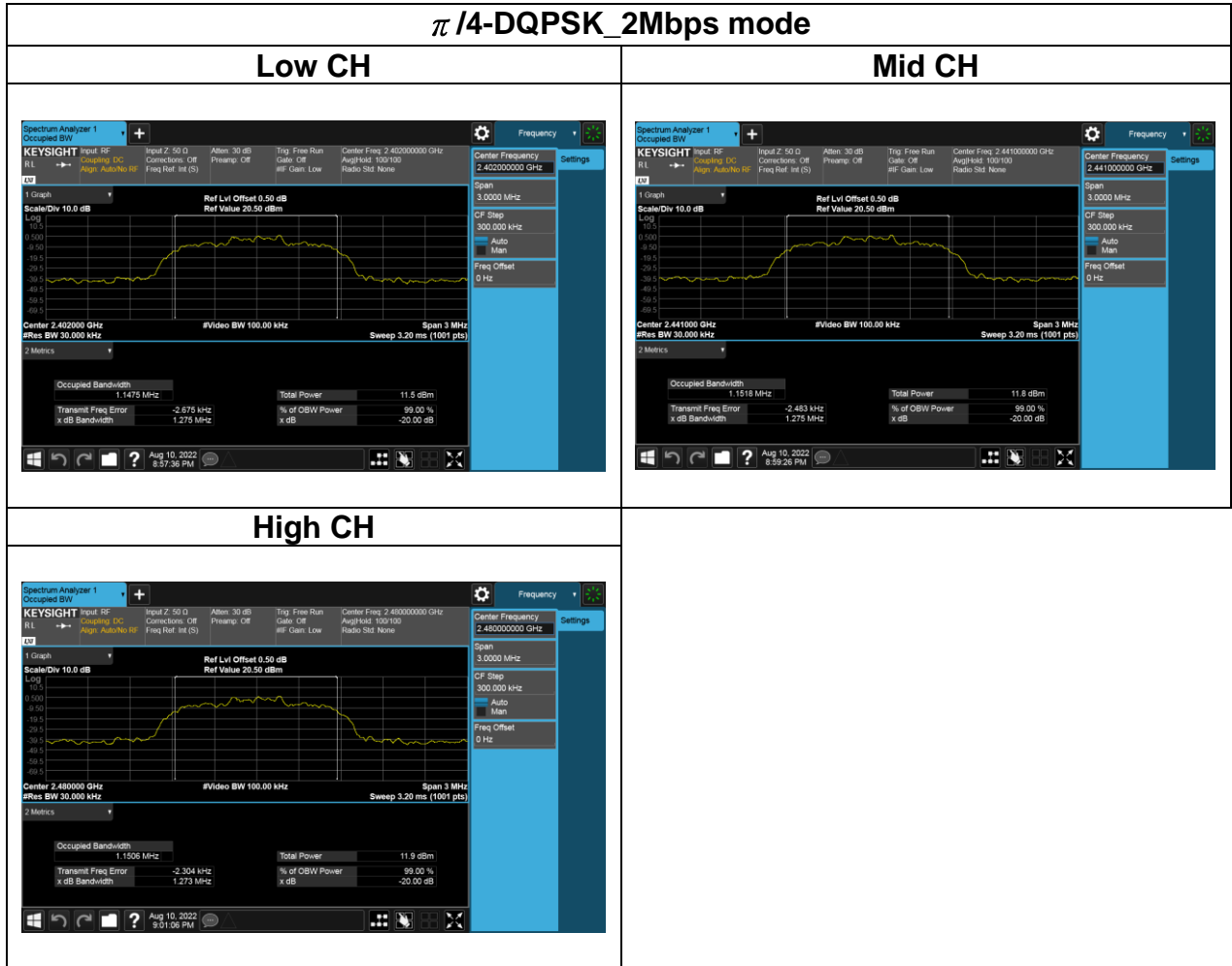

Report No.: TMWK2207002885KR

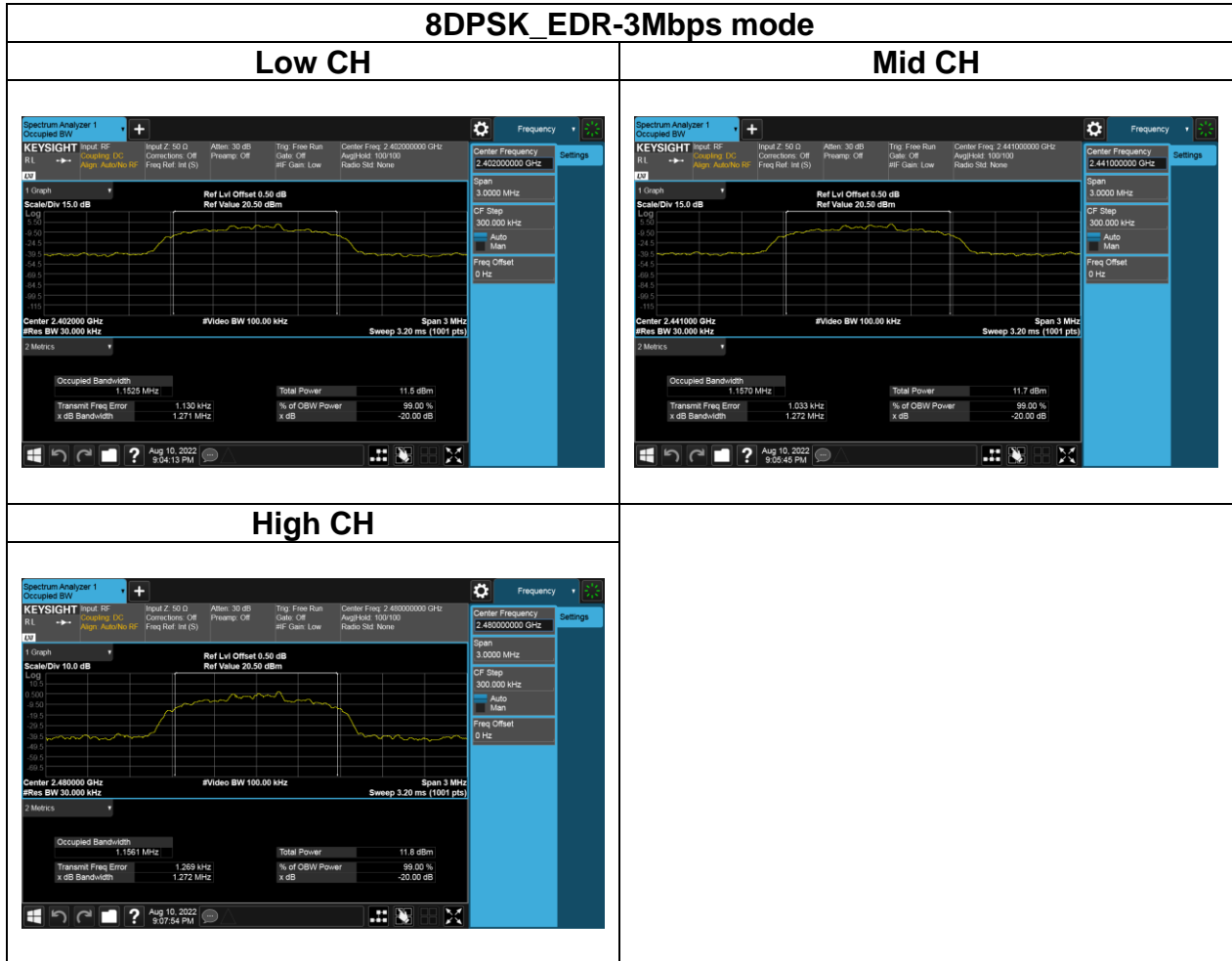

Report No.: TMWK2207002885KR

Test Data

BANDWIDTH 99%

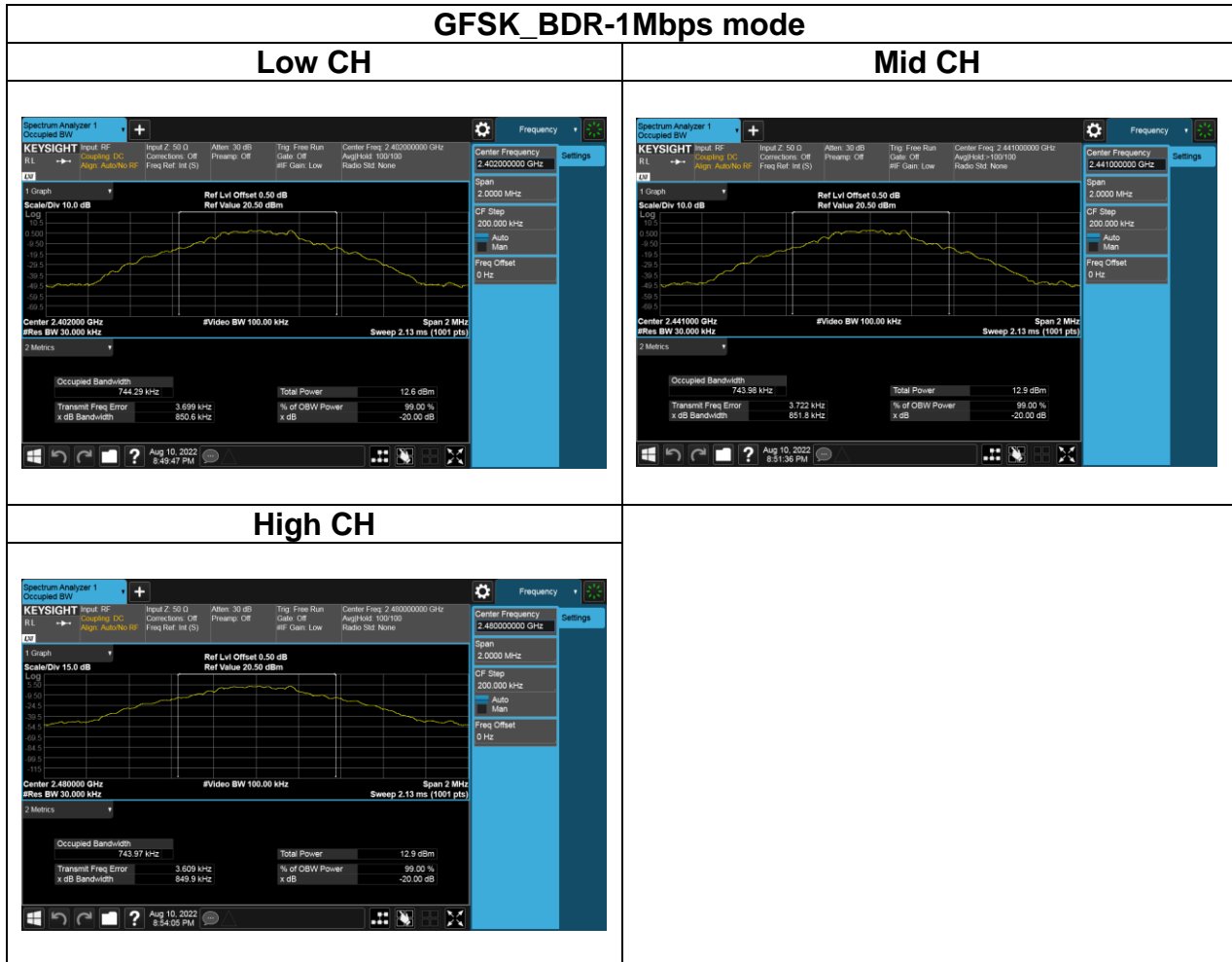

Report No.: TMWK2207002885KR



Report No.: TMWK2207002885KR

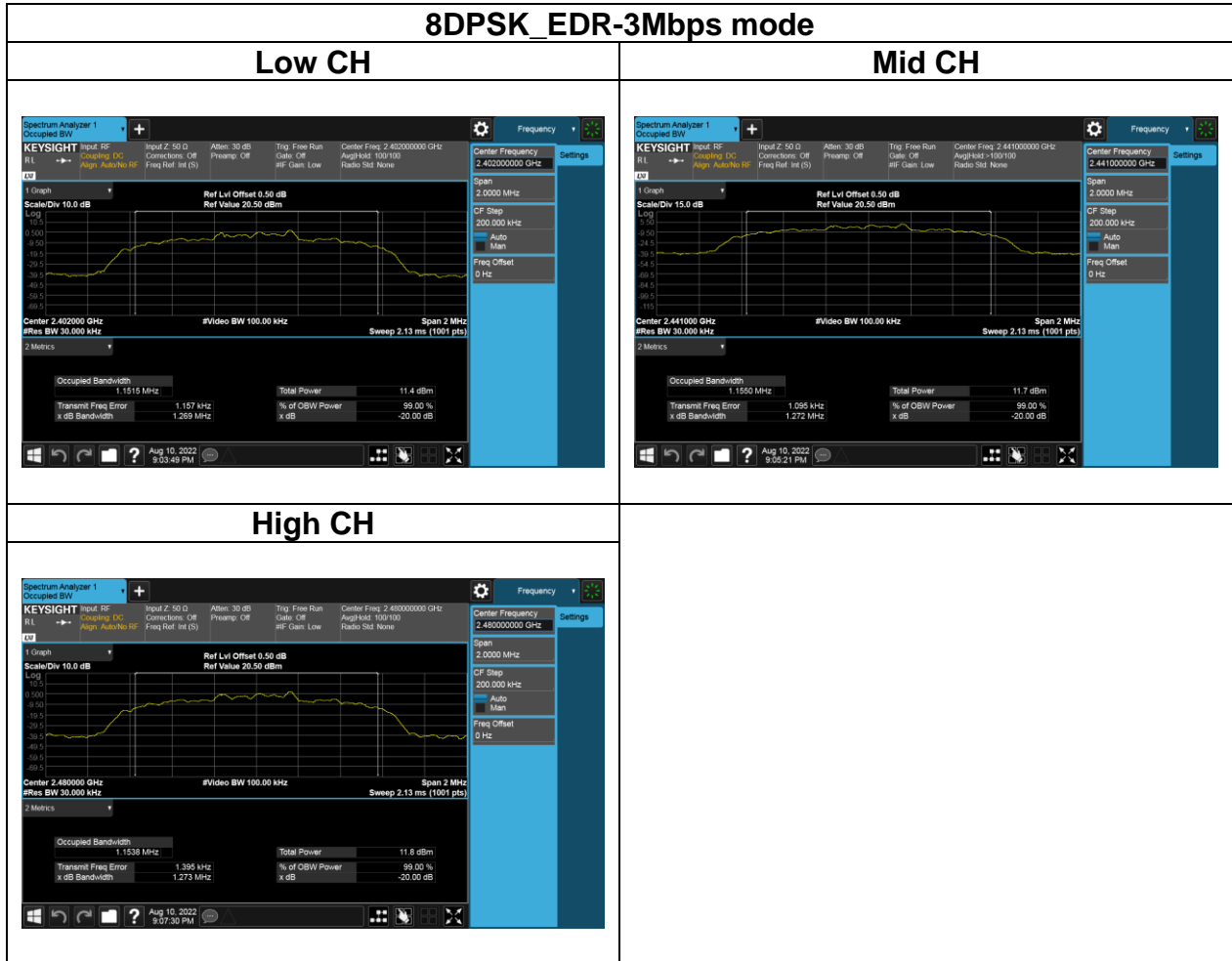

Report No.: TMWK2207002885KR

4.3 OUTPUT POWER MEASUREMENT

4.3.1 Test Limit

According to §15.247(a)(1),

Peak output power :

FCC

Alternatively, frequency hopping systems operating in the 2400-2483.5 MHz band may have hopping channel carrier frequencies that are separated by 25 kHz or two-thirds of the 20 dB bandwidth of the hopping channel, whichever is greater, provided the systems operate with an output power no greater than 125 mW.

Limit	<input checked="" type="checkbox"/> Antenna not exceed 6 dBi : 21dBm <input type="checkbox"/> Antenna with DG greater than 6 dBi : 21dBm [Limit = 30 – (DG – 6)]
-------	--

Average output power : For reporting purposes only.

4.3.2 Test Procedure

1. The EUT RF output connected to the power meter by RF cable.
2. Setting maximum power transmit of EUT.
3. The path loss was compensated to the results for each measurement.
4. Measure and record the result of Peak output power and Average output power. in the test report.

4.3.3 Test Setup

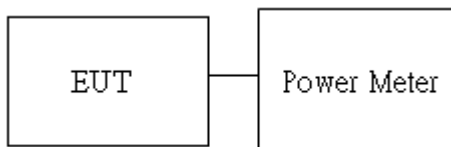

Report No.: TMWK2207002885KR

4.3.4 Test Result

Temperature: 25.6°C

Test date: August 10, 2022

Humidity: 46% RH

Tested by: Marco Chan

Peak output power :

1M BR mode (Peak):

CH	Freq. (MHz)	Power set	Peak Output Power (dBm)	Output Power (mW)	Limit (mW)
Low	2402	default	5.08	3.221	125
Mid	2441	default	5.21	3.319	125
High	2480	default	5.23	3.334	125

2M EDR mode (Peak):

CH	Freq. (MHz)	Power set	Peak Output Power (dBm)	Output Power (mW)	Limit (mW)
Low	2402	default	4.38	2.742	125
Mid	2441	default	4.58	2.871	125
High	2480	default	4.62	2.897	125

3M EDR mode (Peak):

CH	Freq. (MHz)	Power set	Peak Output Power (dBm)	Output Power (mW)	Limit (mW)
Low	2402	default	4.48	2.805	125
Mid	2441	default	4.64	2.911	125
High	2480	default	4.67	2.931	125

Average output power :

1M BR mode (Average):

CH	Freq. (MHz)	Power set	Max. Avg. Output Power (dBm)	Output Power (mW)	Limit (mW)
Low	2402	default	5.04	3.194	125
Mid	2441	default	5.17	3.291	125
High	2480	default	5.20	3.314	125

2M EDR mode (Average):

CH	Freq. (MHz)	Power set	Max. Avg. Output Power (dBm)	Output Power (mW)	Limit (mW)
Low	2402	default	2.00	1.584	125
Mid	2441	default	2.31	1.701	125
High	2480	default	2.35	1.716	125

3M EDR mode (Average):

CH	Freq. (MHz)	Power set	Max. Avg. Output Power (dBm)	Output Power (mW)	Limit (mW)
Low	2402	default	1.99	1.583	125
Mid	2441	default	2.28	1.692	125
High	2480	default	2.32	1.708	125

Report No.: TMWK2207002885KR

4.4 FREQUENCY SEPARATION

4.4.1 Test Limit

According to §15.247(a)(1)

Alternatively, frequency hopping systems operating in the 2400-2483.5 MHz band may have hopping channel carrier frequencies that are separated by 25 kHz or two-thirds of the 20 dB bandwidth of the hopping channel, whichever is greater, provided the systems operate with an output power no greater than 125 mW.

Limit	> two-thirds of the 20 dB bandwidth
-------	-------------------------------------

4.4.2 Test Procedure

1. Place the EUT on the table and set it in transmitting mode.
2. EUT RF output port connected to the SA by RF cable.
3. Set the spectrum analyzer as RBW = 300kHz, VBW = 300kHz, Sweep = auto.
Max hold, mark 3 peaks of hopping channel and record the 3 peaks frequency

4.4.3 Test Setup

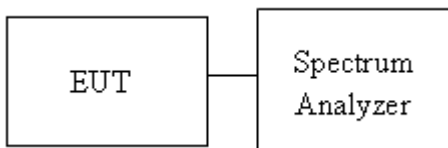

Report No.: TMWK2207002885KR

4.4.4 Test Result

Temperature: 25.6°C

Test date: August 10, 2022

Humidity: 46% RH

Tested by: Marco Chan

Test mode: GFSK_BDR-1Mbps mode / 2402-2480 MHz				
Channel	Frequency (MHz)	Channel Separation (MHz)	Channel Separation Limits (MHz)	Result
Low	2402	1.000	0.57	PASS
Mid	2441	1.000	0.57	PASS
High	2480	1.000	0.57	PASS

Test mode: $\pi/4$ -DQPSK_2Mbps mode / 2402-2480 MHz				
Channel	Frequency (MHz)	Channel Separation (MHz)	Channel Separation Limits (MHz)	Result
Low	2402	1.000	0.85	PASS
Mid	2441	1.000	0.85	PASS
High	2480	1.000	0.85	PASS

Test mode: 8DPSK_EDR-3Mbps mode / 2402-2480 MHz				
Channel	Frequency (MHz)	Channel Separation (MHz)	Channel Separation Limits (MHz)	Result
Low	2402	1.000	0.85	PASS
Mid	2441	1.000	0.85	PASS
High	2480	1.000	0.85	PASS

Report No.: TMWK2207002885KR

Test Data

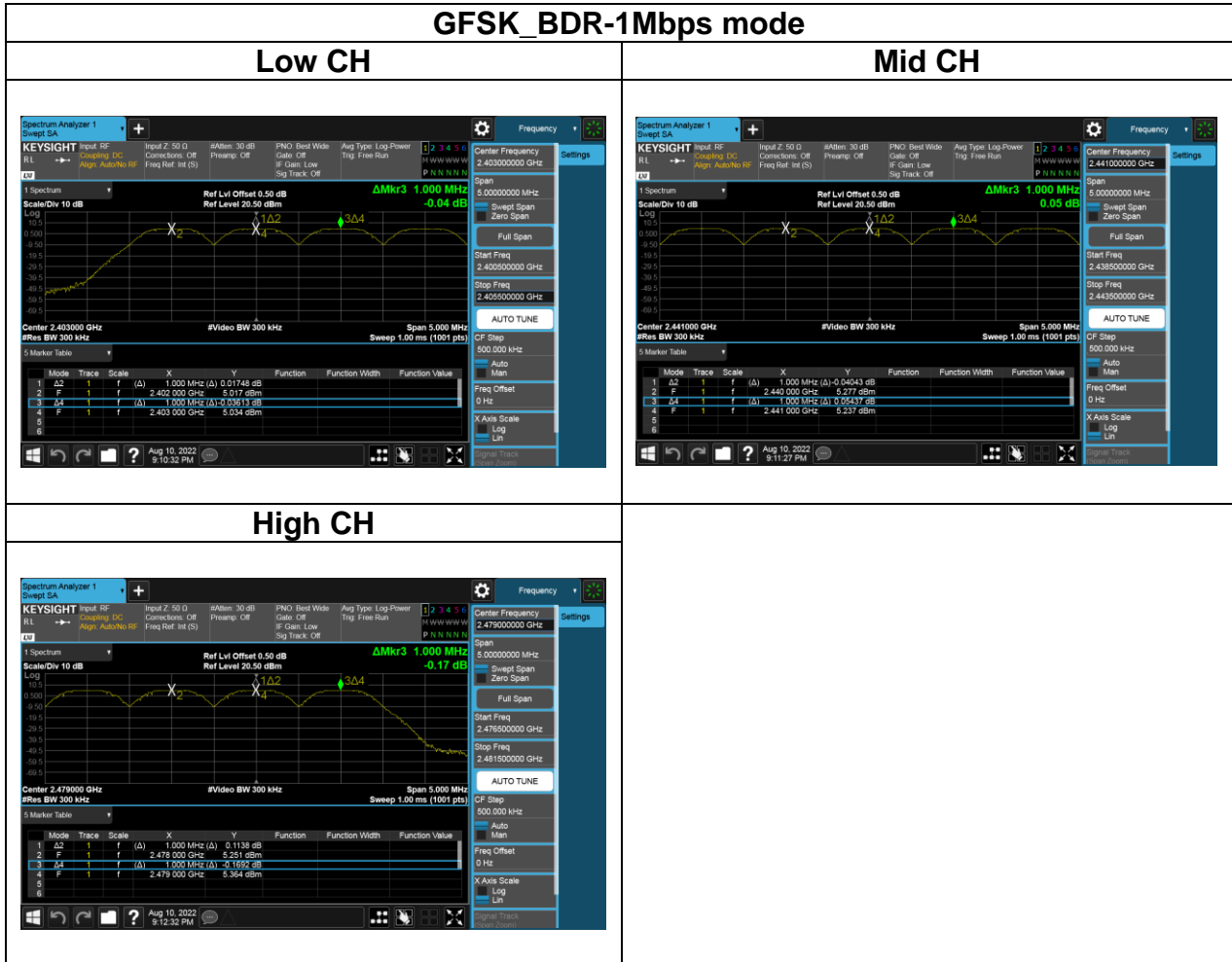

Report No.: TMWK2207002885KR

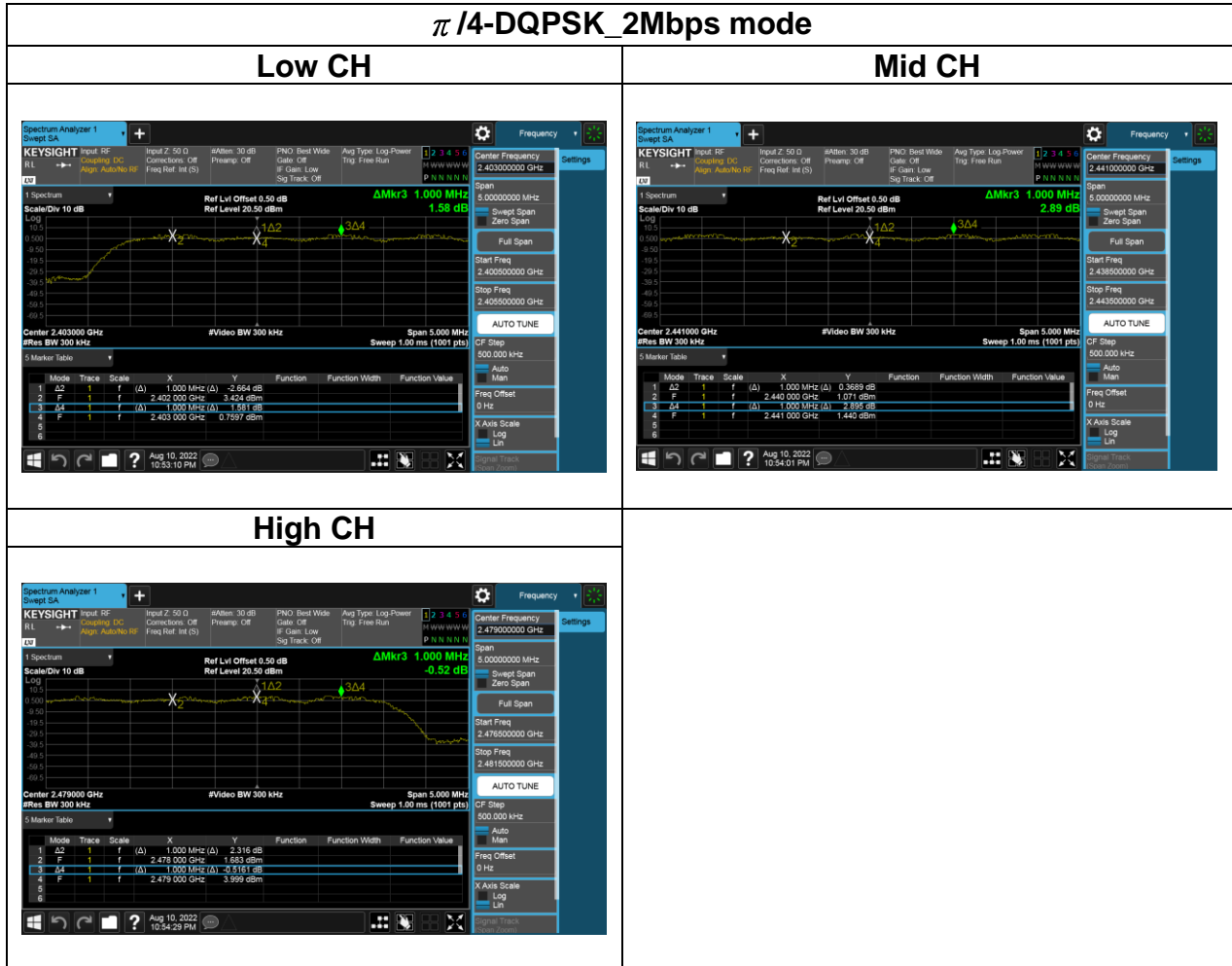

Report No.: TMWK2207002885KR

8DPSK_EDR-3Mbps mode

Low CH

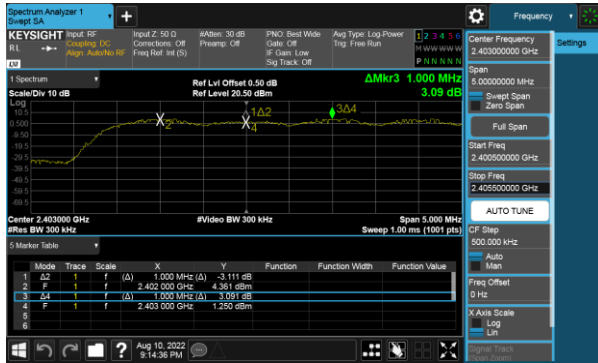

Mid CH

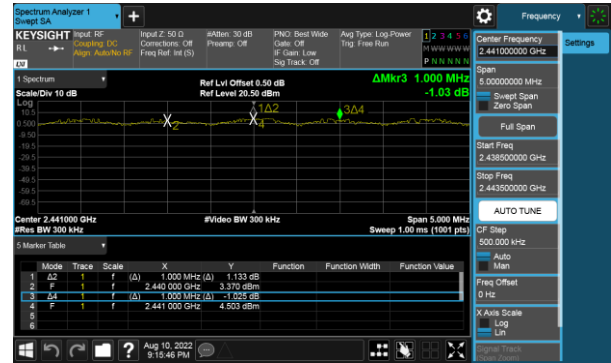

High CH

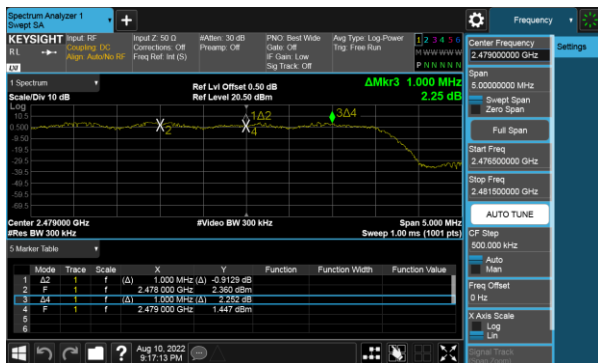

Report No.: TMWK2207002885KR

4.5 NUMBER OF HOPPING

4.5.1 Test Limit

According to §15.247(a)(1)(iii)

Frequency hopping systems in the 2400-2483.5 MHz band shall use at least 15 channels.

4.5.2 Test Procedure

Test method Refer as ANSI C63.10: 2013 clause 7.8.3

1. Place the EUT on the table and set it in transmitting mode.
2. EUT RF output port connected to the SA by RF cable.
3. Set spectrum analyzer Start Freq. = 2400 MHz, Stop Freq. = 2441 MHz for Low range, Start Freq. = 2441 MHz, Stop Freq. = 2483.5 MHz for High range ; RBW=430KHz, VBW = 1.5MHz.
4. Max hold, view and count how many channel in the band.

4.5.3 Test Setup

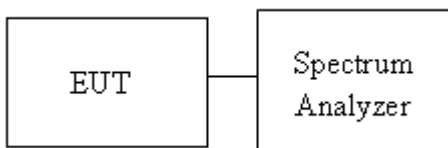

Report No.: TMWK2207002885KR

4.5.4 Test Result

Temperature: 25.6°C

Test date: August 10, 2022

Humidity: 46% RH

Tested by: Marco Chan

Number of Hopping				
Mode	Frequency (MHz)	Hopping Channel Number	Hopping Channel Number Limits	Result
BDR-1Mbps	2402-2480	79	15	Pass
EDR-3Mbps	2402-2480	79	15	

Report No.: TMWK2207002885KR

Test Data

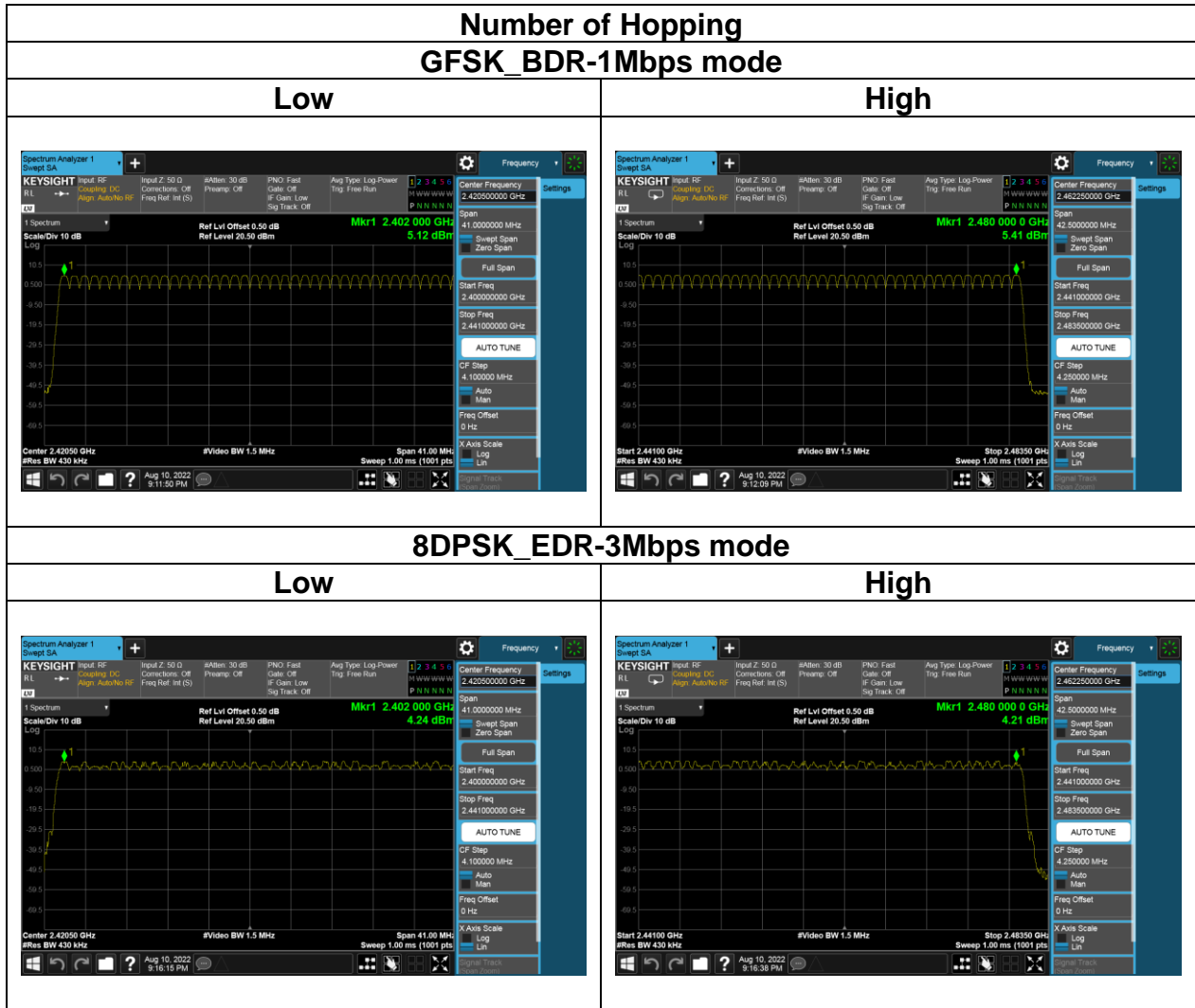

Report No.: TMWK2207002885KR

4.6 CONDUCTED BANDEDGE AND SPURIOUS EMISSION

4.6.1 Test Limit

According to §15.247(d)

Limit	-20 dBc
-------	---------

4.6.2 Test Procedure

1. EUT RF output port connected to the SA by RF cable, and the path loss was compensated to result.
2. SA setting, RBW=100kHz, VBW=300kHz, Detector=Peak, Trace mode = max hold, SWT = Auto.
3. The Band Edge at 2.4GHz and 2.4835GHz are investigated with both hopping "ON" and "OFF" modes ".

4.6.3 Test Setup

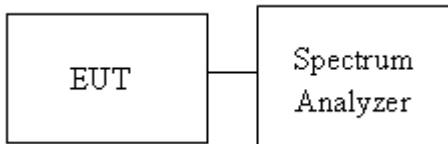

Report No.: TMWK2207002885KR

4.6.4 Test Result

Temperature: 25.6°C

Test date: August 10, 2022

Humidity: 46% RH

Tested by: Marco Chan

Test Data

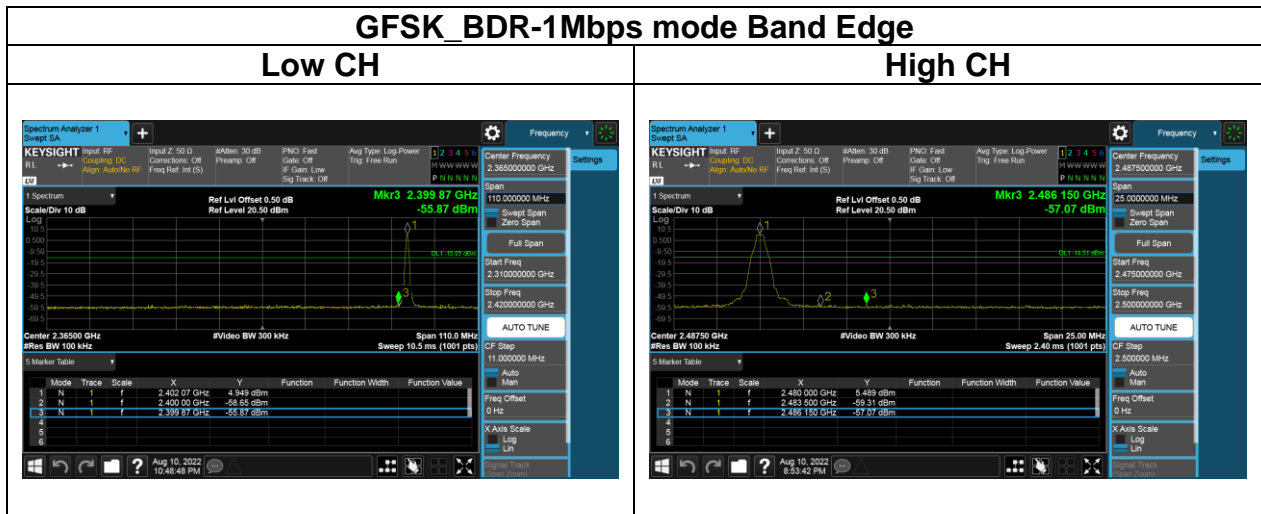

Report No.: TMWK2207002885KR

GFSK_BDR-1Mbps mode Spurious Emission 30MHz-25GHz

Low CH

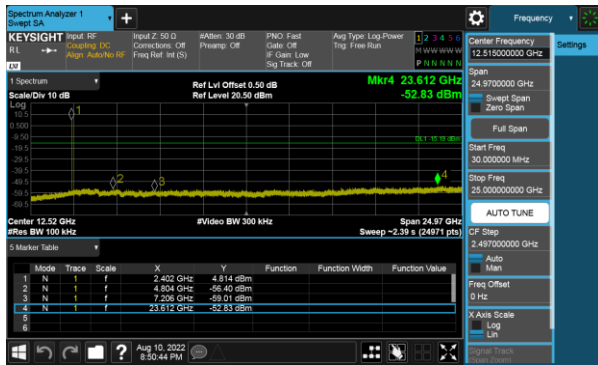

Mid CH

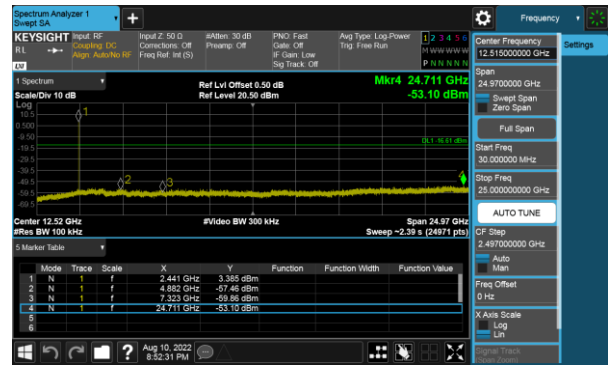

High CH

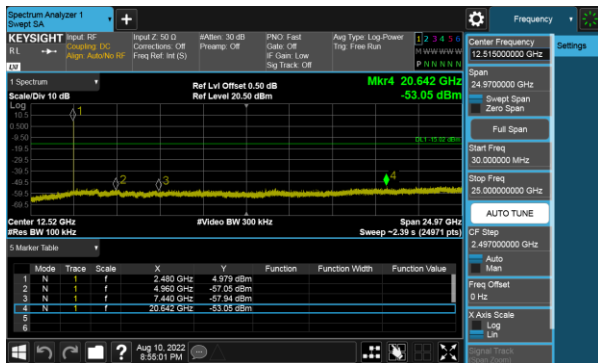

Report No.: TMWK2207002885KR

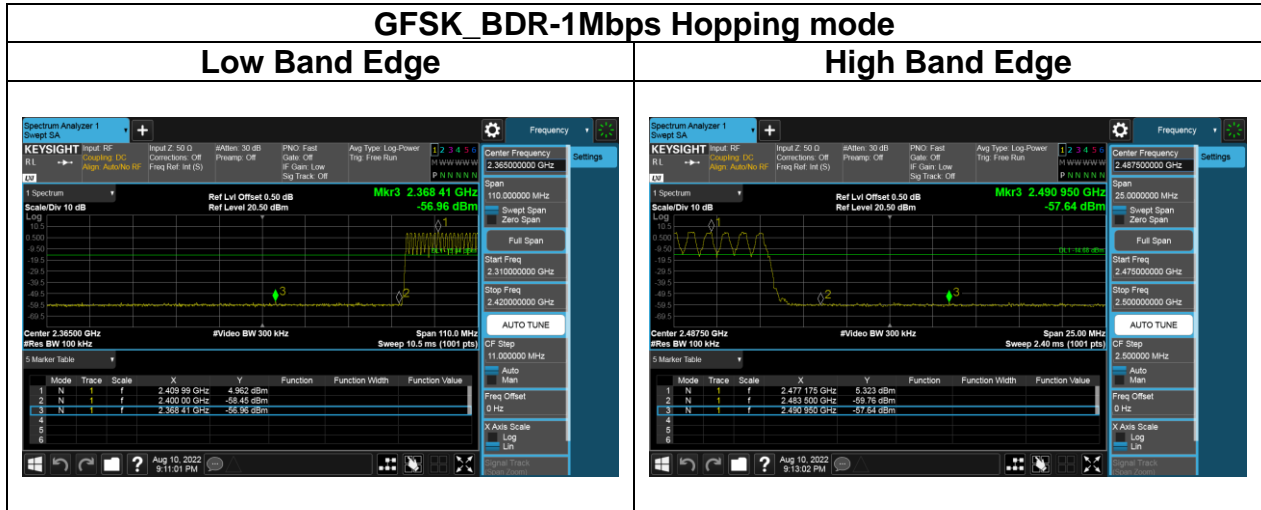

Report No.: TMWK2207002885KR

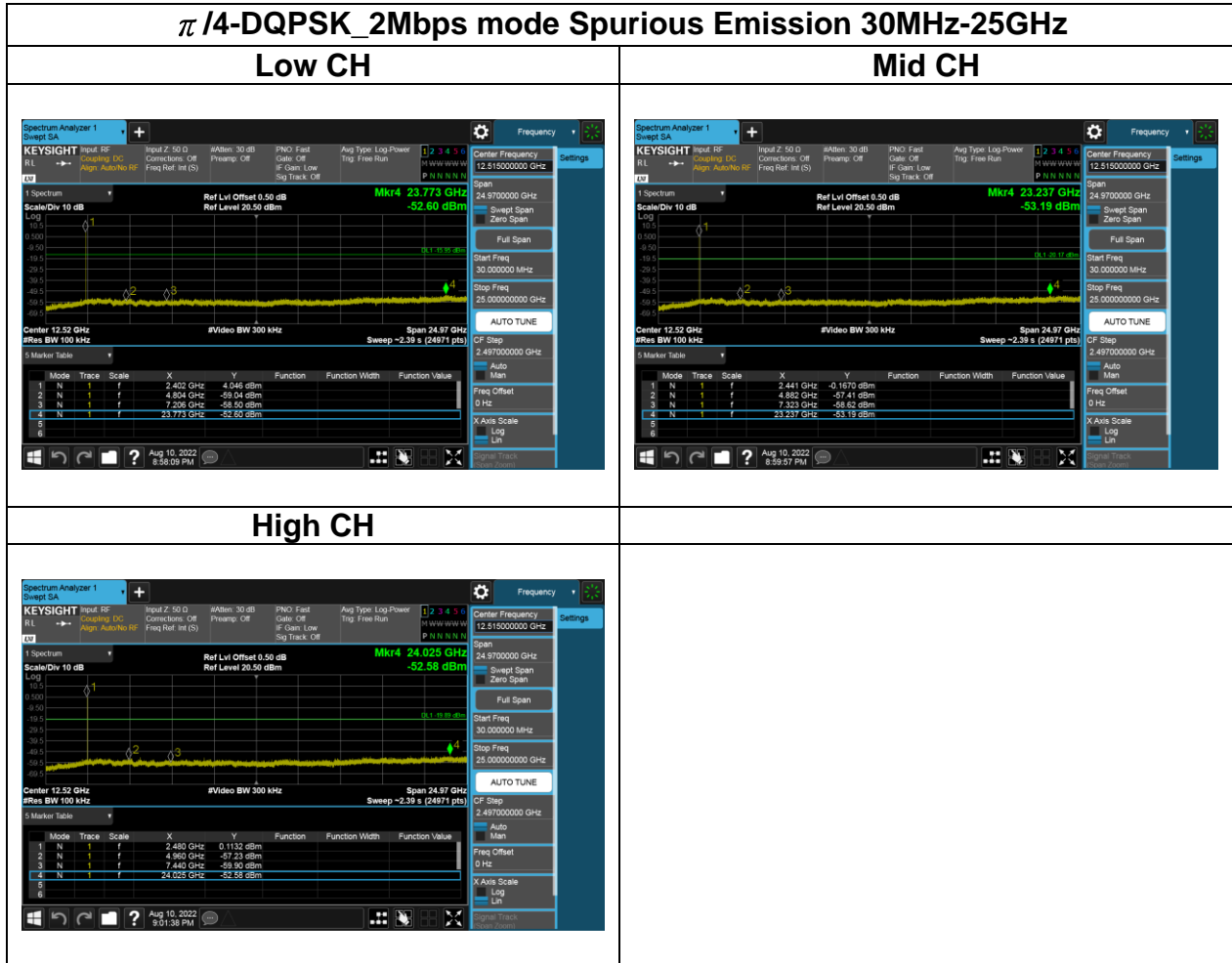

Report No.: TMWK2207002885KR

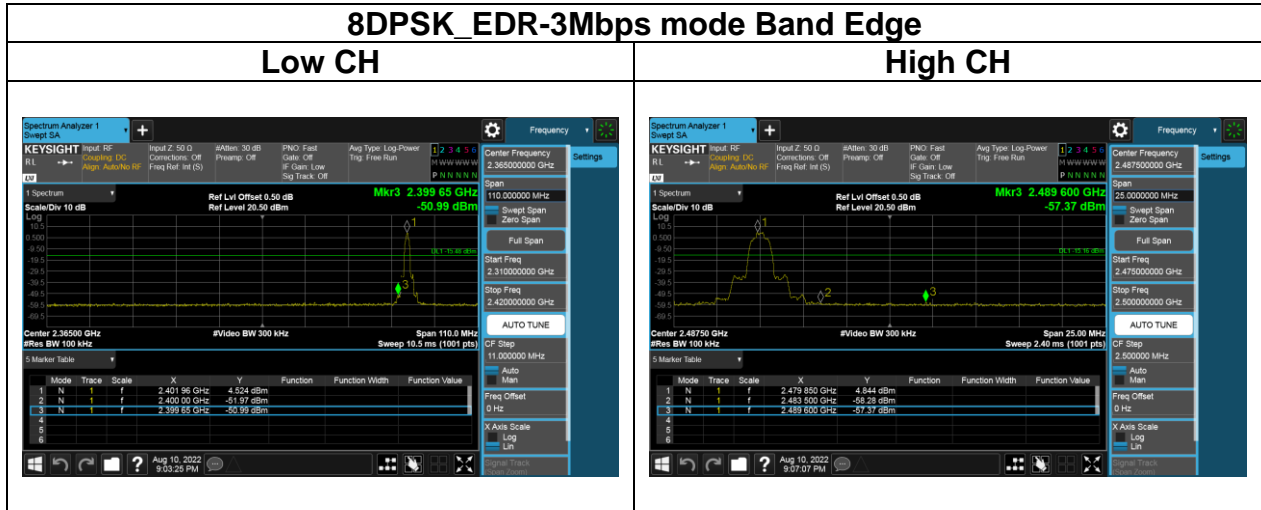

Report No.: TMWK2207002885KR

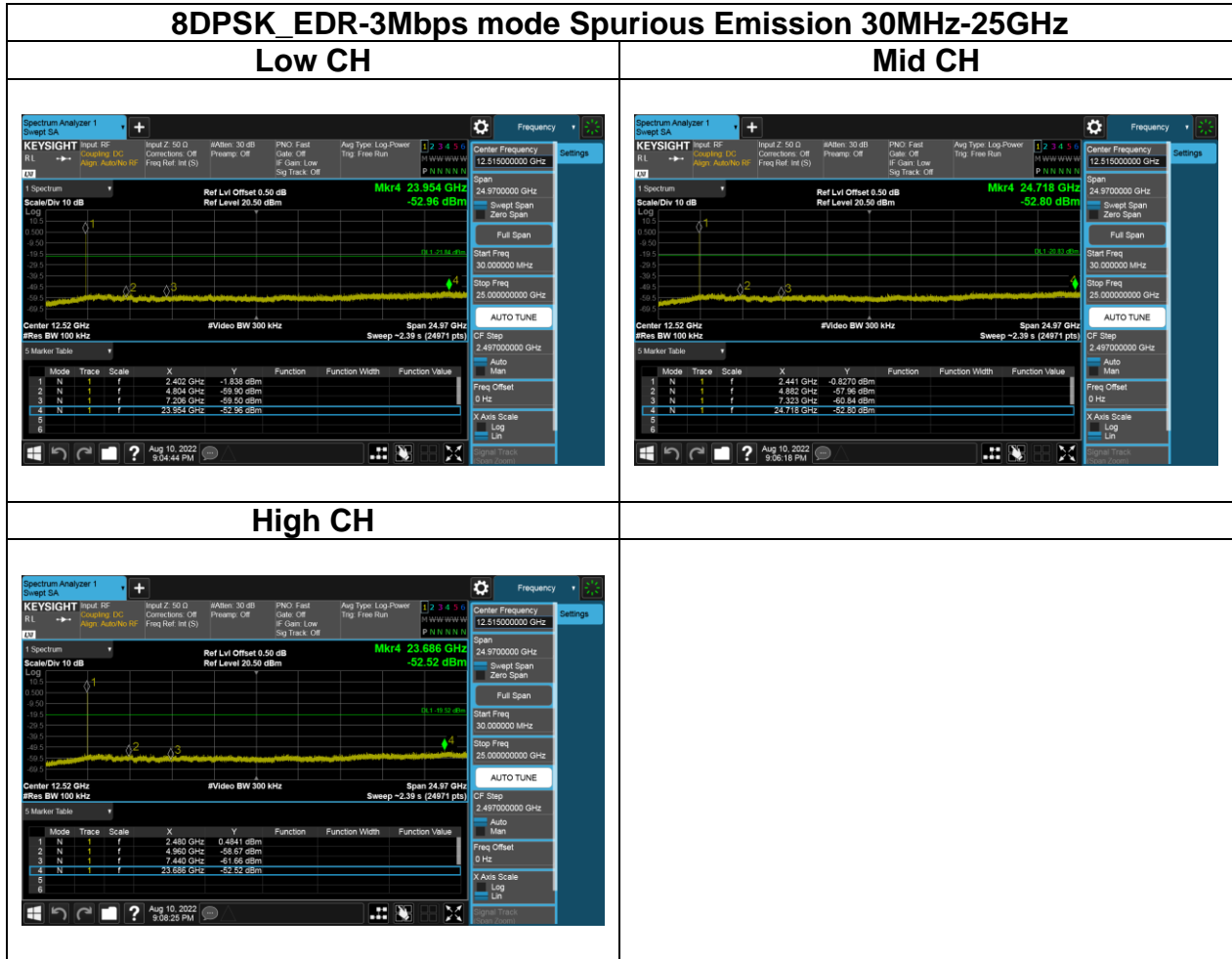

Report No.: TMWK2207002885KR

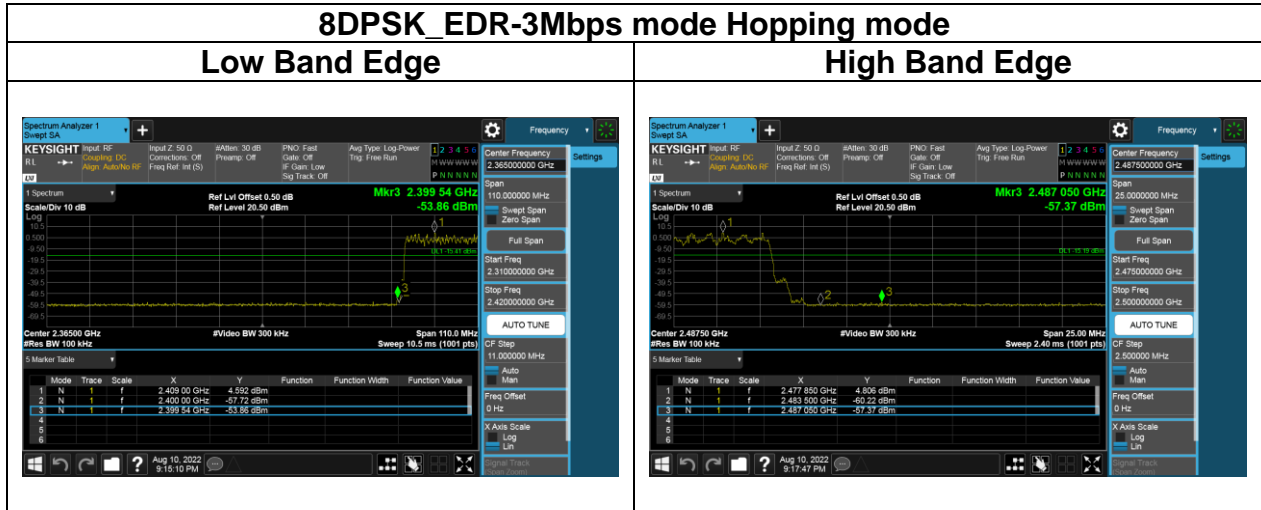

4.7 TIME OF OCCUPANCY (DWELL TIME)

4.7.1 Test Limit

According to §15.247(a)(1)(iii)

The average time of occupancy on any channel shall not be greater than 0.4 seconds within a period of 0.4 seconds multiplied by the number of hopping channels employed.

4.7.2 Test Procedure

1. EUT RF output port connected to the SA by RF cable.
2. Set center frequency of spectrum analyzer = operating frequency.
3. Set the spectrum analyzer as RBW, VBW=3MHz, Sweep > one cycle.

4.7.3 Test Setup

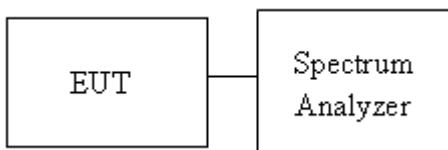

Report No.: TMWK2207002885KR

4.7.4 Test Result

Temperature: 25.6°C Test date: August 10, 2022
Humidity: 46% RH Tested by: Marco Chan

For GFSK (1Mbps)

Channel	PACKET TYPE	Measurement Result (ms)	Limit (ms)
Mid	DH1	121.60	400ms
	DH3	262.40	400ms
	DH5	308.80	400ms

CH Mid DH1 time slot = 0.380 * (1600/2/79) * 31.6 = 121.60 (ms)
 DH3 time slot = 1.640 * (1600/4/79) * 31.6 = 262.40 (ms)
 DH5 time slot = 2.895 * (1600/6/79) * 31.6 = 308.80 (ms)

For $\pi/4$ -DQPSK (2Mbps):

Channel	PACKET TYPE	Measurement Result (ms)	Limit (ms)
Mid	2DH1	123.20	400ms
	2DH3	262.40	400ms
	2DH5	307.20	400ms

CH Mid 2DH1 time slot = 0.385 * (1600/2/79) * 31.6 = 123.20 (ms)
 2DH3 time slot = 1.640 * (1600/4/79) * 31.6 = 262.40 (ms)
 2DH5 time slot = 2.880 * (1600/6/79) * 31.6 = 307.20 (ms)

For 8-DPSK (3Mbps)

Channel	PACKET TYPE	Measurement Result (ms)	Limit (ms)
Mid	3DH1	123.20	400ms
	3DH3	262.40	400ms
	3DH5	308.80	400ms

CH Mid 3DH1 time slot = 0.385 * (1600/2/79) * 31.6 = 123.20 (ms)
 3DH3 time slot = 1.640 * (1600/4/79) * 31.6 = 262.40 (ms)
 3DH5 time slot = 2.895 * (1600/6/79) * 31.6 = 308.80 (ms)

Report No.: TMWK2207002885KR

For GFSK (1Mbps)

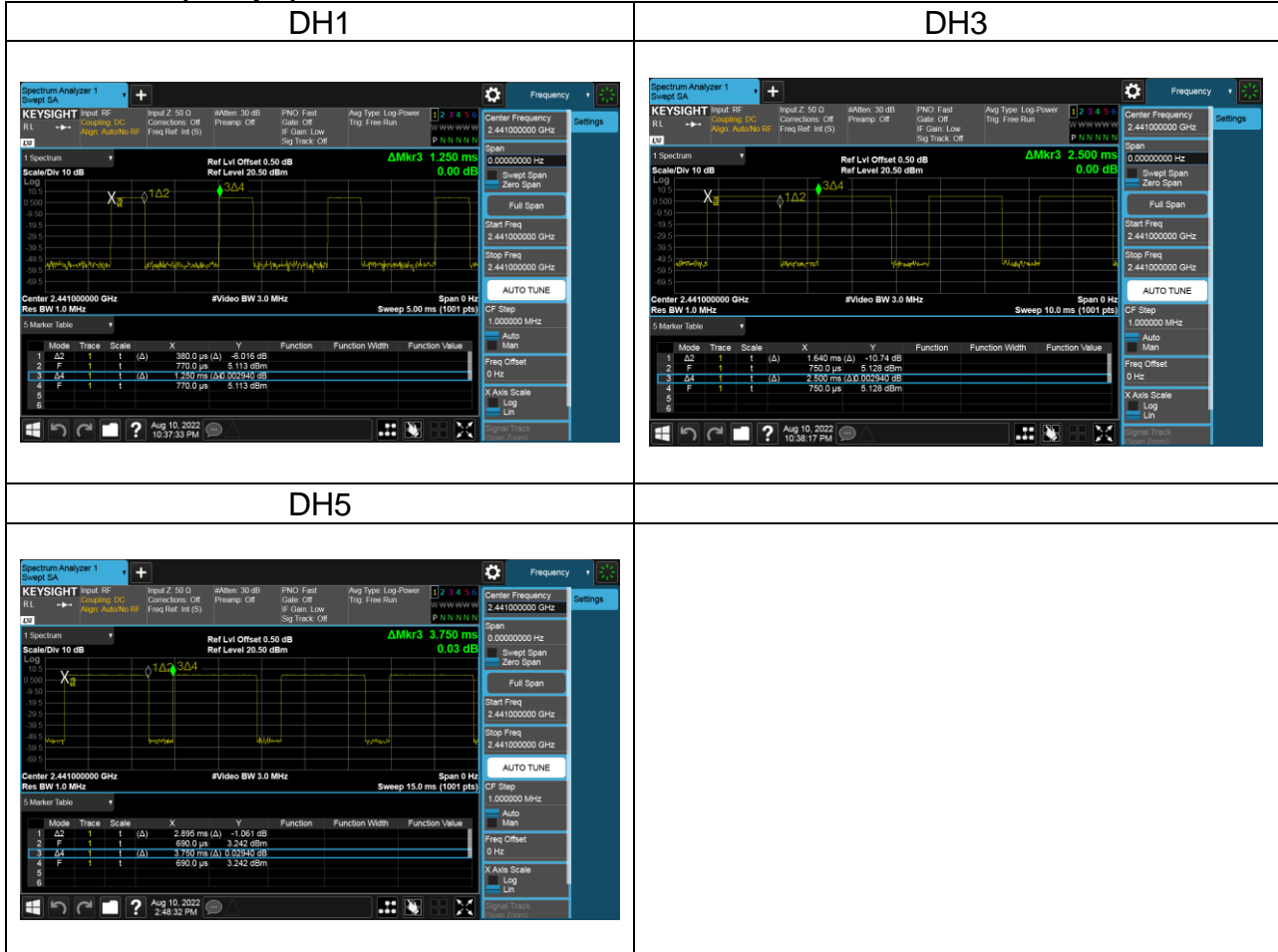

Report No.: TMWK2207002885KR

For $\pi/4$ -DQPSK (2Mbps)

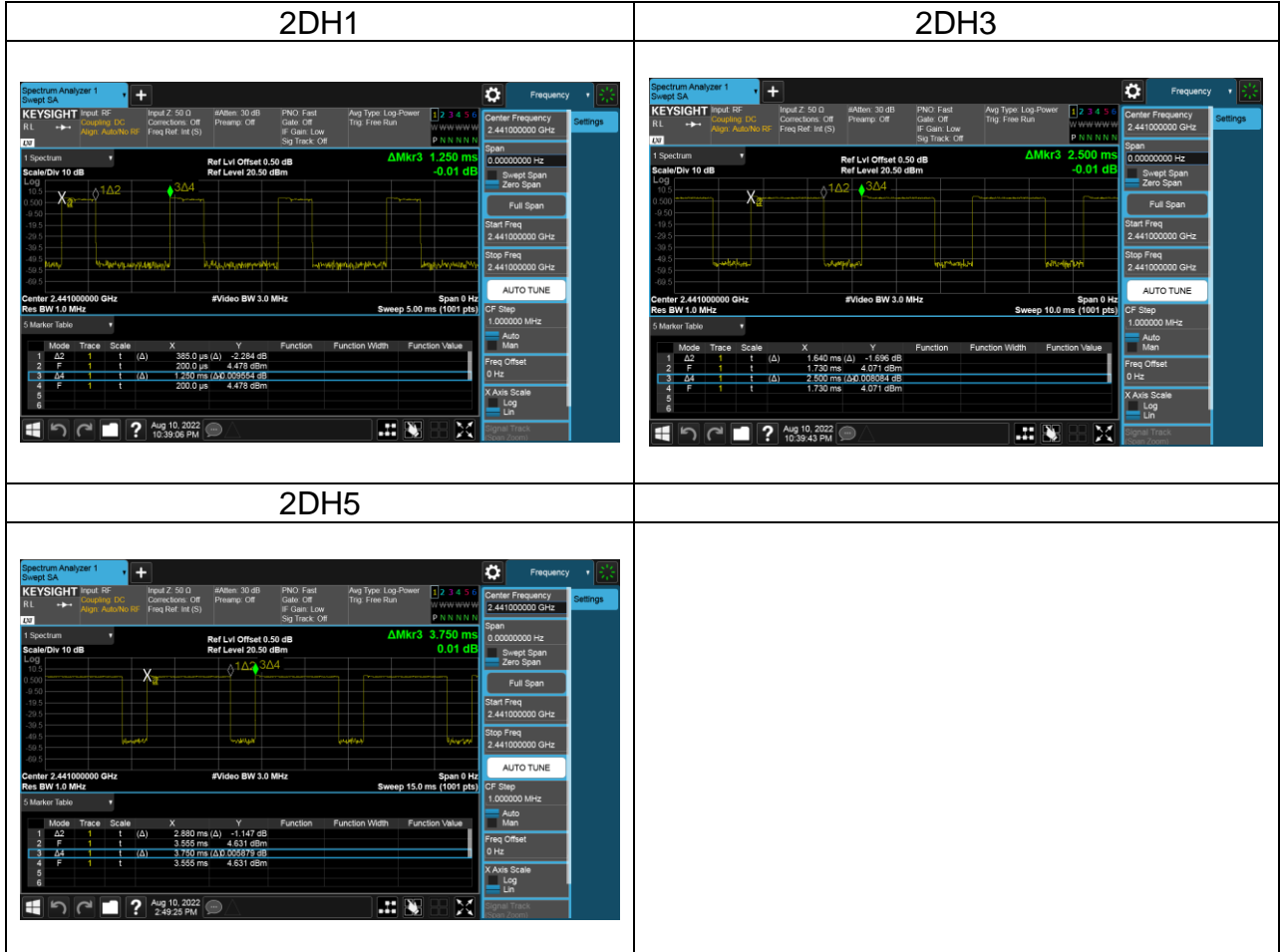

Report No.: TMWK2207002885KR

For 8-DPSK (3Mbps)



Report No.: TMWK2207002885KR

4.8 RADIATION BANDEDGE AND SPURIOUS EMISSION

4.8.1 Test Limit

FCC according to §15.247(d), §15.209 and §15.205,

In any 100 kHz bandwidth outside the authorized frequency band, all harmonic and spurious must be least 20 dB below the highest emission level with the authorized frequency band. Radiation emission which fall in the restricted bands must also follow the FCC section 15.209 as below limit in table.

Below 30 MHz

Frequency	Field Strength (microvolts/m)	Magnetic H-Field (microamperes/m)	Measurement Distance (metres)
9-490 kHz	2,400/F (F in kHz)	2,400/F (F in kHz)	300
490-1,705 kHz	24,000/F (F in kHz)	24,000/F (F in kHz)	30
1.705-30 MHz	30	N/A	30

Above 30 MHz

Frequency (MHz)	Field Strength microvolts/m at 3 metres (watts, e.i.r.p.)	
	Transmitters	Receivers
30-88	100 (3 nW)	100 (3 nW)
88-216	150 (6.8 nW)	150 (6.8 nW)
216-960	200 (12 nW)	200 (12 nW)
Above 960	500 (75 nW)	500 (75 nW)

Remark:

Although these tests were performed other than open area test site, adequate comparison measurements were confirmed against 30 m open are test site. Therefore sufficient tests were made to demonstrate that the alternative site produces results that correlate with the ones of tests made in an open field based on KDB 414788.

Report No.: TMWK2207002885KR

4.8.2 Test Procedure

1. The EUT is placed on a turntable, Above 1 GHz is 1.5m and below 1 GHz is 0.8m above ground plane. The EUT Configured un accordance with ANSI C63.10: 2013, and the EUT set in a continuous mode.

2. The turntable shall be rotated for 360 degrees to determine the position of maximum emission level. And EUT is set 3m away from the receiving antenna, which is scanned from 1m to 4m above the ground plane to find out the highest emissions. Measurement are made polarized in both the vertical and the horizontal positions with antenna.

3. Span shall wide enough to full capture the emission measured. The SA from 9kHz to 26.5GHz set to the low, Mid and High channels with the EUT transmit.

Note: No emission found between lowest internal used/generated frequency to 30MHz(9KHz~30MHz)

4. The SA setting following :

(1) Below 1G : RBW = 100kHz, VBW \geq 3 RBW, Sweep = Auto, Detector = Peak, Trace = Max hold.

(2) Above 1G :

(2.1) For Peak measurement : RBW = 1MHz, VBW \geq 3 RBW, Sweep = Auto, Detector = Peak, Trace = Max hold.

(2.2) For Average measurement : RBW = 1MHz, VBW

·If Duty Cycle \geq 98%, VBW=10Hz.

·If Duty Cycle < 98%, VBW \geq 1/T.

5. Data result

Actual FS=Spectrum Reading Level + Factor

Margin=Actual FS- Limit

Report No.: TMWK2207002885KR

4.8.3 Test Setup

9kHz ~ 30MHz

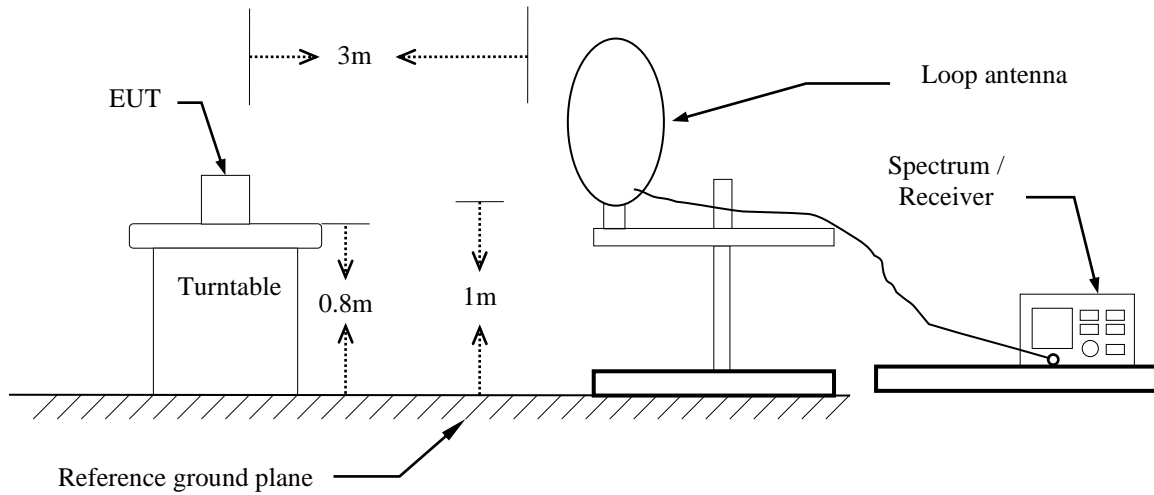

30MHz ~ 1GHz

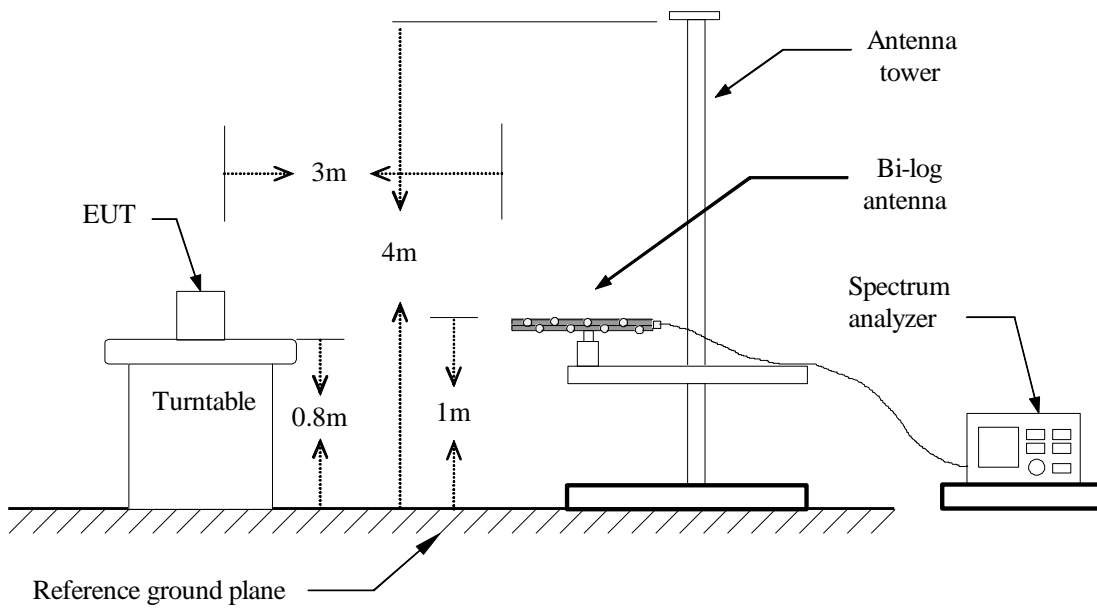

Above 1 GHz

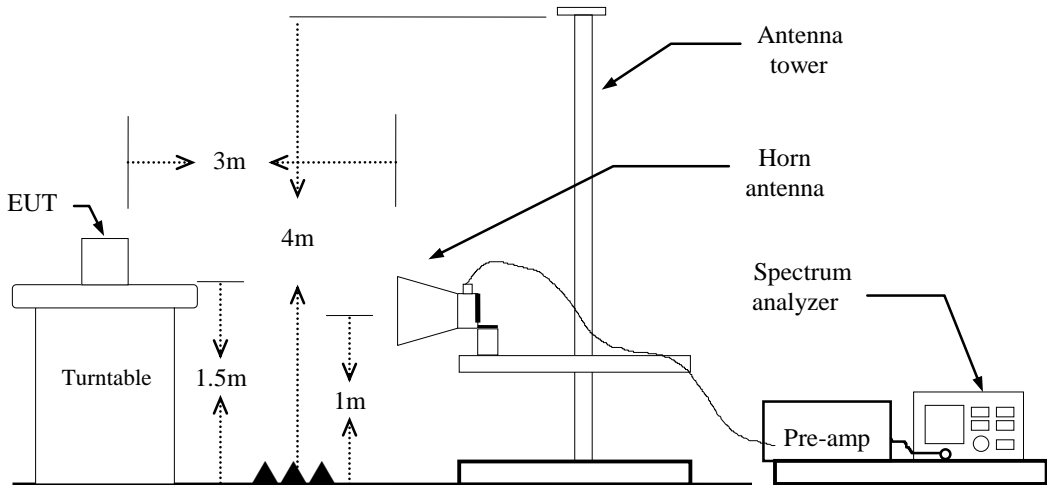

Report No.: TMWK2207002885KR

4.8.4 Test Result

Band Edge Test Data

Test Mode:	GFSK_BDR-1Mbps Low CH	Temp/Hum	24.4(°C)/ 62%RH
Test Item	Band Edge	Test Date	August 19, 2022
Polarize	Vertical	Test Engineer	Tony Chao
Detector	Peak / Average		

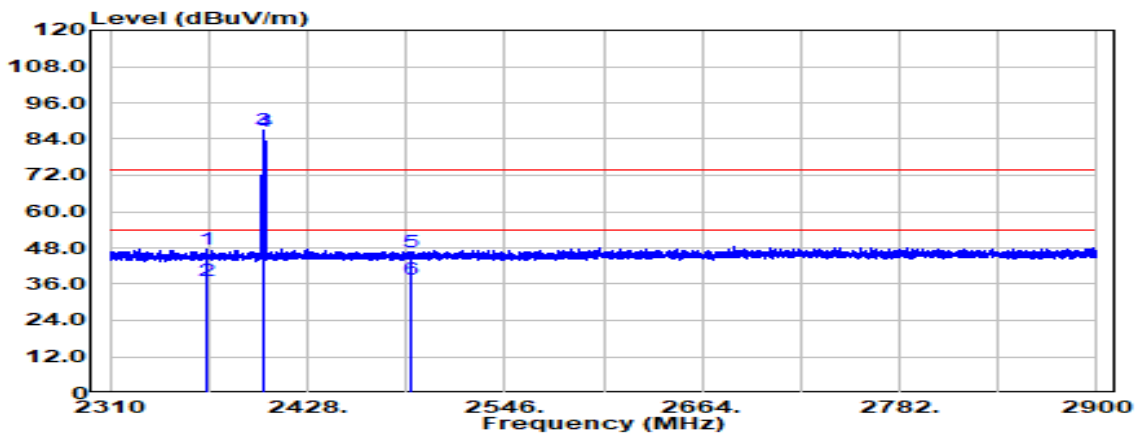

Freq. (MHz)	Detector Mode (PK/QP/AV)	Spectrum Reading Level (dBµV)	Factor (dB)	Actual FS (dBµV/m)	Limit @3m (dBµV/m)	Margin (dB)
2367.820	Peak	39.71	7.69	47.40	74.00	-26.60
2367.820	Average	29.59	7.69	37.28	54.00	-16.72
2402.000	Peak	79.02	7.79	86.81	--	--
2402.000	Average	78.80	7.79	86.60	--	--
2490.304	Peak	38.48	8.29	46.77	74.00	-27.23
2490.304	Average	29.34	8.29	37.63	54.00	-16.37

Report No.: TMWK2207002885KR

Test Mode:	GFSK_BDR-1Mbps Low CH	Temp/Hum	24.4(°C)/ 62%RH
Test Item	Band Edge	Test Date	August 19, 2022
Polarize	Horizontal	Test Engineer	Tony Chao
Detector	Peak / Average		

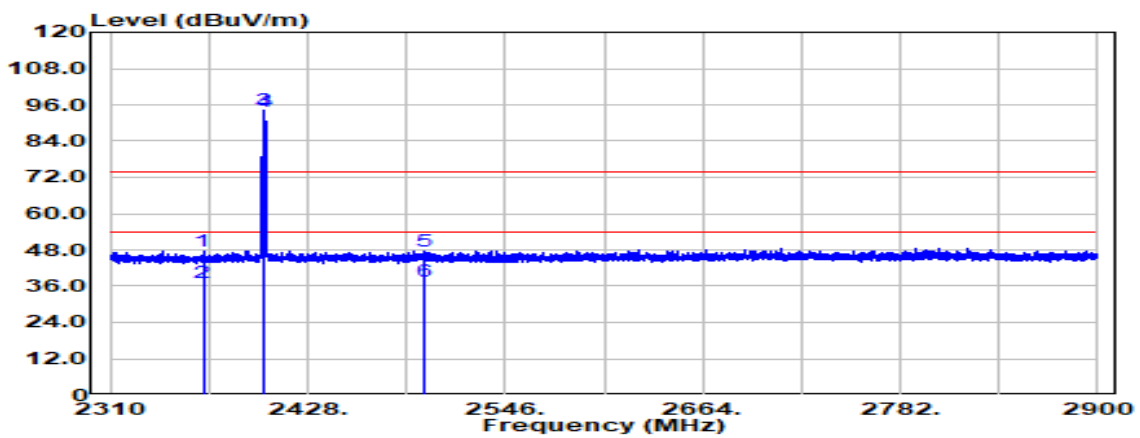

Freq. (MHz)	Detector Mode (PK/QP/AV)	Spectrum Reading Level (dBµV)	Factor (dB)	Actual FS (dBµV/m)	Limit @3m (dBµV/m)	Margin (dB)
2365.460	Peak	40.06	7.68	47.75	74.00	-26.25
2365.460	Average	29.53	7.68	37.21	54.00	-16.79
2402.000	Peak	86.33	7.79	94.13	--	--
2402.000	Average	86.11	7.79	93.90	--	--
2498.092	Peak	39.24	8.33	47.57	74.00	-26.43
2498.092	Average	29.12	8.33	37.46	54.00	-16.54

Report No.: TMWK2207002885KR

Test Mode:	GFSK_BDR-1Mbps High CH	Temp/Hum	24.4(°C)/ 62%RH
Test Item	Band Edge	Test Date	August 19, 2022
Polarize	Vertical	Test Engineer	Tony Chao
Detector	Peak / Average		

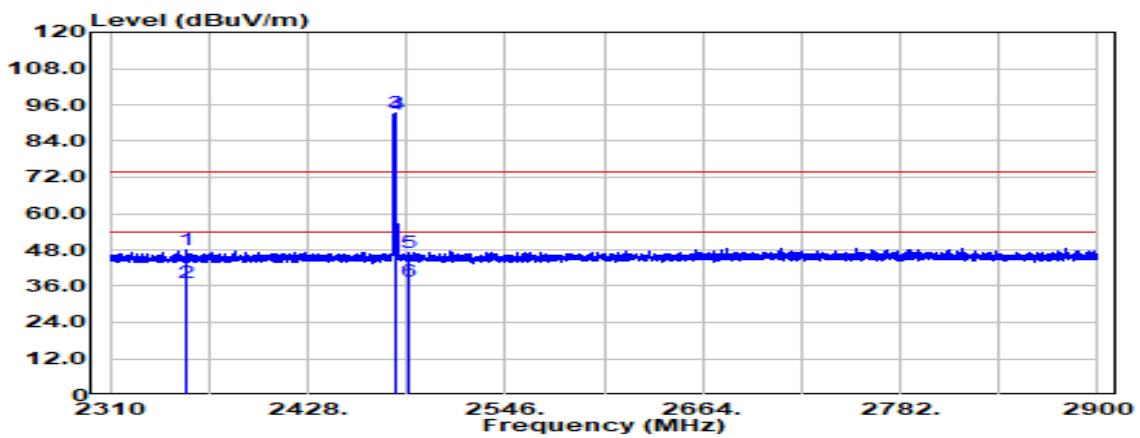

Freq. (MHz)	Detector Mode (PK/QP/AV)	Spectrum Reading Level (dBµV)	Factor (dB)	Actual FS (dBµV/m)	Limit @3m (dBµV/m)	Margin (dB)
2355.312	Peak	40.14	7.65	47.80	74.00	-26.20
2355.312	Average	29.69	7.65	37.35	54.00	-16.65
2480.000	Peak	84.95	8.24	93.20	--	--
2480.000	Average	84.72	8.24	92.97	--	--
2488.416	Peak	38.79	8.28	47.07	74.00	-26.93
2488.416	Average	29.19	8.28	37.48	54.00	-16.52

Report No.: TMWK2207002885KR

Test Mode:	GFSK_BDR-1Mbps High CH	Temp/Hum	24.4(°C)/ 62%RH
Test Item	Band Edge	Test Date	August 19, 2022
Polarize	Horizontal	Test Engineer	Tony Chao
Detector	Peak / Average		

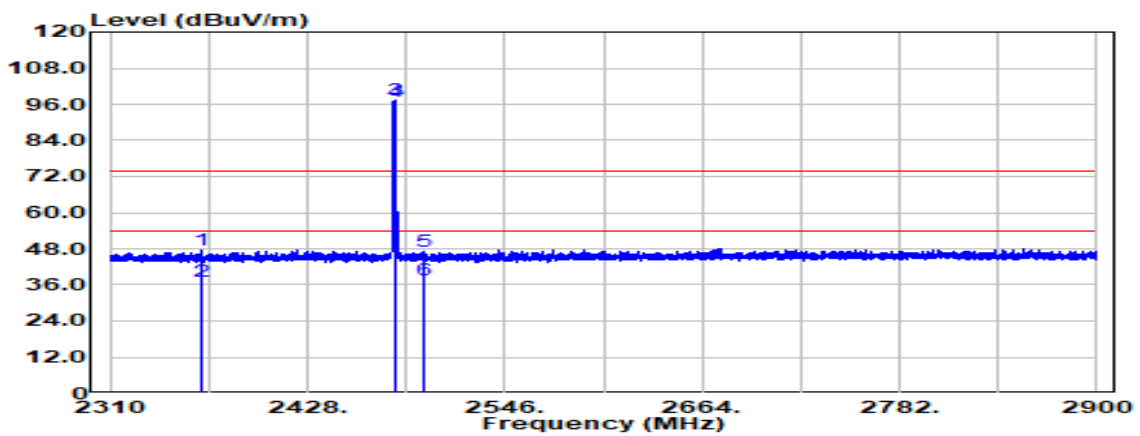

Freq. (MHz)	Detector Mode (PK/QP/AV)	Spectrum Reading Level (dBμV)	Factor (dB)	Actual FS (dBμV/m)	Limit @3m (dBμV/m)	Margin (dB)
2364.63	Peak	39.70	7.68	47.38	74.00	-26.62
2364.63	Average	29.46	7.68	37.14	54.00	-16.86
2480.00	Peak	89.01	8.24	97.25	--	--
2480.00	Average	88.80	8.24	97.04	--	--
2497.50	Peak	38.70	8.33	47.03	74.00	-26.97
2497.50	Average	29.11	8.33	37.44	54.00	-16.56

Report No.: TMWK2207002885KR

Test Mode:	GFSK_BDR-1Mbps Hopping	Temp/Hum	24.4(°C)/ 62%RH
Test Item	Band Edge	Test Date	August 19, 2022
Polarize	Vertical	Test Engineer	Tony Chao
Detector	Peak / Average		

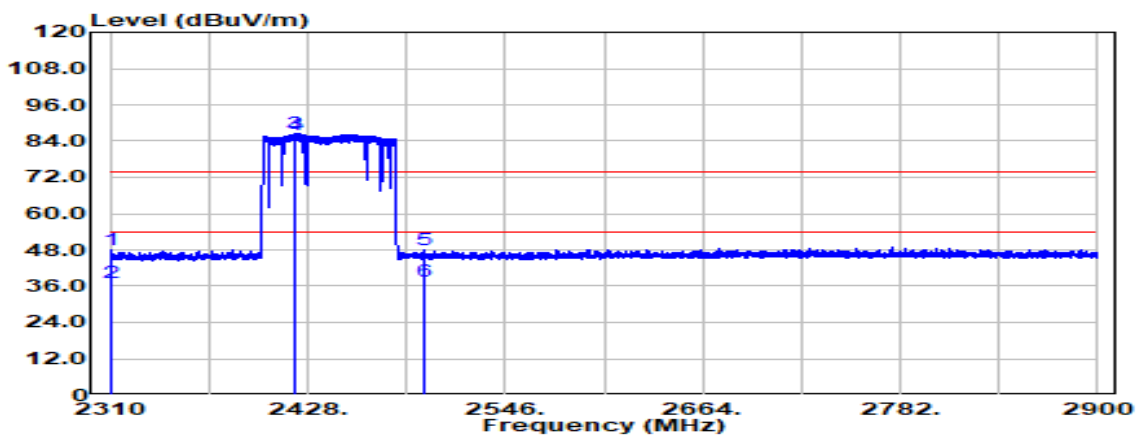

Freq. (MHz)	Detector Mode (PK/QP/AV)	Spectrum Reading Level (dBµV)	Factor (dB)	Actual FS (dBµV/m)	Limit @3m (dBµV/m)	Margin (dB)
2310.826	Peak	40.64	7.58	48.22	74.00	-25.78
2310.826	Average	29.73	7.58	37.31	54.00	-16.69
2421.038	Peak	78.50	7.91	86.41	--	--
2421.038	Average	77.99	7.91	85.90	--	--
2497.620	Peak	39.53	8.33	47.86	74.00	-26.14
2497.620	Average	29.08	8.33	37.41	54.00	-16.59

Report No.: TMWK2207002885KR

Test Mode:	GFSK_BDR-1Mbps Hopping	Temp/Hum	24.4(°C)/ 62%RH
Test Item	Band Edge	Test Date	August 19, 2022
Polarize	Horizontal	Test Engineer	Tony Chao
Detector	Peak / Average		

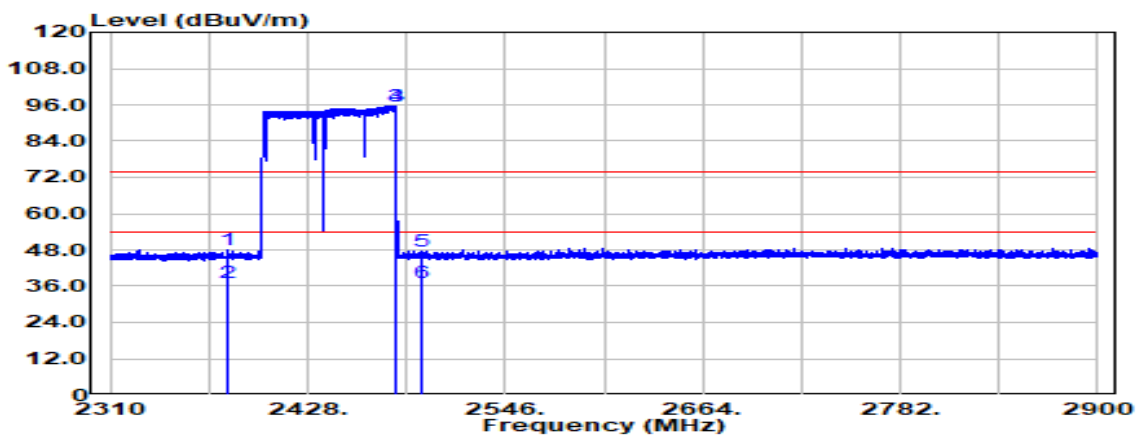

Freq. (MHz)	Detector Mode (PK/QP/AV)	Spectrum Reading Level (dBμV)	Factor (dB)	Actual FS (dBμV/m)	Limit @3m (dBμV/m)	Margin (dB)
2380.092	Peak	40.17	7.72	47.90	74.00	-26.10
2380.092	Average	29.56	7.72	37.28	54.00	-16.72
2480.038	Peak	87.52	8.24	95.77	--	--
2480.038	Average	87.28	8.24	95.53	--	--
2495.732	Peak	39.30	8.32	47.62	74.00	-26.38
2495.732	Average	28.98	8.32	37.30	54.00	-16.70

Report No.: TMWK2207002885KR

Test Mode:	8DPSK_EDR-3Mbps Low CH	Temp/Hum	24.4(°C)/ 62%RH
Test Item	Band Edge	Test Date	August 19, 2022
Polarize	Vertical	Test Engineer	Tony Chao
Detector	Peak / Average		

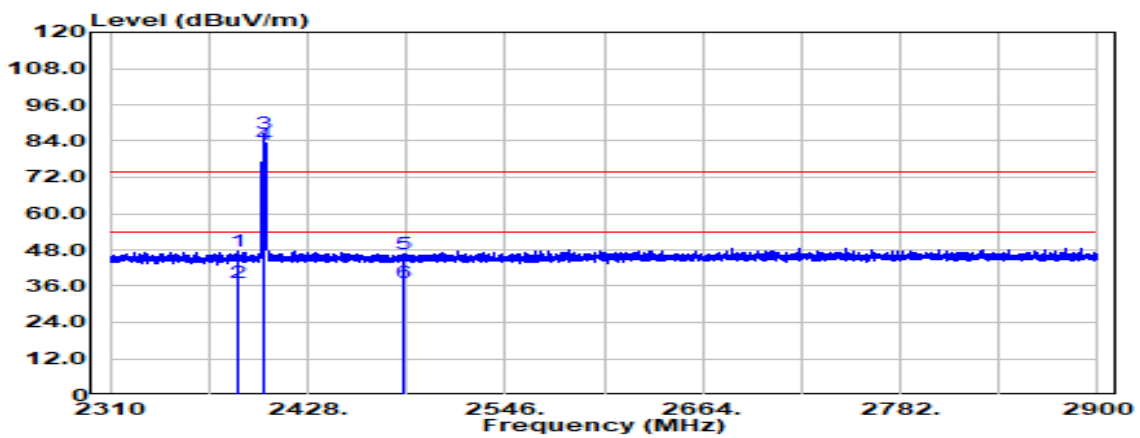

Freq. (MHz)	Detector Mode (PK/QP/AV)	Spectrum Reading Level (dBμV)	Factor (dB)	Actual FS (dBμV/m)	Limit @3m (dBμV/m)	Margin (dB)
2386.228	Peak	39.77	7.74	47.52	74.00	-26.48
2386.228	Average	29.54	7.74	37.28	54.00	-16.72
2402.000	Peak	78.79	7.79	86.58	--	--
2402.000	Average	75.19	7.79	82.98	--	--
2485.938	Peak	38.37	8.27	46.64	74.00	-27.36
2485.938	Average	29.06	8.27	37.33	54.00	-16.67

Report No.: TMWK2207002885KR

Test Mode:	8DPSK_EDR-3Mbps Low CH	Temp/Hum	24.4(°C)/ 62%RH
Test Item	Band Edge	Test Date	August 19, 2022
Polarize	Horizontal	Test Engineer	Tony Chao
Detector	Peak / Average		

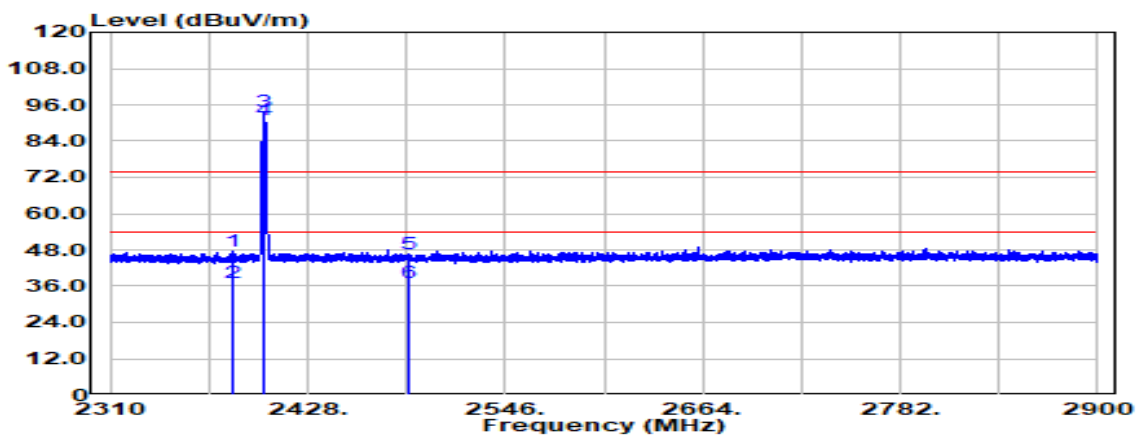

Freq. (MHz)	Detector Mode (PK/QP/AV)	Spectrum Reading Level (dBµV)	Factor (dB)	Actual FS (dBµV/m)	Limit @3m (dBµV/m)	Margin (dB)
2383.750	Peak	39.93	7.73	47.66	74.00	-26.34
2383.750	Average	29.46	7.73	37.20	54.00	-16.80
2402.000	Peak	85.75	7.79	93.54	--	--
2402.000	Average	83.35	7.79	91.14	--	--
2488.534	Peak	38.29	8.28	46.57	74.00	-27.43
2488.534	Average	28.93	8.28	37.22	54.00	-16.78

Report No.: TMWK2207002885KR

Test Mode:	8DPSK_EDR-3Mbps High CH	Temp/Hum	24.4(°C)/ 62%RH
Test Item	Band Edge	Test Date	August 19, 2022
Polarize	Vertical	Test Engineer	Tony Chao
Detector	Peak / Average		

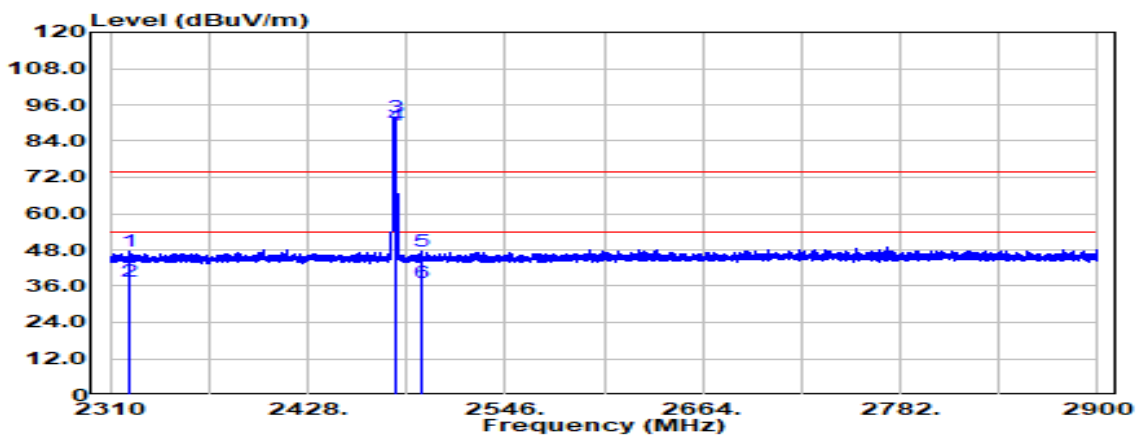

Freq. (MHz)	Detector Mode (PK/QP/AV)	Spectrum Reading Level (dBµV)	Factor (dB)	Actual FS (dBµV/m)	Limit @3m (dBµV/m)	Margin (dB)
2320.738	Peak	39.86	7.59	47.45	74.00	-26.55
2320.738	Average	29.78	7.59	37.37	54.00	-16.63
2480.000	Peak	83.61	8.24	91.86	--	--
2480.000	Average	80.74	8.24	88.99	--	--
2495.732	Peak	39.30	8.32	47.62	74.00	-26.38
2495.732	Average	29.03	8.32	37.34	54.00	-16.66

Report No.: TMWK2207002885KR

Test Mode:	8DPSK_EDR-3Mbps High CH	Temp/Hum	24.4(°C)/ 62%RH
Test Item	Band Edge	Test Date	August 19, 2022
Polarize	Horizontal	Test Engineer	Tony Chao
Detector	Peak / Average		

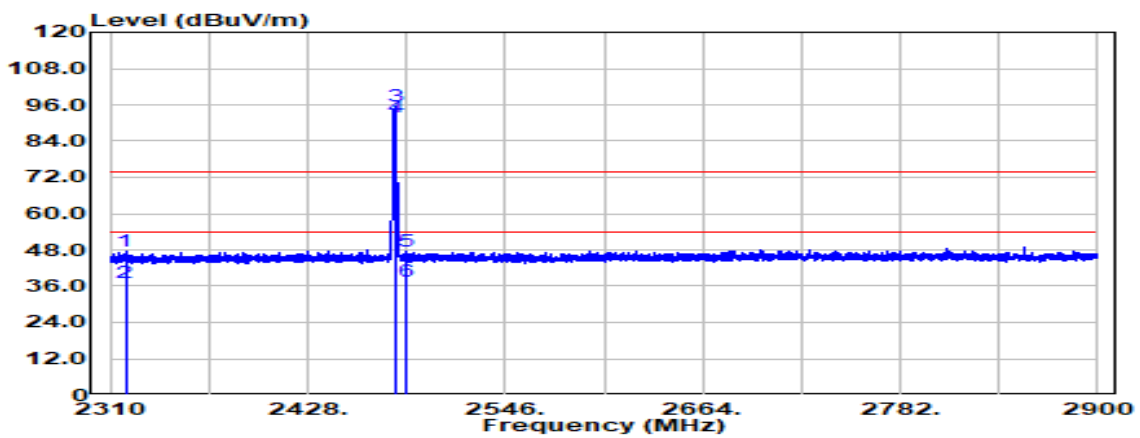

Freq. (MHz)	Detector Mode (PK/QP/AV)	Spectrum Reading Level (dBµV)	Factor (dB)	Actual FS (dBµV/m)	Limit @3m (dBµV/m)	Margin (dB)
2319.086	Peak	39.93	7.59	47.52	74.00	-26.48
2319.086	Average	29.57	7.59	37.16	54.00	-16.84
2480.000	Peak	87.45	8.24	95.69	--	--
2480.000	Average	83.61	8.24	91.85	--	--
2486.764	Peak	39.23	8.28	47.50	74.00	-26.50
2486.764	Average	29.12	8.28	37.40	54.00	-16.60

Report No.: TMWK2207002885KR

Test Mode:	8DPSK_EDR-3Mbps Hopping	Temp/Hum	24.4(°C)/ 62%RH
Test Item	Band Edge	Test Date	August 19, 2022
Polarize	Vertical	Test Engineer	Tony Chao
Detector	Peak / Average		

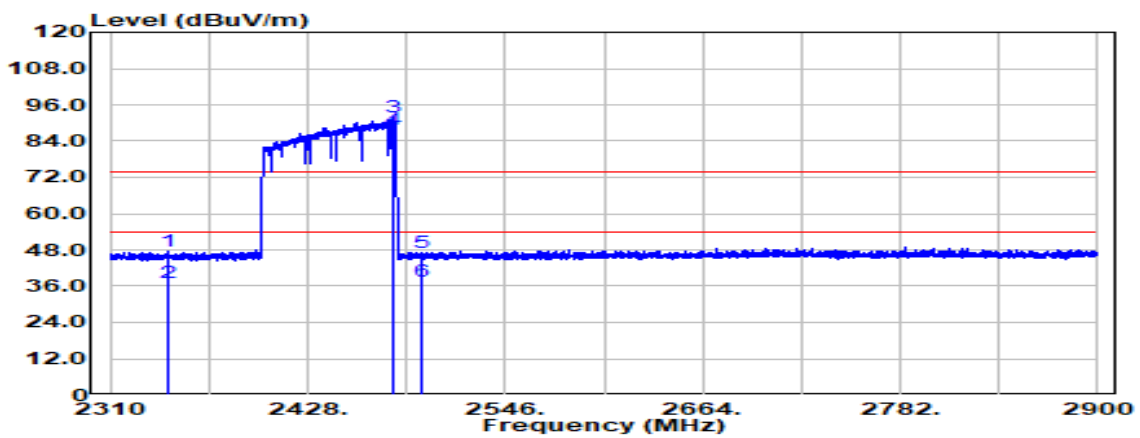

Freq. (MHz)	Detector Mode (PK/QP/AV)	Spectrum Reading Level (dBµV)	Factor (dB)	Actual FS (dBµV/m)	Limit @3m (dBµV/m)	Margin (dB)
2344.102	Peak	39.82	7.63	47.45	74.00	-26.55
2344.102	Average	29.70	7.63	37.33	54.00	-16.67
2479.094	Peak	83.62	8.24	91.86	--	--
2479.094	Average	79.78	8.24	88.02	--	--
2495.378	Peak	38.87	8.32	47.19	74.00	-26.81
2495.378	Average	29.07	8.32	37.39	54.00	-16.61

Report No.: TMWK2207002885KR

Test Mode:	8DPSK_EDR-3Mbps Hopping	Temp/Hum	24.4(°C)/ 62%RH
Test Item	Band Edge	Test Date	August 19, 2022
Polarize	Horizontal	Test Engineer	Tony Chao
Detector	Peak / Average		

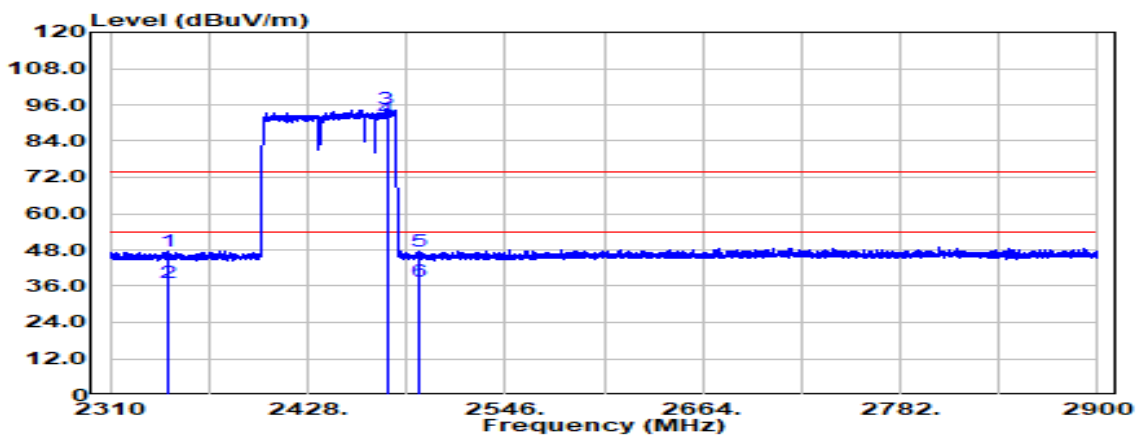

Freq. (MHz)	Detector Mode (PK/QP/AV)	Spectrum Reading Level (dBμV)	Factor (dB)	Actual FS (dBμV/m)	Limit @3m (dBμV/m)	Margin (dB)
2345.164	Peak	40.07	7.63	47.70	74.00	-26.30
2345.164	Average	29.66	7.63	37.29	54.00	-16.71
2475.200	Peak	86.63	8.22	94.86	--	--
2475.200	Average	83.14	8.22	91.36	--	--
2494.316	Peak	39.37	8.31	47.69	74.00	-26.31
2494.316	Average	29.19	8.31	37.50	54.00	-16.50

Report No.: TMWK2207002885KR

Below 1G Test Data

Test Mode:	GFSK_BDR-1Mbps Low CH	Temp/Hum	24.4(°C)/ 64%RH
Test Item	30MHz-1GHz	Test Date	August 22, 2022
Polarize	Vertical	Test Engineer	Ray Li
Detector	Peak		

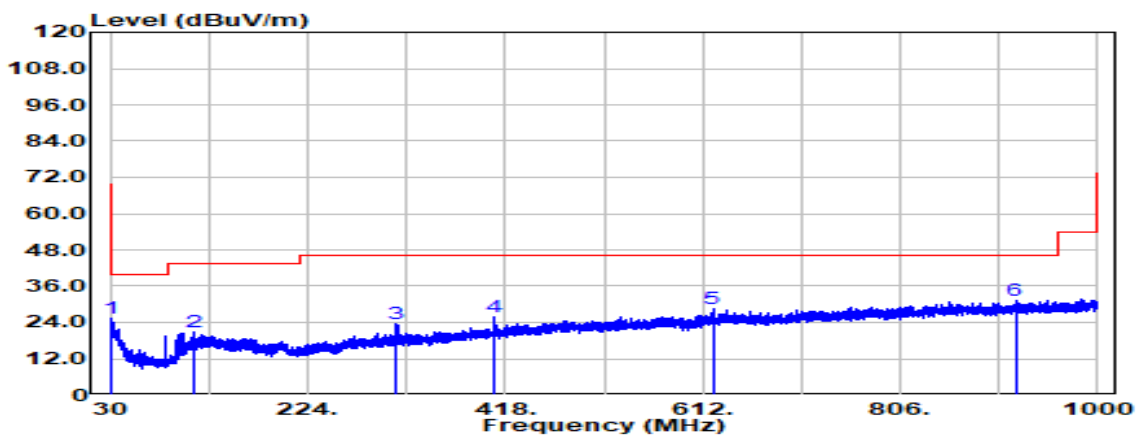

Freq. (MHz)	Detector Mode (PK/QP/AV)	Spectrum Reading Level (dBμV)	Factor (dB)	Actual FS (dBμV/m)	Limit @3m (dBμV/m)	Margin (dB)
30.970	Peak	29.16	-3.90	25.26	40.00	-14.74
112.571	Peak	30.82	-10.14	20.68	43.50	-22.82
310.936	Peak	31.94	-8.60	23.34	46.00	-22.66
407.209	Peak	31.59	-5.73	25.85	46.00	-20.15
621.821	Peak	30.26	-1.55	28.71	46.00	-17.29
919.126	Peak	28.43	2.83	31.25	46.00	-14.75

Test Mode:	GFSK_BDR-1Mbps Low CH	Temp/Hum	24.4(°C)/ 64%RH
Test Item	30MHz-1GHz	Test Date	August 22, 2022
Polarize	Horizontal	Test Engineer	Ray Li
Detector	Peak		

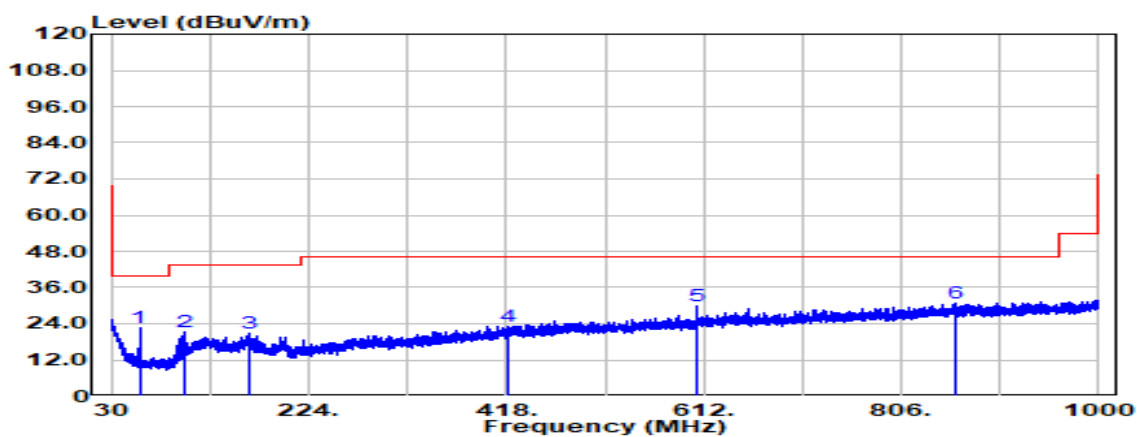

Freq. (MHz)	Detector Mode (PK/QP/AV)	Spectrum Reading Level (dBμV)	Factor (dB)	Actual FS (dBμV/m)	Limit @3m (dBμV/m)	Margin (dB)
57.645	Peak	38.88	-16.46	22.42	40.00	-17.58
101.780	Peak	33.97	-12.47	21.50	43.50	-22.00
165.558	Peak	31.72	-11.02	20.71	43.50	-22.79
418.728	Peak	28.56	-5.41	23.15	46.00	-22.85
606.059	Peak	32.33	-2.30	30.03	46.00	-15.97
858.623	Peak	28.88	2.04	30.92	46.00	-15.08

Report No.: TMWK2207002885KR

Above 1G Test Data

Test Mode:	GFSK_BDR-1Mbps Low CH	Temp/Hum	24.4(°C)/ 62%RH
Test Item	Harmonic	Test Date	August 19, 2022
Polarize	Vertical	Test Engineer	Ray Li
Detector	Peak / Average		

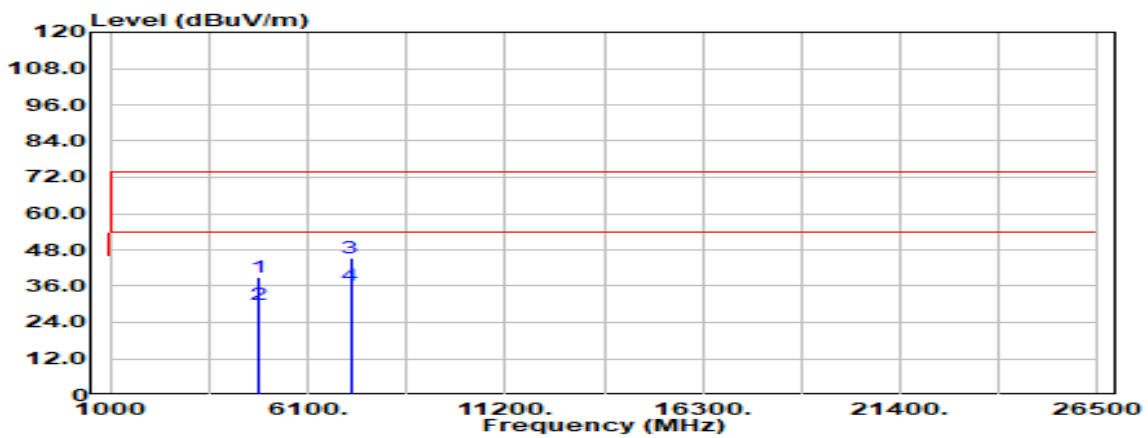

Freq. (MHz)	Detector Mode (PK/QP/AV)	Spectrum Reading Level (dBµV)	Factor (dB)	Actual FS (dBµV/m)	Limit @3m (dBµV/m)	Margin (dB)
4804.000	Peak	33.04	5.87	38.90	74.00	-35.10
4804.000	Average	24.12	5.87	29.99	54.00	-24.01
7206.000	Peak	31.85	13.25	45.10	74.00	-28.90
7206.000	Average	23.19	13.25	36.44	54.00	-17.56
N/A						

Remark:

1. Measuring frequencies from 1 GHz to the 10th harmonic of highest fundamental frequency.

Report No.: TMWK2207002885KR

Test Mode:	GFSK_BDR-1Mbps Low CH	Temp/Hum	24.4(°C)/ 62%RH
Test Item	Harmonic	Test Date	August 19, 2022
Polarize	Horizontal	Test Engineer	Ray Li
Detector	Peak / Average		

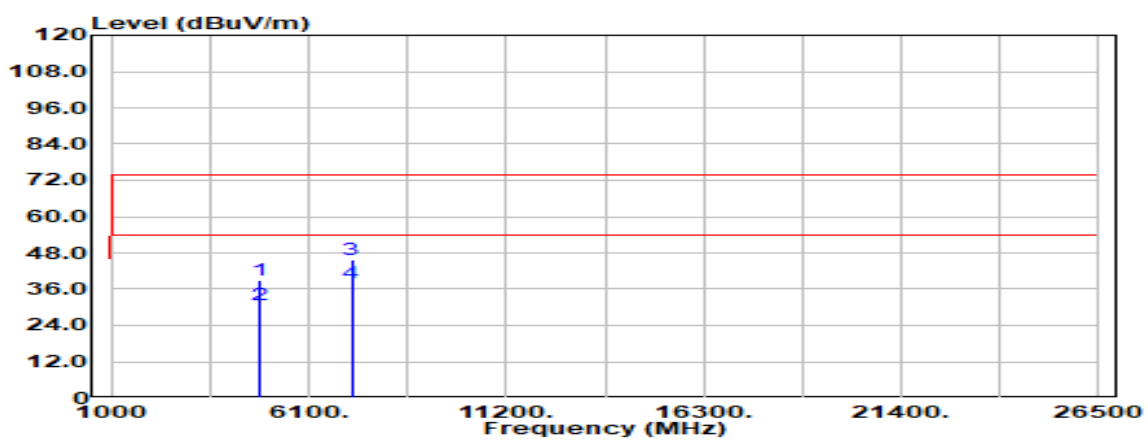

Freq. (MHz)	Detector Mode (PK/QP/AV)	Spectrum Reading Level (dBμV)	Factor (dB)	Actual FS (dBμV/m)	Limit @3m (dBμV/m)	Margin (dB)
4804.000	Peak	33.21	5.87	39.07	74.00	-34.93
4804.000	Average	25.05	5.87	30.91	54.00	-23.09
7206.000	Peak	32.33	13.25	45.59	74.00	-28.41
7206.000	Average	24.69	13.25	37.94	54.00	-16.06
N/A						

Remark:

1. Measuring frequencies from 1 GHz to the 10th harmonic of highest fundamental frequency.

Report No.: TMWK2207002885KR

Test Mode:	GFSK_BDR-1Mbps Mid CH	Temp/Hum	24.4(°C)/ 62%RH
Test Item	Harmonic	Test Date	August 19, 2022
Polarize	Vertical	Test Engineer	Ray Li
Detector	Peak / Average		

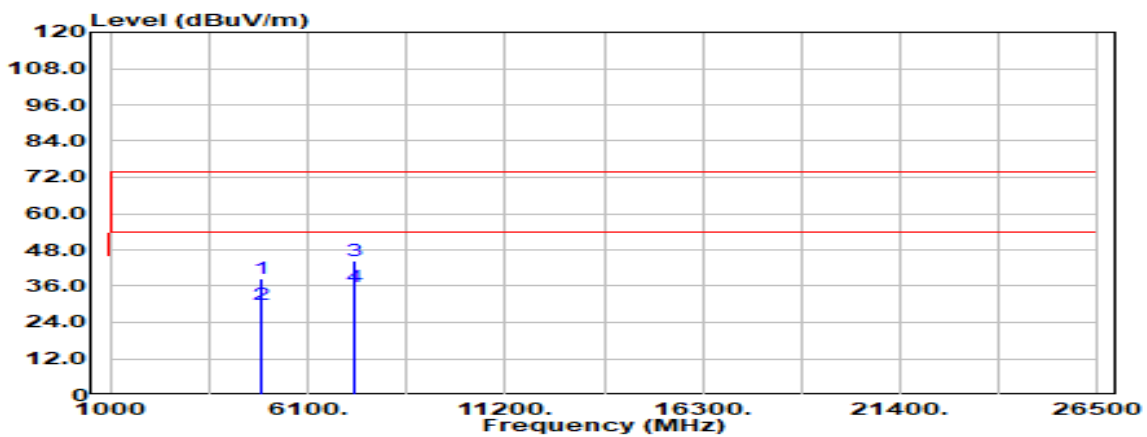

Freq. (MHz)	Detector Mode (PK/QP/AV)	Spectrum Reading Level (dBμV)	Factor (dB)	Actual FS (dBμV/m)	Limit @3m (dBμV/m)	Margin (dB)
4882.000	Peak	32.53	6.14	38.67	74.00	-35.33
4882.000	Average	23.95	6.14	30.09	54.00	-23.91
7323.000	Peak	31.23	13.36	44.59	74.00	-29.41
7323.000	Average	22.64	13.36	35.99	54.00	-18.01
N/A						

Remark:

1. Measuring frequencies from 1 GHz to the 10th harmonic of highest fundamental frequency.

Report No.: TMWK2207002885KR

Test Mode:	GFSK_BDR-1Mbps Mid CH	Temp/Hum	24.4(°C)/ 62%RH
Test Item	Harmonic	Test Date	August 19, 2022
Polarize	Horizontal	Test Engineer	Ray Li
Detector	Peak / Average		

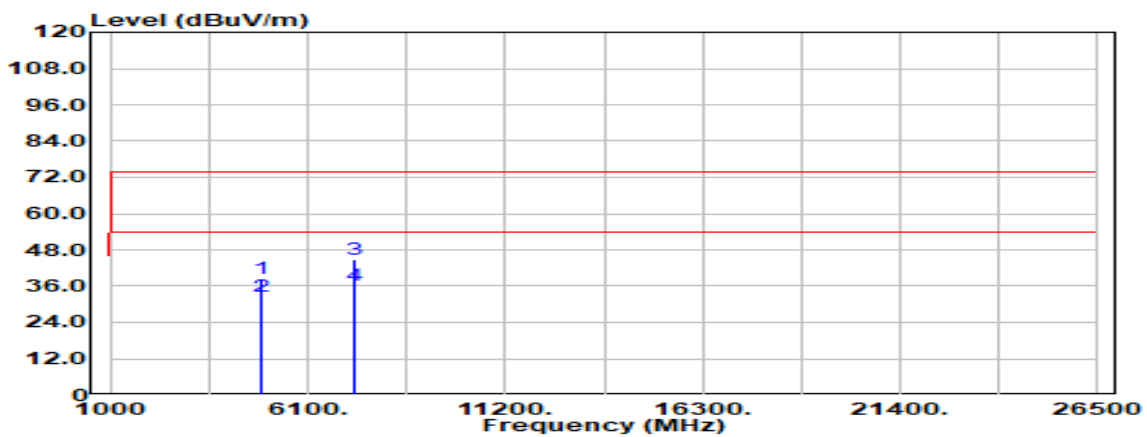

Freq. (MHz)	Detector Mode (PK/QP/AV)	Spectrum Reading Level (dBμV)	Factor (dB)	Actual FS (dBμV/m)	Limit @3m (dBμV/m)	Margin (dB)
4882.000	Peak	32.27	6.14	38.41	74.00	-35.59
4882.000	Average	26.28	6.14	32.42	54.00	-21.58
7323.000	Peak	31.50	13.36	44.85	74.00	-29.15
7323.000	Average	22.96	13.36	36.31	54.00	-17.69
N/A						

Remark:

- Measuring frequencies from 1 GHz to the 10th harmonic of highest fundamental frequency.

Report No.: TMWK2207002885KR

Test Mode:	GFSK_BDR-1Mbps High CH	Temp/Hum	24.4(°C)/ 62%RH
Test Item	Harmonic	Test Date	August 19, 2022
Polarize	Vertical	Test Engineer	Ray Li
Detector	Peak / Average		

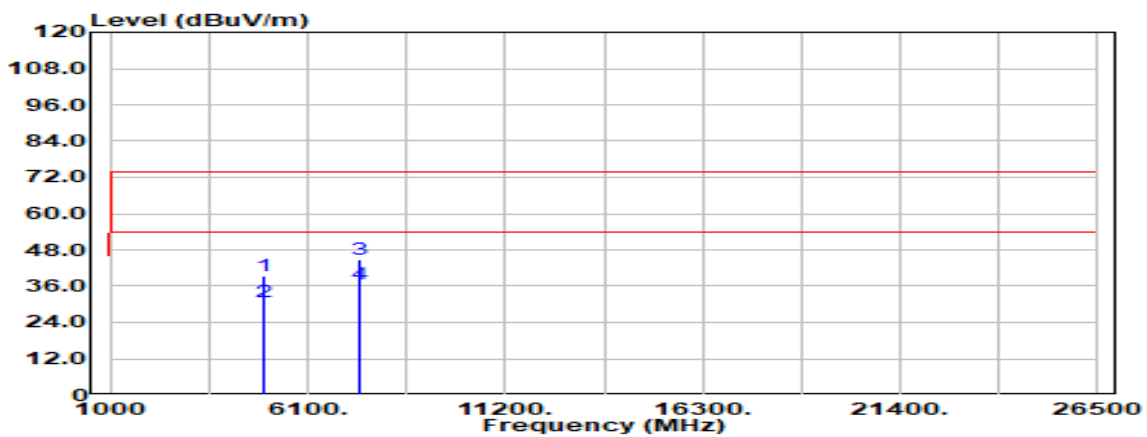

Freq. (MHz)	Detector Mode (PK/QP/AV)	Spectrum Reading Level (dBμV)	Factor (dB)	Actual FS (dBμV/m)	Limit @3m (dBμV/m)	Margin (dB)
4960.000	Peak	32.32	6.91	39.24	74.00	-34.76
4960.000	Average	23.74	6.91	30.65	54.00	-23.35
7440.000	Peak	31.78	13.22	45.00	74.00	-29.00
7440.000	Average	23.29	13.22	36.51	54.00	-17.49
N/A						

Remark:

- Measuring frequencies from 1 GHz to the 10th harmonic of highest fundamental frequency.

Report No.: TMWK2207002885KR

Test Mode:	GFSK_BDR-1Mbps High CH	Temp/Hum	24.4(°C)/ 62%RH
Test Item	Harmonic	Test Date	August 19, 2022
Polarize	Horizontal	Test Engineer	Ray Li
Detector	Peak / Average		

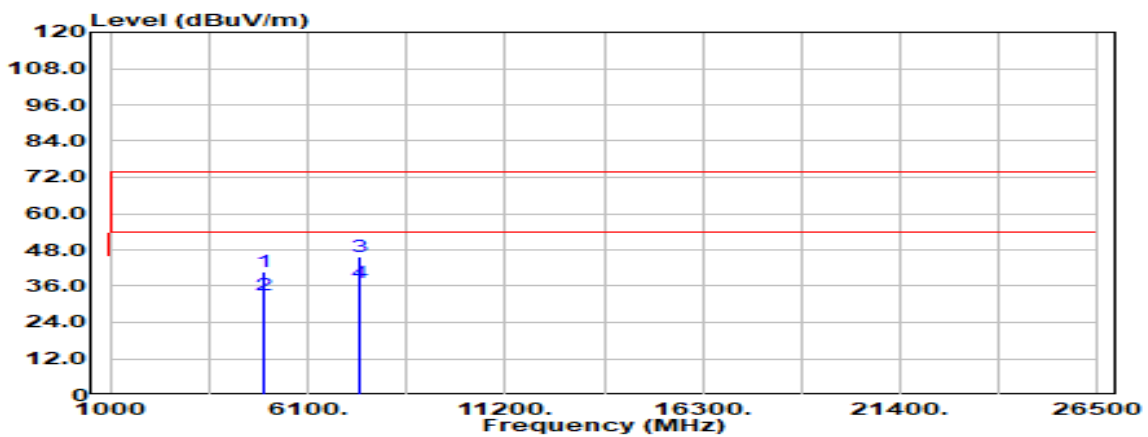

Freq. (MHz)	Detector Mode (PK/QP/AV)	Spectrum Reading Level (dBµV)	Factor (dB)	Actual FS (dBµV/m)	Limit @3m (dBµV/m)	Margin (dB)
4960.000	Peak	33.80	6.91	40.72	74.00	-33.28
4960.000	Average	26.21	6.91	33.12	54.00	-20.88
7440.000	Peak	32.50	13.22	45.72	74.00	-28.28
7440.000	Average	24.09	13.22	37.31	54.00	-16.69
N/A						

Remark:

- Measuring frequencies from 1 GHz to the 10th harmonic of highest fundamental frequency.

Report No.: TMWK2207002885KR

Test Mode:	8DPSK_EDR-3Mbps Low CH	Temp/Hum	24.4(°C)/ 62%RH
Test Item	Harmonic	Test Date	August 19, 2022
Polarize	Vertical	Test Engineer	Ray Li
Detector	Peak / Average		

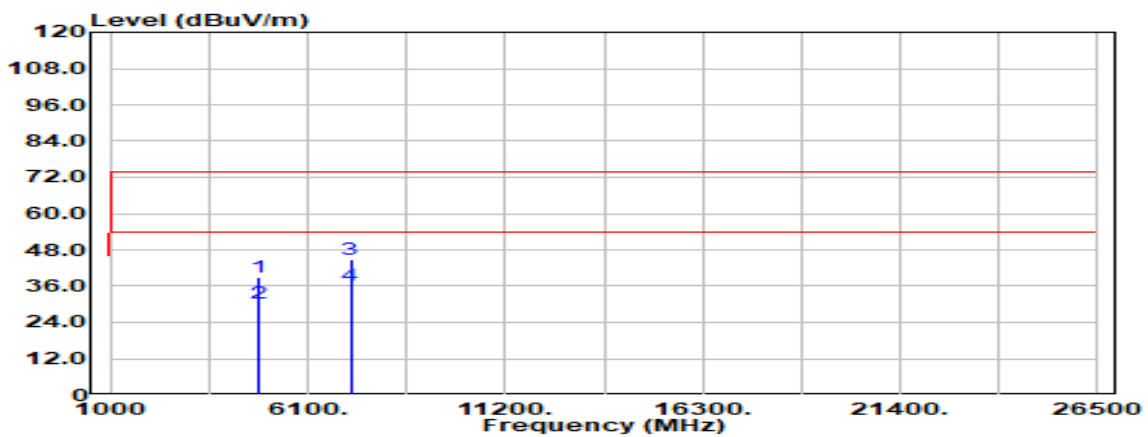

Freq. (MHz)	Detector Mode (PK/QP/AV)	Spectrum Reading Level (dBμV)	Factor (dB)	Actual FS (dBμV/m)	Limit @3m (dBμV/m)	Margin (dB)
4804.000	Peak	33.04	5.87	38.90	74.00	-35.10
4804.000	Average	24.29	5.87	30.16	54.00	-23.84
7206.000	Peak	31.76	13.25	45.01	74.00	-28.99
7206.000	Average	22.97	13.25	36.22	54.00	-17.78
N/A						

Remark:

- Measuring frequencies from 1 GHz to the 10th harmonic of highest fundamental frequency.

Report No.: TMWK2207002885KR

Test Mode:	8DPSK_EDR-3Mbps Low CH	Temp/Hum	24.4(°C)/ 62%RH
Test Item	Harmonic	Test Date	August 19, 2022
Polarize	Horizontal	Test Engineer	Ray Li
Detector	Peak / Average		

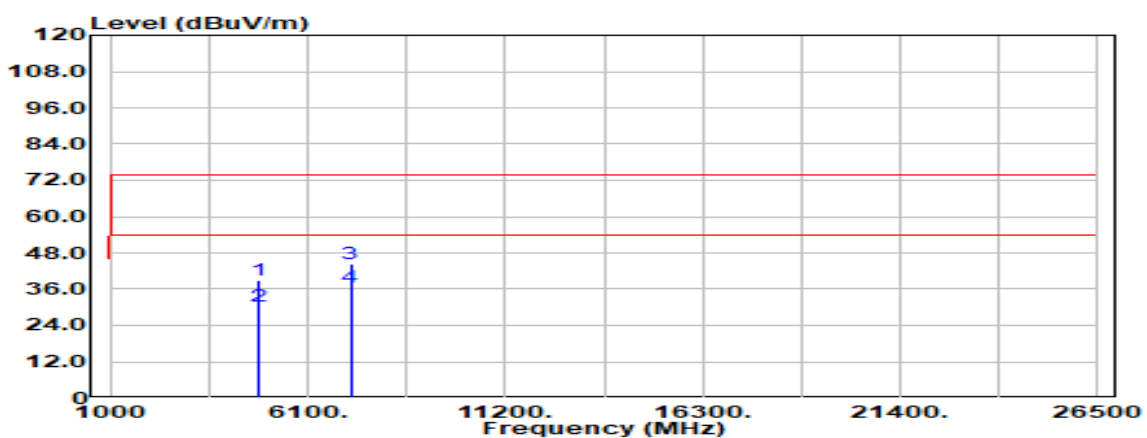

Freq. (MHz)	Detector Mode (PK/QP/AV)	Spectrum Reading Level (dBμV)	Factor (dB)	Actual FS (dBμV/m)	Limit @3m (dBμV/m)	Margin (dB)
4804.000	Peak	32.90	5.87	38.77	74.00	-35.23
4804.000	Average	24.27	5.87	30.14	54.00	-23.86
7206.000	Peak	31.30	13.25	44.55	74.00	-29.45
7206.000	Average	23.46	13.25	36.71	54.00	-17.29
N/A						

Remark:

- Measuring frequencies from 1 GHz to the 10th harmonic of highest fundamental frequency.

Report No.: TMWK2207002885KR

Test Mode:	8DPSK_EDR-3Mbps Mid CH	Temp/Hum	24.4(°C)/ 62%RH
Test Item	Harmonic	Test Date	August 19, 2022
Polarize	Vertical	Test Engineer	Ray Li
Detector	Peak / Average		

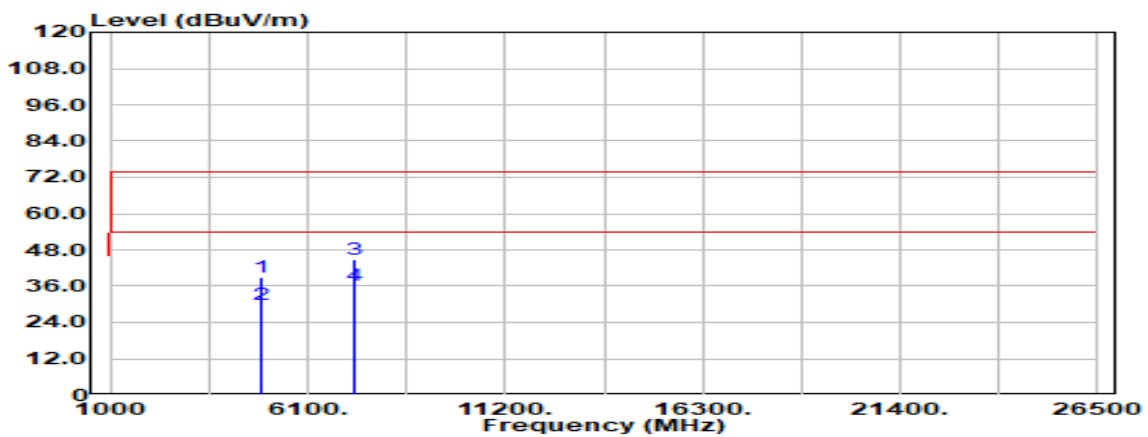

Freq. (MHz)	Detector Mode (PK/QP/AV)	Spectrum Reading Level (dBμV)	Factor (dB)	Actual FS (dBμV/m)	Limit @3m (dBμV/m)	Margin (dB)
4882.000	Peak	32.67	6.14	38.81	74.00	-35.19
4882.000	Average	23.85	6.14	29.99	54.00	-24.01
7323.000	Peak	31.50	13.36	44.85	74.00	-29.15
7323.000	Average	22.79	13.36	36.14	54.00	-17.86
N/A						

Remark:

1. Measuring frequencies from 1 GHz to the 10th harmonic of highest fundamental frequency.

Report No.: TMWK2207002885KR

Test Mode:	8DPSK_EDR-3Mbps Mid CH	Temp/Hum	24.4(°C)/ 62%RH
Test Item	Harmonic	Test Date	August 19, 2022
Polarize	Horizontal	Test Engineer	Ray Li
Detector	Peak / Average		

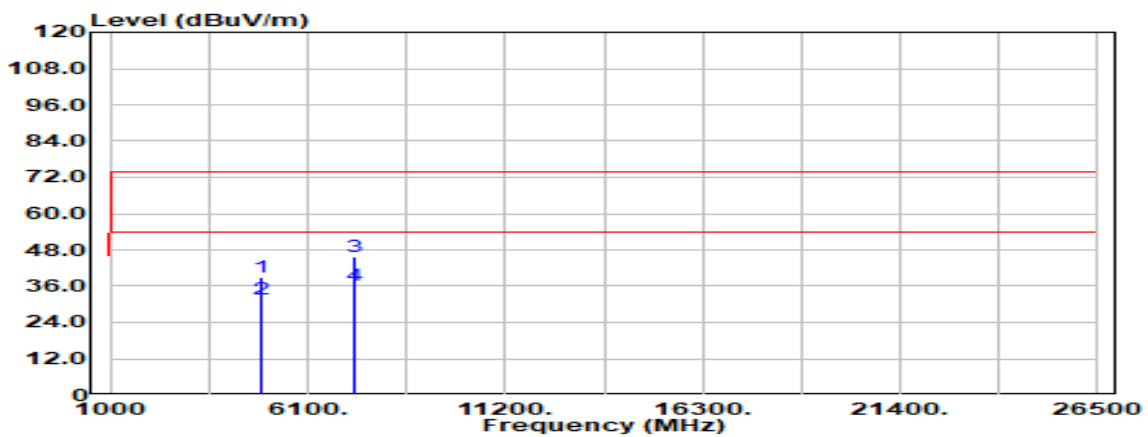

Freq. (MHz)	Detector Mode (PK/QP/AV)	Spectrum Reading Level (dBμV)	Factor (dB)	Actual FS (dBμV/m)	Limit @3m (dBμV/m)	Margin (dB)
4882.000	Peak	32.83	6.14	38.97	74.00	-35.03
4882.000	Average	25.33	6.14	31.47	54.00	-22.53
7323.000	Peak	32.29	13.36	45.65	74.00	-28.35
7323.000	Average	22.76	13.36	36.12	54.00	-17.88
N/A						

Remark:

- Measuring frequencies from 1 GHz to the 10th harmonic of highest fundamental frequency.

Report No.: TMWK2207002885KR

Test Mode:	8DPSK_EDR-3Mbps High CH	Temp/Hum	24.4(°C)/ 62%RH
Test Item	Harmonic	Test Date	August 19, 2022
Polarize	Vertical	Test Engineer	Ray Li
Detector	Peak / Average		

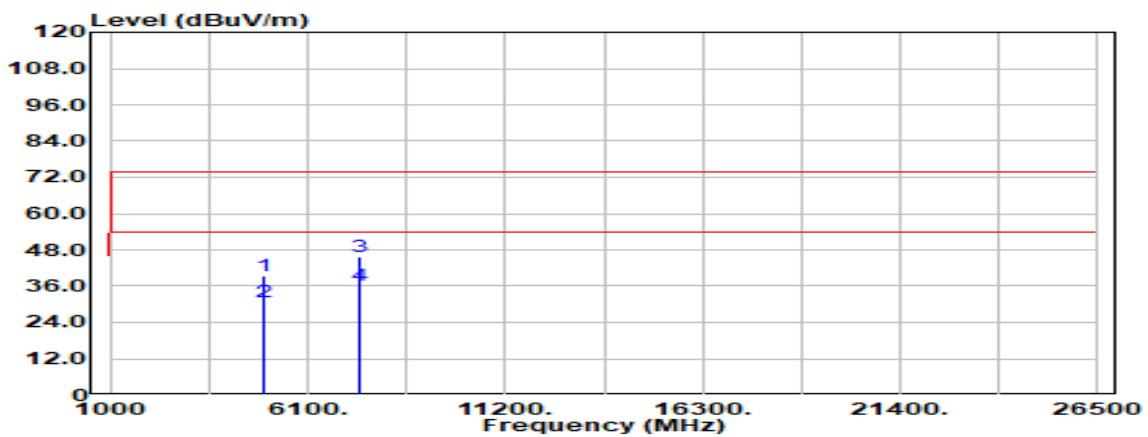

Freq. (MHz)	Detector Mode (PK/QP/AV)	Spectrum Reading Level (dBμV)	Factor (dB)	Actual FS (dBμV/m)	Limit @3m (dBμV/m)	Margin (dB)
4960.000	Peak	32.35	6.91	39.26	74.00	-34.74
4960.000	Average	23.83	6.91	30.74	54.00	-23.26
7440.000	Peak	32.56	13.22	45.78	74.00	-28.22
7440.000	Average	23.15	13.22	36.37	54.00	-17.63
N/A						

Remark:

- Measuring frequencies from 1 GHz to the 10th harmonic of highest fundamental frequency.

Report No.: TMWK2207002885KR

Test Mode:	8DPSK_EDR-3Mbps High CH	Temp/Hum	24.4(°C)/ 62%RH
Test Item	Harmonic	Test Date	August 19, 2022
Polarize	Horizontal	Test Engineer	Ray Li
Detector	Peak / Average		

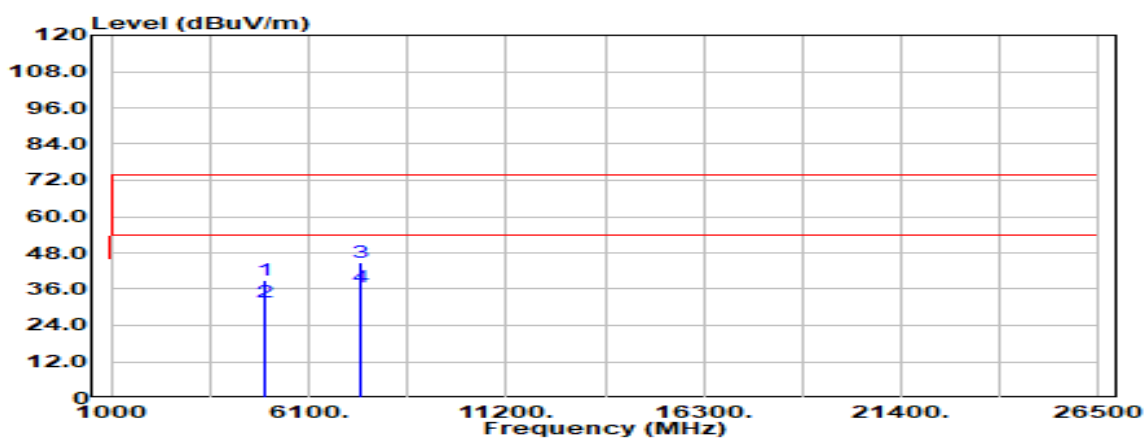

Freq. (MHz)	Detector Mode (PK/QP/AV)	Spectrum Reading Level (dBμV)	Factor (dB)	Actual FS (dBμV/m)	Limit @3m (dBμV/m)	Margin (dB)
4960.000	Peak	31.85	6.91	38.76	74.00	-35.24
4960.000	Average	24.60	6.91	31.51	54.00	-22.49
7440.000	Peak	31.77	13.22	44.99	74.00	-29.01
7440.000	Average	23.47	13.22	36.69	54.00	-17.31
N/A						

Remark:

1. Measuring frequencies from 1 GHz to the 10th harmonic of highest fundamental frequency.

- End of Test Report -