

USER MANUAL

Gateway and Node

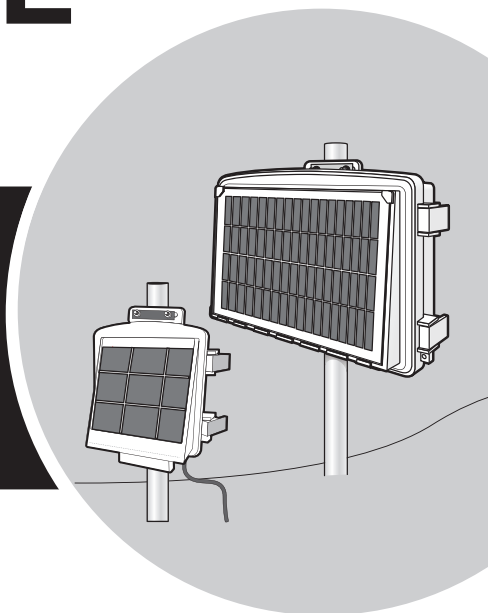

ENVIROMONITOR[®]

Product numbers 6803 and 6810

DAVIS  [®]

Davis Instruments, 3465 Diablo Avenue, Hayward, CA 94545-2778 U.S.A. • 510-732-9229 • www.davisinstruments.com



FCC Part 15 Class B Registration Warning

This equipment has been tested and found to comply with the limits for a Class B digital device, pursuant to Part 15 of the FCC Rules. These limits are designed to provide reasonable protection against harmful interference in a residential installation. This equipment generates, uses, and can radiate radio frequency energy and, if not installed and used in accordance with the instructions, may cause harmful interference to radio communications. However, there is no guarantee that interference will not occur in a particular installation.

This device complies with part 15 of the FCC Rules. Operation is subject to the following two conditions: (1) this device may not cause harmful interference, and (2) this device must accept any interference, including interference received, including inference that may cause undesired operation.

This device complies with Industry Canada license-exempt RSS standard(s). Operation is subject to the following two conditions: (1) this device may not cause interference, and (2) this device must accept any interference, including interference that may cause undesired operation of the device.

Le présent appareil est conforme aux CNR d'Industrie Canada applicables aux appareils radio exempts de licence. L'exploitation est autorisée aux deux conditions suivantes: (1) l'appareil ne doit pas produire de brouillage, et (2) l'appareil doit accepter tout brouillage radioélectrique subi, même si le brouillage est susceptible d'en compromettre le fonctionnement.

The antenna used for this transmitter must be installed to provide a separation distance of at least 20 cm from all persons and must not be co-located or operating in conjunction with any other antenna or transmitter.

If this equipment does cause harmful interference to radio or television reception, which can be determined by turning the equipment on and off, the user is encouraged to try to correct the interference by one or more of the following measures:

- Reorient or relocate the receiving antenna.
- Increase the separation between the equipment and receiver.
- Connect the equipment into an outlet on a circuit different from that to which the receiver is connected.
- Consult the dealer or an experienced radio/TV technician for help.

Changes or modification not expressly approved in writing by Davis Instruments may void the warranty and void the user's authority to operate this equipment.

This radio transmitter 3788A-6803 has been approved by Innovation, Science and Economic Development Canada to operate with the antenna types listed below, with the maximum permissible gain indicated. Antenna types not included in this list that have a gain greater than the maximum gain indicated for any type listed are strictly prohibited for use with this device. The following antennas are permissible to use with this product:

7678 8dBi 50 Ohms

7676 5dBi 50 Ohms

FCC ID: IR2DWW6803, IR2DWW6810

IC: 3788A-6803, 3788A-6810

Contains FCCID: XMR201906EG21G

Contains IC: 10224A-201906EG21G

EC-Declaration of Conformity Directive 2014/53/EU (RED Directive)

Manufacturer/responsible person: Davis Instruments
Compliance Engineer
3465 Diablo Ave., Hayward, CA 94545 USA

Hereby declares that the products:
6803 and 6810

Comply with Directive 2014/53/EU. The full text of the EU Declaration of Conformity is on our website at <https://www.davisinstruments.com/legal>

Power Output: see page 25: **Specifications**

The technical documentation relevant to the above equipment will be held at:
Davis Instruments at 3465 Diablo Ave, Hayward CA 94545

Welcome to Your EnviroMonitor System

An EnviroMonitor System includes a Gateway and a number of Nodes, each with up to four sensors that form an advanced mesh network operating at 902 - 928 MHz (868 MHz in the EU). The Nodes transmit the sensor data to a “mesh parent,” either the Gateway or another Node. The Gateway then sends the data via cellular connection to WeatherLink.com.

EnviroMonitor can be customized for different sized installations. Each Gateway can receive 20 or more Nodes. Additional Gateways can be added to your account to receive data from another set of Nodes.

A Davis cabled GroWeather Sensor Suite can also be plugged into the Gateway.

This manual will show you how to set up both the EnviroMonitor Gateway and Nodes. If you are just installing a Node and have already installed the Gateway, you can skip to page 12: **Set Up Nodes and Sensors**.

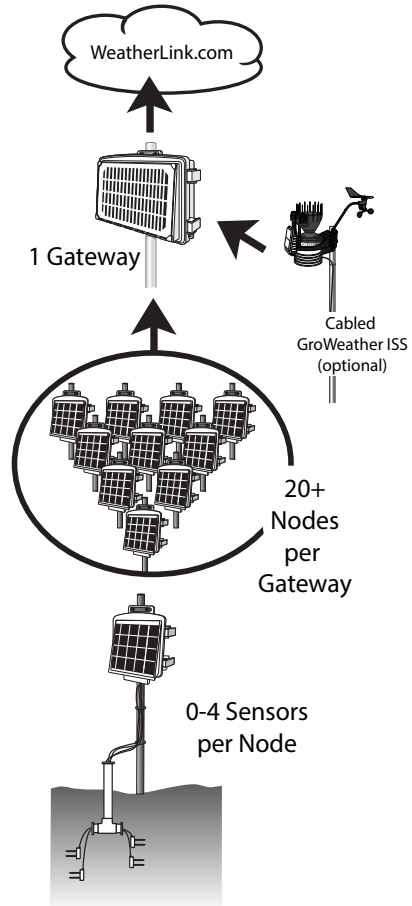

The steps for setting up your EnviroMonitor system:

1. **Plan:** What sensors do you need and where? Decide where you will install the Gateway and Nodes. *See page 2: Planning Your System.*
2. **Power up** your Gateway. *See page 7: Power-up and Connect your Gateway.*
3. **Connect** your Gateway to WeatherLink.com with the EnviroMonitor app.
4. **Mount** the Gateway. *See page 9: Mount the Gateway.*
5. **Power up** the Node. *See page 13: Power-up and Connect the Node.*
6. **Connect** the Node to the Gateway with the EnviroMonitor app.
7. **Mount** the Node. *See page 16: Mount the Node.*
8. **Add and Install** the sensors with the EnviroMonitor app.

Planning Your System

After determining which sensors you want and where you want to install them, make sure you have the correct number of Nodes to support those sensors.

The maximum distance between two Nodes and a Gateway and a Node will vary depending on many factors including environment, height, terrain, and RF noise.

To get optimal transmission range:

- Ideally, locate the devices with unobstructed lines of sight between them. A large hill or large metal barrier will block signals. If transmitting under a canopy or in an orchard, range will be reduced.
- **Mount the devices as high above the ground or the highest crop height as possible.** The higher they are mounted, the longer the transmission distance.
- Try to mount the Gateway on a rooftop or pole so that it has a good “view” of the area where the Nodes will be mounted.

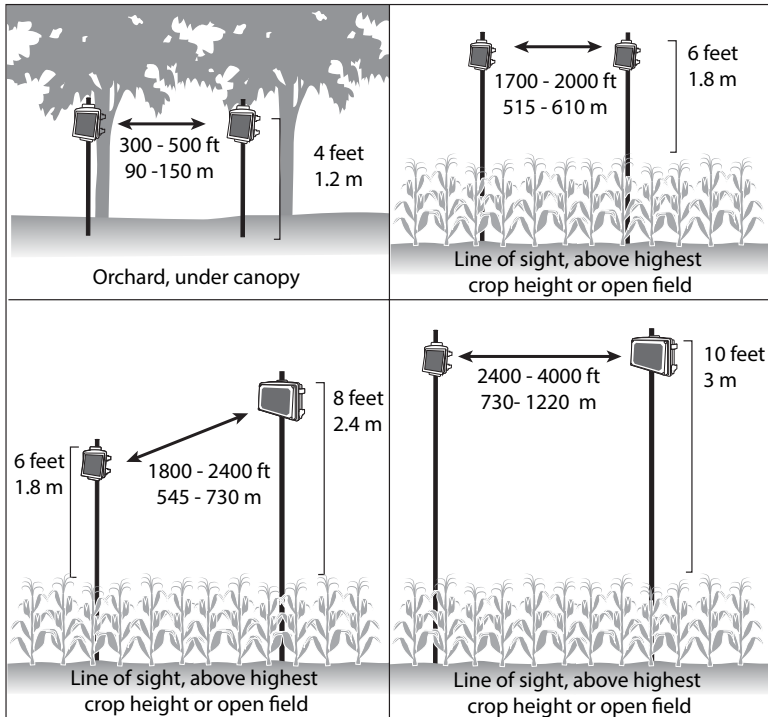

Note: This illustration shows how installation height affects general transmission distances under ideal conditions. Many variables affect transmission distance. Results will vary based on environmental conditions. For longer transmission distance, add a Long Range Antenna to the Gateway and/or Nodes. See page 22: **Appendix A: Adding a Long Range Antenna.**

Make a Sketch

It is helpful to make a sketch of your installation to get an idea of where the Gateway and Nodes should go.

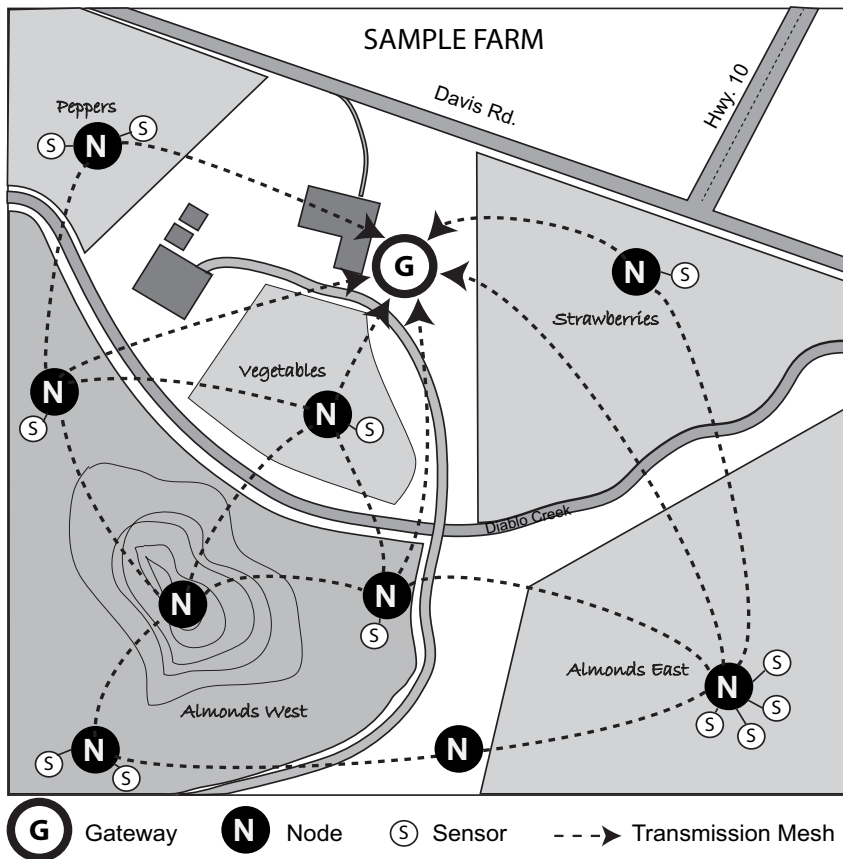

Tips for Siting the Gateway and Nodes

Siting the Gateway

- The Gateway should be mounted where it has the strongest cellular connection and a clear, open “view” of the sky with good sunlight for the solar panel.



- You may add a cabled or wireless Vantage Pro2 sensor suite, such as GroWeather to your Gateway. If you use a cabled sensor suite, you will need to choose a location that is within reach of the sensor suite’s included 100’/30 m (extendable up to 1,000’/300m) cable. See page 11: **Add a Vantage Pro2 Sensor Suite (optional)**.

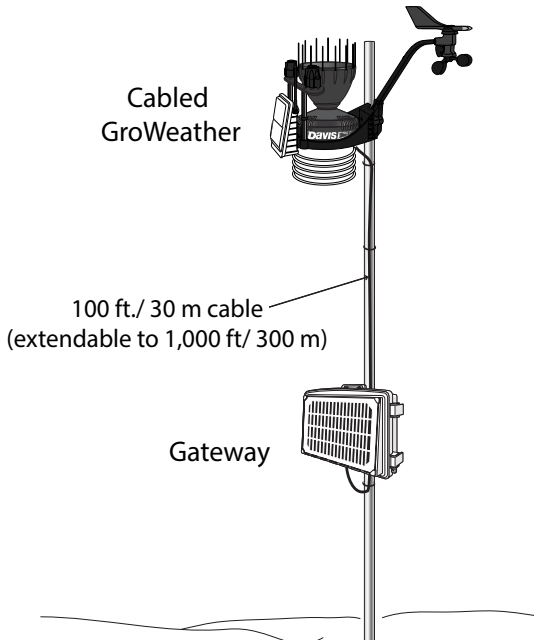

Note: The radio in the Gateway is not compatible with the radio in wireless Vantage Pro2 stations.

Siting the Nodes

- Ideally, the mesh network will be most effective at “self healing” any temporarily impaired transmission paths if each Node has more than one way to reach the Gateway. While the system is designed to handle a mesh, a “star” or nodes in single lines, it is a good idea whenever possible to site each node so that it is within transmission distance of either two (or more) other Nodes, or the Gateway and another Node. A Node can even be installed simply to transmit data from more distant Nodes to the Gateway, without any sensors installed in it. By planning the system’s “transmission mesh,” data can be relayed in from the most remote corner of your installation.

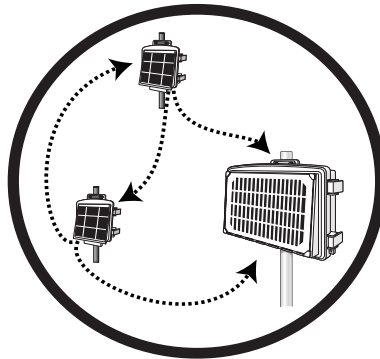

The best installations allow Nodes to transmit to more than one Node or to a Node or Nodes and the Gateway.

- Nodes can also be used to transmit data around or over obstacles, such as hills.

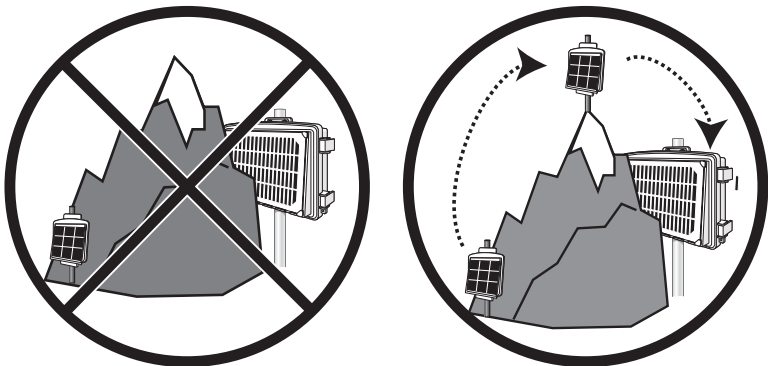

Get around an obstruction by using a Node with no sensors as a relay.

Set up your Gateway

Contents of Gateway

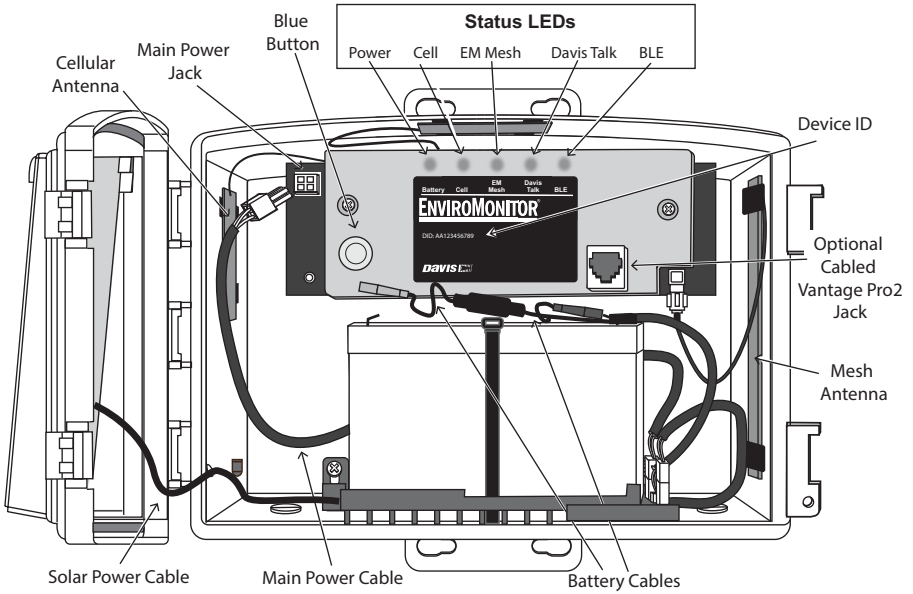

Hardware kit

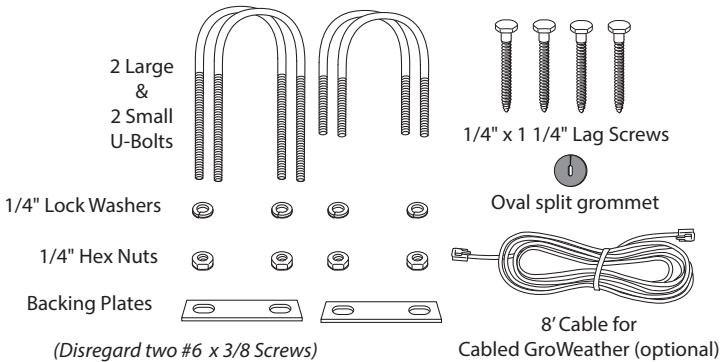

Gateway Requirements & Tools

- 2G, 3G or LTE coverage in the area where the Gateway will be installed
- Smartphone
- Mounting pole or post
- Wrench
- Power drill if using lag screws

Power-up and Connect your Gateway

Install the EnviroMonitor App

1. Install the EnviroMonitor app on your Smartphone. Find the app by searching for the Davis EnviroMonitor app in the iOS App Store or Google Play Store.



EnviroMonitor App

The EnviroMonitor app will guide you through creating an account on WeatherLink.com, adding the Gateway, adding Nodes to the Gateway, and adding sensors to the Node.

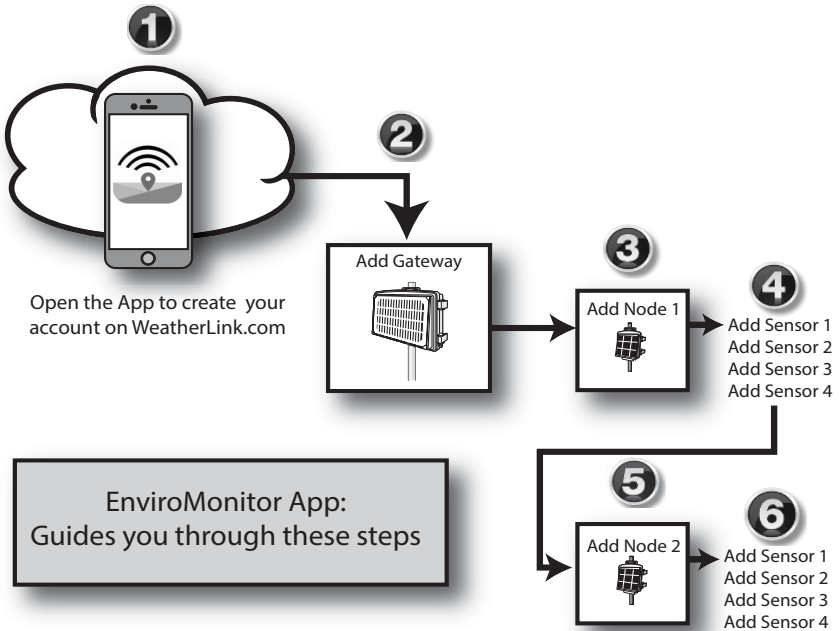

Power up your Gateway

1. Remove all cardboard and packing materials from inside the Gateway.
2. Connect the battery.
The Gateway is shipped with one battery cable (the red, or positive cable) disconnected to prevent battery drain. Connect the red cable to the red terminal.

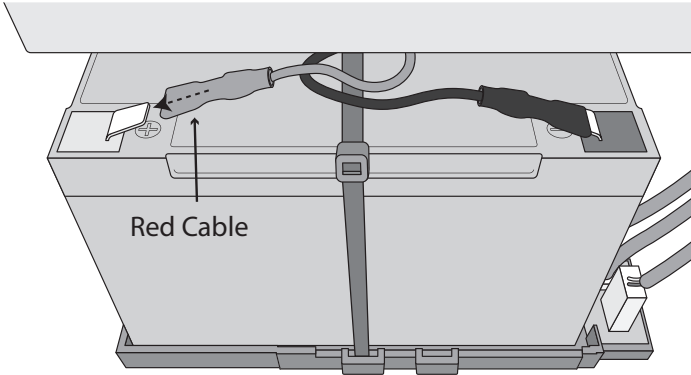

IMPORTANT: If putting your Gateway into storage, disconnect the red cable.

3. Plug the main power cable into the jack.

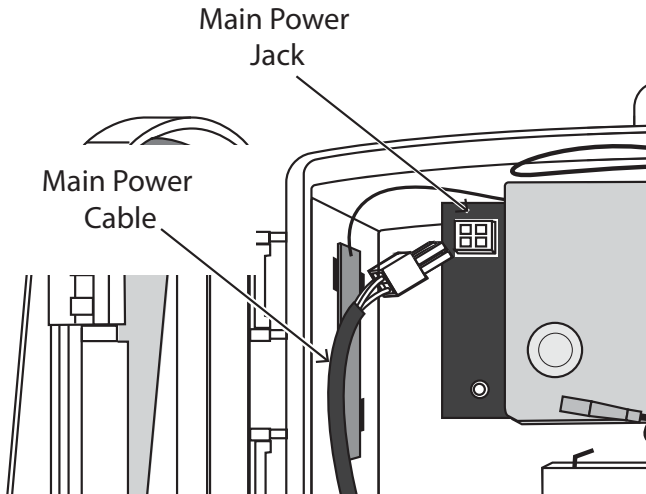

Connect the Gateway to WeatherLink.com

1. Make sure the Bluetooth (BLE) function on your smartphone is on.
2. Open the app and choose **Sign Up** to create an account, or **Log in** if you have already created an account
3. Tap **Add Gateway**.
4. Bring the phone close to the Gateway.
5. If a message appears that an upgrade has been detected, select **Upgrade**. Upgrading can take several minutes.

Tip: The LED flashes to show that the Gateway's BLE is on. If it is not flashing, press the blue button. See the illustration on page 6: **Contents of Gateway** for the location of the button.

6. The LED will turn solid blue when the Gateway has successfully connected to your smartphone.
7. Once connected, enter a name for this Gateway. Choose a name based on the use or location so you can easily identify this Gateway if you install others.
8. Follow the prompts to finish adding the Gateway.
9. Once done, you will be prompted to add a Node. Before adding a Node, however, you should mount the Gateway.

Mount the Gateway

Confirm Cellular Strength

The best way to determine cellular connection is to take the Gateway to your proposed location and use the EnviroMonitor app to see the signal strength.

In the app, choose this Gateway. Open the Menu icon  in the upper right corner. Choose **Connection**.

- If the app shows cell connection, but the RSSI is less than 4, the cellular signal is present but weak. It may be strong enough to work, but it would better to find a location with a stronger signal: 10 or higher is preferable. If there are large trees or buildings nearby, they may be obstructing the signal between the Gateway and cell tower. Try changing the location to avoid the obstruction. If your selected location is in a low spot, try moving to a higher location.

Tip: If the app shows no cellular signal at the chosen location, try a second choice location. Remember to choose **Refresh** in the app and wait a few minutes to see the strength at the new location.

Tip: Mounting the Gateway may be easier if done by two people.

The Gateway can be mounted on a pole or a flat surface such as a wall or post.

It is important that the Gateway be mounted so that the solar panel gets the greatest amount of sunshine: the solar panel should be facing south (in the Northern Hemisphere) or north (in the Southern Hemisphere).

Tip: While south is generally appropriate for the Northern Hemisphere (and north in the Southern Hemisphere), your goal is to maximize direct sunlight on the solar panel. If your location does not have a full sunrise-to-sunset exposure arc when the panel faces south, you should face your solar panel toward a point midway in the existing arc to maximize panel charging.

Mounting on a Flat Surface

Attach the Gateway to the mounting surface in the desired location using the lag screws and backing plates as shown below. Use a pencil or a center-punch to mark the location of the pilot hole.

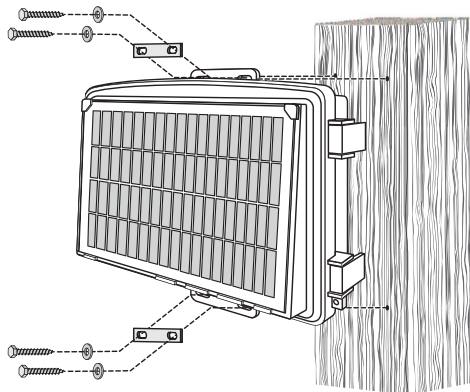

Mounting On a Pole

Mount the Gateway onto a pole with the U-bolts, backing plates, washers, and hex nuts provided.

Note: Use the smaller U-bolts on a pole with an outside diameter of 0.84" to 1.84" (21 mm to 47 mm). For mounting on square perforated tubing or larger diameter poles up to 1.94" (49 mm) outside diameter, use the larger U-bolts.

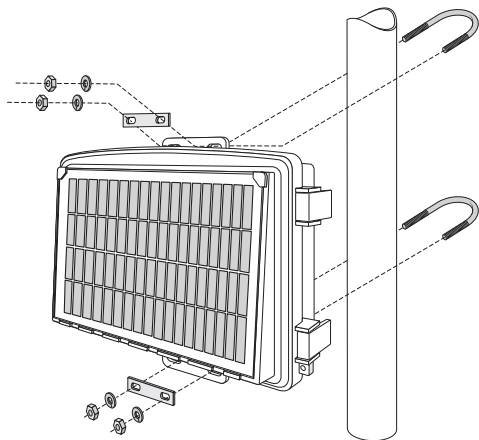

Add a Vantage Pro2 Sensor Suite (optional)

Add a cabled or wireless Vantage Pro2 integrated sensor suite, such as GroWeather (product number 6820/6820C), to your system, to get rain, wind, temperature, humidity, and solar radiation data to the Gateway.

Connect a Wireless Sensor Suite

Connect a wireless station by following the prompts in the EnviroMonitor app, the same way you connect Nodes to the Gateway.

Connect a Cabled Sensor Suite

1. Open the Gateway door.
2. Remove the plug from one of the holes in the bottom of the Gateway and run the sensor suite cable up through it.
3. Outside the shelter, wrap a split grommet with an oval hole (included in hardware kit) around the cable and push the grommet securely into the hole. Plug the cable into the sensor suite cable jack. Close the door.
4. Secure the sensor suite cable to the post or pole with the included zip ties. Do not use staples to secure the cable.

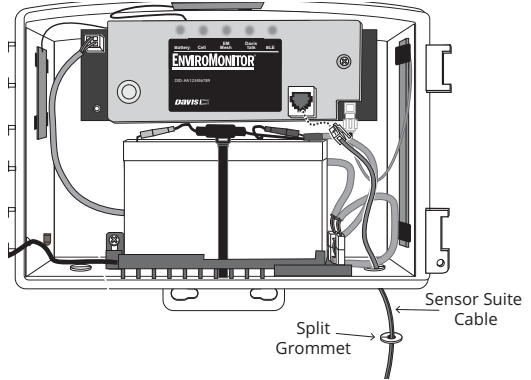

Note: If you are mounting the Gateway and the sensor suite together, you may find that the 100'/30m cable that comes with the sensor suite is too long. You may use the included 8'/2.4 m cable. If you use this shorter cable, pay special attention to preventing the sensor suite from shading the solar panel on the Gateway. (See below.) Davis also has two other cable lengths available for purchase: 40'/12m, (product no: 7876-040) and 200'/61m (product no. 7876-200).

If your installation is between 0° and 45° latitude, North or South, and you mount the Gateway and a Vantage Pro2 sensor suite on the same pole, it is important to make sure the sensor suite does not shadow the Gateway's solar panel at midday, especially in the summer. Mount the sensor suite and Gateway so that they are at least 4 feet (1.2 m) apart or rotate the Gateway 45° to the east or west (depending on your location). If you do rotate the Gateway, you may need to return it to face south (Northern Hemisphere) or north (Southern Hemisphere) in the winter. You can also add a **Davis Angle Shelter Bracket**, product number 6671, which will increase the Gateway's tilt to 30°.

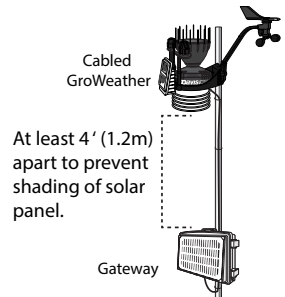

Set Up Nodes and Sensors

Contents of Node

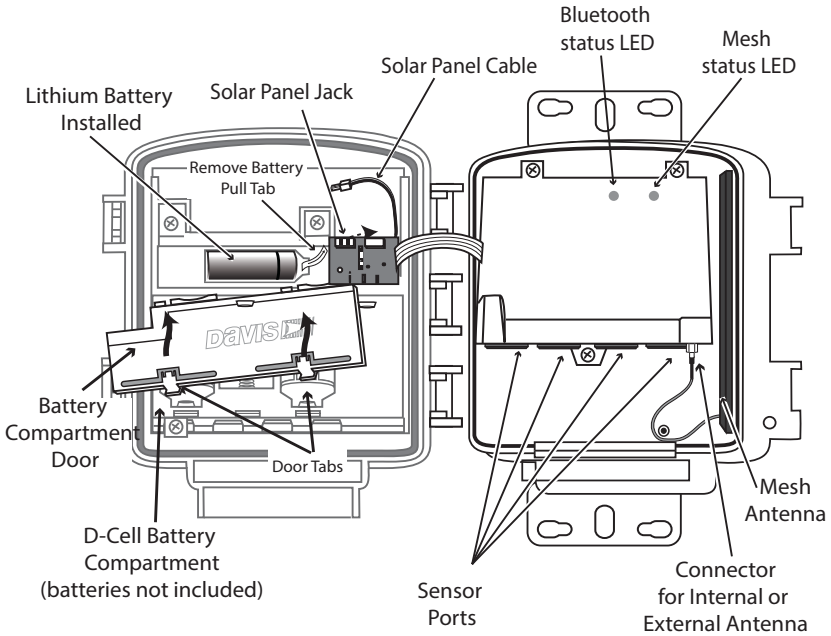

Hardware Kit

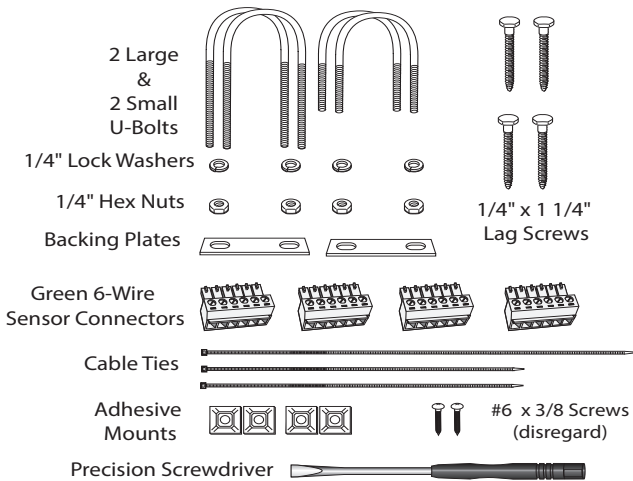

Requirements & Tools for Installation of Nodes and Sensors

- Included precision/miniature slotted screwdriver; ideal size: 2.5 mm or 3/32"; see actual size image of screw head and screwdriver blade at right 
- Four D-cell batteries
- Smartphone with EnviroMonitor app installed. *See page 7: Install the EnviroMonitor App.*
- Wire cutter/stripper and wrench
- Mounting pole or post

Note: You should install Nodes starting with the Node that will be closest to Gateway, then working outward to the Node furthest from Gateway. This allows each Node to establish a connection with the Gateway or a Node that has already been installed.

Power-up and Connect the Node

Make sure the EnviroMonitor app has been installed on the smartphone you will be using to install the Node. It will guide you through adding Nodes to the Gateway that has already been installed.

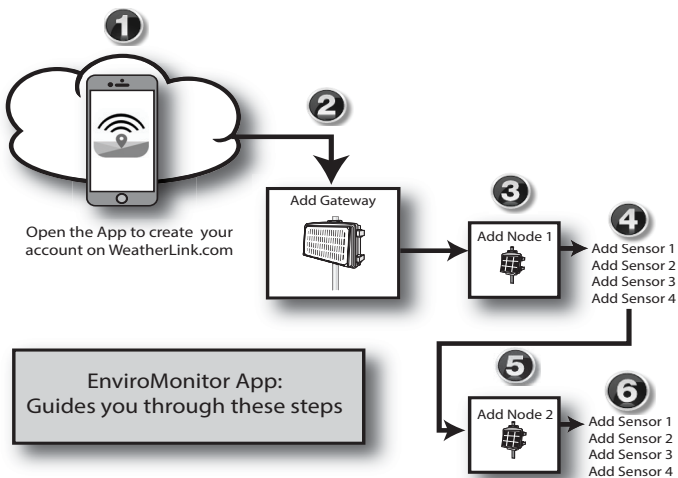

Power Up the Node: *See illustration on page 12: Contents of Node.*

1. Remove the D-cell battery compartment door and install 4 D-cell batteries according to the + and - marks in the battery compartment. The Node will power up. The mesh status LED will indicate connection. Replace the door.

IMPORTANT: Install the D-cell batteries **FIRST**. **Make sure they are firmly installed and not tilted outward.** The battery compartment door prevents the D-cells from vibrating loose; be sure to reinstall it correctly.

2. Remove the battery pull tab from the lithium battery and make sure the battery is firmly in place.
 3. Plug in the solar panel cable.
-

Connect Node to Gateway

1. Take the Node and smartphone to the general location in which you wish to install your Node. Make sure the phone's Bluetooth (BLE) is on.
2. Open the app on the smartphone.
3. Open the door of the Node. (This turns the Node's BLE on.) The BLE status LED will blink blue. See the illustration on page 12: **Contents of Node**.
4. In the app, select the Gateway to which this Node will send its data.
5. Tap **Add Node**.
6. Bring the phone close to the Node.
7. Follow the prompts in the app as it finds the Node and connects it to the Gateway. This transmits the Gateway's identifying information to the Node and allows its data to be received by the Gateway. Having specific identification for each Gateway/Node pair allows you to have multiple Gateways without cross transmission.

Using the app, you will be see this Node's serial number appear on the list for the Gateway.

You will know the Node has found its "mesh parent" (a Gateway or another Node) when you see the BLE status LED go solid blue. If it cannot "find" its parent, try moving the Node to a different location. If the location of the Node cannot be changed, consider installing another Node closer to the parent, to act as a repeater. It does not need to have any sensors installed.

When the connection is complete, the mesh status LED will turn solid green. See the illustration on page 12: **Contents of Node**.

Install the Sensor(s)

The list of sensors your EnviroMonitor system supports is constantly growing. Check www.davisinstruments.com/em-sensors for the current list.

Note: Wiring diagrams for each sensor are shown in the EnviroMonitor app.

Each Node has four sensor ports. You can install the sensors before or after mounting the Node. For example, if you plan to mount the node on a tower, you will want to install the sensor first.

1. Install the sensor in the environment per the manufacturer's instructions, making sure the sensor is installed within cable reach of the Node when it is mounted.
2. On your smartphone, open the EnviroMonitor app and select this Node. Tap **Add Sensor**. From the menu, first select the sensor type, then the specific sensor. Follow the wiring diagram in the app to correctly wire the sensor into one of the green 6-wire sensor connectors. Using a 2.5mm (3/32") precision slotted screwdriver, loosen the appropriate screws and insert the bare wires.
3. Tighten the screws very tight.

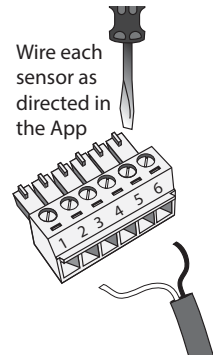

-
4. Insert the 6-wire sensor connector into the sensor port indicated by the app. Make sure it is aligned properly and not offset.

Note: If the Davis sensor has an RJ-plug on its cable, use the Davis RJ Adapter, product number 6860. Or, you can remove the plug and strip the wires.

RJ Adapter,
#6860

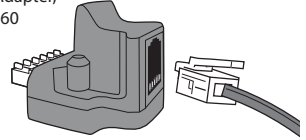

Try not to strip the covering back so far that the bare wires can touch each other when the connector is plugged in, but make sure the clamp in the sensor port is closing on wire, not plastic. (About 1/4" [6.4 mm] of exposed wire is ideal.)

5. Run the sensor cable down and out of the box through the bottom. **Make sure it will be enclosed by the foam when the Node door is closed.**
6. When all sensors are installed, close the Node door, making sure all cables are against the foam and not the hard plastic of the door. Use included zip ties and adhesive mounts if desired.

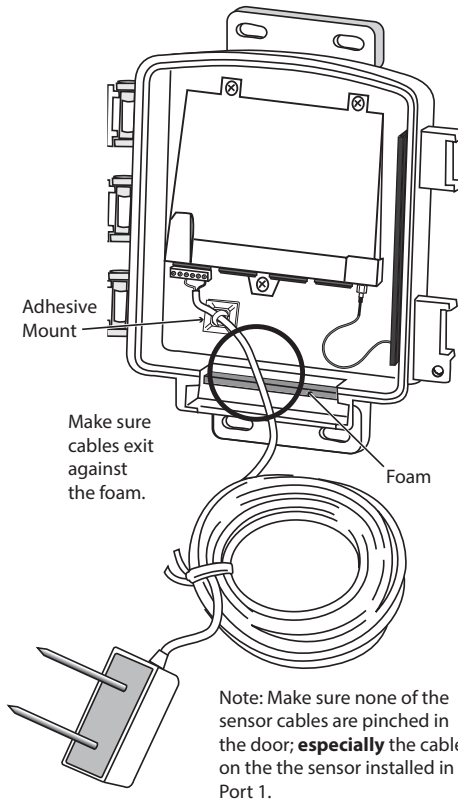

Mount the Node

The Node can be mounted on a pole or a flat surface such as a wall or a wooden post.

It is important that the Node be mounted so that the solar panel gets the greatest amount of sunshine -- the solar panel should be facing south (in the Northern Hemisphere) or north (in the Southern Hemisphere).

Tip: *Mounting the Node may be easier if done by two people.*

Mounting On a Fence Post or Pole

Mount the Node onto a fence post or a pole using the U-bolts, backing plates, washers, and hex nuts provided.

Note: Use the smaller U-bolts on a pole with an outside diameter of 0.84" to 1.84" (21 mm to 47 mm). For mounting on square perforated tubing or larger diameter poles up to 1.94" (49 mm) outside diameter, use the larger U-bolts.

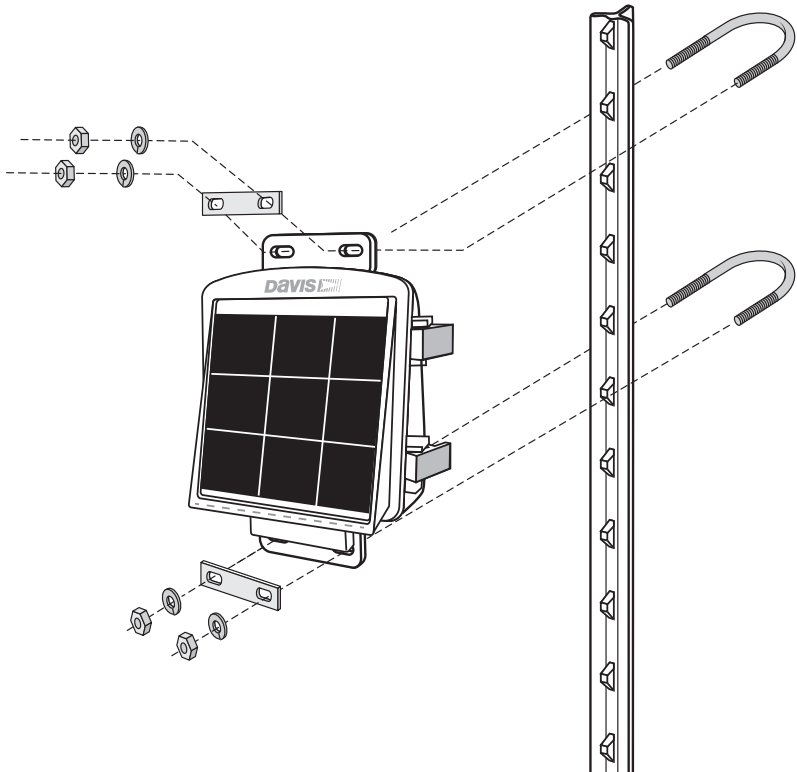

Mounting on a Flat Surface

Attach the Node to the mounting surface in the desired location using the lag screws and backing plates as shown below. Use a pencil or a center-punch to mark the location of the pilot hole.

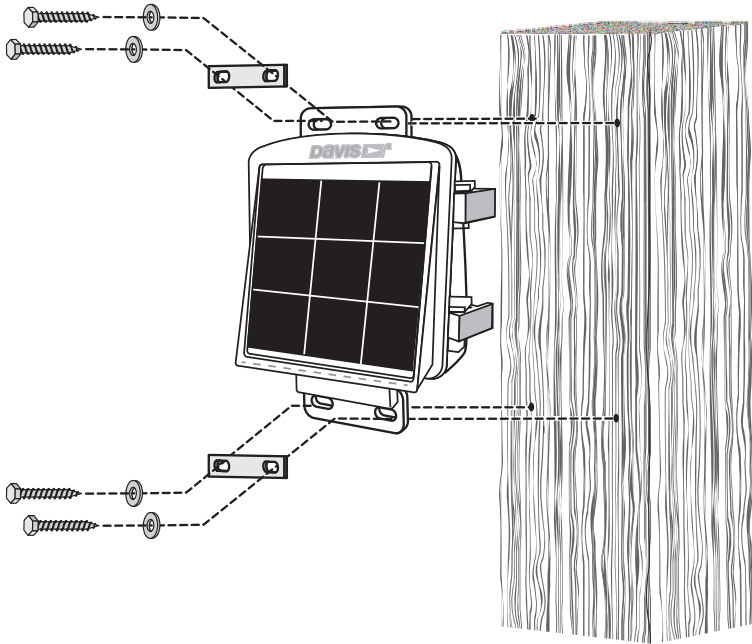

Note: To increase transmission range from Node to Gateway or Node to Node, you may replace the internal mesh antenna with an external Long Range Antenna. See page 22: **Appendix A: Adding a Long Range Antenna**

Manage Your Data

Log on to WeatherLink.com to view and manage your data.

You can also use view and manage your data on your smartphone with the Mobilize app. Find the app by searching for Davis Mobilize in the iOS App Store or Google Play Store.



Download the
Mobilize App

Maintenance

The solar panel on your Gateway or Node will perform well even with dust on it. However, you can keep the panel charging optimally by periodically cleaning any bird droppings, heavy dust, dirt, snow, leaves, or insect nests or webs from the solar panel. The frequency of cleaning will depend on your installation, but at least once a year. Those near roads or railroad tracks, for example may collect more dust and dirt than those in the center of a field. Use a soft, damp cloth to remove any debris from the solar panel.

Troubleshooting

Gateway

? *What do the Gateway status LEDs indicate?*

Gateway Status LEDs			
LED	LED Behavior	Indicates	What to do
POWER	Solid green	Battery is good.	
	Solid amber	Battery is weak.	Check solar panel or replace battery soon.
	Solid red	Battery is very low.	Replace battery.
	Off	In power-save mode.	Press the blue reset button to “wake up” LEDs to determine status.
CELLULAR	Solid green	Connected to WeatherLink.com with good signal RSSI.	
	Solid amber	Connected to WeatherLink.com with weak signal RSSI.	
	Solid red	Radio is malfunctioning.	
	Off	Cell LED has timed-out to save power.	Press the blue reset button to “wake up” LEDs to determine status.
	Blinking green	Attempting to connect with a good signal.	
	Blinking amber	Attempting to connect with a weak signal.	
	Blinking red	No signal.	Check antenna and connections.
MESH	Solid green	Gateway has received a transmission from a Node.	
	Solid red	Mesh not configured or connection lost	
	Off	In power saving mode or not configured.	Use the EnviroMonitor app to configure the Gateway.
	Blinking green	Trying to connect to Nodes.	
DAVIS TALK	Solid green	Connected to weather station with good signal or cable connection	
	Solid amber	Connected to wireless weather station with weak signal.	
	Solid red	Radio connection to wireless weather station is malfunctioning.	
	Off	In power saving mode or not configured.	
	Blinking green	Searching for wireless weather station signal.	
	Blinking Red	Cannot find wireless weather station signal.	Check cabled connections/antenna; move Gateway and wireless weather station closer together.
BLE	Solid blue	The Gateway is connected to the EnviroMonitor app.	
	Off	BLE radio is in power-saving mode.	Press the blue reset button.

? *My Gateway can't access the cell network or WeatherLink.com*

Have you configured your Gateway in the EnviroMonitor app? If you have done so and the cell LED blinks red, your Gateway may be installed in a poor cellular coverage area. Leave the Gateway in place for at least 30 minutes to see if it can connect. If not, you may need to relocate the Gateway or contact Technical Support. See page 26: **Contacting Davis Technical Support**.

? *How can I tell if my Gateway battery voltage is getting too low?*

Our server will monitor your battery voltage and will trigger an e-mail warning if it should get critically low (approximately 14 days of power). The e-mail will go to both the registered customer's e-mail address as well as the alarm e-mail address (if one has been set up). You can also see the battery power in the app: choose this Gateway, then Gateway Power.

? *What do I do if my Gateway battery is low?*

The EnviroMonitor features a robust battery and solar panel. It is designed to recharge and last for years. If your battery is low, you need to determine why the solar panel is not recharging the battery. This is usually due to something shading the solar panel (such as vegetation, snow, or dirt), or the solar panel becoming turned away from the sun. Check your installation to make sure sunlight is reaching the solar panel.

? *My installation is in a low light area. Can I add another solar panel?*

Yes. You can add an Extra Solar Panel Kit (product number 6616).

? *Can I use AC power to charge the Gateway battery?*

If your installation is in a low-light area or an area with prolonged periods of time where temperatures stay below -4°F (-20°C), charging may be severely diminished. You may use Davis's Optional AC Charger Kit, product number 6710, to charge the battery. The kit allows you to replace the solar charger with AC power. The adapter has a universal input (100 -240V, 50-60 Hz) and will work anywhere in the world. (A wall-plug adapter may be necessary for use in some countries.) In a cold environment, you will need to bring the Gateway into a warmer environment (above -4°F/-20°C) to charge the battery with the AC Charger Kit.

? *I'm not getting data from my Node to the Gateway?*

- Make sure the D batteries in the Node are installed all the way in. Sometimes they appear to be but are actually tilted outward, preventing connection.
- Make sure the green sensor adapters in the Node are aligned properly and not offset.
- Make sure the screws on the sensor adapters are very tight.
- Make sure none of the sensor cables are pinched in the Node door.

If these steps don't solve the problem, consider mounting the Node and Gateway higher above the canopy. See "To get optimal transmission range:" on page 2.)

Node

? What do the Node status LEDs indicate?

Node Status LEDs			
LED	LED Behavior	Indicates	What to do
BLE	Off	BLE radio is in low-power mode.	Close, then open the door to activate the BLE radio.
	Flashes blue.	Node is ready to connect to the EnviroMonitor app.	Use the EnviroMonitor app to configure the Node.
	Solid blue.	The Node is connected to the EnviroMonitor app.	
RADIO	Off	The radio LED has timed out to save power.	Close then open the door to activate the radio LED.
	Solid amber for 3 seconds when powering up.	The Node is powering up.	
	Blinking green.	The Node is trying to connect to a mesh parent.	Wait for the LED to turn solid green. See below: My Node can't connect to the Gateway or mesh parent.
	Solid green.	The Node has connected to a mesh parent.	
	Blinking amber.	The Node is trying to connect to a mesh parent and the Node's batteries are low.	Replace the D-cell batteries and see below: My Node can't connect to the Gateway or mesh parent.
	Solid amber.	The Node is connected to a mesh parent and its batteries are low.	Replace D-cell batteries.
	Solid red.	The Node has not been configured.	Configure the Node using the EnviroMonitor app.

? My Node can't connect to the Gateway or mesh parent.

Give the Node more time, at least 15 minutes, to negotiate a connection to the mesh network. If it still cannot connect, the Node is not within transmission distance to a parent. To solve this you can relocate the Node closer to the Gateway or another Node, or you can install another intermediate Node between it and the mesh parent to help it connect to the mesh network.

? How can I tell if my Node batteries are getting too low?

The mesh LED will be solid or blinking amber to show that the Node's batteries are low. See the table above. You can also see the battery power in the app: choose this Node's Gateway, then this Node, then Node Power.

Appendix A: Adding a Long Range Antenna

Add a high gain external antenna to your Gateway and/or Nodes to increase the transmission distance of an EnviroMonitor mesh network up to 10,000 feet (3,000 m). Antennas can be used for either Node-to-Node or Node-to-Gateway transmission.

Choose either product number 7676, 5dBi; or 7678, 8dBi. The table below shows estimated transmission ranges of each of the antennas. (The antenna that comes installed in your Gateway or Node is a standard dipole.)

Antenna	Distance Above Ground or Highest Crop Height					
	6 ft / 2m		8ft./2.5 m		10ft./3 m	
Standard Dipole	1,700 - 2,000'	515 - 610 m	1,800 - 2,400'	545 - 730 m	2,400 - 4,000'	730 - 1,220 m
5dBi External	2,600'	790 m	4,000'	1,200 m	6,000'	1,800 m
8dBi External	5,000'	1,500 m	7,000'	2,100 m	10,000'	3,000 m

Using a Long Range Antenna with a Gateway

1. Open the Gateway.
2. Using a Phillips-head screwdriver, remove the two screws attaching the smoky plastic cover over the Gateway's electronics.

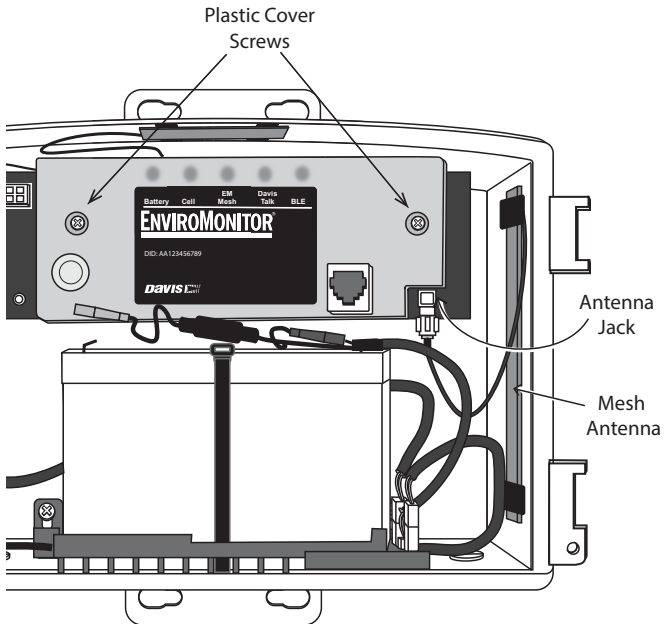

3. Remove the installed mesh antenna by unscrewing it from the connector. You may need to use a 5/16" (8 mm) wrench or small pliers.
4. Remove the solid grommet from the hole on the right side of the bottom of the Gateway shelter. Run the connector end of the antenna cable up through this hole and place the split grommet with a round hole (included with antenna) around it and push the grommet up into the hole to seal the shelter.
5. Screw the external antenna cable into the connector. Do not over-tighten.
6. Replace the plastic cover, making sure the antenna cable exits through the channel on the right.

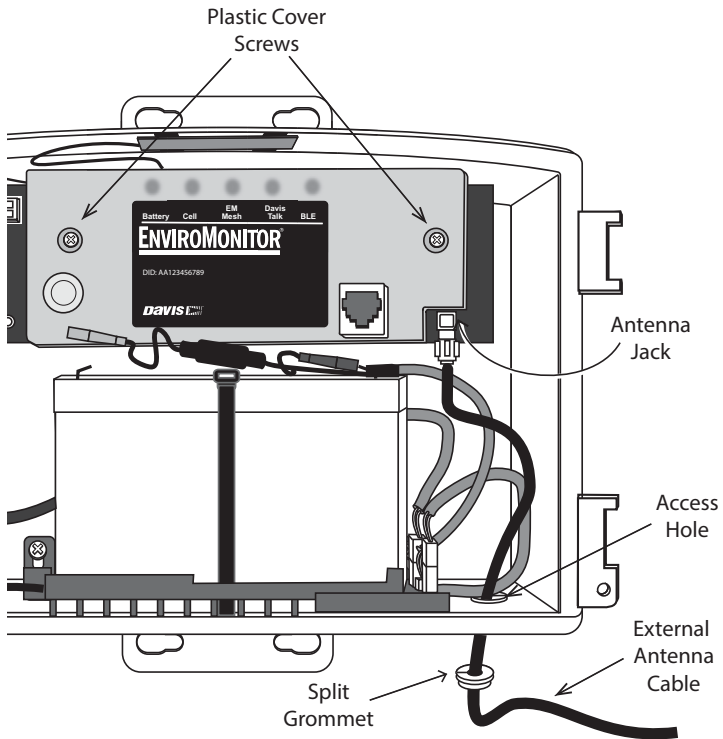

7. Mount the antenna on a pole, as high as possible, using the mounting hardware included with the antenna.

Tip: *If you need longer cable on your antenna, add an Extension Cable. See page 24: Adding an Extension Cable to your Long Range Antenna.*

Using a Long Range Antenna with a Node

1. Open the Node.
2. Remove the installed mesh antenna by unscrewing it from the connector on the right side of the Node shelter. You may need to use a 5/16" x 8 mm wrench or small pliers.
3. Screw the external antenna cable into the connector. Do not over-tighten.
4. Run the cable out the bottom of the Node, making sure it exits against the foam.
5. Close the Node shelter.
6. Mount the antenna on a pole, as high as possible, using the mounting hardware included with the antenna.

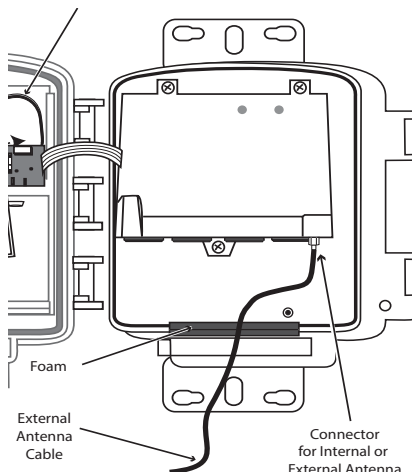

Adding an Extension Cable to your Long Range Antenna

You can extend the length of your Long Range Antenna cable with the Antenna Extension Cable, product number 7692-025.

To use the extension cable:

1. Loosen the end caps of the weatherproof junction cover and insert the extension cable through the cover.
2. Connect the extension cable to the antenna cable.
3. Slide the cover over the junction of the two cables and tighten the end caps.

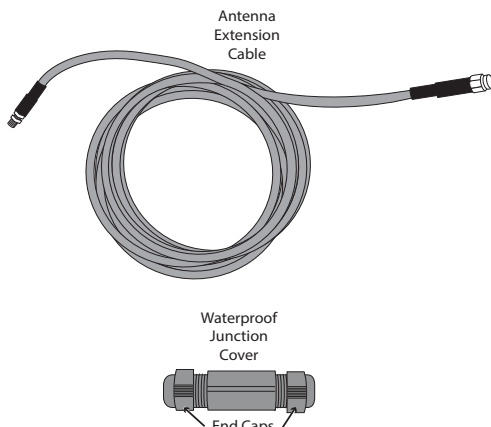

Specifications

Gateway

Operating Temperature	-40° to +140°F (-40° to +60°C)
Charging Temperature	-4° to +120°F (-20° to +49°C)
Storage Temperature	-40° to +140°F (-40° to +60°C)
Current Draw	25mA typical, 1A peak
Housing Material	Rugged ASA Plastic
Dimensions (width x height x depth)	13.75 X 10 X 4.15 inches (34.9 X 25.4 X 10.5 cm)
Weight	8.50 lbs. (3.86 kg)
Battery	6 volt, 12 Ah, gel cell with quick disconnect 0.250" x 0.032" (6.35 mm x 0.81 mm) tabs
Certifications:	FCC CE IC
Cellular Communication	850/900 MHz (GSM/EGSM), Class 4 (33 dBm); 1800/1900 MHz (DCS/PCS) Class 1 (33 dBm); WCDMA: B1/B2/B4/B5/B6/B8/B19, Class 3 (24 dBm); LTE CAT-1 FDD: B1/B2/B3/B4/B5/B7/ B8/B12, B13/B18/B19/B20/B25/B26/ B28, Class 3 (23 dBm); LTE CAT-1 TDD: B38/B39/B40/B41 Class 3 (23 dBm);

Node

Operating Temperature	-4° to +140°F (-20° to +60°C)
Storage Temperature	-40° to +140°F (-40° to +60°C)
Current Draw	12mA typical
Housing Material	Rugged ASA Plastic
Dimensions (width x height x depth)	8.25 X 11.25 X 5.5 inches (21.00 X 28.58 X 14.00cm)
Weight	3.40 lbs. (1.54 kg) (without batteries)
Batteries	Four D-cells (LR20, not included), One lithium-ion (18650, included)
Certifications:	FCC CE IC

Mesh Communication (both Gateway and Node)

Region	Min. - Max Frequency	Output Power
USA	902 - 928 MHz	902 - 928 MHz FHSS, <25 mW
EU	868.0 - 868.6 MHz	868.0 - 868.6 MHz FHSS, <25 mW
Australia, Brazil	918 - 926 MHz	918 - 926 MHz FHSS, <25 mW
New Zealand, Peru	921 - 928 MHz	921 - 928 MHz FHSS, <25 mW
India	865 - 867 MHz	865 - 867 MHz FHSS, <25 mW
Russia	868.7 - 869.2 MHz	868.7 - 869.2 MHz FHSS, <25 mW

All bands are license-free.

Contacting Davis Technical Support

For questions about installing or operating your EnviroMonitor Gateway or Node, please contact Davis Technical Support. We'll be glad to help.

Online www.davisinstruments.com

See the Weather Support section for copies of user manuals, product specifications, application notes, software updates, and more.

E-mail support@davisinstruments.com

Telephone (510) 732-7814
Monday - Friday, 7:00 a.m. - 5:30 p.m. Pacific Time.

EnviroMonitor® Gateway and Node

Product Numbers 6803, 6810

Document Number: 07395.392 Rev. A 5/27/21

EnviroMonitor®, GroWeather®, Vantage Pro®, Vantage Pro2™, Vantage Vue®, and WeatherLink® are trademarks of Davis Instruments Corp., Hayward, CA.

© Davis Instruments Corp. 2021. All rights reserved.

Information in this document subject to change without notice. Davis Instruments Quality Management System is ISO 9001 certified.



3465 Diablo Avenue, Hayward, CA 94545-2778 U.S.A.

510-732-9229 • Fax: 510-732-9188

info@davisinstruments.com • www.davisinstruments.com