

FCC Test Report

FCC ID : IPH-04224
Equipment : Watch and Activity Monitor
Model No. : A04224
Brand Name : GARMIN
Applicant : Garmin International, Inc.
Address : 1200 E. 151st Street Olathe, KS 66062 United States
Standard : 47 CFR FCC Part 15.225
Received Date : Jul. 13, 2022
Tested Date : Jul. 19 ~ Jul. 25, 2022

We, International Certification Corporation, would like to declare that the tested sample has been evaluated and in compliance with the requirement of the above standards. The test results contained in this report refer exclusively to the product. It shall not be reproduced except in full without the written approval of our laboratory.

Reviewed by:

Approved by:

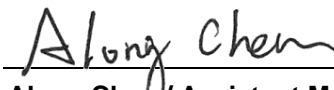

Along Chen / Assistant Manager



Gary Chang / Manager

Table of Contents

1	GENERAL DESCRIPTION	5
1.1	Information.....	5
1.2	Local Support Equipment List	6
1.3	Test Setup Chart	6
1.4	The Equipment List	7
1.5	Test Standards	8
1.6	Deviation from Test Standard and Measurement Procedure.....	8
1.7	Measurement Uncertainty	8
2	TEST CONFIGURATION.....	9
2.1	Testing Facility	9
2.2	The Worst Test Modes and Channel Details	9
3	TRANSMITTER TEST RESULTS	10
3.1	20dB and Occupied Bandwidth.....	10
3.2	Field Strength of Fundamental Emissions	11
3.3	Unwanted Emissions into Restricted Frequency Bands	12
3.4	Frequency Stability.....	14
3.5	AC Power Line Conducted Emissions	15
4	TEST LABORATORY INFORMATION	16

APPENDIX A. 20DB AND OCCUPIED BANDWIDTH

APPENDIX B. FIELD STRENGTH OF FUNDAMENTAL EMISSIONS

APPENDIX C. UNWANTED EMISSIONS INTO RESTRICTED FREQUENCY BANDS

APPENDIX D. FREQUENCY STABILITY

APPENDIX E. AC POWER LINE CONDUCTED EMISSIONS

Release Record

Report No.	Version	Description	Issued Date
FR270504NF	Rev. 01	Initial issue	Sep. 16, 2022

Summary of Test Results

FCC Rules	Test Items	Measured	Result
15.207	AC Power Line Conducted Emissions	[dBuV]: 0.788MHz 17.62 (Margin -28.38dB) - AV	Pass
15.225(a)~(c)	Field strength of fundamental emissions and spectrum mask	Meet the requirement of limit	Pass
15.225(d)	Field strength of any emissions appearing outside of the 13.110-14.010 MHz band	Meet the requirement of limit	Pass
15.225(e)	Frequency tolerance	Meet the requirement of limit	Pass
15.215 (c)	20dB bandwidth	Meet the requirement of limit	Pass
15.203	Antenna Requirement	Meet the requirement of limit	Pass

Declaration of Conformity:

The test results with all measurement uncertainty excluded are presented in accordance with the regulation limits or requirements declared by manufacturers.

Comments and Explanations:

The declared of product specification for EUT presented in the report are provided by the manufacturer, and the manufacturer takes all the responsibilities for the accuracy of product specification.

1 General Description

1.1 Information

1.1.1 Specification of the Equipment under Test (EUT)

RF General Information			
Frequency Range (MHz)	Modulation	Ch. Frequency (MHz)	Channel Number
13.553 – 13.567	ASK	13.56	1

1.1.2 Antenna Details

Ant. No.	Brand	Model	Type	Connector	Gain (dBi)	Remarks
1	INPAQ	NF-C-F9-R0-134	Loop	Yes	---	---

1.1.3 EUT Operational Condition

Power Supply Type	3.83Vdc from battery 5Vdc from host		
Operational Voltage	<input checked="" type="checkbox"/> Vnom (3.83 V)	<input checked="" type="checkbox"/> Vmax (4.4 V)	<input checked="" type="checkbox"/> Vmin (3.6 V)
Operational Climatic	<input checked="" type="checkbox"/> Tnom (20°C)	<input checked="" type="checkbox"/> Tmax (55°C)	<input checked="" type="checkbox"/> Tmin (-10°C)

1.1.4 Accessories

No.	Equipment	Description
1	Battery	Brand: Garmin Model: 361-00155-00 Power Rating: 3.83V, 87mAh
2	USB cable	Brand: Garmin Model: 320-00977-40 Line: 0.57m shielded without core

1.1.5 Test Tool and Power Index

Test Tool	NFC Test, Version: SW 52.07
Power Index	Default

1.2 Local Support Equipment List

Support Equipment List					
No.	Equipment	Brand	Model	FCC ID	Remarks
1	Adapter	philip	DLP6341C	---	---

1.3 Test Setup Chart

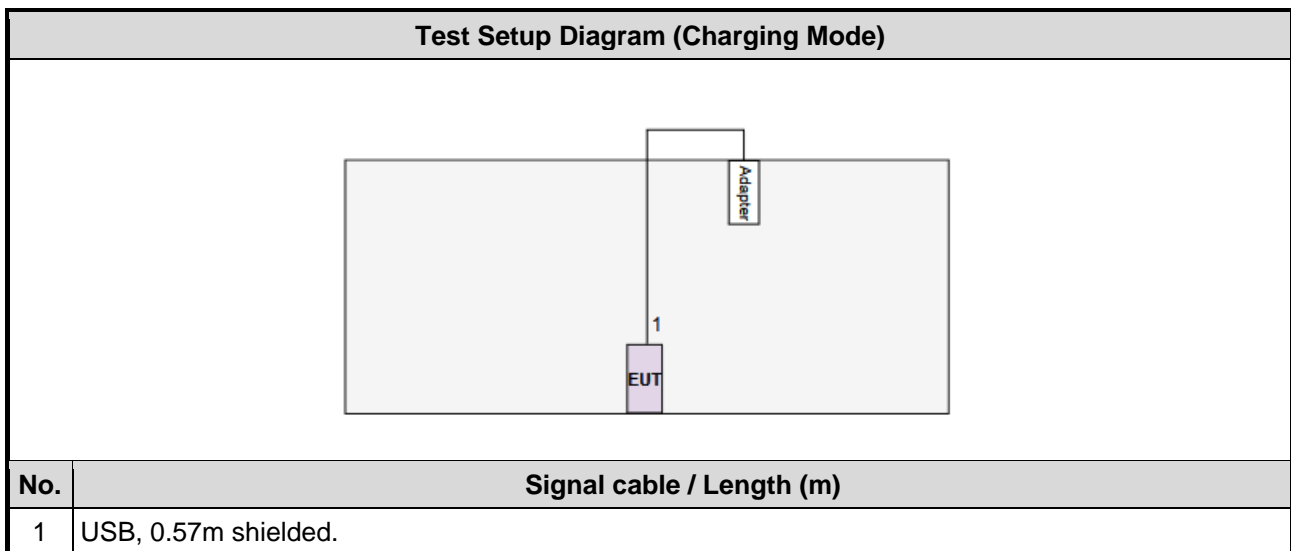
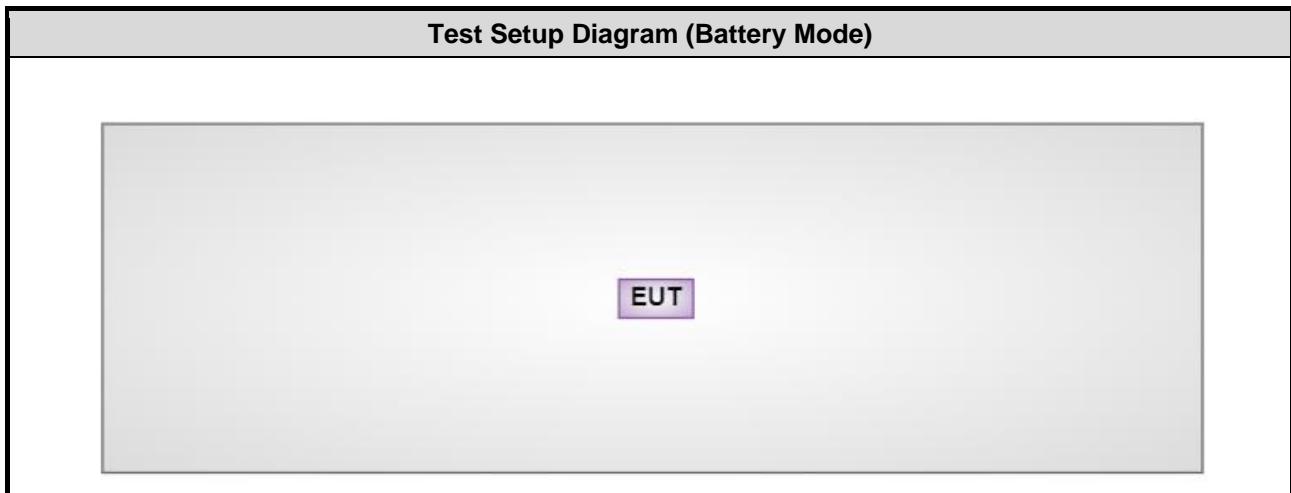

1.4 The Equipment List

Test Item	Conducted Emission				
Test Site	Conduction room 1 / (CO01-WS)				
Tested Date	Jul. 25, 2022				
Instrument	Brand	Model No.	Serial No.	Calibration Date	Calibration Until
Receiver	R&S	ESR3	101658	Feb. 16, 2022	Feb. 15, 2023
LISN	R&S	ENV216	101579	Apr. 21, 2022	Apr. 20, 2023
RF Cable-CON	Woken	CFD200-NL	CFD200-NL-001	Oct. 19, 2021	Oct. 18, 2022
Measurement Software	AUDIX	e3	6.120210k	NA	NA
Note: Calibration Interval of instruments listed above is one year.					

Test Item	Radiated Emission				
Test Site	966 chamber1 / (03CH01-WS)				
Tested Date	Jul. 19 ~ Jul. 25, 2022				
Instrument	Brand	Model No.	Serial No.	Calibration Date	Calibration Until
Receiver	R&S	ESR3	101657	Mar. 15, 2022	Mar. 14, 2023
Loop Antenna	R&S	HFH2-Z2	100330	Nov. 08, 2021	Nov. 07, 2022
Bilog Antenna	SCHWARZBECK	VULB9168	VULB9168-685	Jun. 28, 2022	Jun. 27, 2023
Preamplifier	EMC	EMC02325	980225	Jun. 28, 2022	Jun. 27, 2023
Loop Antenna Cable	KOAX KABEL	101354-BW	101354-BW	Oct. 05, 2021	Oct. 04, 2022
LF cable 3M	Woken	CFD400NL-LW	CFD400NL-001	Oct. 05, 2021	Oct. 04, 2022
LF cable 11M	EMC	EMCCFD400-NW-N W-11000	200801	Oct. 05, 2021	Oct. 04, 2022
LF cable 1M	EMC	EMCCFD400-NM-N M-1000	160502	Oct. 05, 2021	Oct. 04, 2022
Measurement Software	AUDIX	e3	6.120210g	NA	NA
Note: Calibration Interval of instruments listed above is one year.					

Test Item	RF Conducted				
Test Site	(TH01-WS)				
Tested Date	Jul. 25, 2022				
Instrument	Brand	Model No.	Serial No.	Calibration Date	Calibration Until
Spectrum Analyzer	R&S	FSV40	101910	Apr. 18, 2022	Apr. 17, 2023
Power Meter	Anritsu	ML2495A	1241002	Nov. 07, 2021	Nov. 06, 2022
Power Sensor	Anritsu	MA2411B	1207366	Nov. 07, 2021	Nov. 06, 2022
DC POWER SOURCE	GW INSTEK	GPC-6030D	GES855395	Nov. 08, 2021	Nov. 07, 2022
TEMP&HUMIDITY CHAMBER	GIANT FORCE	GCT-225-40-SP-SD	MAF1212-002	Jun. 22, 2022	Jun. 21, 2023
Note: Calibration Interval of instruments listed above is one year.					

1.5 Test Standards

47 CFR FCC Part 15.225

ANSI C63.10-2013

1.6 Deviation from Test Standard and Measurement Procedure

None

1.7 Measurement Uncertainty

The measurement uncertainties given below are based on a 95% confidence level (based on a coverage factor ($k=2$)).

Measurement Uncertainty	
Parameters	Uncertainty
Bandwidth	± 34.130 Hz
Radiated emission ≤ 30 MHz	± 2.3 dB
Radiated emission ≤ 1 GHz	± 3.41 dB
Temperature	± 0.4 °C
AC conducted emission	± 2.92 dB

2 Test Configuration

2.1 Testing Facility

Test Laboratory	International Certification Corporation
Test Site	CO01-WS, 03CH01-WS, TH01-WS
Address of Test Site	No.3-1, Lane 6, Wen San 3rd St., Kwei Shan Dist., Tao Yuan City 33381, Taiwan (R.O.C.)

- FCC Designation No.: TW2732
- FCC site registration No.: 181692
- ISED#: 10807C
- CAB identifier: TW2732

2.2 The Worst Test Modes and Channel Details

Test item	Mode	Test Frequency (MHz)	Test Configuration
AC Power Line Conducted Emissions	Charging	---	1
Field strength of fundamental emissions	NFC	13.56	2
Unwanted Emissions into Restricted Frequency Bands < 30MHz	NFC	13.56	2
Unwanted Emissions into Restricted Frequency Bands > 30MHz	NFC	13.56	2
	Charging	---	1
Frequency tolerance	NFC	13.56	2
20dB bandwidth	NFC	13.56	2
NOTE:			
1. The EUT was pretested with 3 orientations placed on the table for the radiated emission measurement – X, Y, and Z-plane. The Y-plane results were found as the worst case and were shown in this report.			
2. The EUT had been tested by following test configurations.			
1) Configuration 1: Charging mode			
2) Configuration 2: Battery mode			

3 Transmitter Test Results

3.1 20dB and Occupied Bandwidth

3.1.1 Limit of 20dB Bandwidth

The upper and lower frequency of the 20dB bandwidth shall within 13.553~13.567 MHz

3.1.2 Test Procedures

1. Set resolution bandwidth (RBW) = 1 kHz, Video bandwidth = 3 kHz.
2. Detector = Peak, Trace mode = max hold.
3. Sweep = auto couple, Allow the trace to stabilize.
4. Measure the maximum width of the emission that is constrained by the frequencies associated with the two outermost amplitude points (upper and lower) that are attenuated by 20dB relative to the maximum level measured in the fundamental emission.

3.1.3 Test Setup

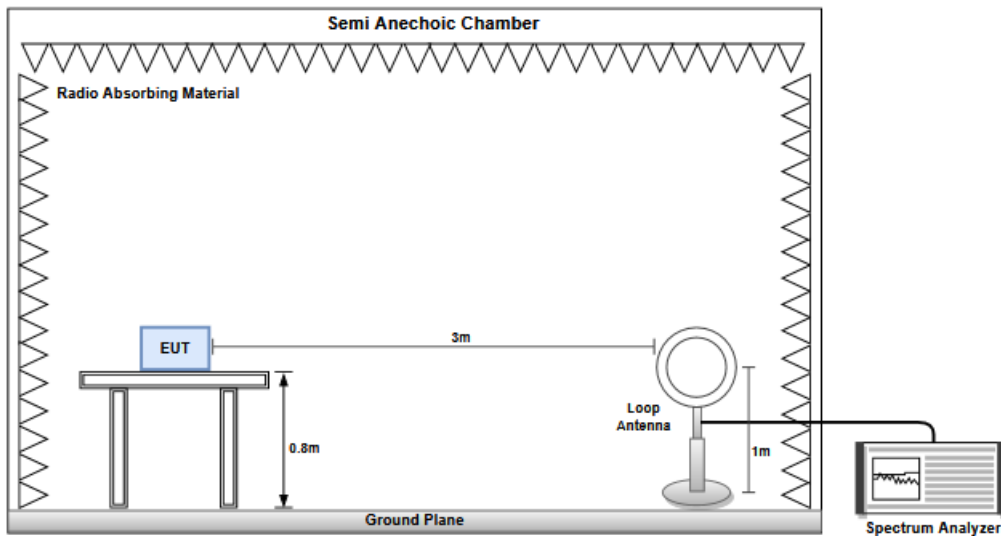

3.1.4 Test Result

Ambient Condition	26°C / 61%	Tested By	Roger Lu
-------------------	------------	-----------	----------

Refer to Appendix A.

3.2 Field Strength of Fundamental Emissions

3.2.1 Field Strength of Fundamental Emissions

The field strength of any emissions within the band 13.553-13.567 MHz shall not exceed 15,848 microvolts/meter at 30 meters.

3.2.2 Test Procedures

1. Measurement is made at a semi-anechoic chamber that incorporates a turntable allowing a EUT rotation of 360°. A continuously-rotating, remotely-controlled turntable is installed at the test site to support the EUT and facilitate determination of the direction of maximum radiation for each EUT emission frequency. The EUT is placed at a height of 0.8 m test table above the ground plane.
2. Measurement is made with the antenna positioned in both the open and close planes of polarization. . Distance between EUT and antenna is 3 m.
3. This investigation is performed with the EUT rotated 360°, and the antenna rotated to repeat the measurements for both the open and close antenna polarizations.

3.2.3 Test Setup

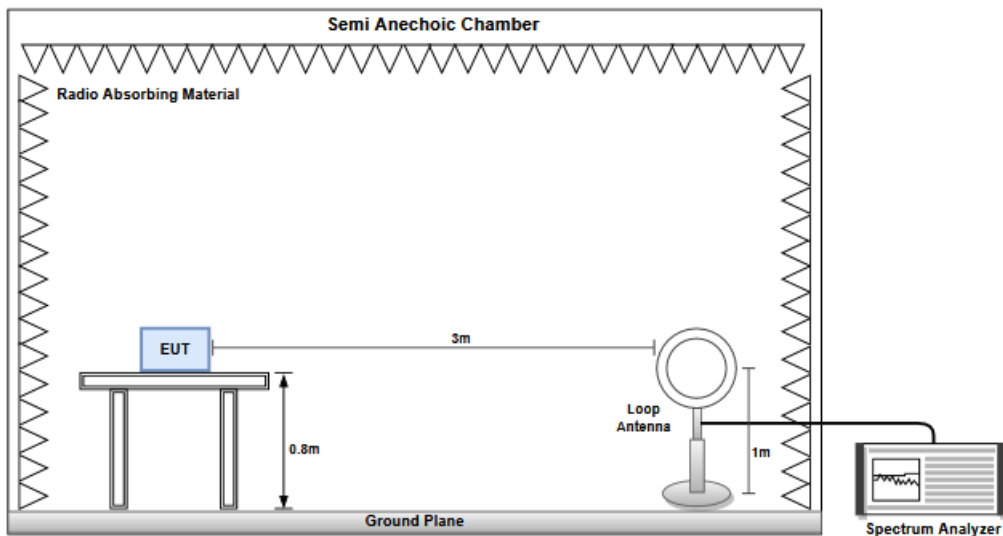

3.2.4 Test Result

Ambient Condition	26°C / 61%	Tested By	Roger Lu
--------------------------	------------	------------------	----------

Refer to Appendix B.

3.3 Unwanted Emissions into Restricted Frequency Bands

3.3.1 Limit of Unwanted Emissions into Restricted Frequency Bands

- 1) Within the bands 13.410-13.553 MHz and 13.567-13.710 MHz, the field strength of any emissions shall not exceed 334 microvolts/meter at 30 meters.
- 2) Within the bands 13.110-13.410 MHz and 13.710-14.010 MHz the field strength of any emissions shall not exceed 106 microvolts/meter at 30 meters.
- 3) The field strength of any emissions appearing outside of the 13.110-14.010 MHz band shall not exceed the general radiated emission limits in below table

Restricted Band Emissions Limit			
Frequency Range (MHz)	Field Strength (uV/m)	Field Strength (dBuV/m)	Measure Distance (m)
0.009~0.490	2400/F(kHz)	48.5 - 13.8	300
0.490~1.705	24000/F(kHz)	33.8 - 23	30
1.705~30.0	30	29	30
30~88	100	40	3
88~216	150	43.5	3
216~960	200	46	3
Above 960	500	54	3

Note 1:
Qusai-Peak value is measured for frequency below 1GHz except for 9–90 kHz, 110–490 kHz frequency band. Peak and average value are measured for frequency above 1GHz. The limit on average radio frequency emission is as above table. The limit on peak radio frequency emissions is 20 dB above the maximum permitted average emission limit

Note 2:
Measurements may be performed at a distance other than what is specified provided. When performing measurements at a distance other than that specified, the results shall be extrapolated to the specified distance using an extrapolation factor as below, Frequency at or above 30 MHz: 20 dB/decade Frequency below 30 MHz: 40 dB/decade.

3.3.2 Test Procedures

4. Measurement is made at a semi-anechoic chamber that incorporates a turntable allowing a EUT rotation of 360°. A continuously-rotating, remotely-controlled turntable is installed at the test site to support the EUT and facilitate determination of the direction of maximum radiation for each EUT emission frequency. The EUT is placed at a height of 0.8 m test table above the ground plane.
5. Measurement is made with the antenna positioned in both the horizontal and vertical planes of polarization. The measurement antenna is varied in height (1m ~ 4m) above the reference ground plane to obtain the maximum signal strength. Distance between EUT and antenna is 3 m.
6. This investigation is performed with the EUT rotated 360°, the antenna height scanned between 1 m and 4 m, and the antenna rotated to repeat the measurements for both the horizontal and vertical antenna polarizations.

Note:

1. 120kHz measurement bandwidth of test receiver and Quasi-peak detector is for radiated emission below 1GHz.

3.3.3 Test Setup

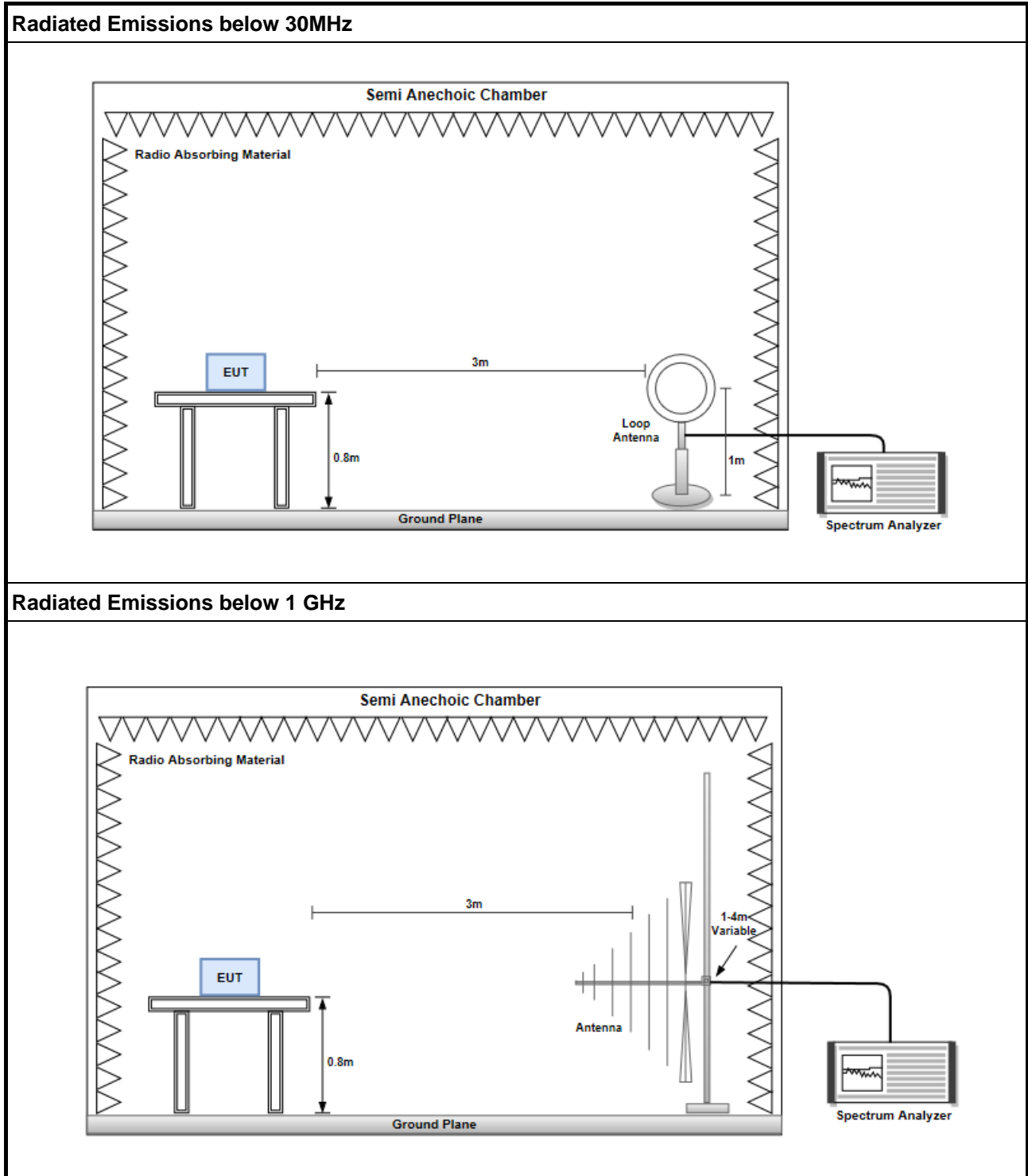

3.3.4 Test Results

Refer to Appendix C.

3.4 Frequency Stability

3.4.1 Frequency Stability Limit

Carrier frequency stability shall be maintained to $\pm 0.01\%$ (± 100 ppm).

3.4.2 Test Procedures

Test Method	
<input checked="" type="checkbox"/>	Refer as ANSI C63.10, clause 6.8 for frequency stability tests
<input checked="" type="checkbox"/>	Frequency stability with respect to ambient temperature
<input checked="" type="checkbox"/>	Frequency stability when varying supply voltage
<input type="checkbox"/>	For conducted measurement.
<input checked="" type="checkbox"/>	For radiated measurement. The equipment to be measured and the test antenna shall be oriented to obtain the maximum emitted power level.

3.4.3 Test Setup

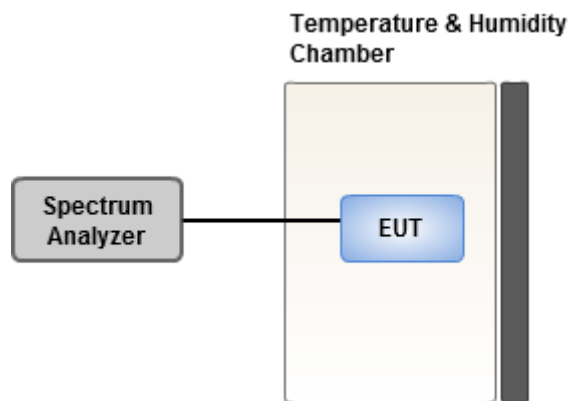

3.4.4 Test Result

Ambient Condition	26°C / 61%	Tested By	Roger Lu
--------------------------	------------	------------------	----------

Refer to Appendix D.

3.5 AC Power Line Conducted Emissions

3.5.1 Limit of AC Power Line Conducted Emissions

Conducted Emissions Limit		
Frequency Emission (MHz)	Quasi-Peak	Average
0.15-0.5	66 - 56 *	56 - 46 *
0.5-5	56	46
5-30	60	50

Note 1: * Decreases with the logarithm of the frequency.

3.5.2 Test Procedures

1. The device is placed on a test table, raised 80 cm above the reference ground plane. The vertical conducting plane is located 40 cm to the rear of the device.
2. The device is connected to line impedance stabilization network (LISN) and other accessories are connected to other LISN. Measured levels of AC power line conducted emission are across the 50 Ω LISN port.
3. AC conducted emission measurements is made over frequency range from 150 kHz to 30 MHz.
4. This measurement was performed with AC 120V / 60Hz.

3.5.3 Test Setup

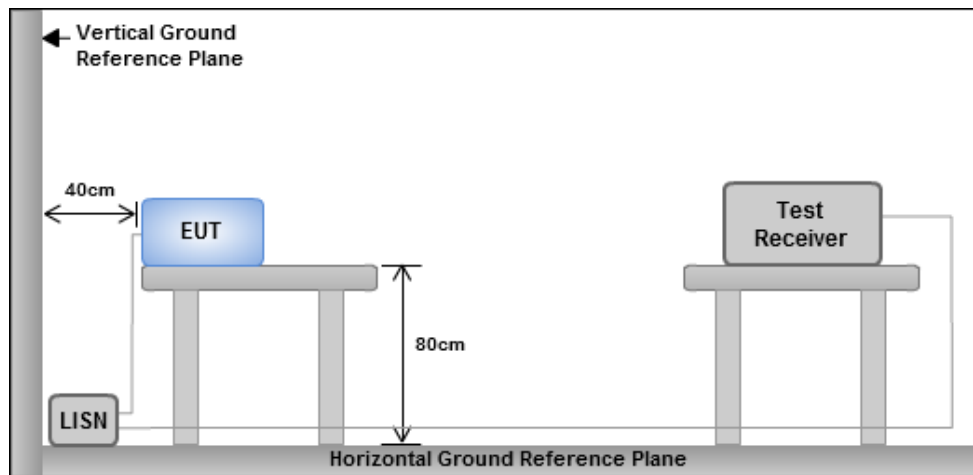

- Note: 1. Support units were connected to second LISN.
 2. Both of LISNs (AMN) are 80 cm from EUT and at least 80 cm from other units and other metal planes

3.5.4 Test Result

Refer to Appendix E.

4 Test laboratory information

Established in 2012, ICC provides foremost EMC & RF Testing and advisory consultation services by our skilled engineers and technicians. Our services employ a wide variety of advanced edge test equipment and one of the widest certification extents in the business.

International Certification Corporation (EMC and Wireless Communication Laboratory), it is our definitive objective is to institute long term, trust-based associations with our clients. The expectation we set up with our clients is based on outstanding service, practical expertise and devotion to a certified value structure. Our passion is to grant our clients with best EMC / RF services by oriented knowledgeable and accommodating staff.

Our Test sites are located at Linkou District and Kwei Shan District. Location map can be found on our website <http://www.icertifi.com.tw>.

Linkou

Tel: 886-2-2601-1640

No.30-2, Ding Fwu Tsuen, Lin Kou
District, New Taipei City, Taiwan
(R.O.C.)

Kwei Shan

Tel: 886-3-271-8666

No.3-1, Lane 6, Wen San 3rd
St., Kwei Shan Dist., Tao Yuan
City 33381, Taiwan (R.O.C.)
No.2-1, Lane 6, Wen San 3rd
St., Kwei Shan Dist., Tao Yuan
City 33381, Taiwan (R.O.C.)

Kwei Shan Site II

Tel: 886-3-271-8640

No.14-1, Lane 19, Wen San 3rd
St., Kwei Shan Dist., Tao Yuan
City 333, Taiwan (R.O.C.)

If you have any suggestion, please feel free to contact us as below information.

Tel: 886-3-271-8666

Fax: 886-3-318-0345

Email: ICC_Service@icertifi.com.tw

==END==



Modulation Mode	Freq. (MHz)	20dB Bandwidth (kHz)	F _L at 20dB BW (MHz)	F _H at 20dB BW (MHz)	99% Bandwidth (kHz)
NFC	13.56	2.75	13.558582	13.561332	2.764109986
Limit		N/A	13.553	13.567	N/A

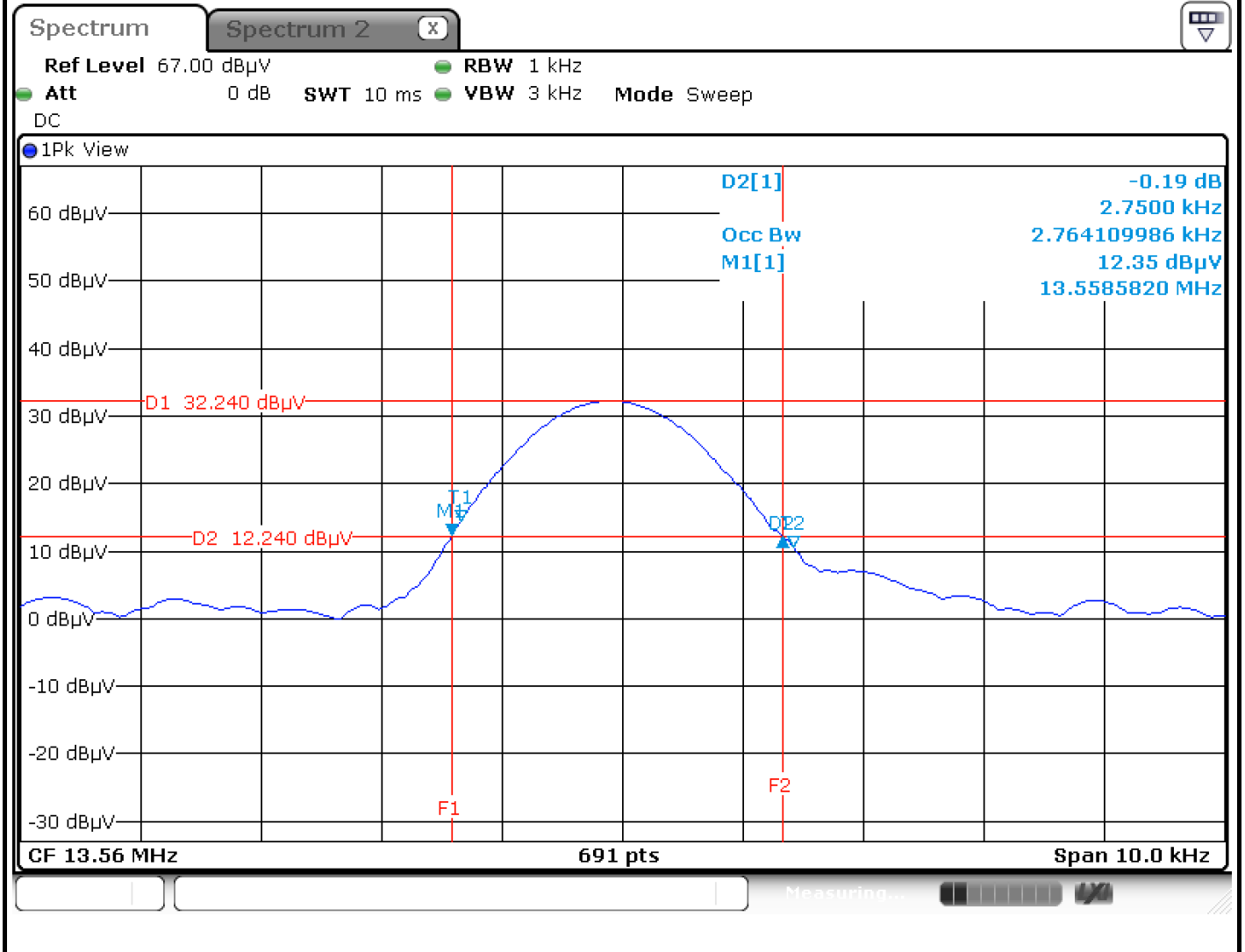



Field Strength of Fundamental Emissions Result							
Polarization	Emission Frequency (MHz)	Emission Level (dBuV/m)	Limit (dBuV/m)	Margin (dB)	SA Reading (dBuV)	Factor (dB)	Remark
Open	13.56	43.94	105.39	-61.45	19.56	24.38	QP

Field Strength of Fundamental Emissions Result							
Polarization	Emission Frequency (MHz)	Emission Level (dBuV/m)	Limit (dBuV/m)	Margin (dB)	SA Reading (dBuV)	Factor (dB)	Remark
Close	13.56	41.29	105.39	-64.1	16.91	24.38	QP

Note: Emission level = SA reading + Factor



Unwanted Emissions (Below 30MHz)

Field Strength of Fundamental Emissions Result							
Polarization	Emission Frequency (MHz)	Emission Level (dBuV/m)	Limit (dBuV/m)	Margin (dB)	SA Reading (dBuV)	Factor(dB)	Remark
Open	13.41	28.63	62	-33.37	4.29	24.34	QP
Open	13.553	31.16	71.87	-40.71	6.78	24.38	QP
Open	13.567	30.95	71.86	-40.91	6.57	24.38	QP
Open	13.71	29.06	61.81	-32.75	4.64	24.42	QP
Open	27.12	23.07	49.54	-26.47	3.24	19.83	QP

Field Strength of Fundamental Emissions Result							
Polarization	Emission Frequency (MHz)	Emission Level (dBuV/m)	Limit (dBuV/m)	Margin (dB)	SA Reading (dBuV)	Factor(dB)	Remark
Close	13.41	28.37	62	-33.63	4.03	24.34	QP
Close	13.553	30.62	71.87	-41.25	6.24	24.38	QP
Close	13.567	30.56	71.86	-41.3	6.18	24.38	QP
Close	13.71	28.65	61.81	-33.16	4.23	24.42	QP
Close	27.12	22.72	49.54	-26.82	2.89	19.83	QP

Note: Emission level = SA reading + Factor



Unwanted Emissions (Above 30MHz)

Configuration 1: Charging mode

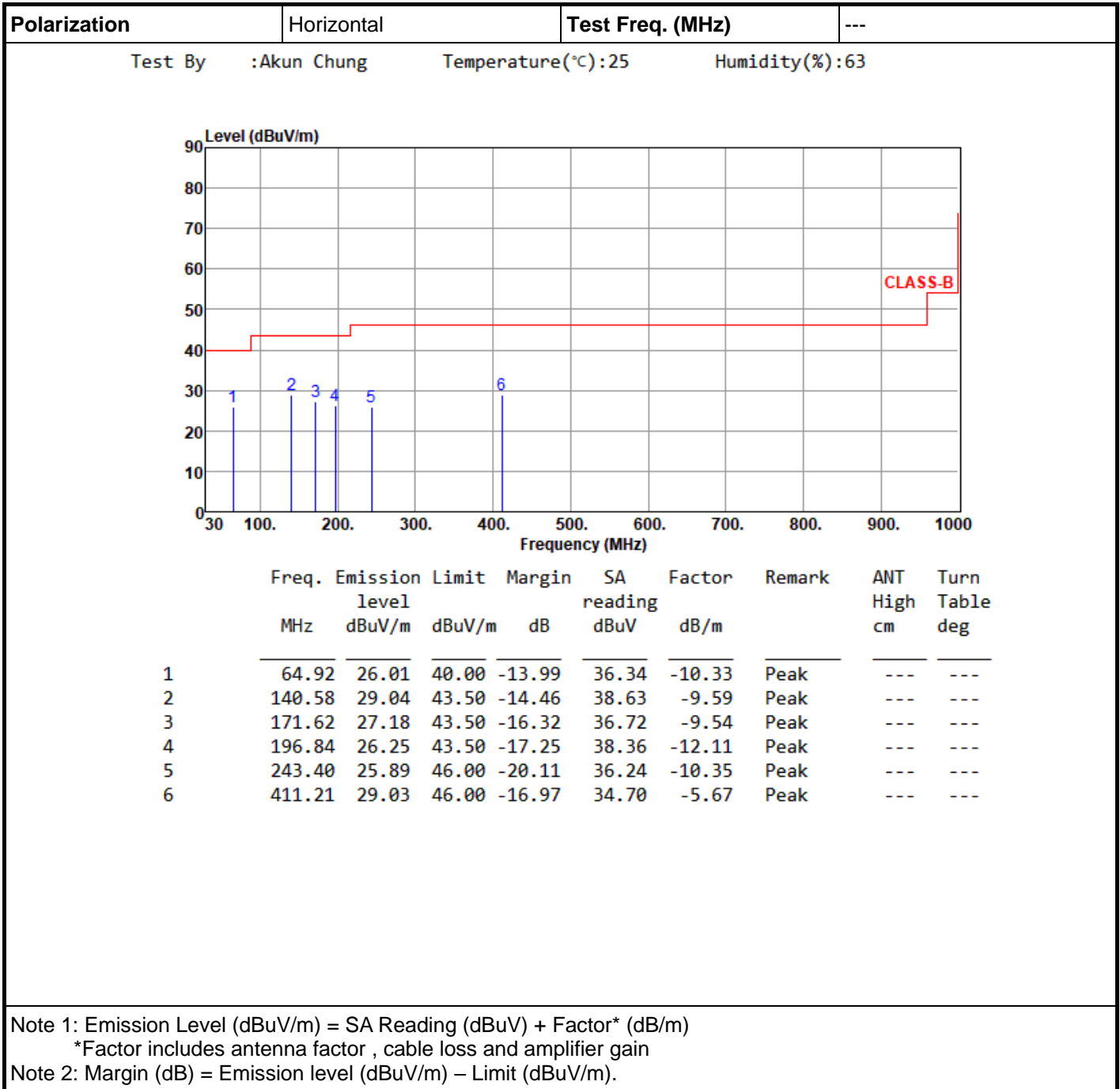



Polarization	Vertical	Test Freq. (MHz)	---
---------------------	----------	-------------------------	-----

Test By :Akun Chung Temperature(°C):25 Humidity(%):63

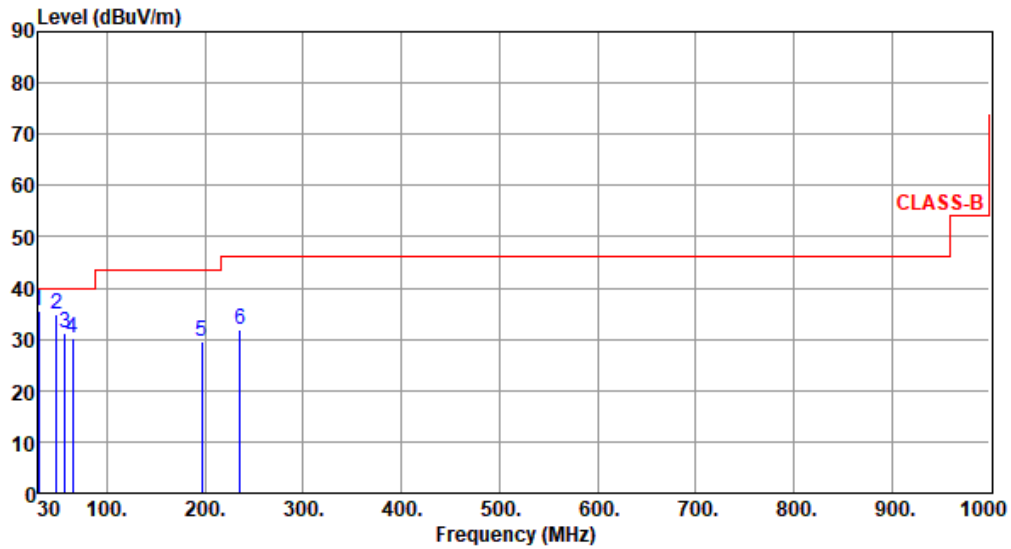

	Freq. MHz	Emission level dBuV/m	Limit dBuV/m	Margin dB	SA reading dBuV	Factor dB/m	Remark	ANT High cm	Turn Table deg
1	30.00	35.40	40.00	-4.60	45.56	-10.16	Peak	---	---
2	48.43	34.77	40.00	-5.23	43.35	-8.58	Peak	---	---
3	57.16	31.33	40.00	-8.67	40.35	-9.02	Peak	---	---
4	64.92	30.23	40.00	-9.77	40.56	-10.33	Peak	---	---
5	196.84	29.71	43.50	-13.79	41.82	-12.11	Peak	---	---
6	235.64	31.83	46.00	-14.17	42.71	-10.88	Peak	---	---

Note 1: Emission Level (dBuV/m) = SA Reading (dBuV) + Factor* (dB/m)

*Factor includes antenna factor , cable loss and amplifier gain

Note 2: Margin (dB) = Emission level (dBuV/m) – Limit (dBuV/m).



Configuration 2: Battery mode

Polarization	Horizontal		Test Freq. (MHz)	13.56					
Test By	:Brad Wu	Temperature(°C):24	Humidity(%):64						
<p>The graph plots Level (dBuV/m) on the y-axis (0 to 90) against Frequency (MHz) on the x-axis (30 to 1000). A red step function represents the CLASS-B limit, starting at 40 dBuV/m, stepping up to 43 dBuV/m at 100 MHz, 46 dBuV/m at 200 MHz, and 55 dBuV/m at 900 MHz. Six blue vertical lines indicate peak emissions at 51.34, 159.01, 273.47, 332.64, 364.65, and 433.52 MHz.</p>									
	Freq.	Emission level	Limit	Margin	SA reading	Factor	Remark	ANT High cm	Turn Table deg
	MHz	dBuV/m	dBuV/m	dB	dBuV	dB/m			
1	51.34	25.99	40.00	-14.01	34.53	-8.54	Peak	---	---
2	159.01	21.54	43.50	-21.96	30.25	-8.71	Peak	---	---
3	273.47	21.33	46.00	-24.67	30.60	-9.27	Peak	---	---
4	332.64	22.69	46.00	-23.31	30.26	-7.57	Peak	---	---
5	364.65	24.89	46.00	-21.11	32.12	-7.23	Peak	---	---
6	433.52	25.87	46.00	-20.13	30.84	-4.97	Peak	---	---

Note 1: Emission Level (dBuV/m) = SA Reading (dBuV) + Factor* (dB/m)

*Factor includes antenna factor , cable loss and amplifier gain

Note 2: Margin (dB) = Emission level (dBuV/m) – Limit (dBuV/m).



Polarization	Vertical	Test Freq. (MHz)	13.56
---------------------	----------	-------------------------	-------

Test By :Brad Wu Temperature(°C):24 Humidity(%):64

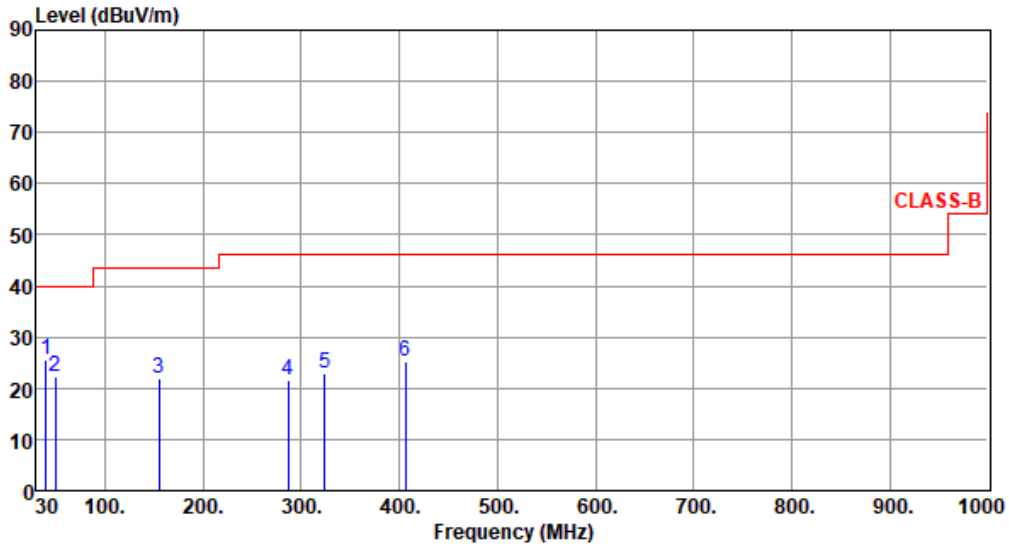

	Freq. MHz	Emission level dBuV/m	Limit dBuV/m	Margin dB	SA reading dBuV	Factor dB/m	Remark	ANT High cm	Turn Table deg
1	39.70	25.51	40.00	-14.49	35.05	-9.54	Peak	---	---
2	49.40	22.23	40.00	-17.77	30.80	-8.57	Peak	---	---
3	155.13	21.78	43.50	-21.72	30.43	-8.65	Peak	---	---
4	287.05	21.69	46.00	-24.31	30.52	-8.83	Peak	---	---
5	323.91	22.88	46.00	-23.12	30.67	-7.79	Peak	---	---
6	406.36	25.08	46.00	-20.92	30.85	-5.77	Peak	---	---

Note 1: Emission Level (dBuV/m) = SA Reading (dBuV) + Factor* (dB/m)

*Factor includes antenna factor , cable loss and amplifier gain

Note 2: Margin (dB) = Emission level (dBuV/m) – Limit (dBuV/m).



Frequency: 13.56 MHz	Frequency Drift (ppm)			
	0 minute	2 minutes	5 minutes	10 minutes
T20°C Vmax	-4.72	-5.16	-5.90	-5.16
T20°C Vmin	-4.72	-5.90	-4.94	-5.90
T55°C Vnom	-5.90	-4.42	-5.16	-3.69
T50°C Vnom	-5.16	-5.16	-3.69	-4.42
T40°C Vnom	-2.21	-3.69	-2.95	-3.69
T30°C Vnom	-2.95	-4.42	-3.69	-5.16
T20°C Vnom	-3.69	-5.16	-4.42	-5.90
T10°C Vnom	0.74	1.47	1.47	2.21
T0°C Vnom	2.21	2.95	1.47	1.47
T-10°C Vnom	5.90	4.42	5.16	4.42
Vnom [V]: 3.83	Vmax [V]: 4.4		Vmin [V]: 3.6	
Tnom [°C]: 20	Tmax [°C]: 55		Tmin [°C]: -10	



Modulation	Charging
Power Phase	Line

Test by : Joe Liao Temperature: 26°C Humidity: 62%

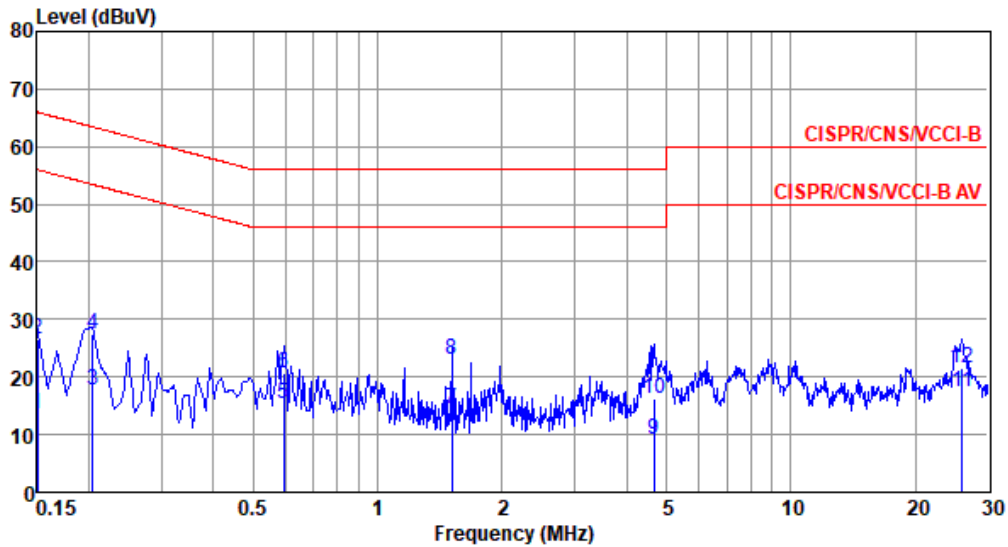

	Freq MHz	Level dBuV	Limit Line dBuV	Over Limit dB	Read Level dBuV	Factor dB	Cable loss dB	Aux dB	Remark
1	0.150	13.66	56.00	-42.34	3.70	9.68	0.08	0.20	Average
2	0.150	26.54	66.00	-39.46	16.58	9.68	0.08	0.20	QP
3	0.204	17.76	53.45	-35.69	7.78	9.68	0.08	0.22	Average
4	0.204	27.60	63.45	-35.85	17.62	9.68	0.08	0.22	QP
5*	0.592	15.49	46.00	-30.51	5.35	9.67	0.11	0.36	Average
6	0.592	20.65	56.00	-35.35	10.51	9.67	0.11	0.36	QP
7	1.511	14.60	46.00	-31.40	4.35	9.69	0.18	0.38	Average
8	1.511	22.96	56.00	-33.04	12.71	9.69	0.18	0.38	QP
9	4.672	9.12	46.00	-36.88	-1.26	9.71	0.25	0.42	Average
10	4.672	16.36	56.00	-39.64	5.98	9.71	0.25	0.42	QP
11	26.001	17.42	50.00	-32.58	6.30	9.69	0.71	0.72	Average
12	26.001	21.60	60.00	-38.40	10.48	9.69	0.71	0.72	QP

Note 1: Level (dBuV) = Read Level (dBuV) + LISN Factor (dB) + Cable Loss (dB) + Aux (dB).
 Note 2: Over Limit (dB) = Level (dBuV) - Limit Line (dBuV).



Modulation	Charging
Power Phase	Neutral

Test by : Joe Liao Temperature: 26°C Humidity: 62%

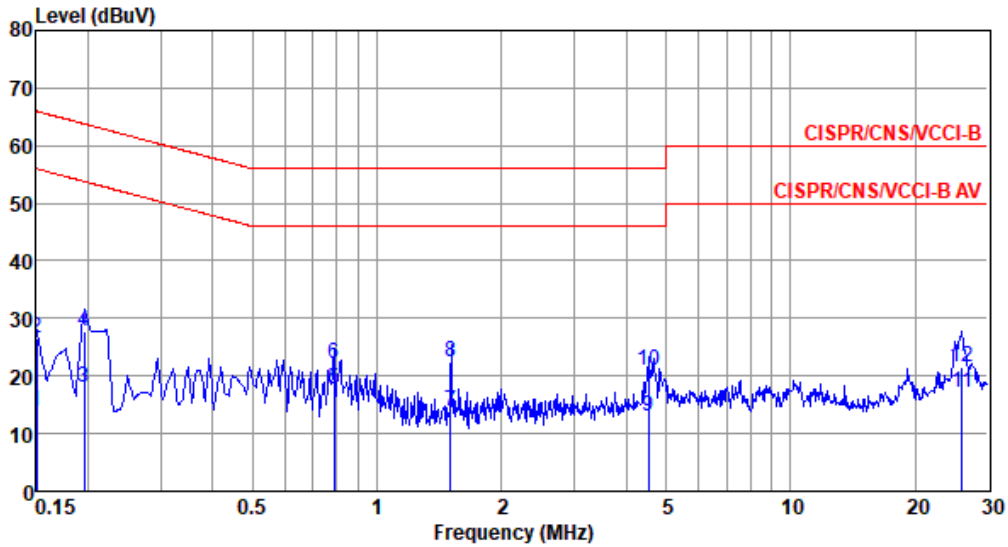

	Freq MHz	Level dBuV	Limit Line dBuV	Over Limit dB	Read Level dBuV	Factor dB	Cable loss dB	Aux dB	Remark
1	0.150	13.98	56.00	-42.02	4.13	9.61	0.08	0.16	Average
2	0.150	26.52	66.00	-39.48	16.67	9.61	0.08	0.16	QP
3	0.195	18.12	53.80	-35.68	8.25	9.61	0.08	0.18	Average
4	0.195	27.67	63.80	-36.13	17.80	9.61	0.08	0.18	QP
5*	0.788	17.62	46.00	-28.38	7.61	9.61	0.14	0.26	Average
6	0.788	22.15	56.00	-33.85	12.14	9.61	0.14	0.26	QP
7	1.508	13.76	46.00	-32.24	3.67	9.62	0.18	0.29	Average
8	1.508	22.41	56.00	-33.59	12.32	9.62	0.18	0.29	QP
9	4.525	13.12	46.00	-32.88	2.89	9.65	0.24	0.34	Average
10	4.525	20.85	56.00	-35.15	10.62	9.65	0.24	0.34	QP
11	26.001	17.16	50.00	-32.84	6.08	9.78	0.71	0.59	Average
12	26.001	21.53	60.00	-38.47	10.45	9.78	0.71	0.59	QP

Note 1: Level (dBuV) = Read Level (dBuV) + LISN Factor (dB) + Cable Loss (dB) + Aux (dB).
 Note 2: Over Limit (dB) = Level (dBuV) – Limit Line (dBuV).