

**Rogers Labs, a division of The Compatibility Center LLC**

7915 Nieman Rd.  
Lenexa, KS 66214  
Phone / Fax (913) 660-0666

Unlicensed National Information Infrastructure (U-NII)  
and License-Exempt Local Area Network (LE-LAN)

Devices, 47CFR, Part 15E (15.407)

Industry Canada RSS-247 Issue 3

Application For Grant of Certification

Model: B04450

Frequency Range: 5180-5240, and 5745-5825 MHz

License-Exempt U-NII, Local Area Network equipment, U-NII-1, and U-NII-3 operation

FCC ID: IPH-B4450

IC: 1792A-B4450

**Garmin International, Inc.**

1200 East 151st Street


Olathe, KS 66062

Tim Olson

Senior Compliance Engineer

Test Report Number: 240102

Test Date: January 2, 2024

Authorized Signatory: 

Patrick Powell

Rogers Labs, a division of The Compatibility Center LLC

FCC Designation: US5305

ISED Registration: 3041A

This report shall not be reproduced except in full, without the written approval of the laboratory.

This report must not be used by the client to claim product certification, approval, or endorsement by NVLAP, NIST, or any agency of the U.S. Government.

**TABLE OF CONTENTS..... 2**

**REVISIONS..... 5**

**EXECUTIVE SUMMARY ..... 6**

**OPINION / INTERPRETATION OF RESULTS ..... 7**

**EQUIPMENT TESTED..... 8**

**Equipment Operational Modes.....9**

**Equipment Function .....10**

**Equipment Configuration.....11**

**APPLICANT COMPANY INFORMATION ..... 12**

**EQUIPMENT INFORMATION..... 12**

**Product Details .....13**

**Antenna and Bandwidth.....13**

**APPLICATION FOR CERTIFICATION..... 14**

**APPLICABLE STANDARDS & TEST PROCEDURES ..... 15**

**TESTING PROCEDURES ..... 15**

**AC Line Conducted Emission Test Procedure .....15**

**Radiated Emission Procedure .....15**

**Antenna Port Conducted Emission Test Procedure.....15**

**Diagram 1 Test arrangement for power-line conducted emissions.....17**

**Diagram 2 Test arrangement for radiated emissions of tabletop equipment.....18**

**Diagram 3 Test arrangement for radiated emissions tested in Semi-Anechoic Chamber (SAC) and Outdoor Area Test Site (OATS) .....19**

**Diagram 4 Test arrangement for Antenna Port Conducted emissions.....20**

**TEST SITE LOCATIONS ..... 20**

**UNITS OF MEASUREMENTS ..... 21**

**ENVIRONMENTAL CONDITIONS..... 21**

**STATEMENT OF MODIFICATIONS AND DEVIATIONS ..... 22**

**INTENTIONAL RADIATORS..... 22**

**Antenna Requirements .....22**

**Restricted Bands of Operation.....22**

        Table 1 Harmonic Radiated Emissions in Restricted Bands Data Mode 8 U-NII-1 (802.11a).....23

        Table 2 Harmonic Radiated Emissions in Restricted Bands Data Mode 9 U-NII-1 (802.11n) .....24

        Table 3 Harmonic Radiated Emissions in Restricted Bands Data Mode 10 U-NII-1 (802.11n40) .....25

        Table 4 Harmonic Radiated Emissions in Restricted Bands Data Mode 11 U-NII-1 (802.11ac80).....25

        Table 5 Harmonic Radiated Emissions in Restricted Bands Data Mode 9 U-NII-3 (802.11a).....26

        Table 6 Harmonic Radiated Emissions in Restricted Bands Data Mode 10 U-NII-3 (802.11n) .....26

        Table 7 Harmonic Radiated Emissions in Restricted Bands Data Mode 11 U-NII-3 (802.11n40) .....27

        Table 8 Harmonic Radiated Emissions in Restricted Bands Data Mode 12 U-NII-3 (802.11ac80).....27

        Summary of Results for Radiated Emissions in Restricted Bands .....27

**AC Line Conducted EMI Procedure .....28**

        Figure 1 AC Line Conducted Emissions Data L1 (#2, EUT – Computer) .....29

        Figure 2 AC Line Conducted Emissions Data L2 (#2, EUT – Computer) .....30

        Table 9 AC Line Conducted Emissions Data L1 (#2, EUT – Computer).....31

        Table 10 AC Line Conducted Emissions Data L2 (#2, EUT – Computer).....31

        Summary of Results for AC Line Conducted Emissions.....31

**General Radiated Emissions Procedure.....32**

        Table 11 General Radiated Emissions Data.....33

        Summary of Results for General Radiated Emissions.....33

**Operation in the 5150-5250 and 5725-5850 MHz Frequency U-NII-1 and U-NII-3 Bands .....34**

        Figure 3 Plot of Transmitter Emissions Across 5150-5250 MHz Mode 8 U-NII-1 (802.11a) .....38

        Figure 4 Plot of Transmitter Emissions Across 5150-5250 MHz Mode 9 U-NII-1 (802.11n) .....39

        Figure 5 Plot of Transmitter Emissions Across 5150-5250 MHz Mode 10 U-NII-1 (802.11n40) .....40

        Figure 6 Plot of Transmitter Emissions Across 5150-5250 MHz Mode 11 U-NII-1 (802.11ac80).....41

Figure 7 Plot of Transmitter Emissions Across 5725-5850 MHz Mode 9 U-NII-3 (802.11a) .....42

Figure 8 Plot of Transmitter Emissions Across 5725-5850 MHz Mode 10 U-NII-3 (802.11n).....43

Figure 9 Plot of Transmitter Emissions Across 5725-5850 MHz Mode 11 U-NII-3 (802.11n40).....44

Figure 10 Plot of Transmitter Emissions Across 5725-5850 MHz Mode 12 U-NII-3 (802.11ac80) .....45

Figure 11 Plot of Lower Band Edge Across 5150-5250 MHz Mode 8 U-NII-1 (802.11a).....46

Figure 12 Plot of Lower Band Edge Across 5150-5250 MHz Mode 9 U-NII-1 (802.11n).....47

Figure 13 Plot of Lower Band Edge Across 5150-5250 MHz Mode 10 U-NII-1 (802.11n40).....48

Figure 14 Plot of Lower Band Edge Across 5150-5250 MHz Mode 11 U-NII-1 (802.11ac80).....49

Figure 15 Plot of Lower Band Edge Across 5725-5850 MHz Mode 12 U-NII-3 (802.11a).....50

Figure 16 Plot of Lower Band Edge Across 5725-5850 MHz Mode 13 U-NII-3 (802.11n).....51

Figure 17 Plot of Lower Band Edge Across 5725-5850 MHz Mode 14 U-NII-3 (802.11n40).....52

Figure 18 Plot of Lower Band Edge Across 5725-5850 MHz Mode 15 U-NII-3 (802.11ac80).....53

Figure 19 Plot of Upper Band Edge Across 5150-5250 MHz Mode 8 U-NII-1 (802.11a).....54

Figure 20 Plot of Upper Band Edge Across 5150-5250 MHz Mode 9 U-NII-1 (802.11n) .....55

Figure 21 Plot of Upper Band Edge Across 5150-5250 MHz Mode 10 U-NII-1 (802.11n40) .....56

Figure 22 Plot of Upper Band Edge Across 5150-5250 MHz Mode 11 U-NII-1 (802.11ac80).....57

Figure 23 Plot of Upper Band Edge Across 5725-5850 MHz Mode 12 U-NII-3 (802.11a).....58

Figure 24 Plot of Upper Band Edge Across 5725-5850 MHz Mode 13 U-NII-3 (802.11n) .....59

Figure 25 Plot of Upper Band Edge Across 5725-5850 MHz Mode 14 U-NII-3 (802.11n40) .....60

Figure 26 Plot of Upper Band Edge Across 5725-5850 MHz Mode 15 U-NII-3 (802.11ac80).....61

Figure 27 Plot of 26-dB Occupied Bandwidth 5150-5250 MHz Mode 8 U-NII-1 (802.11a).....62

Figure 28 Plot of 26-dB Occupied Bandwidth 5150-5250 MHz Mode 9 U-NII-1 (802.11n) .....63

Figure 29 Plot of 26-dB Occupied Bandwidth 5150-5250 MHz Mode 10 U-NII-1 (802.11n40) .....64

Figure 30 Plot of 26-dB Occupied Bandwidth 5150-5250 MHz Mode 11 U-NII-1 (802.11ac80).....65

Figure 31 Plot of 26-dB Occupied Bandwidth 5725-5850 MHz Mode 12 U-NII-3 (802.11a).....66

Figure 32 Plot of 26-dB Occupied Bandwidth 5725-5850 MHz Mode 13 U-NII-3 (802.11n) .....67

Figure 33 Plot of 26-dB Occupied Bandwidth 5725-5850 MHz Mode 14 U-NII-3 (802.11n40) .....68

Figure 34 Plot of 26-dB Occupied Bandwidth 5725-5850 MHz Mode 15 U-NII-3 (802.11ac80).....69

Figure 35 Plot of 99% Occupied Bandwidth 5150-5250 MHz Mode 8 U-NII-1 (802.11a) .....70

Figure 36 Plot of 99% Occupied Bandwidth 5150-5250 MHz Mode 9 U-NII-1 (802.11n).....71

Figure 37 Plot of 99% Occupied Bandwidth 5150-5250 MHz Mode 10 U-NII-1 (802.11n40).....72

Figure 38 Plot of 99% Occupied Bandwidth 5150-5250 MHz Mode 11 U-NII-1 (802.11ac80).....73

Figure 39 Plot of 99% Occupied Bandwidth 5725-5850 MHz Mode 12 U-NII-3 (802.11a) .....74

Figure 40 Plot of 99% Occupied Bandwidth 5725-5850 MHz Mode 13 U-NII-3 (802.11n).....75

Figure 41 Plot of 99% Occupied Bandwidth 5725-5850 MHz Mode 14 U-NII-3 (802.11n40).....76

Figure 42 Plot of 99% Occupied Bandwidth 5725-5850 MHz Mode 15 U-NII-3 (802.11ac80).....77

Figure 43 Plot of 6-dB Occupied Bandwidth 5725-5850 MHz Mode 12 U-NII-3 (802.11a).....78

Figure 44 Plot of 6-dB Occupied Bandwidth 5725-5850 MHz Mode 13 U-NII-3 (802.11n) ..... 79

Figure 45 Plot of 6-dB Occupied Bandwidth 5725-5850 MHz Mode 14 U-NII-3 (802.11n40) ..... 80

Figure 46 Plot of 6-dB Occupied Bandwidth 5725-5850 MHz Mode 15 U-NII-3 (802.11ac80)..... 81

**Transmitter Emissions Data..... 82**

Table 12 Transmitter Radiated Emission 5150-5250 MHz Band, Mode 8 U-NII-1 (802.11a) ..... 82

Table 13 Transmitter Radiated Emission 5150-5250 MHz Band, Mode 9 U-NII-1 (802.11n)..... 83

Table 14 Transmitter Radiated Emission 5150-5250 MHz Band, Mode 10 U-NII-1 (802.11n40) ..... 84

Table 15 Transmitter Radiated Emission 5150-5250 MHz Band, Mode 11 U-NII-1 (802.11ac80)..... 85

Table 16 Transmitter Radiated Emission 5725-5850 MHz Band, Mode 12 U-NII-3 (802.11a) ..... 86

Table 17 Transmitter Radiated Emission 5725-5850 MHz Band, Mode 13 U-NII-3 (802.11n) ..... 87

Table 18 Transmitter Radiated Emission 5725-5850 MHz Band, Mode 14 U-NII-3 (802.11n40) ..... 88

Table 20 Transmitter Radiated Emission 5725-5850 MHz Band, Mode 15 U-NII-3 (802.11ac80)..... 89

Table 21 Transmitter Antenna Port Data Modes 8-11 (U-NII-1) ..... 90

Table 22 Transmitter Antenna Port Data Modes 9-12 (U-NII-3) ..... 91

Summary of Results for Transmitter Radiated Emissions of Intentional Radiator ..... 91

**ANNEX..... 92**

**Annex A Measurement Uncertainty Calculations..... 93**

**Annex B Test Equipment..... 94**

**Annex C Laboratory Certificate of Accreditation..... 96**

## Revisions

Revision 1 – issued May 28, 2024

## Executive Summary

The following information is submitted for consideration in obtaining Equipment Grants of Certification for License Exempt, Unlicensed National Information Infrastructure (U-NII) Intentional Radiator operating under 47 CFR Paragraph 15E (15.407), U-NII-1 and U-NII-3 new rules, 5180-5240, and 5745-5825 MHz bands, and Industry Canada RSS-GEN Issue 5, and RSS-247 Issue 3, LE-LAN transmitter.

Name of Applicant: Garmin International, Inc.  
 1200 East 151st Street  
 Olathe, KS 66062

M/N: B04450 HVIN: B04450

FCC ID: IPH-B4450 Industry Canada ID: 1792A-B4450

Frequency Range: 5180-5240 MHz and 5745-5825 MHz (U-NII-1 and U-NII-3 under new rules 15.407, 802.11a/n/n40/ac80) and limited transmitter operations per regulations for operation in Canada

Mode	Channel width	Average Conducted Power (W)	Average e.i.r.p. Power (W)	99% OBW (kHz)
Mode 8, U-NII-1a	20 MHz mode	0.011	0.043	17,190.0
Mode 9, U-NII-1n	20 MHz mode	0.009	0.037	18,250.0
Mode 10, U-NII-1n40	40 MHz mode	0.008	0.031	36,850.0
Mode 11, U-NII-1ac80	80 MHz mode	0.007	0.028	76,050.0
Mode 12, U-NII-3a	20 MHz mode	0.036	0.091	17,650.0
Mode 13, U-NII-3n	20 MHz mode	0.035	0.088	18,562.5
Mode 14, U-NII-3n40	40 MHz mode	0.033	0.084	37,400.0
Mode 15, U-NII-3ac80	80 MHz mode	0.024	0.060	76,400.0

This report addresses EUT Operations as U-NII transmitter using modulations defined above in modes 8 through 15.

## Opinion / Interpretation of Results

Tests Performed	Margin (dB)	Results
Restricted Frequency Bands 15.205, RSS-GEN 8.10	-4.1	Complies
AC Line Conducted 15.207, RSS-GEN 7.2.4	-14.13	Complies
Radiated Emissions 15.209, RSS-GEN 7.2.5	-6.3	Complies
Harmonic Emissions per 15.407, RSS-247	-5.3	Complies



# Equipment Tested

Model: B04450

Garmin International, Inc.  
1200 East 151st Street  
Olathe, KS 66062

<u>Equipment</u>	<u>Model / PN</u>	<u>Serial Number</u>
EUT Tx #1 NA Radiated	B04450	8BR000030
EUT #2 NA Antenna Port Conducted	B04450	8BR000001
USB Cable	320-01545-00	N/A
USB Cable	320-01563-00	N/A
USB Cable	320-01563-10	N/A
CLA	013-00797-13	N/A
CLA	013-00970-00	N/A
CLA	013-00970-10	N/A
Laptop Computer	Latitude 7480	EFSPSN2
USB Printer	Dell 0N5819	5D1SL61

Test results in this report relate only to the items tested. Worst-case configuration data recorded in this report.

The design may operate one transmitter chain at a time and is not capable of simultaneous transmission on more than one port.

Software (FVIN): 0.73 or higher; Antennas: 2.4 GHz PIFA (3.0 dBi), 5.1 GHz PIFA (6.0 dBi), 5.7 GHz PIFA (4.0 dBi)



### Equipment Operational Modes

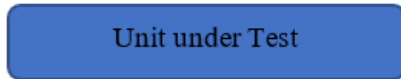
Mode	Transmitter Operation
1	BT BR (GFSK)
2	BT (2EDR $\pi/4$ DQPSK)
3	BT (3EDR 8DPSK)
4	BT BLE (GMSK)
5	802.11b
6	802.11g
7	802.11n
8	U-NII-1 802.11a
9	U-NII-1 802.11n
10	U-NII-1 802.11n40
11	U-NII-1 802.11ac80
12	U-NII-3 802.11a
13	U-NII-3 802.11n
14	U-NII-3 802.11n40
15	U-NII-3 802.11ac80

## **Equipment Function**

The EUT is a GPS receiver, graphical display, incorporated video camera, and user interface unit providing GPS reception, graphical display of location, navigation, and other information for the user. The design incorporates transmitter circuitry operating in the 2402-2480, 5150-5250, and 5725-5850 MHz frequency bands. The product operates from internal battery or external direct current power provided over the micro USB interface port. Power is provided through compatible USB interface cable options and power sources. The design provides a Micro SD Card slot and USB-C interface port as presented below and wireless communications with compatible equipment. The EUT was arranged as described by the manufacturer emulating typical user configurations for testing purposes. The EUT offers no other interface connections than those presented in the configuration options as described by the manufacturer and presented below. During testing, the test system was configured to operate in a manufacturer defined mode. As requested by the manufacturer, the equipment was tested for emissions compliance using the available configurations with the worst-case data presented. Test results in this report relate only to the products described in this report.

### Equipment Configuration

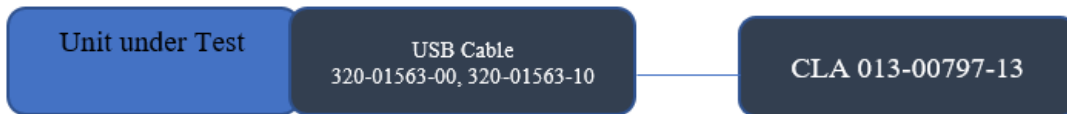
- 1) EUT operating off internal battery



- 2) EUT connected to Computer USB port through cable assembly.



- 3) EUT connected to DC Through USB cable connected to CLA.



- 4) EUT connected to DC Through USB cables connected to CLA.



## Applicant Company information

Applicants Company	Garmin International, Inc.
Applicants Address	1200 East 151st Street, Olathe, KS 66062
FCC Identifier	IPH-B4450
Industry Canada Identifier	1792A-B4450
Manufacturer Company	Garmin International, Inc.
Manufacturer Address	1200 East 151st Street, Olathe, KS 66062

## Equipment information

Hardware Version Identification Number (HVIN): The HVIN identifies hardware specifications of a product version. The HVIN replaces the ISED Model Number in the legacy E-filing System. An HVIN is required for all products for certification applications.	B04450
Host Marketing Name (HMN) (if applicable): The HMN is the name or model number of a final product, which contains a certified radio module.	B04450
Brand Name	
Model Number	B04450
Test Rule Part(s)	47 CFR 15E, 15.407, RSS-247
Test Frequency Range	5.15-5.25 and 5.725-5.85 GHz
Project Number	240102
Submission Type	FCC: Certification, IC: Certification

**Product Details**

Items	Description
Product Type	Single chain 5 GHz U-NII-1, and U-NII-3
Radio Type	Transceiver
Power Type	Internal Rechargeable Battery or External Direct Current
Frequency Range	5150-5250 MHz / 5725-5850 MHz
Channel Number	Channels 36, 38, 40, 42, 44, 46, 48, 149, 151, 153, 155, 157, 159, 161, 165
Carrier Frequencies	Please refer to 802.11 Standard for Carrier Frequencies
Antenna	Integrated 6.0 dBi antenna PIFA (5.1G) / 4.0 dBi antenna (5.7G)
Communication Mode	Device provides 5 GHz, U-NII 1 and U-NII-3 operation
Beamforming Function	Without beamforming
Operating Mode	5150-5250 MHz (U-NII-1) and 5725-5825 MHz (U-NII-3)

**Antenna and Bandwidth**

Antenna	Number of TX chains		
	20 MHz	40 MHz	80 MHz
IEEE 802.11a	Single Chain	N/A	N/A
IEEE 802.11n	Single Chain	Single Chain	N/A
IEEE 802.11ac	N/A	N/A	Single Chain

## Application for Certification

- (1) Manufacturer: Garmin International, Inc.  
1200 East 151st Street  
Olathe, KS 66062
- (2) Identification: HVIN: B04450  
FCC ID: IPH-B4450 IC: 1792A-B4450
- (3) Instruction Book:  
Refer to Exhibit for Instruction Manual.
- (4) Description of Circuit Functions:  
Refer to Exhibit of Operational Description.
- (5) Block Diagram with Frequencies:  
Refer to Exhibit of Operational Description.
- (6) Report of Measurements:  
Report of measurements follows in this Report.
- (7) Photographs: Construction, Component Placement, etc.:  
Refer to Exhibit for photographs of equipment.
- (8) List of Peripheral Equipment Necessary for operation. The equipment operates from internal battery power or external direct current power provided from authorized sources. The EUT provides USB-C interface port for power and communications as presented in this filing.
- (9) Transition Provisions of 47 CFR 15.37 are not requested.
- (10) Not Applicable. The unit is not a scanning receiver.
- (11) Not Applicable. The EUT does not operate in the 59 – 64 GHz frequency band.
- (12) The equipment is not software defined and this section is not applicable.
- (13) Applications for certification of U-NII devices in the 5.15-5.35 GHz and the 5.47-5.85 GHz bands must include a high-level operational description of the security procedures that control the radio frequency operating parameters and ensure that unauthorized modifications cannot be made. The required information has been provided in Operational Description Exhibit filed with the application.
- (14) Contain at least one drawing or photograph showing the test set-up for each of the required types of tests applicable to the device for which certification is requested. These drawings or photographs must show enough detail to confirm other information contained in the test report. Any photographs used must be focused originals without glare or dark spots and must clearly show the test configuration used. This information is provided in this report and Test Setup Exhibits provided with the application filing.

## Applicable Standards & Test Procedures

The following information is submitted in accordance with e-CFR dated February 15, 2024: Part 2, Subpart J, Part 15, Subpart 15E, Industry Canada RSS-GEN Issue 5, and RSS-247 Issue 3. Test procedures used are the established Methods of Measurement of Radio-Noise Emissions as described in ANSI C63.10-2013, KDB 789033 D02 General UNII Test Procedures New Rules v02r01, KDB 926956 v02, RSS-247 Issue 3, and RSS-GEN Issue 5.

## Testing Procedures

### ***AC Line Conducted Emission Test Procedure***

Testing for the AC line-conducted emissions were performed as required in CFR47 15B, RSS-GEN, and directed in ANSI C63.4-2014. The test setup, including the EUT, was arranged in the test configurations as presented during testing. The test configuration was placed on a 1 x 1.5-meter bench, 0.8 meters high located in a screen room. The power lines of the system were isolated from the power source using a standard LISN with a 50- $\mu$ Hy choke. EMI was coupled to the spectrum analyzer through a 0.1  $\mu$ F capacitor internal to the LISN. The LISN was positioned on the floor beneath the wooden bench supporting the EUT. The power lines and cables were draped over the back edge of the table. Refer to diagram one showing typical test arrangement and photographs in the test setup exhibit for EUT placement used during testing.

### ***Radiated Emission Procedure***

Radiated emissions testing was performed as required in 47CFR 15C, RSS-247 Issue 3, RSS-GEN and specified in ANSI C63.10-2013. The EUT was placed on a rotating 0.9 x 1.2-meter platform, elevated as required above the ground plane at a distance of 3 meters from the FSM antenna. EMI energy was maximized by equipment placement permitting orientation in three orthogonal axes, raising, and lowering the FSM antenna, changing the antenna polarization, and by rotating the turntable. Each emission was maximized before data was taken and recorded. The frequency spectrum from 9 kHz to 25,000 MHz was searched for emissions during preliminary investigation. Refer to diagrams two and three showing typical test setup. Refer to photographs in the test setup exhibits for specific EUT placement during testing.

### ***Antenna Port Conducted Emission Test Procedure***

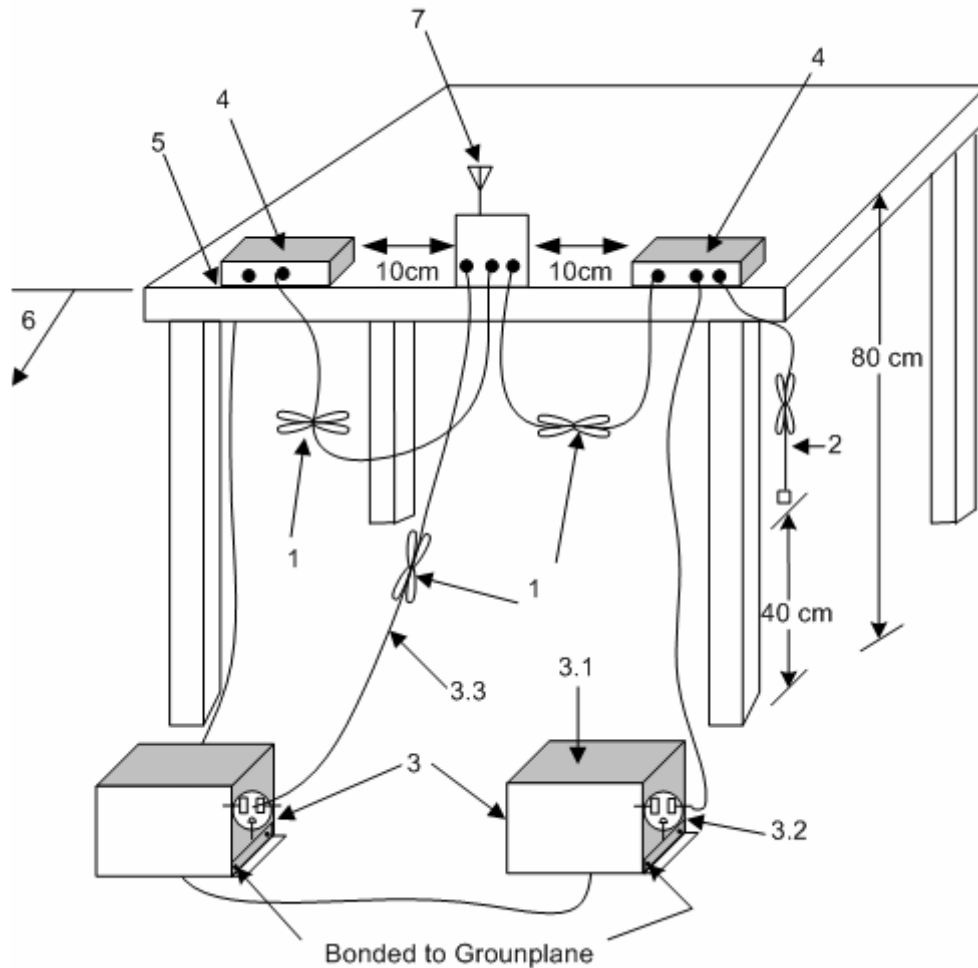
The EUT was assembled as required for operation placed on a benchtop. This configuration provided the ability to connect test equipment to the provided test antenna port



conducted emissions testing was performed presented in the regulations and specified in ANSI C63.10-2013. Testing was completed on a laboratory bench in a shielded room. The active antenna port of the device was connected to appropriate attenuation and the spectrum analyzer. Refer to diagram 4 showing typical test arrangement and photographs in the test setup exhibits for specific EUT placement during testing.

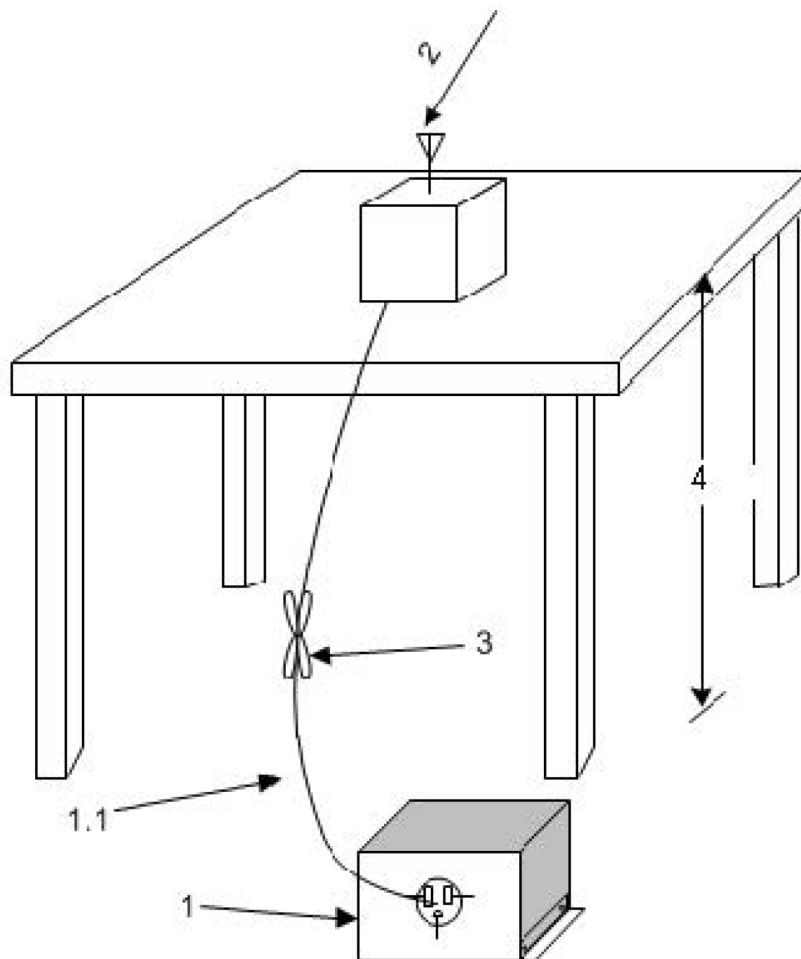


**Diagram 1 Test arrangement for power-line conducted emissions**



1. Interconnecting cables that hang closer than 40 cm to the ground plane shall be folded back and forth in the center forming a bundle 30 cm to 40 cm long see (see 6.2.3.1).
2. I/O cables that are not connected to an accessory shall be bundled in the center. The end of the cable may be terminated, if required, using the correct terminating impedance. The overall length shall not exceed 1 m (see 6.2.2).
3. EUT connected to one LISN. Unused LISN measuring port connectors shall be terminated in 50  $\Omega$  loads. LISN can be placed on top of, or immediately beneath, reference ground plane (see 6.2.2 and 6.2.3).
  - 3.1 All other equipment powered from additional LISN(s).
  - 3.2 Multiple-outlet strip can be used for multiple power cords of non-EUT equipment.
  - 3.3 LISN at least 80 cm from nearest part of EUT chassis.
4. Non-EUT components of EUT system being tested.
5. Rear of EUT, including peripherals, shall all be aligned and flush with rear of tabletop (see 6.2.3.1).
6. Edge of tabletop shall be 40 cm removed from a vertical conducting plane that is bonded to the ground plane (see 6.2.2 for options).
7. Antenna may be integral or detachable. If detachable, the antenna shall be attached for this test

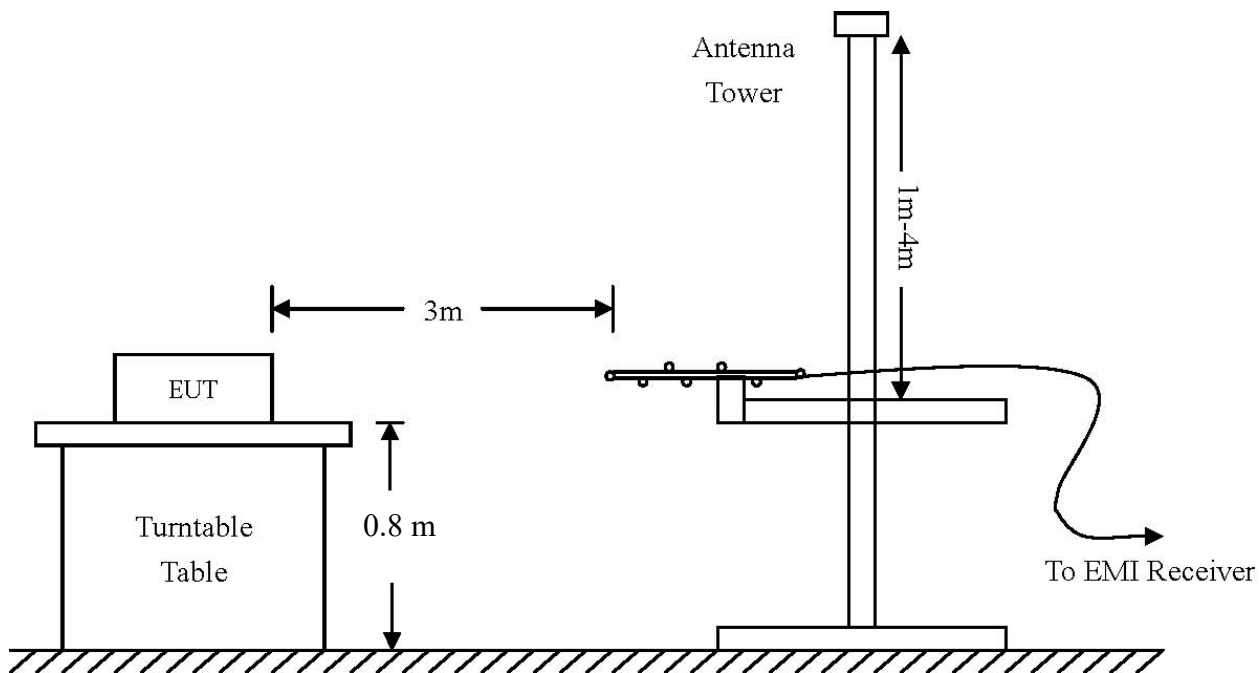
**Diagram 2 Test arrangement for radiated emissions of tabletop equipment**



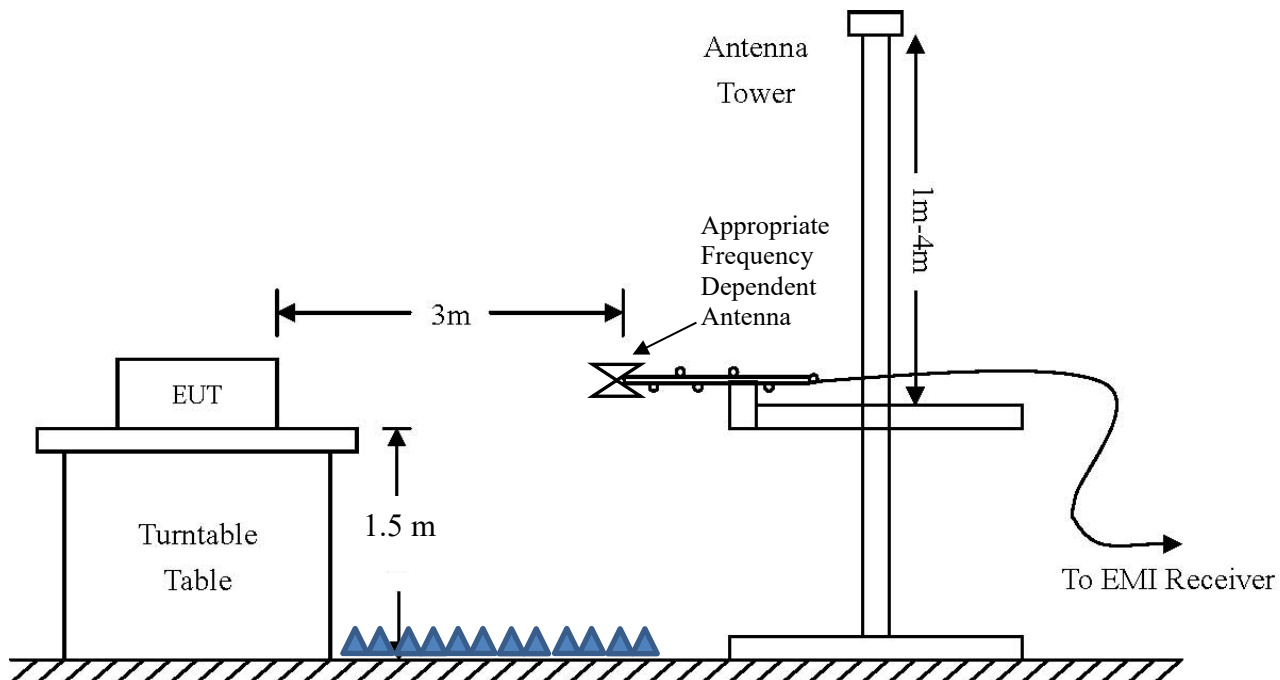
1. A LISN is optional for radiated measurements between 30 MHz and 1000 MHz but not allowed for measurements below 30 MHz and above 1000 MHz (see 6.3.1). If used, then connect EUT to one LISN. Unused LISN measuring port connectors shall be terminated in 50  $\Omega$  loads. The LISN may be placed on top of, or immediately beneath, the reference ground plane (see 6.2.2 and 6.2.3.2).
  - 1.1. LISN spaced at least 80 cm from the nearest part of the EUT chassis.
2. Antenna can be integral or detachable, depending on the EUT (see 6.3.1).
3. Interconnecting cables that hang closer than 40 cm to the ground plane shall be folded back and forth in the center forming a bundle 30 cm to 40 cm long (see 6.3.1).
4. For emission measurements at or below 1 GHz, the table height shall be 80 cm. For emission measurements above 1 GHz, the table height shall be 1.5 m for measurements, except as otherwise specified (see 6.3.1 and 6.6.3.1).

**Diagram 3 Test arrangement for radiated emissions tested in Semi-Anechoic Chamber (SAC) and Outdoor Area Test Site (OATS)**

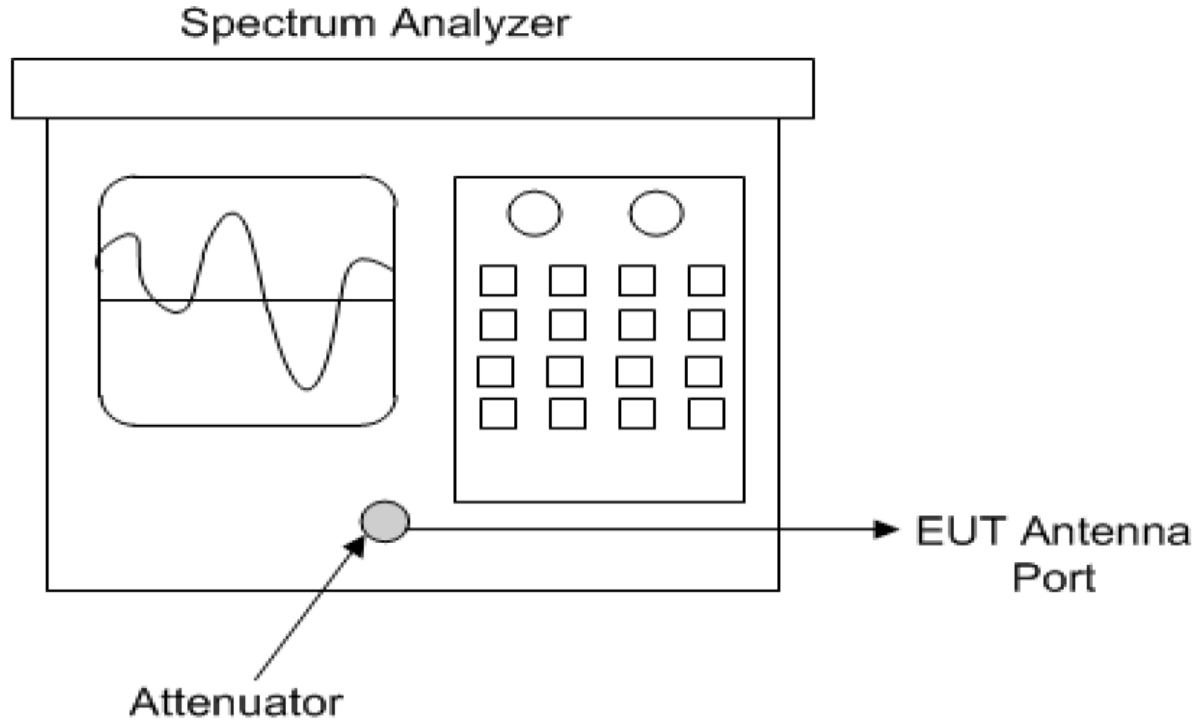
Below 1 GHz



Above 1 GHz:



**Diagram 4 Test arrangement for Antenna Port Conducted emissions**



**Test Site Locations**

**Conducted EMI** AC line conducted emissions testing performed in a shielded screen room located at Rogers Labs, a division of The Compatibility Center LLC, 7915 Nieman Rd., Lenexa, KS (or satellite location).

**Antenna port** Antenna port conducted emissions testing was performed in a shielded screen room located at Rogers Labs, a division of The Compatibility Center LLC, 7915 Nieman Rd., Lenexa, KS (or satellite location).

**Radiated EMI** The radiated emissions tests were performed at the 3 meters Semi-Anechoic Chamber (SAC) located at Rogers Labs, a division of The Compatibility Center LLC, 7915 Nieman Rd., Lenexa, KS or at the 3 meters Outdoor Area Test Site (OATS) in the satellite location.

Registered Site information: FCC Site: US5305, ISED: 3041A, CAB Identifier: US0096

NVLAP Accreditation Lab code 200087-0

## Units of Measurements

Conducted EMI            Data presented in dBμV; dB referenced to one microvolt

Antenna port Conducted        Data is in dBm; dB referenced to one milliwatt

Radiated EMI            Data presented in dBμV/m; dB referenced to one microvolt per meter

Note: The limit is expressed for a measurement in dBμV/m when the measurement is taken at a distance of 3 or 10 meters. Data taken for this report was taken at distance of 3 meters. Sample calculation demonstrates corrected field strength reading for Semi-Anechoic Chamber using the measurement reading and correcting for receive antenna factor, cable losses, and amplifier gains.

### Sample Calculation:

RFS = Radiated Field Strength, FSM = Field Strength Measured

A.F. = Receive antenna factor, Losses = attenuators/cable losses, Gain = amplification gains

$RFS (dB\mu V/m @ 3m) = FSM (dB\mu V) + A.F. (dB/m) + Losses (dB) - Gain (dB)$

Frequency: 9 kHz-30 MHz	Frequency: 30 MHz- 1 GHZ	Frequency: Above 1 GHz
Loop Antenna	Broadband Biconilog	Horn
RBW = 9 kHz	RBW = 120 kHz	RBW = 1 MHz
VBW = 30 kHz	VBW = 500 kHz	VBW = 3 MHz
Sweep time = Auto	Sweep time = Auto	Sweep time = Auto
Detector = PK, QP	Detector = PK, QP	Detector = PK, AV
Antenna Height 1m	Antenna Height 1-4m	Antenna Height 1-4m

## Environmental Conditions

Ambient Temperature        19.9° C

Relative Humidity            54.0 %

Atmospheric Pressure        1012.5 mb

## Statement of Modifications and Deviations

No modifications to the EUT were required for the unit to demonstrate compliance with the 47 CFR Part 15E, RSS-Gen, and RSS-247 Issue 3, and RSS-GEN Issue 5 emission requirements. There were no deviations to the specifications.

## Intentional Radiators

### *Antenna Requirements*

The EUT incorporates integral antenna system and offers no provision for connection to alternate antenna system. The antenna connection point complies with the unique antenna connection requirements. There are no deviations or exceptions to the specification.

### *Restricted Bands of Operation*

Spurious emissions falling in the restricted frequency bands of operation were measured at the OATS or SAC. The EUT utilizes frequency, determining circuitry, which generates harmonics falling in the restricted bands. Emissions were investigated at the OATS or SAC, using appropriate antennas or pyramidal horns, amplification stages, and a spectrum analyzer. Peak and average amplitudes of frequencies above 1000 MHz were compared to the required limits with worst-case data presented below. Test procedures of ANSI C63.10-2013 were used during testing. No other significant emission was observed which fell into the restricted bands of operation. Computed emission values consider the received radiated field strength, receive antenna correction factor, amplifier gain stage, and test system cable losses.

**Table 1 Harmonic Radiated Emissions in Restricted Bands Data Mode 8 U-NII-1 (802.11a)**

Frequency in MHz	Horizontal Peak (dBμV/m)	Horizontal Average (dBμV/m)	Vertical Peak (dBμV/m)	Vertical Average (dBμV/m)	Limit @ 3m (dBμV/m)	Horizontal Margin (dB)	Vertical Margin (dB)
Mode 8 U-NII-1 (802.11a)							
5150.0	60.9	43.9	59.3	43.5	54.0	-10.1	-10.5
5350.0	56.9	42.6	57.1	42.8	54.0	-11.4	-11.2
15540.0	63.9	49.8	63.6	49.7	54.0	-4.2	-4.3
15600.0	63.5	49.8	64.0	49.7	54.0	-4.2	-4.3
15720.0	64.1	49.1	62.8	48.9	54.0	-4.9	-5.1
20720.0	57.5	43.9	58.0	44.0	54.0	-10.1	-10.0
20800.0	57.6	44.1	57.8	44.0	54.0	-9.9	-10.0
20960.0	58.0	44.3	58.4	44.4	54.0	-9.7	-9.6

Other emissions present had amplitudes at least 20 dB below the limit. Peak and Quasi-Peak amplitude emissions are recorded for frequency below 1000 MHz. Peak and Average amplitude emissions are recorded for frequency range above 1000 MHz.

**Table 2 Harmonic Radiated Emissions in Restricted Bands Data Mode 9 U-NII-1 (802.11n)**

Frequency in MHz	Horizontal Peak (dBμV/m)	Horizontal Average (dBμV/m)	Vertical Peak (dBμV/m)	Vertical Average (dBμV/m)	Limit @ 3m (dBμV/m)	Horizontal Margin (dB)	Vertical Margin (dB)
Mode 9 U-NII-1 (802.11n)							
5150.0	64.4	43.8	62.6	43.0	54.0	-10.2	-11.0
5350.0	56.1	42.4	56.1	42.3	54.0	-11.6	-11.7
15540.0	63.9	49.9	63.3	49.8	54.0	-4.1	-4.2
15600.0	63.4	49.8	63.3	49.9	54.0	-4.2	-4.1
15720.0	63.0	49.1	62.4	49.0	54.0	-4.9	-5.0
20720.0	57.1	44.0	57.7	44.0	54.0	-10.0	-10.0
20800.0	57.4	44.0	58.1	44.1	54.0	-10.0	-9.9
20960.0	58.5	44.4	58.5	44.3	54.0	-9.6	-9.7

Other emissions present had amplitudes at least 20 dB below the limit. Peak and Quasi-Peak amplitude emissions are recorded for frequency below 1000 MHz. Peak and Average amplitude emissions are recorded for frequency range above 1000 MHz.



**Table 3 Harmonic Radiated Emissions in Restricted Bands Data Mode 10 U-NII-1 (802.11n40)**

Frequency in MHz	Horizontal Peak (dBμV/m)	Horizontal Average (dBμV/m)	Vertical Peak (dBμV/m)	Vertical Average (dBμV/m)	Limit @ 3m (dBμV/m)	Horizontal Margin (dB)	Vertical Margin (dB)
Mode 10 U-NII-1 (802.11n40)							
5150.0	63.1	45.9	63.0	45.2	54.0	-8.1	-8.8
5350.0	56.9	42.8	57.7	42.7	54.0	-11.2	-11.3
15570.0	63.7	49.3	62.9	49.3	54.0	-4.7	-4.7
15690.0	62.3	48.6	62.4	48.7	54.0	-5.4	-5.3
20760.0	57.6	43.9	58.1	44.1	54.0	-10.1	-9.9
20920.0	58.1	44.3	57.6	44.2	54.0	-9.7	-9.8

Other emissions present had amplitudes at least 20 dB below the limit. Peak and Quasi-Peak amplitude emissions are recorded for frequency below 1000 MHz. Peak and Average amplitude emissions are recorded for frequency range above 1000 MHz.

**Table 4 Harmonic Radiated Emissions in Restricted Bands Data Mode 11 U-NII-1 (802.11ac80)**

Frequency in MHz	Horizontal Peak (dBμV/m)	Horizontal Average (dBμV/m)	Vertical Peak (dBμV/m)	Vertical Average (dBμV/m)	Limit @ 3m (dBμV/m)	Horizontal Margin (dB)	Vertical Margin (dB)
Mode 11 U-NII-1 (802.11ac80)							
5150.0	97.0	79.9	95.8	78.4	54.0	-51.4	-52.9
5350.0	58.5	44.8	58.1	44.6	54.0	-23.5	-23.7
15630.0	63.1	49.6	63.8	49.5	54.0	-18.7	-18.8
20840.0	58.1	44.3	59.0	44.3	54.0	-24.0	-24.0

Other emissions present had amplitudes at least 20 dB below the limit. Peak and Quasi-Peak amplitude emissions are recorded for frequency below 1000 MHz. Peak and Average amplitude emissions are recorded for frequency range above 1000 MHz.

**Table 5 Harmonic Radiated Emissions in Restricted Bands Data Mode 9 U-NII-3 (802.11a)**

Frequency in MHz	Horizontal Peak (dBµV/m)	Horizontal Average (dBµV/m)	Vertical Peak (dBµV/m)	Vertical Average (dBµV/m)	Limit @ 3m (dBµV/m)	Horizontal Margin (dB)	Vertical Margin (dB)
Mode 12 U-NII-3 (802.11a)							
11490	60.8	47.3	60.6	47.1	54.0	-6.7	-6.9
11570	61.2	48.0	61.8	47.9	54.0	-6.0	-6.1
11650	61.2	47.6	61.7	47.7	54.0	-6.4	-6.3
22980	58.7	45.4	58.8	45.4	54.0	-8.6	-8.6

Other emissions present had amplitudes at least 20 dB below the limit. Peak and Quasi-Peak amplitude emissions are recorded for frequency below 1000 MHz. Peak and Average amplitude emissions are recorded for frequency range above 1000 MHz.

**Table 6 Harmonic Radiated Emissions in Restricted Bands Data Mode 10 U-NII-3 (802.11n)**

Frequency in MHz	Horizontal Peak (dBµV/m)	Horizontal Average (dBµV/m)	Vertical Peak (dBµV/m)	Vertical Average (dBµV/m)	Limit @ 3m (dBµV/m)	Horizontal Margin (dB)	Vertical Margin (dB)
Mode 13 U-NII-3 (802.11n)							
11490	60.7	47.0	60.5	47.0	54.0	-7.0	-7.0
11570	61.6	47.8	61.9	48.0	54.0	-6.2	-6.0
11650	60.9	47.1	61.6	47.8	54.0	-6.9	-6.2
22980	59.5	45.3	59.2	45.2	54.0	-8.7	-8.8

Other emissions present had amplitudes at least 20 dB below the limit. Peak and Quasi-Peak amplitude emissions are recorded for frequency below 1000 MHz. Peak and Average amplitude emissions are recorded for frequency range above 1000 MHz.

**Table 7 Harmonic Radiated Emissions in Restricted Bands Data Mode 11 U-NII-3 (802.11n40)**

Frequency in MHz	Horizontal Peak (dBμV/m)	Horizontal Average (dBμV/m)	Vertical Peak (dBμV/m)	Vertical Average (dBμV/m)	Limit @ 3m (dBμV/m)	Horizontal Margin (dB)	Vertical Margin (dB)
Mode 14 U-NII-3 (802.11n40)							
11510	60.0	46.3	59.7	46.4	54.0	-7.7	-7.6
11590	61.2	47.8	61.4	47.6	54.0	-6.2	-6.4
23020	59.1	45.3	58.6	45.3	54.0	-8.7	-8.7

Other emissions present had amplitudes at least 20 dB below the limit. Peak and Quasi-Peak amplitude emissions are recorded for frequency below 1000 MHz. Peak and Average amplitude emissions are recorded for frequency range above 1000 MHz.

**Table 8 Harmonic Radiated Emissions in Restricted Bands Data Mode 12 U-NII-3 (802.11ac80)**

Frequency in MHz	Horizontal Peak (dBμV/m)	Horizontal Average (dBμV/m)	Vertical Peak (dBμV/m)	Vertical Average (dBμV/m)	Limit @ 3m (dBμV/m)	Horizontal Margin (dB)	Vertical Margin (dB)
Mode 15 U-NII-3 (802.11ac80)							
11550	60.7	46.8	60.7	46.4	54.0	-7.2	-7.6
23100	59.0	45.3	59.4	45.3	54.0	-8.7	-8.7

Other emissions present had amplitudes at least 20 dB below the limit. Peak and Quasi-Peak amplitude emissions are recorded for frequency below 1000 MHz. Peak and Average amplitude emissions are recorded for frequency range above 1000 MHz.

**Summary of Results for Radiated Emissions in Restricted Bands**

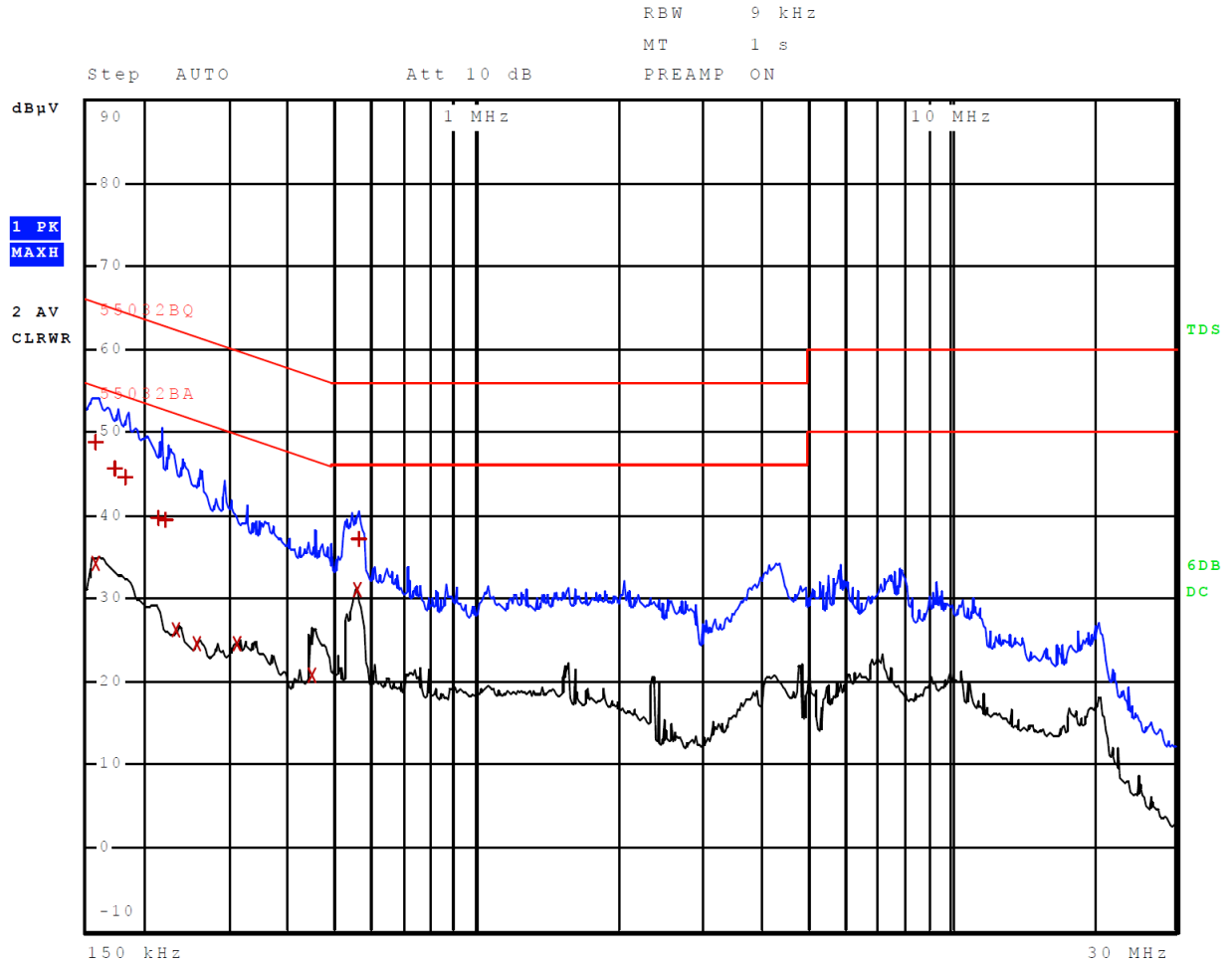
The EUT demonstrated compliance with the emissions requirements of 47 CFR 15.205, RSS-GEN Issue 5, and RSS-247 Issue 3. The EUT provided a worst-case minimum margin of -4.1 dB below the emissions requirements in restricted frequency bands. Peak, Quasi-peak, and average amplitudes were checked for compliance with the regulations. Worst-case emissions are reported with other emissions found in the restricted frequency bands at least 20 dB below the requirements.

## **AC Line Conducted EMI Procedure**

The EUT was arranged in typical equipment configurations as offered by manufacturer and presented above in equipment configuration. AC Line Conducted emission testing was performed with the EUT placed on a 1 x 1.5-meter bench 80 cm above the conducting ground plane, floor of a screen room. The bench was positioned 40 cm away from the wall of the screen room. The LISN was positioned on the floor of the screen room 80-cm from the rear of the EUT. Testing for the AC line-conducted emissions followed the procedures of ANSI C63.10-2013. The EUT was configured as presented in the AC Line conducted configurations as directed by the manufacturer and presented above in equipment configuration. The AC adapter for the EUT was connected to the LISN for AC line-conducted emissions testing. A second LISN was positioned on the floor of the screen room 80-cm from the rear of the supporting equipment of the test configuration. All power cords except the EUT were then powered from the second LISN. EMI was coupled to the spectrum analyzer through a 0.1  $\mu$ F capacitor, internal to the LISN. Power line conducted emissions testing was carried out individually for each current carrying conductor of the EUT. The excess length of lead between the system and the LISN receptacle was folded back and forth to form a bundle not exceeding 40 cm in length. The screen room, conducting ground plane, analyzer, and LISN were bonded together to the protective earth ground. Preliminary testing was performed to identify the frequencies of each of the emissions, which demonstrated the highest amplitudes. The cables were repositioned to obtain maximum amplitude of measured EMI level. Once the worst-case configuration was identified, plots were made of the EMI from 0.15 MHz to 30 MHz and data recorded.

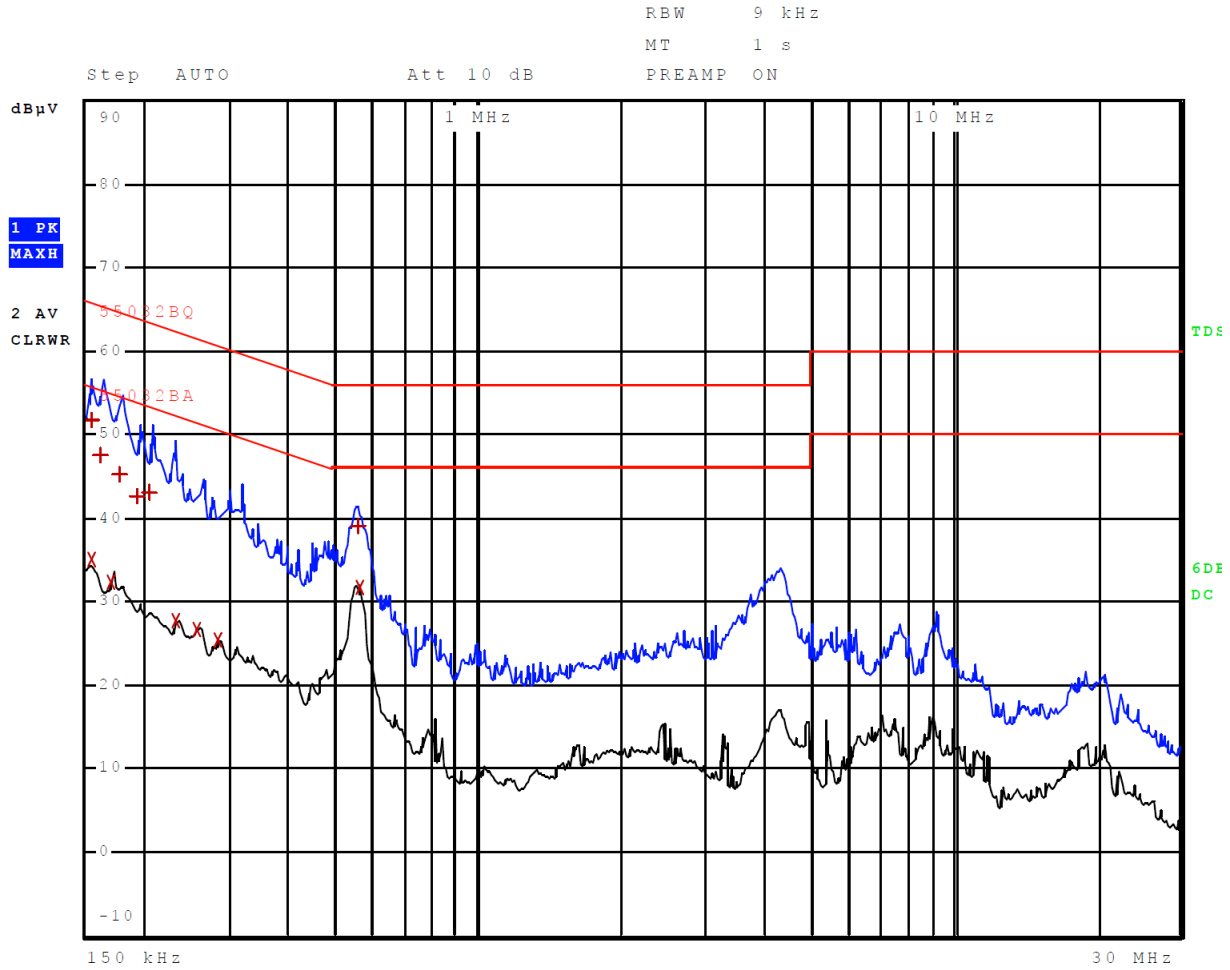
Refer to figure one and two for plots of the Configuration #3 EUT – USB Computer interface AC Line conducted emissions.

Figure 1 AC Line Conducted Emissions Data L1 (#2, EUT – Computer)



Other emissions present had amplitudes at least 20 dB below the limit.

Figure 2 AC Line Conducted Emissions Data L2 (#2, EUT – Computer)



Other emissions present had amplitudes at least 20 dB below the limit.

**Table 9 AC Line Conducted Emissions Data L1 (#2, EUT – Computer)**

Trace	Frequency	Level (dBµV)	Detector	Delta Limit/dB
2	158.000000000 kHz	34.16	Average	-21.41
1	158.000000000 kHz	48.73	Quasi Peak	-16.84
1	174.000000000 kHz	45.61	Quasi Peak	-19.16
1	182.000000000 kHz	44.54	Quasi Peak	-19.86
1	214.000000000 kHz	39.60	Quasi Peak	-23.45
1	222.000000000 kHz	39.43	Quasi Peak	-23.31
2	234.000000000 kHz	26.33	Average	-25.98
2	258.000000000 kHz	24.62	Average	-26.87
2	314.000000000 kHz	24.49	Average	-25.37
2	446.000000000 kHz	20.78	Average	-26.17
2	554.000000000 kHz	31.01	Average	-14.99
1	558.000000000 kHz	37.11	Quasi Peak	-18.89

Other emissions present had amplitudes at least 20 dB below the limit.

**Table 10 AC Line Conducted Emissions Data L2 (#2, EUT – Computer)**

Trace	Frequency	Level (dBµV)	Detector	Delta Limit/dB
2	154.000000000 kHz	35.07	Average	-20.71
1	154.000000000 kHz	51.65	Quasi Peak	-14.13
1	162.000000000 kHz	47.39	Quasi Peak	-17.98
2	170.000000000 kHz	32.40	Average	-22.56
1	178.000000000 kHz	45.14	Quasi Peak	-19.43
1	194.000000000 kHz	42.54	Quasi Peak	-21.32
1	206.000000000 kHz	42.94	Quasi Peak	-20.42
2	234.000000000 kHz	27.67	Average	-24.63
2	258.000000000 kHz	26.68	Average	-24.82
2	282.000000000 kHz	25.31	Average	-25.45
1	554.000000000 kHz	38.98	Quasi Peak	-17.02
2	558.000000000 kHz	31.79	Average	-14.21

Other emissions present had amplitudes at least 20 dB below the limit.

**Summary of Results for AC Line Conducted Emissions**

The EUT demonstrated compliance with the AC Line Conducted Emissions requirements of 47CFR Part 15C and other applicable emissions requirements. The EUT configuration #3 demonstrated a minimum margin of -14.13 dB below the requirement. Other emissions were present with amplitudes at least 20 dB below the limit and worst-case amplitudes recorded.

## **General Radiated Emissions Procedure**

Testing for the radiated emissions were performed as specified in CFR47 15B, RSS-GEN, and directed in ANSI C63.4-2014. For testing purposes, the EUT was arranged as presented in the applicable configuration diagrams above and operated through all modes as presented.

Exploratory radiated emissions measurements were performed in the SAC chamber or screen room, finding maximized emissions over frequency, EUT orientation, antenna height and polarity. This data is then used to focus the final radiated emissions measurements on these maximized points.

Final radiated emissions data were taken with the EUT located in the OATS or SAC at distance of 3 meters between the EUT and the receiving antenna. The frequency spectrum from 9 kHz to 6,000 MHz was searched for radiated emissions. Measured emission levels were maximized by EUT placement on the table, changing cable location, rotating the turntable through 360 degrees, varying the antenna height between 1 and 4 meters above the ground plane and changing antenna position between horizontal and vertical polarization. Antennas used were Loop, Biconical, Broadband Biconilog, Log Periodic, and Double Ridge or Pyramidal Horns and mixers above 1 GHz.



**Table 11 General Radiated Emissions Data**

Frequency (MHz)	Horizontal Peak (dBμV/m)	Horizontal Quasi-Peak (dBμV/m)	Vertical Peak (dBμV/m)	Vertical Quasi-Peak (dBμV/m)	Limit @ 3m (dBμV/m)	Horizontal Margin (dB)	Vertical Margin (dB)
87.3	42.2	33.7	37.5	30.3	40.0	-6.3	-9.7
90.5	39.6	32.3	35.6	29.2	40.0	-7.7	-10.8
93.4	38.4	30.9	35.2	28.2	40.0	-9.1	-11.8
97.8	37.9	30.3	34.1	27.3	40.0	-9.7	-12.7
108.7	35.1	27.0	27.9	20.4	40.0	-13.0	-19.6
110.7	35.0	26.3	26.9	18.0	40.0	-13.7	-22.0
116.8	34.7	25.1	30.0	22.6	40.0	-14.9	-17.4
125.0	38.0	32.5	40.4	31.5	40.0	-7.5	-8.5
155.3	35.6	25.3	33.1	23.9	40.0	-14.7	-16.1
185.5	31.8	21.7	28.2	18.1	40.0	-18.3	-21.9
214.6	32.9	23.2	26.8	17.3	40.0	-16.8	-22.7
272.2	41.3	31.8	38.7	28.2	47.0	-15.2	-18.8
351.3	45.7	29.7	46.2	33.7	47.0	-17.3	-13.3

Other emissions present had amplitudes at least 20 dB below the limit. Peak and Quasi-Peak amplitude emissions are recorded for frequency range below 1000 MHz. Peak and Average amplitude emissions are recorded for frequency range above 1000 MHz.

**Summary of Results for General Radiated Emissions**

The EUT demonstrated compliance with the radiated emissions requirements of 47 CFR part 15 and Industry Canada RSS-247 Issue 3 Intentional Radiators. The EUT demonstrated a minimum margin of -6.3 dB below the requirements. Other emissions were present with amplitudes at least 20 dB below the Limits.

## **Operation in the 5150-5250 and 5725-5850 MHz Frequency U-NII-1 and U-NII-3 Bands**

Testing followed FCC 789033 D02 General U-NII Test Procedures New Rules v02r01.

The manufacturer provided a second test sample which provided direct connection to the antenna port. A power meter was used to measure fundamental transmitter output power. A spectrum analyzer / receiver was used to produce plots and make other antenna port conducted measurements for compliance testing. Test software was provided to operate the transmitter.

This software provided the ability to set test channel, operational mode, and modulation scheme.

The antenna port was connected to coaxial cable with 50-ohm attenuator and receiver, spectrum analyzer, or power meter during testing. The design was also tested for radiated emissions using sample EUT Tx Radiated #1 representative of production equipment. Radiated emissions testing was performed on the Open Area Test Site (OATS) or Semi Anechoic Chamber (SAC) with the transmitter operating. The test sample was placed on a turntable elevated as required above the ground plane as required at a 3 meters distance from the FSM antenna located on the OATS or SAC for testing radiated emissions. The peak and quasi-peak amplitude of the frequencies below 1000 MHz were measured using a spectrum analyzer. The peak and average amplitude of emissions above 1000 MHz were measured using a spectrum analyzer. Emissions data was recorded from the measurement results. Data presented reflects measurement result corrected to account for measurement system gains and losses. Plots were made of transmitter performance for reference and demonstration of compliance. In addition, all Manufacturers of U-NII devices are responsible for ensuring frequency stability such that the emissions are maintained within the band of operation under all conditions of normal operation as specified in the user's manual.

The manufacturer has attested the equipment operates within the required frequency spectrum under normal operational conditions. This report documents emissions governed under the U-NII-1 and U-NII-3 bands operating in the 5180-5240 and 5745-5825 MHz frequency bands.

### **47CFR 15.407 General Technical Requirements**

#### (a) power limitations

(1) For the Band 5.15-5.25 GHz

(ii) For an indoor access point operating in the band 5.15-5.25 GHz, the maximum conducted output power over the frequency band of operation shall not exceed 1 W provided the maximum antenna gain does not exceed 6 dBi. In addition, the maximum power spectral

Rogers Labs, a division of The Compatibility Center LLC

7915 Nieman Road FCC ID: IPH-B4450 IC: 1792A-B4450

Lenexa, KS 66214

Test: 240102

Phone/Fax: (913) 660-0666

Test to: 47CFR 15E, RSS-Gen RSS-247

Revision 1

File: B04450 NII TstRpt 240102 r1

Garmin International, Inc.

PMN: B04450

SN's: 8BR000021, 8BS000009

Date: May 28, 2024

Page 34 of 96

density shall not exceed 17 dBm in any 1-megahertz band. If transmitting antennas of directional gain greater than 6 dBi are used, both the maximum conducted output power and the maximum power spectral density shall be reduced by the amount in dB that the directional gain of the antenna exceeds 6 dBi.

(iv) For client devices in the 5.15-5.25 GHz band, the maximum conducted output power over the frequency band of operation shall not exceed 250 mW provided the maximum antenna gain does not exceed 6 dBi. In addition, the maximum power spectral density shall not exceed 11 dBm in any 1-megahertz band. If transmitting antennas of directional gain greater than 6 dBi are used, both the maximum conducted output power and the maximum power spectral density shall be reduced by the amount in dB that the directional gain of the antenna exceeds 6 dBi.

(3) For the band 5.725-5.85 GHz, the maximum conducted output power over the frequency band of operation shall not exceed 1 W. In addition, the maximum power spectral density shall not exceed 30 dBm in any 500-kHz band. If transmitting antennas of directional gain greater than 6 dBi are used, both the maximum conducted output power and the maximum power spectral density shall be reduced by the amount in dB that the directional gain of the antenna exceeds 6 dBi. However, fixed point-to-point U-NII devices operating in this band may employ transmitting antennas with directional gain greater than 6 dBi without any corresponding reduction in transmitter conducted power. Fixed, point-to-point operations exclude the use of point-to-multipoint systems, omnidirectional applications, and multiple collocated transmitters transmitting the same information. The operator of the U-NII device, or if the equipment is professionally installed, the installer, is responsible for ensuring that systems employing high gain directional antennas are used exclusively for fixed, point-to-point operations.

(11) The maximum conducted output power must be measured over any interval of continuous transmission using instrumentation calibrated in terms of an rms-equivalent voltage.

(12) Power spectral density measurement. The maximum power spectral density is measured as either a conducted emission by direct connection of a calibrated test instrument to the equipment under test or a radiated measurement. Measurements in the 5.725-5.85 GHz band are made over a reference bandwidth of 500 kHz or the 26 dB emission bandwidth of the device, whichever is less. Measurements in all other bands are made over a bandwidth of 1 MHz or the 26 dB emission bandwidth of the device, whichever is less. A narrower resolution bandwidth can be used, provided that the measured power is integrated over the full reference bandwidth.

(b) Undesirable emission limits. Except as shown in paragraph (b)(7) of this section, the maximum emissions outside of the frequency bands of operation shall be attenuated in accordance with the following limits:

(1) For transmitters operating in the 5.15-5.25 GHz band: All emissions outside of the 5.15-5.35 GHz band shall not exceed an e.i.r.p. of -27 dBm/MHz.

(2) For transmitters operating in the 5.25-5.35 GHz band: All emissions outside of the 5.15-5.35 GHz band shall not exceed an e.i.r.p. of -27 dBm/MHz.

- (3) For transmitters operating in the 5.47-5.725 GHz band: All emissions outside of the 5.47-5.725 GHz band shall not exceed an e.i.r.p. of  $-27$  dBm/MHz.
- (4) For transmitters operating in the 5.725-5.85 GHz band:
  - (i) All emissions shall be limited to a level of  $-27$  dBm/MHz at 75 MHz or more above or below the band edge increasing linearly to 10 dBm/MHz at 25 MHz above or below the band edge, and from 25 MHz above or below the band edge increasing linearly to a level of 15.6 dBm/MHz at 5 MHz above or below the band edge, and from 5 MHz above or below the band edge increasing linearly to a level of 27 dBm/MHz at the band edge.
- (7) The emission measurements shall be performed using a minimum resolution bandwidth of 1 MHz. A lower resolution bandwidth may be employed near the band edge, when necessary, provided the measured energy is integrated to show the total power over 1 MHz.
- (8) Unwanted emissions below 1 GHz must comply with the general field strength limits set forth in §15.209. Further, any U-NII devices using an AC power line are required to comply also with the conducted limits set forth in §15.207.
- (9) The provisions of §15.205 apply to intentional radiators operating under this section.
- (10) When measuring the emission limits, the nominal carrier frequency shall be adjusted as close to the upper and lower frequency band edges as the design of the equipment permits.
- (c) The device shall automatically discontinue transmission in case of either absence of information to transmit or operational failure. These provisions are not intended to preclude the transmission of control or signalling information, or the use of repetitive codes used by certain digital technologies to complete frame or burst intervals. Applicants shall include in their application for equipment authorization a description of how this requirement is met.
- (e) Within the 5.725-5.85 GHz band, the minimum 6 dB bandwidth of U-NII devices shall be at least 500 kHz.
- (f) Radio frequency devices operating under the provisions of this part are subject to the radio frequency radiation exposure requirements specified in §§1.1307(b), 1.1310, 2.1091, and 2.1093 of this chapter, as appropriate. All equipment shall be considered to operate in a “general population/uncontrolled” environment. Applications for equipment authorization of mobile or portable devices operating under this section must contain a statement confirming compliance with these requirements. Technical information showing the basis for this statement must be submitted to the Commission upon request.
- (g) Manufacturers of U-NII devices are responsible for ensuring frequency stability such that an emission is maintained within the band of operation under all conditions of normal operation as specified in the user’s manual.

### RSS-247 Issue 3

## **6. Technical requirements for license-exempt local area network devices and digital transmission systems operating in the 5 GHz band**

This section provides standards for License-Exempt Local Area Network (LE-LAN) devices operating in the bands 5150-5250 MHz, 5250-5350 MHz, 5470-5600 MHz, 5650-5725 MHz, and 5725-5850 MHz and for DTS's operating in the band 5725-5850 MHz that employ digital modulation technology but are not designed for LE-LAN operation.

Devices with occupied bandwidths which overlap different bands shall comply with all operational requirements for each band.

### **6.2.1 Frequency band 5150-5250 MHz**

LE-LAN devices are restricted to indoor operation only in the band 5150-5250 MHz. However, original equipment manufacturer (OEM) devices, which are installed in vehicles-by-vehicles manufacturers, are permitted.

Figure 3 Plot of Transmitter Emissions Across 5150-5250 MHz Mode 8 U-NII-1 (802.11a)

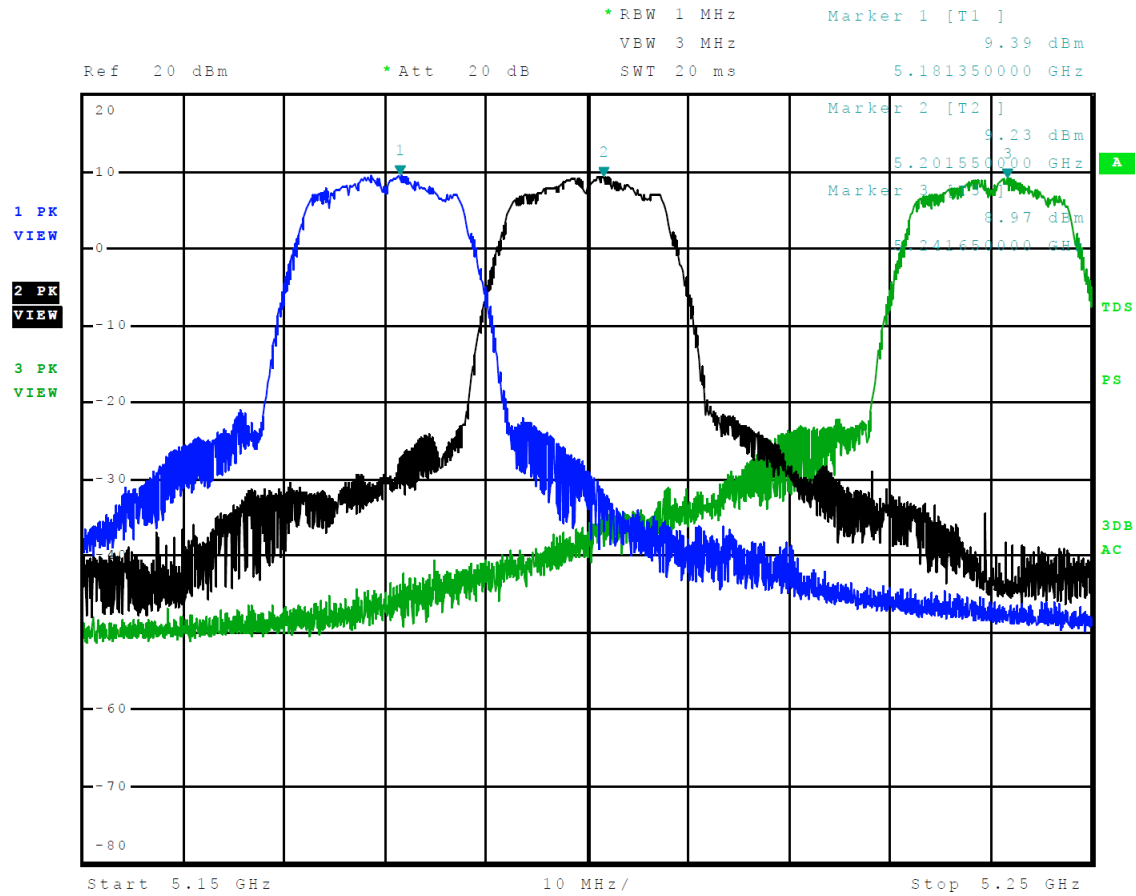
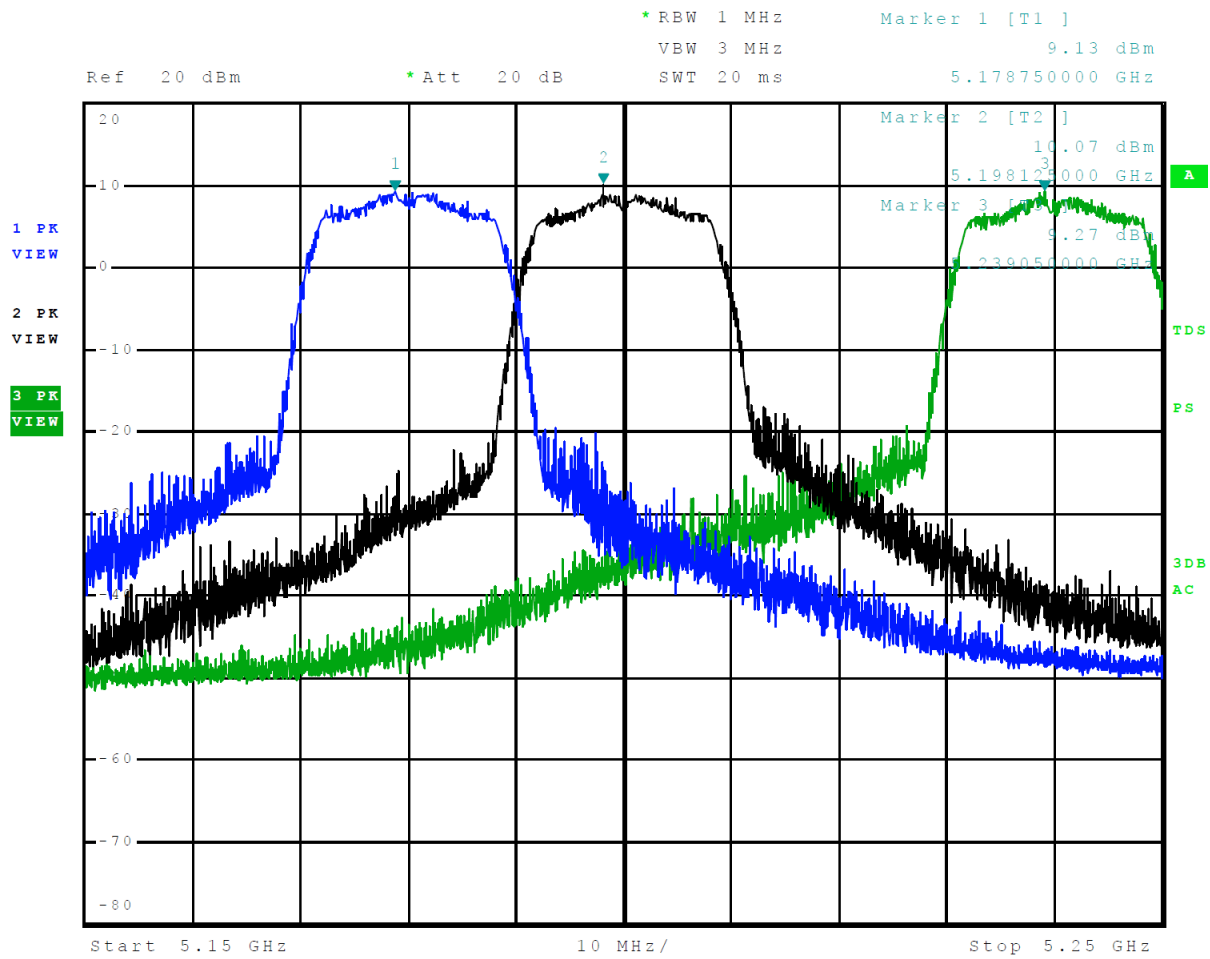
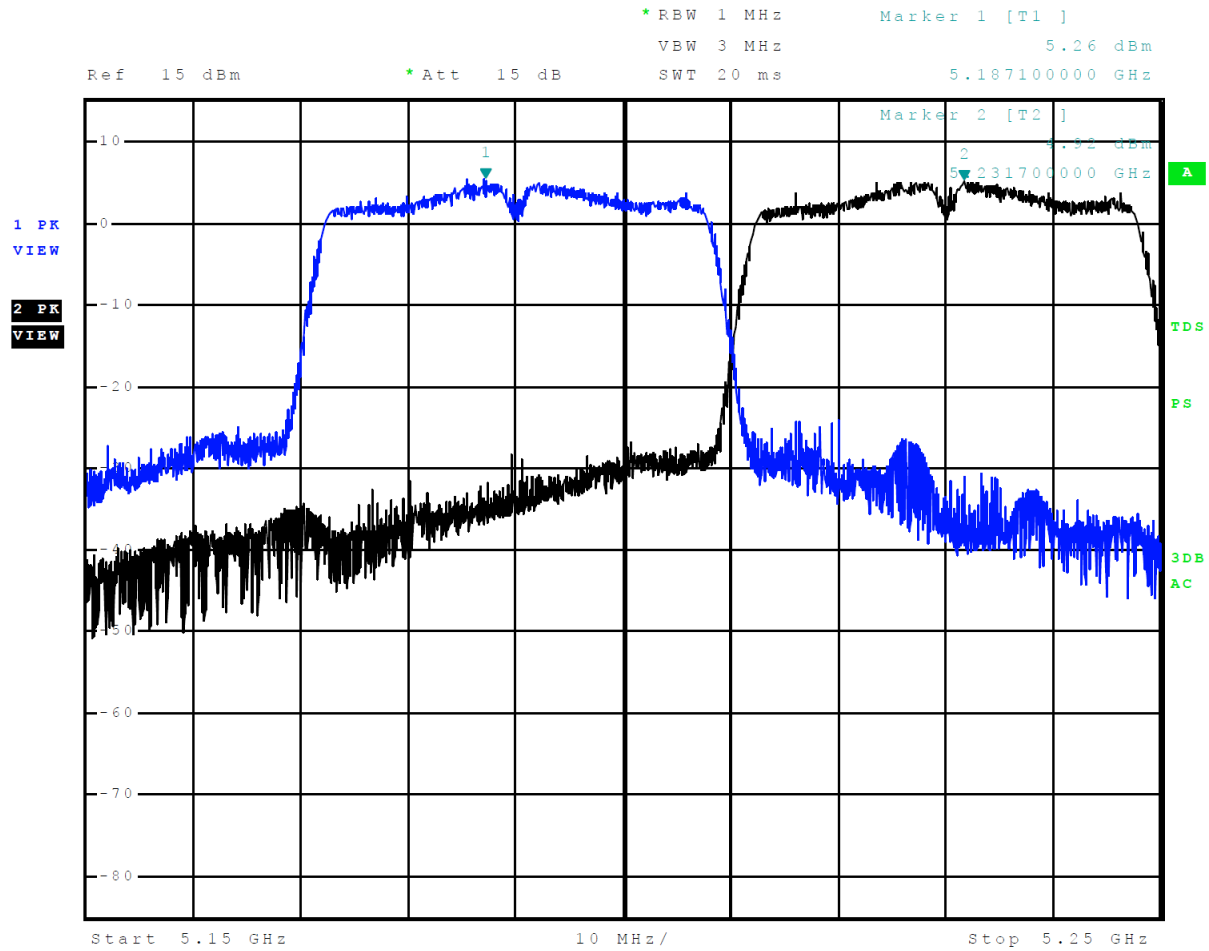


Figure 4 Plot of Transmitter Emissions Across 5150-5250 MHz Mode 9 U-NII-1 (802.11n)



**Figure 5 Plot of Transmitter Emissions Across 5150-5250 MHz Mode 10 U-NII-1 (802.11n40)**





**Figure 6 Plot of Transmitter Emissions Across 5150-5250 MHz Mode 11 U-NII-1 (802.11ac80)**

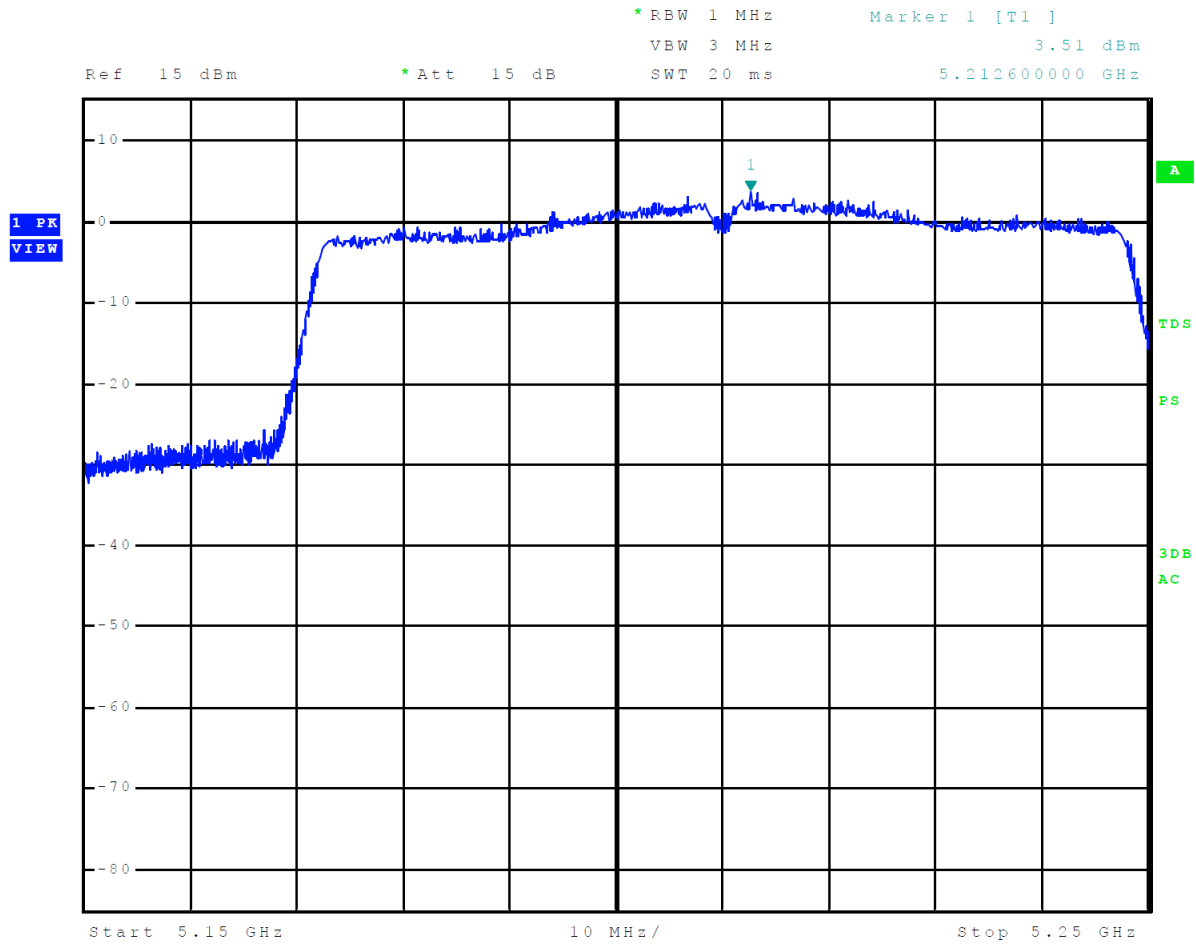
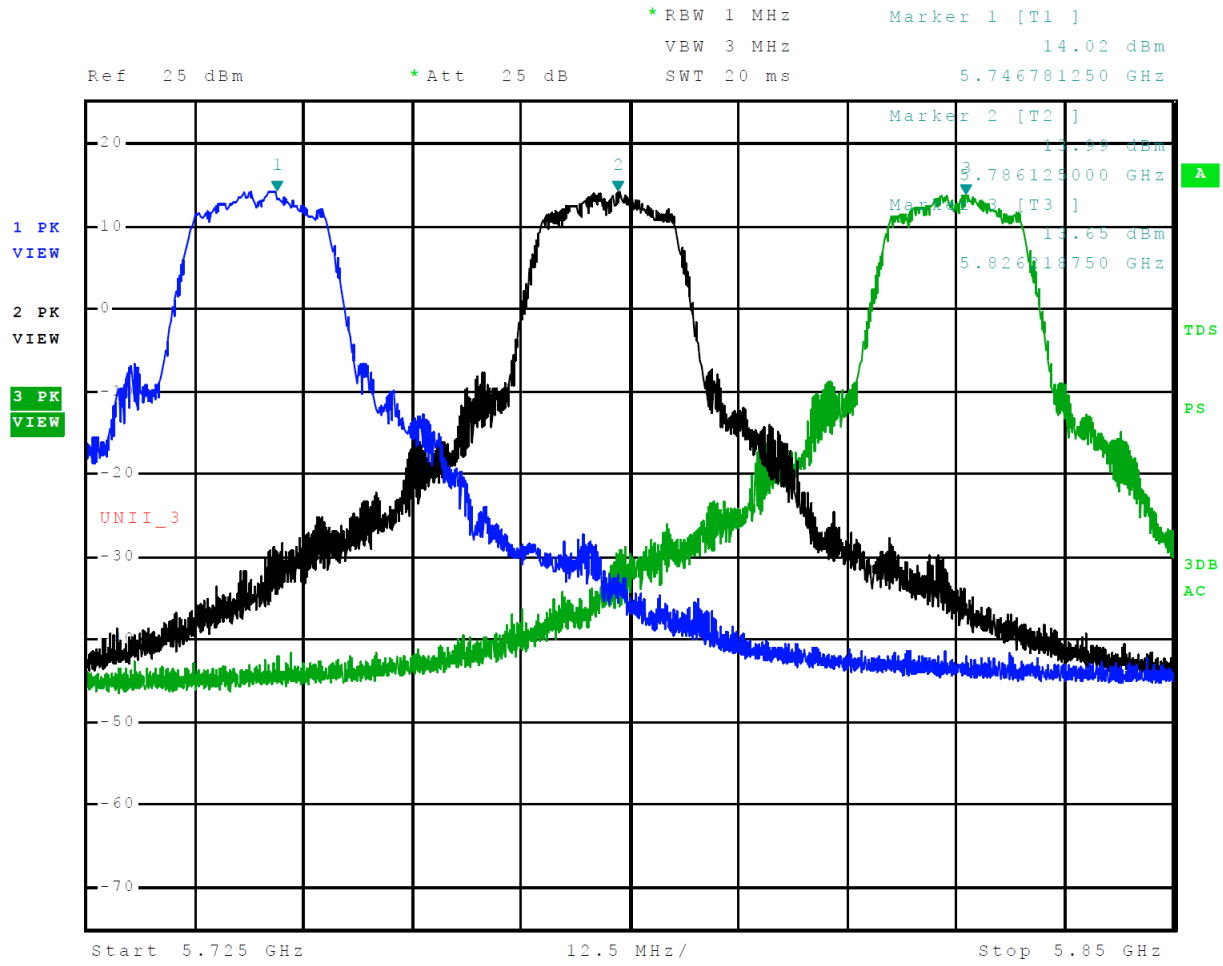
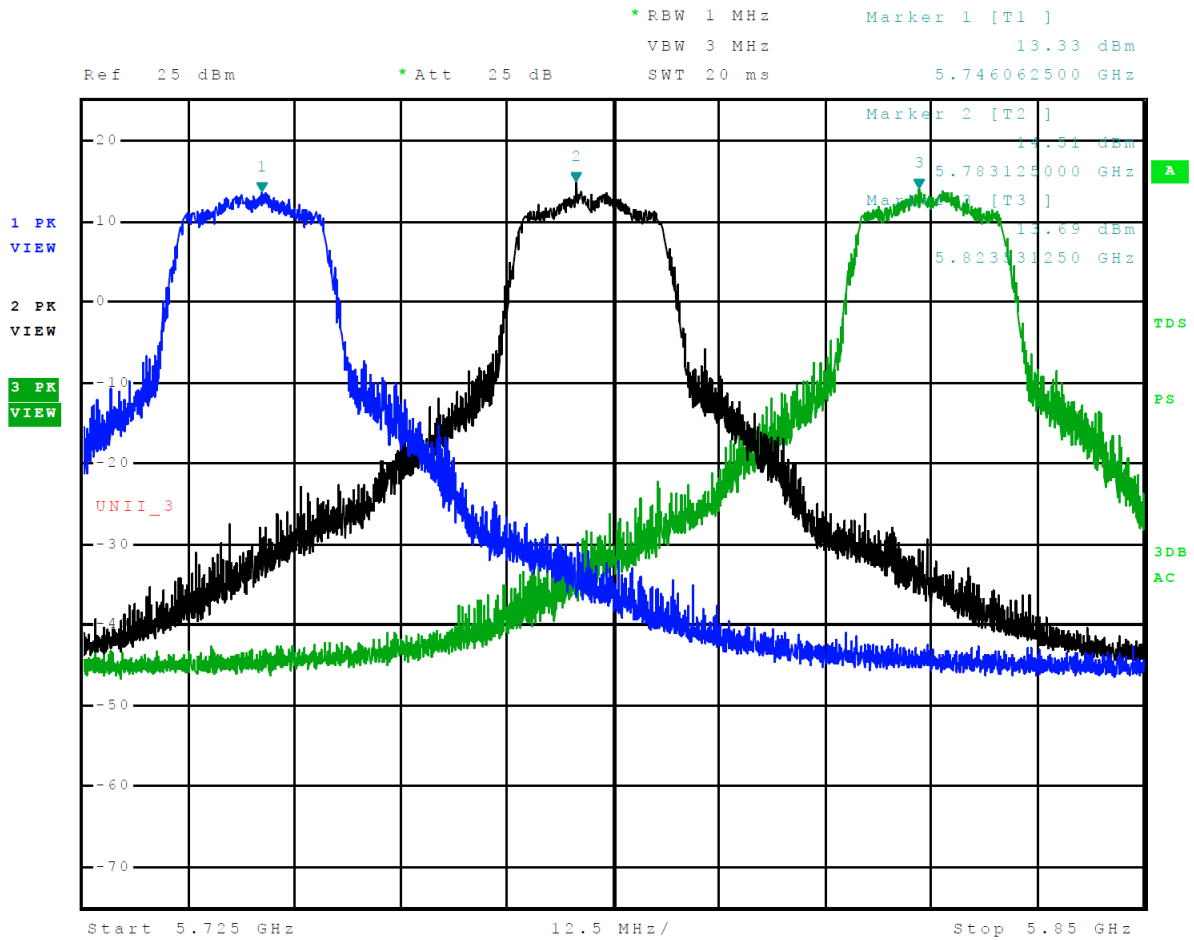


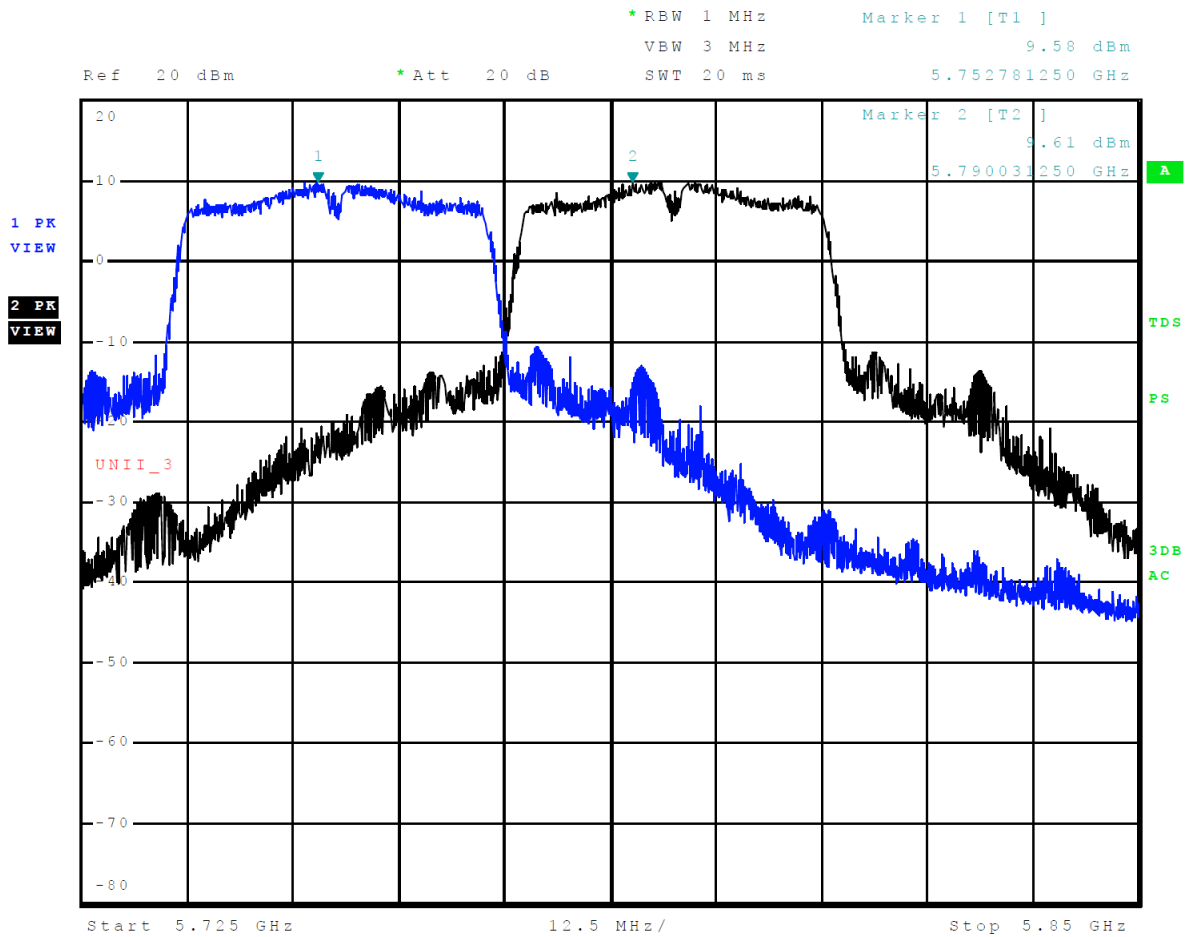
Figure 7 Plot of Transmitter Emissions Across 5725-5850 MHz Mode 9 U-NII-3 (802.11a)



**Figure 8 Plot of Transmitter Emissions Across 5725-5850 MHz Mode 10 U-NII-3 (802.11n)**



**Figure 9 Plot of Transmitter Emissions Across 5725-5850 MHz Mode 11 U-NII-3 (802.11n40)**



**Figure 10 Plot of Transmitter Emissions Across 5725-5850 MHz Mode 12 U-NII-3 (802.11ac80)**

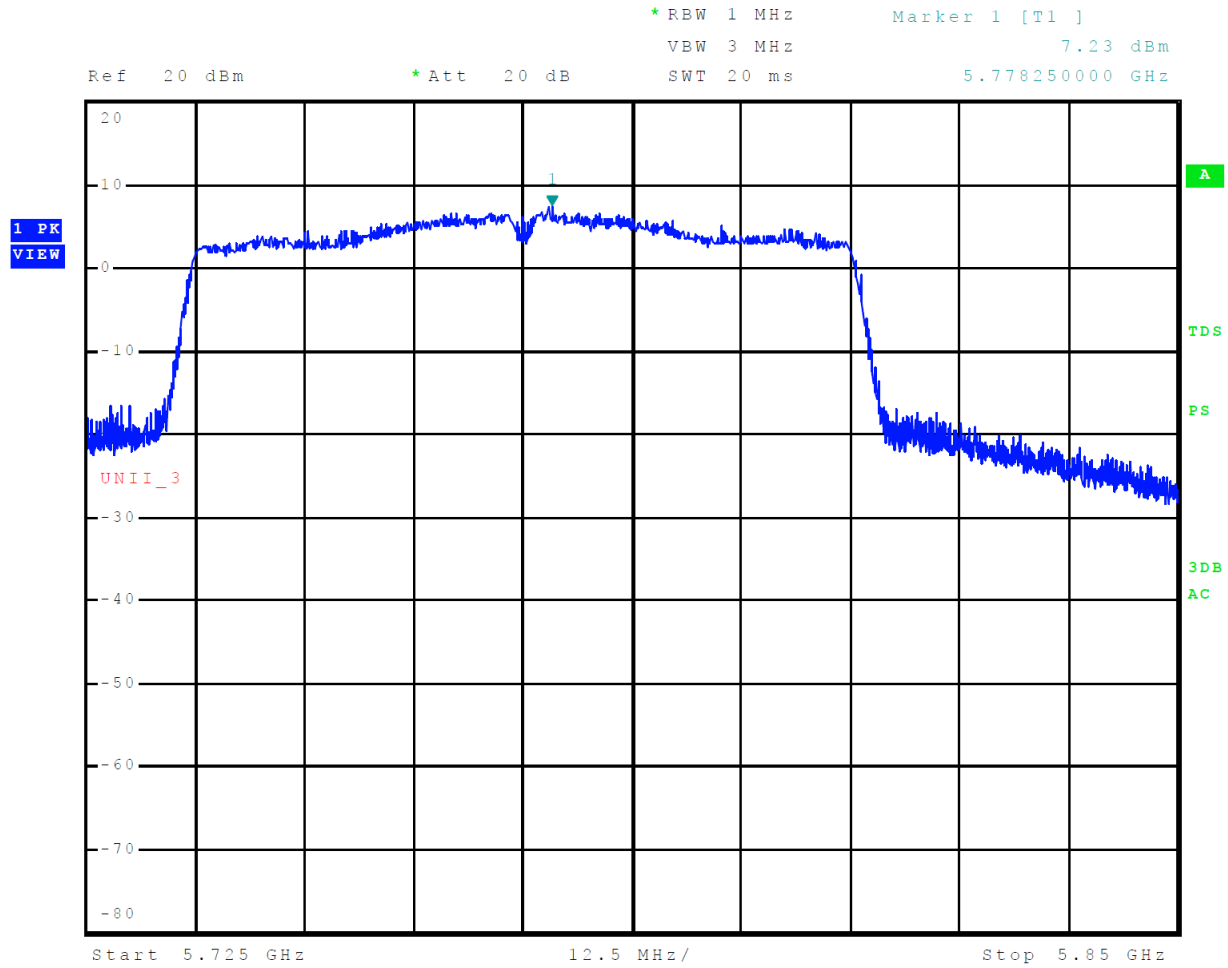


Figure 11 Plot of Lower Band Edge Across 5150-5250 MHz Mode 8 U-NII-1 (802.11a)

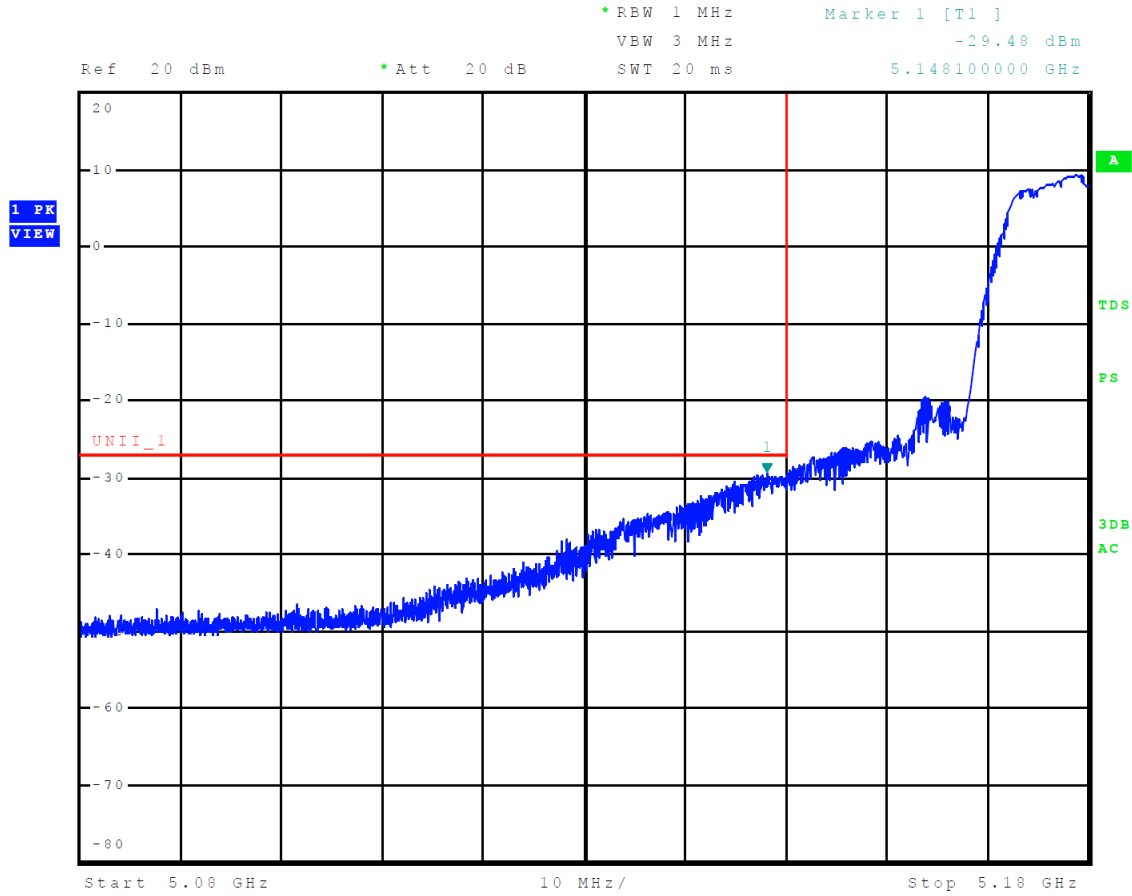


Figure 12 Plot of Lower Band Edge Across 5150-5250 MHz Mode 9 U-NII-1 (802.11n)

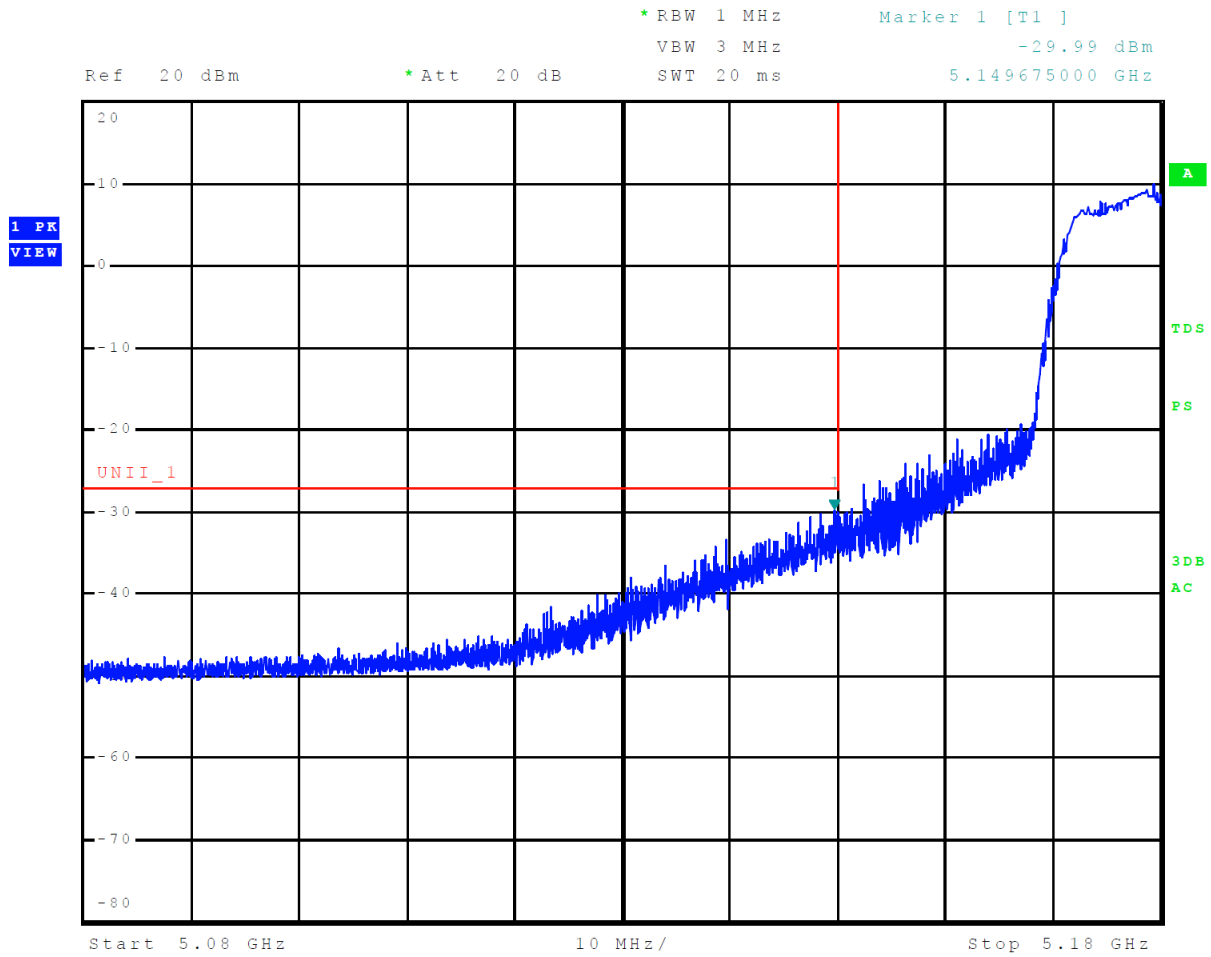


Figure 13 Plot of Lower Band Edge Across 5150-5250 MHz Mode 10 U-NII-1 (802.11n40)

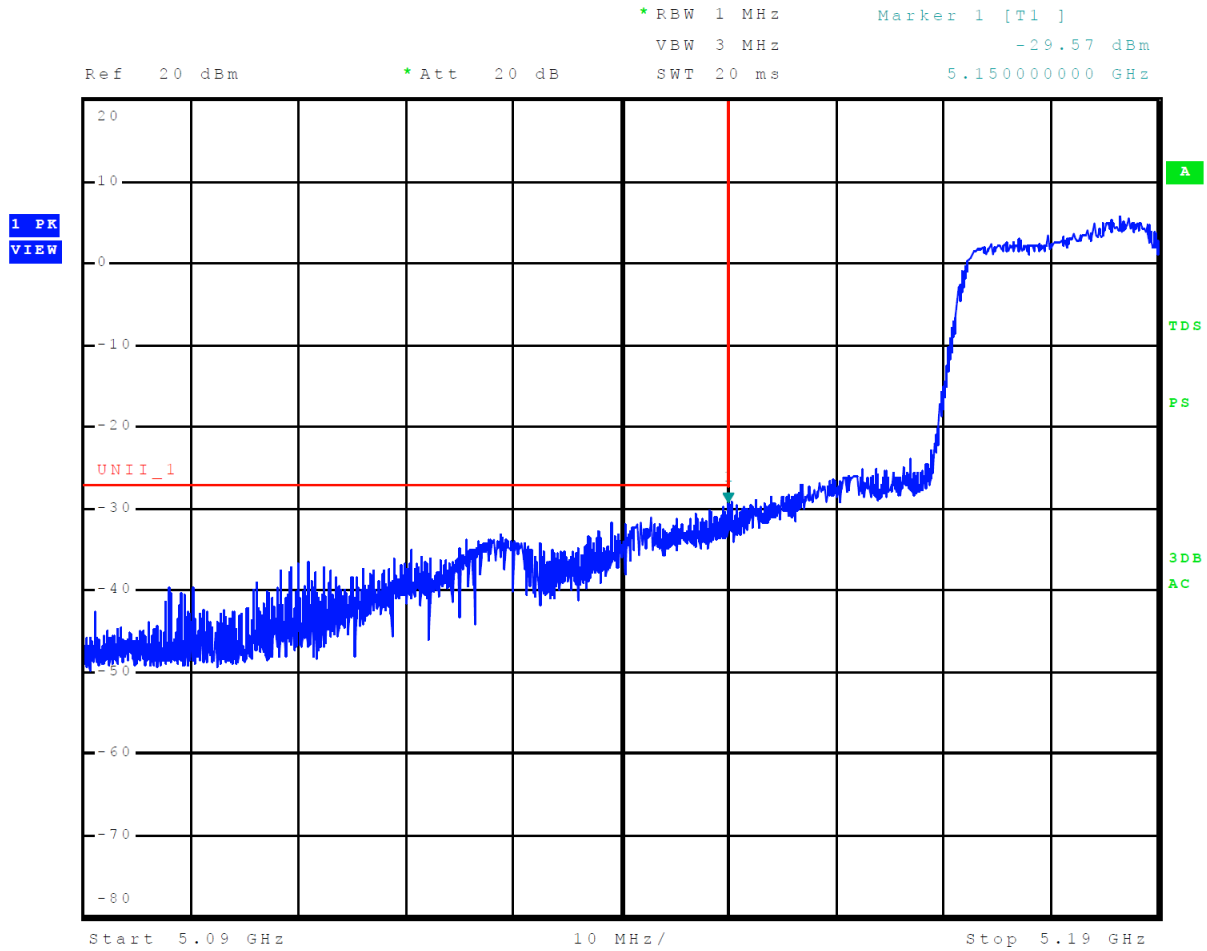




Figure 14 Plot of Lower Band Edge Across 5150-5250 MHz Mode 11 U-NII-1 (802.11ac80)

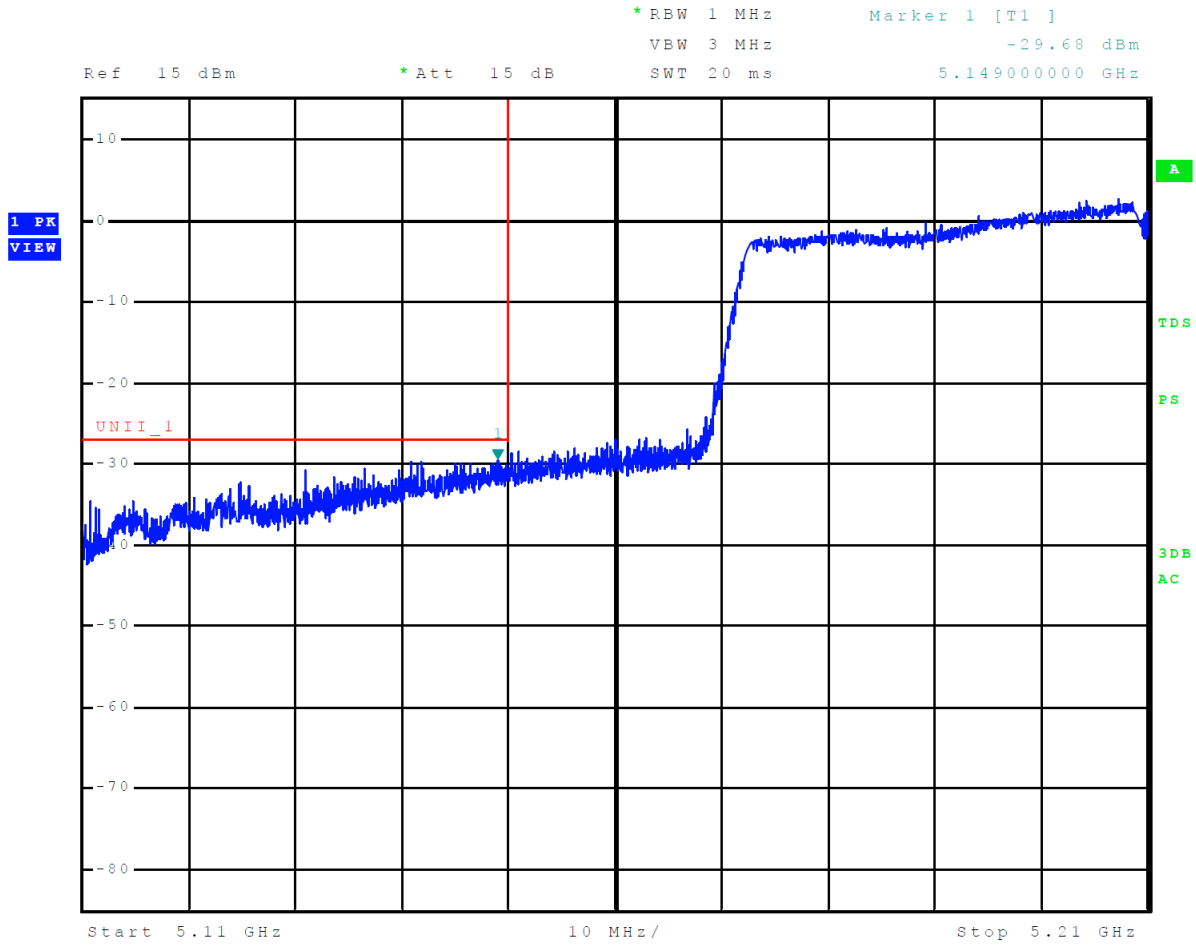


Figure 15 Plot of Lower Band Edge Across 5725-5850 MHz Mode 12 U-NII-3 (802.11a)

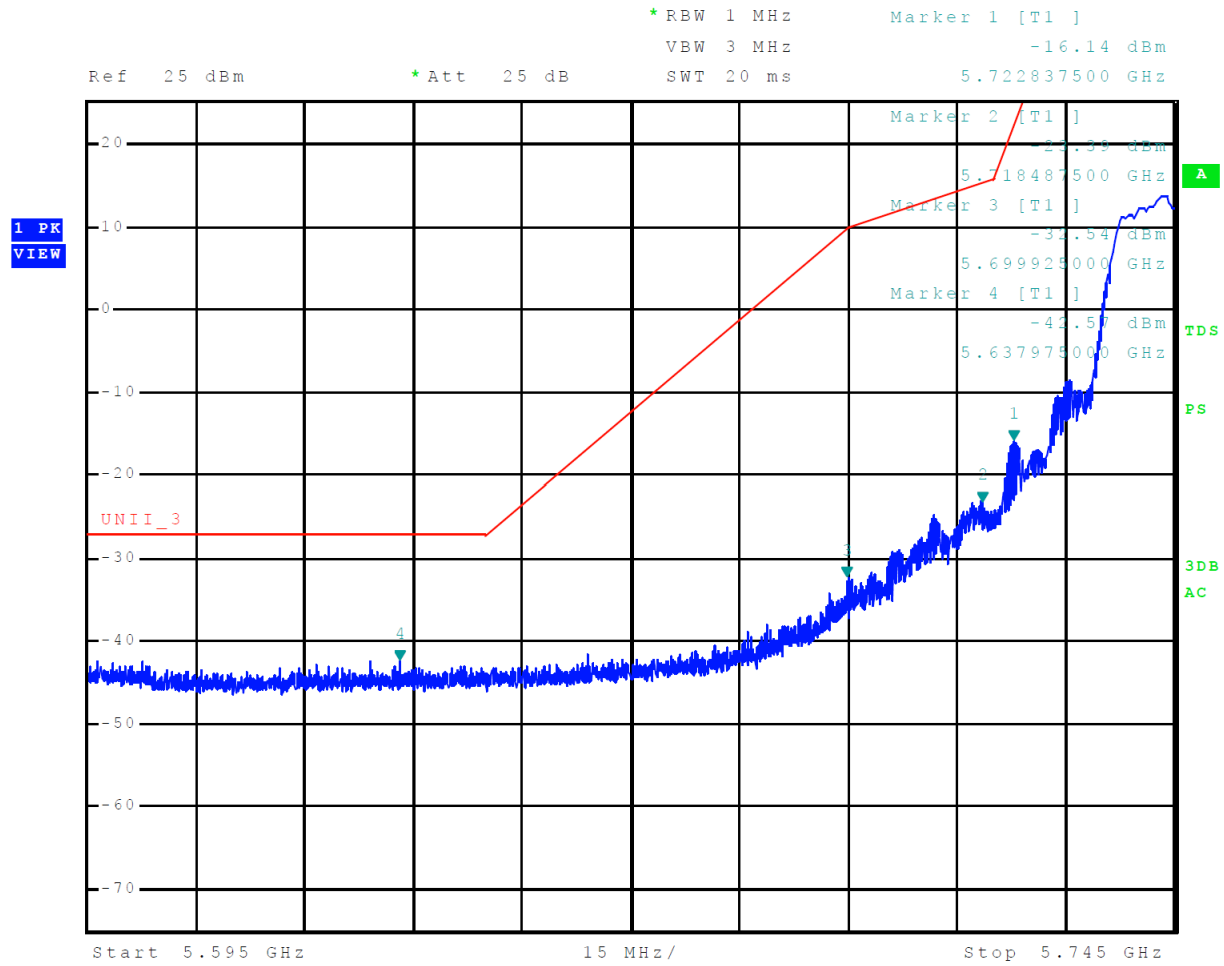


Figure 16 Plot of Lower Band Edge Across 5725-5850 MHz Mode 13 U-NII-3 (802.11n)

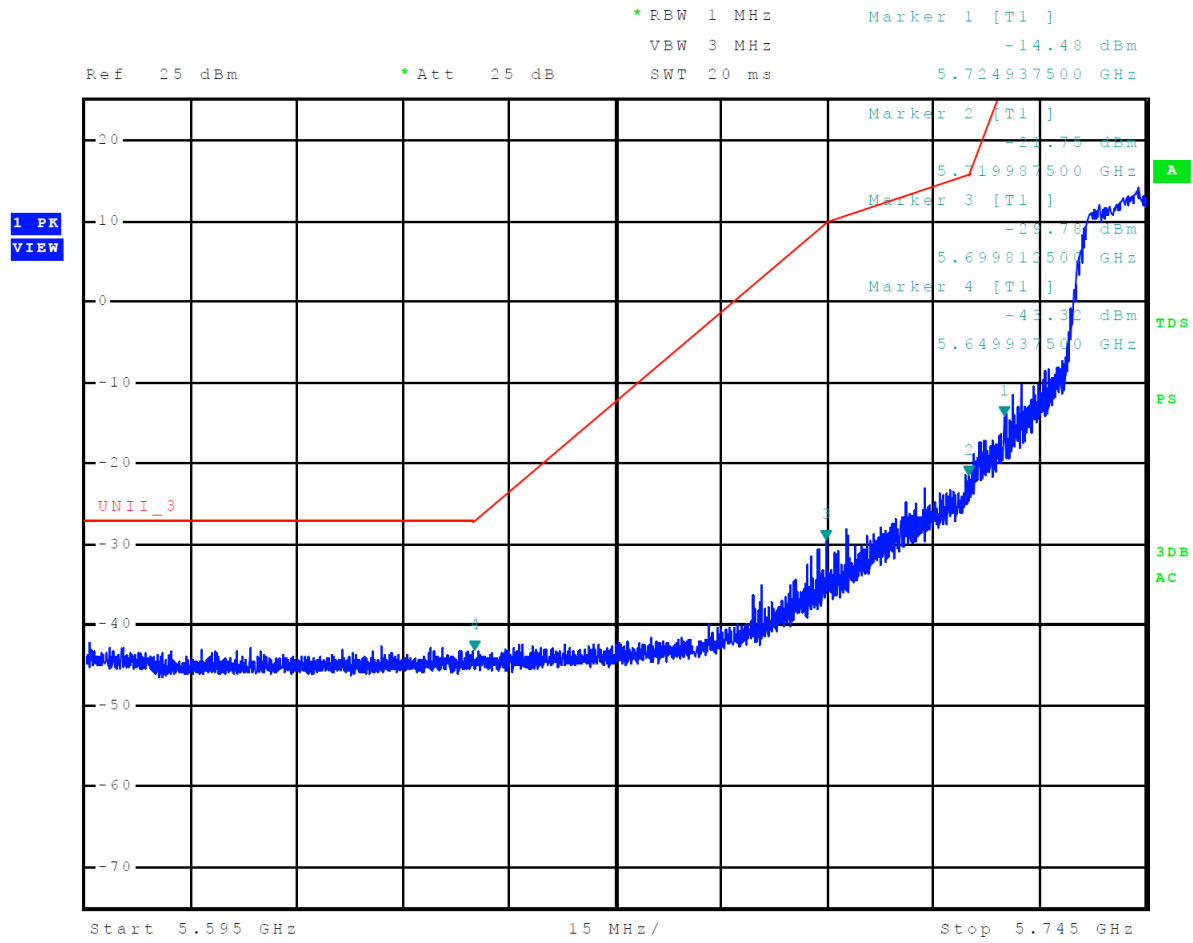


Figure 17 Plot of Lower Band Edge Across 5725-5850 MHz Mode 14 U-NII-3 (802.11n40)

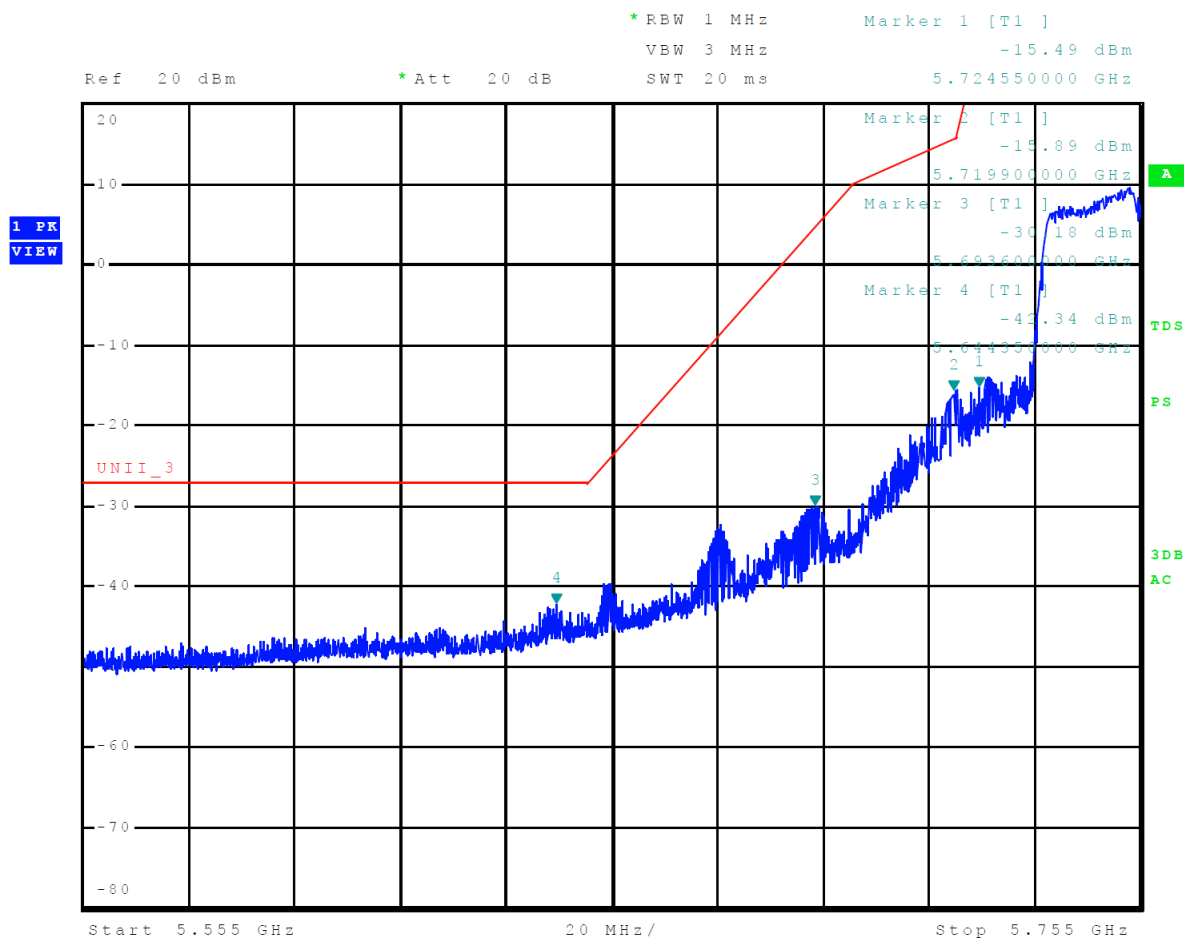


Figure 18 Plot of Lower Band Edge Across 5725-5850 MHz Mode 15 U-NII-3 (802.11ac80)

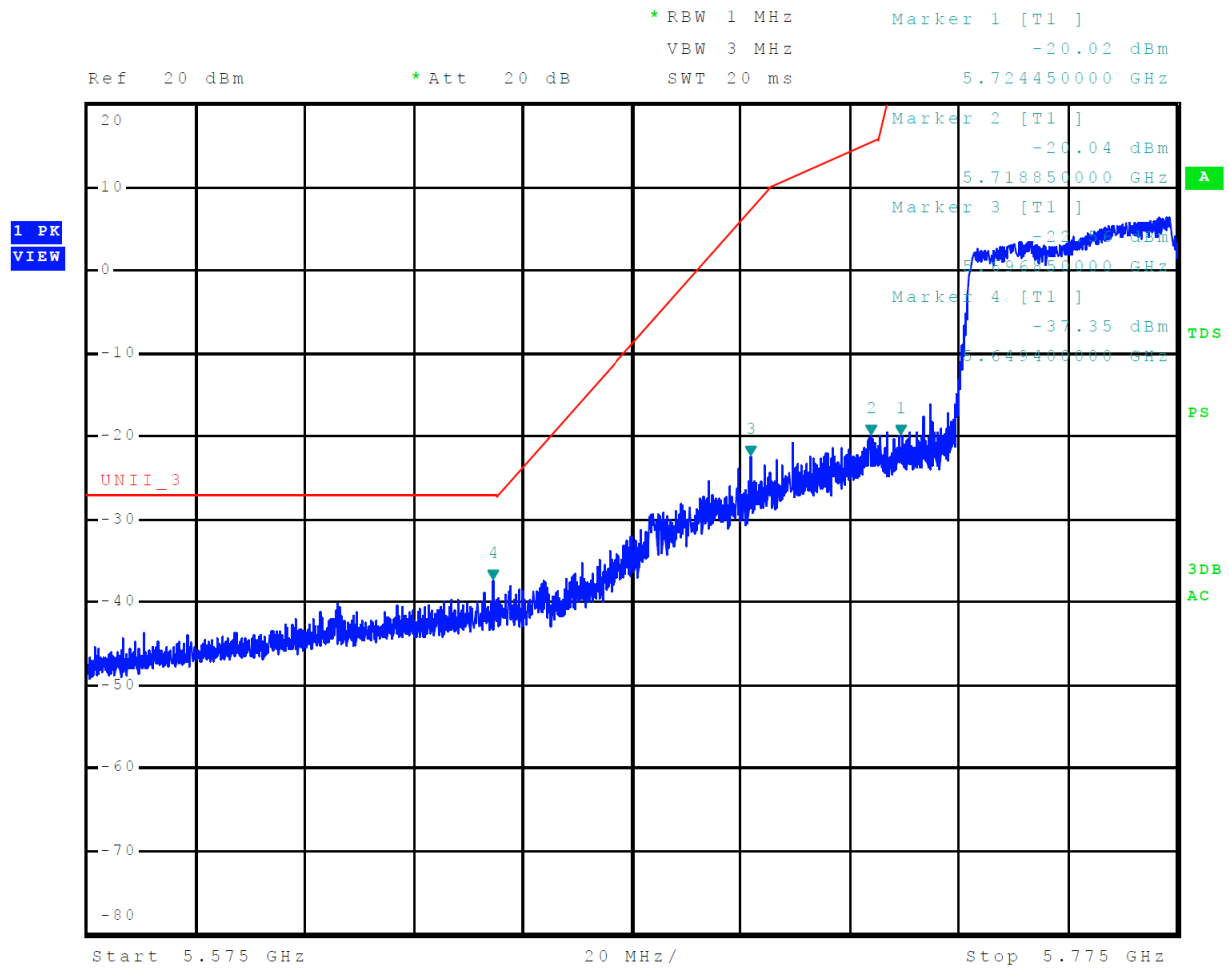


Figure 19 Plot of Upper Band Edge Across 5150-5250 MHz Mode 8 U-NII-1 (802.11a)

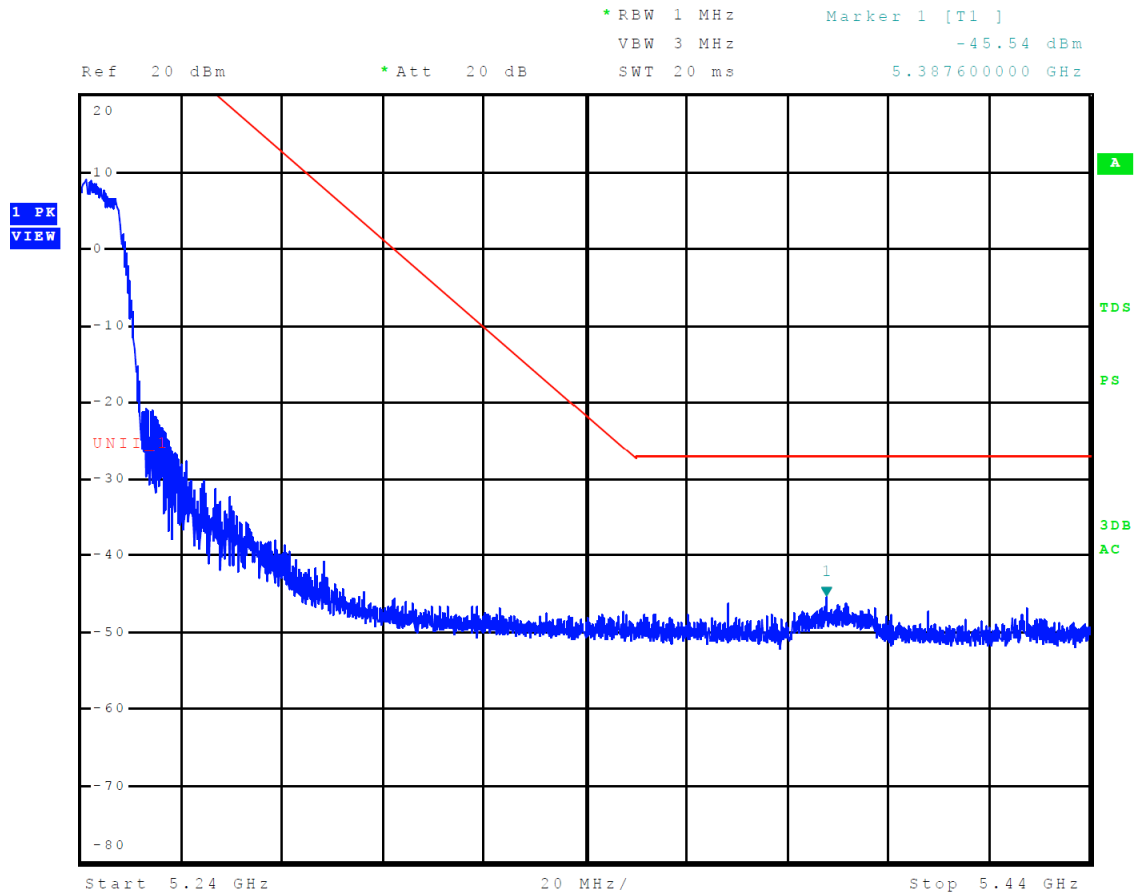


Figure 20 Plot of Upper Band Edge Across 5150-5250 MHz Mode 9 U-NII-1 (802.11n)

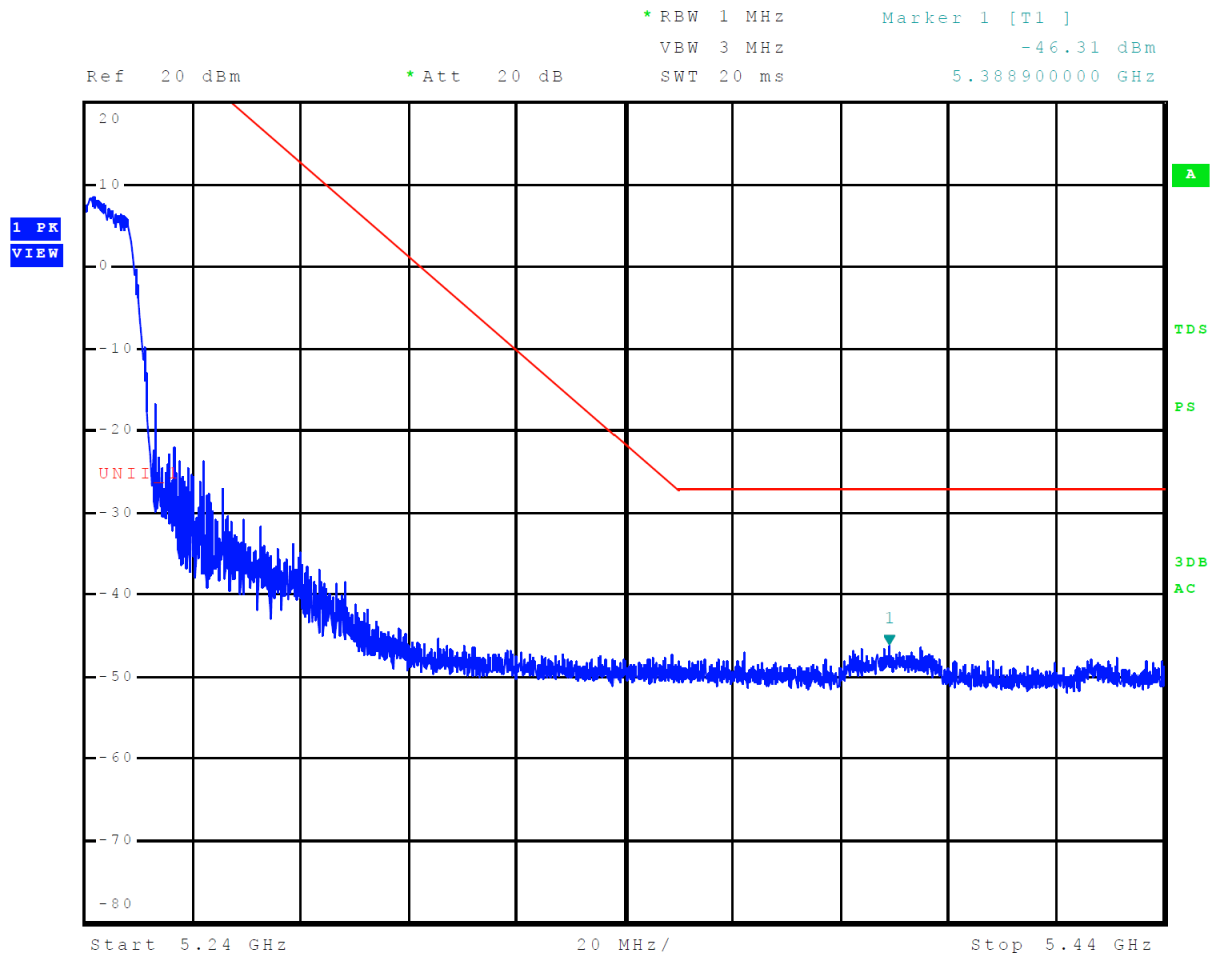


Figure 21 Plot of Upper Band Edge Across 5150-5250 MHz Mode 10 U-NII-1 (802.11n40)

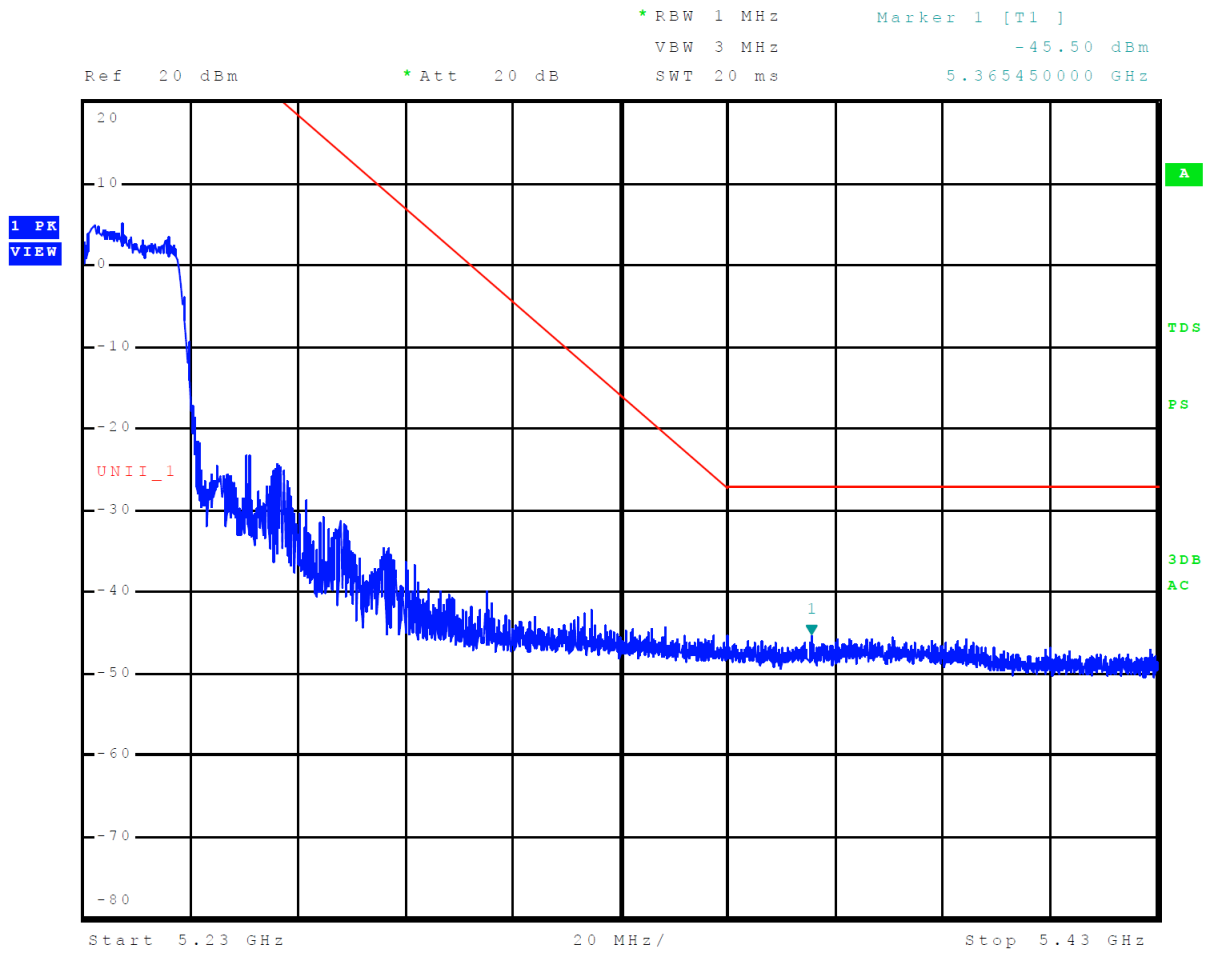




Figure 22 Plot of Upper Band Edge Across 5150-5250 MHz Mode 11 U-NII-1 (802.11ac80)

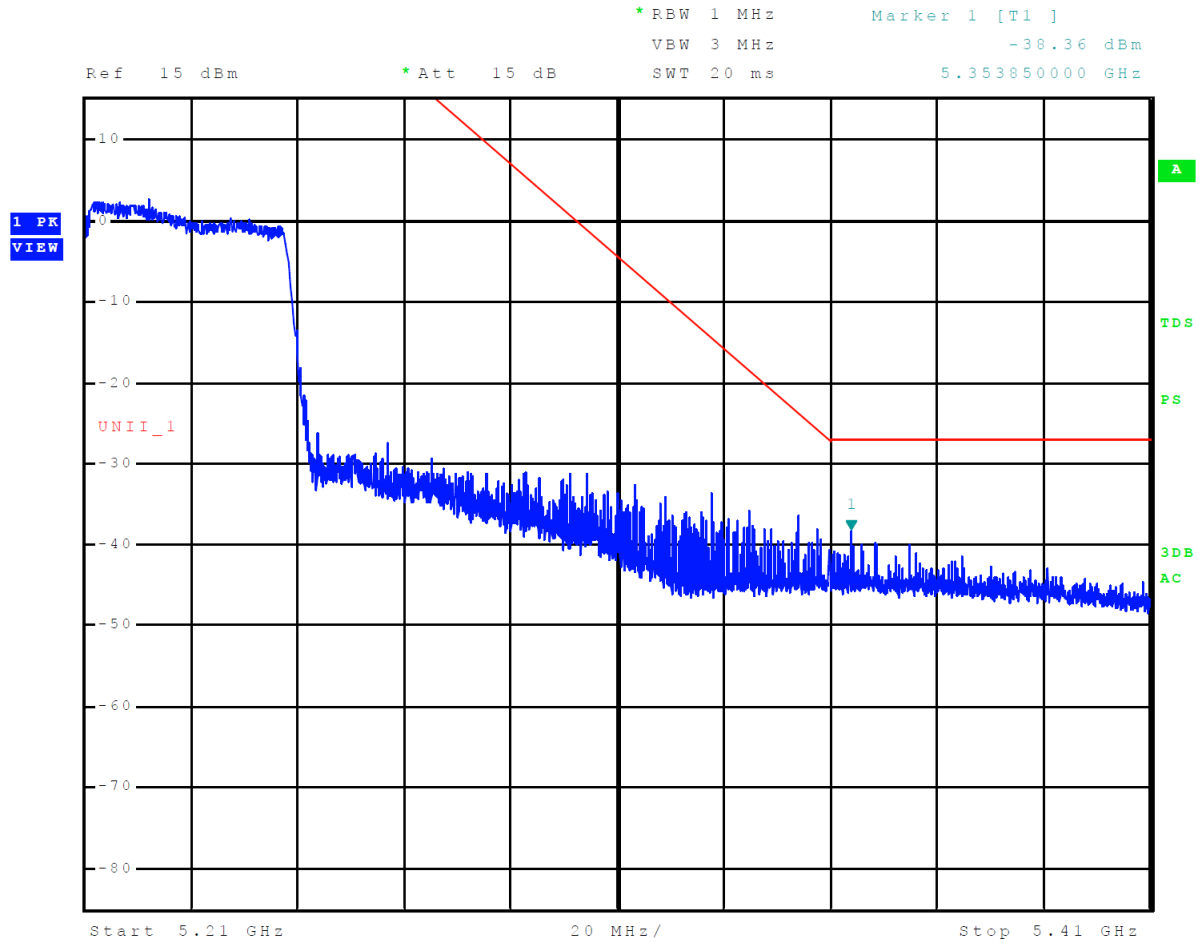


Figure 23 Plot of Upper Band Edge Across 5725-5850 MHz Mode 12 U-NII-3 (802.11a)

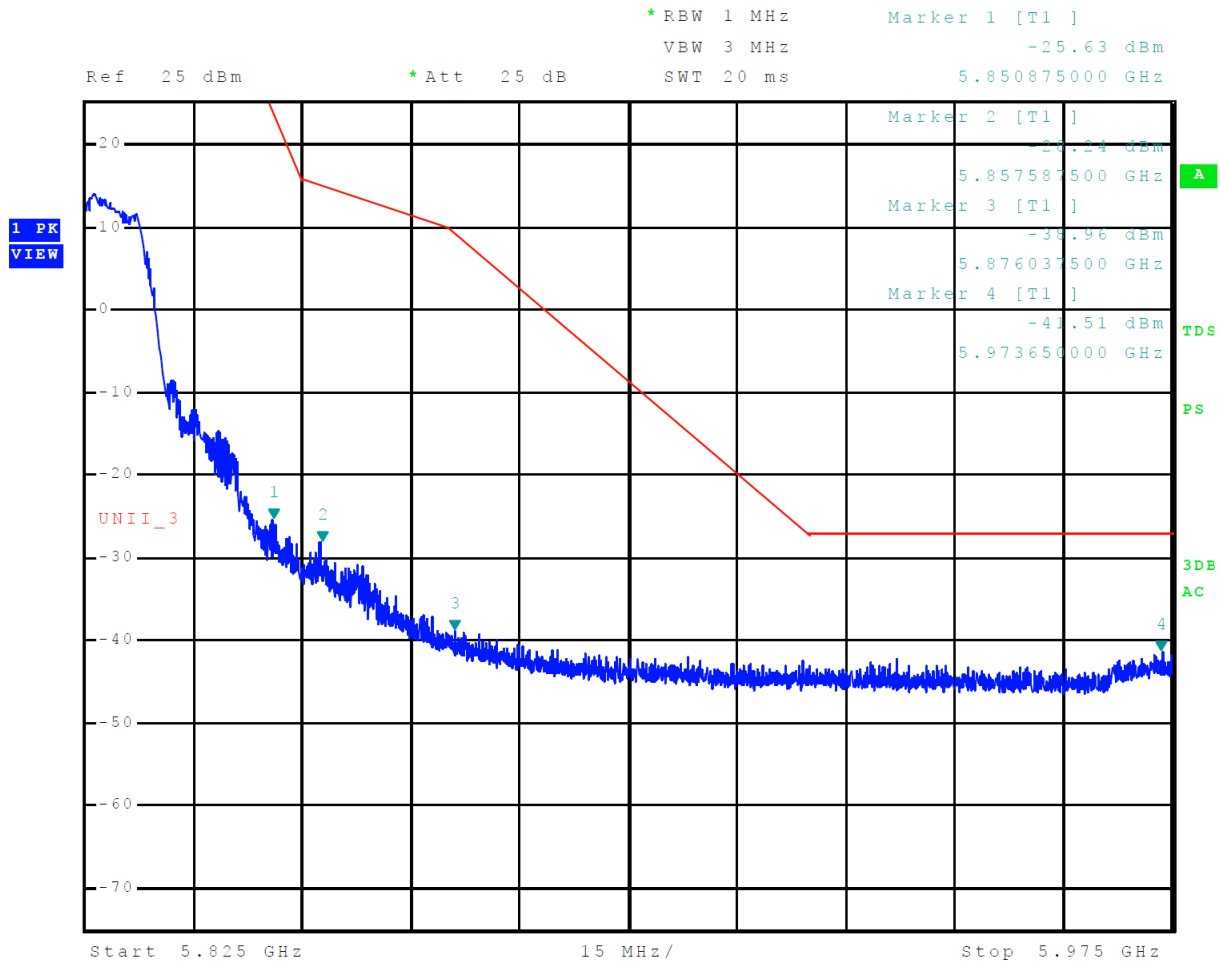


Figure 24 Plot of Upper Band Edge Across 5725-5850 MHz Mode 13 U-NII-3 (802.11n)

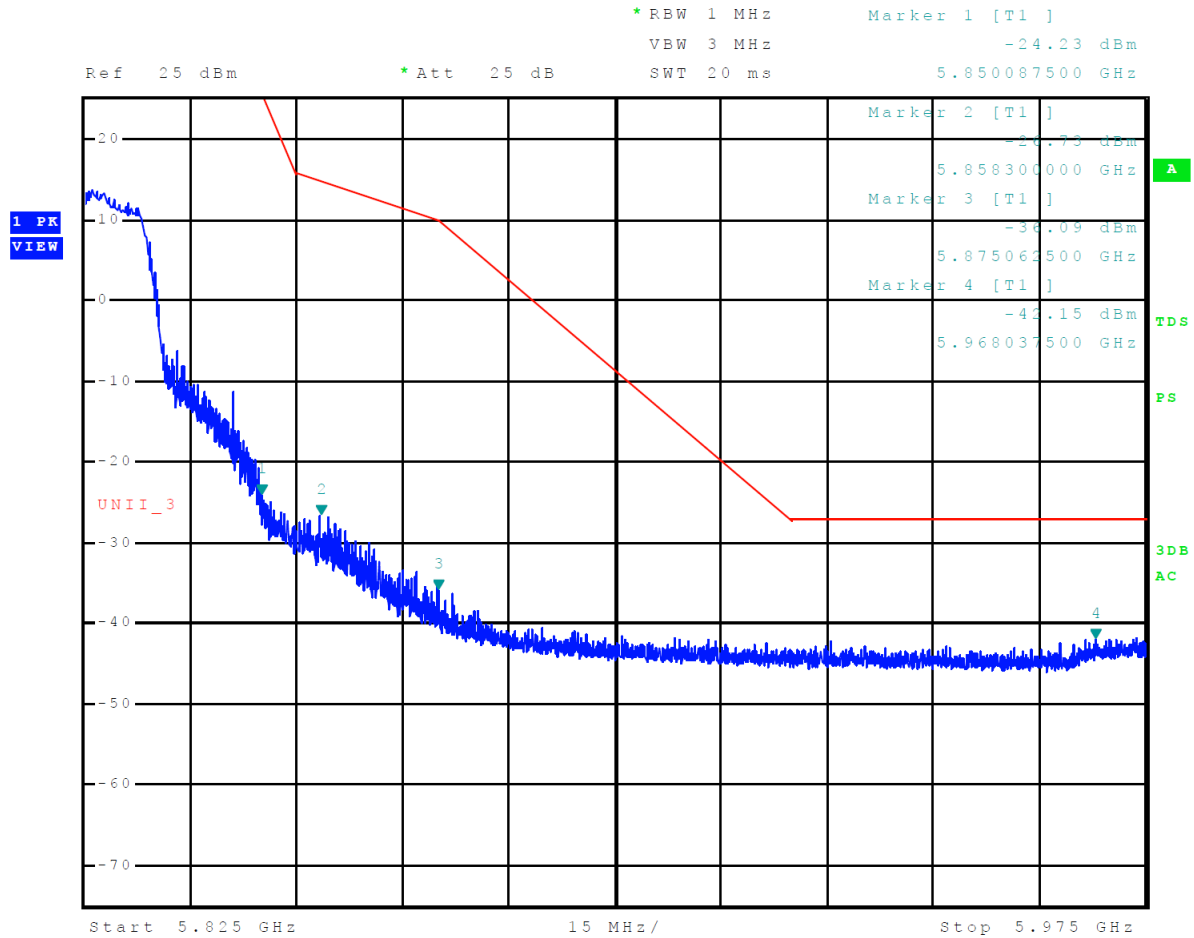


Figure 25 Plot of Upper Band Edge Across 5725-5850 MHz Mode 14 U-NII-3 (802.11n40)

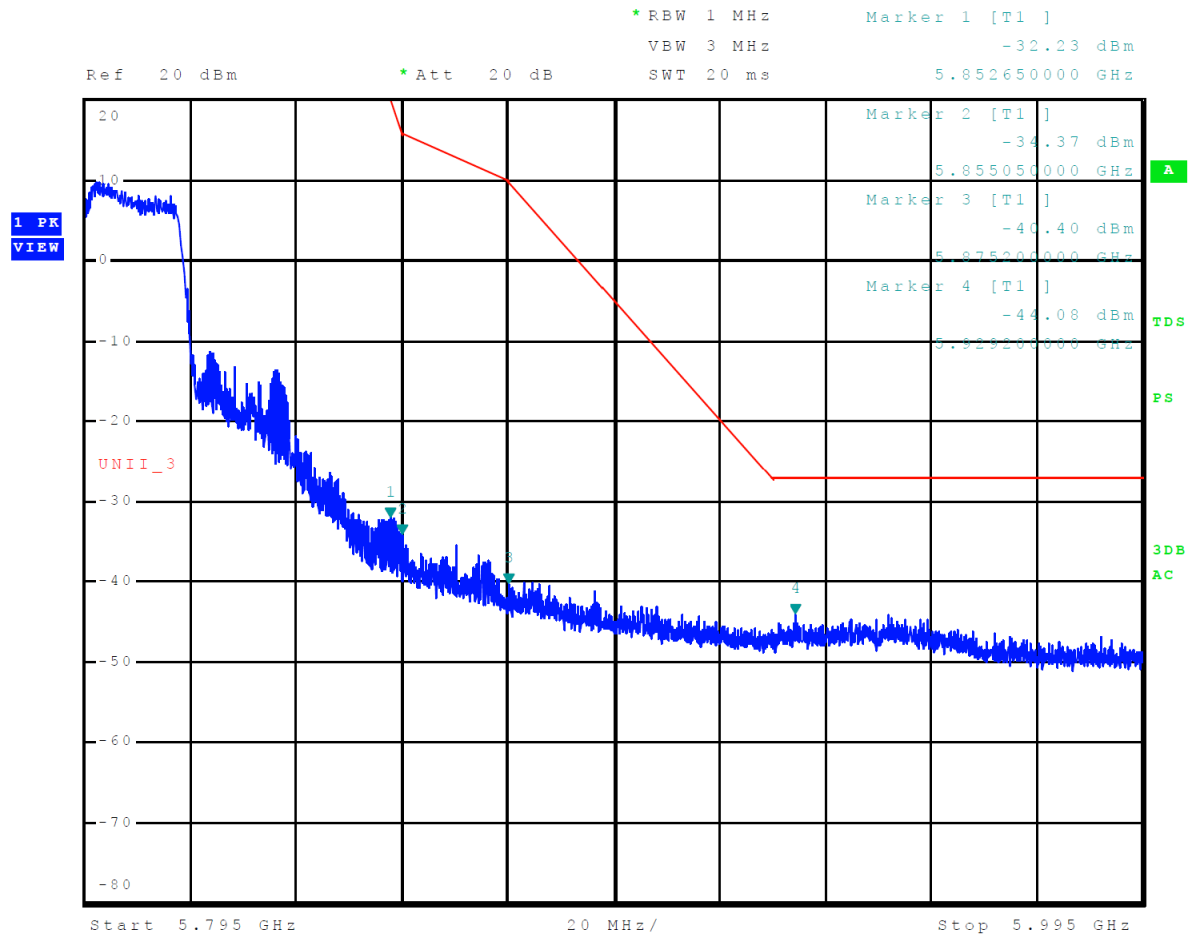


Figure 26 Plot of Upper Band Edge Across 5725-5850 MHz Mode 15 U-NII-3 (802.11ac80)

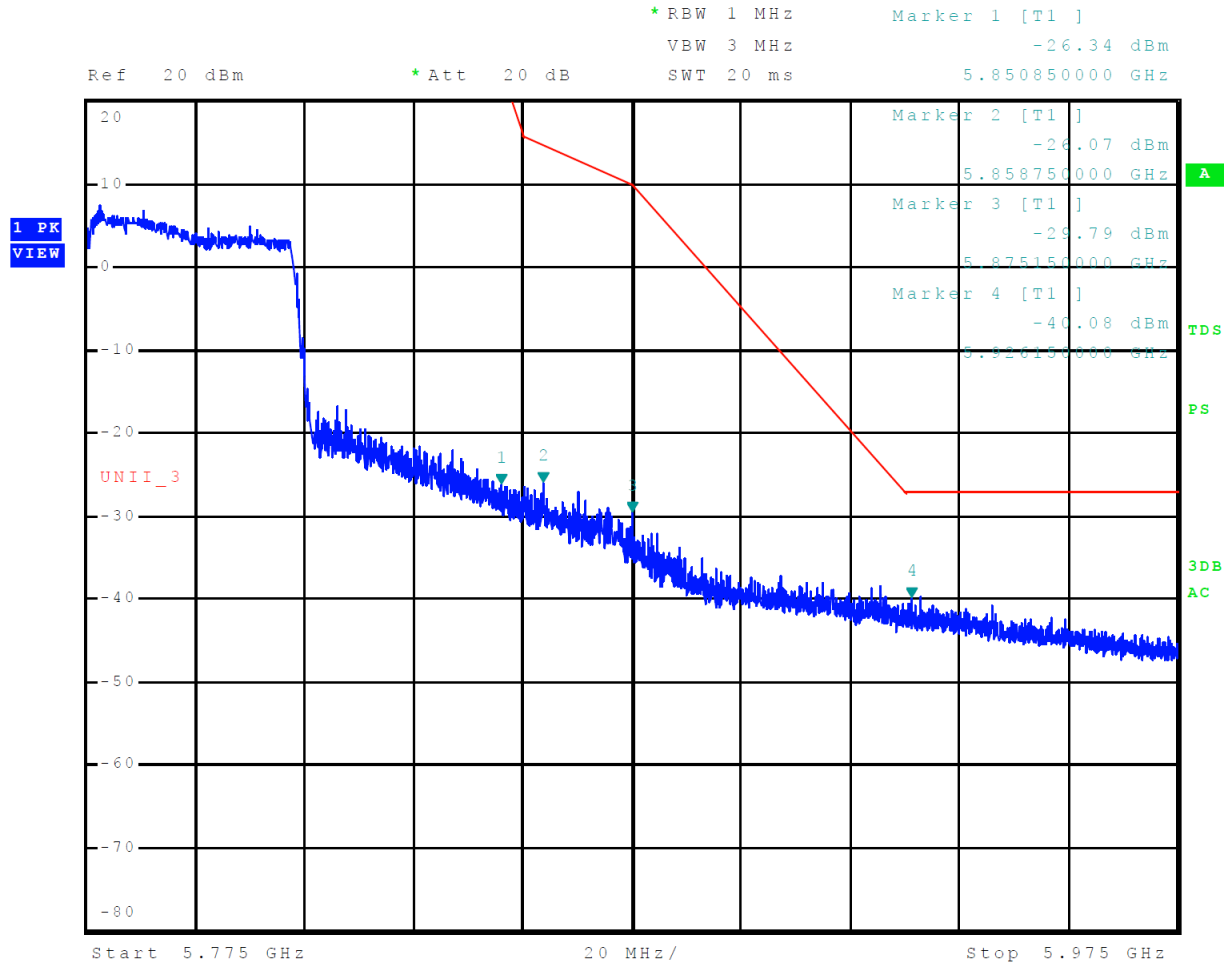


Figure 27 Plot of 26-dB Occupied Bandwidth 5150-5250 MHz Mode 8 U-NII-1 (802.11a)

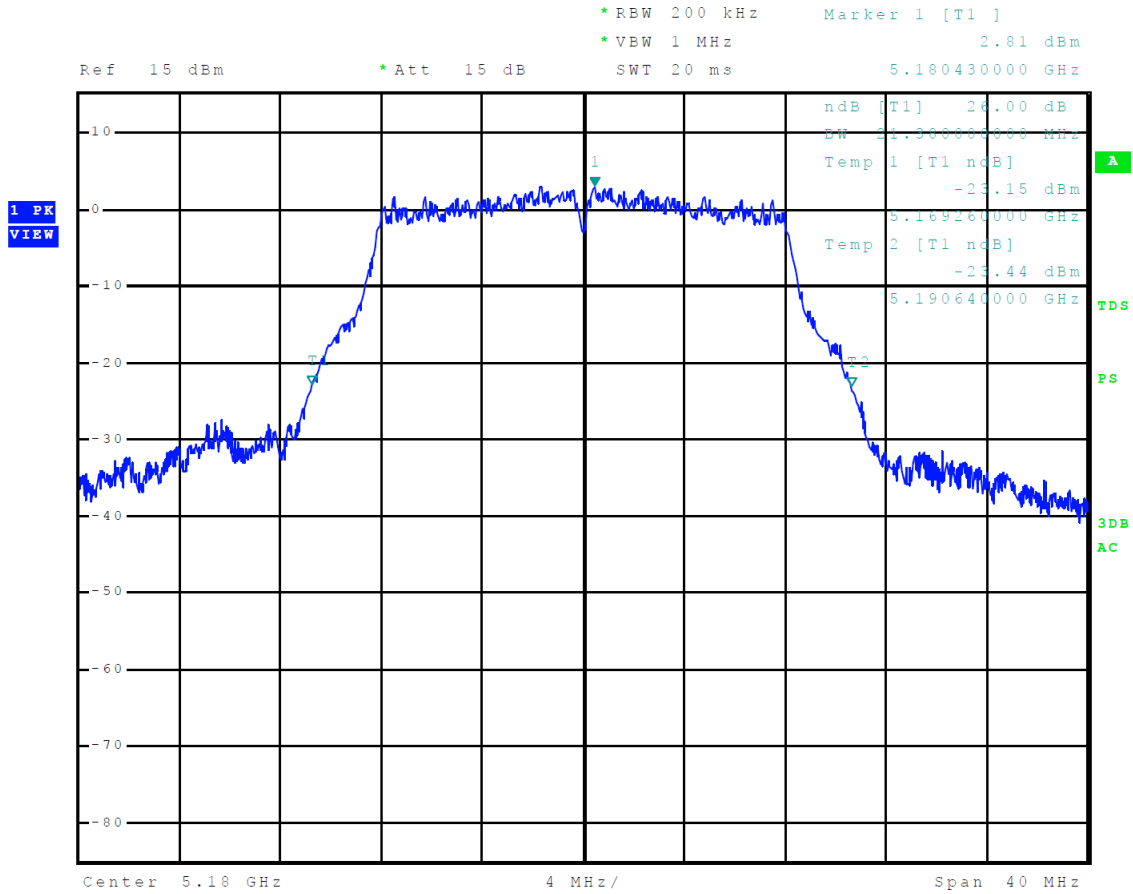
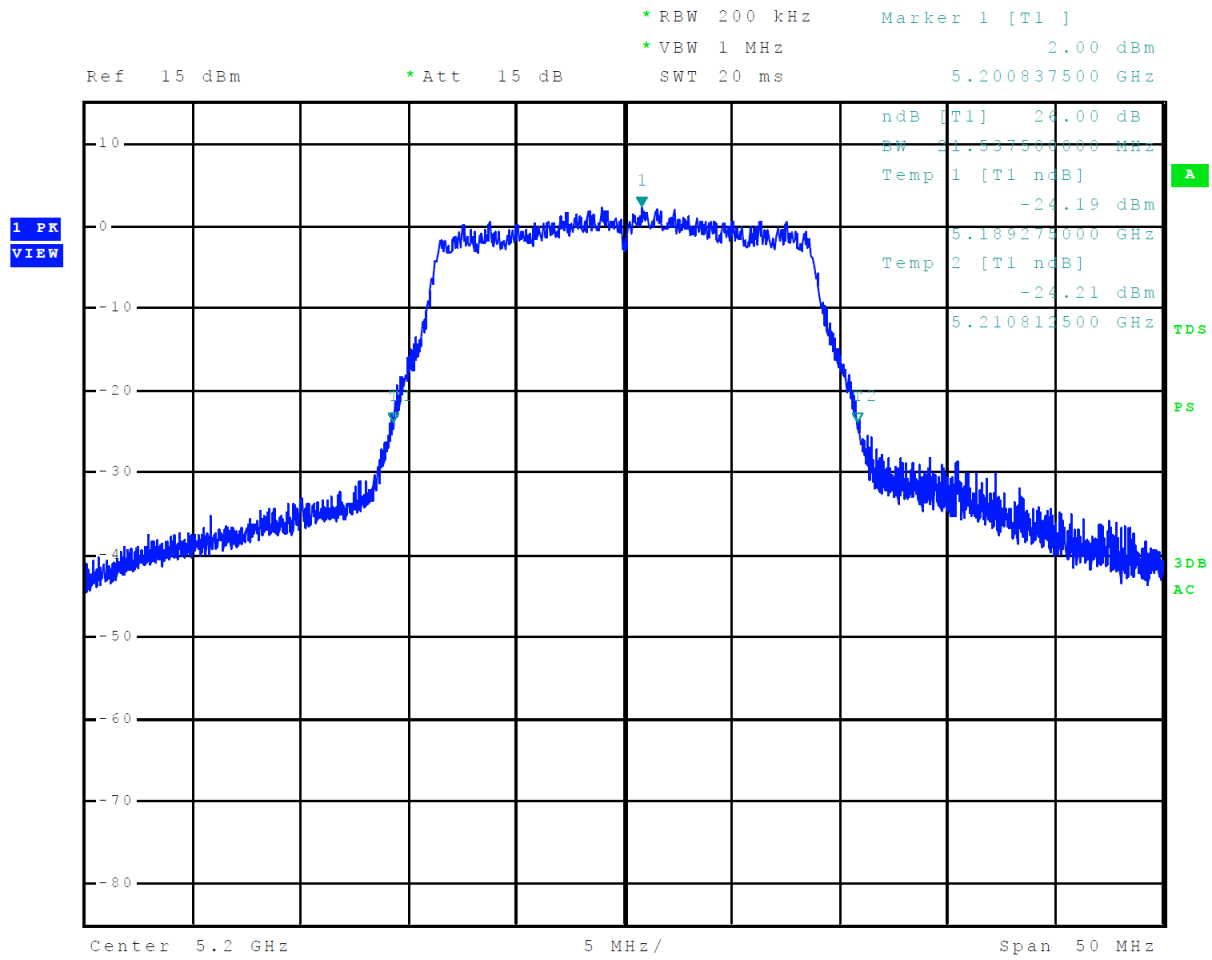
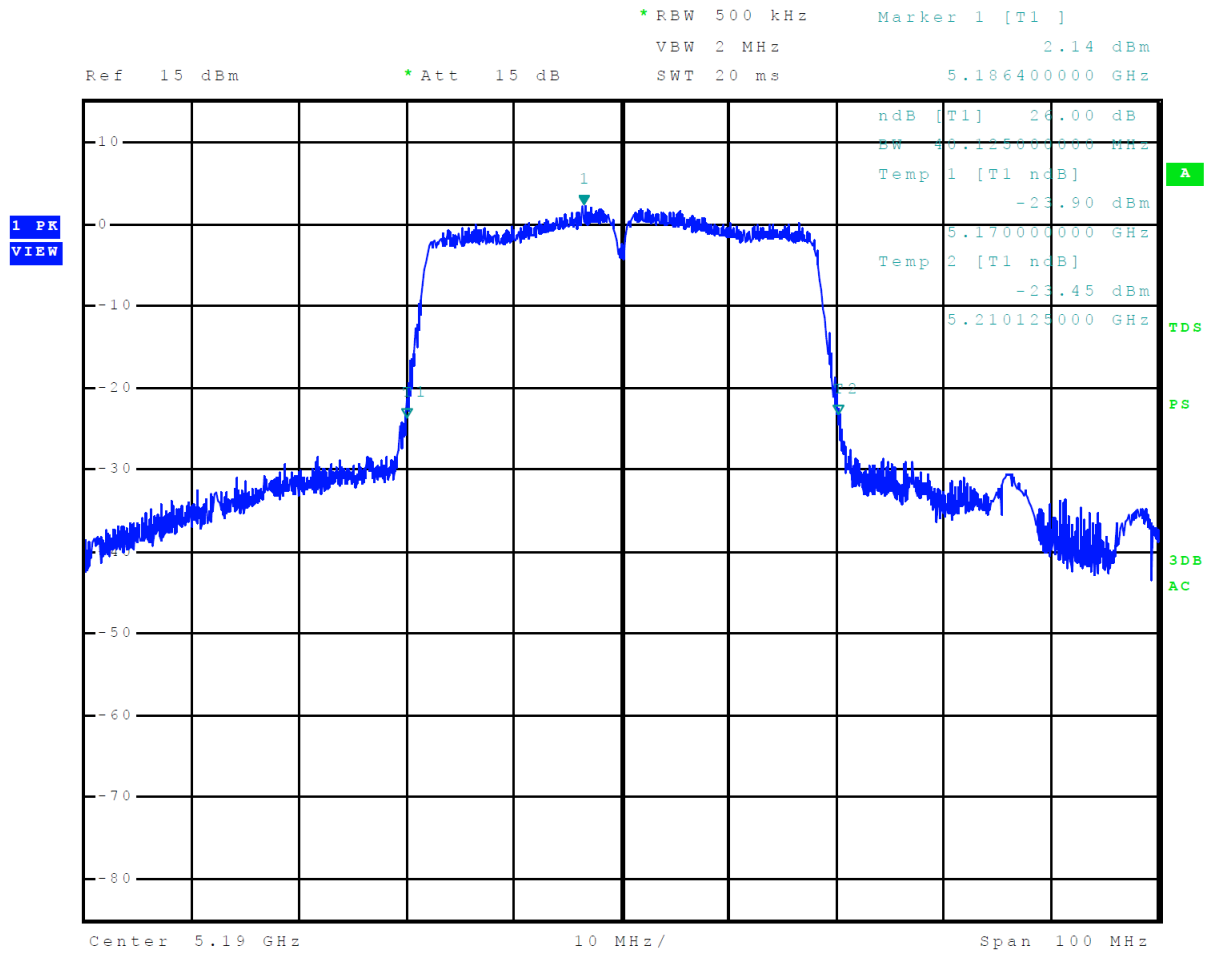


Figure 28 Plot of 26-dB Occupied Bandwidth 5150-5250 MHz Mode 9 U-NII-1 (802.11n)



**Figure 29 Plot of 26-dB Occupied Bandwidth 5150-5250 MHz Mode 10 U-NII-1 (802.11n40)**





**Figure 30 Plot of 26-dB Occupied Bandwidth 5150-5250 MHz Mode 11 U-NII-1 (802.11ac80)**

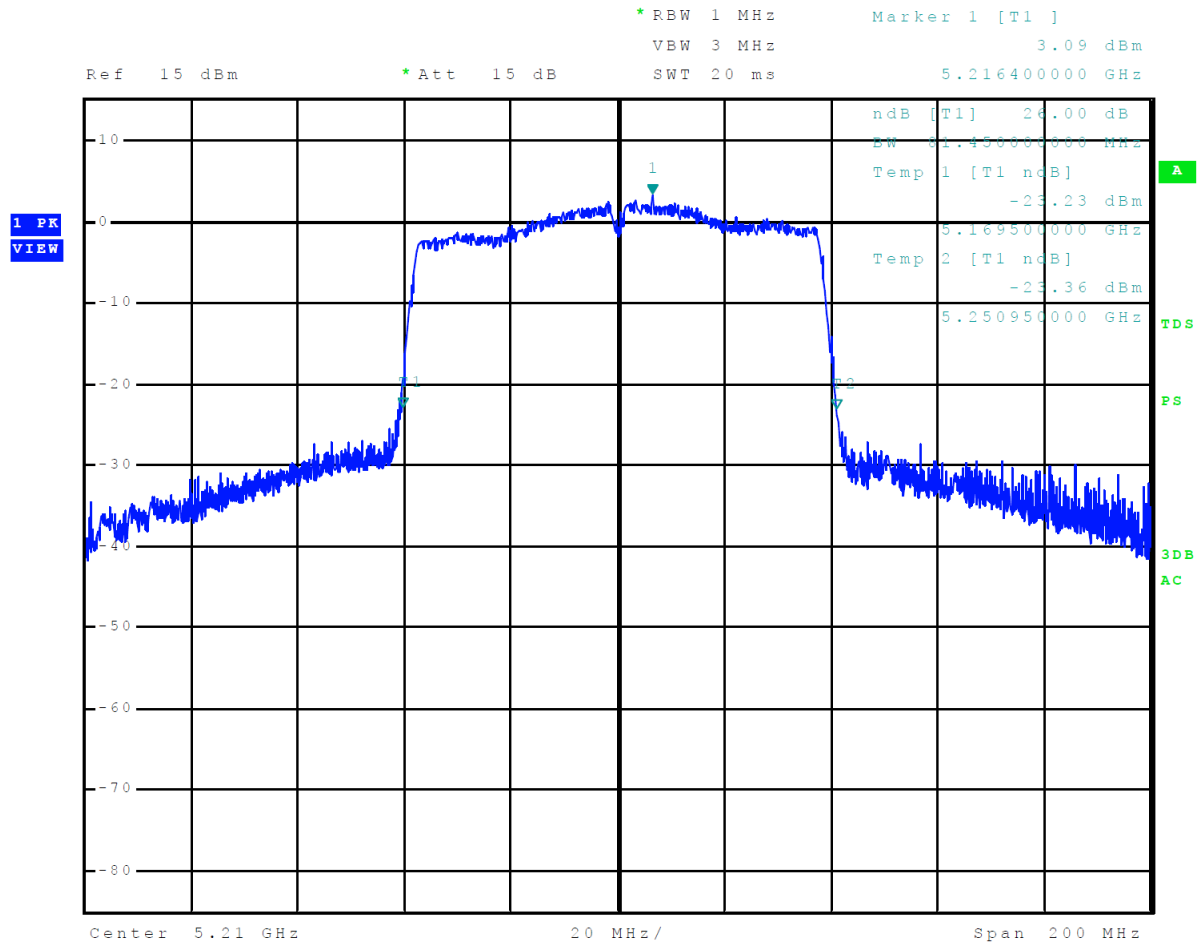


Figure 31 Plot of 26-dB Occupied Bandwidth 5725-5850 MHz Mode 12 U-NII-3 (802.11a)

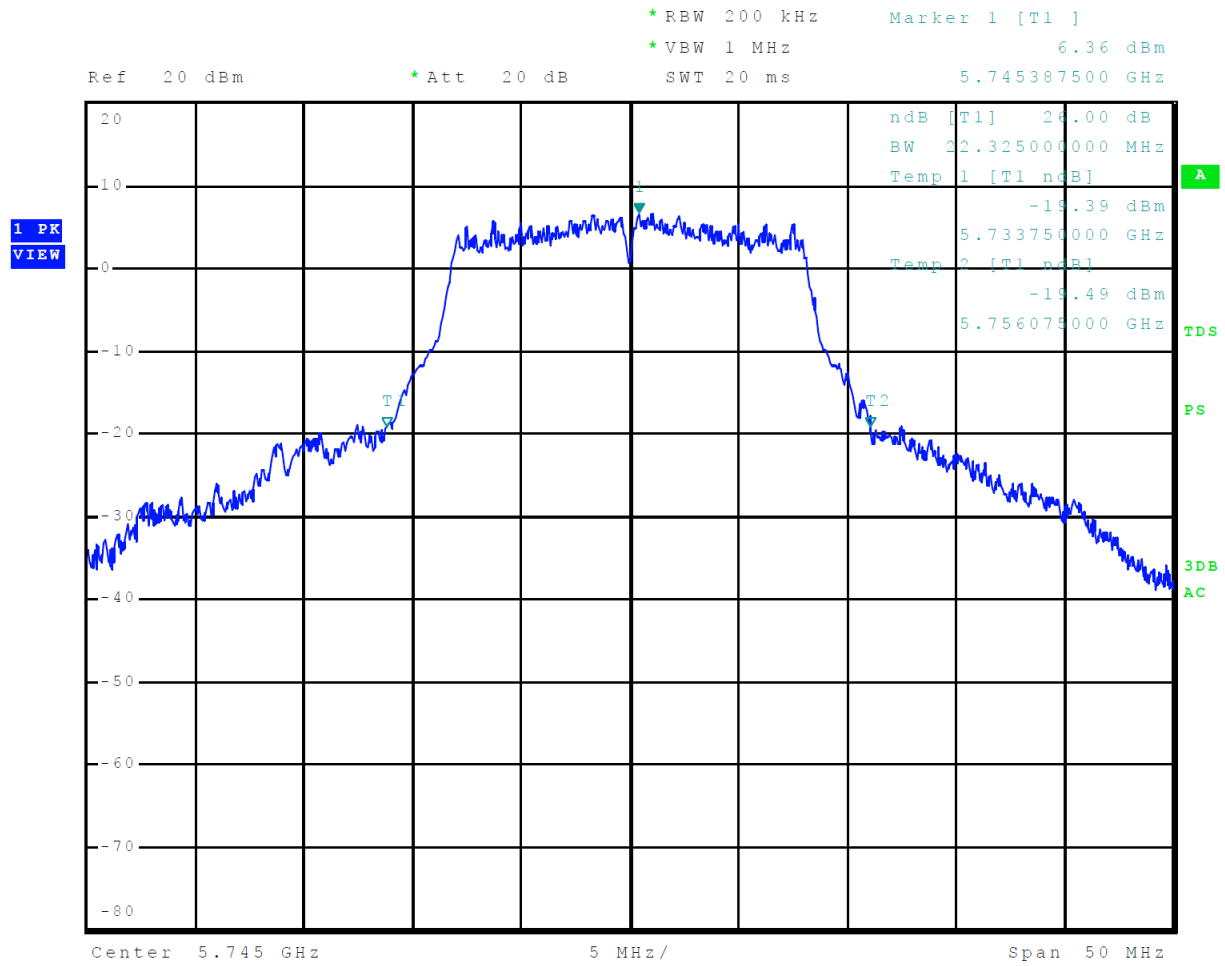
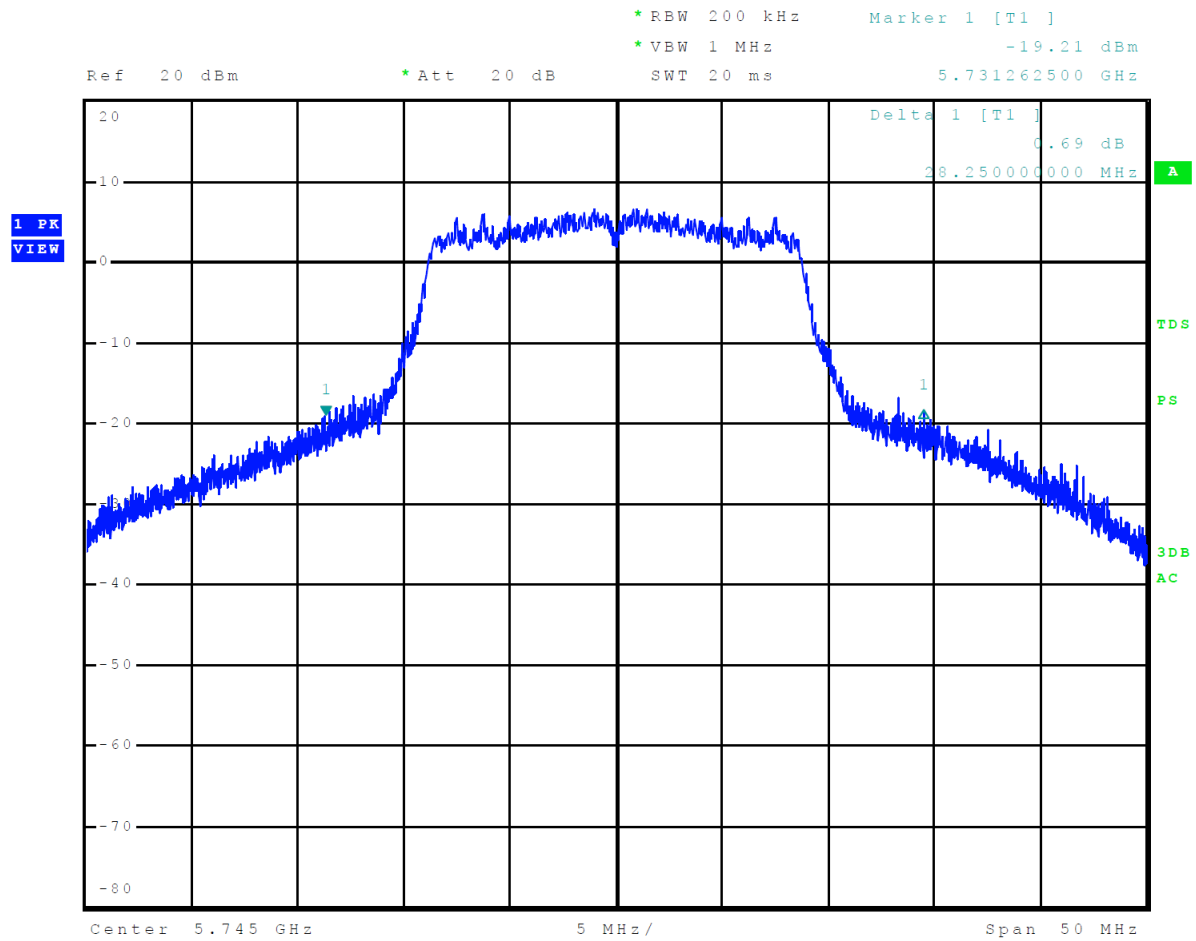
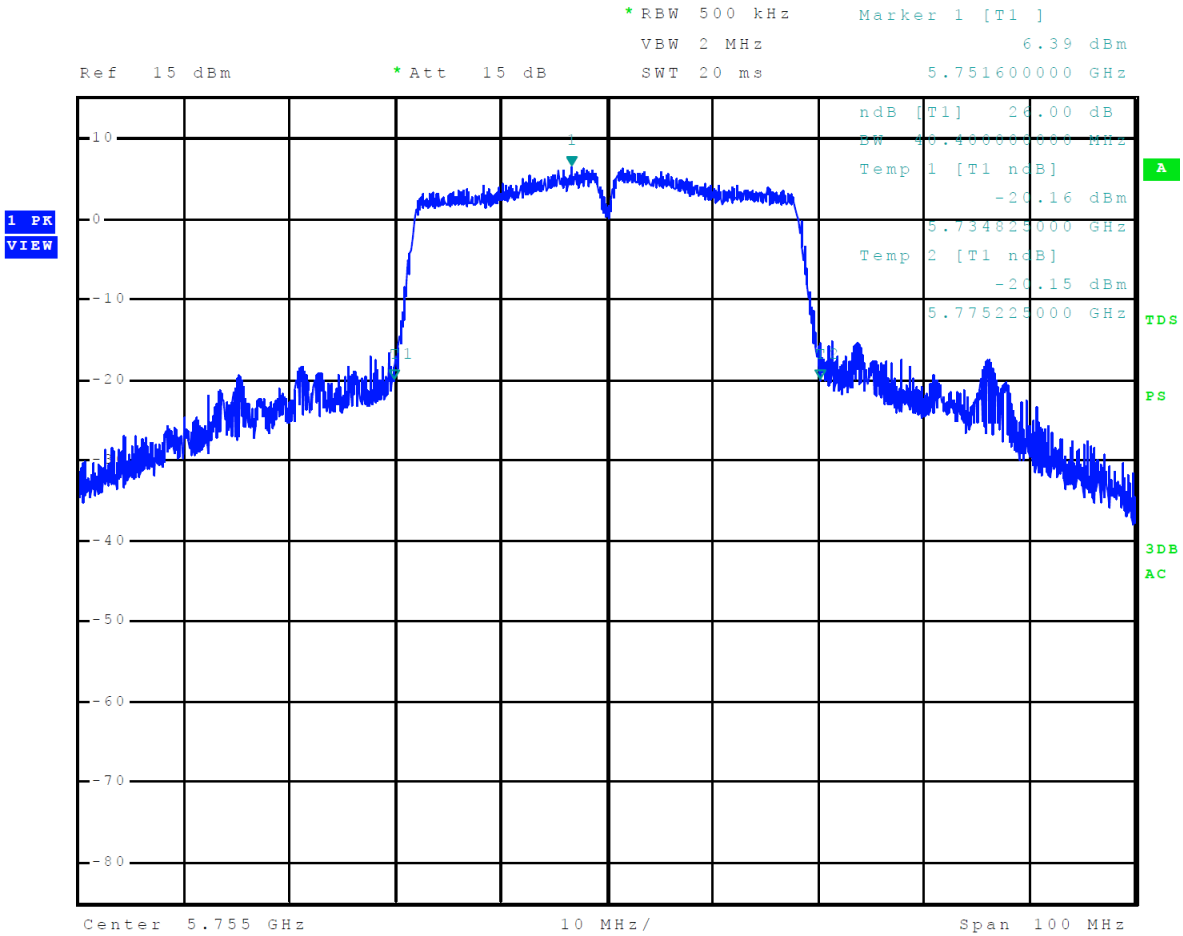


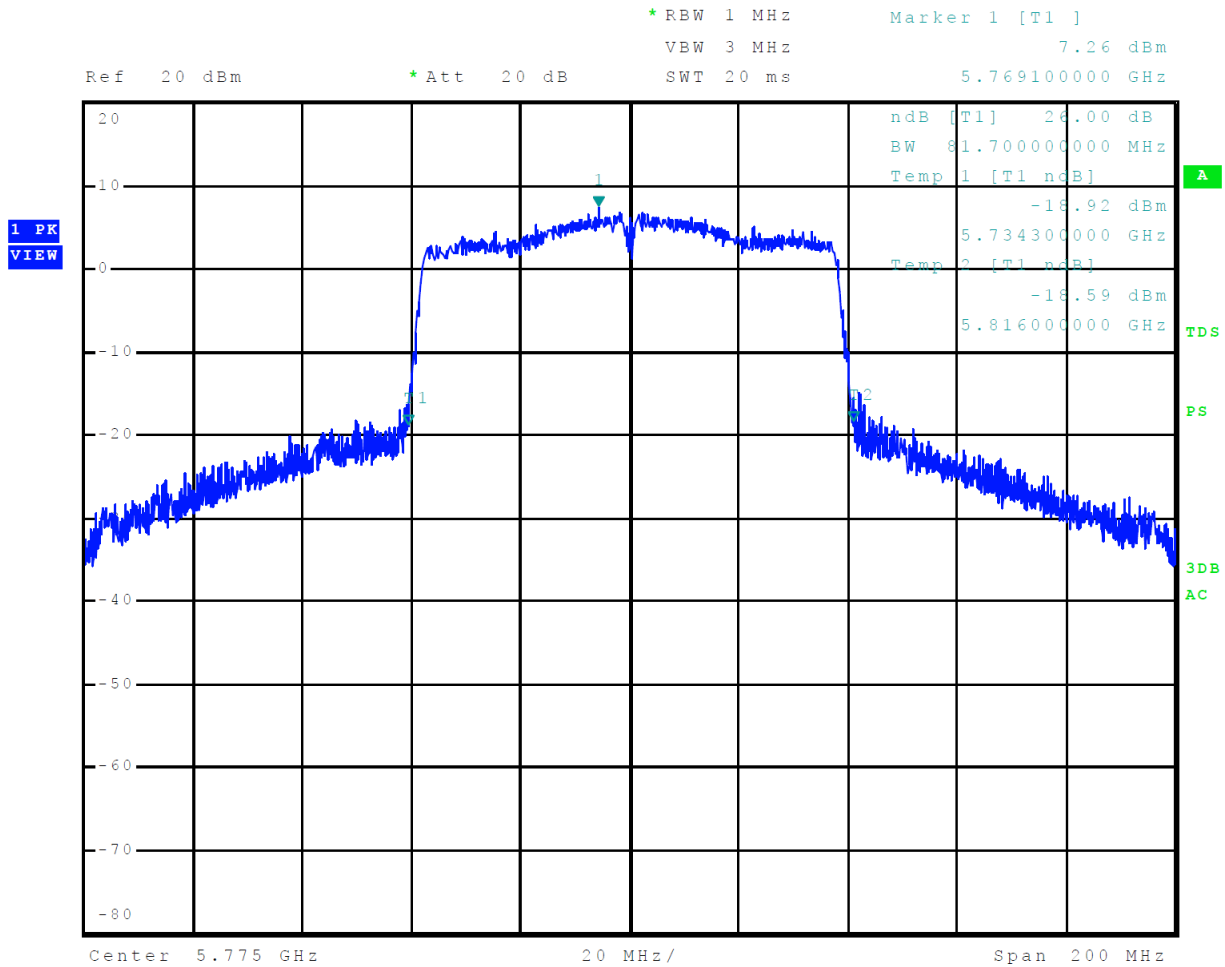
Figure 32 Plot of 26-dB Occupied Bandwidth 5725-5850 MHz Mode 13 U-NII-3 (802.11n)



**Figure 33 Plot of 26-dB Occupied Bandwidth 5725-5850 MHz Mode 14 U-NII-3 (802.11n40)**



**Figure 34 Plot of 26-dB Occupied Bandwidth 5725-5850 MHz Mode 15 U-NII-3 (802.11ac80)**



**Figure 35 Plot of 99% Occupied Bandwidth 5150-5250 MHz Mode 8 U-NII-1 (802.11a)**

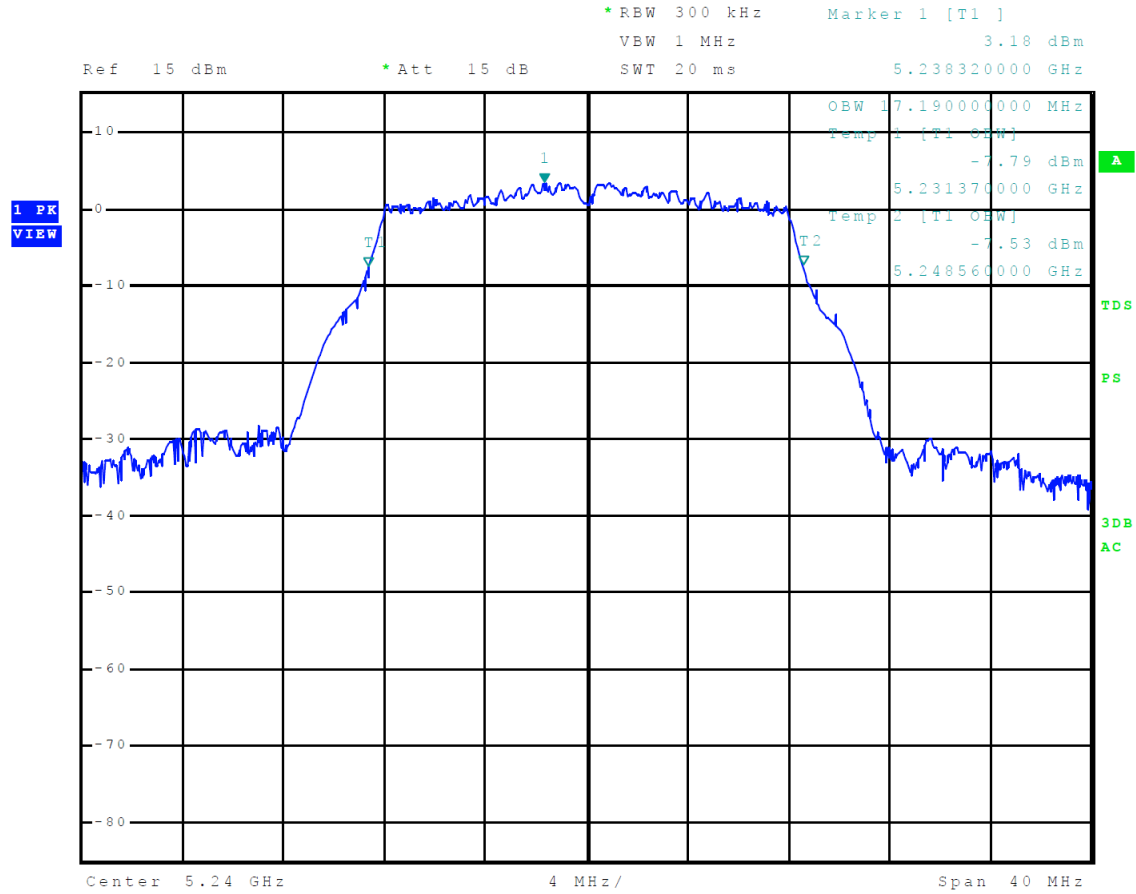
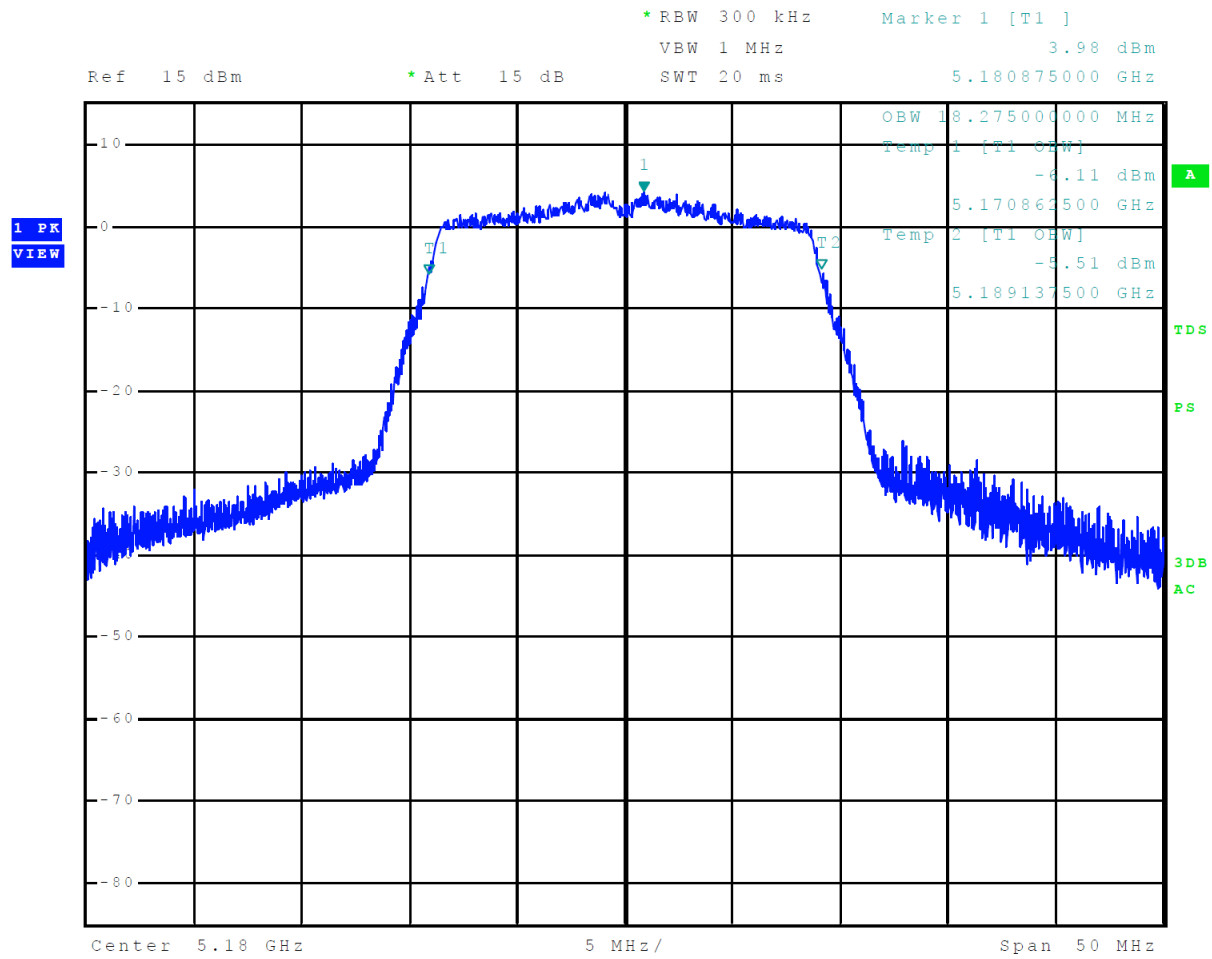
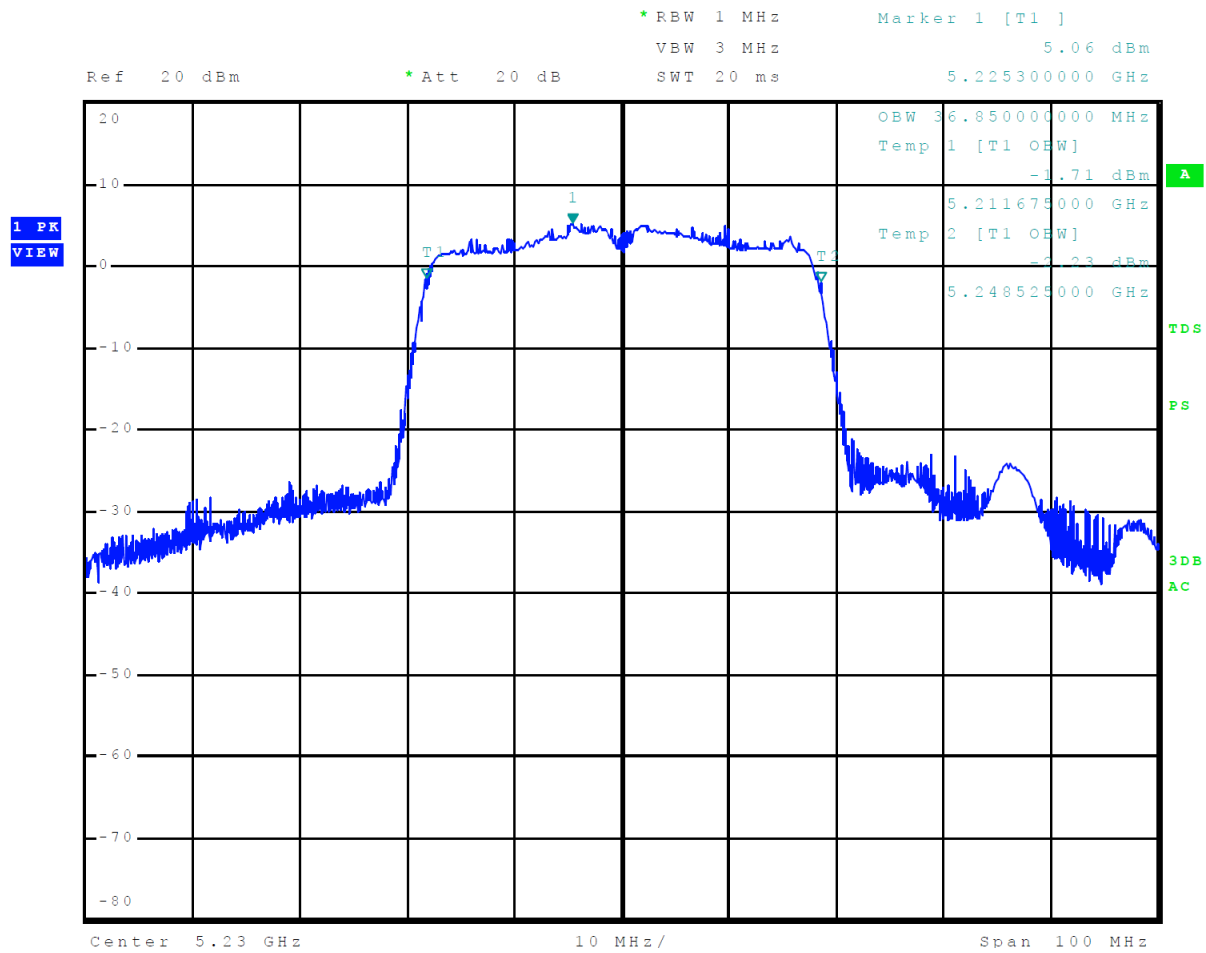


Figure 36 Plot of 99% Occupied Bandwidth 5150-5250 MHz Mode 9 U-NII-1 (802.11n)



**Figure 37 Plot of 99% Occupied Bandwidth 5150-5250 MHz Mode 10 U-NII-1 (802.11n40)**





**Figure 38 Plot of 99% Occupied Bandwidth 5150-5250 MHz Mode 11 U-NII-1 (802.11ac80)**

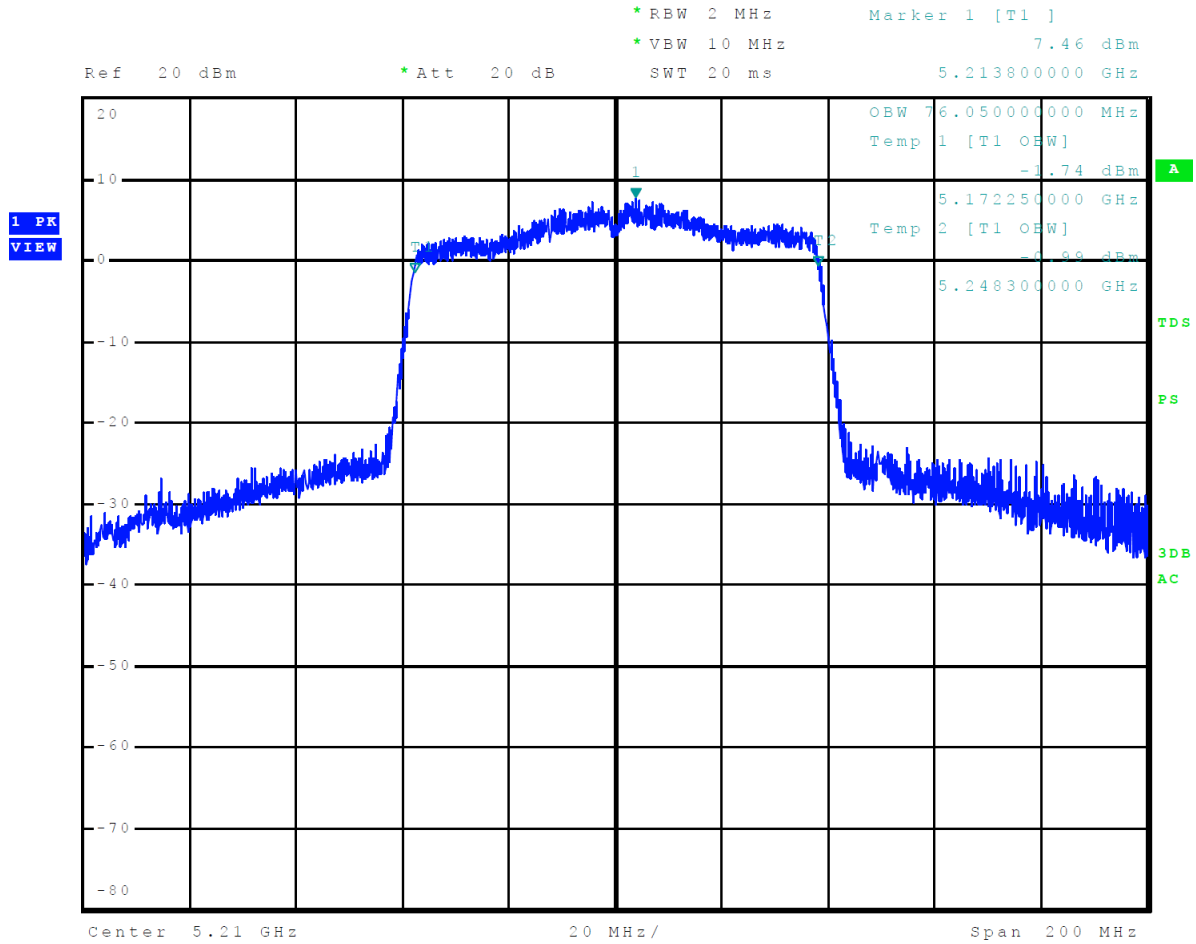


Figure 39 Plot of 99% Occupied Bandwidth 5725-5850 MHz Mode 12 U-NII-3 (802.11a)

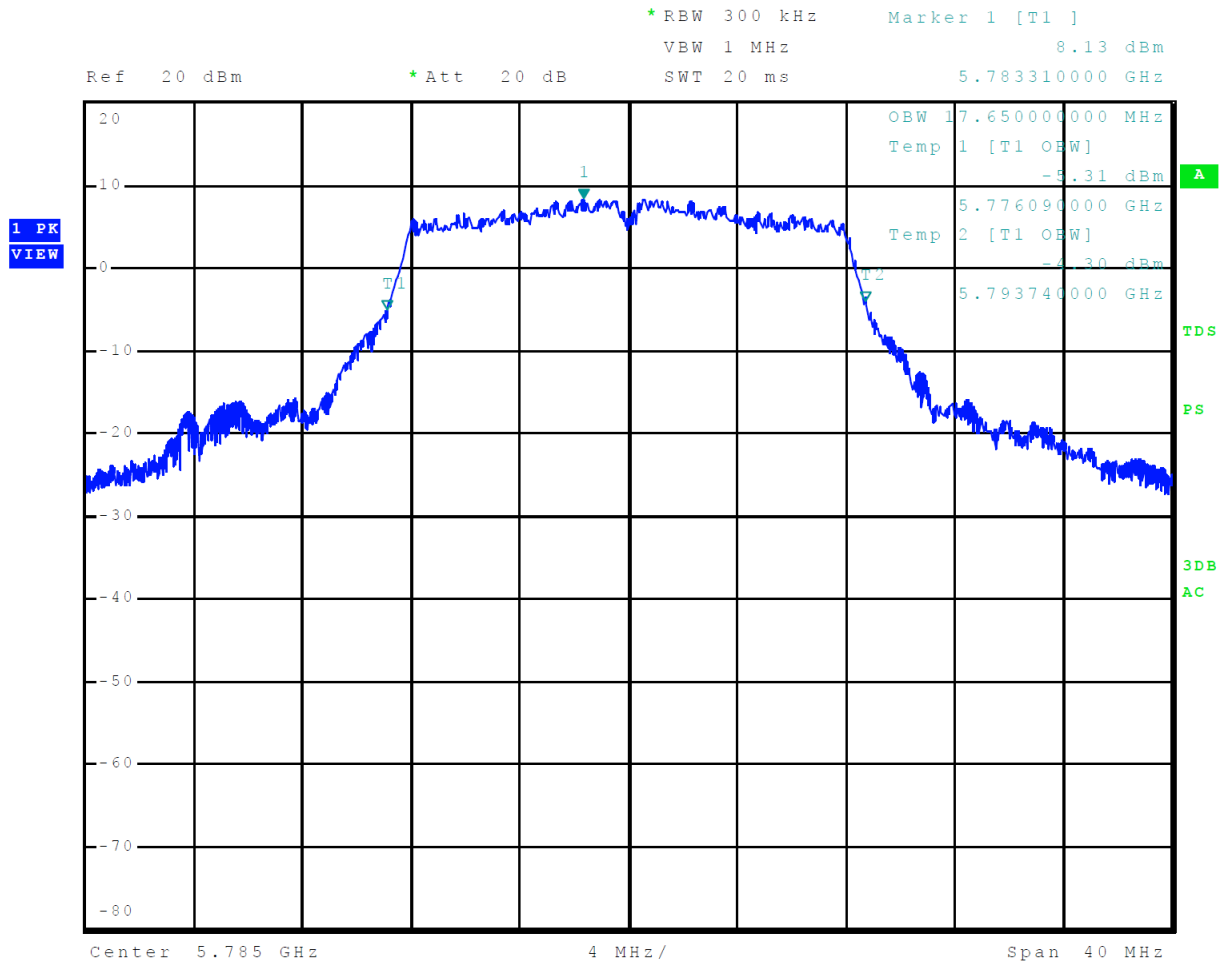


Figure 40 Plot of 99% Occupied Bandwidth 5725-5850 MHz Mode 13 U-NII-3 (802.11n)

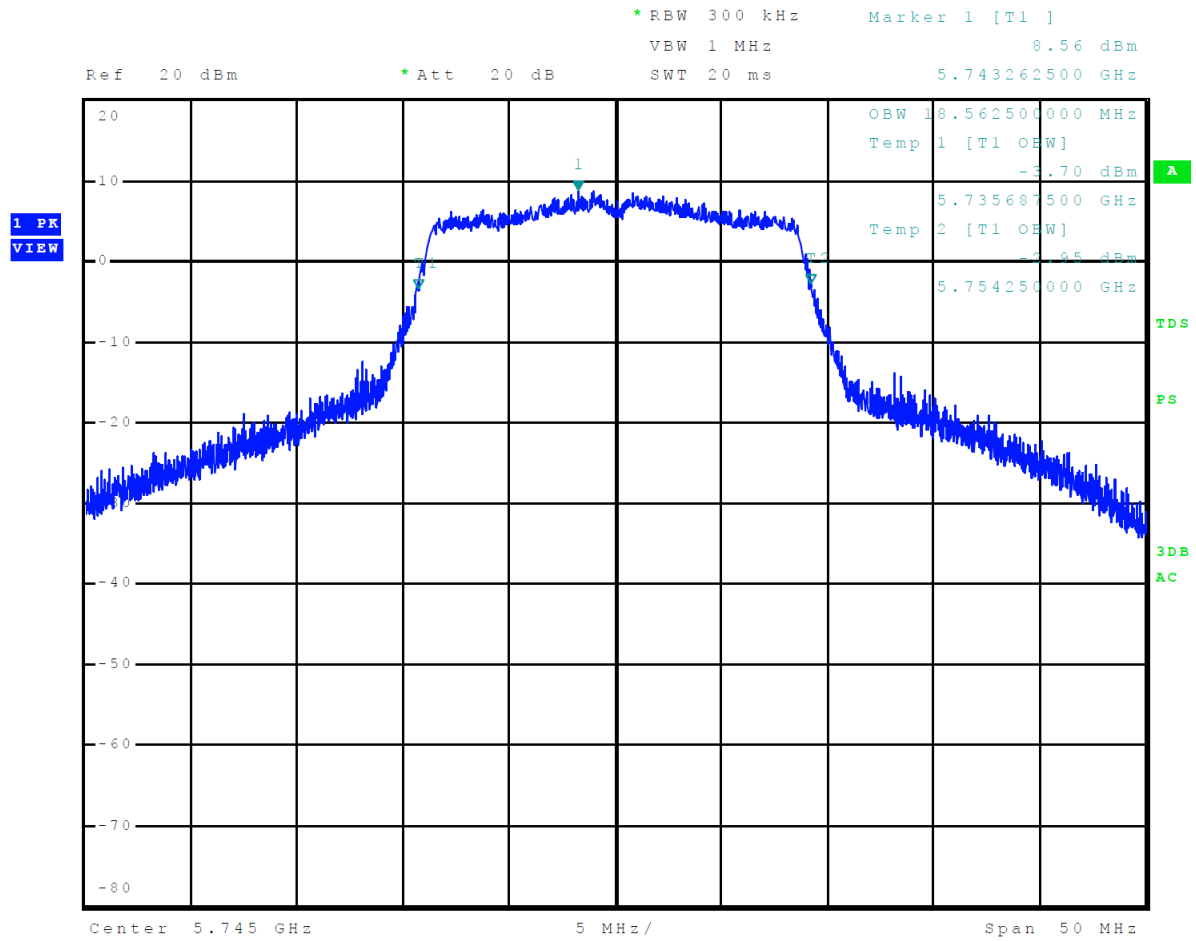


Figure 41 Plot of 99% Occupied Bandwidth 5725-5850 MHz Mode 14 U-NII-3 (802.11n40)

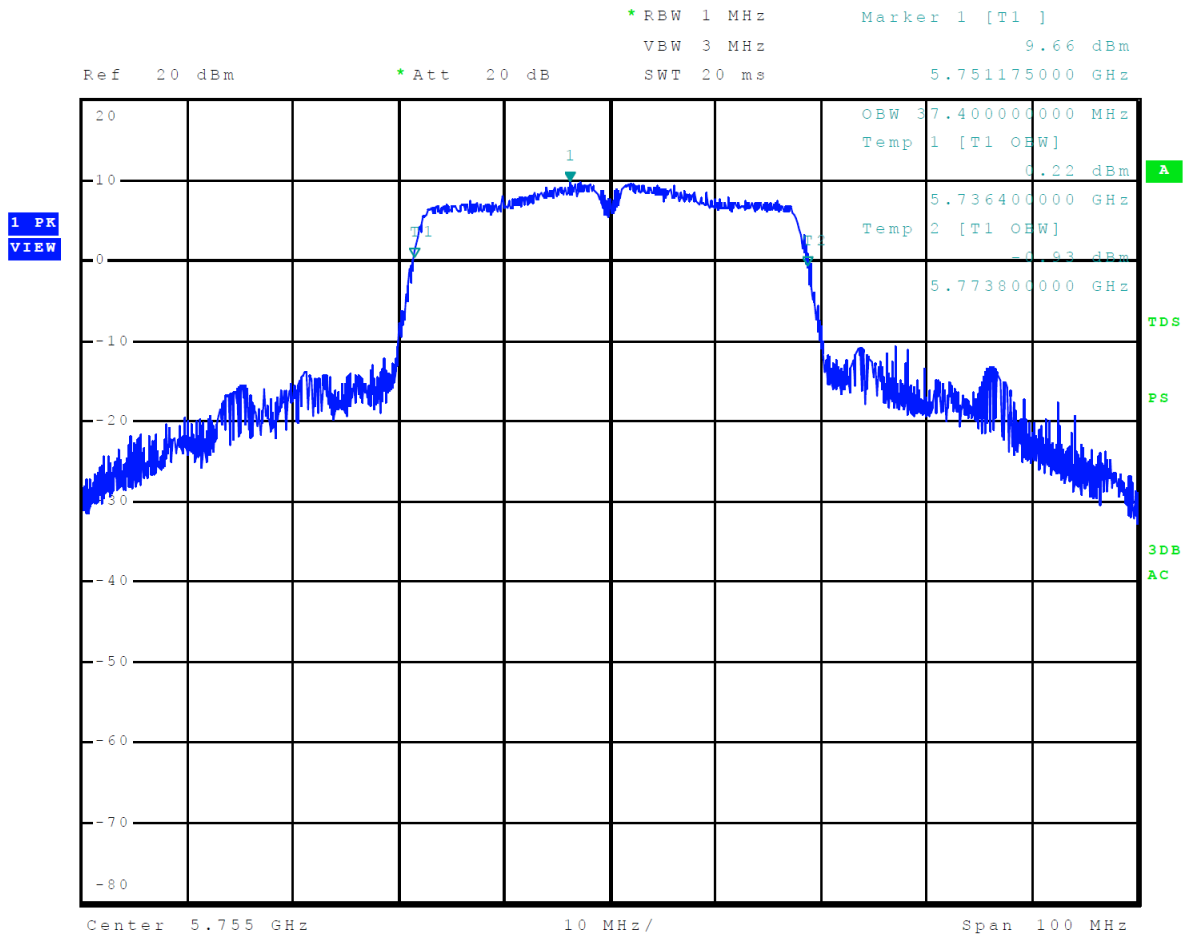


Figure 42 Plot of 99% Occupied Bandwidth 5725-5850 MHz Mode 15 U-NII-3 (802.11ac80)

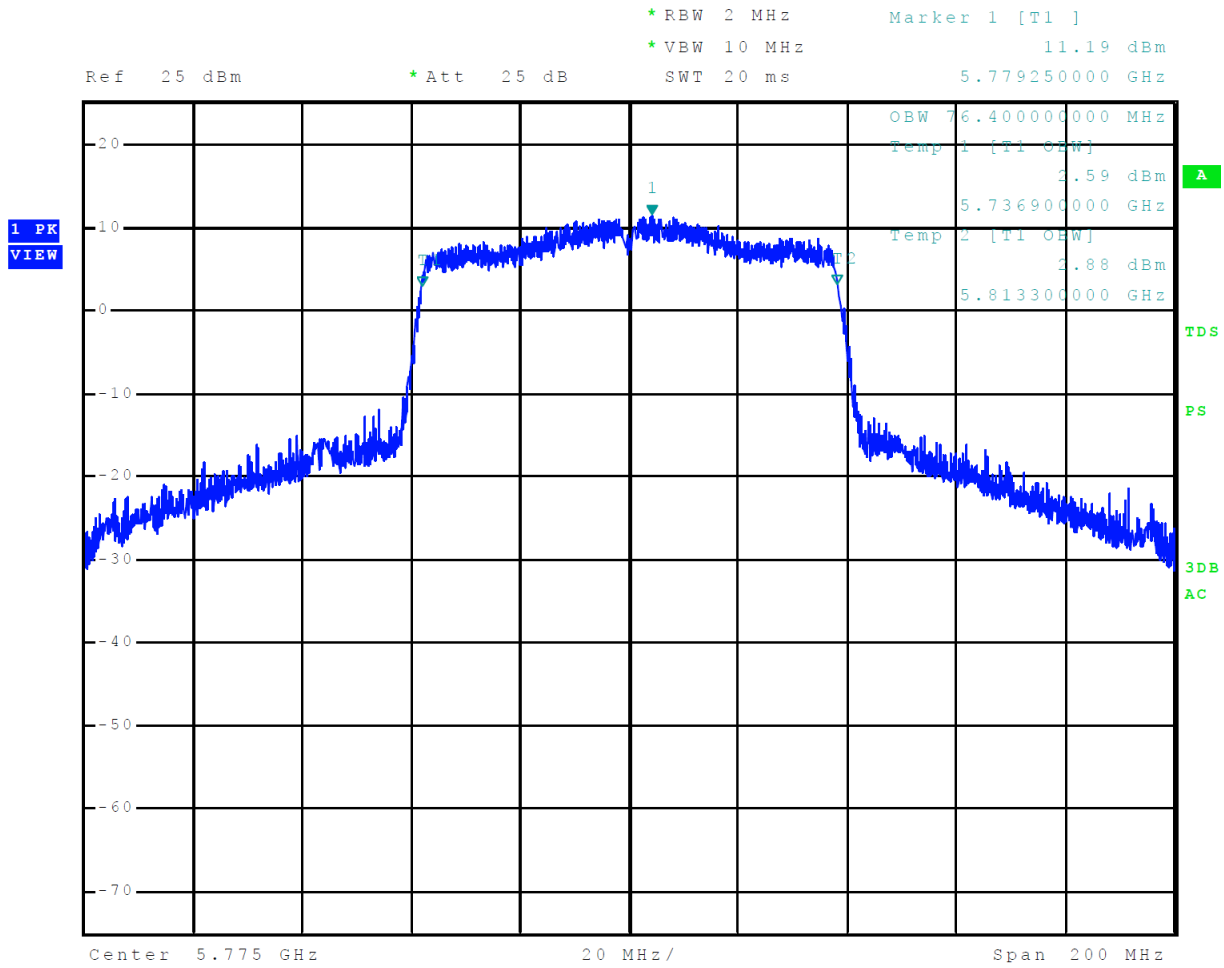


Figure 43 Plot of 6-dB Occupied Bandwidth 5725-5850 MHz Mode 12 U-NII-3 (802.11a)

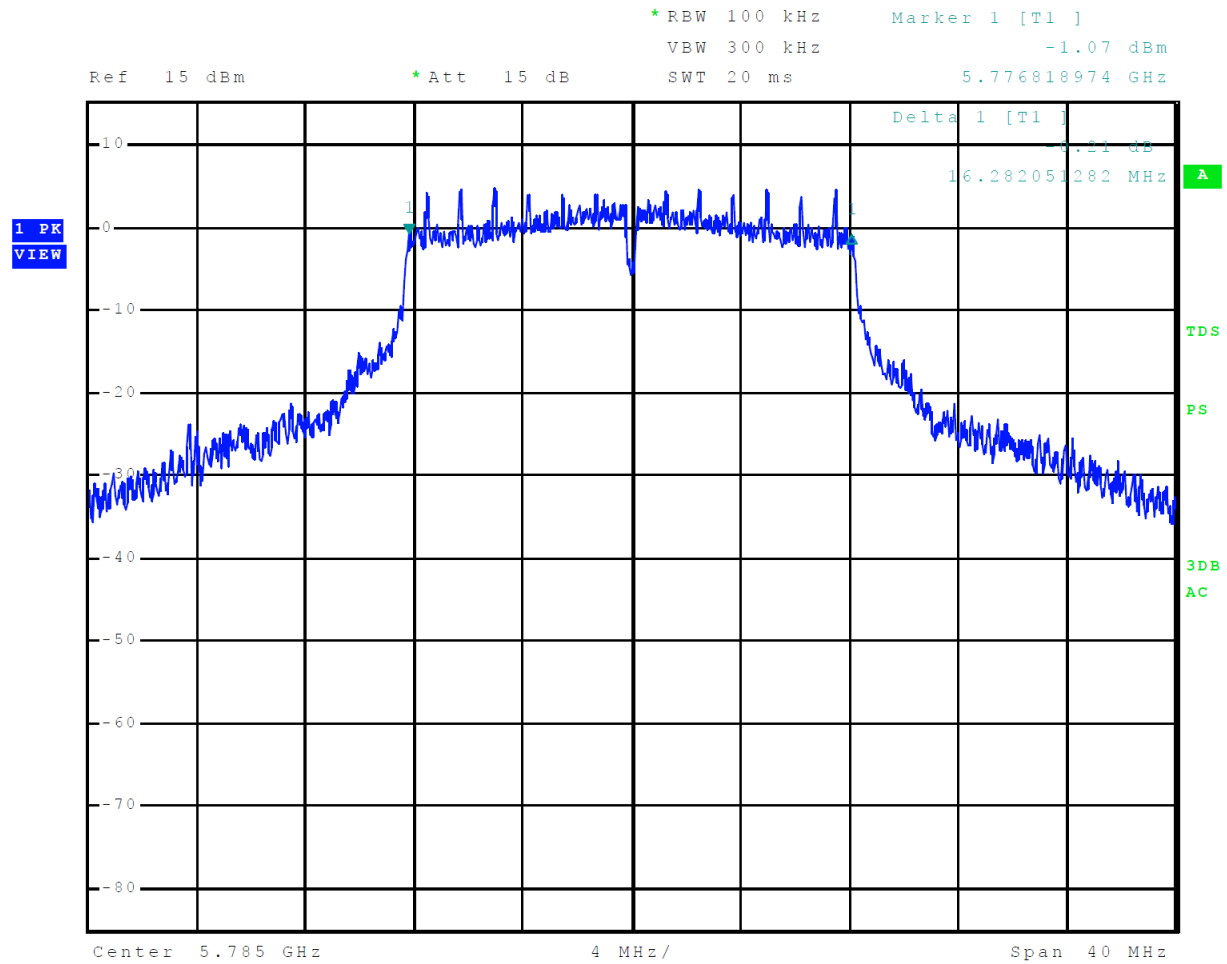


Figure 44 Plot of 6-dB Occupied Bandwidth 5725-5850 MHz Mode 13 U-NII-3 (802.11n)

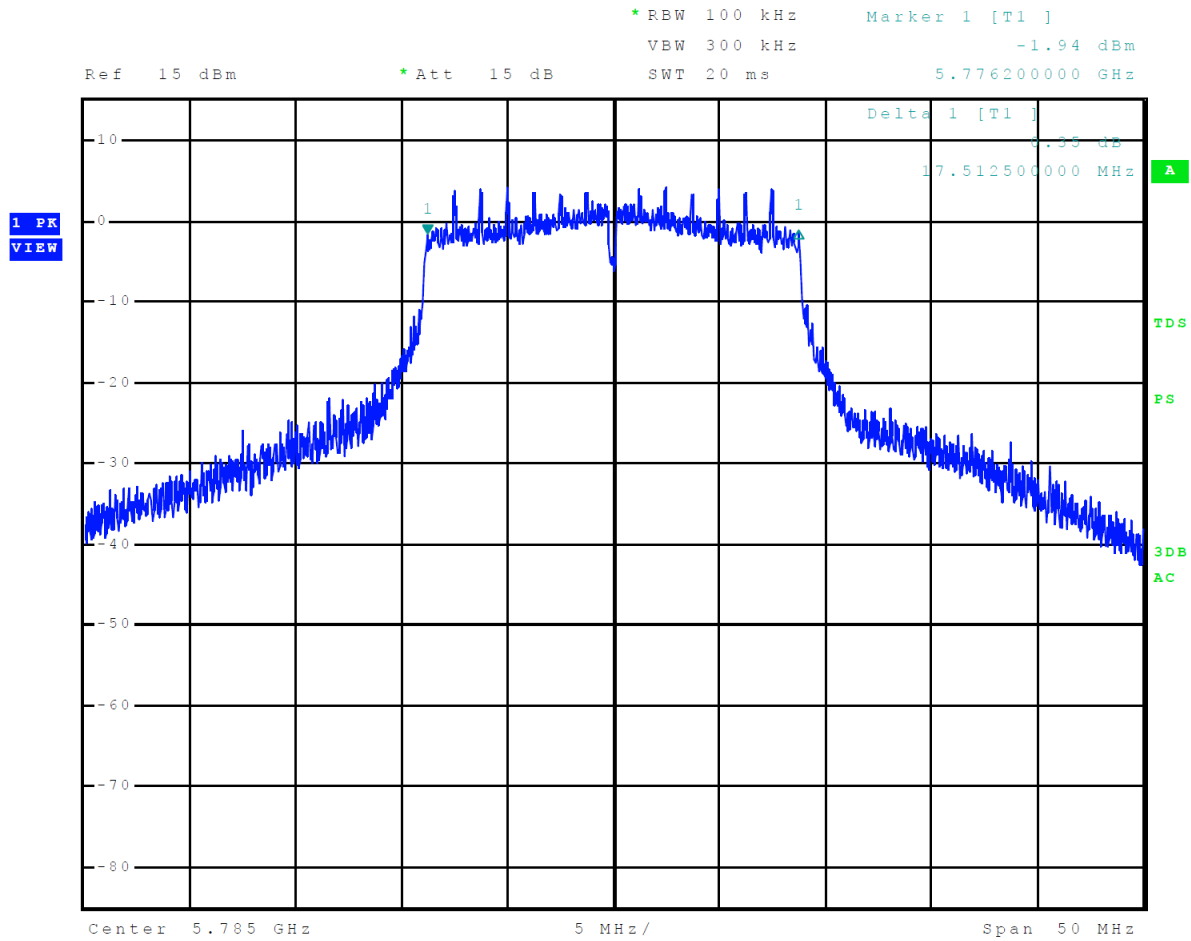


Figure 45 Plot of 6-dB Occupied Bandwidth 5725-5850 MHz Mode 14 U-NII-3 (802.11n40)

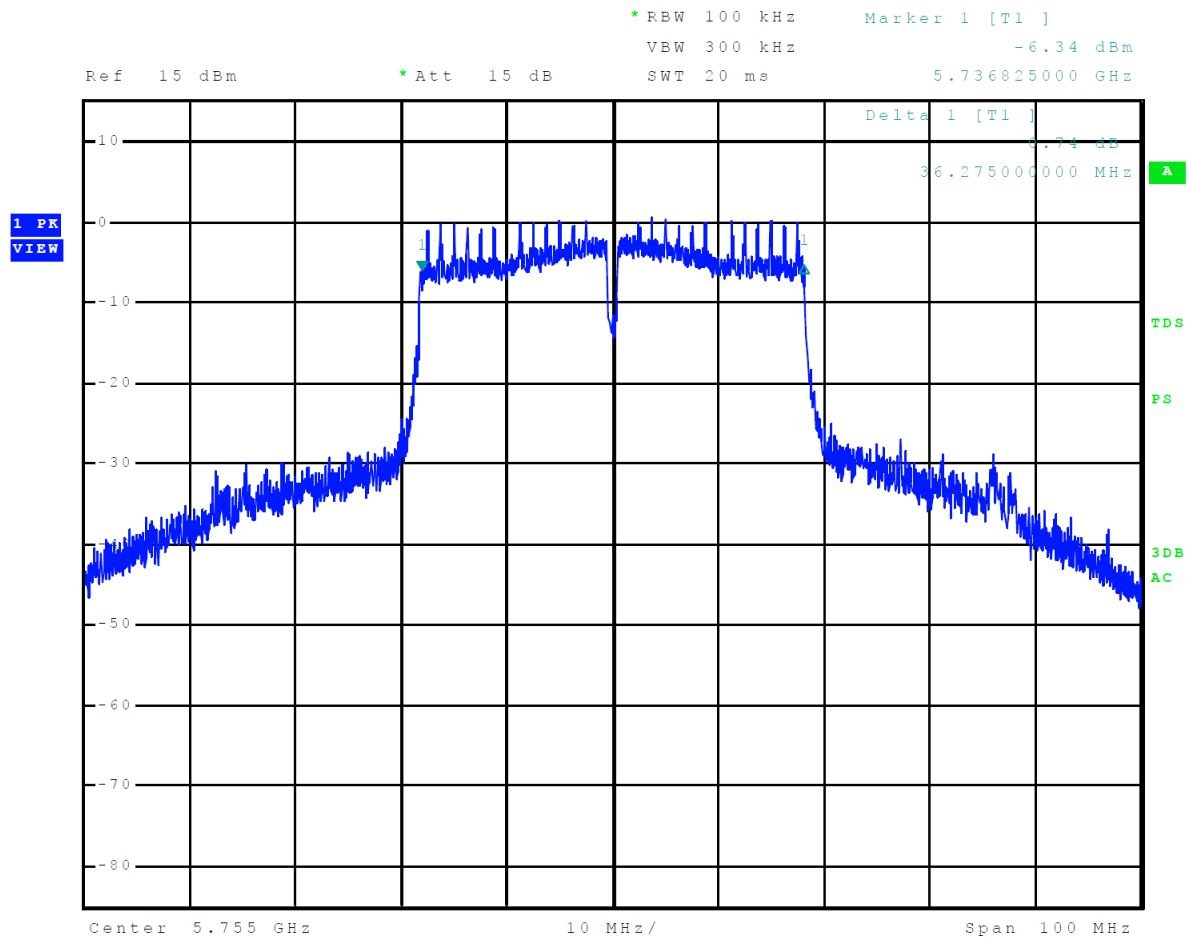
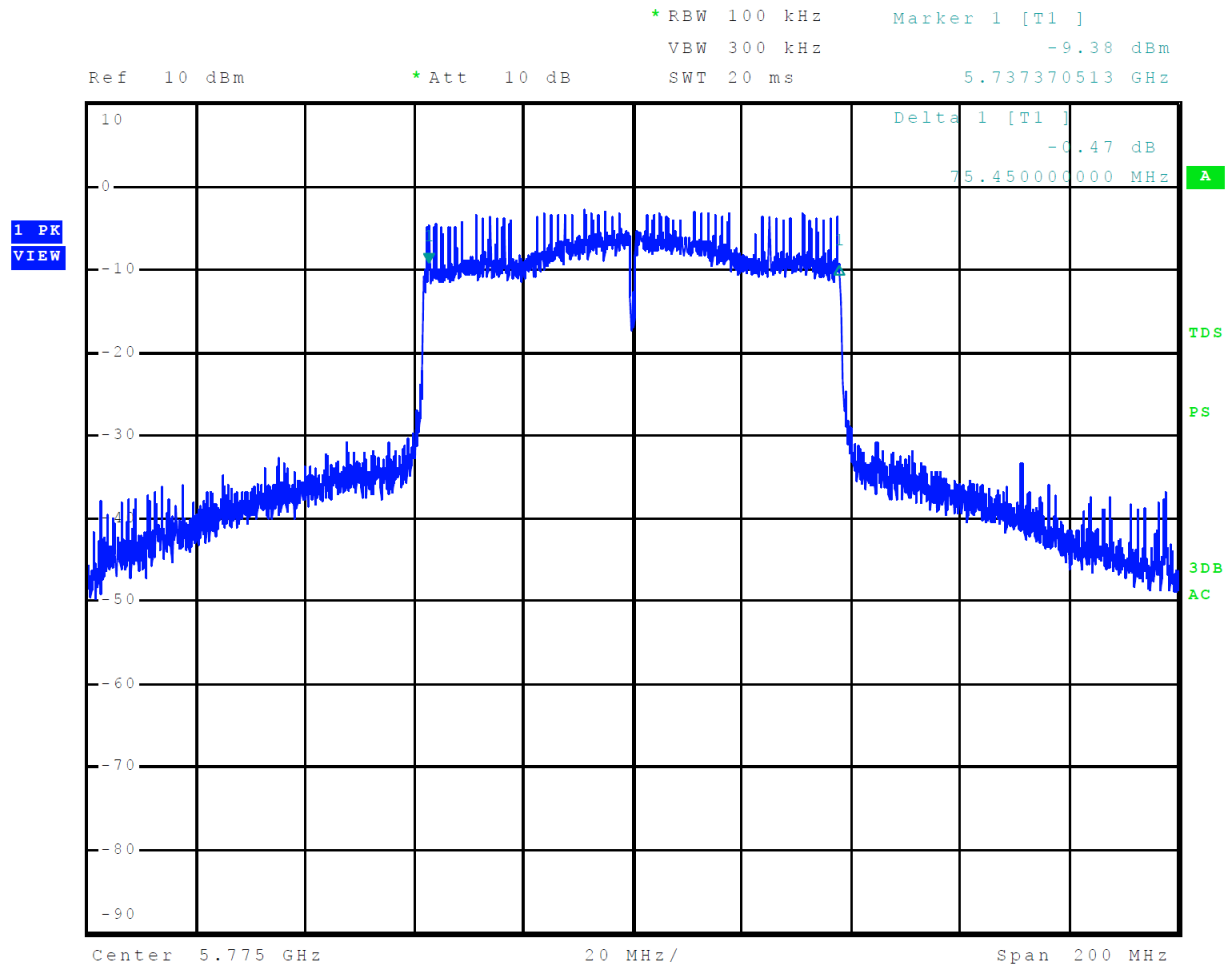




Figure 46 Plot of 6-dB Occupied Bandwidth 5725-5850 MHz Mode 15 U-NII-3 (802.11ac80)



**Transmitter Emissions Data**

**Table 12 Transmitter Radiated Emission 5150-5250 MHz Band, Mode 8 U-NII-1 (802.11a)**

Frequency in MHz	Horizontal Peak (dBµV/m)	Horizontal Average (dBµV/m)	Vertical Peak (dBµV/m)	Vertical Average (dBµV/m)	Limit @ 3m (dBµV/m)	Horizontal Margin (dB)	Vertical Margin (dB)
5180.0	--	--	--	--	--	--	--
10360.0	58.2	44.5	58.1	44.6	68.3	-23.8	-23.7
15540.0	63.9	49.8	63.6	49.7	68.3	-18.5	-18.6
20720.0	57.5	43.9	58.0	44.0	68.3	-24.4	-24.3
25900.0	61.3	48.2	61.5	48.1	68.3	-20.1	-20.2
5200.0	--	--	--	--	--	--	--
10400.0	59.8	45.2	58.8	45.3	68.3	-23.1	-23.0
15600.0	63.5	49.8	64.0	49.7	68.3	-18.5	-18.6
20800.0	57.6	44.1	57.8	44.0	68.3	-24.2	-24.3
26000.0	62.9	49.0	62.4	49.0	68.3	-19.3	-19.3
5240.0	--	--	--	--	--	--	--
10480.0	58.1	44.6	58.3	44.5	68.3	-23.7	-23.8
15720.0	64.1	49.1	62.8	48.9	68.3	-19.2	-19.4
20960.0	58.0	44.3	58.4	44.4	68.3	-24.0	-23.9
26200.0	62.9	49.1	62.5	49.2	68.3	-19.2	-19.1
<b>Band Edges</b>							
5150.0	60.9	43.9	59.3	43.5	54.0	-10.1	-10.5
5350.0	56.9	42.6	57.1	42.8	54.0	-11.4	-11.2

Other emissions present had amplitudes at least 20 dB below the limit. Peak and Quasi-Peak amplitude emissions are recorded for frequency below 1000 MHz. Peak and Average amplitude emissions are recorded for frequency range above 1000 MHz.

**Table 13 Transmitter Radiated Emission 5150-5250 MHz Band, Mode 9 U-NII-1 (802.11n)**

Frequency in MHz	Horizontal Peak (dBμV/m)	Horizontal Average (dBμV/m)	Vertical Peak (dBμV/m)	Vertical Average (dBμV/m)	Limit @ 3m (dBμV/m)	Horizontal Margin (dB)	Vertical Margin (dB)
5180.0	--	--	--	--	--	--	--
10360.0	57.8	44.3	58.2	44.5	68.3	-24.0	-23.8
15540.0	63.9	49.9	63.3	49.8	68.3	-18.4	-18.5
20720.0	57.1	44.0	57.7	44.0	68.3	-24.3	-24.3
25900.0	61.5	48.1	61.8	48.1	68.3	-20.2	-20.2
5200.0	--	--	--	--	--	--	--
10400.0	59.3	45.2	59.5	45.3	68.3	-23.1	-23.0
15600.0	63.4	49.8	63.3	49.9	68.3	-18.5	-18.4
20800.0	57.4	44.0	58.1	44.1	68.3	-24.3	-24.2
26000.0	62.8	49.1	62.4	49.1	68.3	-19.2	-19.2
5240.0	--	--	--	--	--	--	--
10480.0	58.2	44.4	58.3	44.7	68.3	-23.9	-23.6
15720.0	63.0	49.1	62.4	49.0	68.3	-19.2	-19.3
20960.0	58.5	44.4	58.5	44.3	68.3	-23.9	-24.0
26200.0	62.8	49.2	62.6	49.1	68.3	-19.1	-19.2
Band Edges							
5150.0	64.4	43.8	62.6	43.0	54.0	-10.2	-11.0
5350.0	56.1	42.4	56.1	42.3	54.0	-11.6	-11.7

Other emissions present had amplitudes at least 20 dB below the limit. Peak and Quasi-Peak amplitude emissions are recorded for frequency below 1000 MHz. Peak and Average amplitude emissions are recorded for frequency range above 1000 MHz.

**Table 14 Transmitter Radiated Emission 5150-5250 MHz Band, Mode 10 U-NII-1 (802.11n40)**

Frequency in MHz	Horizontal Peak (dBµV/m)	Horizontal Average (dBµV/m)	Vertical Peak (dBµV/m)	Vertical Average (dBµV/m)	Limit @ 3m (dBµV/m)	Horizontal Margin (dB)	Vertical Margin (dB)
5190.0	--	--	--	--	--	--	--
10380.0	58.6	45.0	58.7	44.9	68.3	-23.3	-23.4
15570.0	63.7	49.3	62.9	49.3	68.3	-19.0	-19.0
20760.0	57.6	43.9	58.1	44.1	68.3	-24.4	-24.2
25950.0	62.3	48.0	61.8	48.1	68.3	-20.3	-20.2
5230.0	--	--	--	--	--	--	--
10460.0	57.8	44.3	58.0	44.3	68.3	-24.0	-24.0
15690.0	62.3	48.6	62.4	48.7	68.3	-19.7	-19.6
20920.0	58.1	44.3	57.6	44.2	68.3	-24.0	-24.1
26150.0	62.5	49.1	62.4	49.1	68.3	-19.2	-19.2
Band Edges							
5150.0	63.1	45.9	63.0	45.2	54.0	-8.1	-8.8
5350.0	56.9	42.8	57.7	42.7	54.0	-11.2	-11.3

Other emissions present had amplitudes at least 20 dB below the limit. Peak and Quasi-Peak amplitude emissions are recorded for frequency below 1000 MHz. Peak and Average amplitude emissions are recorded for frequency range above 1000 MHz.

**Table 15 Transmitter Radiated Emission 5150-5250 MHz Band, Mode 11 U-NII-1 (802.11ac80)**

Frequency in MHz	Horizontal Peak (dBµV/m)	Horizontal Average (dBµV/m)	Vertical Peak (dBµV/m)	Vertical Average (dBµV/m)	Limit @ 3m (dBµV/m)	Horizontal Margin (dB)	Vertical Margin (dB)
5210.0	--	--	--	--	--	--	--
10420.0	58.5	44.8	58.1	44.6	68.3	-23.5	-23.7
15630.0	63.1	49.6	63.8	49.5	68.3	-18.7	-18.8
20840.0	58.1	44.3	59.0	44.3	68.3	-24.0	-24.0
26050.0	62.8	49.5	62.9	49.4	68.3	-18.8	-18.9
Band Edges							
5150.0	63.0	48.7	61.8	47.4	54.0	-5.3	-6.6
5350.0	57.4	43.6	57.5	43.8	54.0	-10.4	-10.2

Other emissions present had amplitudes at least 20 dB below the limit. Peak and Quasi-Peak amplitude emissions are recorded for frequency below 1000 MHz. Peak and Average amplitude emissions are recorded for frequency range above 1000 MHz.

**Table 16 Transmitter Radiated Emission 5725-5850 MHz Band, Mode 12 U-NII-3 (802.11a)**

Frequency in MHz	Horizontal Peak (dBµV/m)	Horizontal Average (dBµV/m)	Vertical Peak (dBµV/m)	Vertical Average (dBµV/m)	Limit @ 3m (dBµV/m)	Horizontal Margin (dB)	Vertical Margin (dB)
5745.0	--	--	--	--	--	--	--
11490.0	60.8	47.3	60.6	47.1	68.3	-21.0	-21.2
17235.0	67.1	53.7	67.0	53.6	68.3	-14.6	-14.7
22980.0	58.7	45.4	58.8	45.4	68.3	-22.9	-22.9
28725.0	68.2	54.7	68.4	54.7	68.3	-13.6	-13.6
5785.0	--	--	--	--	--	--	--
11570.0	61.2	48.0	61.8	47.9	68.3	-20.3	-20.4
17355.0	68.0	54.3	66.7	53.4	68.3	-14.0	-14.9
23140.0	59.6	45.6	59.3	45.5	68.3	-22.7	-22.8
28925.0	68.7	55.2	68.8	55.2	68.3	-13.1	-13.1
5825.0	--	--	--	--	--	--	--
11650.0	61.2	47.6	61.7	47.7	68.3	-20.7	-20.6
17475.0	67.8	54.3	67.2	53.7	68.3	-14.0	-14.6
23300.0	58.6	45.3	59.5	45.3	68.3	-23.0	-23.0
29125.0	69.3	55.6	70.3	55.7	68.3	-12.7	-12.6
Band Edges							
5725.0	78.3	59.6	78.7	59.9	78.2	-18.6	-18.3
5850.0	71.9	55.6	67.6	52.2	78.2	-22.6	-26.0

Other emissions present had amplitudes at least 20 dB below the limit. Peak and Quasi-Peak amplitude emissions are recorded for frequency below 1000 MHz. Peak and Average amplitude emissions are recorded for frequency range above 1000 MHz.

**Table 17 Transmitter Radiated Emission 5725-5850 MHz Band, Mode 13 U-NII-3 (802.11n)**

Frequency in MHz	Horizontal Peak (dB $\mu$ V/m)	Horizontal Average (dB $\mu$ V/m)	Vertical Peak (dB $\mu$ V/m)	Vertical Average (dB $\mu$ V/m)	Limit @ 3m (dB $\mu$ V/m)	Horizontal Margin (dB)	Vertical Margin (dB)
5745.0	--	--	--	--	--	--	--
11490.0	60.7	47.0	60.5	47.0	68.3	-21.3	-21.3
17235.0	66.9	53.5	67.2	53.4	68.3	-14.8	-14.9
22980.0	59.5	45.3	59.2	45.2	68.3	-23.0	-23.1
28725.0	68.5	54.8	68.5	54.8	68.3	-13.5	-13.5
5785.0	--	--	--	--	--	--	--
11570.0	61.6	47.8	61.9	48.0	68.3	-20.5	-20.3
17355.0	67.4	53.6	67.8	53.4	68.3	-14.7	-14.9
23140.0	59.0	45.4	59.3	45.5	68.3	-22.9	-22.8
28925.0	68.9	55.0	69.3	55.1	68.3	-13.3	-13.2
5825.0	--	--	--	--	--	--	--
11650.0	60.9	47.1	61.6	47.8	68.3	-21.2	-20.5
17475.0	67.9	54.2	67.5	53.6	68.3	-14.1	-14.7
23300.0	59.1	45.2	58.9	45.1	68.3	-23.1	-23.2
29125.0	69.7	55.7	69.0	55.7	68.3	-12.6	-12.6
Band Edges							
5725.0	80.2	61.5	79.6	60.8	78.2	-16.7	-17.4
5850.0	74.8	55.7	70.8	52.2	78.2	-22.5	-26.0

Other emissions present had amplitudes at least 20 dB below the limit. Peak and Quasi-Peak amplitude emissions are recorded for frequency below 1000 MHz. Peak and Average amplitude emissions are recorded for frequency range above 1000 MHz.

**Table 18 Transmitter Radiated Emission 5725-5850 MHz Band, Mode 14 U-NII-3 (802.11n40)**

Frequency in MHz	Horizontal Peak (dBµV/m)	Horizontal Average (dBµV/m)	Vertical Peak (dBµV/m)	Vertical Average (dBµV/m)	Limit @ 3m (dBµV/m)	Horizontal Margin (dB)	Vertical Margin (dB)
5755.0	--	--	--	--	--	--	--
11510.0	60.0	46.3	59.7	46.4	68.3	-22.0	-21.9
17265.0	66.0	52.5	65.8	52.4	68.3	-15.8	-15.9
23020.0	59.1	45.3	58.6	45.3	68.3	-23.0	-23.0
28775.0	68.7	54.8	68.8	54.9	68.3	-13.5	-13.4
5795.0	--	--	--	--	--	--	--
11590.0	61.2	47.8	61.4	47.6	68.3	-20.5	-20.7
17385.0	67.5	53.4	66.6	53.2	68.3	-14.9	-15.1
23180.0	59.0	45.4	59.3	45.4	68.3	-22.9	-22.9
28975.0	69.0	55.4	69.2	55.3	68.3	-12.9	-13.0
Band Edges							
5725.0	78.0	62.1	77.7	61.8	78.2	-16.1	-16.4
5850.0	62.7	46.5	60.9	45.3	78.2	-31.7	-32.9

Other emissions present had amplitudes at least 20 dB below the limit. Peak and Quasi-Peak amplitude emissions are recorded for frequency below 1000 MHz. Peak and Average amplitude emissions are recorded for frequency range above 1000 MHz.



**Table 20 Transmitter Radiated Emission 5725-5850 MHz Band, Mode 15 U-NII-3 (802.11ac80)**

Frequency in MHz	Horizontal Peak (dB $\mu$ V/m)	Horizontal Average (dB $\mu$ V/m)	Vertical Peak (dB $\mu$ V/m)	Vertical Average (dB $\mu$ V/m)	Limit @ 3m (dB $\mu$ V/m)	Horizontal Margin (dB)	Vertical Margin (dB)
5775.0	--	--	--	--	--	--	--
11550.0	60.7	46.8	60.7	46.4	68.3	-21.5	-21.9
17325.0	65.4	52.0	65.9	51.9	68.3	-16.3	-16.4
23100.0	59.0	45.3	59.4	45.3	68.3	-23.0	-23.0
28875.0	692.0	55.2	68.7	55.1	68.3	-13.1	-13.2
Band Edges							
5725.0	78.2	62.6	77.4	61.8	78.2	-15.6	-16.4
5850.0	70.3	52.2	64.7	48.9	78.2	-26.0	-29.3

Other emissions present had amplitudes at least 20 dB below the limit. Peak and Quasi-Peak amplitude emissions are recorded for frequency below 1000 MHz. Peak and Average amplitude emissions are recorded for frequency range above 1000 MHz.

**Table 21 Transmitter Antenna Port Data Modes 8-11 (U-NII-1)**

Frequency MHz	Antenna Port Conducted Output Power (Watts)	99% Occupied Bandwidth (kHz)	Peak Power Spectral Density (dBm/MHz)
20 MHz Mode 8 U-NII-1 (802.11a)			
5180	0.011	17,150.0	9.8
5200	0.010	17,150.0	9.5
5240	0.009	17,190.0	8.9
20 MHz Mode 9 U-NII-1 (802.11n)			
5180	0.009	18,275.0	11.2
5200	0.009	18,250.0	9.5
5240	0.008	18,237.5	10.1
40 MHz Mode 10 U-NII-1 (802.11n40)			
5190	0.008	36,800.0	6.1
5230	0.007	36,850.0	5.6
80 MHz Mode 11 U-NII-1 (802.11ac80)			
5210	0.007	76,050.0	3.4

**Table 22 Transmitter Antenna Port Data Modes 9-12 (U-NII-3)**

Frequency MHz	Antenna Port Conducted Average Output Power (Watts)	99% Occupied Bandwidth (kHz)	6-dB Occupied Bandwidth (kHz)	26-dB Occupied Bandwidth (kHz)	Peak Power Spectral Density (dBm/500kHz)
20 MHz Mode 12 U-NII-3 (802.11a)					
5745	0.036	17,560.0	16,260.0	22,325.0	10.1
5785	0.036	17,650.0	16,282.1	22,137.5	10.4
5825	0.035	17,630.0	16,282.1	22,175.0	10.1
20 MHz Mode 13 U-NII-3 (802.11n)					
5745	0.035	18,562.5	17,487.5	21,870.0	10.5
5785	0.034	18,537.5	17,512.5	21,480.0	11.6
5825	0.033	18,550.0	17,512.5	21,825.0	10.6
40 MHz Mode 14 (802.11n40) U-NII-3					
5755	0.027	37,400.0	36,275.0	40,400.0	6.7
5795	0.033	37,225.0	36,250.0	40,400.0	6.6
80 MHz Mode 15 U-NII-3 (802.11ac80)					
5775	0.024	76,400.0	75,450.0	81,700.0	3.7

**Summary of Results for Transmitter Radiated Emissions of Intentional Radiator**

The EUT demonstrated compliance with the radiated emissions requirements of 47 CFR Part 15.407 and Industry Canada RSS-247 Issue 3. The maximum average conducted power delivered to antenna was 0.011-Watts in the U-NII-1 Band and 0.036-Watts in the U-NII-3 Band. The radiated harmonic emissions provided a minimum margin of -5.3 dB below requirements. There were no other significantly measurable emissions in the restricted bands other than those presented in this report. Other emissions were present with amplitudes at least 20 dB below the requirements. There were no other deviations or exceptions to the requirements.



## Annex

- Annex A Measurement Uncertainty Calculations
- Annex B Additional Test Equipment
- Annex C Rogers Labs Certificate of Accreditation

## Annex A Measurement Uncertainty Calculations

The measurement uncertainty was calculated for all measurements listed in this test report according To CISPR 16–4. Result of measurement uncertainty calculations are recorded below. Component and process variability of production devices similar to those tested may result in additional deviations. The manufacturer has the sole responsibility of continued compliance.

Measurement	Expanded Measurement Uncertainty $U_{(lab)}$
3 Meter Horizontal 0.009-1000 MHz Measurements	4.16
3 Meter Vertical 0.009-1000 MHz Measurements	4.33
3 Meter Measurements 1-18 GHz	5.46
3 Meter Measurements 18-40 GHz	5.16
10 Meter Horizontal Measurements 0.009-1000 MHz	4.15
10 Meter Vertical Measurements 0.009-1000 MHz	4.32
AC Line Conducted	1.75
Antenna Port Conducted power	1.17
Frequency Stability	1.00E-11
Temperature	1.6°C
Humidity	3%

## Annex B Test Equipment

Equipment	Manufacturer	Model (SN)	Band	Last Cal Date	Next Cal Due
<input type="checkbox"/> AC Power Source	Ametech / California Instruments	??	N/A	2/18/2023	2/18/2024
<input type="checkbox"/> Amplifier	Com-Power	PA-010 (171003)	100Hz-30MHz	9/26/2023	9/26/2024
<input type="checkbox"/> Amplifier	Com-Power	CPPA-102 (01254)	1-1000 MHz	9/26/2023	9/26/2024
<input checked="" type="checkbox"/> Amplifier	Com-Power	PAM-118A (551014)	0.5-18 GHz	9/26/2023	9/26/2024
<input checked="" type="checkbox"/> Amplifier	Com-Power	PAM-840A (461328)	18-40 GHz	9/26/2023	9/26/2024
<input checked="" type="checkbox"/> Analyzer	Rohde & Schwarz	ESU40 (100108)	20Hz-40GHz	6/26/2023	6/26/2024
<input checked="" type="checkbox"/> Analyzer	Rohde & Schwarz	ESW44 (101534)	20Hz-44GHz	1/26/2024	1/26/2025
<input type="checkbox"/> Analyzer	Rohde & Schwarz	FS-Z60, 90, 140, and 220	40GHz-220GHz	12/22/2017	12/22/2027
<input checked="" type="checkbox"/> Analyzer	HP	8562A (3051A05950)	9kHz-125GHz	3/25/2024	3/25/2025
<input checked="" type="checkbox"/> Antenna	Com Power	AL-130 (121055)	.001-30 MHz	9/26/2023	9/26/2024
<input type="checkbox"/> Antenna	ARA	BCD-235-B (169)	20-350MHz	9/26/2023	9/26/2024
<input checked="" type="checkbox"/> Antenna	Sunol	JB-6 (A100709)	30-1000 MHz	11/8/2023	11/8/2024
<input type="checkbox"/> Antenna	ETS-Lindgren	3147 (40582)	200-1000MHz	9/26/2023	10/11/2024
<input checked="" type="checkbox"/> Antenna	ETS-Lindgren	3117 (200389)	1-18 GHz	3/25/2024	3/25/2026
<input checked="" type="checkbox"/> Antenna	Com Power	AH-118 (10110)	1-18 GHz	10/11/2022	10/11/2024
<input checked="" type="checkbox"/> Antenna	Com Power	AH-1840 (101046)	18-40 GHz	3/27/2023	3/27/2025
<input type="checkbox"/> Antenna	EMCO	6509	.001-30 MHz	10/11/2022	10/11/2024
<input type="checkbox"/> Antenna	Solar	9229-1 & 9230-1	??	2/18/2023	2/18/2024
<input type="checkbox"/> Attenuator	Fairview	SA6NFNF100W-40 (1625)	30-18000 MHz	3/25/2024	3/25/2025
<input checked="" type="checkbox"/> Attenuator	Mini-Circuits	VAT-3W2+ (1436)	30-6000 MHz	3/25/2024	3/25/2025
<input checked="" type="checkbox"/> Attenuator	Mini-Circuits	VAT-3W2+ (1445)	30-6000 MHz	3/25/2024	3/25/2025
<input checked="" type="checkbox"/> Attenuator	Mini-Circuits	VAT-3W2+ (1735)	30-6000 MHz	3/25/2024	3/25/2025
<input type="checkbox"/> Attenuator	Mini-Circuits	VAT-6W2+ (1438)	30-6000 MHz	3/25/2024	3/25/2025
<input type="checkbox"/> Attenuator	Mini-Circuits	VAT-6W2+ (1736)	30-6000 MHz	3/25/2024	3/25/2025
<input checked="" type="checkbox"/> Cable	Huber & Suhner Inc.	Sucoflex102ea(L10M)(303073)	9kHz-40Ghz	9/26/2023	9/26/2024
<input checked="" type="checkbox"/> Cable	Huber & Suhner Inc.	Sucoflex102ea(1.5M)(303069)	9kHz-40Ghz	9/26/2023	9/26/2024
<input type="checkbox"/> Cable	Huber & Suhner Inc.	Sucoflex102ea(1.5M)(303070)	9kHz-40Ghz	9/26/2023	9/26/2024
<input checked="" type="checkbox"/> Cable	Belden	RG-58 (L1-CAT3-11509)	9kHz-30 MHz	9/26/2023	9/26/2024
<input type="checkbox"/> Cable	Belden	RG-58 (L2-CAT3-11509)	9kHz-30 MHz	9/26/2023	9/26/2024
<input checked="" type="checkbox"/> Cable	Huber & Suhner Inc.	Sucoflex102ea(1.5M)(303072) 9kHz-40 GHz	9kHz-40Ghz	9/26/2023	9/26/2024
<input checked="" type="checkbox"/> Cable	Huber & Suhner Inc.	Sucoflex102ea(L1M)(281183) 9kHz-40 GHz	9kHz-40Ghz	9/26/2023	9/26/2024
<input checked="" type="checkbox"/> Cable	Huber & Suhner Inc.	Sucoflex102ea(L4M)(281184) 9kHz-40 GHz	9kHz-40Ghz	9/26/2023	9/26/2024
<input checked="" type="checkbox"/> Cable	Huber & Suhner Inc.	Sucoflex102ea(L10M)(317546)9kHz-40 GHz	9kHz-40Ghz	9/26/2023	9/26/2024
<input checked="" type="checkbox"/> Cable	Time Microwave	4M-750HF290-750 (S/N-L4M)	9kHz-24 GHz	9/26/2023	9/26/2024
<input type="checkbox"/> Cable	Mini-Circuits	KBL-2M-LOW+ (23090329)	9kHz-40Ghz	3/25/2024	3/25/2025

Equipment	Manufacturer	Model (SN)	Band	Last Cal Date	Next Cal Due
<input type="checkbox"/> CDN	Com-Power	CDN325E		10/11/2022	10/11/2024
<input type="checkbox"/> EMC Transient Generator HVT	EMC?	TR3000		2/18/2023	2/18/2024
<input type="checkbox"/> ESD Simulator	??	MZ-15	N/A	2/18/2023	2/18/2024
<input type="checkbox"/> Field Intensity Meter	??	EFM-018	??	2/18/2023	2/18/2024
<input type="checkbox"/> Frequency Counter	Leader	LDC-825	??	3/28/2023	3/28/2025
<input checked="" type="checkbox"/> Generator	Rohde & Schwarz	SMB100A6 (100150)	20Hz-6 GHz	3/25/2024	3/25/2025
<input checked="" type="checkbox"/> Generator	Rohde & Schwarz	SMBV100A6 (260771)	20Hz-6 GHz	3/25/2024	3/25/2025
<input type="checkbox"/> ISN	Com-Power	ISN T-8 (600111)	??	3/25/2024	3/25/2025
<input checked="" type="checkbox"/> LISN	Fischer Custom Communications	FCC-LISN-50-25-10(1PA) (160611)	.15-30MHz	3/25/2024	3/25/2025
<input type="checkbox"/> LISN	Fischer Custom Communications	FCC-LISN-50-16-2-08		3/25/2024	3/25/2025
<input type="checkbox"/> LISN	Compliance Design	FCC-LISN-2.Mod.cd,(126)	.15-30MHz	9/26/2023	10/11/2024
<input type="checkbox"/> LISN	Com-Power	LI-220A	??	3/29/2023	3/29/2025
<input checked="" type="checkbox"/> LISN	Com-Power	LI-550C	??	9/26/2023	10/11/2024
<input type="checkbox"/> Oscilloscope Scope	Tektronix	MDO 4104	??	2/18/2023	2/18/2024
<input checked="" type="checkbox"/> Power meter	Agilent	N1911A with N1921A	0.05-40 GHz	3/28/2023	3/28/2025
<input checked="" type="checkbox"/> Pwr Sensor	Rohde & Schwarz	NRP33T	0.05-33 GHz	9/26/2023	9/26/2025
<input checked="" type="checkbox"/> RF Filter	Micro-Tronics	BRC50722 (009).9G notch	30-18000 MHz	3/25/2024	3/25/2025
<input type="checkbox"/> RF Filter	Micro-Tronics	HPM50114 (017)1.5G HPF	30-18000 MHz	3/25/2024	3/25/2025
<input type="checkbox"/> RF Filter	Micro-Tronics	HPM50117 (063) 3G HPF	30-18000 MHz	3/25/2024	3/25/2025
<input type="checkbox"/> RF Filter	Micro-Tronics	HPM50105 (059) 6G HPF	30-18000 MHz	3/25/2024	3/25/2025
<input checked="" type="checkbox"/> RF Filter	Micro-Tronics	BRM50702 (172) 2G notch	30-18000 MHz	3/25/2024	3/25/2025
<input checked="" type="checkbox"/> RF Filter	Micro-Tronics	BRC50703 (G102) 5G notch	30-18000 MHz	3/25/2024	3/25/2025
<input checked="" type="checkbox"/> RF Filter	Micro-Tronics	BRC50705 (024) 5G notch	30-18000 MHz	3/25/2024	3/25/2025
<input type="checkbox"/> RF Filter	Micro-Tronics	BRC17663 (001)	9.3-9.5 notch 30-1800 MHz	3/28/2023	3/28/2025
<input type="checkbox"/> RF Filter	Micro-Tronics	BRC19565 (001)	9.2-9.6 notch 30-1800 MHz	3/28/2023	3/28/2025
<input type="checkbox"/> Wave Form Generator	Keysight	33512B (MY57400128)	??	3/29/2022	3/25/2026
<input type="checkbox"/> Weather station	Davis	6152 (A70927D44N)	N/A	7/13/2022	7/14/2024
<input checked="" type="checkbox"/> Generator	Rohde & Schwarz	SMBV100A6 (101844)	20Hz-6 GHz	3/07/2024	9/17/2025

**Annex C Laboratory Certificate of Accreditation**

3/18/24 through 3/31/25:

United States Department of Commerce  
 National Institute of Standards and Technology




---

**Certificate of Accreditation to ISO/IEC 17025:2017**

---

NVLAP LAB CODE: 200087-0

**Rogers Labs, a division of The Compatibility Center LLC**  
 Lenexa, KS

*is accredited by the National Voluntary Laboratory Accreditation Program for specific services,  
 listed on the Scope of Accreditation, for:*

**Electromagnetic Compatibility & Telecommunications**


*This laboratory is accredited in accordance with the recognized International Standard ISO/IEC 17025:2017.  
 This accreditation demonstrates technical competence for a defined scope and the operation of a laboratory quality  
 management system (refer to joint ISO-ILAC-IAF Communique dated January 2009).*

2024-03-18 through 2025-03-31  
 Effective Dates


  
 For the National Voluntary Laboratory Accreditation Program

3/16/23 through 3/31/24:

United States Department of Commerce  
 National Institute of Standards and Technology

---

**Certificate of Accreditation to ISO/IEC 17025:2017**

---

NVLAP LAB CODE: 200087-0

**Rogers Labs, a division of The Compatibility Center LLC**  
 Lenexa, KS

*is accredited by the National Voluntary Laboratory Accreditation Program for specific services,  
 listed on the Scope of Accreditation, for:*

**Electromagnetic Compatibility & Telecommunications**

*This laboratory is accredited in accordance with the recognized International Standard ISO/IEC 17025:2017.  
 This accreditation demonstrates technical competence for a defined scope and the operation of a laboratory quality  
 management system (refer to joint ISO-ILAC-IAF Communique dated January 2009).*

2023-03-16 through 2024-03-31  
 Effective Dates


  
 For the National Voluntary Laboratory Accreditation Program

Rogers Labs, a division of The Compatibility Center LLC  
 7915 Nieman Road FCC ID: IPH-B4450 IC: 1792A-B4450  
 Lenexa, KS 66214 Test: 240102  
 Phone/Fax: (913) 660-0666 Test to: 47CFR 15E, RSS-Gen RSS-247  
 Revision 1 File: B04450 NII TstRpt 240102 r1

Garmin International, Inc.  
 PMN: B04450  
 SN's: 8BR000021, 8BS000009  
 Date: May 28, 2024  
 Page 96 of 96