



## ROGERS LABS, INC.

4405 West 259<sup>th</sup> Terrace  
Louisburg, KS 66053  
Phone / Fax (913) 837-3214

# Application For Grant of Certification

47 CFR, PART 15C - Intentional Radiators  
47 CFR Paragraph 15.247 and  
Industry Canada RSS-GEN and RSS-247

Model: AA03474  
2402-2480 MHz (DTS)  
Broadband Digital Transmission System

FCC ID: IPH-A03474

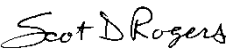
IC: 1792A-A03474

## Garmin International, Inc.

1200 East 151st Street  
Olathe, KS 66062

FCC Designation: US5305  
ISED Registration: 3041A-1  
Test Report Number: 190925

Test Date: September 25, 2019

Authorized Signatory:   
Scot D. Rogers

This report shall not be reproduced except in full, without the written approval of the laboratory.  
This report must not be used by the client to claim product certification, approval, or  
endorsement by NVLAP, NIST, or any agency of the U.S. Government.

## Table of Contents

|  |           |
|--|-----------|
| <b>TABLE OF CONTENTS</b> .....   | <b>2</b>  |
| <b>REVISIONS</b> .....   | <b>3</b>  |
| <b>FOREWORD</b> .....  | <b>4</b>  |
| <b>OPINION / INTERPRETATION OF RESULTS</b> .....   | <b>5</b>  |
| <b>EQUIPMENT TESTED</b> .....  | <b>7</b>  |
| <b>Equipment Function</b> .....  | <b>8</b>  |
| <b>Equipment Configuration</b> .....   | <b>9</b>  |
| <b>APPLICATION FOR CERTIFICATION</b> .....   | <b>10</b> |
| <b>APPLICABLE STANDARDS &amp; TEST PROCEDURES</b> .....                                      | <b>11</b> |
| <b>TESTING PROCEDURES</b> .....  | <b>11</b> |
| <b>AC Line Conducted Emission Test Procedure</b> .....                                       | <b>11</b> |
| <b>Radiated Emission Test Procedure</b> .....  | <b>11</b> |
| <b>Antenna Port Conducted Emission Test Procedure</b> .....                                  | <b>12</b> |
| Diagram 1 Test arrangement for radiated emissions of tabletop equipment.....                 | 13        |
| Diagram 2 Test arrangement for radiated emissions tested on Open Area Test Site (OATS) ..... | 14        |
| Diagram 3 Test arrangement for Antenna Port Conducted emissions .....                        | 15        |
| <b>TEST SITE LOCATIONS</b> .....   | <b>15</b> |
| <b>LIST OF TEST EQUIPMENT</b> .....  | <b>16</b> |
| <b>UNITS OF MEASUREMENTS</b> .....   | <b>17</b> |
| <b>ENVIRONMENTAL CONDITIONS</b> .....  | <b>17</b> |
| <b>STATEMENT OF MODIFICATIONS AND DEVIATIONS</b> .....                                       | <b>17</b> |
| <b>INTENTIONAL RADIATORS</b> .....   | <b>18</b> |
| <b>Antenna Requirements</b> .....  | <b>18</b> |

**Restricted Bands of Operation.....18**

Table 1 Harmonic Radiated Emissions in Restricted Bands Data (GMSK) ..... 19

**Summary of Results for Radiated Emissions in Restricted Bands .....19**

**General Radiated Emissions Procedure.....20**

Table 2 General Radiated Emissions Data ..... 21

**Summary of Results for General Radiated Emissions .....21**

**Operation in the Band 2400 – 2483.5 MHz .....22**

Figure 1 Plot of Transmitter Operation in 2402-2480 MHz (GMSK) ..... 23

Figure 2 Plot of Transmitter Emissions Low Band Edge (GMSK) ..... 24

Figure 3 Plot of Transmitter Emissions High Band Edge (GMSK)..... 25

Figure 4 Plot of 99% Occupied Bandwidth (GMSK) ..... 26

Figure 5 Plot of 6-dB Occupied Bandwidth (GMSK) ..... 27

Figure 6 Plot of Transmitter Power Spectral Density (GMSK) ..... 28

**Transmitter Emissions Data.....29**

Table 3 Transmitter Radiated Emissions (GMSK) ..... 29

Table 4 Transmitter Antenna Port Conducted Data (GMSK)..... 30

**Summary of Results for Transmitter Radiated Emissions of Intentional Radiator .....30**

**ANNEX..... 31**

**Annex A Measurement Uncertainty Calculations.....32**

**Annex B Additional Test Equipment.....33**

**Annex C Rogers Qualifications .....34**

**Annex D Rogers Labs Certificate of Accreditation .....35**

**Revisions**

Revision 2 Issued December 17, 2019 – Updated report to reflect operational duty cycle and power (page 7 of 35)

Revision 1 Issued November 26, 2019

## Foreword

The following information is submitted for consideration in obtaining Grant of Certification for License Exempt Digital Transmission System Intentional Radiator operating under Title 47 Code of Federal Regulations (47 CFR) Paragraph 15.247 and Industry Canada RSS-GEN, Issue 5 and RSS-247 Issue 2, operation in the 2400 – 2483.5 MHz band.

Name of Applicant: Garmin International, Inc.  
 1200 East 151st Street  
 Olathe, KS 66062

M/N: AA03474

FCC ID: IPH-A03474

IC: 1792A-A03474

Frequency Range: operation across the 2402-2480 MHz band

Operational communication modes include

| Mode   | Power (Watts)<br>operating at<br>100% duty<br>cycle | 99% OBW (kHz) | 6-dB OBW (kHz) |
|--------|---|---------------|----------------|
| (GMSK) | 0.006   | 1048.1        | 695.5          |

This report addresses EUT Operations as Digital Transmission System using (GMSK) modulation

## Opinion / Interpretation of Results

| Tests Performed                                 | Margin (dB) | Results  |
|---|-------------|----------|
| Emissions 15.205, RSS-GEN                       | -5.3        | Complies |
| Emissions as per 47 CFR paragraphs 2 and 15.207 | N/A         | Complies |
| Emissions as per 47 CFR paragraphs 2 and 15.209 | -5.9        | Complies |
| Harmonic Emissions per 47 CFR 15.247            | -4.6        | Complies |
| Power Spectral Density per 47 CFR 15.247        | -16.7       | Complies |

Tests performed include

47CFR

15.247 (a) (2) Systems using digital modulation techniques may operate in the 902-928 MHz, 2400-2483.5 MHz, and 5725-5850 MHz bands. The minimum 6 dB bandwidth shall be at least 500 kHz.

(b) The maximum peak conducted output power of the intentional radiator shall not exceed the following:

(3) For systems using digital modulation in the 902-928 MHz, 2400-2483.5 MHz, and 5725-5850 MHz bands: 1 Watt. As an alternative to a peak power measurement, compliance with the one-Watt limit can be based on a measurement of the maximum conducted output power.

Maximum Conducted Output Power is defined as the total transmit power delivered to all antennas and antenna elements averaged across all symbols in the signaling alphabet when the transmitter is operating at its maximum power control level. Power must be summed across all antennas and antenna elements. The average must not include any time intervals during which the transmitter is off or is transmitting at a reduced power level. If multiple modes of operation are possible (e.g., alternative modulation methods), the *maximum conducted output power* is the highest total transmit power occurring in any mode.

(d) In any 100 kHz bandwidth outside the frequency band in which the spread spectrum or digitally modulated intentional radiator is operating, the radio frequency power that is produced by the intentional radiator shall be at least 20 dB below that in the 100 kHz bandwidth within the band that contains the highest level of the desired power, based on either an RF conducted or a radiated measurement, provided the transmitter demonstrates compliance with the peak conducted power limits. If the transmitter complies with the conducted power limits based on the use of RMS averaging over a time interval, as permitted under paragraph (b)(3) of this section, the attenuation required under this paragraph shall be 30 dB instead of 20 dB. Attenuation below the general limits specified in §15.209(a) is not required. In addition, radiated emissions which fall in the restricted bands, as defined in §15.205(a), must also comply with the radiated emission limits specified in §15.209(a) (see §15.205(c)).

(e) For digitally modulated systems, the power spectral density conducted from the intentional radiator to the antenna shall not be greater than 8 dBm in any 3 kHz band during any time interval of continuous transmission. This power spectral density shall be determined in accordance with the provisions of paragraph (b) of this section. The same method of determining the conducted output power shall be used to determine the power spectral density.

## RSS-247 Issue 2

### 5.2 Digital transmission systems

DTSs include systems that employ digital modulation techniques resulting in spectral characteristics similar to direct sequence systems. The following applies to the bands 902-928 MHz and 2400-2483.5 MHz

a) The minimum 6 dB bandwidth shall be 500 kHz.

b) The transmitter power spectral density conducted from the transmitter to the antenna shall not be greater than 8 dBm in any 3 kHz band during any time interval of continuous transmission.

This power spectral density shall be determined in accordance with the provisions of section 5.4(d), (i.e. the power spectral density shall be determined using the same method as is used to determine the conducted output power).

### 5.4 Transmitter output power and equivalent isotropically radiated power (e.i.r.p.) requirements

d) For DTSs employing digital modulation techniques operating in the bands 902-928 MHz and 2400-2483.5 MHz, the maximum peak conducted output power shall not exceed 1 W. The e.i.r.p. shall not exceed 4 W, except as provided in section 5.4(e).

### 5.5 Unwanted emissions

In any 100 kHz bandwidth outside the frequency band in which the spread spectrum or digitally modulated device is operating, the RF power that is produced shall be at least 20 dB below that in the 100 kHz bandwidth within the band that contains the highest level of the desired power, based on either an RF conducted or a radiated measurement, provided that the transmitter demonstrates compliance with the peak conducted power limits. If the transmitter complies with the conducted power limits based on the use of root-mean-square averaging over a time interval, as permitted under section 5.4(d), the attenuation required shall be 30 dB instead of 20 dB.

Attenuation below the general field strength limits specified in RSS-Gen is not required.

## Equipment Tested

| <u>Equipment</u> | <u>Model / PN</u> | <u>Serial Number</u> |
|------------------|-------------------|----------------------|
| EUT #1           | AA03474           | 3307548259           |
| EUT #2           | AA03474           | 3307548244           |
| DC Power Supply  | BK1745            | 209C13               |

Test results in this report relate only to the items tested

Operational communication modes of the equipment include

| Mode | Transmitter Operation |
|------|-----------------------|
| 1    | (GMSK)                |

Software Version 2.12

Power setting of 8 dBm

This device may operate at a maximum duty cycle of 36% which provides an operational output power below 10mW e.i.r.p. this level of power complies with SAR Exemption requires.

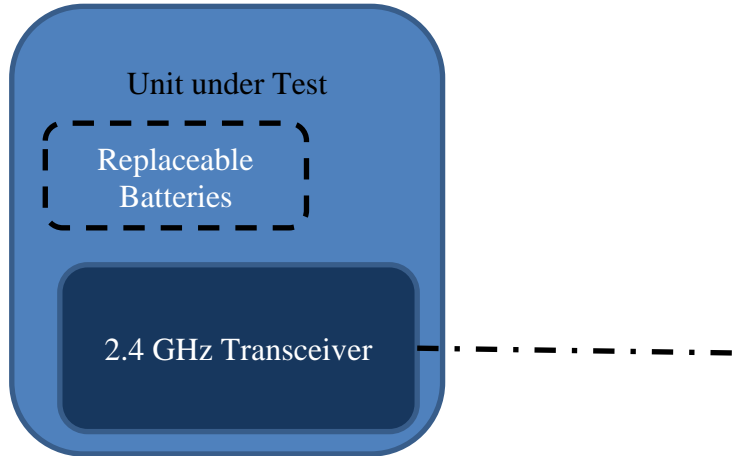
Test results in this report relate only to the items tested.

## ***Equipment Function***

The EUT is a Wireless remote control for use in a Marine installation. The design offers the end user the ability to wirelessly send command messages to compatible receiver and the associated connected equipment. The product operates from internal direct current power supplied from 2 AA batteries. The unit requires 3 volts direct current power for operation. The design provides no connection port for interfacing with other equipment. The EUT offers no other interface connection ports than those in the configuration shown below as described by the manufacturer. The unit incorporates transmitter circuitry providing wireless communications with compatible equipment and systems. The transmitter provides wireless operation capability across the 2402-2480 MHz frequency band. The design utilizes internal fixed antenna system and offers no provision for antenna replacement or modification. Two samples were provided for testing, one representative of production design, and the other modified for testing purposes replacing the integral 2.4 GHz antenna with 50-ohm RF connection port. The test samples were provided with test software Version 2.12 enabling testing personnel the ability to enable transmitter functions on defined modulation and channels. The test software enabled near 100% transmit duty cycle for testing purposes. The antenna modification offered testing facility the ability to connect test equipment to the temporary 2.4 GHz antenna port. The EUT was arranged as described by the manufacturer emulating typical user configuration for testing purposes. For testing purposes, the EUT received power from new internal batteries and/or external power supply and configured to operate in available modes. As requested by the manufacturer and required by regulations, the equipment was tested for compliance using the available configurations with the worst-case data presented. Test results in this report relate only to the products described in this report.



## Equipment Configuration



## Application for Certification

- (1) Manufacturer: Garmin International, Inc.  
1200 East 151st Street  
Olathe, KS 66062
- (2) Identification: M/N: AA03474  
FCC ID: IPH-A03474 IC: 1792A-A03474
- (3) Instruction Book:  
Refer to Exhibit for Instruction Manual.
- (4) Description of Circuit Functions:  
Refer to Exhibit of Operational Description.
- (5) Block Diagram with Frequencies:  
Refer to Exhibit of Operational Description.
- (6) Report of Measurements:  
Report of measurements follows in this Report.
- (7) Photographs: Construction, Component Placement, etc.:  
Refer to Exhibit for photographs of equipment.
- (8) List of Peripheral Equipment Necessary for operation. The equipment operates from direct current power provided from replaceable internal batteries. The design provides no interface options as presented in this filing. The EUT offers no other connection ports than those presented in this filing.
- (9) Transition Provisions of 47 CFR 15.37 are not requested.
- (10) Not Applicable. The unit is not a scanning receiver.
- (11) Not Applicable. The EUT does not operate in the 59 – 64 GHz frequency band.
- (12) The equipment is not software defined and this section is not applicable.
- (13) Applications for certification of U-NII devices in the 5.15-5.35 GHz and the 5.47-5.85 GHz bands must include a high-level operational description of the security procedures that control the radio frequency operating parameters and ensure that unauthorized modifications cannot be made. This requirement is not applicable to his DTS device.
- (14) Contain at least one drawing or photograph showing the test set-up for each of the required types of tests applicable to the device for which certification is requested. These drawings or photographs must show enough detail to confirm other information contained in the test report. Any photographs used must be focused originals without glare or dark spots and must clearly show the test configuration used. This information is provided in this report and Test Setup Exhibits provided with the application filing.

## Applicable Standards & Test Procedures

The following information is submitted in accordance with the eCFR Title 47 Federal Communications Code of Federal Regulations (47 CFR), dated September 25, 2019, Part 2, Subpart J, Paragraphs 2.907, 2.911, 2.913, 2.925, 2.926, 2.1031 through 2.1057, and applicable parts of paragraph 15, Part 15C Paragraph 15.247, and Industry Canada RSS-GEN Issue 5, and RSS-247 Issue 2. Test procedures used are the established Methods of Measurement of Radio-Noise Emissions as described in ANSI C63.10-2013. This report documents compliance for the EUT operations as Digital Transmission Systems operation.

## Testing Procedures

### ***AC Line Conducted Emission Test Procedure***

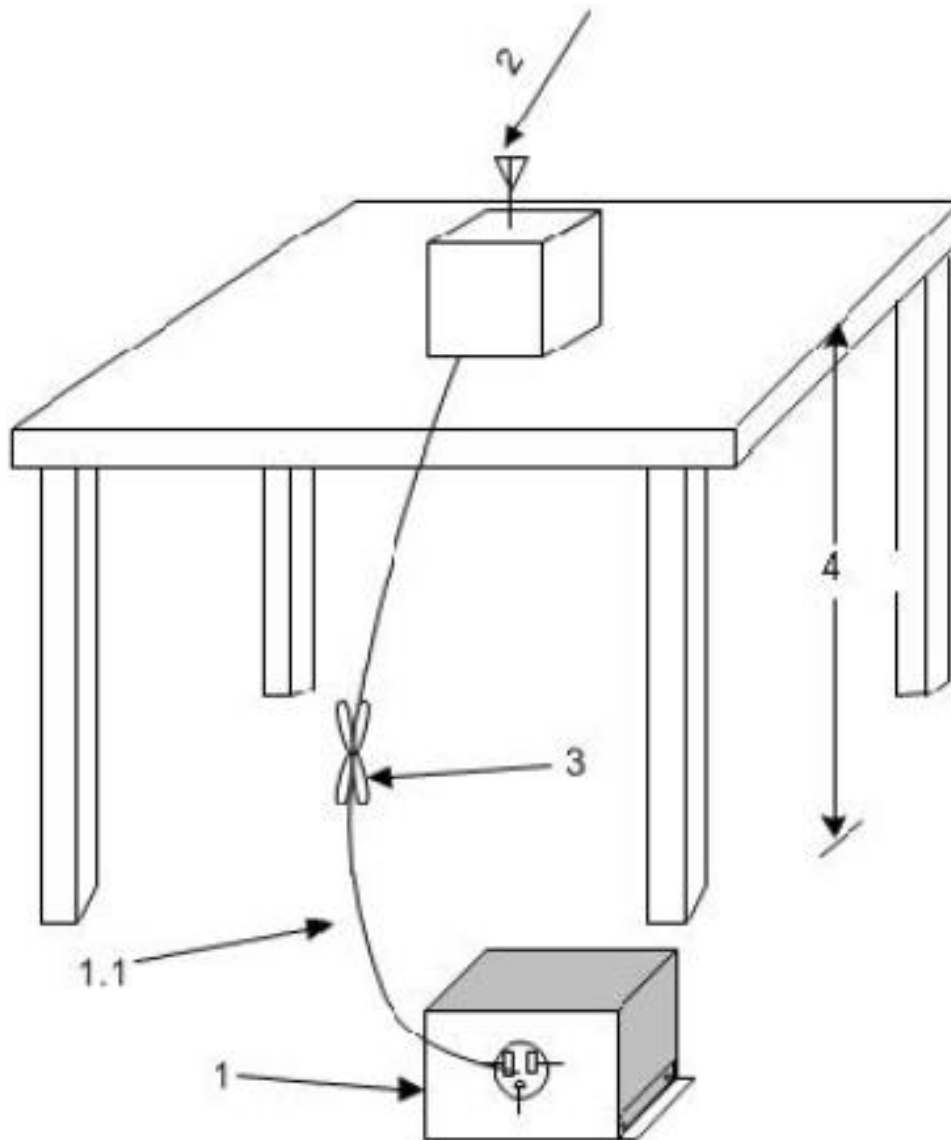
The EUT operates on direct current power only provided by the crafts installation. Therefore, no AC line conducted emission testing was required or performed.

### ***Radiated Emission Test Procedure***

Radiated emissions testing was performed as required in 47 CFR 15C, RSS-210 and specified in ANSI C63.10-2013. The EUT was placed on a rotating 0.9 x 1.2-meter platform, elevated as required above the ground plane at a distance of 3 meters from the FSM antenna. EMI energy was maximized by equipment placement permitting orientation in three orthogonal axes, raising and lowering the FSM antenna, changing the antenna polarization, and by rotating the turntable. Each emission was maximized before data was taken and recorded. The frequency spectrum from 9 kHz to 25,000 MHz was searched for emissions during preliminary investigation. Refer to diagrams one and two showing typical test setup. Refer to photographs in the test setup exhibits for specific EUT placement during testing.

## ***Antenna Port Conducted Emission Test Procedure***

The EUT was assembled as required for operation placed on a benchtop. This configuration provided the ability to connect test equipment to the provided test antenna port. Antenna Port conducted emissions testing was performed presented in the regulations and specified in ANSI C63.10-2013. Testing was completed on a laboratory bench in a shielded room. The active antenna port of the device was connected to appropriate attenuation and the spectrum analyzer. Refer to diagram three showing typical test arrangement and photographs in the test setup exhibits for specific EUT placement during testing.



1—A LISN is optional for radiated measurements between 30 MHz and 1000 MHz but not allowed for measurements below 30 MHz and above 1000 MHz (see 6.3.1). If used, then connect EUT to one LISN. Unused LISN measuring port connectors shall be terminated in 50  $\Omega$  loads. The LISN may be placed on top of, or immediately beneath, the reference ground plane (see 6.2.2 and 6.2.3.2).

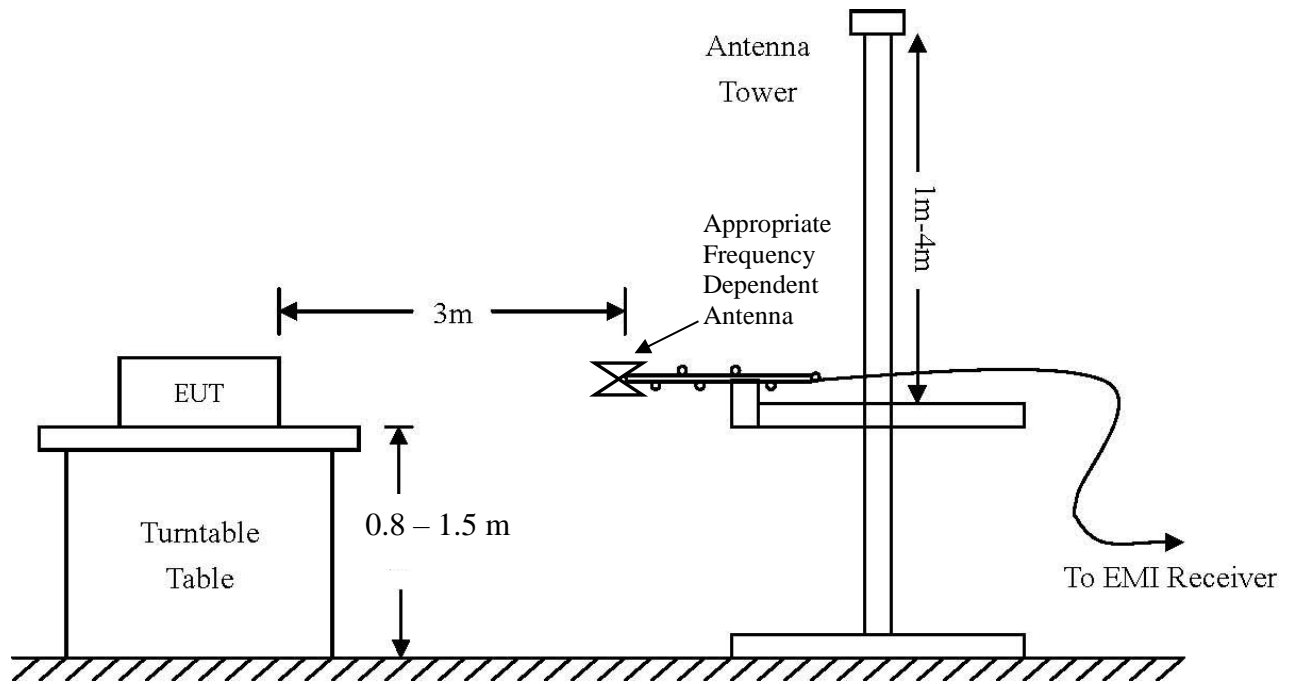
1.1—LISN spaced at least 80 cm from the nearest part of the EUT chassis.

2—Antenna can be integral or detachable, depending on the EUT (see 6.3.1).

3—Interconnecting cables that hang closer than 40 cm to the ground plane shall be folded back and forth in the center forming a bundle 30 cm to 40 cm long (see 6.3.1).

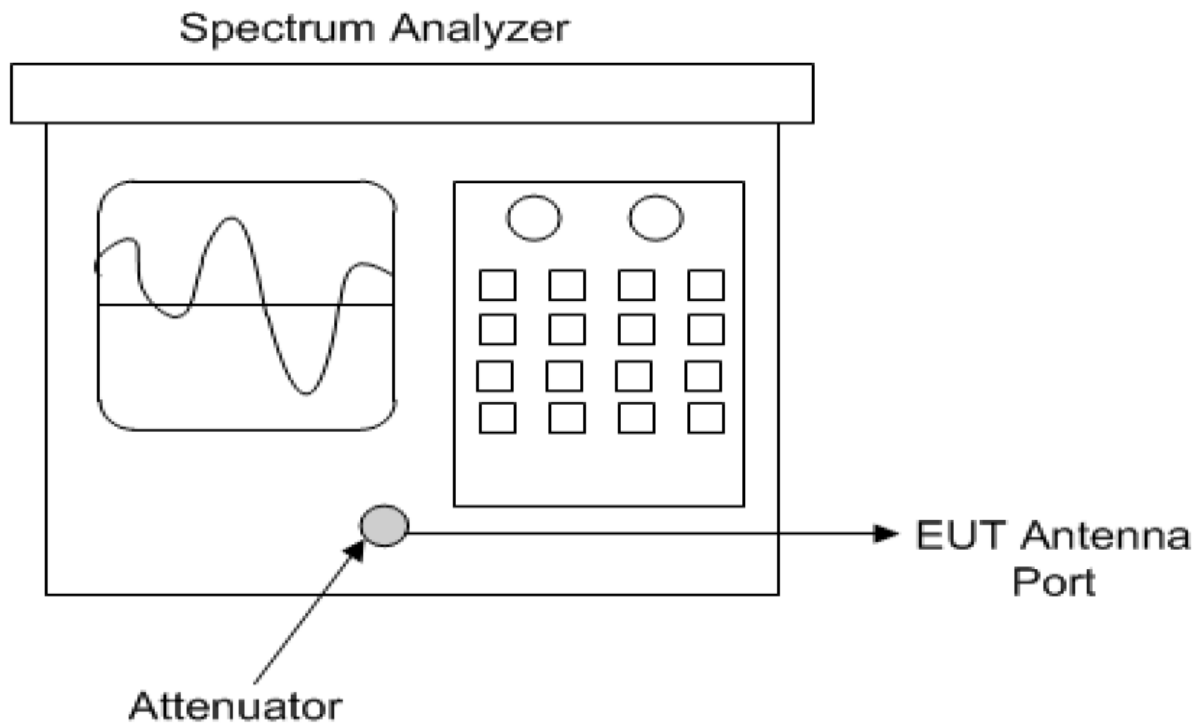
4—For emission measurements at or below 1 GHz, the table height shall be 80 cm. For emission measurements above 1 GHz, the table height shall be 1.5 m for measurements, except as otherwise specified (see 6.3.1 and 6.6.3.1).

**Diagram 1 Test arrangement for radiated emissions of tabletop equipment**



| AC Line Conducted Emissions (0.150 -30 MHz) |          |                   |
|---|----------|-------------------|
| RBW   | AVG. BW  | Detector Function |
| 9 kHz                                       | 30 kHz   | Peak / Quasi Peak |
| Emissions (30-1000 MHz)                     |          |                   |
| RBW   | AVG. BW  | Detector Function |
| 120 kHz                                     | 300 kHz  | Peak / Quasi Peak |
| Emissions (Above 1000 MHz)                  |          |                   |
| RBW   | Video BW | Detector Function |
| 100 kHz                                     | 100 kHz  | Peak              |
| 1 MHz                                       | 1 MHz    | Peak / Average    |

**Diagram 2 Test arrangement for radiated emissions tested on Open Area Test Site (OATS)**



**Diagram 3 Test arrangement for Antenna Port Conducted emissions**

### Test Site Locations

Conducted EMI AC line conducted emissions testing performed in a shielded screen room located at Rogers Labs, Inc., 4405 West 259<sup>th</sup> Terrace, Louisburg, KS

Radiated EMI The radiated emissions tests were performed at the 3 meters, Open Area Test Site (OATS) located at Rogers Labs, Inc., 4405 West 259<sup>th</sup> Terrace, Louisburg, KS

Registered Site information: FCC Site: US5305 and ISED #: 3041A, CAB Identifier: US0096

NVLAP Accreditation Lab code 200087-0

## List of Test Equipment

| <u>Equipment</u>                                    | <u>Manufacturer</u> | <u>Model (SN)</u>               | <u>Band</u>  | <u>Cal Date(m/d/y)</u> | <u>Due</u> |
|---|---------------------|---------------------------------|--------------|------------------------|------------|
| <input type="checkbox"/> LISN                       | FCC                 | FCC-LISN-50-25-10(1PA) (160611) | .15-30MHz    | 4/18/2019              | 4/18/2020  |
| <input type="checkbox"/> LISN                       | Compliance Design   | FCC-LISN-2.Mod.cd,(126)         | .15-30MHz    | 10/16/2018             | 10/16/2019 |
| <input checked="" type="checkbox"/> Cable           | Huber & Suhner Inc. | Sucoflex102ea(L10M)(303073)     | 9kHz-40 GHz  | 10/16/2018             | 10/16/2019 |
| <input checked="" type="checkbox"/> Cable           | Huber & Suhner Inc. | Sucoflex102ea(1.5M)(303069)     | 9kHz-40 GHz  | 10/16/2018             | 10/16/2019 |
| <input checked="" type="checkbox"/> Cable           | Huber & Suhner Inc. | Sucoflex102ea(1.5M)(303071)     | 9kHz-40 GHz  | 10/16/2018             | 10/16/2019 |
| <input type="checkbox"/> Cable                      | Belden              | RG-58 (L1-CAT3-11509)           | 9kHz-30 MHz  | 10/16/2018             | 10/16/2019 |
| <input type="checkbox"/> Cable                      | Belden              | RG-58 (L2-CAT3-11509)           | 9kHz-30 MHz  | 10/16/2018             | 10/16/2019 |
| <input type="checkbox"/> Antenna                    | ARA                 | BCD-235-B (169)                 | 20-350MHz    | 10/16/2018             | 10/16/2019 |
| <input type="checkbox"/> Antenna                    | EMCO                | 3147 (40582)                    | 200-1000MHz  | 10/16/2018             | 10/16/2019 |
| <input checked="" type="checkbox"/> Antenna         | ETS-Lindgren        | 3117 (200389)                   | 1-18 GHz     | 5/2/2018               | 5/2/2020   |
| <input type="checkbox"/> Antenna                    | Com Power           | AH-118 (10110)                  | 1-18 GHz     | 10/16/2018             | 10/24/2019 |
| <input checked="" type="checkbox"/> Antenna         | Com Power           | AH-840 (101046)                 | 18-40 GHz    | 4/18/2019              | 4/18/2021  |
| <input checked="" type="checkbox"/> Antenna         | Com Power           | AL-130 (121055)                 | .001-30 MHz  | 10/16/2018             | 10/16/2019 |
| <input checked="" type="checkbox"/> Antenna         | Sunol               | JB-6 (A100709)                  | 30-1000 MHz  | 10/16/2018             | 10/16/2019 |
| <input checked="" type="checkbox"/> Analyzer        | Rohde & Schwarz     | ESU40 (100108)                  | 20Hz-40GHz   | 4/18/2019              | 4/18/2020  |
| <input checked="" type="checkbox"/> Analyzer        | Rohde & Schwarz     | ESW44 (101534)                  | 20Hz-44GHz   | 1/31/2019              | 1/31/2020  |
| <input checked="" type="checkbox"/> Analyzer        | Rohde & Schwarz     | FS-Z60, 90, 140, and 220        | 40GHz-220GHz | 12/22/2017             | 12/22/2019 |
| <input checked="" type="checkbox"/> Amplifier       | Com-Power           | PA-010 (171003)                 | 100Hz-30MHz  | 10/16/2018             | 10/16/2019 |
| <input checked="" type="checkbox"/> Amplifier       | Com-Power           | CPPA-102 (01254)                | 1-1000 MHz   | 10/16/2018             | 10/16/2019 |
| <input checked="" type="checkbox"/> Amplifier       | Com-Power           | PAM-118A (551014)               | 0.5-18 GHz   | 10/16/2018             | 10/16/2019 |
| <input checked="" type="checkbox"/> Amplifier       | Com-Power           | PAM-840A (461328)               | 18-40 GHz    | 10/16/2018             | 10/16/2019 |
| <input checked="" type="checkbox"/> Power Meter     | Agilent             | N1911A with N1921A              | 0.05-40 GHz  | 4/18/2019              | 4/18/2020  |
| <input type="checkbox"/> Generator                  | Rohde & Schwarz     | SMB100A6 (100150)               | 20Hz-6 GHz   | 4/18/2019              | 4/18/2020  |
| <input type="checkbox"/> Generator                  | Rohde & Schwarz     | SMBV100A6 (260771)              | 20Hz-6 GHz   | 4/18/2019              | 4/18/2020  |
| <input type="checkbox"/> RF Filter                  | Micro-Tronics       | BRC50722 (009).9G notch         | 30-1800 MHz  | 4/18/2019              | 4/18/2020  |
| <input type="checkbox"/> RF Filter                  | Micro-Tronics       | HPM50114 (017)1.5G HPF          | 30-18000 MHz | 4/18/2019              | 4/18/2020  |
| <input type="checkbox"/> RF Filter                  | Micro-Tronics       | HPM50117 (063) 3G HPF           | 30-18000 MHz | 4/18/2019              | 4/18/2020  |
| <input type="checkbox"/> RF Filter                  | Micro-Tronics       | HPM50105 (059) 6G HPF           | 30-18000 MHz | 4/18/2019              | 4/18/2020  |
| <input type="checkbox"/> RF Filter                  | Micro-Tronics       | BRM50702 (172) 2G notch         | 30-1800 MHz  | 4/18/2019              | 4/18/2020  |
| <input type="checkbox"/> RF Filter                  | Micro-Tronics       | BRC50703 (G102) 5G notch        | 30-1800 MHz  | 4/18/2019              | 4/18/2020  |
| <input type="checkbox"/> RF Filter                  | Micro-Tronics       | BRC50705 (024) 5G notch         | 30-1800 MHz  | 4/18/2019              | 4/18/2020  |
| <input type="checkbox"/> Attenuator                 | Fairview            | SA6NFN100W-14 (1625)            | 30-1800 MHz  | 4/18/2019              | 4/18/2020  |
| <input checked="" type="checkbox"/> Attenuator      | Mini-Circuits       | VAT-3W2+ (1436)                 | 30-6000 MHz  | 4/18/2019              | 4/18/2020  |
| <input type="checkbox"/> Attenuator                 | Mini-Circuits       | VAT-3W2+ (1445)                 | 30-6000 MHz  | 4/18/2019              | 4/18/2020  |
| <input type="checkbox"/> Attenuator                 | Mini-Circuits       | VAT-6W2+ (1438)                 | 30-6000 MHz  | 4/18/2019              | 4/18/2020  |
| <input type="checkbox"/> Attenuator                 | Mini-Circuits       | VAT-6W2+ (1736)                 | 30-6000 MHz  | 4/18/2019              | 4/18/2020  |
| <input checked="" type="checkbox"/> Weather station | Davis               | 6312 (A81120N075)               |              | 10/26/2018             | 10/26/2019 |



## Units of Measurements

Conducted EMI            Data presented in dB $\mu$ V; dB referenced to one microvolt

Antenna port Conducted        Data is in dBm; dB referenced to one milliwatt

Radiated EMI            Data presented in dB $\mu$ V/m; dB referenced to one microvolt per meter

Note: The limit is expressed for a measurement in dB $\mu$ V/m when the measurement is taken at a distance of 3 or 10 meters. Data taken for this report was taken at distance of 3 meters. Sample calculation demonstrates corrected field strength reading for Open Area Test Site using the measurement reading and correcting for receive antenna factor, cable losses, and amplifier gains.

Sample Calculation:

RFS = Radiated Field Strength, FSM = Field Strength Measured

A.F. = Receive antenna factor, Losses = attenuators/cable losses, Gain = amplification gains

$RFS (dB\mu V/m @ 3m) = FSM (dB\mu V) + A.F. (dB/m) + Losses (dB) - Gain (dB)$

## Environmental Conditions

Ambient Temperature        25.2° C

Relative Humidity        40 %

Atmospheric Pressure        1012.6 mb

## Statement of Modifications and Deviations

No modifications to the EUT were required for the unit to demonstrate compliance with the 47 CFR Part 15C, RSS-Gen, and RSS-247 emission requirements. There were no deviations to the specifications.

## **Intentional Radiators**

The following information is submitted in support demonstration of compliance with the requirements of 47 CFR, Subpart C, paragraph 15.247 and Industry Canada RSS-247 and RSS-Gen the following information is submitted.

### ***Antenna Requirements***

The EUT incorporates integral antenna system and offers no provision for connection to alternate antenna system. The antenna connection point complies with the unique antenna connection requirements. There are no deviations or exceptions to the specification.

### ***Restricted Bands of Operation***

Spurious emissions falling in the restricted frequency bands of operation were measured at the OATS. The EUT utilizes frequency, determining circuitry, which generates harmonics falling in the restricted bands. Emissions were investigated at the OATS, using appropriate antennas or pyramidal horns, amplification stages, and a spectrum analyzer. Peak and average amplitudes of frequencies above 1000 MHz were compared to the required limits with worst-case data presented below. Test procedures of ANSI C63.10-2013 were used during testing. No other significant emission was observed which fell into the restricted bands of operation. Computed emission values consider the received radiated field strength, receive antenna correction factor, amplifier gain stage, and test system cable losses.

**Table 1 Harmonic Radiated Emissions in Restricted Bands Data (GMSK)**

| Frequency in MHz | Horizontal Peak (dBµV/m) | Horizontal Average (dBµV/m) | Vertical Peak (dBµV/m) | Vertical Average (dBµV/m) | Limit @ 3m (dBµV/m) | Horizontal Margin (dBm) | Vertical Margin (dBm) |
|------------------|--------------------------|-----------------------------|------------------------|---------------------------|---------------------|-------------------------|-----------------------|
| 2390.0           | 51.0                     | 36.6                        | 47.6                   | 34.4                      | 54.0                | -17.4                   | -19.6                 |
| 2483.5           | 59.4                     | 41.7                        | 56.1                   | 38.4                      | 54.0                | -12.3                   | -15.6                 |
| 4804.0           | 52.0                     | 38.5                        | 51.2                   | 38.4                      | 54.0                | -15.5                   | -15.6                 |
| 4880.0           | 51.9                     | 39.0                        | 52.0                   | 38.9                      | 54.0                | -15.0                   | -15.1                 |
| 4960.0           | 51.5                     | 38.8                        | 51.9                   | 38.6                      | 54.0                | -15.2                   | -15.4                 |
| 7206.0           | 58.8                     | 45.5                        | 56.9                   | 43.6                      | 54.0                | -8.5                    | -10.4                 |
| 7320.0           | 58.6                     | 45.7                        | 61.4                   | 48.7                      | 54.0                | -8.3                    | -5.3                  |
| 7440.0           | 59.5                     | 45.6                        | 61.3                   | 48.4                      | 54.0                | -8.4                    | -5.6                  |
| 12010.0          | 61.1                     | 47.6                        | 60.5                   | 47.2                      | 54.0                | -6.4                    | -6.8                  |
| 12200.0          | 60.4                     | 47.9                        | 61.1                   | 47.9                      | 54.0                | -6.1                    | -6.1                  |
| 12400.0          | 60.5                     | 47.9                        | 60.9                   | 47.9                      | 54.0                | -6.1                    | -6.1                  |

Other emissions present had amplitudes at least 20 dB below the limit. Peak and Quasi-Peak amplitude emissions are recorded for frequency below 1000 MHz. Peak and Average amplitude emissions are recorded for frequency range above 1000 MHz.

**Summary of Results for Radiated Emissions in Restricted Bands**

The EUT demonstrated compliance with the radiated emissions requirements of 47 CFR Part 15C RSS-Gen, and RSS-247 Intentional Radiators. The EUT worst-case operation demonstrated a minimum radiated emission margin of -5.3 dB below the requirements in restricted frequency bands. Peak, Quasi-peak, and average amplitudes were checked for compliance with the regulations. Worst-case emissions are reported with other emissions found in the restricted frequency bands at least 20 dB below the requirements.

## **General Radiated Emissions Procedure**

The EUT was arranged in a typical equipment configuration and operated through all available mode during testing. Preliminary testing was performed in a screen room with the EUT positioned 1 meter from the FSM. Radiated emissions measurements were performed to identify the frequencies, which produced the highest emissions. Each radiated emission was then maximized at the OATS location before final radiated measurements were performed. Final data was taken with the EUT located on the OATS at 3 meters distance between the EUT and the receiving antenna. The frequency spectrum from 9 kHz to 25,000 MHz was searched for general radiated emissions. Measured emission levels were maximized by EUT placement on the table, rotating the turntable through 360 degrees, varying the antenna height between 1 and 4 meters above the ground plane and changing antenna position between horizontal and vertical polarization. Antennas used were Loop from 9 kHz to 30 MHz, Broadband Biconical from 30 to 200 MHz, Biconilog from 30 to 1000 MHz, Log Periodic from 200 MHz to 1 GHz and or double Ridge or pyramidal horns and mixers above 1 GHz, notch filters and appropriate amplifiers and external mixers were utilized.

**Table 2 General Radiated Emissions Data**

| Frequency (MHz) | Horizontal Peak (dBµV/m) | Horizontal Quasi-Peak (dBµV/m) | Vertical Peak (dBµV/m) | Vertical Quasi-Peak (dBµV/m) | Limit @ 3m (dBµV/m) | Horizontal Margin (dBm) | Vertical Margin (dBm) |
|-----------------|--------------------------|--------------------------------|------------------------|------------------------------|---------------------|-------------------------|-----------------------|
| 32.0            | 37.1                     | 30.6                           | 33.4                   | 30.5                         | 40.0                | -9.4                    | -9.5                  |
| 48.0            | 37.5                     | 33.8                           | 36.6                   | 34.1                         | 40.0                | -6.2                    | -5.9                  |
| 56.0            | 34.5                     | 27.1                           | 35.9                   | 31.8                         | 40.0                | -12.9                   | -8.2                  |
| 56.5            | 36.4                     | 28.9                           | 33.5                   | 28.5                         | 40.0                | -11.1                   | -11.5                 |
| 64.0            | 30.4                     | 25.1                           | 30.8                   | 24.7                         | 40.0                | -14.9                   | -15.3                 |
| 72.0            | 30.4                     | 23.9                           | 31.6                   | 26.8                         | 40.0                | -16.1                   | -13.2                 |
| 270.0           | 27.5                     | 25.3                           | 24.3                   | 21.6                         | 46.0                | -20.7                   | -24.4                 |

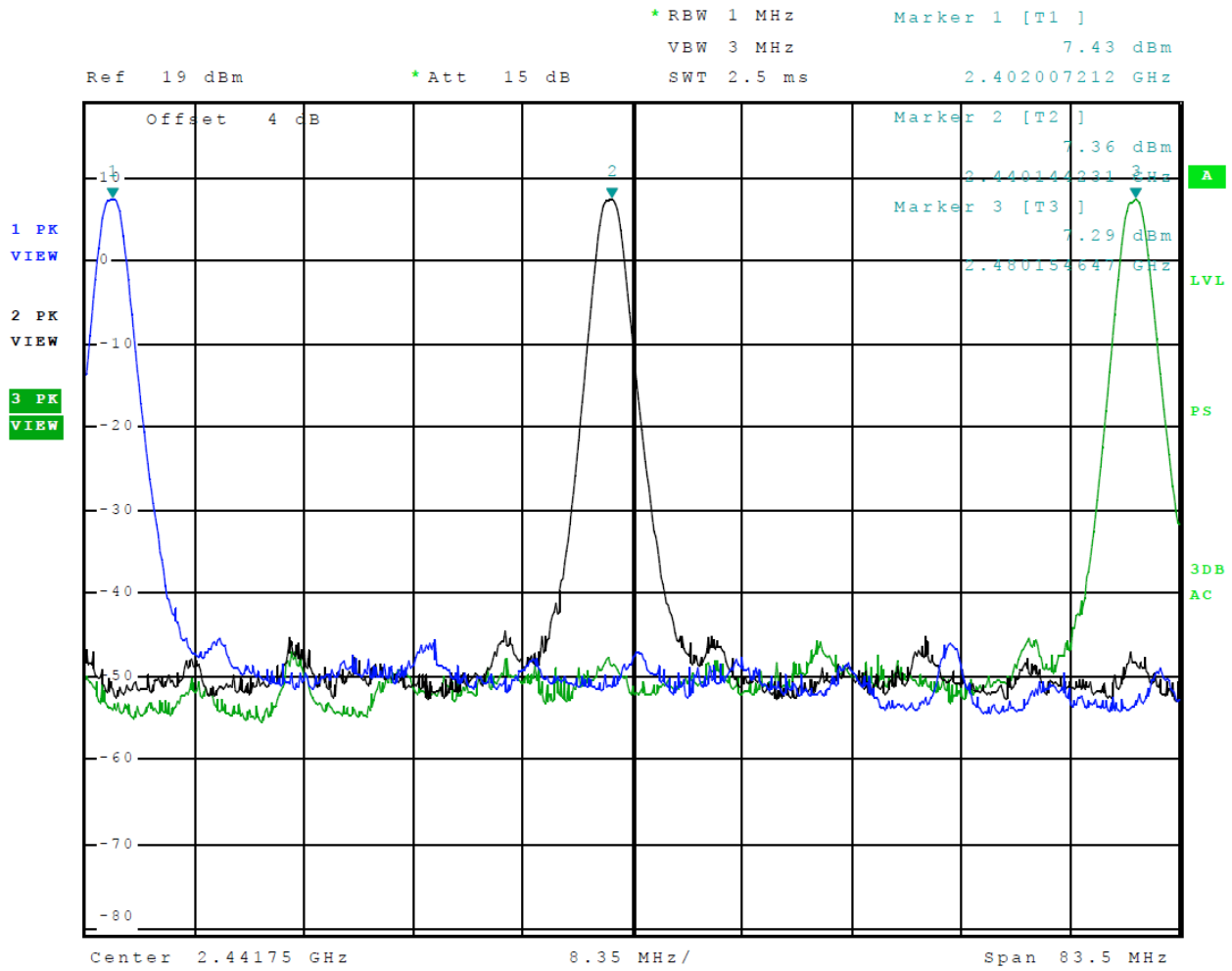
Other emissions present had amplitudes at least 20 dB below the limit. Peak and Quasi-Peak amplitude emissions are recorded for frequency range below 1000 MHz. Peak and Average amplitude emissions are recorded for frequency range above 1000 MHz.

**Summary of Results for General Radiated Emissions**

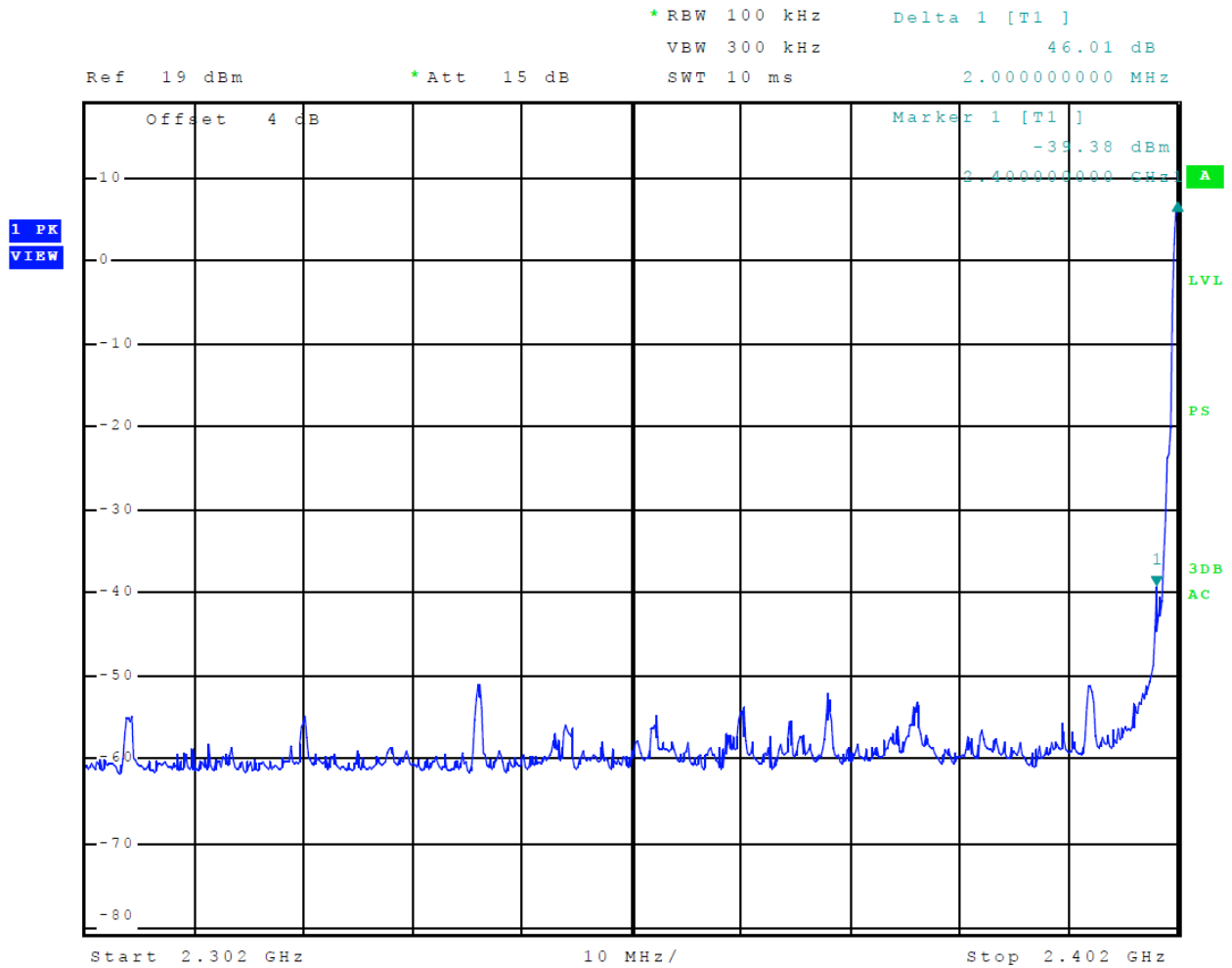
The EUT demonstrated compliance with the radiated emissions requirements of 47 CFR Part 15C paragraph 15.209, RSS-247 and RSS-GEN Intentional Radiators. The EUT demonstrated a minimum margin of -5.9 dB below the requirements. Other emissions were present with amplitudes at least 20 dB below the Limits.

### **Operation in the Band 2400 – 2483.5 MHz**

Test procedures of ANSI C63.10-2013 paragraph 6, and KDB 558074 were used during transmitter testing. Test sample #2 was provided for testing antenna port conducted emissions. This sample was modified by replacing the internal antenna with a 50-ohm antenna port connector and attenuator for testing purposes. The transmitter peak and average power was measured at the antenna port using a wideband RF power meter as described in KDB 558074 and ANSI C63.10-2013. Average power measured did not include any time intervals during which the transmitter was off or transmitting at a reduced power level. The peak Power Spectral Density (PKPSD) was measured as defined in KDB 558074 and ANSI C63.10-2013. DTS Emission bandwidth was measured as described in KDB 558074 and ANSI C63.10-2013. The amplitude of each harmonic and general radiated emission was measured on the OATS at distance of 3 meters from the FSM antenna (radiated emission testing was performed on sample #1 representative of production equipment with integral antenna). The EUT was positioned on supporting turntable elevated as required above the ground plane, at a distance of 3 meters from the FSM antenna. Radiated emission investigations were performed from 9 kHz to 25,000 MHz. Each radiated emission was maximized by varying the FSM antenna height and polarization, and by rotating the turntable. The worst-case amplitude of each emission was then recorded from the analyzer display. The peak and quasi-peak amplitude of frequencies below 1000 MHz were measured using a spectrum analyzer. The peak and average amplitude of frequencies above 1000 MHz were measured using a spectrum analyzer. A Loop antenna was used for measuring emissions from 0.009 to 30 MHz, Biconilog Antenna for 30 to 1000 MHz, Double-Ridge, and/or Pyramidal Horn Antennas from 1 GHz to 25 GHz. Radiated Emissions were measured in dB $\mu$ V/m @ 3 meters. Plots were taken of transmitter performance (using sample #2) for reference in this and other documentation.

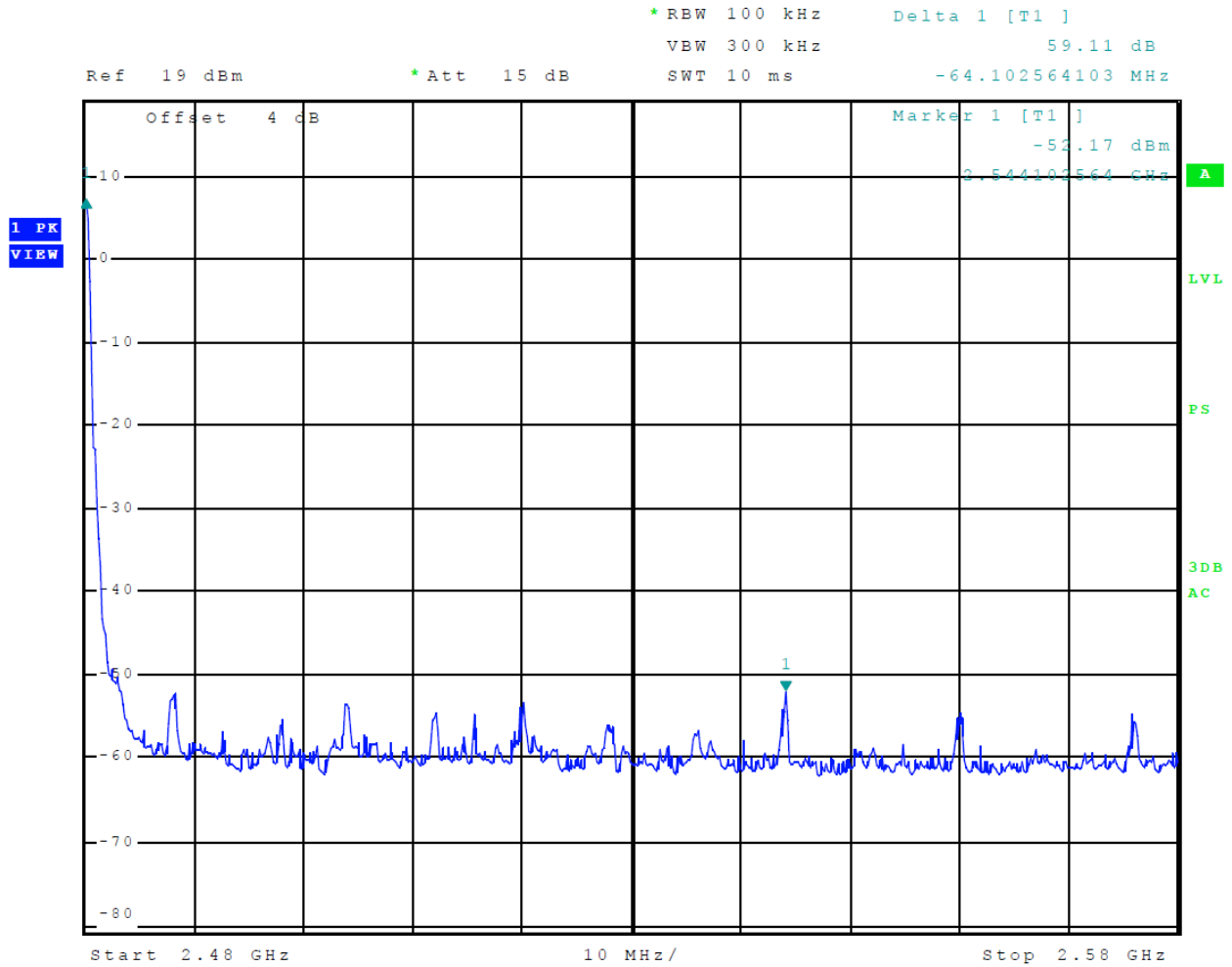


**Figure 1 Plot of Transmitter Operation in 2402-2480 MHz (GMSK)**

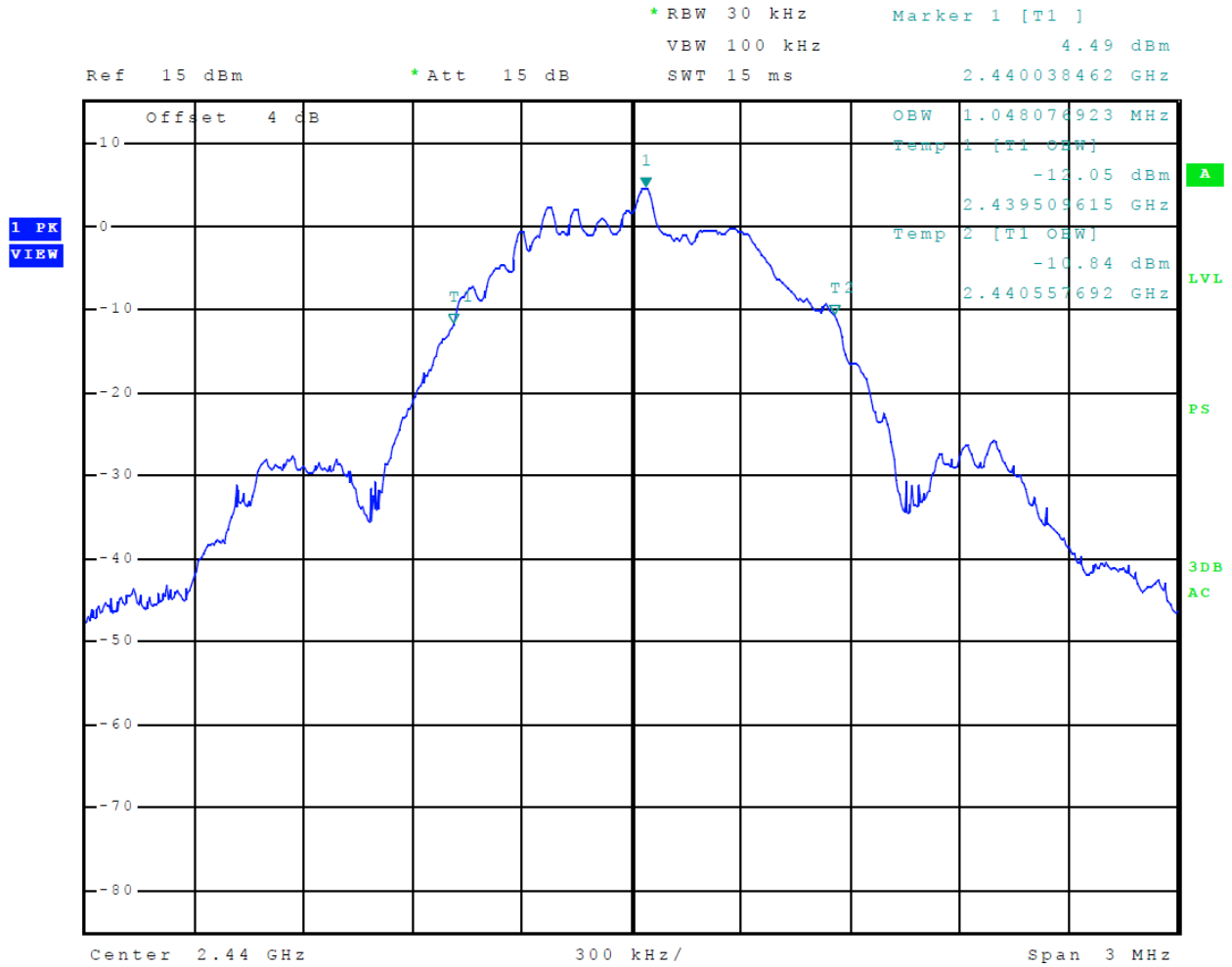


**Figure 2 Plot of Transmitter Emissions Low Band Edge (GMSK)**

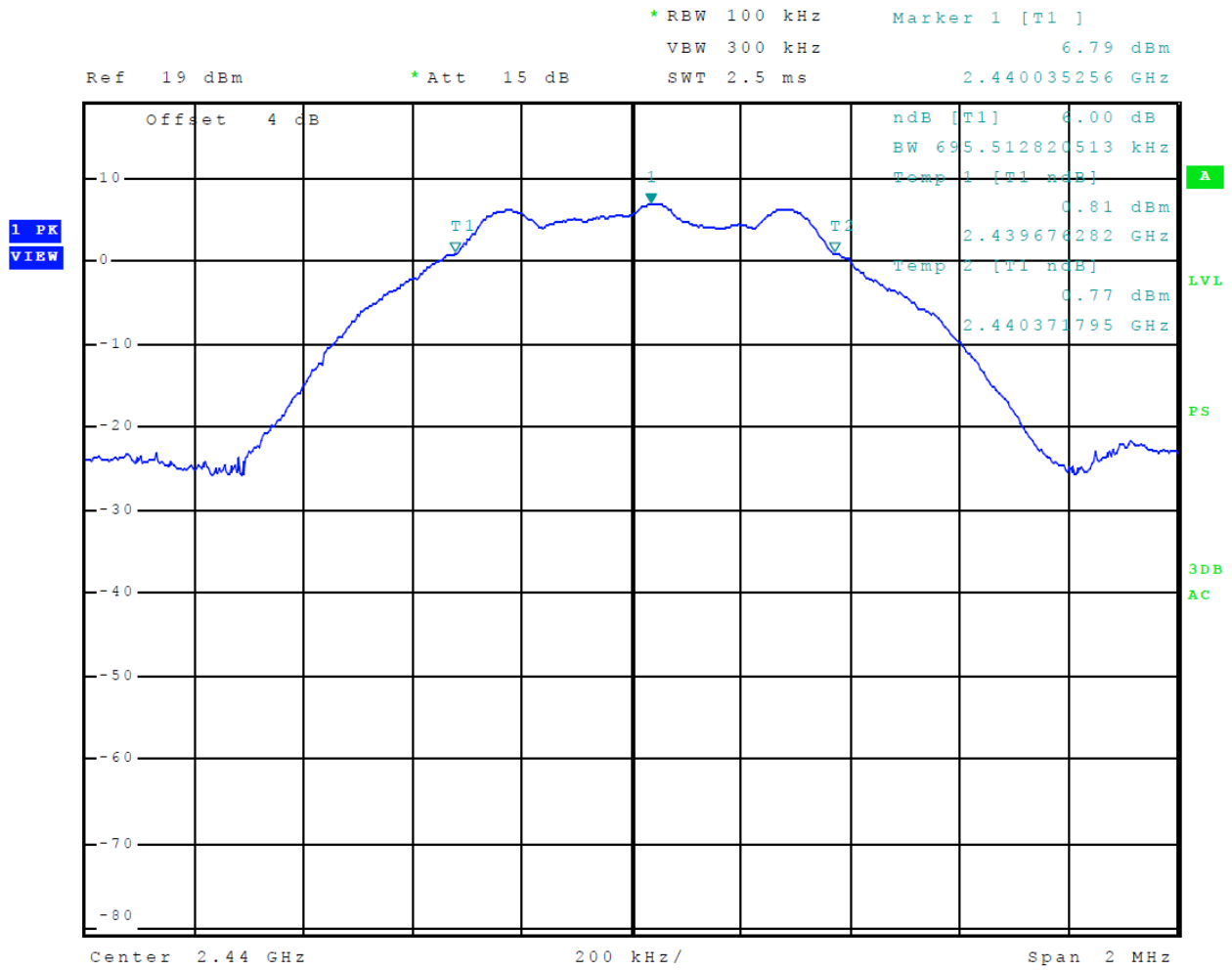




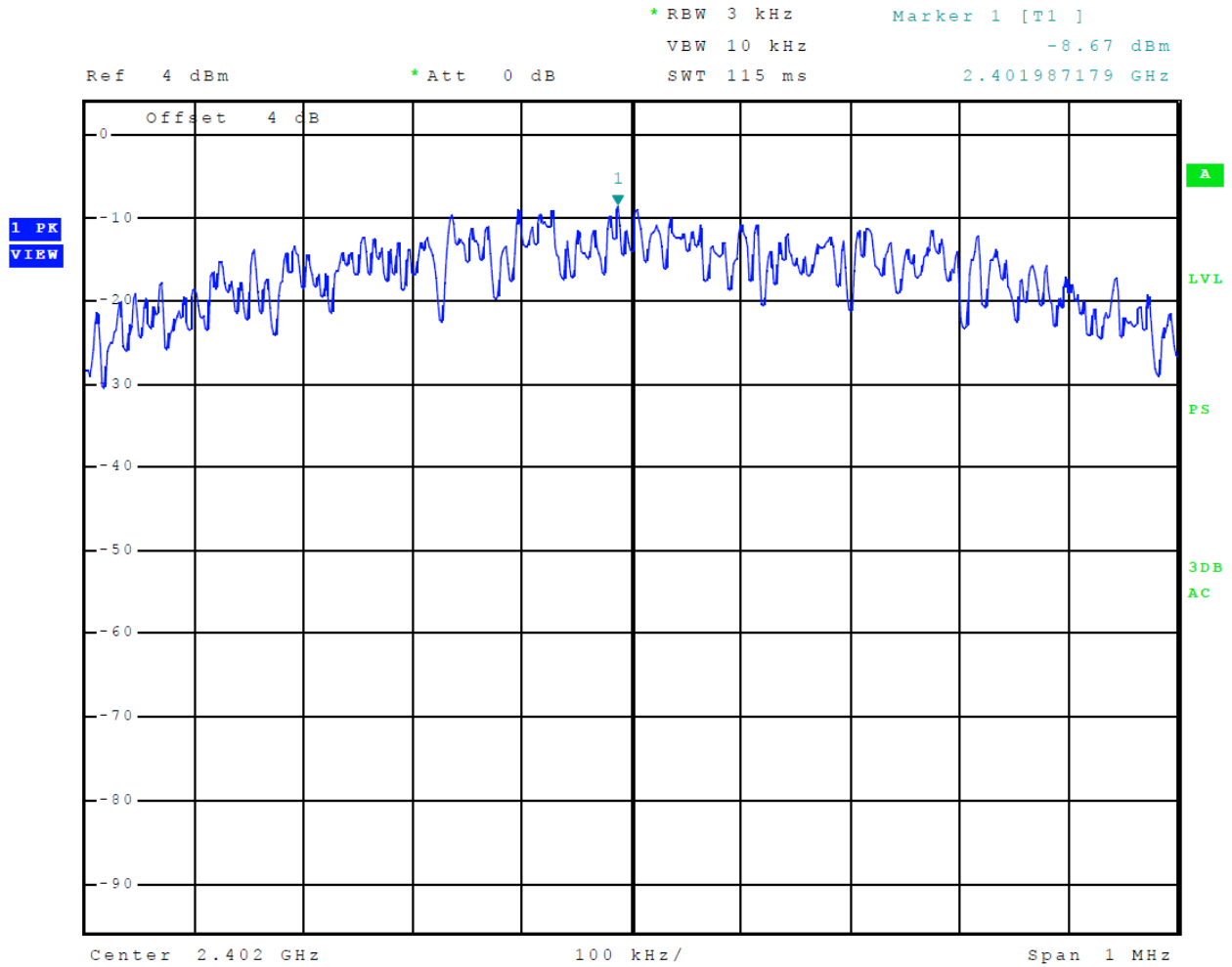
**Figure 3 Plot of Transmitter Emissions High Band Edge (GMSK)**



**Figure 4 Plot of 99% Occupied Bandwidth (GMSK)**



**Figure 5 Plot of 6-dB Occupied Bandwidth (GMSK)**



**Figure 6 Plot of Transmitter Power Spectral Density (GMSK)**

**Transmitter Emissions Data**

**Table 3 Transmitter Radiated Emissions (GMSK)**

| Frequency in MHz | Horizontal Peak (dBµV/m) | Horizontal Average (dBµV/m) | Vertical Peak (dBµV/m) | Vertical Average (dBµV/m) | Limit @ 3m (dBµV/m) | Horizontal Margin (dBm) | Vertical Margin (dBm) |
|------------------|--------------------------|-----------------------------|------------------------|---------------------------|---------------------|-------------------------|-----------------------|
| 2402.0           | --                       | --                          | --                     | --                        | --                  | --                      | --                    |
| 4804.0           | 52.0                     | 38.5                        | 51.2                   | 38.4                      | 54.0                | -15.5                   | -15.6                 |
| 7206.0           | 58.8                     | 45.5                        | 56.9                   | 43.6                      | 54.0                | -8.5                    | -10.4                 |
| 9608.0           | 57.6                     | 44.7                        | 57.4                   | 44.6                      | 54.0                | -9.3                    | -9.4                  |
| 12010.0          | 61.1                     | 47.6                        | 60.5                   | 47.2                      | 54.0                | -6.4                    | -6.8                  |
| 14412.0          | 61.6                     | 48.7                        | 61.0                   | 48.6                      | 54.0                | -5.3                    | -5.4                  |
| 16814.0          | 62.1                     | 49.3                        | 62.3                   | 49.4                      | 54.0                | -4.7                    | -4.6                  |
| 2440.0           | --                       | --                          | --                     | --                        | --                  | --                      | --                    |
| 4880.0           | 51.9                     | 39.0                        | 52.0                   | 38.9                      | 54.0                | -15.0                   | -15.1                 |
| 7320.0           | 58.6                     | 45.7                        | 61.4                   | 48.7                      | 54.0                | -8.3                    | -5.3                  |
| 9760.0           | 57.2                     | 44.5                        | 57.6                   | 44.5                      | 54.0                | -9.5                    | -9.5                  |
| 12200.0          | 60.4                     | 47.9                        | 61.1                   | 47.9                      | 54.0                | -6.1                    | -6.1                  |
| 14640.0          | 62.0                     | 49.0                        | 61.9                   | 49.0                      | 54.0                | -5.0                    | -5.0                  |
| 17080.0          | 61.5                     | 48.4                        | 61.3                   | 48.4                      | 54.0                | -5.6                    | -5.6                  |
| 2480.0           | --                       | --                          | --                     | --                        | --                  | --                      | --                    |
| 4960.0           | 51.5                     | 38.8                        | 51.9                   | 38.6                      | 54.0                | -15.2                   | -15.4                 |
| 7440.0           | 59.5                     | 45.6                        | 61.3                   | 48.4                      | 54.0                | -8.4                    | -5.6                  |
| 9920.0           | 57.8                     | 44.6                        | 57.5                   | 44.6                      | 54.0                | -9.4                    | -9.4                  |
| 12400.0          | 60.5                     | 47.9                        | 60.9                   | 47.9                      | 54.0                | -6.1                    | -6.1                  |
| 14880.0          | 61.5                     | 48.8                        | 61.7                   | 48.8                      | 54.0                | -5.2                    | -5.2                  |
| 17360.0          | 61.2                     | 48.2                        | 61.2                   | 48.3                      | 54.0                | -5.8                    | -5.7                  |

Other emissions present had amplitudes at least 20 dB below the limit. Peak and Quasi-Peak amplitude emissions are recorded for frequency below 1000 MHz. Peak and Average amplitude emissions are recorded for frequency range above 1000 MHz.

**Table 4 Transmitter Antenna Port Conducted Data (GMSK)**

| Frequency<br>MHz | Antenna Port<br>Peak Output<br>Power (Watts) | 99%<br>Occupied<br>Bandwidth<br>(kHz) | 6-dB<br>Occupied<br>Bandwidth<br>(kHz) | Peak Power<br>Spectral<br>Density (dBm) |
|------------------|--|---------------------------------------|--|---|
| (GMSK)           |  |                                       |  |   |
| 2402             | 0.006  | 1043.3                                | 695.50                                 | -8.67                                   |
| 2440             | 0.005  | 1048.1                                | 695.5                                  | -8.7                                    |
| 2480             | 0.005  | 1048.1                                | 692.3                                  | -8.9                                    |

**Summary of Results for Transmitter Radiated Emissions of Intentional Radiator**

The EUT demonstrated compliance with the radiated and conducted emission requirements of 47CFR Part 15.247, RSS-GEN, and RSS-247 Digital Transmission Systems. Highest average output power measured at the antenna port was 0.006 Watts. The highest peak power spectral density measured at the antenna port presented a minimum margin of -16.7 dB below the requirements. The EUT demonstrated a minimum margin of -4.6 dB below the harmonic emissions requirements. There were no other significantly measurable emissions in the restricted bands other than those recorded in this report. Other emissions were present with amplitudes at least 20 dB below the requirements. There were no other deviations or exceptions to the requirements.

## Annex

- Annex A Measurement Uncertainty Calculations
- Annex B Additional Test Equipment
- Annex C Rogers Qualifications
- Annex D Rogers Labs Certificate of Accreditation

## Annex A Measurement Uncertainty Calculations

The measurement uncertainty was calculated for all measurements listed in this test report according To CISPR 16-4. Result of measurement uncertainty calculations are recorded below. Component and process variability of production devices similar to those tested may result in additional deviations. The manufacturer has the sole responsibility of continued compliance.

| Measurement                                     | Expanded Measurement Uncertainty $U_{(lab)}$ |
|---|--|
| 3 Meter Horizontal 0.009-1000 MHz Measurements  | 4.16   |
| 3 Meter Vertical 0.009-1000 MHz Measurements    | 4.33   |
| 3 Meter Measurements 1-18 GHz                   | 5.14   |
| 3 Meter Measurements 18-40 GHz                  | 5.16   |
| 10 Meter Horizontal Measurements 0.009-1000 MHz | 4.15   |
| 10 Meter Vertical Measurements 0.009-1000 MHz   | 4.32   |
| AC Line Conducted                               | 1.75   |
| Antenna Port Conducted power                    | 1.17   |
| Frequency Stability                             | 1.00E-11                                     |
| Temperature                                     | 1.6°C  |
| Humidity  | 3%   |



## **Annex B Additional Test Equipment**

| List of Test Equipment   | Calibration | <u>Date (m/d/y)</u> | <u>Due</u> |
|--|-------------|---------------------|------------|
| Antenna: Schwarzbeck Model: BBA 9106/VHBB 9124 (9124-627)      |             | 4/18/2019           | 4/18/2020  |
| Antenna: Schwarzbeck Model: VULP 9118 A (VULP 9118 A-534)      |             | 4/18/2019           | 4/18/2020  |
| Antenna: EMCO 6509   |             | 10/16/2018          | 10/16/2020 |
| Antenna: EMCO 3143 (9607-1277) 20-1200 MHz                     |             | 4/18/2019           | 4/18/2020  |
| Antenna: EMCO Dipole Set 3121C                                 |             | 2/22/2019           | 2/22/2020  |
| Antenna: C.D. B-101  |             | 2/22/2019           | 2/22/2020  |
| Antenna: Solar 9229-1 & 9230-1                                 |             | 2/22/2019           | 2/22/2020  |
| Cable: Belden 8268 (L3)  |             | 10/16/2018          | 10/16/2019 |
| Cable: Time Microwave: 4M-750HF290-750                         |             | 10/16/2018          | 10/16/2019 |
| Frequency Counter: Leader LDC-825 (8060153)                    |             | 4/18/2019           | 4/18/2020  |
| Oscilloscope Scope: Tektronix 2230                             |             | 2/22/2019           | 2/22/2020  |
| Wattmeter: Bird 43 with Load Bird 8085                         |             | 2/22/2019           | 2/22/2020  |
| R.F. Generators: HP 606A, HP 8614A, HP 8640B                   |             | 2/22/2019           | 2/22/2020  |
| R.F. Power Amp 65W Model: 470-A-1010                           |             | 2/22/2019           | 2/22/2020  |
| R.F. Power Amp 50W M185- 10-501                                |             | 2/22/2019           | 2/22/2020  |
| R.F. Power Amp A.R. Model: 10W 1010M7                          |             | 2/22/2019           | 2/22/2020  |
| R.F. Power Amp EIN Model: A301                                 |             | 2/22/2019           | 2/22/2020  |
| LISN: Compliance Eng. Model 240/20                             |             | 4/18/2019           | 4/18/2020  |
| LISN: Fischer Custom Communications Model: FCC-LISN-50-16-2-08 |             | 4/18/2019           | 4/18/2020  |
| Audio Oscillator: H.P. 201CD                                   |             | 2/22/2019           | 2/22/2020  |
| ESD Test Set 2010i   |             | 2/22/2019           | 2/22/2020  |
| Oscilloscope Scope: Tektronix MDO 4104                         |             | 2/22/2019           | 2/22/2020  |
| EMC Transient Generator HVT TR 3000                            |             | 2/22/2019           | 2/22/2020  |
| AC Power Source (Ametech, California Instruments)              |             | 2/22/2019           | 2/22/2020  |
| Fast Transient Burst Generator Model: EFT/B-101                |             | 2/22/2019           | 2/22/2020  |
| Field Intensity Meter: EFM-018                                 |             | 2/22/2019           | 2/22/2020  |
| KEYTEK Ecat Surge Generator                                    |             | 2/22/2019           | 2/22/2020  |
| ESD Simulator: MZ-15   |             | 2/22/2019           | 2/22/2020  |
| Shielded Room not required                                     |             |                     |            |

## **Annex C Rogers Qualifications**

***Scot D. Rogers, Engineer***

### **Rogers Labs, Inc.**

Mr. Rogers has approximately 31 years' experience in the field of electronics. Engineering experience includes six years in the automated controls industry and remaining years working with the design, development and testing of radio communications and electronic equipment.

#### Positions Held

Systems Engineer: A/C Controls Mfg. Co., Inc. 6 Years

Electrical Engineer: Rogers Consulting Labs, Inc. 5 Years

Electrical Engineer: Rogers Labs, Inc. Current

#### Educational Background

- 1) Bachelor of Science Degree in Electrical Engineering from Kansas State University.
- 2) Bachelor of Science Degree in Business Administration Kansas State University.
- 3) Several Specialized Training courses and seminars pertaining to Microprocessors and Software programming.

*Scot D. Rogers*

Scot D. Rogers

**Annex D Rogers Labs Certificate of Accreditation**

United States Department of Commerce  
National Institute of Standards and Technology



---

**Certificate of Accreditation to ISO/IEC 17025:2005**

---

NVLAP LAB CODE: 200087-0

**Rogers Labs, Inc.**  
Louisburg, KS

*is accredited by the National Voluntary Laboratory Accreditation Program for specific services,  
listed on the Scope of Accreditation, for:*

**Electromagnetic Compatibility & Telecommunications**

*This laboratory is accredited in accordance with the recognized International Standard ISO/IEC 17025:2005.  
This accreditation demonstrates technical competence for a defined scope and the operation of a laboratory quality  
management system (refer to joint ISO-ILAC-IAF Communique dated January 2009).*

---

2019-03-27 through 2020-03-31  
Effective Dates



---

*[Signature]*  
For the National Voluntary Laboratory Accreditation Program