

FCC Test Report

FCC ID : IPH-A4390
Equipment : Smart Watch
Model No. : AA4390
Brand Name : GARMIN
Applicant : Garmin International, Inc.
Address : 1200 E. 151st Street Olathe, KS 66062 United States
Standard : 47 CFR FCC Part 15.249
Received Date : Apr. 07, 2022
Tested Date : May. 05 ~ May. 09, 2022

We, International Certification Corporation, would like to declare that the tested sample has been evaluated and in compliance with the requirement of the above standards. The test results contained in this report refer exclusively to the product. It shall not be reproduced except in full without the written approval of our laboratory.

Reviewed by:

Approved by:



Along Chen / Assistant Manager



Gary Chang / Manager

Table of Contents

1	GENERAL DESCRIPTION	5
1.1	Information.....	5
1.2	Local Support Equipment List	7
1.3	Test Setup Chart	7
1.4	The Equipment List	8
1.5	Test Standards	9
1.6	Deviation from Test Standard and Measurement Procedure.....	9
1.7	Measurement Uncertainty	9
2	TEST CONFIGURATION.....	10
2.1	Testing Facility	10
2.2	The Worst Test Modes and Channel Details	10
3	TRANSMITTER TEST RESULTS	11
3.1	Radiated Emission	11
3.2	20dB and Occupied Bandwidth.....	14
3.3	AC Power Line Conducted Emissions	15
4	TEST LABORATORY INFORMATION	16
 APPENDIX A. RADIATED EMISSION		
APPENDIX B. 20DB AND OCCUPIED BANDWIDTH		
APPENDIX C. AC POWER LINE CONDUCTED EMISSIONS		

Release Record

Report No.	Version	Description	Issued Date
FR240703AF	Rev. 01	Initial issue	May 30, 2022

Summary of Test Results

FCC Rules	Test Items	Measured	Result
15.207	AC Power Line Conducted Emissions	[dBuV]: 0.788MHz 25.56 (Margin -20.44dB) - AV	Pass
15.249(a)	Field Strength of Fundamental	Meet the requirement of limit	Pass
15.249(a)(d)	Field Strength of Harmonics and Emissions Radiated outside of the Specified Frequency Bands	Meet the requirement of limit	Pass
15.215(c)	20dB bandwidth	Meet the requirement of limit	Pass
15.203	Antenna Requirement	Meet the requirement of limit	Pass

Declaration of Conformity:

The test results with all measurement uncertainty excluded are presented in accordance with the regulation limits or requirements declared by manufacturers.

Comments and Explanations:

The declared of product specification for EUT presented in the report are provided by the manufacturer, and the manufacturer takes all the responsibilities for the accuracy of product specification.

1 General Description

1.1 Information

1.1.1 Specification of the Equipment under Test (EUT)

RF General Information				
Frequency Range (MHz)	Modulation	Ch. Freq. (MHz)	Channel Number	Data Rate
2402-2480	GFSK	2402-2480	1-79 [79]	1 Mbps

1.1.2 Antenna Details

Ant. No.	Brand	Model	Type	Connector	Gain (dBi)
1	Garmin	117-01806-0X	PIFA	No	-2.08

1.1.3 Power Supply Type of Equipment under Test (EUT)

Power Type	5Vdc from adapter 3.87Vdc from battery
-------------------	---

1.1.4 Accessories

No.	Equipment	Description
1	Battery	Brand: Garmin Model: 361-00136-20 Power Rating: 3.87V, 205mAh
2	USB cable	Brand: GARMIN Model: 320-01069-10 Power line: 0.52m shielded without core

1.1.5 Channel List

Frequency band (MHz)				2400~2483.5			
Channel	Frequency (MHz)	Channel	Frequency (MHz)	Channel	Frequency (MHz)	Channel	Frequency (MHz)
1	2402	21	2422	41	2442	61	2462
2	2403	22	2423	42	2443	62	2463
3	2404	23	2424	43	2444	63	2464
4	2405	24	2425	44	2445	64	2465
5	2406	25	2426	45	2446	65	2466
6	2407	26	2427	46	2447	66	2467
7	2408	27	2428	47	2448	67	2468
8	2409	28	2429	48	2449	68	2469
9	2410	29	2430	49	2450	69	2470
10	2411	30	2431	50	2451	70	2471
11	2412	31	2432	51	2452	71	2472
12	2413	32	2433	52	2453	72	2473
13	2414	33	2434	53	2454	73	2474
14	2415	34	2435	54	2455	74	2475
15	2416	35	2436	55	2456	75	2476
16	2417	36	2437	56	2457	76	2477
17	2418	37	2438	57	2458	77	2478
18	2419	38	2439	58	2459	78	2479
19	2420	39	2440	59	2460	79	2480
20	2421	40	2441	60	2461	---	---

1.1.6 Test Tool and Duty Cycle

Test Tool	ANT Tests, Version: V97.26	
Duty Cycle and Duty Factor	Duty Cycle (%)	Duty Factor (dB)
	64.35%	1.91

1.1.7 Power Index of Test Tool

Modulation Mode	Test Frequency (MHz)		
	2402	2442	2480
ANT+	Default	Default	Default

1.2 Local Support Equipment List

Support Equipment List					
No.	Equipment	Brand	Model	FCC ID	Remarks
1	Adapter	samsung	ETA-U90JWS	---	---

1.3 Test Setup Chart

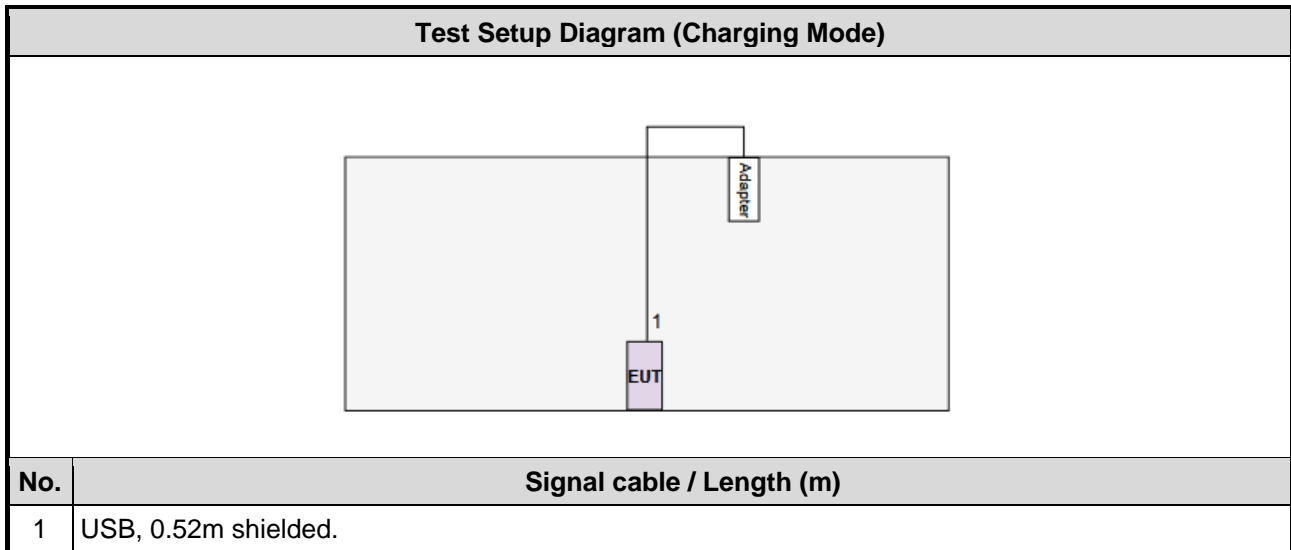
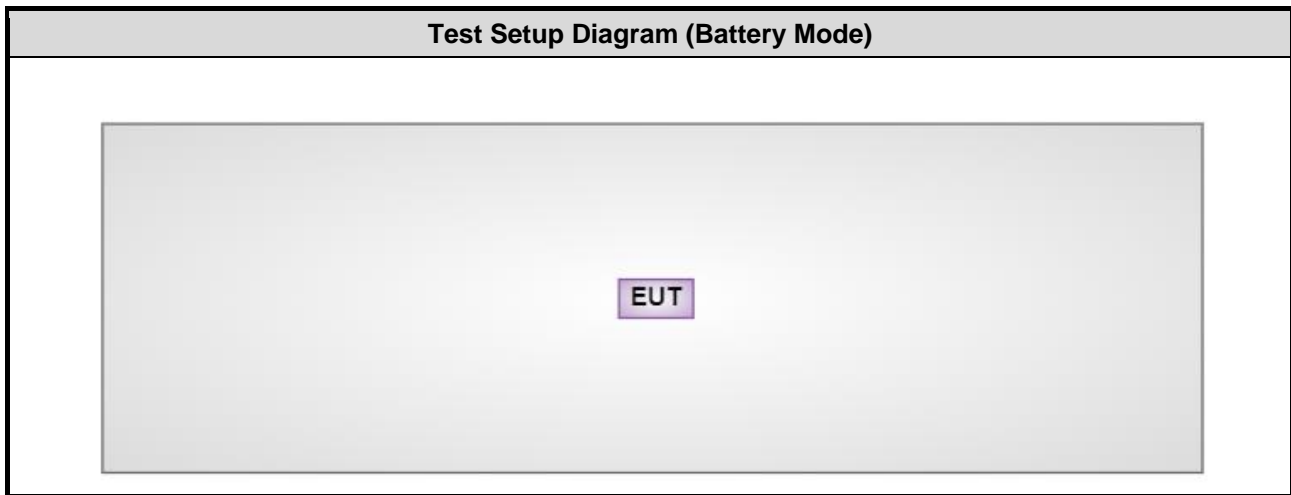

1.4 The Equipment List

Test Item	Conducted Emission				
Test Site	Conduction room 1 / (CO01-WS)				
Tested Date	May 09, 2022				
Instrument	Brand	Model No.	Serial No.	Calibration Date	Calibration Until
Receiver	R&S	ESR3	101658	Feb. 16, 2022	Feb. 15, 2023
LISN	R&S	ENV216	101579	Apr. 21, 2022	Apr. 20, 2023
LISN (Support Unit)	SCHWARZBECK	Schwarzbeck 8127	8127667	Jan .07, 2022	Jan .06, 2023
RF Cable-CON	Woken	CFD200-NL	CFD200-NL-001	Oct. 19, 2021	Oct. 18, 2022
50 ohm terminal (Support Unit)	NA	50	04	May 25, 2021	May 24, 2022
Measurement Software	AUDIX	e3	6.120210k	NA	NA

Note: Calibration Interval of instruments listed above is one year.

Test Item	Radiated Emission				
Test Site	966 chamber1 / (03CH01-WS)				
Tested Date	May 05 ~ May 09, 2022				
Instrument	Brand	Model No.	Serial No.	Calibration Date	Calibration Until
Receiver	R&S	ESR3	101657	Mar. 15, 2022	Mar. 14, 2023
Spectrum Analyzer	R&S	FSV40	101498	Nov. 29, 2021	Nov. 28, 2022
Loop Antenna	R&S	HFH2-Z2	100330	Nov. 08, 2021	Nov. 07, 2022
Bilog Antenna	SCHWARZBECK	VULB9168	VULB9168-522	Jun. 30, 2021	Jun. 29, 2022
Horn Antenna 1G-18G	SCHWARZBECK	BBHA 9120 D	BBHA 9120 D 1096	Dec. 03, 2021	Dec. 02, 2022
Horn Antenna 18G-40G	SCHWARZBECK	BBHA 9170	BBHA 9170508	Jan. 11, 2022	Jan. 10, 2023
Preamplifier	EMC	EMC02325	980225	Jun. 29, 2021	Jun. 28, 2022
Preamplifier	Agilent	83017A	MY39501308	Sep. 28, 2021	Sep. 27, 2022
Preamplifier	EMC	EMC184045B	980192	Jul. 14, 2021	Jul. 13, 2022
Loop Antenna Cable	KOAX KABEL	101354-BW	101354-BW	Oct. 05, 2021	Oct. 04, 2022
LF cable 3M	Woken	CFD400NL-LW	CFD400NL-001	Oct. 05, 2021	Oct. 04, 2022
LF cable 11M	EMC	EMCCFD400-NW-N W-11000	200801	Oct. 05, 2021	Oct. 04, 2022
LF cable 1M	EMC	EMCCFD400-NM-N M-1000	160502	Oct. 05, 2021	Oct. 04, 2022
RF Cable	EMC	EMC104-35M-35M-8000	210920	Oct. 05, 2021	Oct. 04, 2022
RF Cable	HUBER+SUHNER	SUCOFLEX104	MY16019/4	Oct. 05, 2021	Oct. 04, 2022
Measurement Software	AUDIX	e3	6.120210g	NA	NA

Note: Calibration Interval of instruments listed above is one year.

1.5 Test Standards

47 CFR FCC Part 15.249
ANSI C63.10-2013

1.6 Deviation from Test Standard and Measurement Procedure

None

1.7 Measurement Uncertainty

The measurement uncertainties given below are based on a 95% confidence level (based on a coverage factor ($k=2$)).

Measurement Uncertainty	
Parameters	Uncertainty
Bandwidth	± 34.130 Hz
AC conducted emission	± 2.92 dB
Radiated emission ≤ 1 GHz	± 3.41 dB
Radiated emission > 1 GHz	± 4.59 dB

2 Test Configuration

2.1 Testing Facility

Test Laboratory	International Certification Corporation
Test Site	CO01-WS, 03CH01-WS
Address of Test Site	No.3-1, Lane 6, Wen San 3rd St., Kwei Shan Dist., Tao Yuan City 33381, Taiwan (R.O.C.)

- FCC Designation No.: TW2732
- FCC site registration No.: 181692
- ISED#: 10807A
- CAB identifier: TW2732

2.2 The Worst Test Modes and Channel Details

Test item	Mode	Test Frequency (MHz)	Data Rate	Test Configuration
AC Power Line Conducted Emissions	Charging	---	---	1
Field Strength of Fundamental	GFSK	2402, 2442, 2480	1 Mbps	2
Radiated Emissions ≤ 1GHz	GFSK	2402	1 Mbps	2
	Charging	---	---	1
Radiated Emissions > 1GHz	GFSK	2402, 2442, 2480	1 Mbps	2
20dB bandwidth	GFSK	2402, 2442, 2480	1 Mbps	2

NOTE:

1. The EUT was pretested with 3 orientations placed on the table for the radiated emission measurement – X, Y, and Z-plane. The **Y-plane** result was found as the worst case and was shown in this report.
2. The test configurations are listed as follows:
 - 1) Configuration 1: Charging mode
 - 2) Configuration 2: Battery mode

3 Transmitter Test Results

3.1 Radiated Emission

This section includes field strength of fundamental, field strength of harmonics and emissions radiated outside of the operating frequency bands.

3.1.1 Limit of field strength of fundamental and field strength of harmonics

Fundamental Frequency	Field strength of fundamental (millivolts/meter)	Field strength of harmonics (microvolts/meter)
2400–2483.5 MHz	50	500

3.1.2 Limit of Unwanted Emissions

Emissions radiated outside of the specified frequency bands, except for harmonics, shall be attenuated by at least 50 dB below the level of the fundamental or to the general radiated emission limits in below table, whichever is the lesser attenuation.

Radiated emission limits			
Frequency Range (MHz)	Field Strength (uV/m)	Field Strength (dBuV/m)	Measure Distance (m)
0.009~0.490	2400/F(kHz)	48.5 - 13.8	300
0.490~1.705	24000/F(kHz)	33.8 - 23	30
1.705~30.0	30	29	30
30~88	100	40	3
88~216	150	43.5	3
216~960	200	46	3
Above 960	500	54	3

Note 1:

Qusai-Peak value is measured for frequency below 1GHz except for 9–90 kHz, 110–490 kHz frequency band. Peak and average value are measured for frequency above 1GHz. The limit on average radio frequency emission is as above table. The limit on peak radio frequency emissions is 20 dB above the maximum permitted average emission limit

Note 2:

Measurements may be performed at a distance other than what is specified provided. When performing measurements at a distance other than that specified, the results shall be extrapolated to the specified distance using an extrapolation factor as below, Frequency at or above 30 MHz: 20 dB/decade Frequency below 30 MHz: 40 dB/decade.

3.1.3 Test Procedures

1. Measurement is made at a semi-anechoic chamber that incorporates a turntable allowing a EUT rotation of 360°. A continuously-rotating, remotely-controlled turntable is installed at the test site to support the EUT and facilitate determination of the direction of maximum radiation for each EUT emission frequency. The EUT is placed at test table. For emissions testing at or below 1 GHz, the table height is 80 cm above the reference ground plane. For emission measurements above 1 GHz, the table height is 1.5 m
2. Measurement is made with the antenna positioned in both the horizontal and vertical planes of polarization. The measurement antenna is varied in height (1m ~ 4m) above the reference ground plane to obtain the maximum signal strength. Distance between EUT and antenna is 3 m.
3. This investigation is performed with the EUT rotated 360°, the antenna height scanned between 1 m and 4 m, and the antenna rotated to repeat the measurements for both the horizontal and vertical antenna polarizations.

Note:

1. Radiated emission below 1GHz
120kHz measurement bandwidth of test receiver and Quasi-peak detector is for radiated emission
2. Radiated emission above 1GHz / Peak value except fundamental
RBW=1MHz, VBW=3MHz and Peak detector
3. Radiated emission above 1GHz / Average value for field strength of fundamental and harmonics
The average value is: Average = Peak value + 20log(Duty cycle) Where the duty factor is calculated from following formula:

$$20\log(\text{Duty cycle}) = 20\log \frac{0.20058 \times 1\text{ms}}{100\text{ms}} = -53.95\text{dB}$$

4. Radiated emission above 1GHz / Average value for other emissions
RBW=1MHz, VBW=1/T and Peak detector
5. Radiated emission Peak value for fundamental
RBW=2MHz, VBW=10MHz and Peak detector

3.1.4 Test Setup

Radiated Emissions below 1 GHz

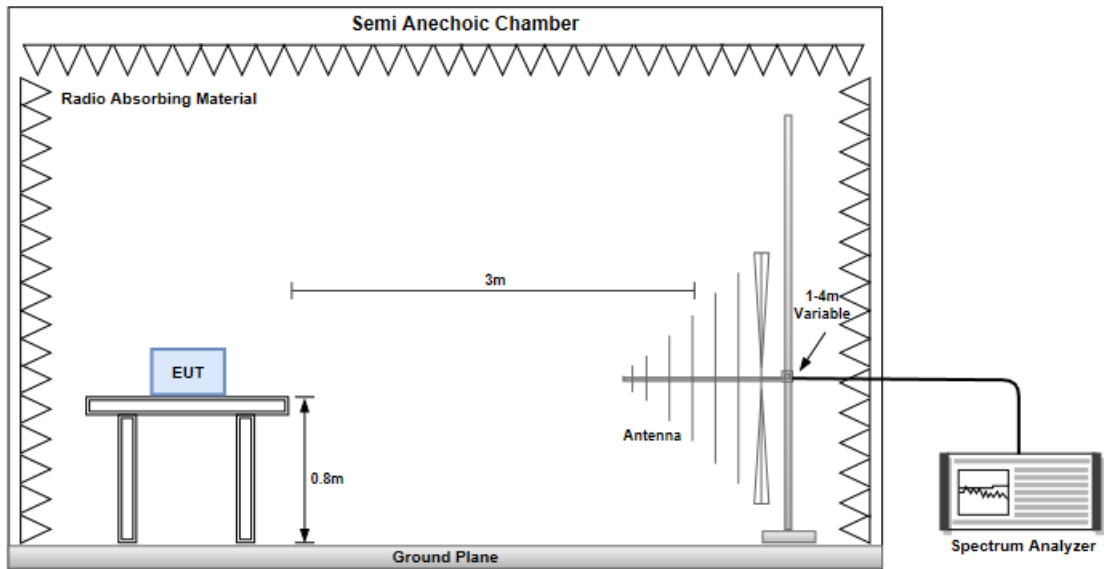

Radiated Emissions above 1 GHz

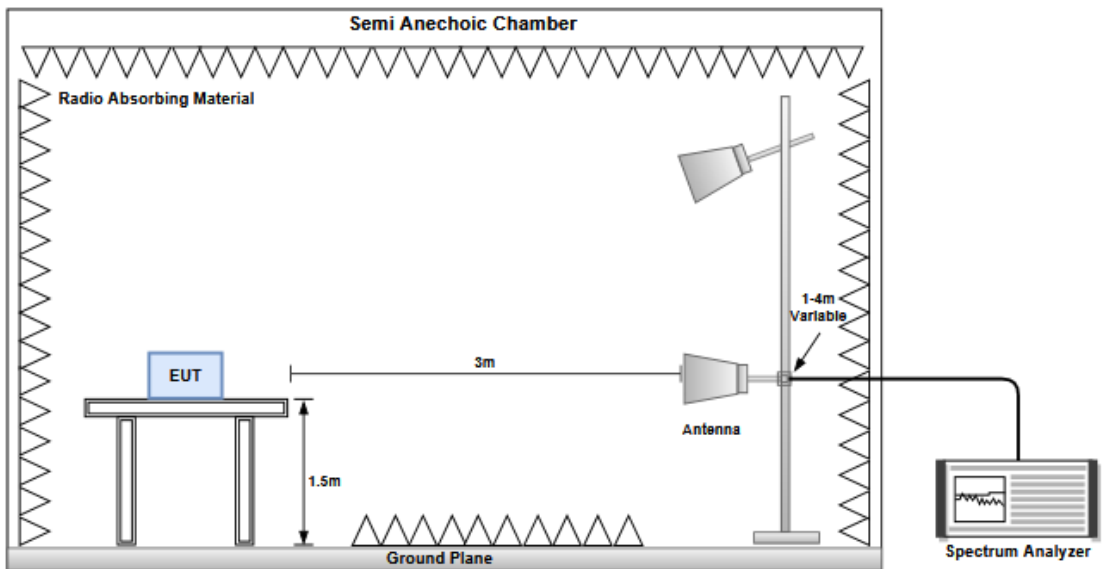

3.1.5 Test Results

Refer to Appendix A.

3.2 20dB and Occupied Bandwidth

3.2.1 Test Procedures

1. Set resolution bandwidth (RBW) = 20 kHz, Video bandwidth = 100 kHz.
2. Detector = Peak(20 dB bandwidth) / Sample(Occupied bandwidth), Trace mode = max hold
3. Sweep = auto couple, Allow the trace to stabilize.
4. Measure the maximum width of the emission that is constrained by the frequencies associated with the two outermost amplitude points (upper and lower) that are attenuated by 20dB relative to the maximum level measured in the fundamental emission.
5. Use the occupied measurement function of spectrum analyzer to measure 99% occupied bandwidth.

3.2.2 Test Setup

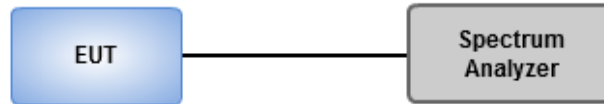

3.2.3 Test Results

Ambient Condition	23°C / 67%	Tested By	Akun Chung
--------------------------	------------	------------------	------------

Refer to Appendix B.

3.3 AC Power Line Conducted Emissions

3.3.1 Limit of AC Power Line Conducted Emissions

Conducted Emissions Limit		
Frequency Emission (MHz)	Quasi-Peak	Average
0.15-0.5	66 - 56 *	56 - 46 *
0.5-5	56	46
5-30	60	50

Note 1: * Decreases with the logarithm of the frequency.

3.3.2 Test Procedures

1. The device is placed on a test table, raised 80 cm above the reference ground plane. The vertical conducting plane is located 40 cm to the rear of the device.
2. The device is connected to line impedance stabilization network (LISN) and other accessories are connected to other LISN. Measured levels of AC power line conducted emission are across the 50 Ω LISN port.
3. AC conducted emission measurements is made over frequency range from 150 kHz to 30 MHz.
4. This measurement was performed with AC 120V / 60Hz.

3.3.3 Test Setup

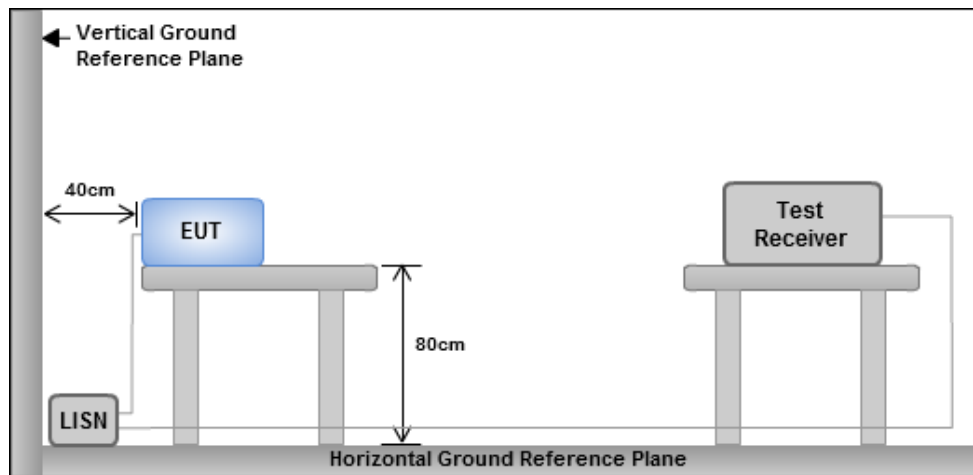

- Note: 1. Support units were connected to second LISN.
2. Both of LISNs (AMN) are 80 cm from EUT and at least 80 cm from other units and other metal planes

3.3.4 Test Results

Refer to Appendix C.

4 Test laboratory information

Established in 2012, ICC provides foremost EMC & RF Testing and advisory consultation services by our skilled engineers and technicians. Our services employ a wide variety of advanced edge test equipment and one of the widest certification extents in the business.

International Certification Corporation (EMC and Wireless Communication Laboratory), it is our definitive objective is to institute long term, trust-based associations with our clients. The expectation we set up with our clients is based on outstanding service, practical expertise and devotion to a certified value structure. Our passion is to grant our clients with best EMC / RF services by oriented knowledgeable and accommodating staff.

Our Test sites are located at Linkou District and Kwei Shan District. Location map can be found on our website <http://www.icertifi.com.tw>.

Linkou

Tel: 886-2-2601-1640

No.30-2, Ding Fwu Tsuen, Lin Kou
District, New Taipei City, Taiwan
(R.O.C.)

Kwei Shan

Tel: 886-3-271-8666

No.3-1, Lane 6, Wen San 3rd
St., Kwei Shan Dist., Tao Yuan
City 33381, Taiwan (R.O.C.)
No.2-1, Lane 6, Wen San 3rd
St., Kwei Shan Dist., Tao Yuan
City 33381, Taiwan (R.O.C.)

Kwei Shan Site II

Tel: 886-3-271-8640

No.14-1, Lane 19, Wen San 3rd
St., Kwei Shan Dist., Tao Yuan
City 333, Taiwan (R.O.C.)

If you have any suggestion, please feel free to contact us as below information.

Tel: 886-3-271-8666

Fax: 886-3-318-0345

Email: ICC_Service@icertifi.com.tw

==END==



Configuration 2: Battery mode

Unwanted Emissions (Below 1GHz)

Modulation	GFSK	Test Freq. (MHz)	2402
Polarization	Horizontal		

Test By :Roger Lu Temperature(°C):24 Humidity(%):65

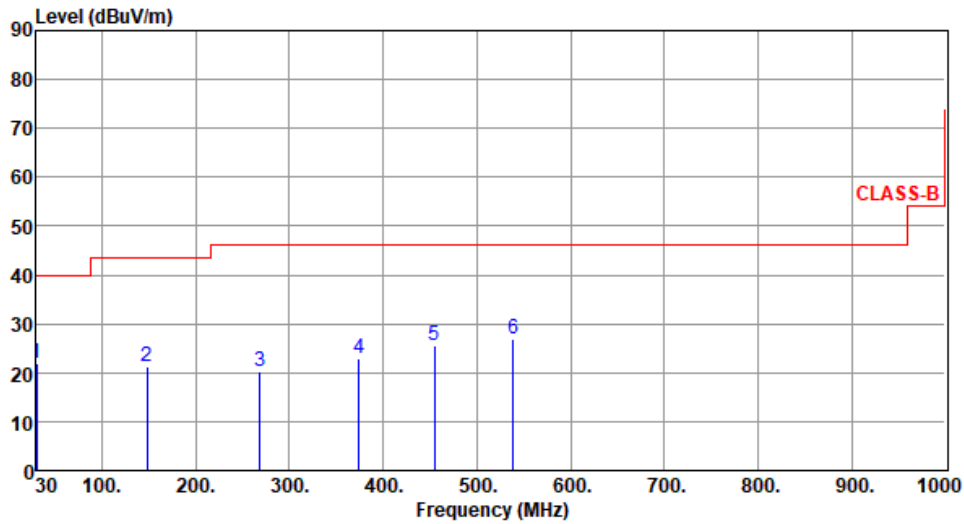

	Freq. MHz	Emission level dBuV/m	Limit dBuV/m	Margin dB	SA reading dBuV	Factor dB/m	Remark	ANT High cm	Turn Table deg
1	30.00	22.08	40.00	-17.92	32.02	-9.94	Peak	---	---
2	148.34	21.27	43.50	-22.23	30.25	-8.98	Peak	---	---
3	268.62	20.39	46.00	-25.61	29.58	-9.19	Peak	---	---
4	374.35	22.88	46.00	-23.12	29.22	-6.34	Peak	---	---
5	454.86	25.68	46.00	-20.32	29.81	-4.13	Peak	---	---
6	539.25	26.90	46.00	-19.10	29.61	-2.71	Peak	---	---

Note 1: Emission Level (dBuV/m) = SA Reading (dBuV) + Factor* (dB/m)

*Factor includes antenna factor , cable loss and amplifier gain

Note 2: Margin (dB) = Emission level (dBuV/m) – Limit (dBuV/m).

Note 3: All spurious emissions below 30MHz are more than 20 dB below the limit.



Modulation	GFSK	Test Freq. (MHz)	2402
Polarization	Vertical		

Test By : Roger Lu Temperature(°C): 24 Humidity(%): 65

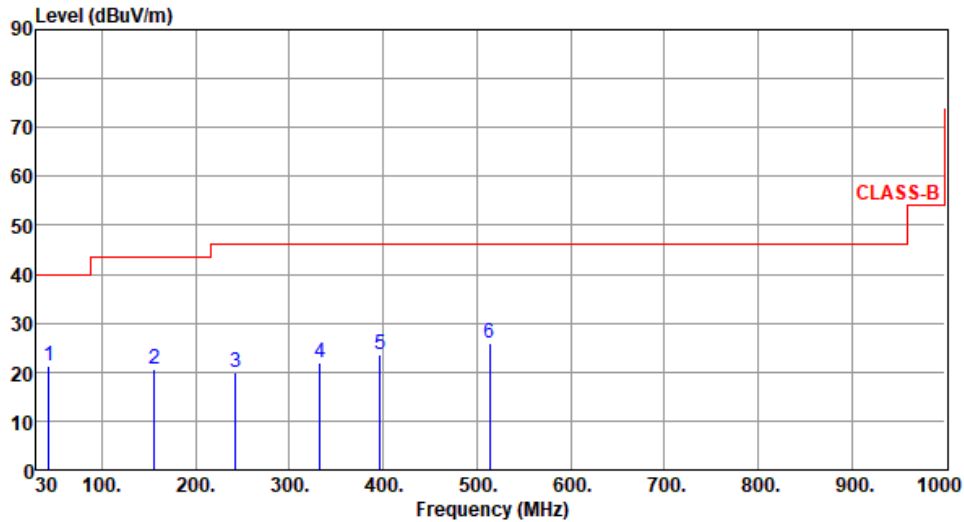

	Freq. MHz	Emission level dBuV/m	Limit dBuV/m	Margin dB	SA reading dBuV	Factor dB/m	Remark	ANT High cm	Turn Table deg
1	43.58	21.41	40.00	-18.59	29.96	-8.55	Peak	---	---
2	156.10	20.45	43.50	-23.05	29.15	-8.70	Peak	---	---
3	242.43	19.79	46.00	-26.21	30.07	-10.28	Peak	---	---
4	332.64	21.78	46.00	-24.22	29.16	-7.38	Peak	---	---
5	396.66	23.62	46.00	-22.38	29.48	-5.86	Peak	---	---
6	514.03	25.87	46.00	-20.13	28.84	-2.97	Peak	---	---

Note 1: Emission Level (dBuV/m) = SA Reading (dBuV) + Factor* (dB/m)

*Factor includes antenna factor , cable loss and amplifier gain

Note 2: Margin (dB) = Emission level (dBuV/m) – Limit (dBuV/m).

Note 3: All spurious emissions below 30MHz are more than 20 dB below the limit.



Unwanted Emissions (Above 1GHz)

Modulation	GFSK	Test Freq. (MHz)	2402						
Polarization	Horizontal								
Test By :Akun Chung Temperature(°C):23 Humidity(%):67									
	Freq. MHz	Emission level dBuV/m	Limit dBuV/m	Margin dB	SA reading dBuV	Factor dB/m	Remark	ANT High cm	Turn Table deg
1	2390.00	38.96	54.00	-15.04	41.71	-2.75	Average	244	166
2	2390.00	53.96	74.00	-20.04	56.71	-2.75	Peak	244	166
3	2400.00	41.74	54.00	-12.26	44.51	-2.77	Average	244	166
4	2400.00	63.34	74.00	-10.66	66.11	-2.77	Peak	244	166
5	2402.00	39.08	94.00	-54.92			Average	244	166
6	2402.00	93.03	114.00	-20.97	95.80	-2.77	Peak	244	166
7	4804.00	1.72	54.00	-52.28			Average	100	26
8	4804.00	55.67	74.00	-18.33	51.54	4.13	Peak	100	26
9	7206.00	1.80	54.00	-52.20			Average	100	30
10	7206.00	55.75	74.00	-18.25	46.69	9.06	Peak	100	30

Note 1: Emission Level (dBuV/m) = SA Reading (dBuV) + Factor* (dB/m)
 *Factor includes antenna factor , cable loss and amplifier gain
 Note 2: Margin (dB) = Emission level (dBuV/m) – Limit (dBuV/m).
 Note 3: When average value is calculated not measured, no SA reading and factor value are listed.



Modulation	GFSK	Test Freq. (MHz)	2402						
Polarization	Vertical								
Test By : Akun Chung Temperature(°C):23 Humidity(%):67									
	<table border="1"> <thead> <tr> <th>10</th> <th>8</th> <th>2</th> </tr> </thead> <tbody> <tr> <td>7206.00</td> <td>4804.00</td> <td>2390.00</td> </tr> </tbody> </table>	10	8	2	7206.00	4804.00	2390.00		
10	8	2							
7206.00	4804.00	2390.00							
	<table border="1"> <thead> <tr> <th>10</th> <th>8</th> <th>2</th> </tr> </thead> <tbody> <tr> <td>56.01</td> <td>55.05</td> <td>39.38</td> </tr> </tbody> </table>	10	8	2	56.01	55.05	39.38		
10	8	2							
56.01	55.05	39.38							
	<table border="1"> <thead> <tr> <th>10</th> <th>8</th> <th>2</th> </tr> </thead> <tbody> <tr> <td>74.00</td> <td>74.00</td> <td>54.00</td> </tr> </tbody> </table>	10	8	2	74.00	74.00	54.00		
10	8	2							
74.00	74.00	54.00							
	<table border="1"> <thead> <tr> <th>10</th> <th>8</th> <th>2</th> </tr> </thead> <tbody> <tr> <td>-17.99</td> <td>-18.95</td> <td>-14.62</td> </tr> </tbody> </table>	10	8	2	-17.99	-18.95	-14.62		
10	8	2							
-17.99	-18.95	-14.62							
	<table border="1"> <thead> <tr> <th>10</th> <th>8</th> <th>2</th> </tr> </thead> <tbody> <tr> <td>46.95</td> <td>50.92</td> <td>42.13</td> </tr> </tbody> </table>	10	8	2	46.95	50.92	42.13		
10	8	2							
46.95	50.92	42.13							
	<table border="1"> <thead> <tr> <th>10</th> <th>8</th> <th>2</th> </tr> </thead> <tbody> <tr> <td>9.06</td> <td>4.13</td> <td>-2.75</td> </tr> </tbody> </table>	10	8	2	9.06	4.13	-2.75		
10	8	2							
9.06	4.13	-2.75							
	<table border="1"> <thead> <tr> <th>10</th> <th>8</th> <th>2</th> </tr> </thead> <tbody> <tr> <td>Peak</td> <td>Peak</td> <td>Average</td> </tr> </tbody> </table>	10	8	2	Peak	Peak	Average		
10	8	2							
Peak	Peak	Average							
	<table border="1"> <thead> <tr> <th>10</th> <th>8</th> <th>2</th> </tr> </thead> <tbody> <tr> <td>135</td> <td>100</td> <td>121</td> </tr> </tbody> </table>	10	8	2	135	100	121		
10	8	2							
135	100	121							
	<table border="1"> <thead> <tr> <th>10</th> <th>8</th> <th>2</th> </tr> </thead> <tbody> <tr> <td>182</td> <td>63</td> <td>190</td> </tr> </tbody> </table>	10	8	2	182	63	190		
10	8	2							
182	63	190							

Note 1: Emission Level (dBuV/m) = SA Reading (dBuV) + Factor* (dB/m)
 *Factor includes antenna factor , cable loss and amplifier gain
 Note 2: Margin (dB) = Emission level (dBuV/m) – Limit (dBuV/m).
 Note 3: When average value is calculated not measured, no SA reading and factor value are listed.



Modulation	GFSK	Test Freq. (MHz)	2442
Polarization	Horizontal		

Test By : Akun Chung Temperature(°C): 23 Humidity(%): 67

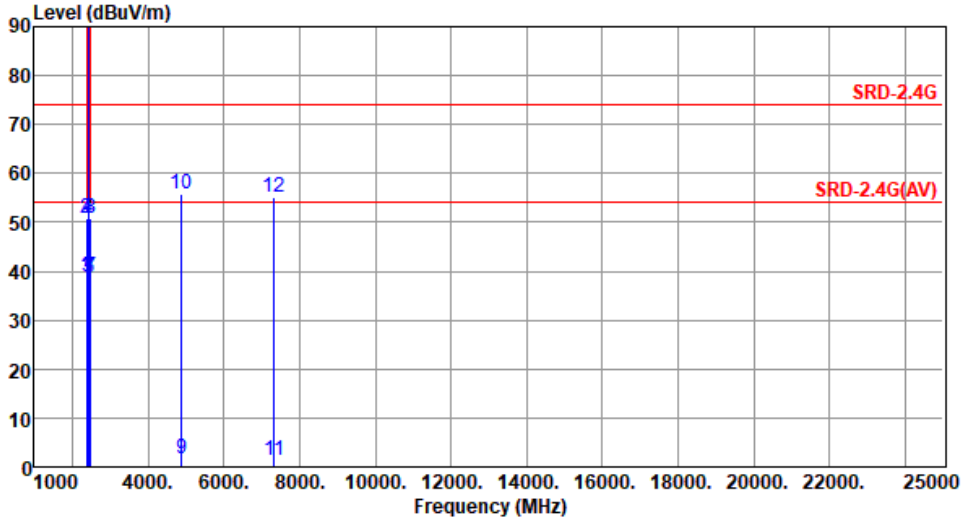

	Freq. MHz	Emission level dBuV/m	Limit dBuV/m	Margin dB	SA reading dBuV	Factor dB/m	Remark	ANT High cm	Turn Table deg
1	2390.00	38.74	54.00	-15.26	41.49	-2.75	Average	238	162
2	2390.00	50.78	74.00	-23.22	53.53	-2.75	Peak	238	162
3	2400.00	38.82	54.00	-15.18	41.59	-2.77	Average	238	162
4	2400.00	50.82	74.00	-23.18	53.59	-2.77	Peak	238	162
5	2442.00	38.69	94.00	-55.31			Average	238	162
6	2442.00	92.64	114.00	-21.36	95.43	-2.79	Peak	238	162
7	2483.50	38.77	54.00	-15.23	41.47	-2.70	Average	238	162
8	2483.50	50.79	74.00	-23.21	53.49	-2.70	Peak	238	162
9	4884.00	1.73	54.00	-52.27			Average	100	29
10	4884.00	55.68	74.00	-18.32	51.57	4.11	Peak	100	29
11	7326.00	1.34	54.00	-52.66			Average	100	30
12	7326.00	55.29	74.00	-18.71	46.01	9.28	Peak	100	30

Note 1: Emission Level (dBuV/m) = SA Reading (dBuV) + Factor* (dB/m)
 *Factor includes antenna factor , cable loss and amplifier gain
 Note 2: Margin (dB) = Emission level (dBuV/m) – Limit (dBuV/m).
 Note 3: When average value is calculated not measured, no SA reading and factor value are listed.



Modulation	GFSK	Test Freq. (MHz)	2442
Polarization	Vertical		

Test By : Akun Chung Temperature(°C): 23 Humidity(%): 67

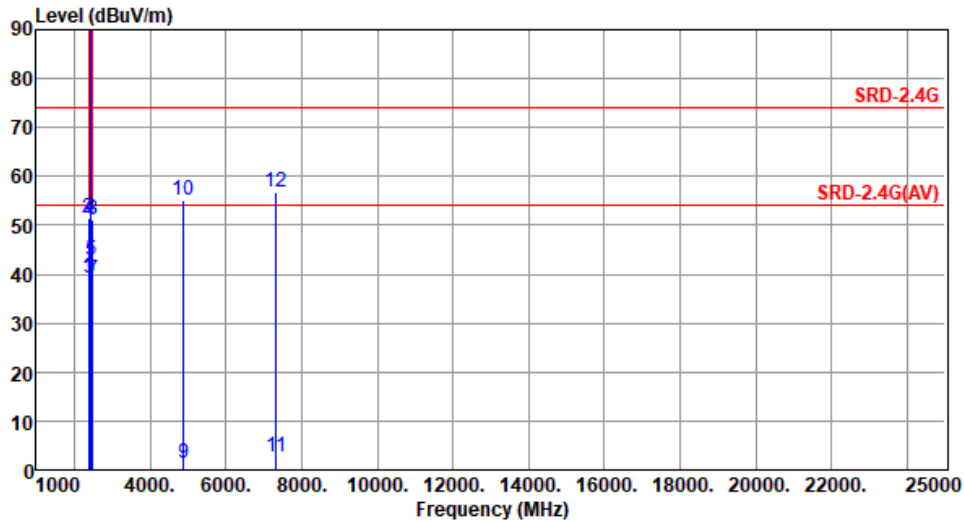

	Freq. MHz	Emission level dBuV/m	Limit dBuV/m	Margin dB	SA reading dBuV	Factor dB/m	Remark	ANT High cm	Turn Table deg
1	2390.00	39.16	54.00	-14.84	41.91	-2.75	Average	118	191
2	2390.00	51.45	74.00	-22.55	54.20	-2.75	Peak	118	191
3	2400.00	39.16	54.00	-14.84	41.93	-2.77	Average	118	191
4	2400.00	51.48	74.00	-22.52	54.25	-2.77	Peak	118	191
5	2442.00	42.90	94.00	-51.10	-----	-----	Average	118	191
6	2442.00	96.85	114.00	-17.15	99.64	-2.79	Peak	118	191
7	2483.50	39.00	54.00	-15.00	41.70	-2.70	Average	118	191
8	2483.50	51.29	74.00	-22.71	53.99	-2.70	Peak	118	191
9	4884.00	1.25	54.00	-52.75	-----	-----	Average	100	187
10	4884.00	55.20	74.00	-18.80	51.09	4.11	Peak	100	187
11	7326.00	2.71	54.00	-51.29	-----	-----	Average	125	182
12	7326.00	56.66	74.00	-17.34	47.38	9.28	Peak	125	182

Note 1: Emission Level (dBuV/m) = SA Reading (dBuV) + Factor* (dB/m)

*Factor includes antenna factor , cable loss and amplifier gain

Note 2: Margin (dB) = Emission level (dBuV/m) – Limit (dBuV/m).

Note 3: When average value is calculated not measured, no SA reading and factor value are listed.



Modulation	GFSK	Test Freq. (MHz)	2480
Polarization	Horizontal		

Test By : Akun Chung Temperature(°C): 23 Humidity(%): 67

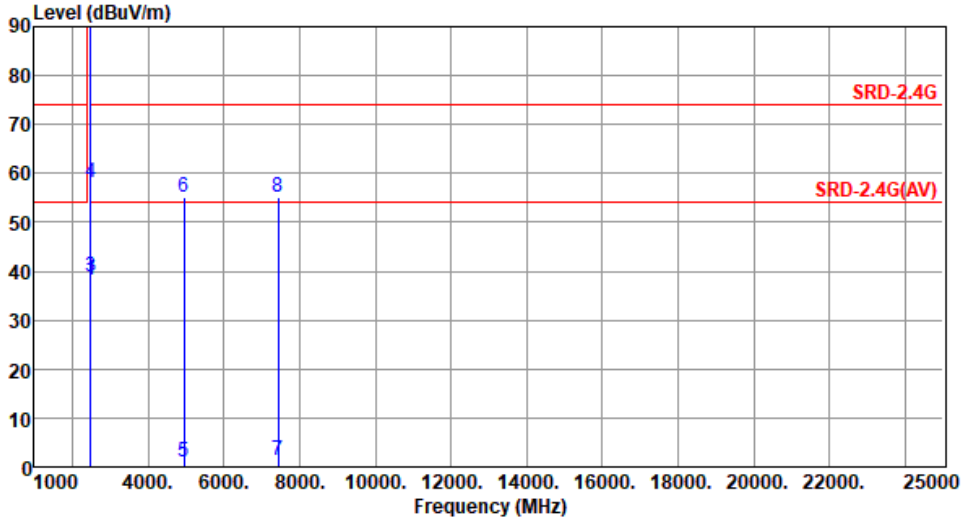

	Freq. MHz	Emission level dBuV/m	Limit dBuV/m	Margin dB	SA reading dBuV	Factor dB/m	Remark	ANT High cm	Turn Table deg
1	2480.00	38.09	94.00	-55.91			Average	249	159
2	2480.00	92.04	114.00	-21.96	94.75	-2.71	Peak	249	159
3	2483.50	38.90	54.00	-15.10	41.60	-2.70	Average	249	159
4	2483.50	58.28	74.00	-15.72	60.98	-2.70	Peak	249	159
5	4960.00	1.15	54.00	-52.85	----	----	Average	100	26
6	4960.00	55.10	74.00	-18.90	51.07	4.03	Peak	100	26
7	7440.00	1.18	54.00	-52.82			Average	100	23
8	7440.00	55.13	74.00	-18.87	45.76	9.37	Peak	100	23

Note 1: Emission Level (dBuV/m) = SA Reading (dBuV) + Factor* (dB/m)

*Factor includes antenna factor , cable loss and amplifier gain

Note 2: Margin (dB) = Emission level (dBuV/m) – Limit (dBuV/m).

Note 3: When average value is calculated not measured, no SA reading and factor value are listed.



Modulation	GFSK	Test Freq. (MHz)	2480
Polarization	Vertical		

Test By : Akun Chung Temperature(°C): 23 Humidity(%): 67

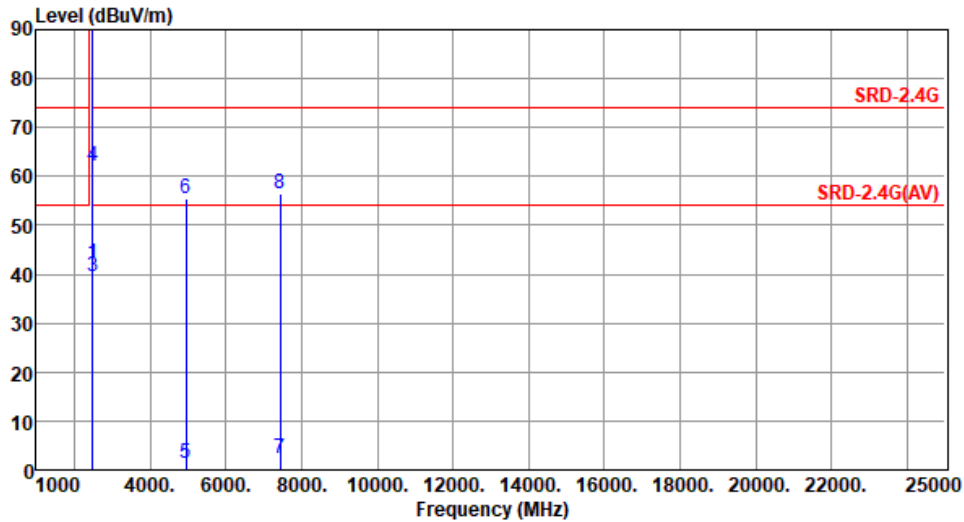

	Freq. MHz	Emission level dBuV/m	Limit dBuV/m	Margin dB	SA reading dBuV	Factor dB/m	Remark	ANT High cm	Turn Table deg
1	2480.00	42.21	94.00	-51.79			Average	126	191
2	2480.00	96.16	114.00	-17.84	98.87	-2.71	Peak	126	191
3	2483.50	39.67	54.00	-14.33	42.37	-2.70	Average	126	191
4	2483.50	62.02	74.00	-11.98	64.72	-2.70	Peak	126	191
5	4960.00	1.39	54.00	-52.61			Average	100	154
6	4960.00	55.34	74.00	-18.66	51.31	4.03	Peak	100	154
7	7440.00	2.45	54.00	-51.55			Average	125	184
8	7440.00	56.40	74.00	-17.60	47.03	9.37	Peak	125	184

Note 1: Emission Level (dBuV/m) = SA Reading (dBuV) + Factor* (dB/m)

*Factor includes antenna factor , cable loss and amplifier gain

Note 2: Margin (dB) = Emission level (dBuV/m) – Limit (dBuV/m).

Note 3: When average value is calculated not measured, no SA reading and factor value are listed.



Configuration 1: Charging mode

Unwanted Emissions (Below 1GHz)

Modulation	Charging	Test Freq. (MHz)	---
Polarization	Horizontal		

Test By :Roger Lu Temperature(°C):24 Humidity(%):65

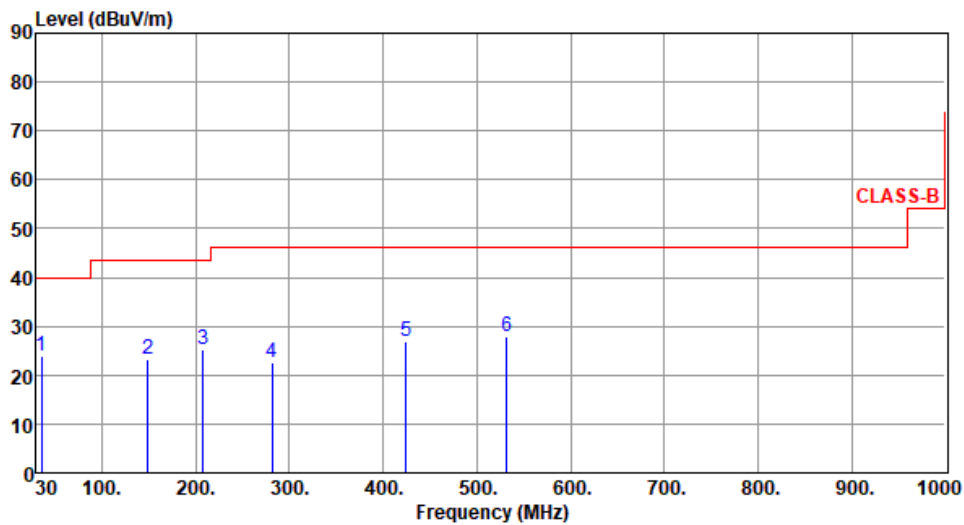

	Freq. MHz	Emission level dBuV/m	Limit dBuV/m	Margin dB	SA reading dBuV	Factor dB/m	Remark	ANT High cm	Turn Table deg
1	35.82	23.84	40.00	-16.16	33.27	-9.43	Peak	---	---
2	149.31	23.19	43.50	-20.31	32.24	-9.05	Peak	---	---
3	207.51	25.19	43.50	-18.31	37.15	-11.96	Peak	---	---
4	281.23	22.74	46.00	-23.26	31.39	-8.65	Peak	---	---
5	424.79	26.86	46.00	-19.14	31.88	-5.02	Peak	---	---
6	531.49	27.89	46.00	-18.11	30.73	-2.84	Peak	---	---

Note 1: Emission Level (dBuV/m) = SA Reading (dBuV) + Factor* (dB/m)

*Factor includes antenna factor , cable loss and amplifier gain

Note 2: Margin (dB) = Emission level (dBuV/m) – Limit (dBuV/m).

Note 3: All spurious emissions below 30MHz are more than 20 dB below the limit.



Modulation	Charging	Test Freq. (MHz)	---
Polarization	Vertical		

Test By :Roger Lu Temperature(°C):24 Humidity(%):65

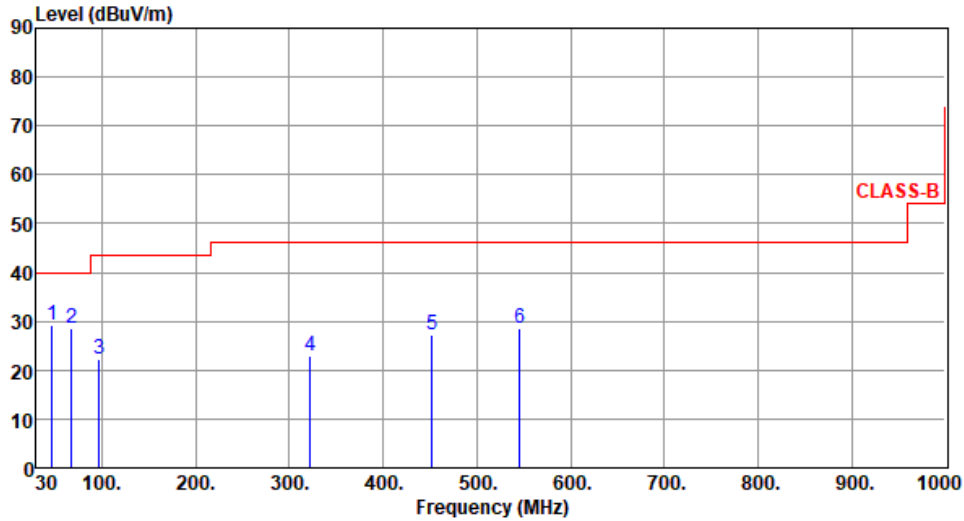

	Freq. MHz	Emission level dBuV/m	Limit dBuV/m	Margin dB	SA reading dBuV	Factor dB/m	Remark	ANT High cm	Turn Table deg
1	46.49	29.37	40.00	-10.63	37.86	-8.49	Peak	---	---
2	67.83	28.72	40.00	-11.28	38.88	-10.16	Peak	---	---
3	96.93	22.30	43.50	-21.20	36.10	-13.80	Peak	---	---
4	321.97	22.89	46.00	-23.11	30.35	-7.46	Peak	---	---
5	451.95	27.07	46.00	-18.93	31.26	-4.19	Peak	---	---
6	546.04	28.71	46.00	-17.29	31.34	-2.63	Peak	---	---

Note 1: Emission Level (dBuV/m) = SA Reading (dBuV) + Factor* (dB/m)

*Factor includes antenna factor , cable loss and amplifier gain

Note 2: Margin (dB) = Emission level (dBuV/m) – Limit (dBuV/m).

Note 3: All spurious emissions below 30MHz are more than 20 dB below the limit.

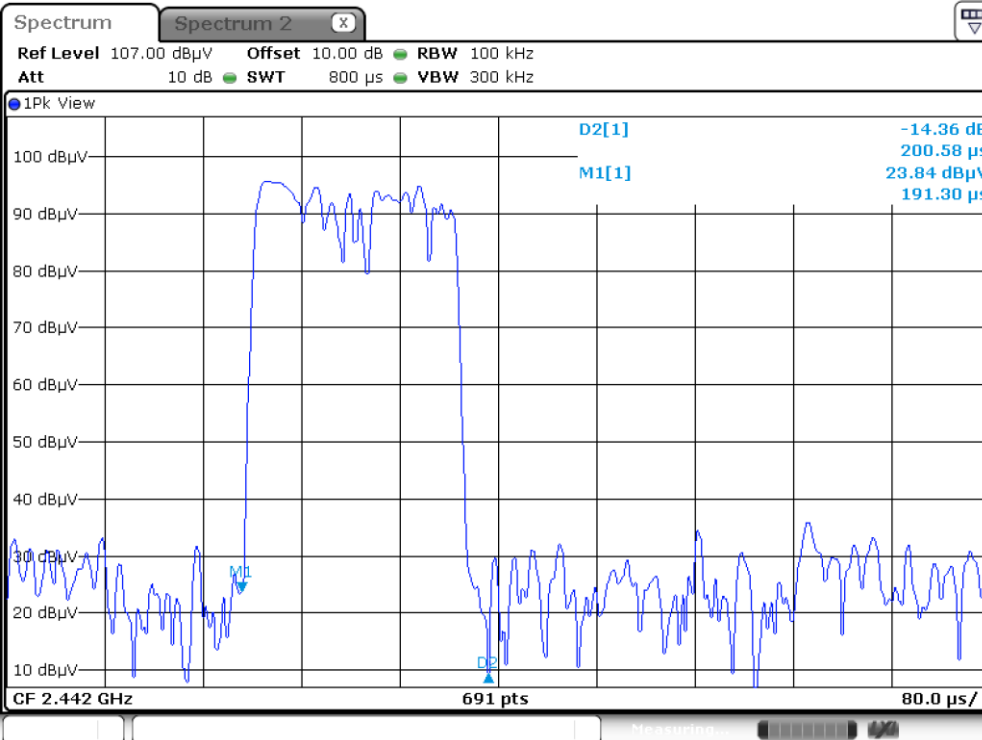
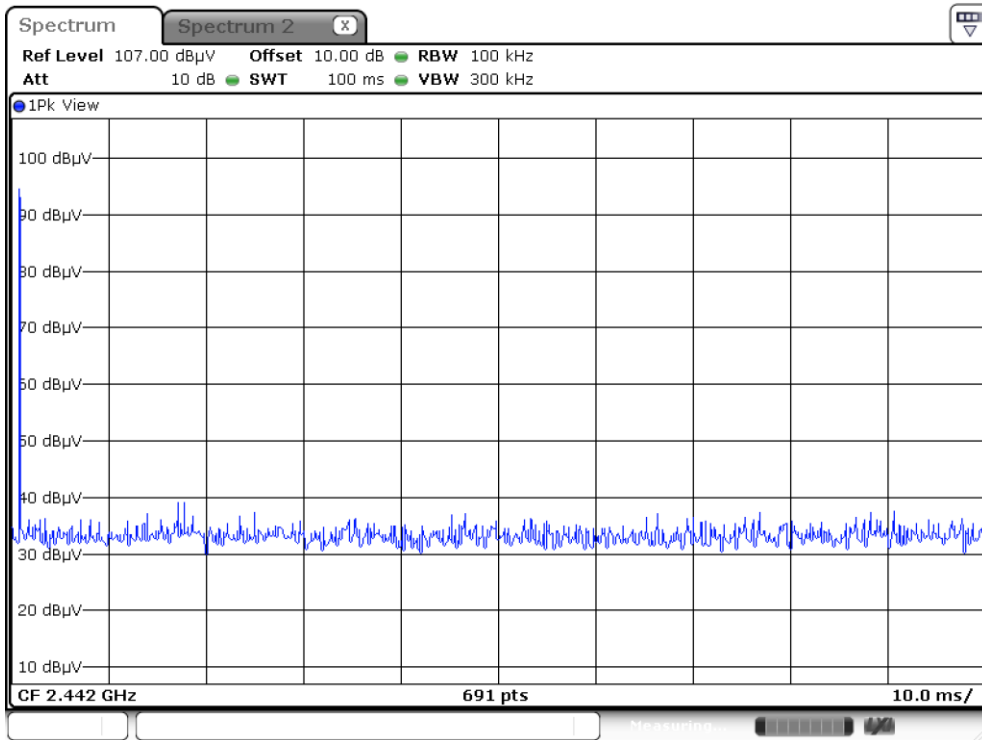

$$20\log(\text{Duty cycle}) = 20\log \frac{0.20058 \times 1 \text{ ms}}{100 \text{ ms}} = -53.95\text{dB}$$



Frequency (MHz)	20dB Bandwidth (MHz)	99% Occupied BW
2402.0	1.143	1.042
2442.0	1.143	1.042
2480.0	1.143	1.042

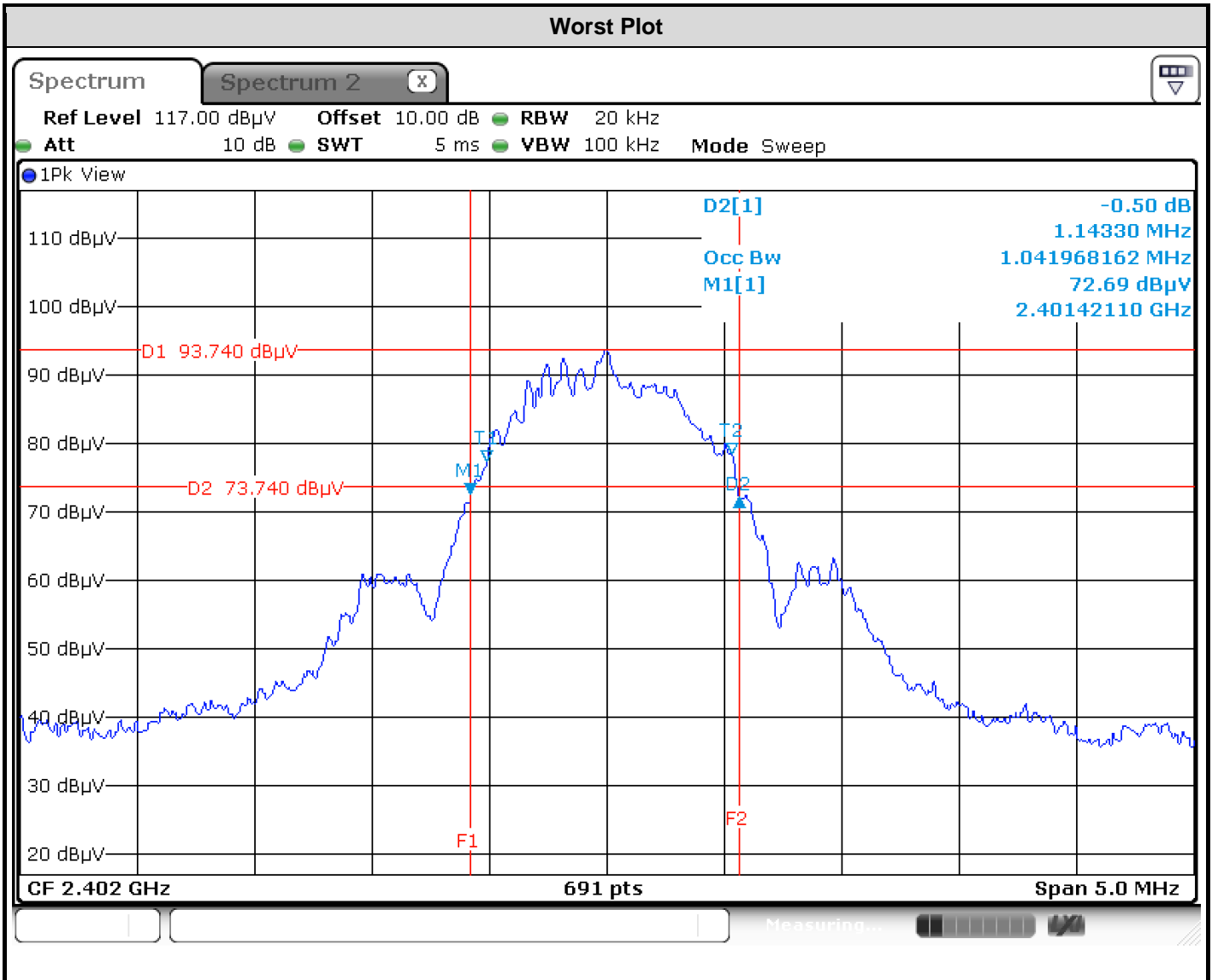



Modulation	Charging
Power Phase	Line

Test by : Joe Liao Temperature: 22°C Humidity: 61%

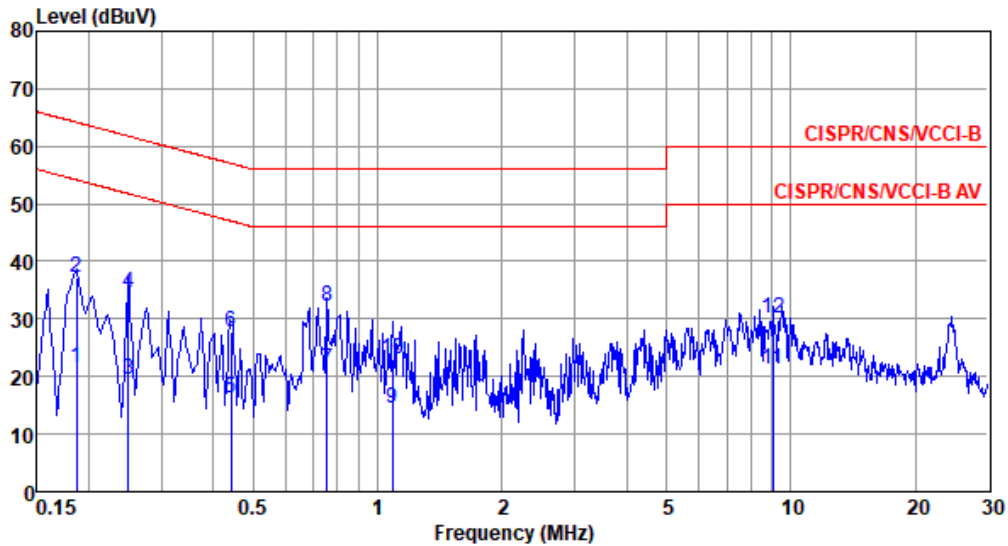

	Freq MHz	Level dBuV	Limit Line dBuV	Over Limit dB	Read Level dBuV	Factor dB	Cable loss dB	Aux dB	Remark
1	0.186	21.67	54.20	-32.53	11.70	9.68	0.08	0.21	Average
2	0.186	37.13	64.20	-27.07	27.16	9.68	0.08	0.21	QP
3	0.249	19.60	51.78	-32.18	9.58	9.68	0.08	0.26	Average
4	0.249	34.62	61.78	-27.16	24.60	9.68	0.08	0.26	QP
5	0.442	16.10	47.02	-30.92	5.98	9.67	0.09	0.36	Average
6	0.442	27.74	57.02	-29.28	17.62	9.67	0.09	0.36	QP
7	0.755	21.35	46.00	-24.65	11.16	9.68	0.14	0.37	Average
8*	0.755	32.20	56.00	-23.80	22.01	9.68	0.14	0.37	QP
9	1.088	14.56	46.00	-31.44	4.35	9.68	0.16	0.37	Average
10	1.088	23.10	56.00	-32.90	12.89	9.68	0.16	0.37	QP
11	9.059	21.32	50.00	-28.68	10.72	9.74	0.42	0.44	Average
12	9.059	30.03	60.00	-29.97	19.43	9.74	0.42	0.44	QP

Note 1: Level (dBuV) = Read Level (dBuV) + LISN Factor (dB) + Cable Loss (dB) + Aux (dB).
 Note 2: Over Limit (dB) = Level (dBuV) – Limit Line (dBuV).



Modulation	Charging
Power Phase	Neutral

Test by : Joe Liao Temperature: 22°C Humidity: 61%

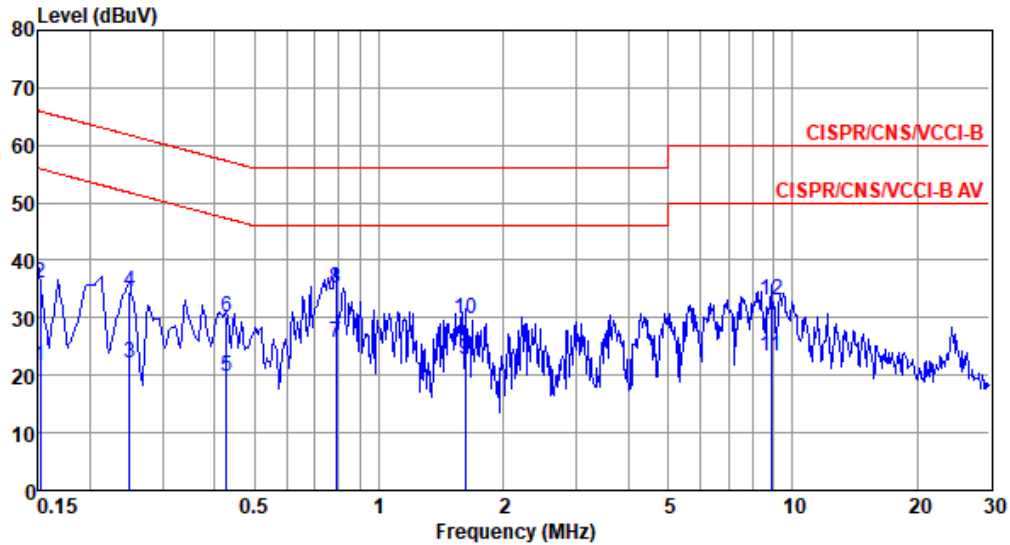

	Freq MHz	Level dBuV	Limit Line dBuV	Over Limit dB	Read Level dBuV	Factor dB	Cable loss dB	Aux dB	Remark
1	0.152	21.51	55.91	-34.40	11.66	9.61	0.08	0.16	Average
2	0.152	36.02	65.91	-29.89	26.17	9.61	0.08	0.16	QP
3	0.249	22.19	51.78	-29.59	12.32	9.61	0.08	0.18	Average
4	0.249	34.44	61.78	-27.34	24.57	9.61	0.08	0.18	QP
5	0.428	19.77	47.29	-27.52	9.87	9.61	0.09	0.20	Average
6	0.428	30.12	57.29	-27.17	20.22	9.61	0.09	0.20	QP
7*	0.788	25.56	46.00	-20.44	15.55	9.61	0.14	0.26	Average
8	0.788	35.19	56.00	-20.81	25.18	9.61	0.14	0.26	QP
9	1.619	22.74	46.00	-23.26	12.64	9.62	0.19	0.29	Average
10	1.619	29.75	56.00	-26.25	19.65	9.62	0.19	0.29	QP
11	8.869	23.46	50.00	-26.54	13.00	9.68	0.42	0.36	Average
12	8.869	32.95	60.00	-27.05	22.49	9.68	0.42	0.36	QP

Note 1: Level (dBuV) = Read Level (dBuV) + LISN Factor (dB) + Cable Loss (dB) + Aux (dB).
 Note 2: Over Limit (dB) = Level (dBuV) - Limit Line (dBuV).