

# FCC Test Report

**FCC ID** : IPH-A4263  
**Equipment** : Outdoor GPS Watch  
**Model No.** : AA4263  
**Brand Name** : GARMIN  
**Applicant** : Garmin International, Inc.  
**Address** : 1200 E. 151st Street Olathe, KS 66062 United States  
**Standard** : 47 CFR FCC Part 15.225  
**Received Date** : Apr. 13, 2023  
**Tested Date** : May 24 ~ Jul. 07, 2023

We, International Certification Corporation, would like to declare that the tested sample has been evaluated and in compliance with the requirement of the above standards. The test results contained in this report refer exclusively to the product. It shall not be reproduced except in full without the written approval of our laboratory.

Reviewed by:

Approved by:

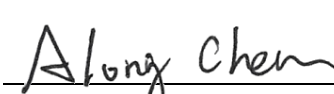
  
\_\_\_\_\_  
Along Chen / Assistant Manager

  
\_\_\_\_\_  
Gary Chang / Manager

---

## Table of Contents

<b>1</b>	<b>GENERAL DESCRIPTION .....</b>	<b>5</b>
1.1	Information.....	5
1.2	Local Support Equipment List .....	6
1.3	Test Setup Chart .....	6
1.4	The Equipment List .....	7
1.5	Test Standards .....	8
1.6	Deviation from Test Standard and Measurement Procedure.....	8
1.7	Measurement Uncertainty .....	8
<b>2</b>	<b>TEST CONFIGURATION.....</b>	<b>9</b>
2.1	Testing Facility .....	9
2.2	The Worst Test Modes and Channel Details .....	9
<b>3</b>	<b>TRANSMITTER TEST RESULTS .....</b>	<b>10</b>
3.1	20dB and Occupied Bandwidth.....	10
3.2	Field Strength of Fundamental Emissions .....	11
3.3	Unwanted Emissions into Restricted Frequency Bands .....	12
3.4	Frequency Stability.....	14
3.5	AC Power Line Conducted Emissions .....	15
<b>4</b>	<b>TEST LABORATORY INFORMATION .....</b>	<b>16</b>

**Appendix A. 20dB and Occupied Bandwidth**

**Appendix B. Field Strength of Fundamental Emissions**

**Appendix C. Unwanted Emissions into Restricted Frequency Bands**

**Appendix D. Field Strength of Fundamental Emissions**

**Appendix E. AC Power Line Conducted Emissions**

---

## Release Record

Report No.	Version	Description	Issued Date
FR341301NF	Rev. 01	Initial issue	Aug. 07, 2023

## Summary of Test Results

FCC Rules	Test Items	Measured	Result
15.207	AC Power Line Conducted Emissions	[dBuV]: 0.491MHz 40.87 (Margin -15.27dB) - QP	Pass
15.225(a)~(c)	Field strength of fundamental emissions and spectrum mask	Meet the requirement of limit	Pass
15.225(d)	Field strength of any emissions appearing outside of the 13.110-14.010 MHz band	Meet the requirement of limit	Pass
15.225(e)	Frequency tolerance	Meet the requirement of limit	Pass
15.215 (c)	20dB bandwidth	Meet the requirement of limit	Pass
15.203	Antenna Requirement	Meet the requirement of limit	Pass

### Declaration of Conformity:

The test results with all measurement uncertainty excluded are presented in accordance with the regulation limits or requirements declared by manufacturers.

### Comments and Explanations:

The declared of product specification for EUT presented in the report are provided by the manufacturer, and the manufacturer takes all the responsibilities for the accuracy of product specification.

# 1 General Description

## 1.1 Information

### 1.1.1 Specification of the Equipment under Test (EUT)

RF General Information				
Frequency Range (MHz)	Modulation	Ch. Frequency (MHz)	Channel Number	NFC Type Category
13.553 – 13.567	ASK	13.56	1	NFC-A / NFC-B

### 1.1.2 Antenna Details

Ant. No.	Brand	Model	Type	Connector	Gain (dBi)
1	INPAQ TECH CO LTD	NF-C-F9-R0-157	Loop	-	-

### 1.1.3 EUT Operational Condition

<b>Power Type</b>	5Vdc from host 3.87Vdc from battery		
<b>Operational Voltage</b>	<input checked="" type="checkbox"/> Vnom (3.87 V)	<input checked="" type="checkbox"/> Vmax (4.45 V)	<input checked="" type="checkbox"/> Vmin (3.4 V)
<b>Operational Climatic</b>	<input checked="" type="checkbox"/> Tnom (20°C)	<input checked="" type="checkbox"/> Tmax (60°C)	<input checked="" type="checkbox"/> Tmin (-20°C)

### 1.1.4 Accessories

No.	Equipment	Description
1	Battery	Brand: Garmin Model: 361-00146-01 Rating: 3.87Vdc, 342mAh
2	USB cable	Brand: GARMIN Model: 320-01048-C1 1.02m shielded without core

### 1.1.5 Test Tool and Power Index

<b>Test Tool</b>	NFC Test, V13.14
<b>Power Index</b>	Default

## 1.2 Local Support Equipment List

Support Equipment List					
No.	Equipment	Brand	Model	FCC ID	Remarks
1	Adapter	Samsung	EP-TA800	---	---

## 1.3 Test Setup Chart

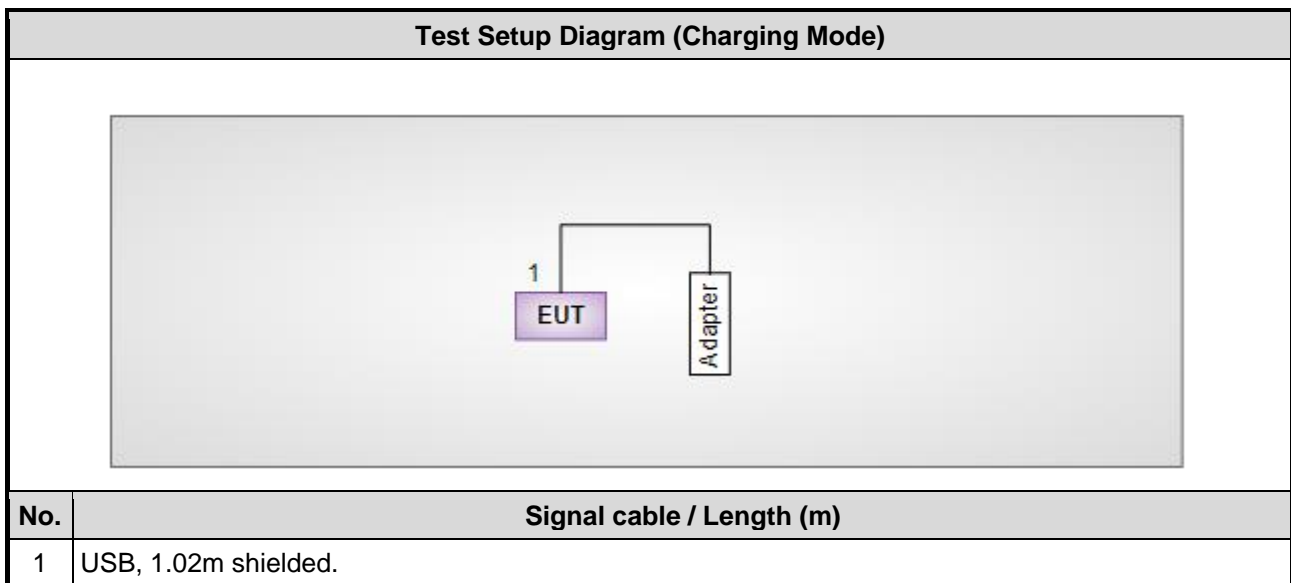
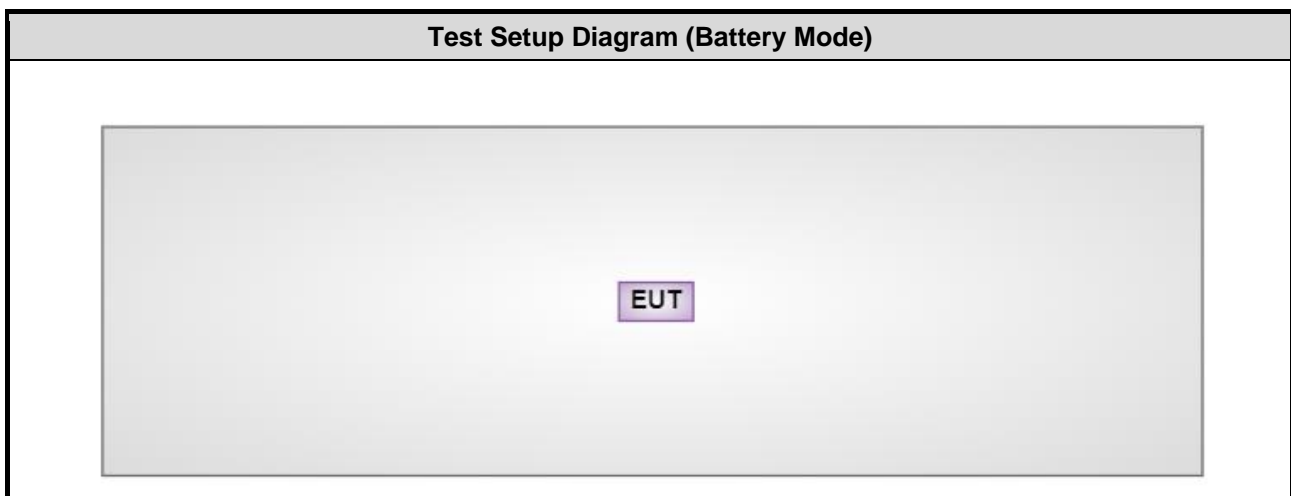

## 1.4 The Equipment List

<b>Test Item</b>	Conducted Emission				
<b>Test Site</b>	Conduction room 1 / (CO01-WS)				
<b>Tested Date</b>	May 24, 2023				
<b>Instrument</b>	<b>Brand</b>	<b>Model No.</b>	<b>Serial No.</b>	<b>Calibration Date</b>	<b>Calibration Until</b>
Receiver	R&S	ESR3	101658	Feb. 17, 2023	Feb. 16, 2024
LISN	R&S	ENV216	101579	May 09, 2023	May 08, 2024
LISN (Support Unit)	SCHWARZBECK	Schwarzbeck 8127	8127667	Jan .03, 2023	Jan .02, 2024
RF Cable-CON	Woken	CFD200-NL	CFD200-NL-001	Oct. 17, 2022	Oct. 16, 2023
50 ohm terminal (Support Unit)	NA	50	03	Jun. 08, 2022	Jun. 07, 2023
Measurement Software	AUDIX	e3	6.120210k	NA	NA
Note: Calibration Interval of instruments listed above is one year.					

<b>Test Item</b>	Radiated Emission				
<b>Test Site</b>	966 chamber1 / (03CH01-WS)				
<b>Tested Date</b>	Jul. 06, 2023				
<b>Instrument</b>	<b>Brand</b>	<b>Model No.</b>	<b>Serial No.</b>	<b>Calibration Date</b>	<b>Calibration Until</b>
Receiver	R&S	ESR3	101657	Mar. 03, 2023	Mar. 02, 2024
Loop Antenna	R&S	HFH2-Z2	100330	Nov. 01, 2022	Oct. 31, 2023
Bilog Antenna	SCHWARZBECK	VULB9168	VULB9168-522	Aug. 03, 2022	Aug. 02, 2023
Preamplifier	EMC	EMC02325	980225	Jun. 28, 2023	Jun. 27, 2024
Loop Antenna Cable	KOAX KABEL	101354-BW	101354-BW	Oct. 04, 2022	Oct. 03, 2023
LF cable 3M	Woken	CFD400NL-LW	CFD400NL-001	Oct. 04, 2022	Oct. 03, 2023
LF cable 11M	EMC	EMCCFD400-NW-N W-11000	200801	Oct. 04, 2022	Oct. 03, 2023
LF cable 1M	EMC	EMCCFD400-NM-N M-1000	160502	Oct. 04, 2022	Oct. 03, 2023
Measurement Software	Sporton	SENSE-EMI	V5.10.8	NA	NA
Note: Calibration Interval of instruments listed above is one year.					

<b>Test Item</b>	RF Conducted				
<b>Test Site</b>	(TH01-WS)				
<b>Tested Date</b>	Jul. 07, 2023				
<b>Instrument</b>	<b>Brand</b>	<b>Model No.</b>	<b>Serial No.</b>	<b>Calibration Date</b>	<b>Calibration Until</b>
Spectrum Analyzer	R&S	FSV40	101910	Apr. 14, 2023	Apr. 13, 2024
Power Meter	Anritsu	ML2495A	1241002	Nov. 23, 2022	Nov. 22, 2023
Power Sensor	Anritsu	MA2411B	1207366	Nov. 23, 2022	Nov. 22, 2023
TEMP&HUMIDITY CHAMBER	GIANT FORCE	GCT-225-40-SP-SD	MAF1212-002	Sep. 19, 2022	Sep. 18, 2023
DC POWER SOURCE	GW INSTEK	GPC-6030D	GES855395	Oct. 31, 2022	Oct. 30, 2023
Note: Calibration Interval of instruments listed above is one year.					

## 1.5 Test Standards

47 CFR FCC Part 15.225

ANSI C63.10-2013

## 1.6 Deviation from Test Standard and Measurement Procedure

None

## 1.7 Measurement Uncertainty

The measurement uncertainties given below are based on a 95% confidence level (based on a coverage factor (k=2)).

Measurement Uncertainty	
Parameters	Uncertainty
Bandwidth	$\pm 34.130$ Hz
Radiated emission $\leq 30$ MHz	$\pm 2.3$ dB
Radiated emission $\leq 1$ GHz	$\pm 3.41$ dB
Temperature	$\pm 0.4$ °C
AC conducted emission	$\pm 2.92$ dB



## 2 Test Configuration

### 2.1 Testing Facility

<b>Test Laboratory</b>	International Certification Corporation
<b>Test Site</b>	CO01-WS, 03CH01-WS, TH01-WS
<b>Address of Test Site</b>	No.3-1, Lane 6, Wen San 3rd St., Kwei Shan Dist., Tao Yuan City 33381, Taiwan (R.O.C.)

- FCC Designation No.: TW2732
- FCC site registration No.: 181692
- ISED#: 10807A
- CAB identifier: TW2732

### 2.2 The Worst Test Modes and Channel Details

Test item	Modulation Mode	Test Frequency (MHz)	Test Configuration
AC Power Line Conducted Emissions	Charging mode	---	2
Field strength of fundamental emissions	NFC	13.56	1
Unwanted Emissions into Restricted Frequency Bands < 30MHz	NFC	13.56	1
Unwanted Emissions into Restricted Frequency Bands 30MHz-1GHz	NFC	13.56	1
	Charging mode	---	2
Frequency tolerance	NFC	13.56	1
20dB bandwidth	NFC	13.56	1

**NOTE:**

1. The EUT was pretested with 3 orientations placed on the table for the radiated emission measurement – X, Y, and Z-plane. The **Z-plane** result was found as the worst case and was shown in this report.
2. The test configurations are listed as follows:
  - 1) Mode 1: Battery mode
  - 2) Mode 2: Charging mode
3. The device supports NFC-A and NFC-B type. NFC-A was found as the worst case and was shown in this report.

### 3 Transmitter Test Results

#### 3.1 20dB and Occupied Bandwidth

##### 3.1.1 Limit of 20dB Bandwidth

The upper and lower frequency of the 20dB bandwidth shall within 13.553~13.567 MHz

##### 3.1.2 Test Procedures

1. Set resolution bandwidth (RBW) = 1 kHz, Video bandwidth = 3 kHz.
2. Detector = Peak, Trace mode = max hold.
3. Sweep = auto couple, Allow the trace to stabilize.
4. Measure the maximum width of the emission that is constrained by the frequencies associated with the two outermost amplitude points (upper and lower) that are attenuated by 20dB relative to the maximum level measured in the fundamental emission.

##### 3.1.3 Test Setup

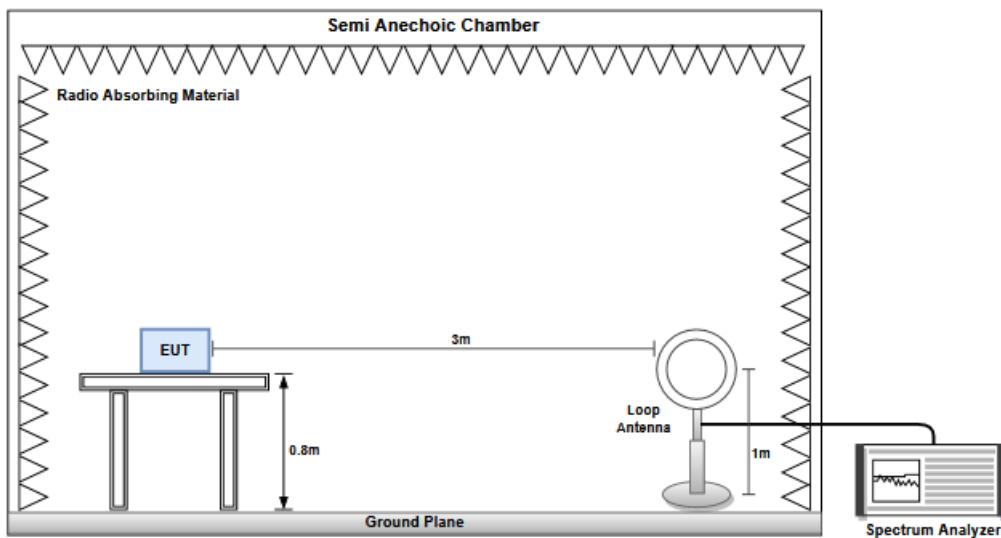

##### 3.1.4 Test Result

Ambient Condition	22°C / 66%	Tested By	Akun Chung
-------------------	------------	-----------	------------

Refer to Appendix A.

## 3.2 Field Strength of Fundamental Emissions

### 3.2.1 Field Strength of Fundamental Emissions

The field strength of any emissions within the band 13.553-13.567 MHz shall not exceed 15,848 microvolts/meter at 30 meters.

### 3.2.2 Test Procedures

1. Measurement is made at a semi-anechoic chamber that incorporates a turntable allowing a EUT rotation of 360°. A continuously-rotating, remotely-controlled turntable is installed at the test site to support the EUT and facilitate determination of the direction of maximum radiation for each EUT emission frequency. The EUT is placed at a height of 0.8 m test table above the ground plane.
2. Measurement is made with the antenna positioned in both the open and close planes of polarization. . Distance between EUT and antenna is 3 m.
3. This investigation is performed with the EUT rotated 360°, and the antenna rotated to repeat the measurements for both the open and close antenna polarizations.

### 3.2.3 Test Setup

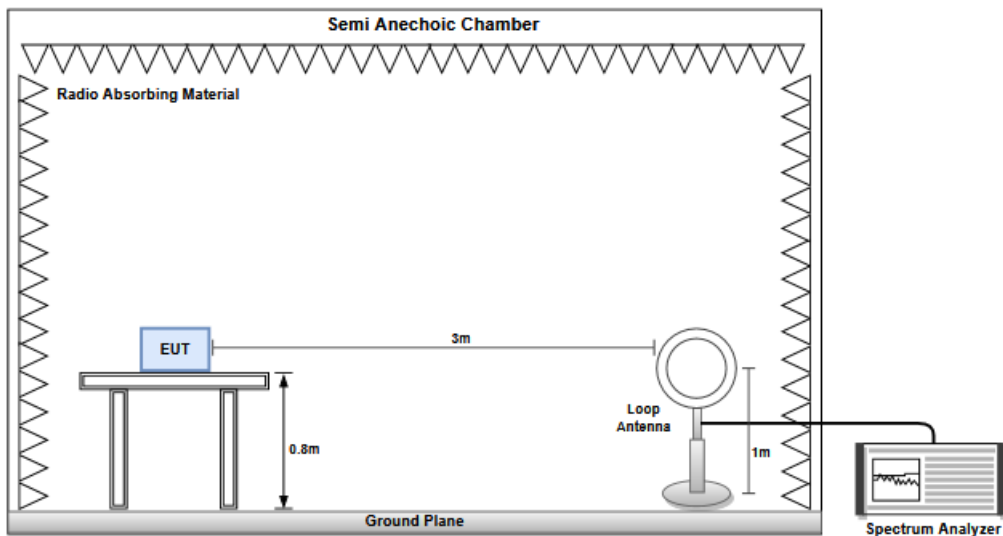

### 3.2.4 Test Result

Ambient Condition	24°C / 66%	Tested By	Paul Lin
-------------------	------------	-----------	----------

Refer to Appendix B.

### 3.3 Unwanted Emissions into Restricted Frequency Bands

#### 3.3.1 Limit of Unwanted Emissions into Restricted Frequency Bands

- 1) Within the bands 13.410-13.553 MHz and 13.567-13.710 MHz, the field strength of any emissions shall not exceed 334 microvolts/meter at 30 meters.
- 2) Within the bands 13.110-13.410 MHz and 13.710-14.010 MHz the field strength of any emissions shall not exceed 106 microvolts/meter at 30 meters.
- 3) The field strength of any emissions appearing outside of the 13.110-14.010 MHz band shall not exceed the general radiated emission limits in below table

Restricted Band Emissions Limit			
Frequency Range (MHz)	Field Strength (uV/m)	Field Strength (dBuV/m)	Measure Distance (m)
0.009~0.490	2400/F(kHz)	48.5 - 13.8	300
0.490~1.705	24000/F(kHz)	33.8 - 23	30
1.705~30.0	30	29	30
30~88	100	40	3
88~216	150	43.5	3
216~960	200	46	3
Above 960	500	54	3

**Note 1:**  
Qusai-Peak value is measured for frequency below 1GHz except for 9–90 kHz, 110–490 kHz frequency band. Peak and average value are measured for frequency above 1GHz. The limit on average radio frequency emission is as above table. The limit on peak radio frequency emissions is 20 dB above the maximum permitted average emission limit

**Note 2:**  
Measurements may be performed at a distance other than what is specified provided. When performing measurements at a distance other than that specified, the results shall be extrapolated to the specified distance using an extrapolation factor as below, Frequency at or above 30 MHz: 20 dB/decade Frequency below 30 MHz: 40 dB/decade.

#### 3.3.2 Test Procedures

4. Measurement is made at a semi-anechoic chamber that incorporates a turntable allowing a EUT rotation of 360°. A continuously-rotating, remotely-controlled turntable is installed at the test site to support the EUT and facilitate determination of the direction of maximum radiation for each EUT emission frequency. The EUT is placed at a height of 0.8 m test table above the ground plane.
5. Measurement is made with the antenna positioned in both the horizontal and vertical planes of polarization. The measurement antenna is varied in height (1m ~ 4m) above the reference ground plane to obtain the maximum signal strength. Distance between EUT and antenna is 3 m.
6. This investigation is performed with the EUT rotated 360°, the antenna height scanned between 1 m and 4 m, and the antenna rotated to repeat the measurements for both the horizontal and vertical antenna polarizations.

Note:

1. 120kHz measurement bandwidth of test receiver and Quasi-peak detector is for radiated emission below 1GHz.

### 3.3.3 Test Setup

#### Radiated Emissions below 30MHz

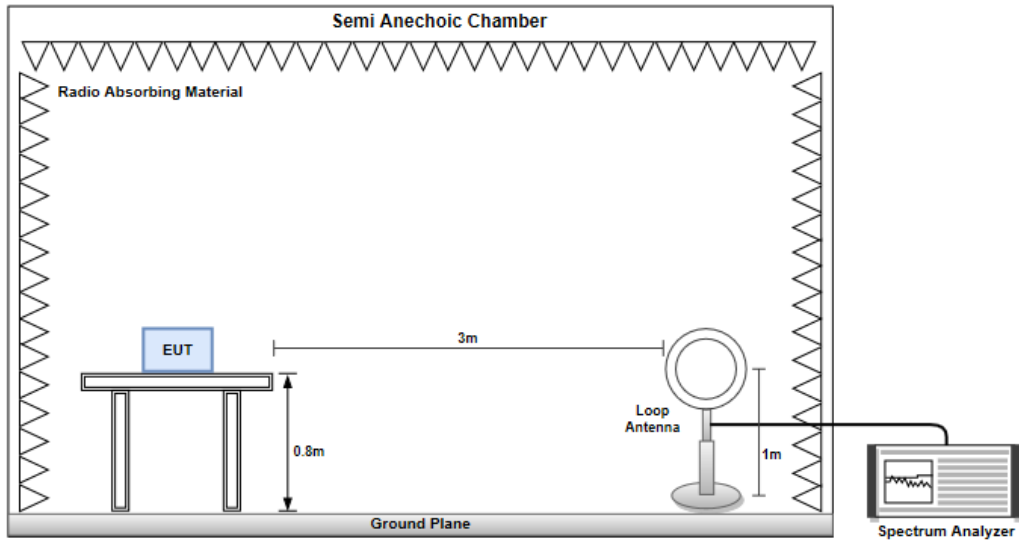

#### Radiated Emissions below 1 GHz

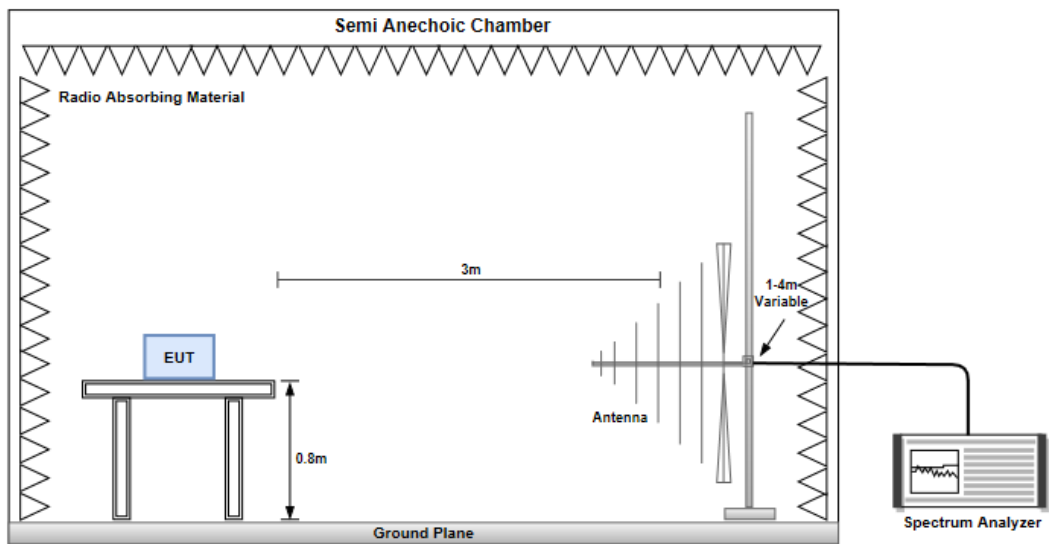

### 3.3.4 Test Results

Ambient Condition	24°C / 66%	Tested By	Paul Lin
-------------------	------------	-----------	----------

Refer to Appendix C.

### 3.4 Frequency Stability

#### 3.4.1 Frequency Stability Limit

Carrier frequency stability shall be maintained to  $\pm 0.01\%$  ( $\pm 100$  ppm).

#### 3.4.2 Test Procedures

Test Method	
<input checked="" type="checkbox"/>	Refer as ANSI C63.10, clause 6.8 for frequency stability tests
<input checked="" type="checkbox"/>	Frequency stability with respect to ambient temperature
<input checked="" type="checkbox"/>	Frequency stability when varying supply voltage
<input type="checkbox"/>	For conducted measurement.
<input checked="" type="checkbox"/>	For radiated measurement. The equipment to be measured and the test antenna shall be oriented to obtain the maximum emitted power level.

#### 3.4.3 Test Setup

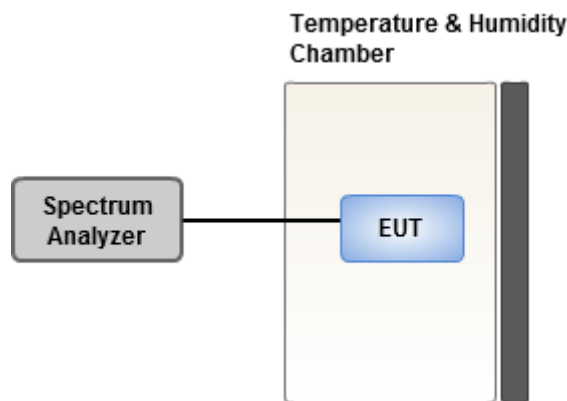

#### 3.4.4 Test Result

<b>Ambient Condition</b>	22°C / 66%	<b>Tested By</b>	Akun Chung
--------------------------	------------	------------------	------------

Refer to Appendix D.

## 3.5 AC Power Line Conducted Emissions

### 3.5.1 Limit of AC Power Line Conducted Emissions

Conducted Emissions Limit		
Frequency Emission (MHz)	Quasi-Peak	Average
0.15-0.5	66 - 56 *	56 - 46 *
0.5-5	56	46
5-30	60	50

Note 1: \* Decreases with the logarithm of the frequency.

### 3.5.2 Test Procedures

1. The device is placed on a test table, raised 80 cm above the reference ground plane. The vertical conducting plane is located 40 cm to the rear of the device.
2. The device is connected to line impedance stabilization network (LISN) and other accessories are connected to other LISN. Measured levels of AC power line conducted emission are across the 50  $\Omega$  LISN port.
3. AC conducted emission measurements is made over frequency range from 150 kHz to 30 MHz.
4. This measurement was performed with AC 120V / 60Hz.

### 3.5.3 Test Setup

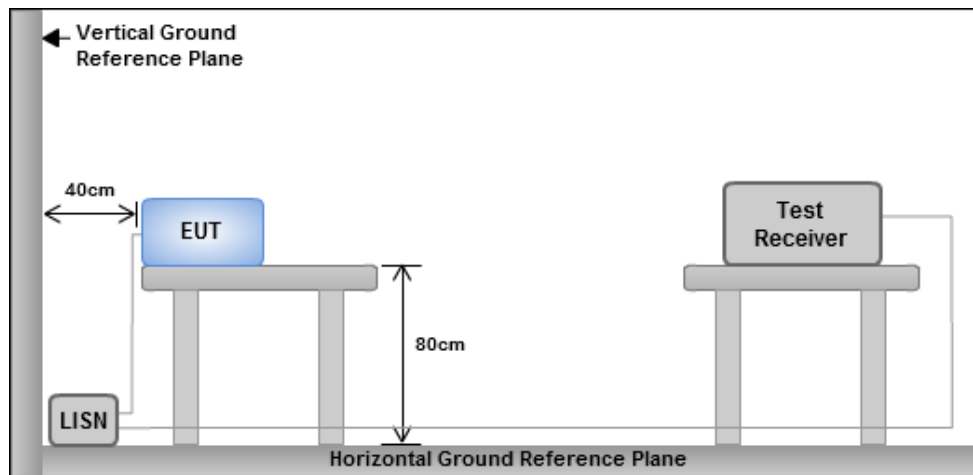

- Note: 1. Support units were connected to second LISN.  
 2. Both of LISNs (AMN) are 80 cm from EUT and at least 80 cm from other units and other metal planes

### 3.5.4 Test Result

Refer to Appendix E.

## 4 Test laboratory information

Established in 2012, ICC provides foremost EMC & RF Testing and advisory consultation services by our skilled engineers and technicians. Our services employ a wide variety of advanced edge test equipment and one of the widest certification extents in the business.

International Certification Corporation (EMC and Wireless Communication Laboratory), it is our definitive objective is to institute long term, trust-based associations with our clients. The expectation we set up with our clients is based on outstanding service, practical expertise and devotion to a certified value structure. Our passion is to grant our clients with best EMC / RF services by oriented knowledgeable and accommodating staff.

Our Test sites are located at Linkou District and Kwei Shan District. Location map can be found on our website <http://www.icertifi.com.tw>.

### **Linkou**

Tel: 886-2-2601-1640

No.30-2, Ding Fwu Tsuen, Lin Kou  
District, New Taipei City, Taiwan  
(R.O.C.)

### **Kwei Shan**

Tel: 886-3-271-8666

No.3-1, Lane 6, Wen San 3rd  
St., Kwei Shan Dist., Tao Yuan  
City 33381, Taiwan (R.O.C.)  
No.2-1, Lane 6, Wen San 3rd  
St., Kwei Shan Dist., Tao Yuan  
City 33381, Taiwan (R.O.C.)

### **Kwei Shan Site II**

Tel: 886-3-271-8640

No.14-1, Lane 19, Wen San 3rd  
St., Kwei Shan Dist., Tao Yuan  
City 33381, Taiwan (R.O.C.)

If you have any suggestion, please feel free to contact us as below information.

Tel: 886-3-271-8666

Fax: 886-3-318-0345

Email: ICC\_Service@icertifi.com.tw

==END==





Modulation Mode	Freq. (MHz)	20dB Bandwidth (kHz)	F <sub>L</sub> at 20dB BW (MHz)	F <sub>H</sub> at 20dB BW (MHz)	99% Bandwidth (kHz)
NFC	13.56	2.605	13.558784	13.561389	2.214182344
<b>Limit</b>		N/A	13.553	13.567	N/A

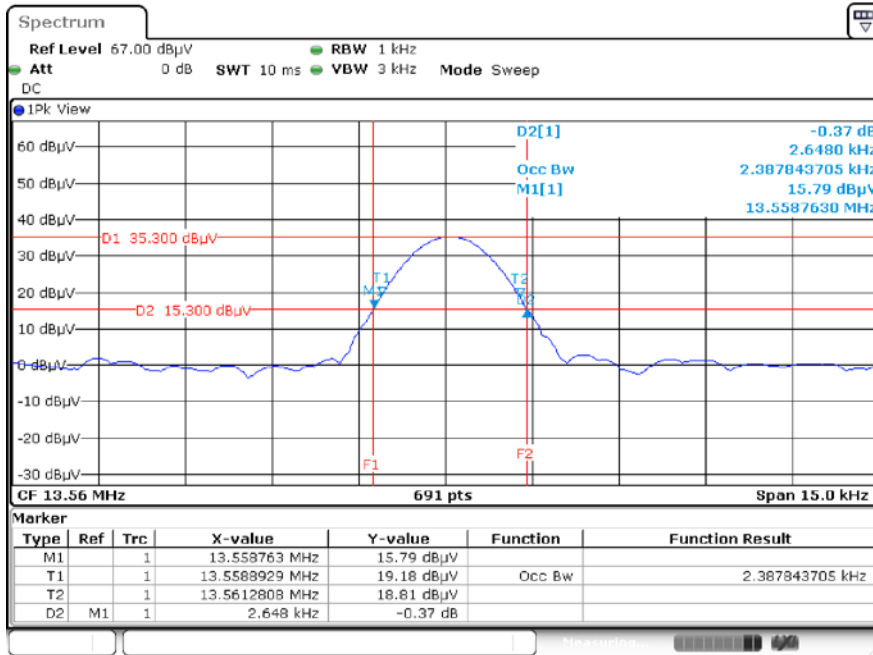



<b>Field Strength of Fundamental Emissions Result</b>							
<b>Polarization</b>	<b>Emission Frequency (MHz)</b>	<b>Emission Level (dBuV/m)</b>	<b>Limit (dBuV/m)</b>	<b>Margin (dB)</b>	<b>SA Reading (dBuV)</b>	<b>Factor (dB)</b>	<b>Remark</b>
Open	13.56	38.31	105.39	-67.08	14	24.31	QP

<b>Field Strength of Fundamental Emissions Result</b>							
<b>Polarization</b>	<b>Emission Frequency (MHz)</b>	<b>Emission Level (dBuV/m)</b>	<b>Limit (dBuV/m)</b>	<b>Margin (dB)</b>	<b>SA Reading (dBuV)</b>	<b>Factor (dB)</b>	<b>Remark</b>
Close	13.56	37.34	105.39	-68.05	13.03	24.31	QP

Note: Emission level = SA reading + Factor



**Unwanted Emissions (Below 30MHz)**

Field Strength of Fundamental Emissions Result							
Polarization	Emission Frequency (MHz)	Emission Level (dBuV/m)	Limit (dBuV/m)	Margin (dB)	SA Reading (dBuV)	Factor(dB)	Remark
Open	13.41	35.91	51.03	-15.12	11.64	24.27	QP
Open	13.553	37.82	50.94	-13.12	13.51	24.31	QP
Open	13.567	38.42	50.93	-12.51	14.1	24.32	QP
Open	13.71	35.57	50.84	-15.27	11.21	24.36	QP
Open	27.12	31.24	49.54	-18.3	11.25	19.99	QP

Field Strength of Fundamental Emissions Result							
Polarization	Emission Frequency (MHz)	Emission Level (dBuV/m)	Limit (dBuV/m)	Margin (dB)	SA Reading (dBuV)	Factor(dB)	Remark
Close	13.41	35.53	51.03	-15.5	11.26	24.27	QP
Close	13.553	34.12	50.94	-16.82	9.81	24.31	QP
Close	13.567	34.64	50.93	-16.29	10.32	24.32	QP
Close	13.71	35.5	50.84	-15.34	11.14	24.36	QP
Close	27.12	31.84	49.54	-17.7	11.85	19.99	QP

Note: Emission level = SA reading + Factor



**Summary**

Mode	Result	Type	Freq (Hz)	Level (dBuV/m)	Limit (dBuV/m)	Margin (dB)	Condition
Mode 1	Pass	PK	623.8M	32.57	46.00	-13.43	Horizontal
Mode 2	Pass	PK	31.41M	34.36	40.00	-5.64	Vertical

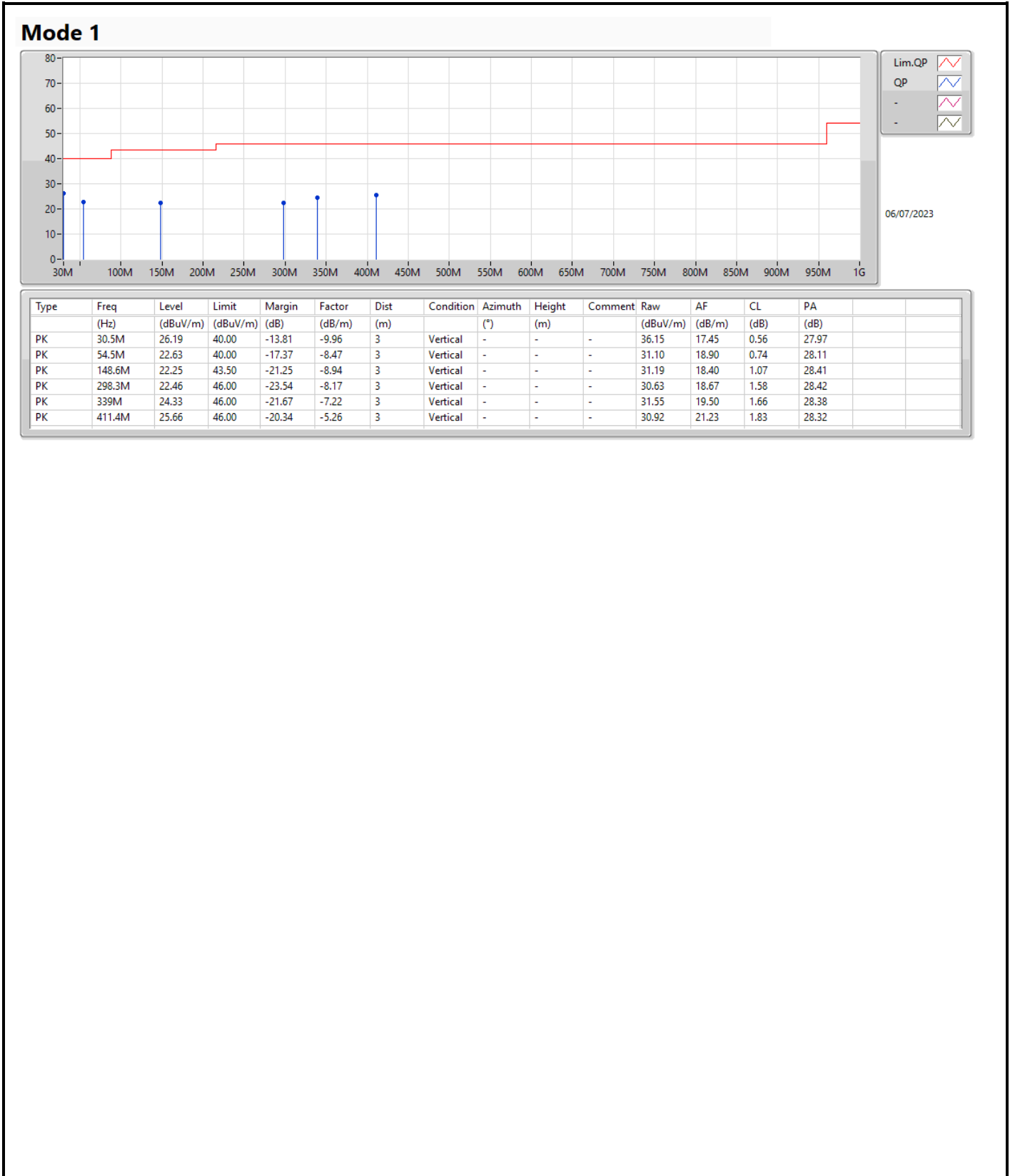



# Unwanted Emissions into Restricted Frequency Bands 30MHz ~ 1GHz

## Appendix C.2

### Mode 1

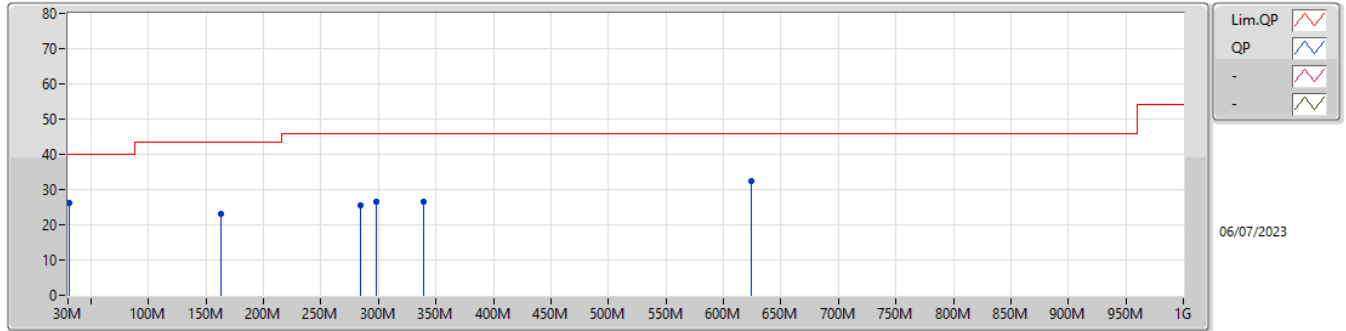

Type	Freq (Hz)	Level (dBuV/m)	Limit (dBuV/m)	Margin (dB)	Factor (dB/m)	Dist (m)	Condition	Azimuth (°)	Height (m)	Comment	Raw (dBuV/m)	AF (dB/m)	CL (dB)	PA (dB)
PK	30.7M	26.25	40.00	-13.75	-9.98	3	Horizontal	-	-	-	36.23	17.43	0.56	27.97
PK	162.7M	23.11	43.50	-20.39	-9.13	3	Horizontal	-	-	-	32.24	18.17	1.12	28.42
PK	284.8M	25.64	46.00	-20.36	-8.48	3	Horizontal	-	-	-	34.12	18.40	1.54	28.42
PK	298.3M	26.60	46.00	-19.40	-8.17	3	Horizontal	-	-	-	34.77	18.67	1.58	28.42
PK	339M	26.50	46.00	-19.50	-7.22	3	Horizontal	-	-	-	33.72	19.50	1.66	28.38
PK	623.8M	32.57	46.00	-13.43	-0.35	3	Horizontal	-	-	-	32.92	25.58	2.30	28.23



**Mode 2**

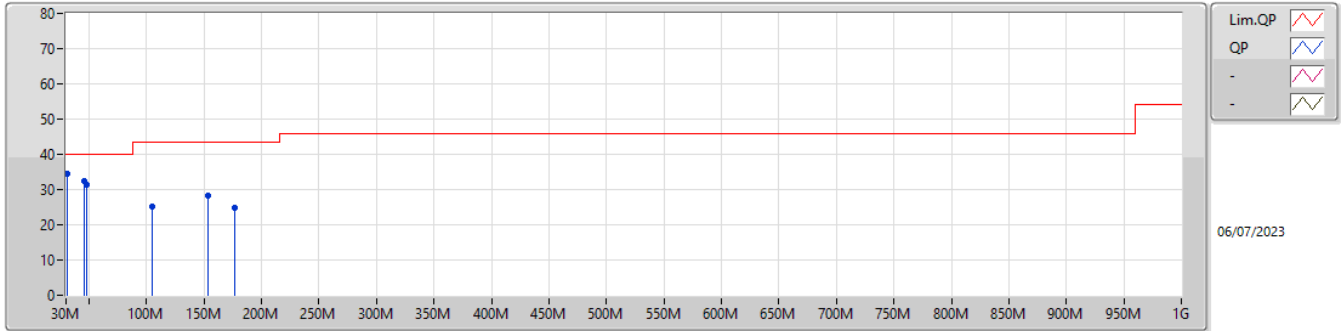

Type	Freq (Hz)	Level (dBuV/m)	Limit (dBuV/m)	Margin (dB)	Factor (dB/m)	Dist (m)	Condition	Azimuth (°)	Height (m)	Comment	Raw (dBuV/m)	AF (dB/m)	CL (dB)	PA (dB)
PK	31.41M	34.36	40.00	-5.64	-9.76	3	Vertical	-	-	-	44.12	17.65	0.57	27.98
PK	45.46M	32.50	40.00	-7.50	-8.15	3	Vertical	-	-	-	40.65	19.25	0.66	28.06
PK	48.28M	31.38	40.00	-8.62	-8.10	3	Vertical	-	-	-	39.48	19.27	0.70	28.07
PK	104.51M	25.20	43.50	-18.30	-12.44	3	Vertical	-	-	-	37.64	15.00	0.94	28.38
PK	153.71M	28.32	43.50	-15.18	-8.95	3	Vertical	-	-	-	37.27	18.37	1.09	28.41
PK	176.2M	24.71	43.50	-18.79	-9.96	3	Vertical	-	-	-	34.67	17.28	1.19	28.43



**Mode 2**

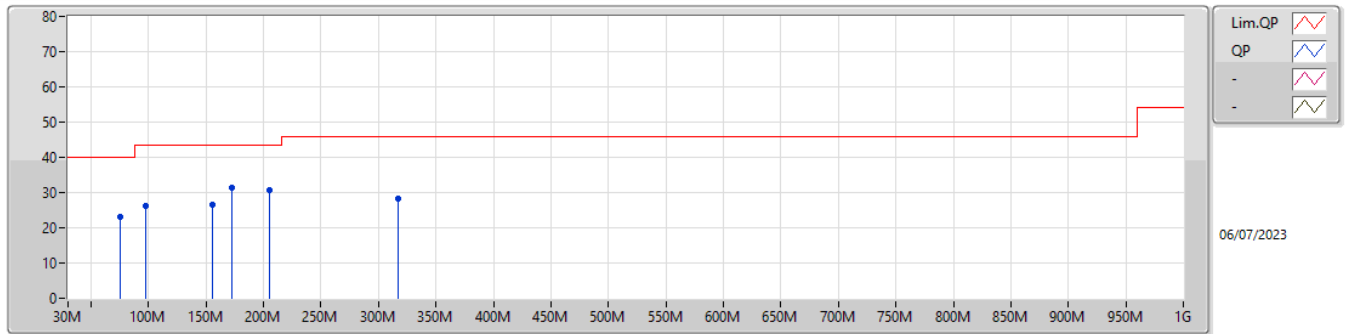

Type	Freq (Hz)	Level (dBuV/m)	Limit (dBuV/m)	Margin (dB)	Factor (dB/m)	Dist (m)	Condition	Azimuth (°)	Height (m)	Comment	Raw (dBuV/m)	AF (dB/m)	CL (dB)	PA (dB)
PK	75.52M	23.21	40.00	-16.79	-12.39	3	Horizontal	-	-	-	35.60	15.00	0.84	28.23
PK	97.48M	26.10	43.50	-17.40	-13.70	3	Horizontal	-	-	-	39.80	13.75	0.91	28.36
PK	155.12M	26.65	43.50	-16.85	-8.74	3	Horizontal	-	-	-	35.39	18.58	1.09	28.41
PK	171.99M	31.22	43.50	-12.28	-9.45	3	Horizontal	-	-	-	40.67	17.80	1.17	28.42
PK	205.72M	30.78	43.50	-12.72	-11.90	3	Horizontal	-	-	-	42.68	15.20	1.34	28.44
PK	316.78M	28.16	46.00	-17.84	-7.54	3	Horizontal	-	-	-	35.70	19.24	1.62	28.40





Frequency: 13.56 MHz	Frequency Drift (ppm)			
	0 minute	2 minutes	5 minutes	10 minutes
T20°C Vmax	2.21	3.69	8.85	11.06
T20°C Vmin	2.95	4.42	8.11	10.32
T60°C Vnom	3.69	6.64	8.11	9.07
T50°C Vnom	2.95	4.42	6.64	9.59
T40°C Vnom	2.95	5.16	7.37	11.80
T30°C Vnom	1.47	2.95	5.90	8.85
T20°C Vnom	2.21	3.69	8.85	10.32
T10°C Vnom	0.74	2.95	10.32	11.06
T0°C Vnom	1.47	5.16	9.59	12.54
T-10°C Vnom	2.21	5.90	11.80	13.27
T-20°C Vnom	2.95	7.37	12.54	13.86
Vnom [V]: 3.87	Vmax [V]: 4.45		Vmin [V]: 3.4	
Tnom [°C]: 20	Tmax [°C]: 60		Tmin [°C]: -20	



Mode	Charging mode
Power Phase	Line

Test by : Joe Liao      Temperature: 21°C      Humidity: 63%

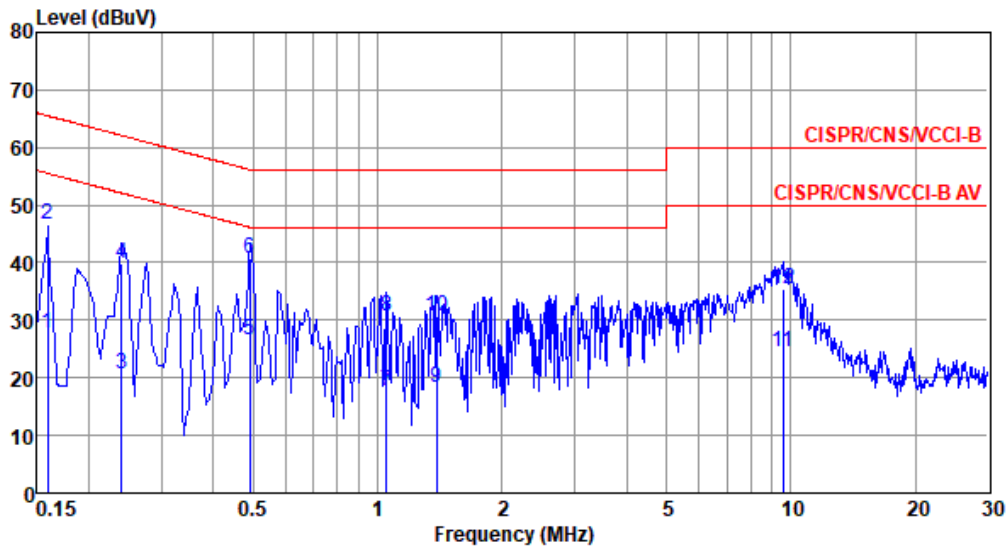

	Freq MHz	Level dBUV	Limit Line dBUV	Over Limit dB	Read Level dBUV	Factor dB	Cable loss dB	Aux dB	Remark
1	0.159	27.63	55.52	-27.89	17.76	9.63	0.06	0.18	Average
2	0.159	46.62	65.52	-18.90	36.75	9.63	0.06	0.18	QP
3	0.240	20.56	52.08	-31.52	10.66	9.62	0.06	0.22	Average
4	0.240	39.87	62.08	-22.21	29.97	9.62	0.06	0.22	QP
5	0.491	26.56	46.14	-19.58	16.56	9.62	0.07	0.31	Average
6*	0.491	40.87	56.14	-15.27	30.87	9.62	0.07	0.31	QP
7	1.049	17.64	46.00	-28.36	7.57	9.63	0.11	0.33	Average
8	1.049	30.58	56.00	-25.42	20.51	9.63	0.11	0.33	QP
9	1.388	18.31	46.00	-27.69	8.22	9.63	0.12	0.34	Average
10	1.388	30.84	56.00	-25.16	20.75	9.63	0.12	0.34	QP
11	9.552	24.43	50.00	-25.57	13.95	9.69	0.35	0.44	Average
12	9.552	35.37	60.00	-24.63	24.89	9.69	0.35	0.44	QP

Note 1: Level (dBUV) = Read Level (dBUV) + LISN Factor (dB) + Cable Loss (dB) + Aux (dB).  
 Note 2: Over Limit (dB) = Level (dBUV) - Limit Line (dBUV).



Mode	Charging mode
Power Phase	Neutral

Test by : Joe Liao      Temperature: 21°C      Humidity: 63%

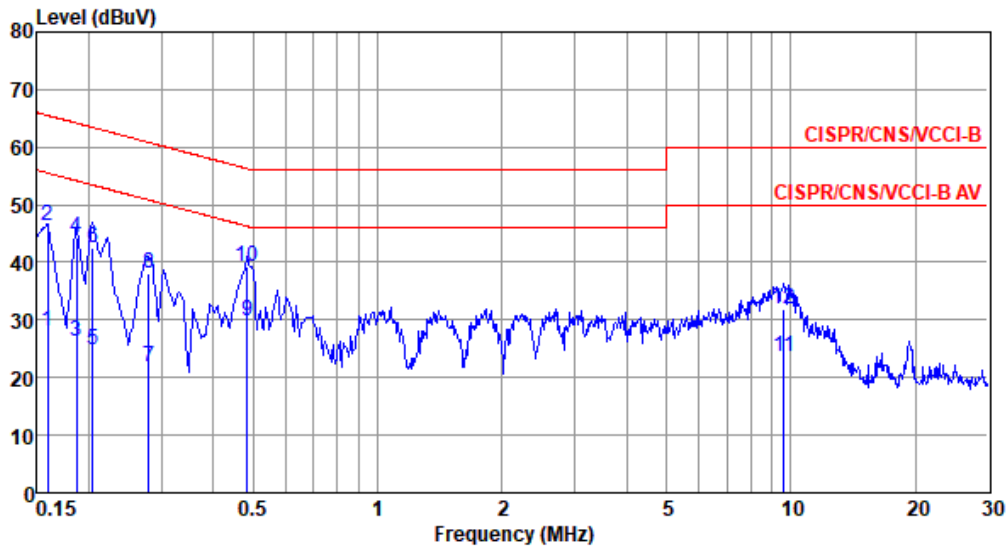

	Freq MHz	Level dBuV	Limit Line dBuV	Over Limit dB	Read Level dBuV	Factor dB	Cable loss dB	Aux dB	Remark
1	0.159	28.00	55.52	-27.52	18.13	9.63	0.06	0.18	Average
2	0.159	46.46	65.52	-19.06	36.59	9.63	0.06	0.18	QP
3	0.186	26.39	54.20	-27.81	16.51	9.63	0.06	0.19	Average
4	0.186	44.18	64.20	-20.02	34.30	9.63	0.06	0.19	QP
5	0.204	24.92	53.45	-28.53	15.04	9.63	0.06	0.19	Average
6	0.204	42.61	63.45	-20.84	32.73	9.63	0.06	0.19	QP
7	0.279	21.92	50.85	-28.93	11.99	9.63	0.06	0.24	Average
8	0.279	38.19	60.85	-22.66	28.26	9.63	0.06	0.24	QP
9*	0.484	29.69	46.27	-16.58	19.69	9.62	0.07	0.31	Average
10	0.484	39.22	56.27	-17.05	29.22	9.62	0.07	0.31	QP
11	9.603	23.51	50.00	-26.49	13.01	9.71	0.35	0.44	Average
12	9.603	31.77	60.00	-28.23	21.27	9.71	0.35	0.44	QP

Note 1: Level (dBuV) = Read Level (dBuV) + LISN Factor (dB) + Cable Loss (dB) + Aux (dB).  
 2: Over Limit (dB) = Level (dBuV) – Limit Line (dBuV).