

FCC Test Report

FCC ID : IPH-A4263
Equipment : Outdoor GPS Watch
Model No. : AA4263
Brand Name : GARMIN
Applicant : Garmin International, Inc.
Address : 1200 E. 151st Street Olathe, KS 66062 United States
Standard : 47 CFR FCC Part 15.247
Received Date : Apr. 13, 2023
Tested Date : May 20 ~ Jul. 06, 2023

We, International Certification Corporation, would like to declare that the tested sample has been evaluated and in compliance with the requirement of the above standards. The test results contained in this report refer exclusively to the product. It shall not be reproduced except in full without the written approval of our laboratory.

Reviewed by:

Approved by:



Along Chen / Assistant Manager



Gary Chang / Manager

Table of Contents

1	GENERAL DESCRIPTION	5
1.1	Information.....	5
1.2	Local Support Equipment List	8
1.3	Test Setup Chart	8
1.4	Test Equipment List and Calibration Data.....	9
1.5	Test Standards	10
1.6	Reference Guidance	10
1.7	Deviation from Test Standard and Measurement Procedure.....	11
1.8	Measurement Uncertainty	11
2	TEST CONFIGURATION.....	12
2.1	Testing Facility	12
2.2	The Worst Test Modes and Channel Details	12
3	TRANSMITTER TEST RESULTS	13
3.1	6dB and Occupied Bandwidth	13
3.2	Conducted Output Power	14
3.3	Power Spectral Density	15
3.4	Unwanted Emissions in Restricted Frequency Bands.....	16
3.5	Emissions in non-restricted Frequency Bands.....	18
3.6	AC Power Line Conducted Emissions	19
4	TEST LABORATORY INFORMATION	20

Appendix A. 6dB and Occupied Bandwidth

Appendix B. Conducted Output Power

Appendix C. Power Spectral Density

Appendix D. Unwanted Emissions into Restricted Frequency Bands

Appendix E. Emissions in Non-Restricted Frequency Bands

Appendix F. AC Power Line Conducted Emissions

Release Record

Report No.	Version	Description	Issued Date
FR341301AE	Rev. 01	Initial issue	Aug. 07, 2023

Summary of Test Results

FCC Rules	Test Items	Measured	Result
15.207	AC Power Line Conducted Emissions	[dBuV]: 0.491MHz 40.87 (Margin -15.27dB) - QP	Pass
15.247(d) 15.209	Unwanted Emissions	[dBuV/m at 3m]: 31.41MHz 34.36 (Margin -5.64dB) - PK	Pass
15.247(b)(3)	Conducted Output Power	Power [dBm]: 4.29	Pass
15.247(a)(2)	6dB Bandwidth	Meet the requirement of limit	Pass
15.247(e)	Power Spectral Density	Meet the requirement of limit	Pass
15.203	Antenna Requirement	Meet the requirement of limit	Pass

Declaration of Conformity:

The test results with all measurement uncertainty excluded are presented in accordance with the regulation limits or requirements declared by manufacturers.

Comments and Explanations:

The declared of product specification for EUT presented in the report are provided by the manufacturer, and the manufacturer takes all the responsibilities for the accuracy of product specification.

1 General Description

1.1 Information

1.1.1 Specification of the Equipment under Test (EUT)

RF General Information				
Frequency Range (MHz)	Bluetooth Mode	Ch. Freq. (MHz)	Channel Number	Data Rate
2400-2483.5	LE	2402-2480	40	1 Mbps
		2404-2478	37	2 Mbps

Note: Bluetooth LE (Low energy) uses GFSK modulation.

1.1.2 Antenna Details

Ant. No.	Brand	Model	Type	Connector	Gain (dBi)
1	Garmin	145-03859-00	Slot	No	-6.31

1.1.3 Power Supply Type of Equipment under Test (EUT)

Power Supply Type	5Vdc from host 3.87Vdc from battery
--------------------------	--

1.1.4 Accessories

Accessories		
No.	Equipment	Description
1	Battery	Brand: Garmin Model: 361-00146-01 Rating: 3.87Vdc, 342mAh
2	USB cable	Brand: GARMIN Model: 320-01048-C1 1.02m shielded without core

1.1.5 Channel List

Frequency band (MHz)				2402-2480 / BT-LE(1Mbps)			
Channel	Frequency (MHz)	Channel	Frequency (MHz)	Channel	Frequency (MHz)	Channel	Frequency (MHz)
37	2402	9	2422	18	2442	28	2462
0	2404	10	2424	19	2444	29	2464
1	2406	38	2426	20	2446	30	2466
2	2408	11	2428	21	2448	31	2468
3	2410	12	2430	22	2450	32	2470
4	2412	13	2432	23	2452	33	2472
5	2414	14	2434	24	2454	34	2474
6	2416	15	2436	25	2456	35	2476
7	2418	16	2438	26	2458	36	2478
8	2420	17	2440	27	2460	39	2480

Frequency band (MHz)				2404-2478 / BT-LE(2Mbps)			
Channel	Frequency (MHz)	Channel	Frequency (MHz)	Channel	Frequency (MHz)	Channel	Frequency (MHz)
0	2404	10	2424	20	2446	30	2466
1	2406	11	2428	21	2448	31	2468
2	2408	12	2430	22	2450	32	2470
3	2410	13	2432	23	2452	33	2472
4	2412	14	2434	24	2454	34	2474
5	2414	15	2436	25	2456	35	2476
6	2416	16	2438	26	2458	36	2478
7	2418	17	2440	27	2460	--	--
8	2420	18	2442	28	2462	--	--
9	2422	19	2444	29	2464	--	--

1.1.6 Test Tool and Duty Cycle

Test Tool	BLE Test, V24.95	
Modulation Mode	Duty Cycle (%)	Duty Factor (dB)
BT-LE(1Mbps)	100.00%	0.00
BT-LE(2Mbps)	100.00%	0.00

1.1.7 Power Index of Test Tool

Modulation Mode	Test Frequency (MHz)		
	2402	2440	2480
BT-LE(1Mbps)	default	default	default

Modulation Mode	Test Frequency (MHz)		
	2404	2440	2478
BT-LE(2Mbps)	default	default	default

1.2 Local Support Equipment List

Support Equipment List					
No.	Equipment	Brand	Model	FCC ID	Remarks
1	Adapter	Samsung	EP-TA800	---	---

1.3 Test Setup Chart

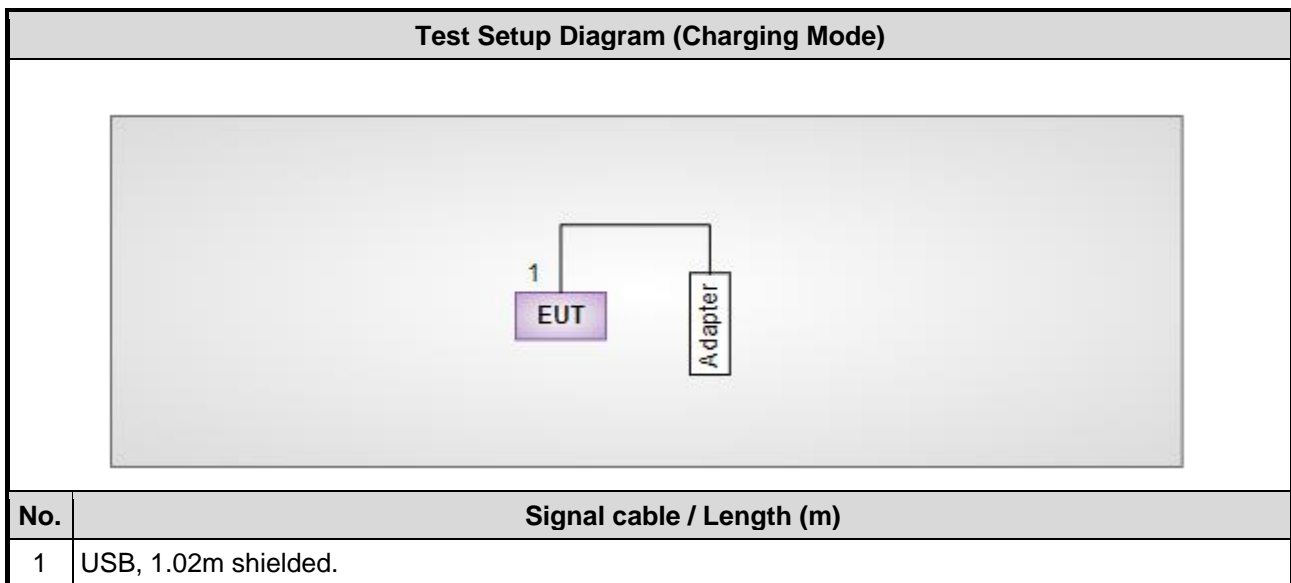
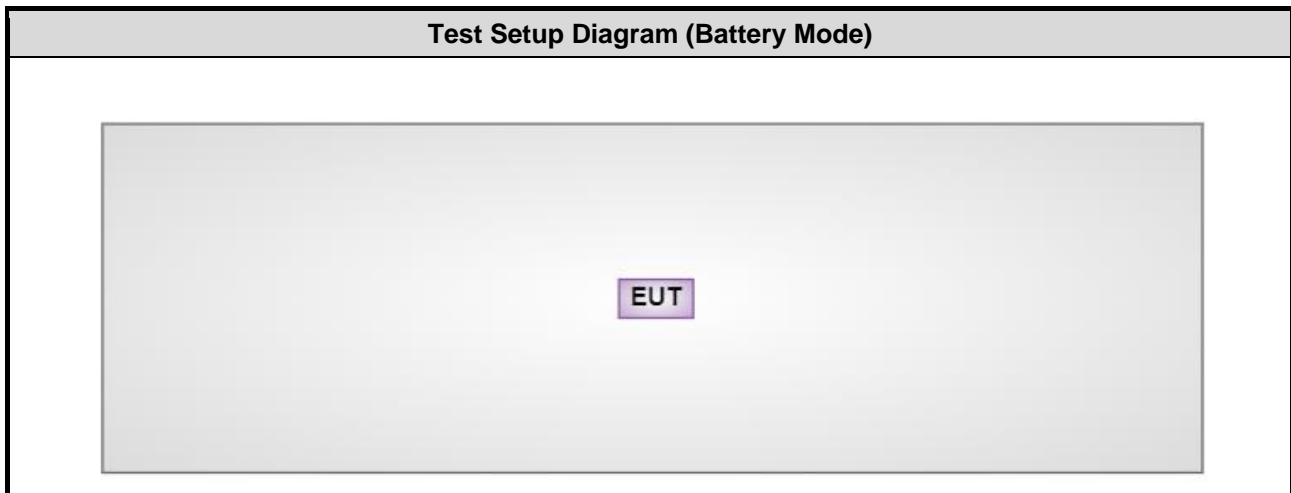

1.4 Test Equipment List and Calibration Data

Test Item	Conducted Emission				
Test Site	Conduction room 1 / (CO01-WS)				
Tested Date	May 24, 2023				
Instrument	Brand	Model No.	Serial No.	Calibration Date	Calibration Until
Receiver	R&S	ESR3	101658	Feb. 17, 2023	Feb. 16, 2024
LISN	R&S	ENV216	101579	May 09, 2023	May 08, 2024
LISN (Support Unit)	SCHWARZBECK	Schwarzbeck 8127	8127667	Jan .03, 2023	Jan .02, 2024
RF Cable-CON	Woken	CFD200-NL	CFD200-NL-001	Oct. 17, 2022	Oct. 16, 2023
50 ohm terminal (Support Unit)	NA	50	03	Jun. 08, 2022	Jun. 07, 2023
Measurement Software	AUDIX	e3	6.120210k	NA	NA
Note: Calibration Interval of instruments listed above is one year.					

Test Item	Radiated Emission below 1GHz				
Test Site	966 chamber1 / (03CH01-WS)				
Tested Date	Jul. 06, 2023				
Instrument	Brand	Model No.	Serial No.	Calibration Date	Calibration Until
Receiver	R&S	ESR3	101657	Mar. 03, 2023	Mar. 02, 2024
Loop Antenna	R&S	HFH2-Z2	100330	Nov. 01, 2022	Oct. 31, 2023
Bilog Antenna	SCHWARZBECK	VULB9168	VULB9168-522	Aug. 03, 2022	Aug. 02, 2023
Preamplifier	EMC	EMC02325	980225	Jun. 28, 2023	Jun. 27, 2024
Loop Antenna Cable	KOAX KABEL	101354-BW	101354-BW	Oct. 04, 2022	Oct. 03, 2023
LF cable 3M	Woken	CFD400NL-LW	CFD400NL-001	Oct. 04, 2022	Oct. 03, 2023
LF cable 11M	EMC	EMCCFD400-NW-N W-11000	200801	Oct. 04, 2022	Oct. 03, 2023
LF cable 1M	EMC	EMCCFD400-NM-N M-1000	160502	Oct. 04, 2022	Oct. 03, 2023
Measurement Software	Sporton	SENSE-EMI	V5.10.8	NA	NA
Note: Calibration Interval of instruments listed above is one year.					

Test Item	Radiated Emission above 1GHz				
Test Site	966 chamber1 / (03CH01-WS)				
Tested Date	May 20 ~ May 24, 2023				
Instrument	Brand	Model No.	Serial No.	Calibration Date	Calibration Until
Spectrum Analyzer	R&S	FSV40	101498	Nov. 21, 2022	Nov. 20, 2023
Horn Antenna 1G-18G	SCHWARZBECK	BBHA 9120 D	BBHA 9120 D 1096	Nov. 25, 2022	Nov. 24, 2023
Horn Antenna 18G-40G	SCHWARZBECK	BBHA 9170	BBHA 9170517	Oct. 27, 2022	Oct. 26, 2023
Preamplifier	EMC	EMC118A45SE	980898	Jul. 16, 2022	Jul. 15, 2023
Preamplifier	EMC	EMC184045SE	980903	Jul. 16, 2022	Jul. 15, 2023
RF Cable	EMC	EMC104-35M-35M-8000	210920	Oct. 04, 2022	Oct. 03, 2023
RF Cable	EMC	EMC104-35M-35M-3000	210922	Oct. 04, 2022	Oct. 03, 2023
Attenuator	Pasternack	PE7005-10	10-1	Oct. 06, 2022	Oct. 05, 2023
HIGHPASS FILTER 3.1-18G	WHK	WHK3.1/18G-10SS	39	Oct. 06, 2022	Oct. 05, 2023
Measurement Software	Sporton	SENSE-15247_FS	V5.10.8	NA	NA
Note: Calibration Interval of instruments listed above is one year.					

Test Item	RF Conducted				
Test Site	(TH01-WS)				
Tested Date	Jul. 06, 2023				
Instrument	Brand	Model No.	Serial No.	Calibration Date	Calibration Until
Spectrum Analyzer	R&S	FSV40	101910	Apr. 14, 2023	Apr. 13, 2024
Power Meter	Anritsu	ML2495A	1241002	Nov. 23, 2022	Nov. 22, 2023
Power Sensor	Anritsu	MA2411B	1207366	Nov. 23, 2022	Nov. 22, 2023
Attenuator	Pasternack	PE7005-10	10-2	Oct. 06, 2022	Oct. 05, 2023
Measurement Software	Sporton	SENSE-15247_FS	V5.10.8	NA	NA
Note: Calibration Interval of instruments listed above is one year.					

1.5 Test Standards

47 CFR FCC Part 15.247
ANSI C63.10-2013

1.6 Reference Guidance

FCC KDB 558074 D01 15.247 Meas Guidance v05r02

1.7 Deviation from Test Standard and Measurement Procedure

None

1.8 Measurement Uncertainty

The measurement uncertainties given below are based on a 95% confidence level (based on a coverage factor (k=2)).

Measurement Uncertainty	
Parameters	Uncertainty
Bandwidth	±34.130 Hz
Conducted power	±0.808 dB
Power density	±0.583 dB
Conducted emission	±2.715 dB
AC conducted emission	±2.92 dB
Unwanted Emission ≤ 1GHz	±3.41 dB
Unwanted Emission > 1GHz	±4.59 dB

2 Test Configuration

2.1 Testing Facility

Test Laboratory	International Certification Corporation
Test Site	CO01-WS, 03CH01-WS, TH01-WS
Address of Test Site	No.3-1, Lane 6, Wen San 3rd St., Kwei Shan Dist., Tao Yuan City 33381, Taiwan (R.O.C.)

- FCC Designation No.: TW2732
- FCC site registration No.: 181692
- ISED#: 10807A
- CAB identifier: TW2732

2.2 The Worst Test Modes and Channel Details

Test item	Modulation Mode	Test Frequency (MHz)	Data Rate	Test Configuration
AC Power Line Conducted Emissions	Charging mode	---	---	2
Unwanted Emissions ≤ 1GHz	BT LE	2440	2Mbps	1
	Charging mode	---	---	2
Unwanted Emissions >1GHz Conducted Output Power 6dB bandwidth Power spectral density	BT LE	2402 / 2440 / 2480 2404 / 2440 / 2478	1Mbps 2Mbps	1
NOTE:				
1. The EUT was pretested with 3 orientations placed on the table for the radiated emission measurement – X, Y, and Z-plane. The Z-plane result was found as the worst case and was shown in this report.				
2. The test configurations are listed as follows:				
1) Mode 1: Battery mode				
2) Mode 2: Charging mode				

3 Transmitter Test Results

3.1 6dB and Occupied Bandwidth

3.1.1 Limit of 6dB Bandwidth

The minimum 6dB bandwidth shall be at least 500 kHz.

3.1.2 Test Procedures

6dB Bandwidth

1. Set resolution bandwidth (RBW) = 100 kHz, Video bandwidth = 300 kHz.
2. Detector = Peak, Trace mode = max hold.
3. Sweep = auto couple, Allow the trace to stabilize.
4. Measure the maximum width of the emission that is constrained by the frequencies associated with the two outermost amplitude points (upper and lower) that are attenuated by 6dB relative to the maximum level measured in the fundamental emission.

Occupied Bandwidth

1. Set resolution bandwidth (RBW) = 1% ~ 5 % of OBW, Video bandwidth = 3 x RBW
2. Detector = Sample, Trace mode = max hold.
3. Sweep = auto couple, Allow the trace to stabilize.
4. Use the OBW measurement function of spectrum analyzer to measure the occupied bandwidth.

3.1.3 Test Setup

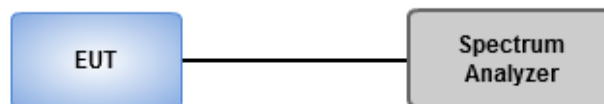

3.1.4 Test Results

Ambient Condition	25°C / 66%	Tested By	Akun Chung
--------------------------	------------	------------------	------------

Refer to Appendix A.

3.2 Conducted Output Power

3.2.1 Limit of Conducted Output Power

Conducted power shall not exceed 1Watt.

Antenna gain $\leq 6\text{dBi}$, no any corresponding reduction is in output power limit.

3.2.2 Test Procedures

A broadband RF power meter is used for output power measurement. The video bandwidth of power meter is greater than DTS bandwidth of EUT. If duty cycle of test signal is not 100 %, trigger and gating function of power meter will be enabled to capture transmission burst for measuring output power.

3.2.3 Test Setup

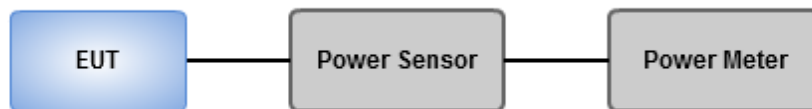

3.2.4 Test Results

Ambient Condition	25°C / 66%	Tested By	Akun Chung
--------------------------	------------	------------------	------------

Refer to Appendix B.

3.3 Power Spectral Density

3.3.1 Limit of Power Spectral Density

Power spectral density shall not be greater than 8 dBm in any 3 kHz band.

3.3.2 Test Procedures

1. Set the RBW = 3 kHz, VBW = 10 kHz.
2. Detector = Peak, Sweep time = auto couple.
3. Trace mode = max hold, allow trace to fully stabilize.
4. Use the peak marker function to determine the maximum amplitude level.

3.3.3 Test Setup

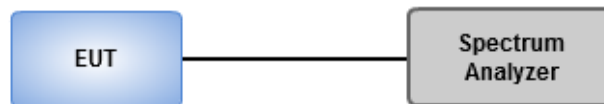

3.3.4 Test Results

Ambient Condition	25°C / 66%	Tested By	Akun Chung
--------------------------	------------	------------------	------------

Refer to Appendix C.

3.4 Unwanted Emissions in Restricted Frequency Bands

3.4.1 Limit of Unwanted Emissions in Restricted Frequency Bands

Restricted Band Emissions Limit			
Frequency Range (MHz)	Field Strength (uV/m)	Field Strength (dBuV/m)	Measure Distance (m)
0.009~0.490	2400/F(kHz)	48.5 - 13.8	300
0.490~1.705	24000/F(kHz)	33.8 - 23	30
1.705~30.0	30	29	30
30~88	100	40	3
88~216	150	43.5	3
216~960	200	46	3
Above 960	500	54	3

Note 1:
Qusai-Peak value is measured for frequency below 1GHz except for 9–90 kHz, 110–490 kHz frequency band. Peak and average value are measured for frequency above 1GHz. The limit on average radio frequency emission is as above table. The limit on peak radio frequency emissions is 20 dB above the maximum permitted average emission limit

Note 2:
Measurements may be performed at a distance other than what is specified provided. When performing measurements at a distance other than that specified, the results shall be extrapolated to the specified distance using an extrapolation factor as below, Frequency at or above 30 MHz: 20 dB/decade Frequency below 30 MHz: 40 dB/decade.

3.4.2 Test Procedures

1. Measurement is made at a semi-anechoic chamber that incorporates a turntable allowing a EUT rotation of 360°. A continuously-rotating, remotely-controlled turntable is installed at the test site to support the EUT and facilitate determination of the direction of maximum radiation for each EUT emission frequency. The EUT is placed at test table. For emissions testing at or below 1 GHz, the table height is 80 cm above the reference ground plane. For emission measurements above 1 GHz, the table height is 1.5 m
2. Measurement is made with the antenna positioned in both the horizontal and vertical planes of polarization. The measurement antenna is varied in height (1m ~ 4m) above the reference ground plane to obtain the maximum signal strength. Distance between EUT and antenna is 3 m.
3. This investigation is performed with the EUT rotated 360°, the antenna height scanned between 1 m and 4 m, and the antenna rotated to repeat the measurements for both the horizontal and vertical antenna polarizations.

Note:

1. 120kHz measurement bandwidth of test receiver and Quasi-peak detector is for radiated emission below 1GHz.
2. RBW=1MHz, VBW=3MHz and Peak detector is for peak measured value of radiated emission above 1GHz.
3. RBW=1MHz, VBW=1/T and Peak detector is for average measured value of radiated emission above 1GHz.

3.4.3 Test Setup

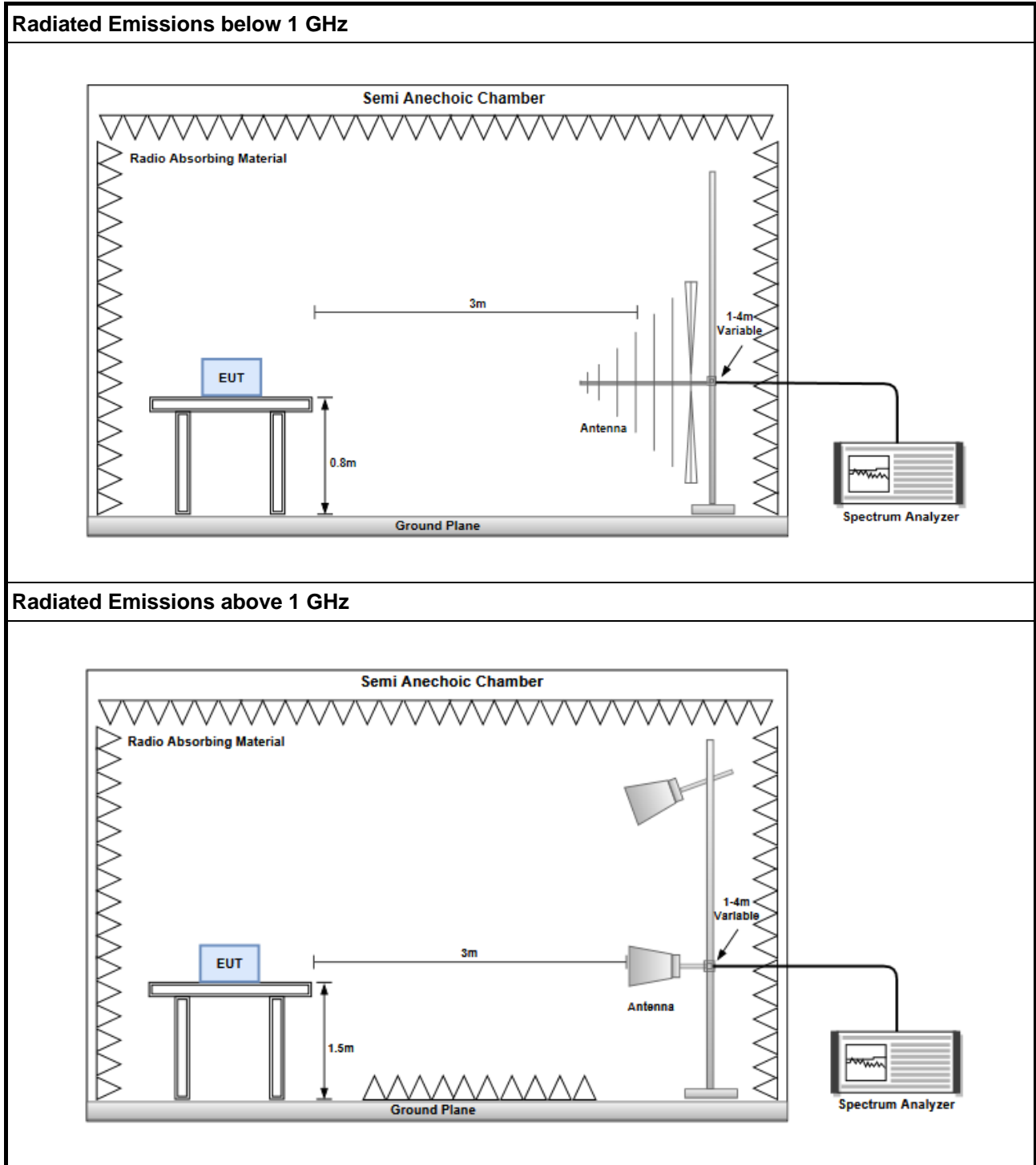

3.4.4 Test Results

Ambient Condition	23-25°C / 62-63%	Tested By	Sean Yu / Brad Wu
--------------------------	------------------	------------------	-------------------

Refer to Appendix D.

3.5 Emissions in non-restricted Frequency Bands

3.5.1 Emissions in non-restricted frequency bands limit

Peak power in any 100 kHz bandwidth outside of the authorized frequency band shall be attenuated by at least 20 dB relative to the maximum in-band peak PSD level in 100 kHz.

3.5.2 Test Procedures

Reference level measurement

1. Set RBW=100kHz, VBW = 300kHz , Detector = Peak, Sweep time = Auto
2. Trace = max hold , Allow Trace to fully stabilize
3. Use the peak marker function to determine the maximum PSD level

Emission level measurement

1. Set RBW=100kHz, VBW = 300kHz , Detector = Peak, Sweep time = Auto
2. Trace = max hold , Allow Trace to fully stabilize
3. Scan Frequency range is up to 25GHz
4. Use the peak marker function to determine the maximum amplitude level

3.5.3 Test Setup

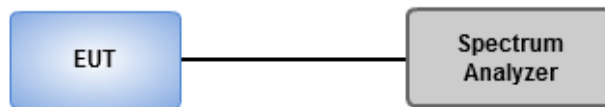

3.5.4 Test Results

Ambient Condition	25°C / 66%	Tested By	Akun Chung
--------------------------	------------	------------------	------------

Refer to Appendix E.

3.6 AC Power Line Conducted Emissions

3.6.1 Limit of AC Power Line Conducted Emissions

Conducted Emissions Limit		
Frequency Emission (MHz)	Quasi-Peak	Average
0.15-0.5	66 - 56 *	56 - 46 *
0.5-5	56	46
5-30	60	50

Note 1: * Decreases with the logarithm of the frequency.

3.6.2 Test Procedures

1. The device is placed on a test table, raised 80 cm above the reference ground plane. The vertical conducting plane is located 40 cm to the rear of the device.
2. The device is connected to line impedance stabilization network (LISN) and other accessories are connected to other LISN. Measured levels of AC power line conducted emission are across the 50 Ω LISN port.
3. AC conducted emission measurements is made over frequency range from 150 kHz to 30 MHz.
4. This measurement was performed with AC 120V/60Hz

3.6.3 Test Setup

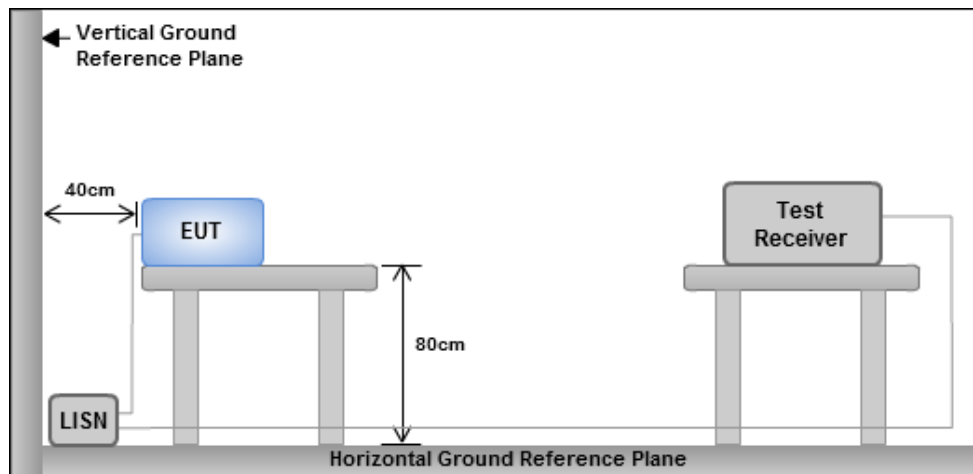

- Note: 1. Support units were connected to second LISN.
 2. Both of LISNs (AMN) are 80 cm from EUT and at least 80 cm from other units and other metal planes

3.6.4 Test Results

Refer to Appendix F.

4 Test laboratory information

Established in 2012, ICC provides foremost EMC & RF Testing and advisory consultation services by our skilled engineers and technicians. Our services employ a wide variety of advanced edge test equipment and one of the widest certification extents in the business.

International Certification Corporation (EMC and Wireless Communication Laboratory), it is our definitive objective is to institute long term, trust-based associations with our clients. The expectation we set up with our clients is based on outstanding service, practical expertise and devotion to a certified value structure. Our passion is to grant our clients with best EMC / RF services by oriented knowledgeable and accommodating staff.

Our Test sites are located at Linkou District and Kwei Shan District. Location map can be found on our website <http://www.icertifi.com.tw>.

Linkou

Tel: 886-2-2601-1640

No.30-2, Ding Fwu Tsuen, Lin Kou
District, New Taipei City, Taiwan
(R.O.C.)

Kwei Shan

Tel: 886-3-271-8666

No.3-1, Lane 6, Wen San 3rd
St., Kwei Shan Dist., Tao Yuan
City 33381, Taiwan (R.O.C.)
No.2-1, Lane 6, Wen San 3rd
St., Kwei Shan Dist., Tao Yuan
City 33381, Taiwan (R.O.C.)

Kwei Shan Site II

Tel: 886-3-271-8640

No.14-1, Lane 19, Wen San 3rd
St., Kwei Shan Dist., Tao Yuan
City 33381, Taiwan (R.O.C.)

If you have any suggestion, please feel free to contact us as below information.

Tel: 886-3-271-8666

Fax: 886-3-318-0155

Email: ICC_Service@icertifi.com.tw

==END==



Summary

Mode	Max-N dB (Hz)	Max-OBW (Hz)	ITU-Code	Min-N dB (Hz)	Min-OBW (Hz)
2.4-2.4835GHz	-	-	-	-	-
BT-LE(1Mbps)	930k	1.705M	1M71F1D	786.25k	1.309M
BT-LE(2Mbps)	1.88M	2.879M	2M88F1D	1.405M	2.564M

Max-N dB = Maximum 6dB down bandwidth; Max-OBW = Maximum 99% occupied bandwidth;
Min-N dB = Minimum 6dB down bandwidth; Min-OBW = Minimum 99% occupied bandwidth

Result

Mode	Result	Limit (Hz)	Port 1-N dB (Hz)	Port 1-OBW (Hz)
BT-LE(1Mbps)	-	-	-	-
2402MHz	Pass	500k	786.25k	1.309M
2440MHz	Pass	500k	930k	1.705M
2480MHz	Pass	500k	886.25k	1.379M
BT-LE(2Mbps)	-	-	-	-
2404MHz	Pass	500k	1.405M	2.564M
2440MHz	Pass	500k	1.88M	2.879M
2478MHz	Pass	500k	1.778M	2.701M

Port X-N dB = Port X 6dB down bandwidth;
Port X-OBW = Port X 99% occupied bandwidth



2.4-2.4835GHz_BT-LE(1Mbps)

EBW-DTS

2402MHz

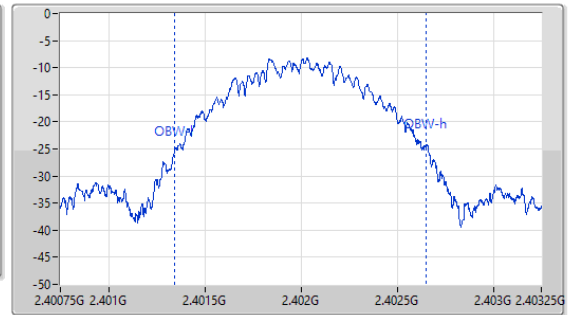
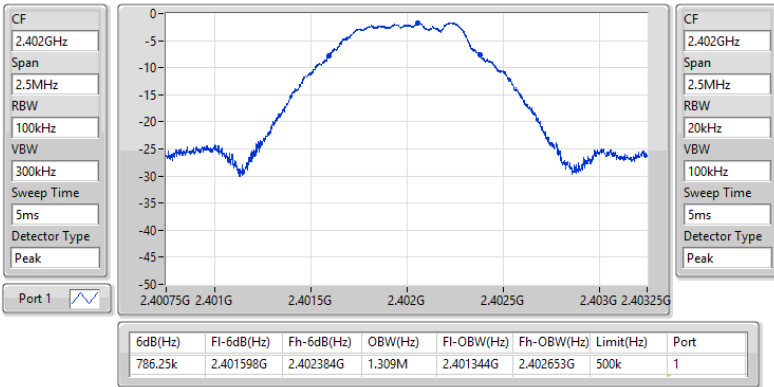

2.4-2.4835GHz_BT-LE(1Mbps)

EBW-DTS

2440MHz

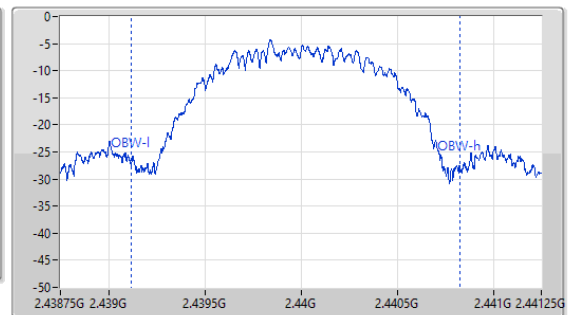
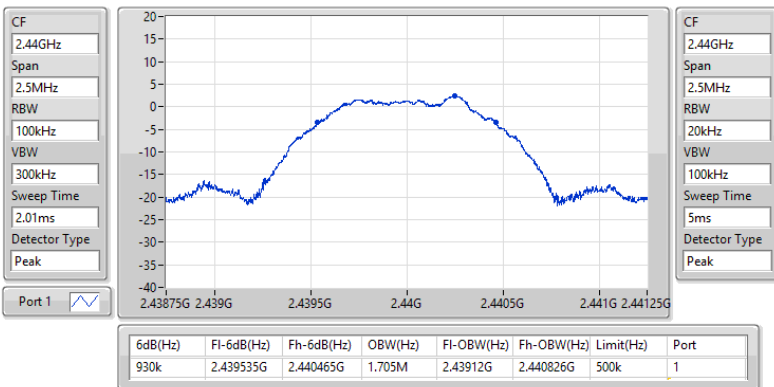



2.4-2.4835GHz_BT-LE(1Mbps)

EBW-DTS

2480MHz

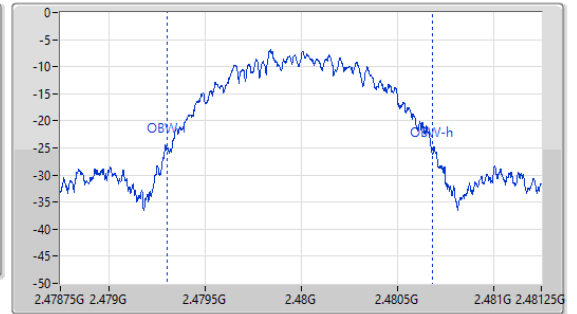
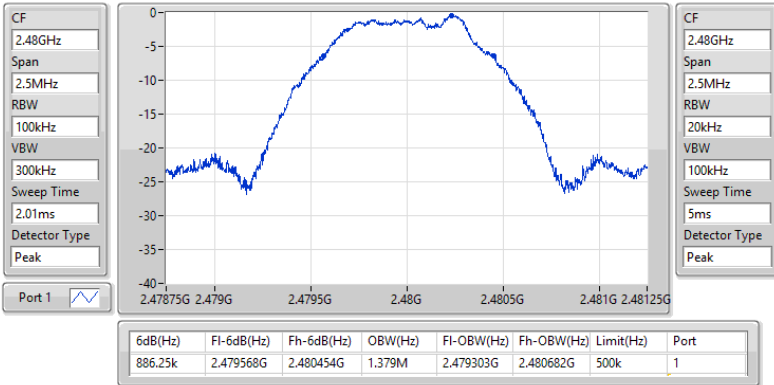

2.4-2.4835GHz_BT-LE(2Mbps)

EBW-DTS

2404MHz

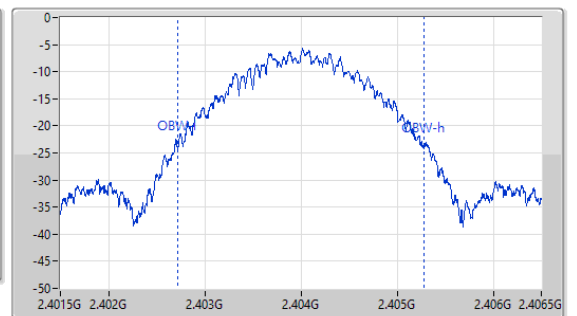
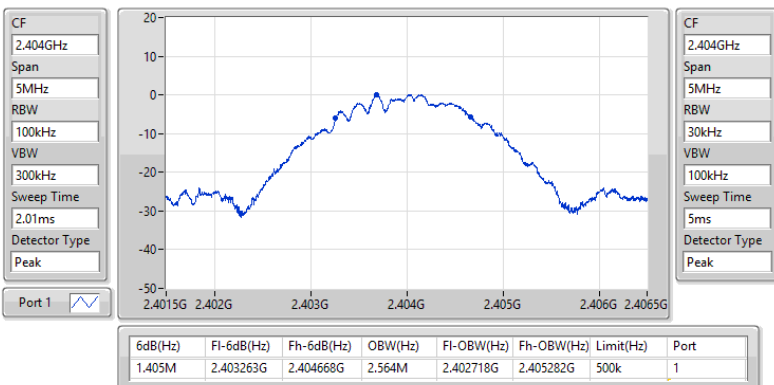



2.4-2.4835GHz_BT-LE(2Mbps)

EBW-DTS

2440MHz

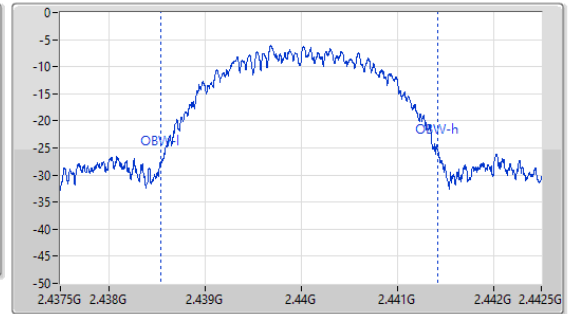
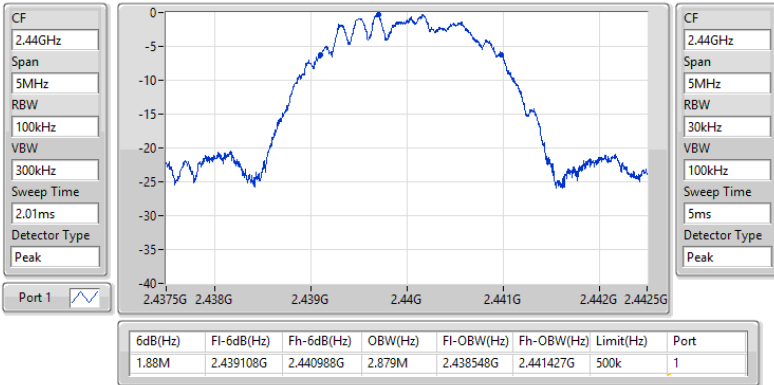

2.4-2.4835GHz_BT-LE(2Mbps)

EBW-DTS

2478MHz

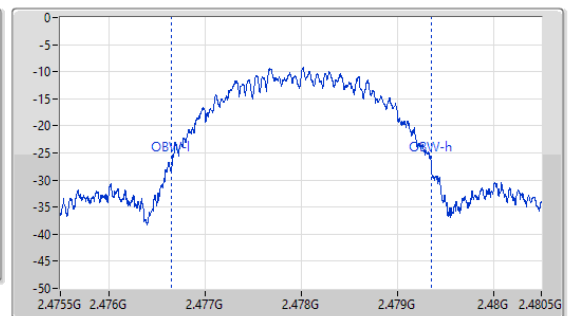
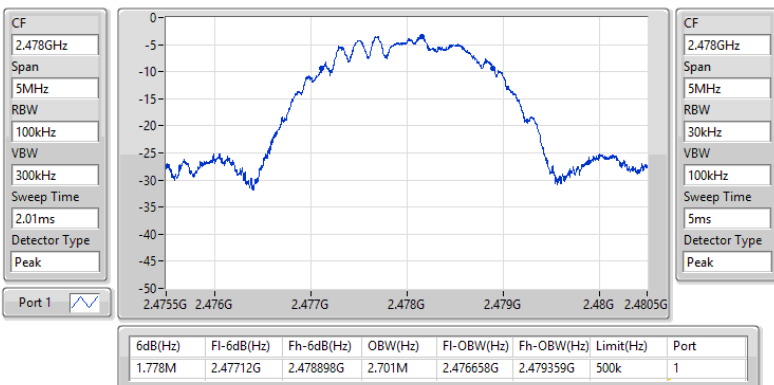



Conducted Output Power (Peak)

Appendix B.1

Summary

Mode	Total Power (dBm)	Power (W)
2.4-2.4835GHz	-	-
BT-LE(1Mbps)	4.16	0.00261
BT-LE(2Mbps)	4.29	0.00269

Result

Mode	Result	Antenna Gain (dBi)	Total Power (dBm)	Power Limit (dBm)	EIRP (dBm)	EIRP Limit (dBm)
BT-LE(1Mbps)	-	-	-	-	-	-
2402MHz	Pass	-6.31	-0.04	30.00	-6.35	36.00
2440MHz	Pass	-6.31	4.16	30.00	-2.15	36.00
2480MHz	Pass	-6.31	1.22	30.00	-5.09	36.00
BT-LE(2Mbps)	-	-	-	-	-	-
2404MHz	Pass	-6.31	3.64	30.00	-2.67	36.00
2440MHz	Pass	-6.31	4.29	30.00	-2.02	36.00
2478MHz	Pass	-6.31	1.63	30.00	-4.68	36.00



Conducted Output Power (Average)

Appendix B.2

Summary

Mode	Total Power (dBm)	Power (W)
2.4-2.4835GHz	-	-
BT-LE(1Mbps)	4.03	0.00253
BT-LE(2Mbps)	4.17	0.00261

Result

Mode	Result	Antenna Gain (dBi)	Total Power (dBm)	Power Limit (dBm)	EIRP (dBm)	EIRP Limit (dBm)
BT-LE(1Mbps)	-	-	-	-	-	-
2402MHz	Pass	-6.31	-0.18	-	-6.49	-
2440MHz	Pass	-6.31	4.03	-	-2.28	-
2480MHz	Pass	-6.31	1.10	-	-5.21	-
BT-LE(2Mbps)	-	-	-	-	-	-
2404MHz	Pass	-6.31	3.51	-	-2.80	-
2440MHz	Pass	-6.31	4.17	-	-2.14	-
2478MHz	Pass	-6.31	1.49	-	-4.82	-

Note: Average power is for reference only.



Summary

Mode	PD (dBm/3kHz)
2.4-2.4835GHz	-
BT-LE(1Mbps)	-14.25
BT-LE(2Mbps)	-13.80

Result

Mode	Result	Antenna Gain (dBi)	Power Density (dBm/3kHz)	Power Density Limit (dBm/3kHz)
BT-LE(1Mbps)	-	-	-	-
2402MHz	Pass	-6.31	-17.67	8.00
2440MHz	Pass	-6.31	-14.25	8.00
2480MHz	Pass	-6.31	-16.02	8.00
BT-LE(2Mbps)	-	-	-	-
2404MHz	Pass	-6.31	-13.80	8.00
2440MHz	Pass	-6.31	-14.07	8.00
2478MHz	Pass	-6.31	-17.51	8.00

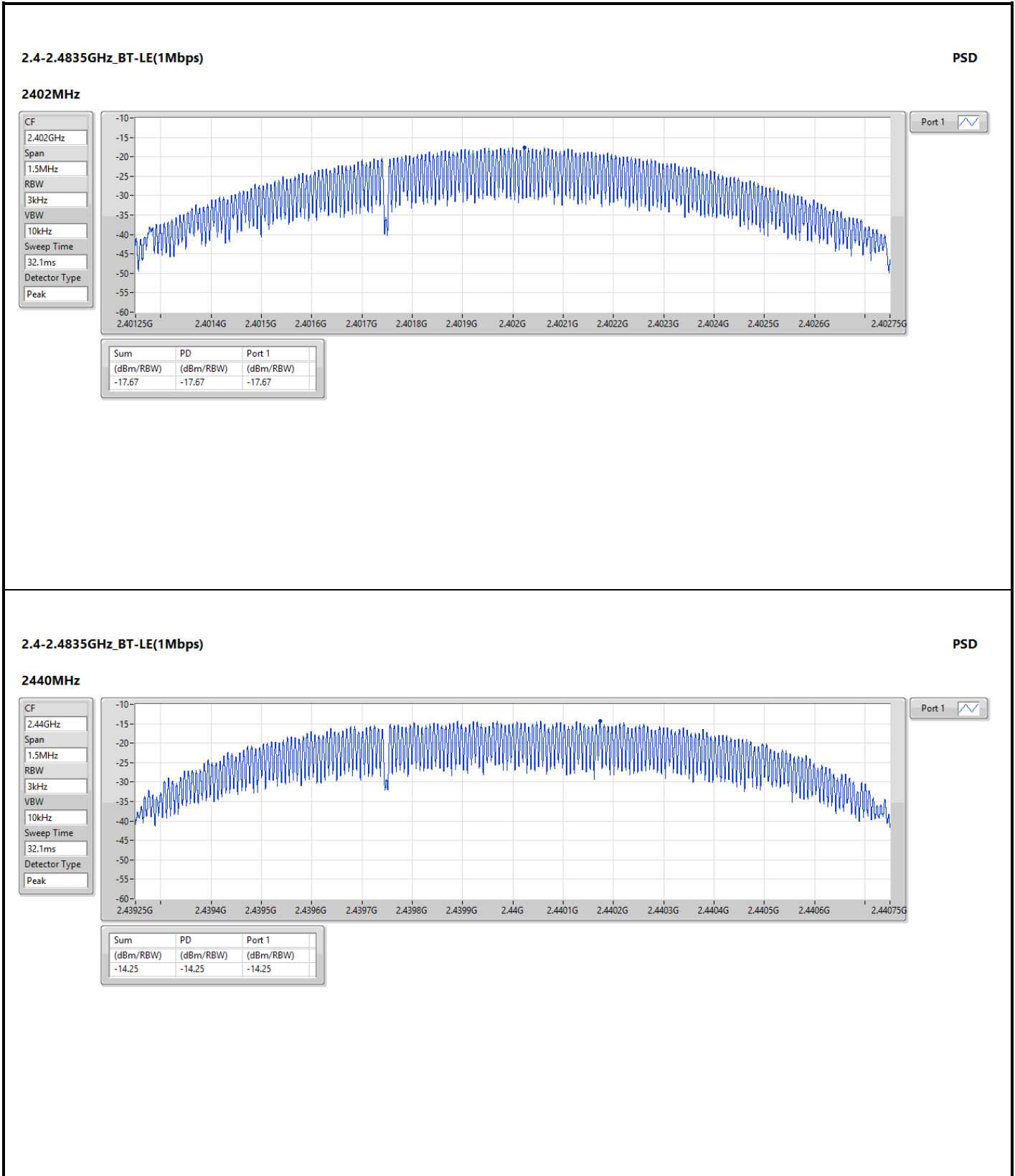

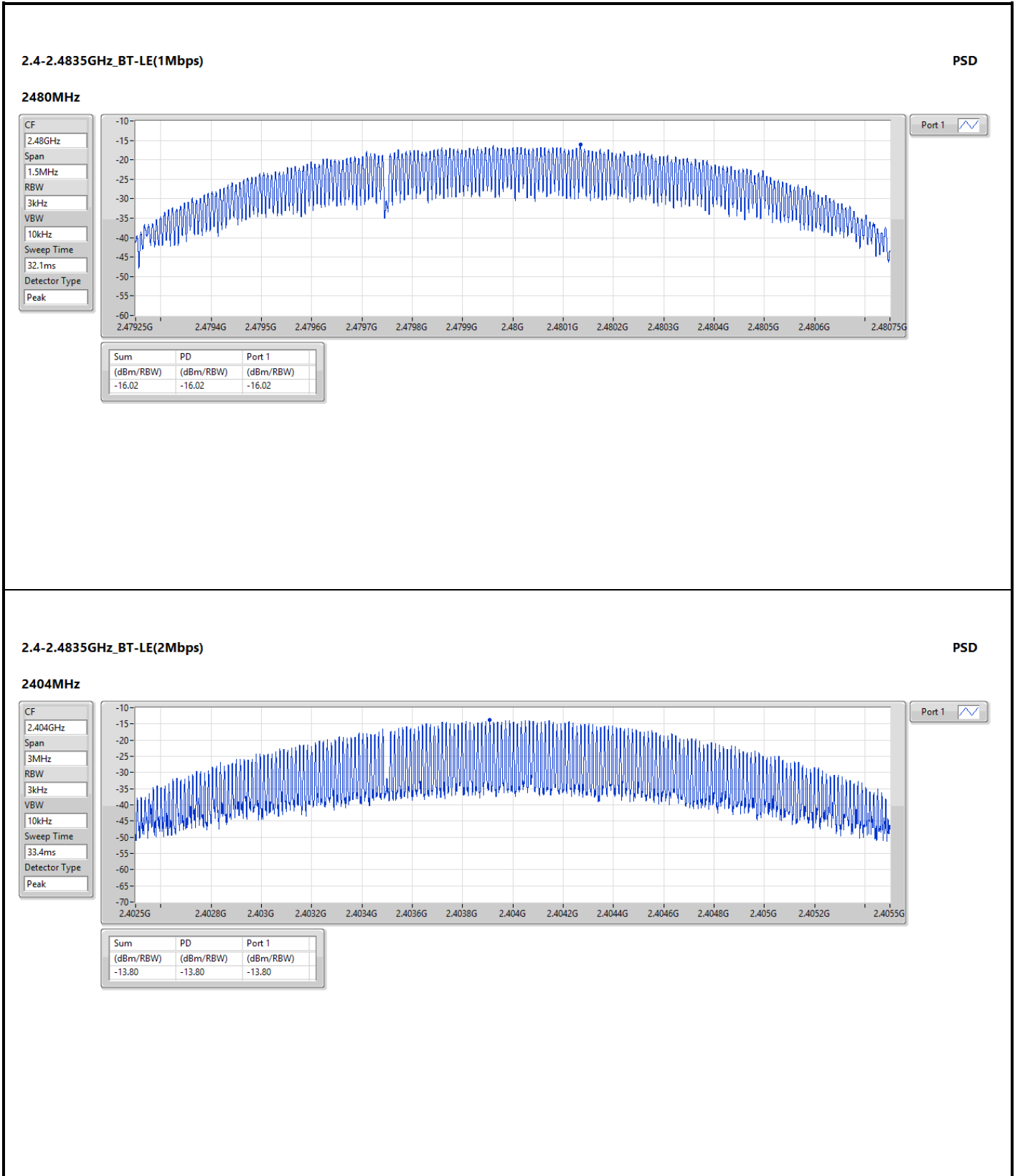

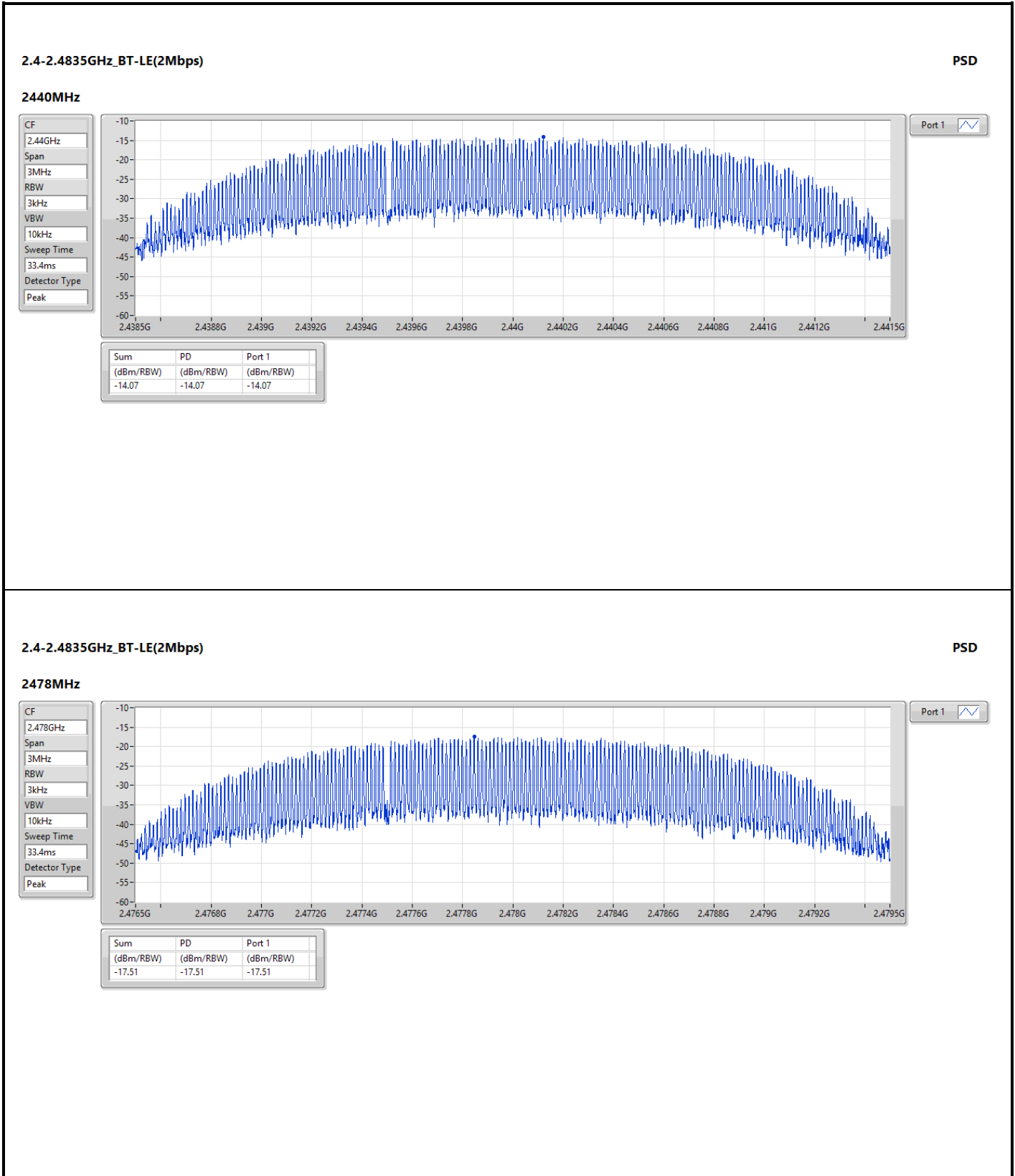



Summary

Mode	Result	Type	Freq (Hz)	Level (dBuV/m)	Limit (dBuV/m)	Margin (dB)	Condition
Mode 1	Pass	PK	38.64M	25.13	40.00	-14.87	Vertical
Mode 2	Pass	PK	31.41M	34.36	40.00	-5.64	Vertical



Mode 1

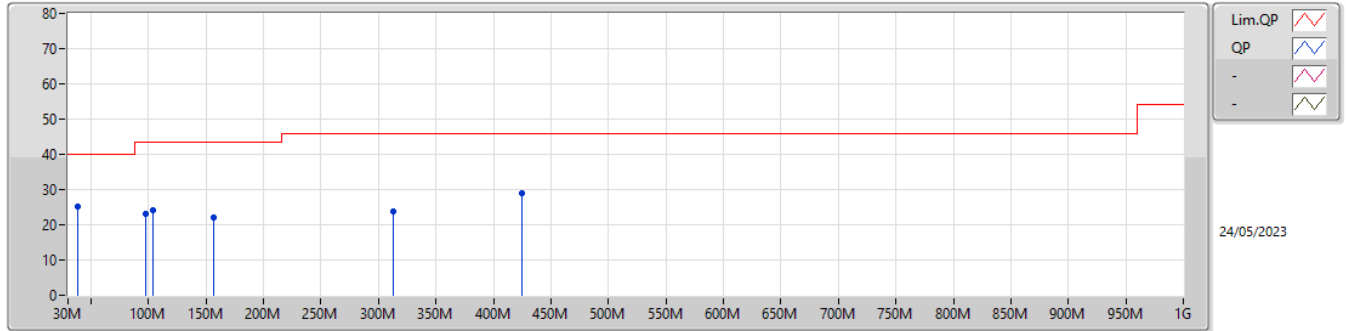

Type	Freq (Hz)	Level (dBuV/m)	Limit (dBuV/m)	Margin (dB)	Factor (dB/m)	Dist (m)	Condition	Azimuth (°)	Height (m)	Comment	Raw (dBuV/m)	AF (dB/m)	CL (dB)	PA (dB)
PK	38.64M	25.13	40.00	-14.87	-8.81	3	Vertical	-	-	-	33.94	18.60	0.61	28.02
PK	97.56M	23.17	43.50	-20.33	-13.69	3	Vertical	-	-	-	36.86	13.76	0.92	28.37
PK	104.26M	24.03	43.50	-19.47	-12.50	3	Vertical	-	-	-	36.53	14.95	0.93	28.38
PK	156.27M	22.01	43.50	-21.49	-8.94	3	Vertical	-	-	-	30.95	18.37	1.10	28.41
PK	312.36M	23.83	46.00	-22.17	-7.71	3	Vertical	-	-	-	31.54	19.09	1.61	28.41
PK	425.23M	29.11	46.00	-16.89	-4.86	3	Vertical	-	-	-	33.97	21.60	1.85	28.31



Mode 1

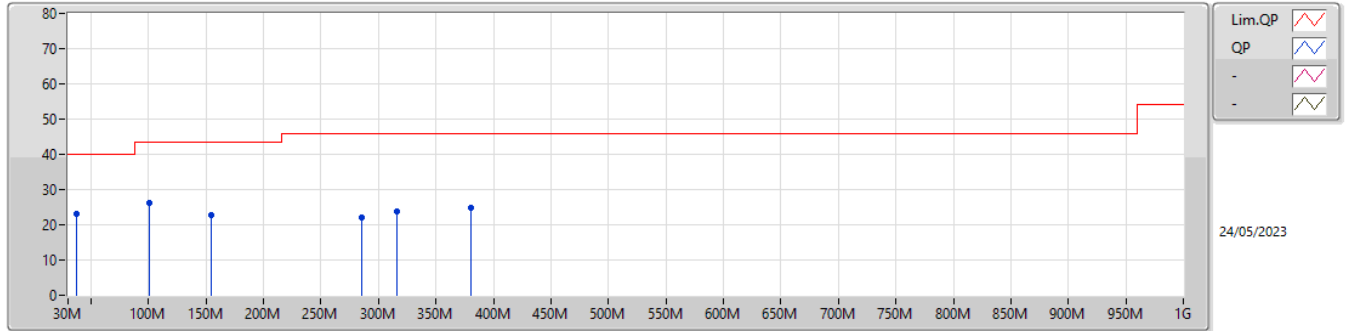

Type	Freq (Hz)	Level (dBuV/m)	Limit (dBuV/m)	Margin (dB)	Factor (dB/m)	Dist (m)	Condition	Azimuth (°)	Height (m)	Comment	Raw (dBuV/m)	AF (dB/m)	CL (dB)	PA (dB)
PK	37.53M	23.10	40.00	-16.90	-8.90	3	Horizontal	-	-	-	32.00	18.51	0.60	28.01
PK	100.62M	26.11	43.50	-17.39	-13.21	3	Horizontal	-	-	-	39.32	14.25	0.92	28.38
PK	154.52M	22.81	43.50	-20.69	-8.82	3	Horizontal	-	-	-	31.63	18.50	1.09	28.41
PK	285.22M	22.06	46.00	-23.94	-8.48	3	Horizontal	-	-	-	30.54	18.40	1.54	28.42
PK	315.55M	23.81	46.00	-22.19	-7.58	3	Horizontal	-	-	-	31.39	19.21	1.62	28.41
PK	380.27M	24.86	46.00	-21.14	-5.98	3	Horizontal	-	-	-	30.84	20.61	1.76	28.35



Mode 2

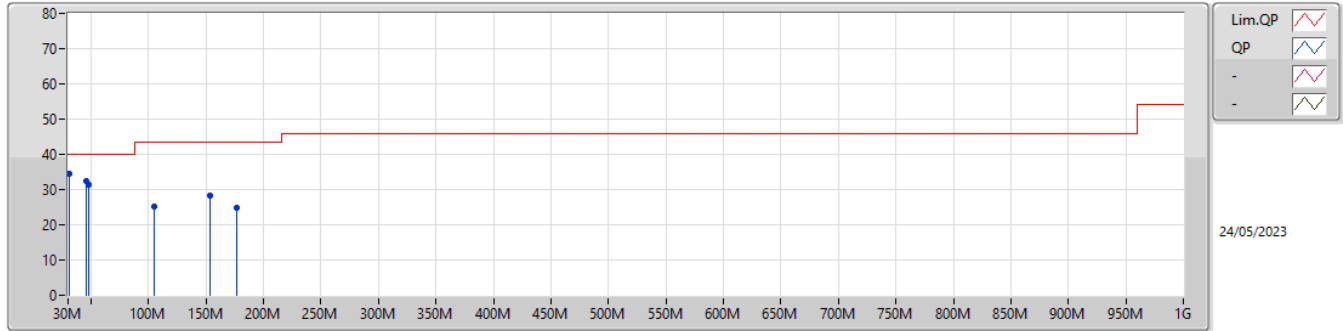

Type	Freq (Hz)	Level (dBuV/m)	Limit (dBuV/m)	Margin (dB)	Factor (dB/m)	Dist (m)	Condition	Azimuth (°)	Height (m)	Comment	Raw (dBuV/m)	AF (dB/m)	CL (dB)	PA (dB)
PK	31.41M	34.36	40.00	-5.64	-9.76	3	Vertical	-	-	-	44.12	17.65	0.57	27.98
PK	45.46M	32.50	40.00	-7.50	-8.15	3	Vertical	-	-	-	40.65	19.25	0.66	28.06
PK	48.28M	31.38	40.00	-8.62	-8.10	3	Vertical	-	-	-	39.48	19.27	0.70	28.07
PK	104.51M	25.20	43.50	-18.30	-12.44	3	Vertical	-	-	-	37.64	15.00	0.94	28.38
PK	153.71M	28.32	43.50	-15.18	-8.95	3	Vertical	-	-	-	37.27	18.37	1.09	28.41
PK	176.2M	24.71	43.50	-18.79	-9.96	3	Vertical	-	-	-	34.67	17.28	1.19	28.43



Mode 2

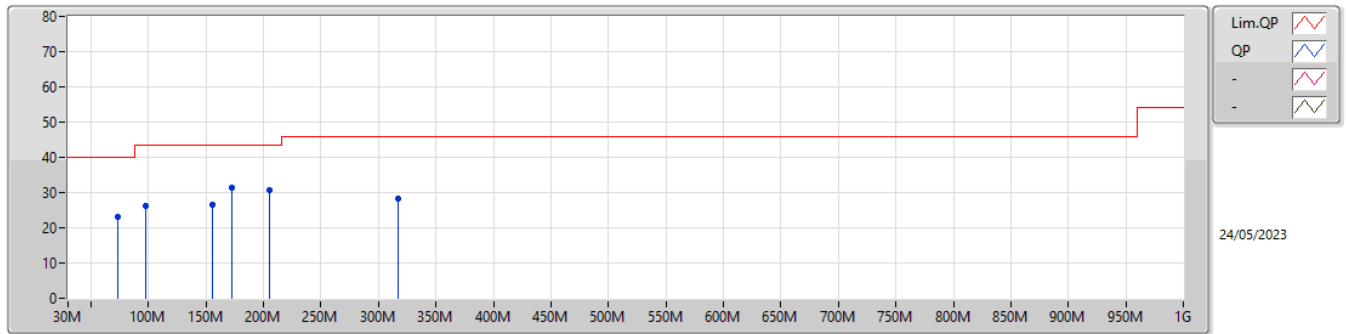

Type	Freq (Hz)	Level (dBuV/m)	Limit (dBuV/m)	Margin (dB)	Factor (dB/m)	Dist (m)	Condition	Azimuth (°)	Height (m)	Comment	Raw (dBuV/m)	AF (dB/m)	CL (dB)	PA (dB)
PK	73.58M	23.21	40.00	-16.79	-12.06	3	Horizontal	-	-	-	35.27	15.33	0.83	28.22
PK	97.48M	26.10	43.50	-17.40	-13.70	3	Horizontal	-	-	-	39.80	13.75	0.91	28.36
PK	155.12M	26.65	43.50	-16.85	-8.74	3	Horizontal	-	-	-	35.39	18.58	1.09	28.41
PK	171.99M	31.22	43.50	-12.28	-9.45	3	Horizontal	-	-	-	40.67	17.80	1.17	28.42
PK	205.72M	30.78	43.50	-12.72	-11.90	3	Horizontal	-	-	-	42.68	15.20	1.34	28.44
PK	316.78M	28.16	46.00	-17.84	-7.54	3	Horizontal	-	-	-	35.70	19.24	1.62	28.40



**Unwanted Emissions into Restricted Frequency Bands
Above 1GHz**

Appendix D.2

Summary

Mode	Result	Type	Freq (Hz)	Level (dBuV/m)	Limit (dBuV/m)	Margin (dB)	Dist (m)	Condition	Azimuth (°)	Height (m)	Comments
2.4-2.4835GHz	-	-	-	-	-	-	-	-	-	-	-
BT-LE(1Mbps)	Pass	AV	12.01G	42.35	54.00	-11.65	3	Horizontal	21	1.00	-
BT-LE(2Mbps)	Pass	AV	2.4835G	44.17	54.00	-9.83	3	Vertical	359	2.24	-



2.4-2.4835GHz_BT-LE(1Mbps)

2402MHz_TX

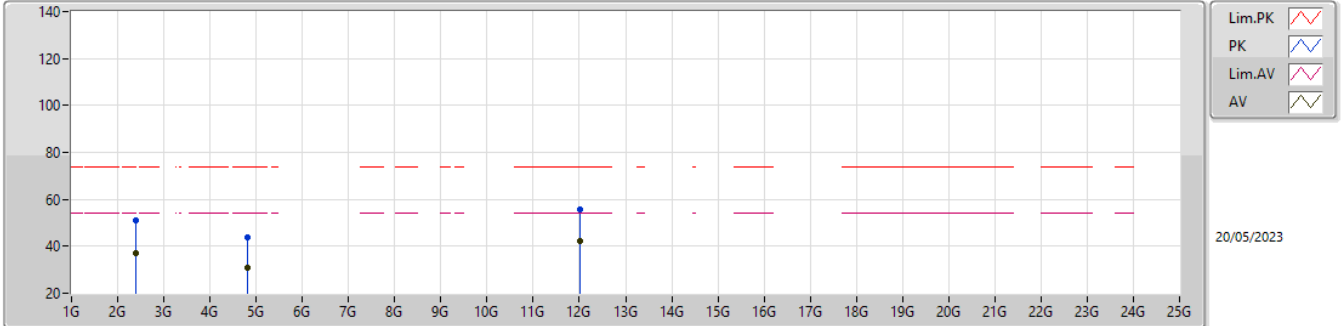

Type	Freq (Hz)	Level (dBuV/m)	Limit (dBuV/m)	Margin (dB)	Raw (dBuV)	Dist (m)	Condition	Azimuth (°)	Height (m)	Comment	AF (dB)	CL (dB)	PA (dB)
PK	2.39G	51.00	74.00	-23.00	55.65	3	Vertical	355	2.55	-	27.72	4.67	37.04
AV	2.39G	37.11	54.00	-16.89	41.76	3	Vertical	355	2.55	-	27.72	4.67	37.04
PK	4.804G	43.79	74.00	-30.21	44.31	3	Vertical	15	1.00	-	31.40	6.71	38.63
AV	4.804G	30.62	54.00	-23.38	31.14	3	Vertical	15	1.00	-	31.40	6.71	38.63
PK	12.01G	55.62	74.00	-18.38	49.49	3	Vertical	8	1.00	-	39.45	9.71	43.03
AV	12.01G	42.14	54.00	-11.86	36.01	3	Vertical	8	1.00	-	39.45	9.71	43.03



2.4-2.4835GHz_BT-LE(1Mbps)

2402MHz_TX

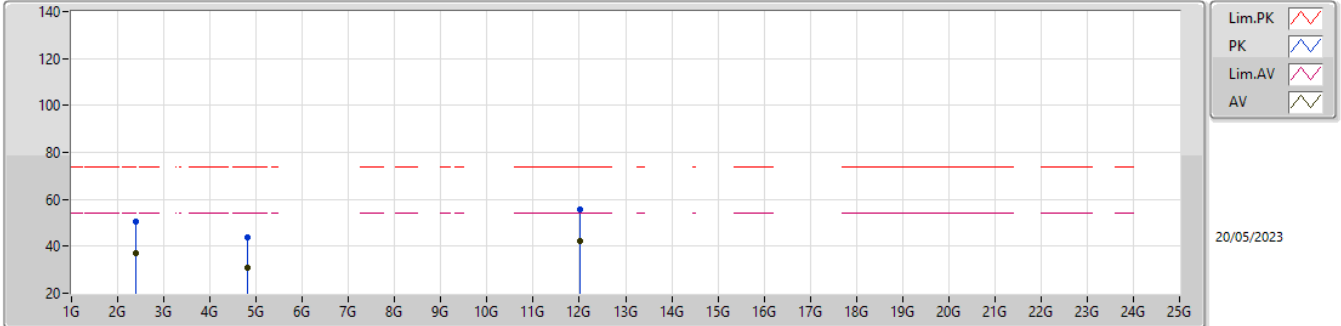

Type	Freq (Hz)	Level (dBuV/m)	Limit (dBuV/m)	Margin (dB)	Raw (dBuV)	Dist (m)	Condition	Azimuth (°)	Height (m)	Comment	AF (dB)	CL (dB)	PA (dB)
PK	2.39G	50.41	74.00	-23.59	55.06	3	Horizontal	342	1.66	-	27.72	4.67	37.04
AV	2.39G	37.12	54.00	-16.88	41.77	3	Horizontal	342	1.66	-	27.72	4.67	37.04
PK	4.804G	44.03	74.00	-29.97	44.55	3	Horizontal	18	1.00	-	31.40	6.71	38.63
AV	4.804G	30.68	54.00	-23.32	31.20	3	Horizontal	18	1.00	-	31.40	6.71	38.63
PK	12.01G	55.85	74.00	-18.15	49.72	3	Horizontal	21	1.00	-	39.45	9.71	43.03
AV	12.01G	42.35	54.00	-11.65	36.22	3	Horizontal	21	1.00	-	39.45	9.71	43.03



2.4-2.4835GHz_BT-LE(1Mbps)

2440MHz_TX

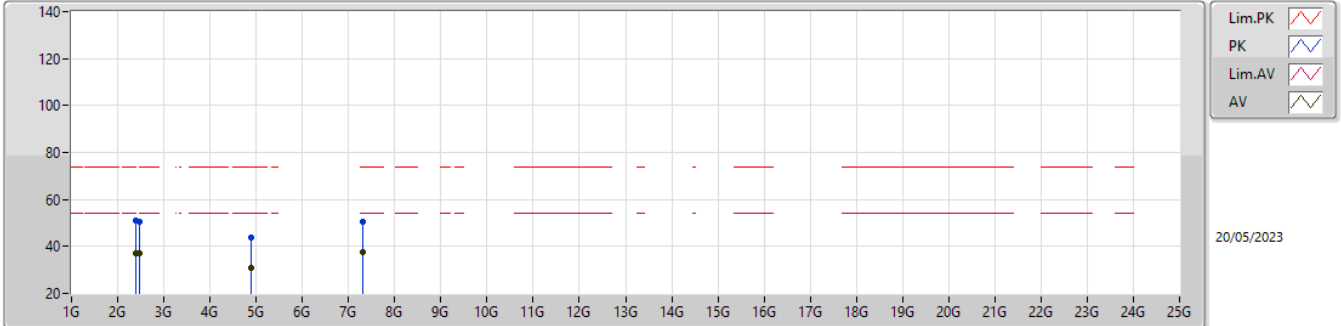

Type	Freq (Hz)	Level (dBuV/m)	Limit (dBuV/m)	Margin (dB)	Raw (dBuV)	Dist (m)	Condition	Azimuth (°)	Height (m)	Comment	AF (dB)	CL (dB)	PA (dB)
PK	2.39G	51.10	74.00	-22.90	55.75	3	Vertical	352	2.26	-	27.72	4.67	37.04
AV	2.39G	37.04	54.00	-16.96	41.69	3	Vertical	352	2.26	-	27.72	4.67	37.04
PK	2.4835G	50.52	74.00	-23.48	55.41	3	Vertical	352	2.26	-	27.50	4.73	37.12
AV	2.4835G	37.14	54.00	-16.86	42.03	3	Vertical	352	2.26	-	27.50	4.73	37.12
PK	4.88G	43.81	74.00	-30.19	44.35	3	Vertical	24	1.00	-	31.40	6.74	38.68
AV	4.88G	31.01	54.00	-22.99	31.55	3	Vertical	24	1.00	-	31.40	6.74	38.68
PK	7.32G	50.60	74.00	-23.40	45.41	3	Vertical	11	1.00	-	36.46	8.23	39.50
AV	7.32G	37.55	54.00	-16.45	32.36	3	Vertical	11	1.00	-	36.46	8.23	39.50



2.4-2.4835GHz_BT-LE(1Mbps)

2440MHz_TX

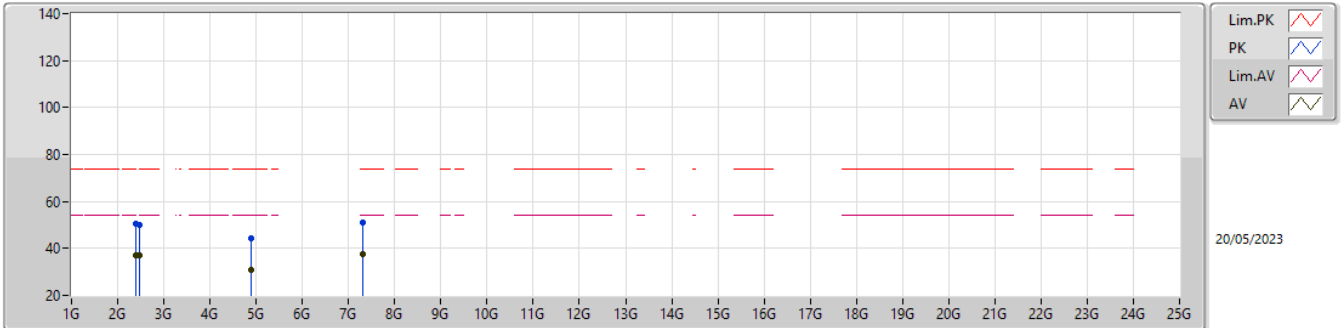

Type	Freq (Hz)	Level (dBuV/m)	Limit (dBuV/m)	Margin (dB)	Raw (dBuV)	Dist (m)	Condition	Azimuth (°)	Height (m)	Comment	AF (dB)	CL (dB)	PA (dB)
PK	2.39G	50.50	74.00	-23.50	55.15	3	Horizontal	336	1.65	-	27.72	4.67	37.04
AV	2.39G	36.99	54.00	-17.01	41.64	3	Horizontal	336	1.65	-	27.72	4.67	37.04
PK	2.4835G	50.15	74.00	-23.85	55.04	3	Horizontal	336	1.65	-	27.50	4.73	37.12
AV	2.4835G	36.92	54.00	-17.08	41.81	3	Horizontal	336	1.65	-	27.50	4.73	37.12
PK	4.88G	44.21	74.00	-29.79	44.75	3	Horizontal	28	1.00	-	31.40	6.74	38.68
AV	4.88G	31.07	54.00	-22.93	31.61	3	Horizontal	28	1.00	-	31.40	6.74	38.68
PK	7.32G	50.88	74.00	-23.12	45.69	3	Horizontal	44	1.00	-	36.46	8.23	39.50
AV	7.32G	37.44	54.00	-16.56	32.25	3	Horizontal	44	1.00	-	36.46	8.23	39.50



2.4-2.4835GHz_BT-LE(1Mbps)

2480MHz_TX

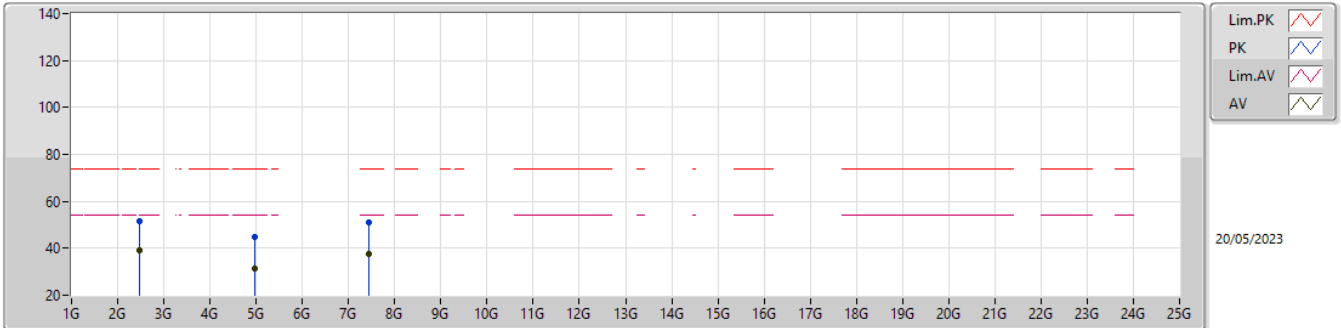

Type	Freq (Hz)	Level (dBuV/m)	Limit (dBuV/m)	Margin (dB)	Raw (dBuV)	Dist (m)	Condition	Azimuth (°)	Height (m)	Comment	AF (dB)	CL (dB)	PA (dB)
PK	2.4835G	51.63	74.00	-22.37	56.52	3	Vertical	353	2.21	-	27.50	4.73	37.12
AV	2.4835G	39.30	54.00	-14.70	44.19	3	Vertical	353	2.21	-	27.50	4.73	37.12
PK	4.96G	44.67	74.00	-29.33	45.11	3	Vertical	25	1.00	-	31.52	6.77	38.73
AV	4.96G	31.38	54.00	-22.62	31.82	3	Vertical	25	1.00	-	31.52	6.77	38.73
PK	7.44G	51.13	74.00	-22.87	46.02	3	Vertical	31	1.00	-	36.48	8.28	39.65
AV	7.44G	37.37	54.00	-16.63	32.26	3	Vertical	31	1.00	-	36.48	8.28	39.65



2.4-2.4835GHz_BT-LE(1Mbps)

2480MHz_TX

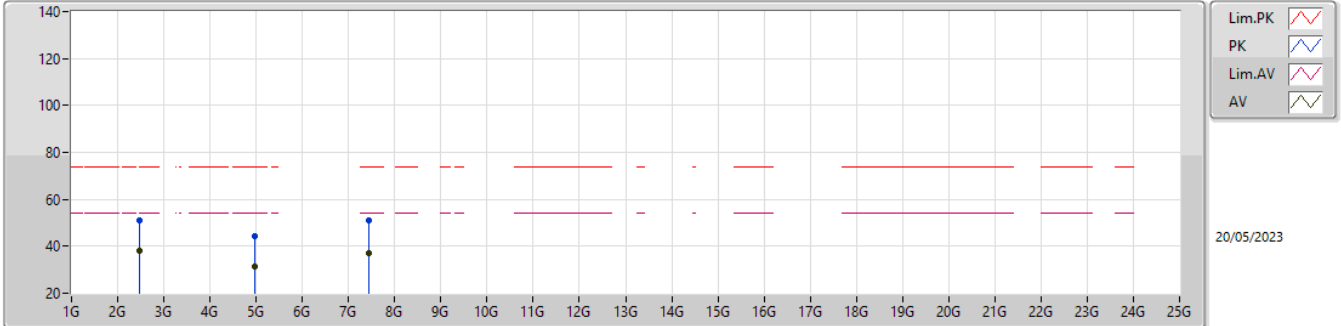

Type	Freq (Hz)	Level (dBuV/m)	Limit (dBuV/m)	Margin (dB)	Raw (dBuV)	Dist (m)	Condition	Azimuth (°)	Height (m)	Comment	AF (dB)	CL (dB)	PA (dB)
PK	2.4835G	51.13	74.00	-22.87	56.02	3	Horizontal	336	1.62	-	27.50	4.73	37.12
AV	2.4835G	37.99	54.00	-16.01	42.88	3	Horizontal	336	1.62	-	27.50	4.73	37.12
PK	4.96G	44.52	74.00	-29.48	44.96	3	Horizontal	14	1.00	-	31.52	6.77	38.73
AV	4.96G	31.47	54.00	-22.53	31.91	3	Horizontal	14	1.00	-	31.52	6.77	38.73
PK	7.44G	51.09	74.00	-22.91	45.98	3	Horizontal	22	1.00	-	36.48	8.28	39.65
AV	7.44G	37.15	54.00	-16.85	32.04	3	Horizontal	22	1.00	-	36.48	8.28	39.65



2.4-2.4835GHz_BT-LE(2Mbps)

2404MHz_TX

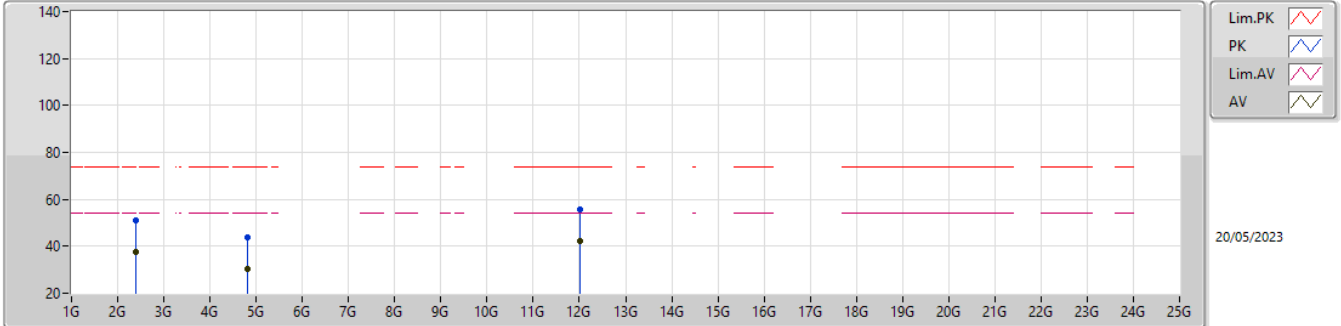

Type	Freq (Hz)	Level (dBuV/m)	Limit (dBuV/m)	Margin (dB)	Raw (dBuV)	Dist (m)	Condition	Azimuth (°)	Height (m)	Comment	AF (dB)	CL (dB)	PA (dB)
PK	2.39G	51.04	74.00	-22.96	55.69	3	Vertical	353	2.56	-	27.72	4.67	37.04
AV	2.39G	37.82	54.00	-16.18	42.47	3	Vertical	353	2.56	-	27.72	4.67	37.04
PK	4.808G	43.72	74.00	-30.28	44.25	3	Vertical	11	1.00	-	31.40	6.71	38.64
AV	4.808G	30.58	54.00	-23.42	31.11	3	Vertical	11	1.00	-	31.40	6.71	38.64
PK	12.02G	55.55	74.00	-18.45	49.38	3	Vertical	26	1.00	-	39.50	9.71	43.04
AV	12.02G	42.12	54.00	-11.88	35.95	3	Vertical	26	1.00	-	39.50	9.71	43.04



2.4-2.4835GHz_BT-LE(2Mbps)

2404MHz_TX

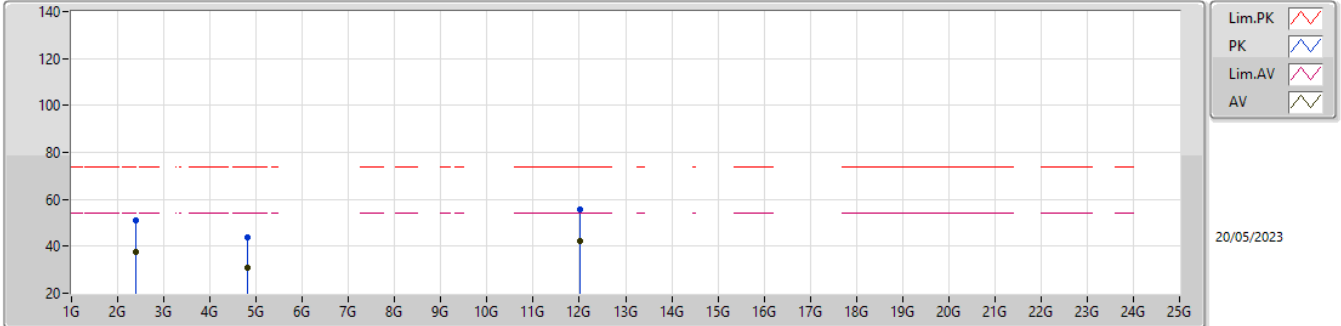

Type	Freq (Hz)	Level (dBuV/m)	Limit (dBuV/m)	Margin (dB)	Raw (dBuV)	Dist (m)	Condition	Azimuth (°)	Height (m)	Comment	AF (dB)	CL (dB)	PA (dB)
PK	2.39G	50.96	74.00	-23.04	55.61	3	Horizontal	343	1.65	-	27.72	4.67	37.04
AV	2.39G	37.65	54.00	-16.35	42.30	3	Horizontal	343	1.65	-	27.72	4.67	37.04
PK	4.808G	43.98	74.00	-30.02	44.51	3	Horizontal	25	1.00	-	31.40	6.71	38.64
AV	4.808G	30.63	54.00	-23.37	31.16	3	Horizontal	25	1.00	-	31.40	6.71	38.64
PK	12.02G	55.86	74.00	-18.14	49.69	3	Horizontal	14	1.00	-	39.50	9.71	43.04
AV	12.02G	42.32	54.00	-11.68	36.15	3	Horizontal	14	1.00	-	39.50	9.71	43.04



2.4-2.4835GHz_BT-LE(2Mbps)

2440MHz_TX

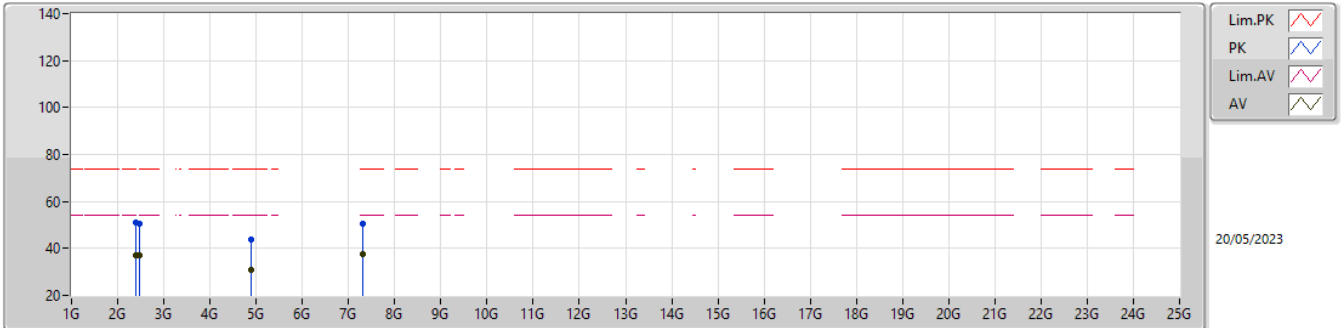

Type	Freq (Hz)	Level (dBuV/m)	Limit (dBuV/m)	Margin (dB)	Raw (dBuV)	Dist (m)	Condition	Azimuth (°)	Height (m)	Comment	AF (dB)	CL (dB)	PA (dB)
PK	2.39G	50.81	74.00	-23.19	55.46	3	Vertical	358	2.28	-	27.72	4.67	37.04
AV	2.39G	37.16	54.00	-16.84	41.81	3	Vertical	358	2.28	-	27.72	4.67	37.04
PK	2.4835G	50.36	74.00	-23.64	55.25	3	Vertical	358	2.28	-	27.50	4.73	37.12
AV	2.4835G	37.22	54.00	-16.78	42.11	3	Vertical	358	2.28	-	27.50	4.73	37.12
PK	4.88G	43.77	74.00	-30.23	44.31	3	Vertical	15	1.00	-	31.40	6.74	38.68
AV	4.88G	30.94	54.00	-23.06	31.48	3	Vertical	15	1.00	-	31.40	6.74	38.68
PK	7.32G	50.65	74.00	-23.35	45.46	3	Vertical	22	1.00	-	36.46	8.23	39.50
AV	7.32G	37.60	54.00	-16.40	32.41	3	Vertical	22	1.00	-	36.46	8.23	39.50



2.4-2.4835GHz_BT-LE(2Mbps)

2440MHz_TX

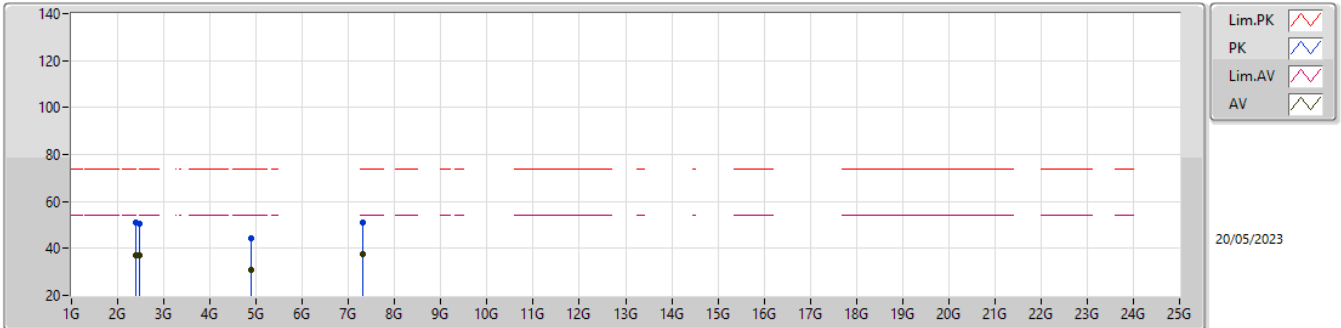

Type	Freq (Hz)	Level (dBuV/m)	Limit (dBuV/m)	Margin (dB)	Raw (dBuV)	Dist (m)	Condition	Azimuth (°)	Height (m)	Comment	AF (dB)	CL (dB)	PA (dB)
PK	2.39G	50.80	74.00	-23.20	55.45	3	Horizontal	339	1.66	-	27.72	4.67	37.04
AV	2.39G	36.97	54.00	-17.03	41.62	3	Horizontal	339	1.66	-	27.72	4.67	37.04
PK	2.4835G	50.49	74.00	-23.51	55.38	3	Horizontal	339	1.66	-	27.50	4.73	37.12
AV	2.4835G	37.15	54.00	-16.85	42.04	3	Horizontal	339	1.66	-	27.50	4.73	37.12
PK	4.88G	44.09	74.00	-29.91	44.63	3	Horizontal	25	1.00	-	31.40	6.74	38.68
AV	4.88G	31.00	54.00	-23.00	31.54	3	Horizontal	25	1.00	-	31.40	6.74	38.68
PK	7.32G	50.84	74.00	-23.16	45.65	3	Horizontal	41	1.00	-	36.46	8.23	39.50
AV	7.32G	37.47	54.00	-16.53	32.28	3	Horizontal	41	1.00	-	36.46	8.23	39.50



2.4-2.4835GHz_BT-LE(2Mbps)

2478MHz_TX

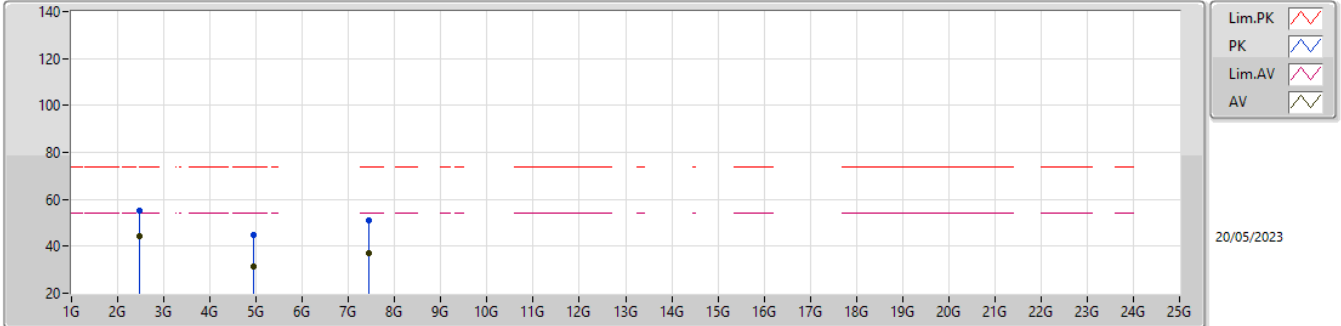

Type	Freq (Hz)	Level (dBuV/m)	Limit (dBuV/m)	Margin (dB)	Raw (dBuV)	Dist (m)	Condition	Azimuth (°)	Height (m)	Comment	AF (dB)	CL (dB)	PA (dB)
PK	2.4835G	55.02	74.00	-18.98	59.91	3	Vertical	359	2.24	-	27.50	4.73	37.12
AV	2.4835G	44.17	54.00	-9.83	49.06	3	Vertical	359	2.24	-	27.50	4.73	37.12
PK	4.956G	44.59	74.00	-29.41	45.05	3	Vertical	22	1.00	-	31.51	6.76	38.73
AV	4.956G	31.32	54.00	-22.68	31.78	3	Vertical	22	1.00	-	31.51	6.76	38.73
PK	7.434G	51.04	74.00	-22.96	45.94	3	Vertical	36	1.00	-	36.47	8.28	39.65
AV	7.434G	37.26	54.00	-16.74	32.16	3	Vertical	36	1.00	-	36.47	8.28	39.65



2.4-2.4835GHz_BT-LE(2Mbps)

2478MHz_TX

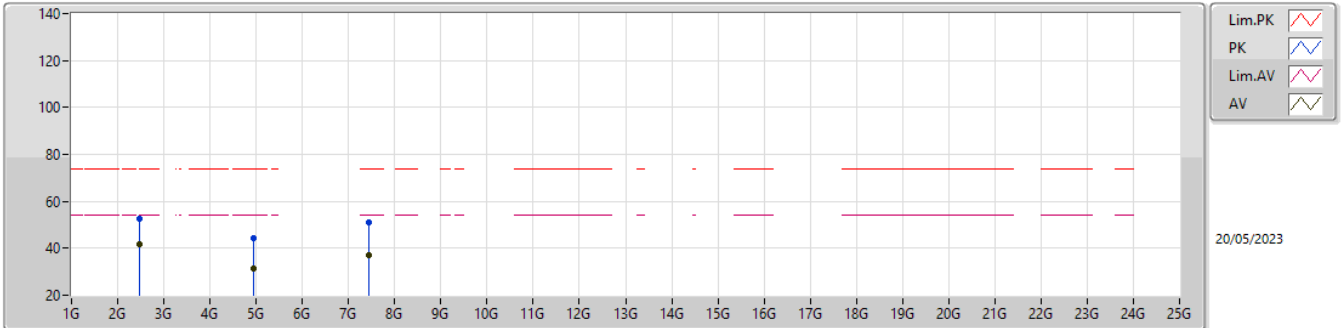

Type	Freq (Hz)	Level (dBuV/m)	Limit (dBuV/m)	Margin (dB)	Raw (dBuV)	Dist (m)	Condition	Azimuth (°)	Height (m)	Comment	AF (dB)	CL (dB)	PA (dB)
PK	2.4835G	52.35	74.00	-21.65	57.24	3	Horizontal	336	1.64	-	27.50	4.73	37.12
AV	2.4835G	41.56	54.00	-12.44	46.45	3	Horizontal	336	1.64	-	27.50	4.73	37.12
PK	4.956G	44.39	74.00	-29.61	44.85	3	Horizontal	18	1.00	-	31.51	6.76	38.73
AV	4.956G	31.36	54.00	-22.64	31.82	3	Horizontal	18	1.00	-	31.51	6.76	38.73
PK	7.434G	51.01	74.00	-22.99	45.91	3	Horizontal	45	1.00	-	36.47	8.28	39.65
AV	7.434G	37.06	54.00	-16.94	31.96	3	Horizontal	45	1.00	-	36.47	8.28	39.65

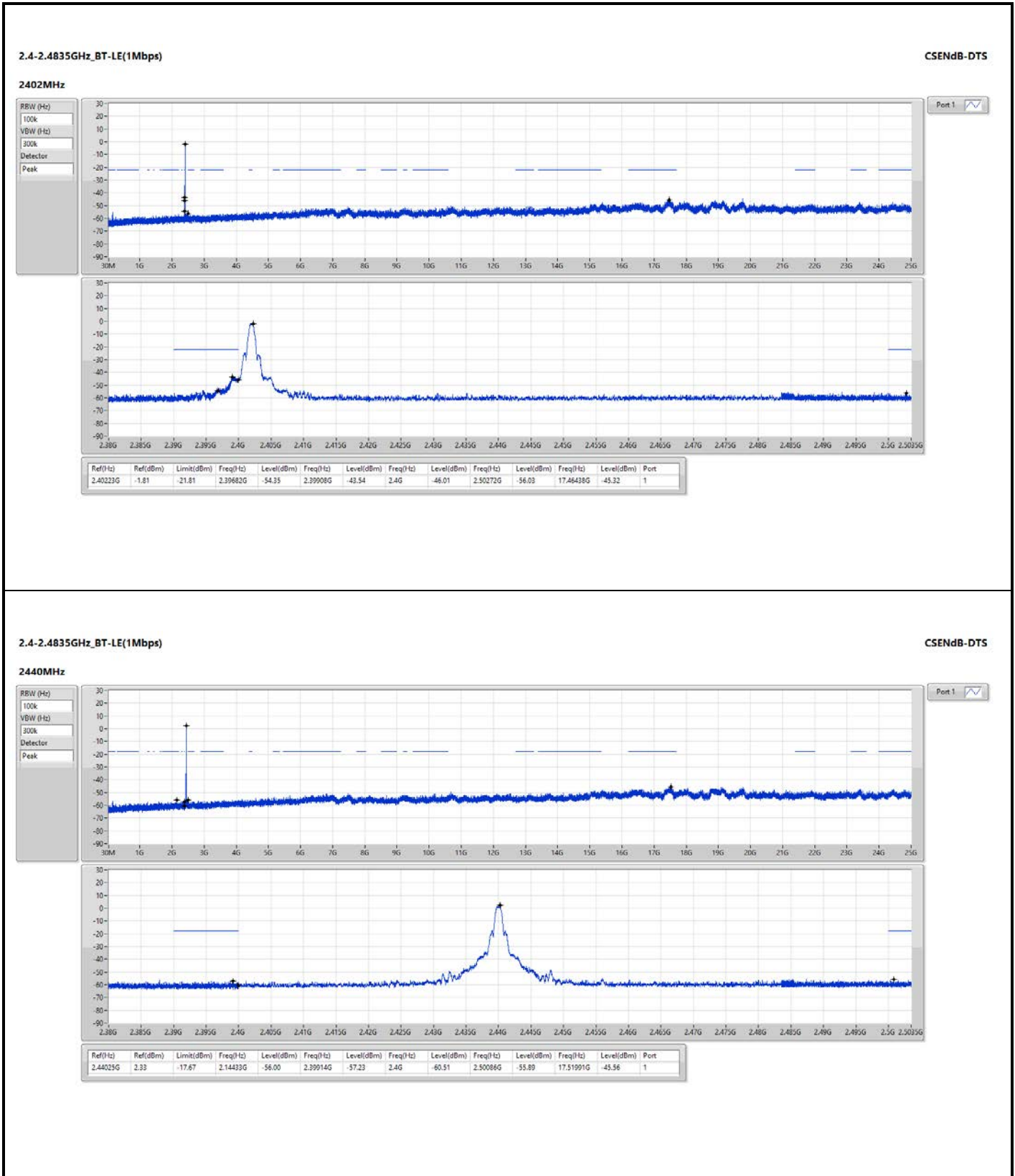

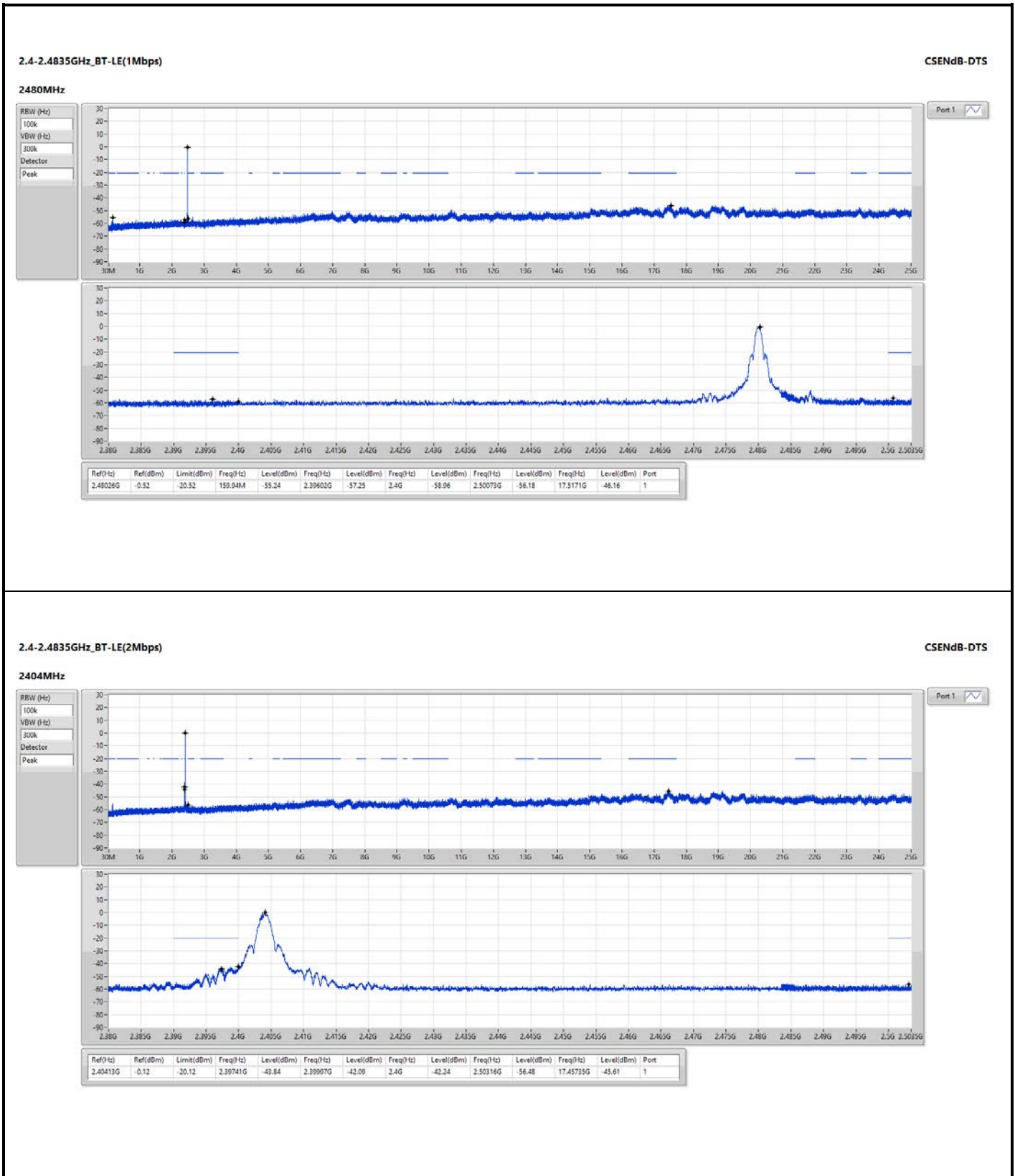

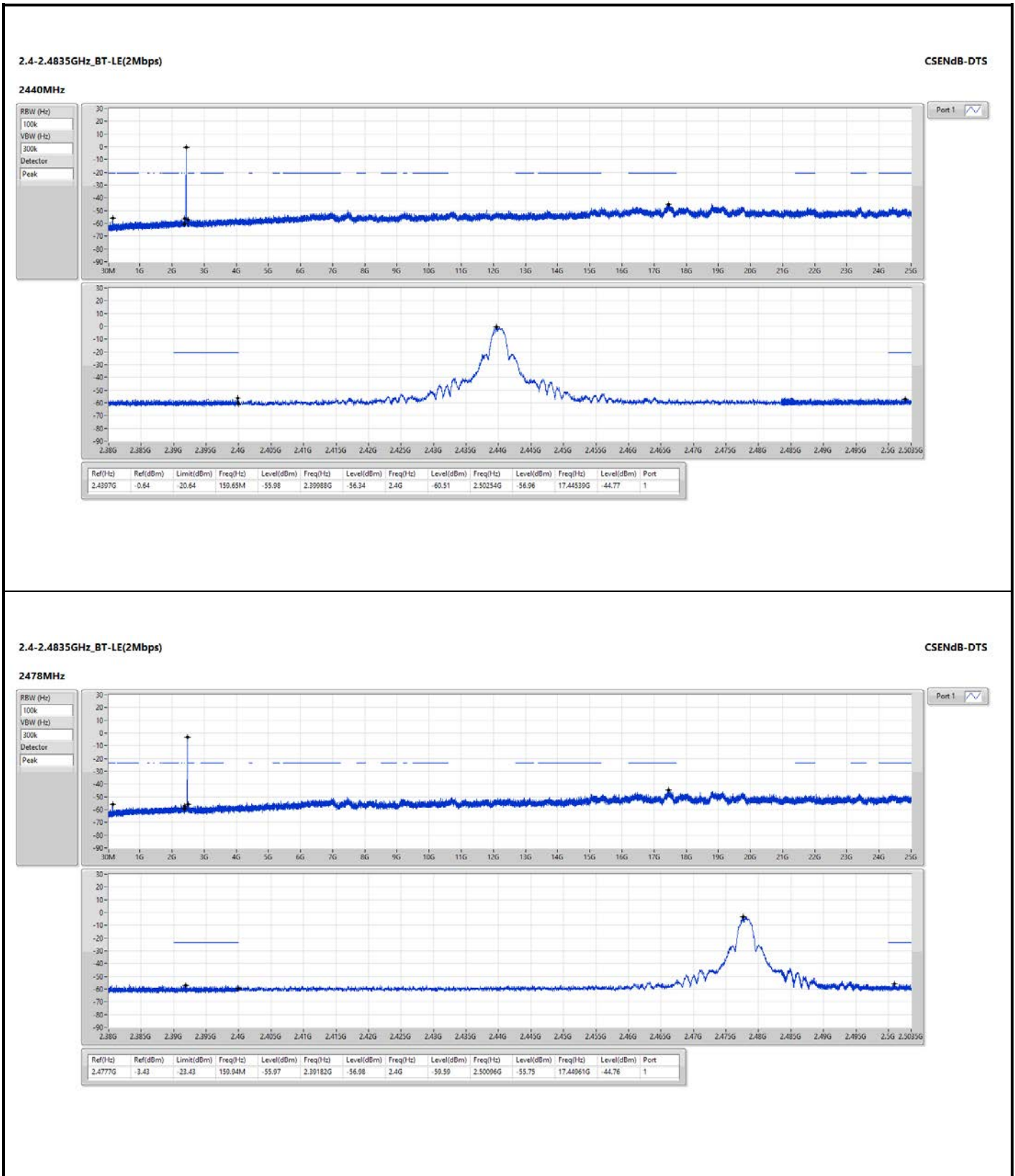



Mode	Charging mode
Power Phase	Line

Test by : Joe Liao Temperature: 21°C Humidity: 63%

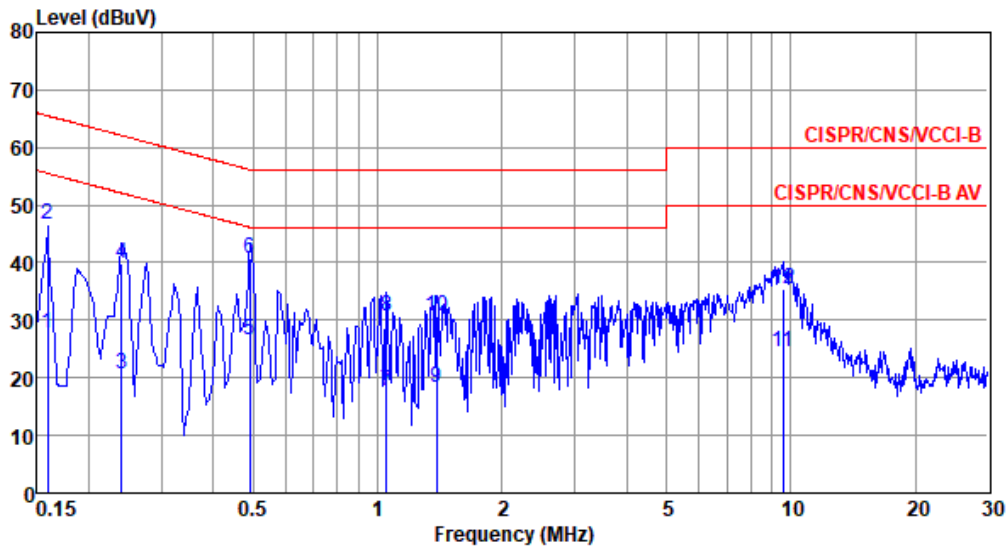

	Freq MHz	Level dBUV	Limit Line dBUV	Over Limit dB	Read Level dBUV	Factor dB	Cable loss dB	Aux dB	Remark
1	0.159	27.63	55.52	-27.89	17.76	9.63	0.06	0.18	Average
2	0.159	46.62	65.52	-18.90	36.75	9.63	0.06	0.18	QP
3	0.240	20.56	52.08	-31.52	10.66	9.62	0.06	0.22	Average
4	0.240	39.87	62.08	-22.21	29.97	9.62	0.06	0.22	QP
5	0.491	26.56	46.14	-19.58	16.56	9.62	0.07	0.31	Average
6*	0.491	40.87	56.14	-15.27	30.87	9.62	0.07	0.31	QP
7	1.049	17.64	46.00	-28.36	7.57	9.63	0.11	0.33	Average
8	1.049	30.58	56.00	-25.42	20.51	9.63	0.11	0.33	QP
9	1.388	18.31	46.00	-27.69	8.22	9.63	0.12	0.34	Average
10	1.388	30.84	56.00	-25.16	20.75	9.63	0.12	0.34	QP
11	9.552	24.43	50.00	-25.57	13.95	9.69	0.35	0.44	Average
12	9.552	35.37	60.00	-24.63	24.89	9.69	0.35	0.44	QP

Note 1: Level (dBUV) = Read Level (dBUV) + LISN Factor (dB) + Cable Loss (dB) + Aux (dB).
 2: Over Limit (dB) = Level (dBUV) – Limit Line (dBUV).



Mode	Charging mode
Power Phase	Neutral

Test by : Joe Liao Temperature: 21°C Humidity: 63%

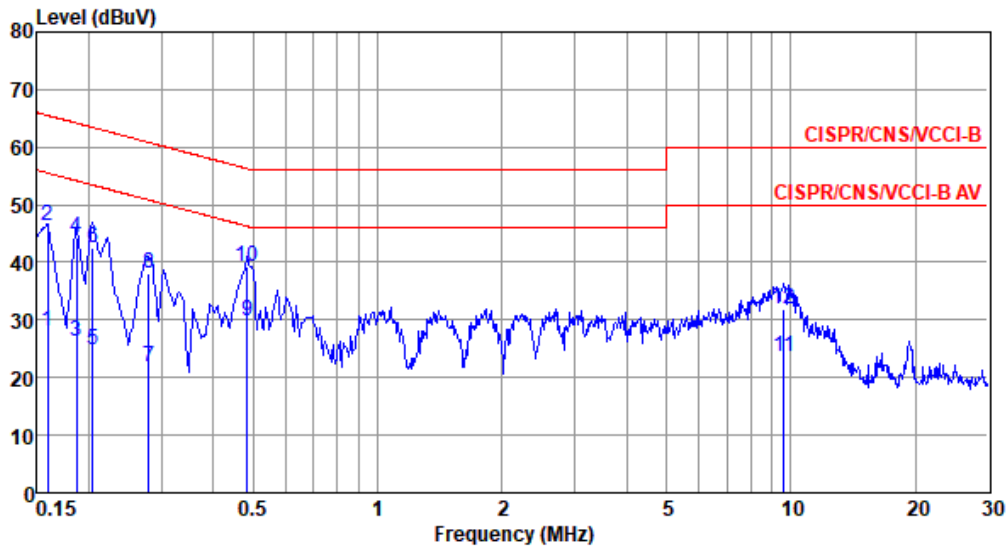

	Freq MHz	Level dBuV	Limit Line dBuV	Over Limit dB	Read Level dBuV	Factor dB	Cable loss dB	Aux dB	Remark
1	0.159	28.00	55.52	-27.52	18.13	9.63	0.06	0.18	Average
2	0.159	46.46	65.52	-19.06	36.59	9.63	0.06	0.18	QP
3	0.186	26.39	54.20	-27.81	16.51	9.63	0.06	0.19	Average
4	0.186	44.18	64.20	-20.02	34.30	9.63	0.06	0.19	QP
5	0.204	24.92	53.45	-28.53	15.04	9.63	0.06	0.19	Average
6	0.204	42.61	63.45	-20.84	32.73	9.63	0.06	0.19	QP
7	0.279	21.92	50.85	-28.93	11.99	9.63	0.06	0.24	Average
8	0.279	38.19	60.85	-22.66	28.26	9.63	0.06	0.24	QP
9*	0.484	29.69	46.27	-16.58	19.69	9.62	0.07	0.31	Average
10	0.484	39.22	56.27	-17.05	29.22	9.62	0.07	0.31	QP
11	9.603	23.51	50.00	-26.49	13.01	9.71	0.35	0.44	Average
12	9.603	31.77	60.00	-28.23	21.27	9.71	0.35	0.44	QP

Note 1: Level (dBuV) = Read Level (dBuV) + LISN Factor (dB) + Cable Loss (dB) + Aux (dB).
 2: Over Limit (dB) = Level (dBuV) – Limit Line (dBuV).