

FCC Test Report

FCC ID : IPH-A4263
Equipment : Outdoor GPS Watch
Model No. : AA4263
Brand Name : GARMIN
Applicant : Garmin International, Inc.
Address : 1200 E. 151st Street Olathe, KS 66062 United States
Standard : 47 CFR FCC Part 15.247
Received Date : Apr. 13, 2023
Tested Date : May 23 ~ Jul. 06, 2023

We, International Certification Corporation, would like to declare that the tested sample has been evaluated and in compliance with the requirement of the above standards. The test results contained in this report refer exclusively to the product. It shall not be reproduced except in full without the written approval of our laboratory.

Reviewed by:

Approved by:

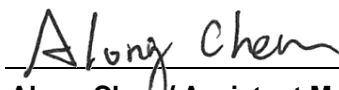

Along Chen / Assistant Manager



Gary Chang / Manager

Table of Contents

1	GENERAL DESCRIPTION	5
1.1	Information.....	5
1.2	Local Support Equipment List	8
1.3	Test Setup Chart	8
1.4	The Equipment List	9
1.5	Test Standards	10
1.6	Reference Guidance	10
1.7	Deviation from Test Standard and Measurement Procedure.....	11
1.8	Measurement Uncertainty	11
2	TEST CONFIGURATION.....	12
2.1	Testing Facility	12
2.2	The Worst Test Modes and Channel Details	12
3	TRANSMITTER TEST RESULTS	13
3.1	Unwanted Emissions into Restricted Frequency Bands	13
3.2	Unwanted Emissions into Non-Restricted Frequency Bands	16
3.3	Conducted Output Power	17
3.4	Number of Hopping Frequency	18
3.5	20dB and Occupied Bandwidth.....	19
3.6	Channel Separation.....	20
3.7	Number of Dwell Time.....	21
3.8	AC Power Line Conducted Emissions	22
4	TEST LABORATORY INFORMATION	23

Appendix A. Unwanted Emissions into Restricted Frequency Bands

Appendix B. Unwanted Emissions into Non-Restricted Frequency Bands

Appendix C. Conducted Output Power

Appendix D. Number of Hopping Frequency

Appendix E. 20dB and Occupied Bandwidth

Appendix F. Channel Separation

Appendix G. Number of Dwell Time

Appendix H. AC Power Line Conducted Emissions

Release Record

Report No.	Version	Description	Issued Date
FR341301AD	Rev. 01	Initial issue	Aug. 07, 2023

Summary of Test Results

FCC Rules	Test Items	Measured	Result
15.207	AC Power Line Conducted Emission	[dBuV]: 0.491MHz 40.87 (Margin -15.27dB) - QP	Pass
15.247(d) 15.209	Unwanted Emissions	[dBuV/m at 3m]: 31.41MHz 34.36 (Margin -5.64dB) - PK	Pass
15.247(d)	Band Edge	Meet the requirement of limit	Pass
15.247(b)(1)	Conducted Output Power	Power [dBm]: 13.23	Pass
15.247(a)(1)(iii)	Number of Hopping Channels	Meet the requirement of limit	Pass
15.247(a)(1)	Hopping Channel Separation	Meet the requirement of limit	Pass
15.247(a)(1)(iii)	Dwell Time	Meet the requirement of limit	Pass
15.203	Antenna Requirement	Meet the requirement of limit	Pass

Declaration of Conformity:

The test results with all measurement uncertainty excluded are presented in accordance with the regulation limits or requirements declared by manufacturers.

Comments and Explanations:

The declared of product specification for EUT presented in the report are provided by the manufacturer, and the manufacturer takes all the responsibilities for the accuracy of product specification.

1 General Description

1.1 Information

1.1.1 Specification of the Equipment under Test (EUT)

RF General Information				
Frequency Range (MHz)	Bluetooth Mode	Ch. Frequency (MHz)	Channel Number	Data Rate
2400-2483.5	BR	2402-2480	0-78 [79]	1 Mbps
2400-2483.5	EDR	2402-2480	0-78 [79]	2 Mbps
2400-2483.5	EDR	2402-2480	0-78 [79]	3 Mbps

Note 1: RF output power specifies that Maximum Peak Conducted Output Power.
 Note 2: Bluetooth BR uses a GFSK.
 Note 3: Bluetooth EDR uses a combination of $\pi/4$ -DQPSK and 8DPSK.

1.1.2 Antenna Details

Ant. No.	Brand	Model	Type	Connector	Gain (dBi)
1	Garmin	145-03859-00	Slot	No	-6.31

1.1.3 Power Supply Type of Equipment under Test (EUT)

Power Supply Type	5Vdc from host 3.87Vdc from battery
--------------------------	--

1.1.4 Accessories

Accessories		
No.	Equipment	Description
1	Battery	Brand: Garmin Model: 361-00146-01 Rating: 3.87Vdc, 342mAh
2	USB cable	Brand: GARMIN Model: 320-01048-C1 1.02m shielded without core

1.1.5 Channel List

Frequency band (MHz)				2400~2483.5			
Channel	Frequency (MHz)	Channel	Frequency (MHz)	Channel	Frequency (MHz)	Channel	Frequency (MHz)
0	2402	20	2422	40	2442	60	2462
1	2403	21	2423	41	2443	61	2463
2	2404	22	2424	42	2444	62	2464
3	2405	23	2425	43	2445	63	2465
4	2406	24	2426	44	2446	64	2466
5	2407	25	2427	45	2447	65	2467
6	2408	26	2428	46	2448	66	2468
7	2409	27	2429	47	2449	67	2469
8	2410	28	2430	48	2450	68	2470
9	2411	29	2431	49	2451	69	2471
10	2412	30	2432	50	2452	70	2472
11	2413	31	2433	51	2453	71	2473
12	2414	32	2434	52	2454	72	2474
13	2415	33	2435	53	2455	73	2475
14	2416	34	2436	54	2456	74	2476
15	2417	35	2437	55	2457	75	2477
16	2418	36	2438	56	2458	76	2478
17	2419	37	2439	57	2459	77	2479
18	2420	38	2440	58	2460	78	2480
19	2421	39	2441	59	2461	---	---

1.1.6 Test Tool and Duty Cycle

Test Tool	BT Test, V24.95 Bluetooth Simulator, Brand: R&S, Model: CMW270	
Modulation Mode	Duty Cycle Of Test Signal (%)	Duty Factor (dB)
DH5	77.61%	1.10
2DH5	77.61%	1.10
3DH5	77.91%	1.08

1.1.7 Power Index of Test Tool

Modulation Mode	Test Frequency (MHz)		
	2402	2441	2480
GFSK / 1Mbps	default	default	default
$\pi/4$ -DQPSK / 2Mbps	default	default	default
8DPSK / 3Mbps	default	default	default

1.2 Local Support Equipment List

Support Equipment List					
No.	Equipment	Brand	Model	FCC ID	Remarks
1	Adapter	Samsung	EP-TA800	---	---

1.3 Test Setup Chart

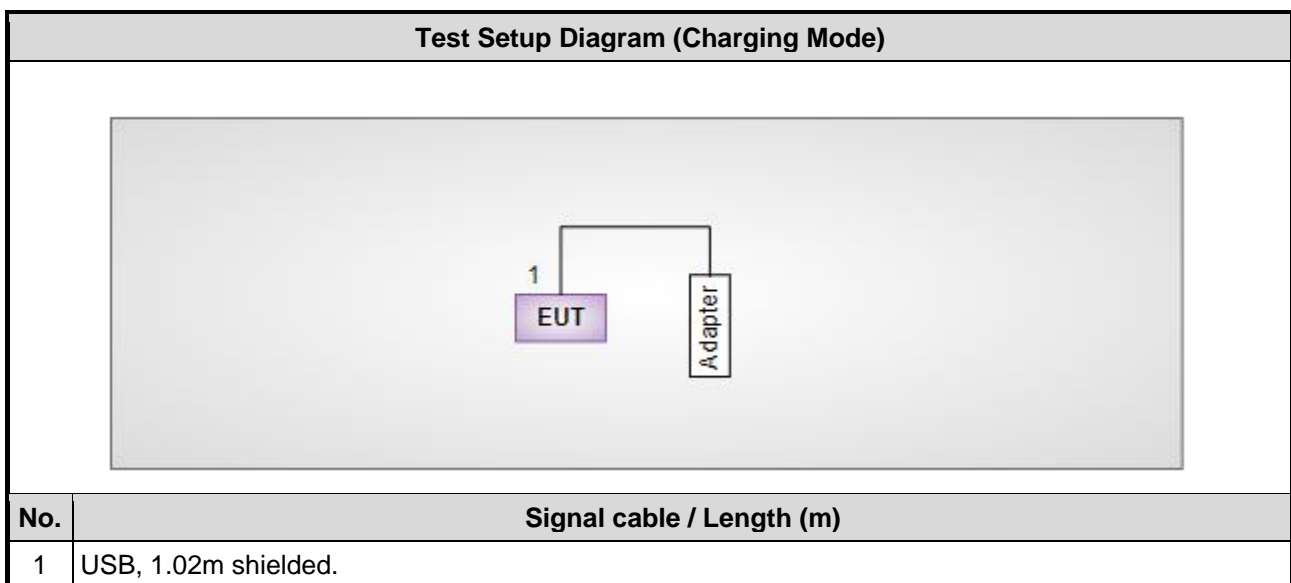
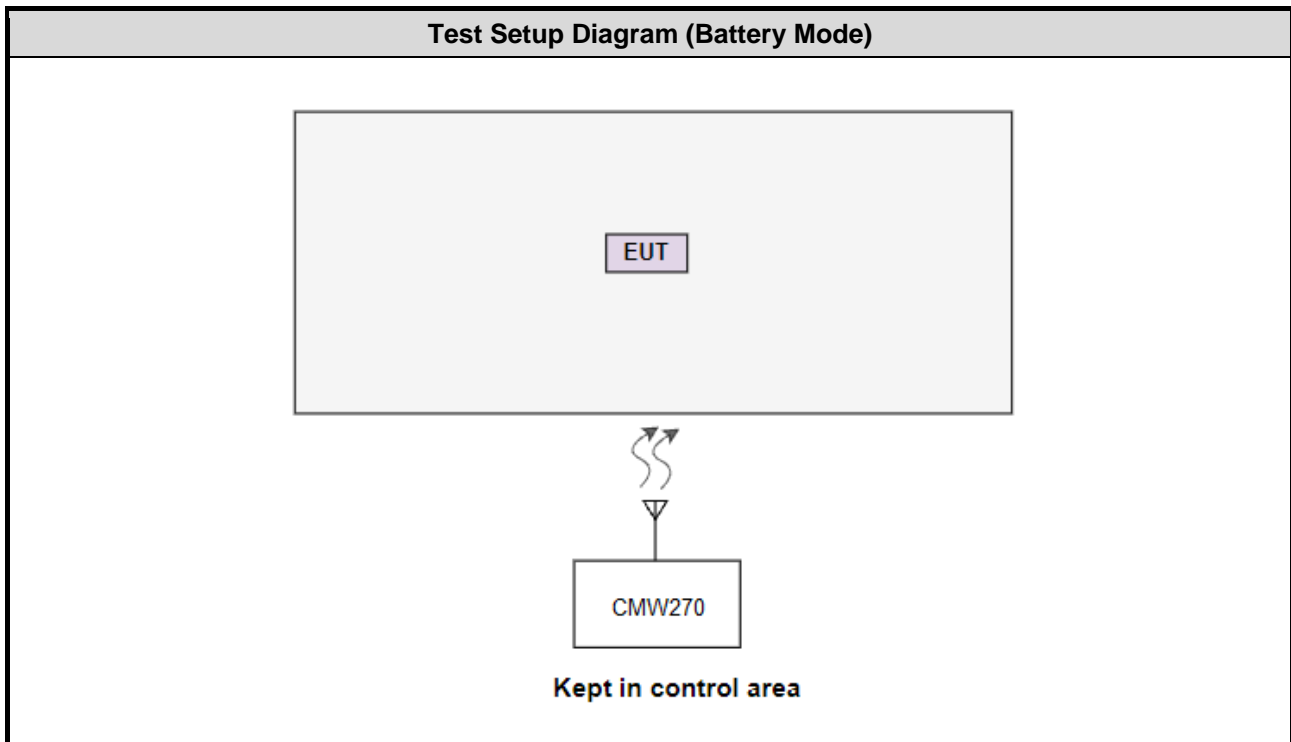

1.4 The Equipment List

Test Item	Conducted Emission				
Test Site	Conduction room 1 / (CO01-WS)				
Tested Date	May 24, 2023				
Instrument	Brand	Model No.	Serial No.	Calibration Date	Calibration Until
Receiver	R&S	ESR3	101658	Feb. 17, 2023	Feb. 16, 2024
LISN	R&S	ENV216	101579	May 09, 2023	May 08, 2024
LISN (Support Unit)	SCHWARZBECK	Schwarzbeck 8127	8127667	Jan .03, 2023	Jan .02, 2024
RF Cable-CON	Woken	CFD200-NL	CFD200-NL-001	Oct. 17, 2022	Oct. 16, 2023
50 ohm terminal (Support Unit)	NA	50	03	Jun. 08, 2022	Jun. 07, 2023
Measurement Software	AUDIX	e3	6.120210k	NA	NA
Note: Calibration Interval of instruments listed above is one year.					

Test Item	Radiated Emission below 1GHz				
Test Site	966 chamber1 / (03CH01-WS)				
Tested Date	Jul. 06, 2023				
Instrument	Brand	Model No.	Serial No.	Calibration Date	Calibration Until
Wireless connectivity tester	R&S	CMW270	100856	Nov. 16, 2022	Nov. 15, 2023
Receiver	R&S	ESR3	101657	Mar. 03, 2023	Mar. 02, 2024
Loop Antenna	R&S	HFH2-Z2	100330	Nov. 01, 2022	Oct. 31, 2023
Bilog Antenna	SCHWARZBECK	VULB9168	VULB9168-522	Aug. 03, 2022	Aug. 02, 2023
Preamplifier	EMC	EMC02325	980225	Jun. 28, 2023	Jun. 27, 2024
Loop Antenna Cable	KOAX KABEL	101354-BW	101354-BW	Oct. 04, 2022	Oct. 03, 2023
LF cable 3M	Woken	CFD400NL-LW	CFD400NL-001	Oct. 04, 2022	Oct. 03, 2023
LF cable 11M	EMC	EMCCFD400-NW-N W-11000	200801	Oct. 04, 2022	Oct. 03, 2023
LF cable 1M	EMC	EMCCFD400-NM-N M-1000	160502	Oct. 04, 2022	Oct. 03, 2023
Measurement Software	Sporton	SENSE-EMI	V5.10.8	NA	NA
Note: Calibration Interval of instruments listed above is one year.					

Test Item	Radiated Emission above 1GHz				
Test Site	966 chamber1 / (03CH01-WS)				
Tested Date	May 23, 2023				
Instrument	Brand	Model No.	Serial No.	Calibration Date	Calibration Until
Wireless connectivity tester	R&S	CMW270	100856	Nov. 16, 2022	Nov. 15, 2023
Spectrum Analyzer	R&S	FSV40	101498	Nov. 21, 2022	Nov. 20, 2023
Horn Antenna 1G-18G	SCHWARZBECK	BBHA 9120 D	BBHA 9120 D 1096	Nov. 25, 2022	Nov. 24, 2023
Horn Antenna 18G-40G	SCHWARZBECK	BBHA 9170	BBHA 9170517	Oct. 27, 2022	Oct. 26, 2023
Preamplifier	EMC	EMC118A45SE	980898	Jul. 16, 2022	Jul. 15, 2023
Preamplifier	EMC	EMC184045SE	980903	Jul. 16, 2022	Jul. 15, 2023
RF Cable	EMC	EMC104-35M-35M-8000	210920	Oct. 04, 2022	Oct. 03, 2023
RF Cable	EMC	EMC104-35M-35M-3000	210922	Oct. 04, 2022	Oct. 03, 2023
Attenuator	Pasternack	PE7005-10	10-1	Oct. 06, 2022	Oct. 05, 2023
HIGHPASS FILTER 3.1-18G	WHK	WHK3.1/18G-10SS	39	Oct. 06, 2022	Oct. 05, 2023
Measurement Software	Sporton	SENSE-15247_FS	V5.10.8	NA	NA
Note: Calibration Interval of instruments listed above is one year.					

Test Item	RF Conducted				
Test Site	(TH01-WS)				
Tested Date	Jul. 06, 2023				
Instrument	Brand	Model No.	Serial No.	Calibration Date	Calibration Until
Wireless connectivity tester	R&S	CMW270	100856	Nov. 16, 2022	Nov. 15, 2023
Spectrum Analyzer	R&S	FSV40	101910	Apr. 14, 2023	Apr. 13, 2024
Power Meter	Anritsu	ML2495A	1241002	Nov. 23, 2022	Nov. 22, 2023
Power Sensor	Anritsu	MA2411B	1207366	Nov. 23, 2022	Nov. 22, 2023
Attenuator	Pasternack	PE7005-10	10-2	Oct. 06, 2022	Oct. 05, 2023
Measurement Software	Sporton	SENSE-15247_FS	V5.10.8	NA	NA
Note: Calibration Interval of instruments listed above is one year.					

1.5 Test Standards

47 CFR FCC Part 15.247
ANSI C63.10-2013

1.6 Reference Guidance

FCC KDB 558074 D01 15.247 Meas Guidance v05r02

1.7 Deviation from Test Standard and Measurement Procedure

None

1.8 Measurement Uncertainty

The measurement uncertainties given below are based on a 95% confidence level (based on a coverage factor ($k=2$)).

Measurement Uncertainty	
Parameters	Uncertainty
Bandwidth	± 34.130 Hz
Conducted power	± 0.808 dB
Power density	± 0.583 dB
Conducted emission	± 2.715 dB
AC conducted emission	± 2.92 dB
Unwanted Emission ≤ 1 GHz	± 3.41 dB
Unwanted Emission > 1 GHz	± 4.59 dB
Time	$\pm 0.1\%$

2 Test Configuration

2.1 Testing Facility

Test Laboratory	International Certification Corporation
Test Site	CO01-WS, 03CH01-WS, TH01-WS
Address of Test Site	No.3-1, Lane 6, Wen San 3rd St., Kwei Shan Dist., Tao Yuan City 33381, Taiwan (R.O.C.)

- FCC Designation No.: TW2732
- FCC site registration No.: 181692
- ISED#: 10807A
- CAB identifier: TW2732

2.2 The Worst Test Modes and Channel Details

Test item	Modulation Mode	Test Frequency (MHz)	Data Rate (Mbps)	Test Configuration
Conducted Emissions	Charging mode	---	---	2
Radiated Emissions ≤ 1GHz	8DPSK	2480	3Mbps	1
	Charging mode	---	---	2
Radiated Emissions > 1GHz	GFSK	2402, 2441, 2480	1Mbps	1
	8DPSK	2402, 2441, 2480	3Mbps	
Conducted Output Power	GFSK	2402, 2441, 2480	1Mbps	1
	π/4 DQPSK	2402, 2441, 2480	2Mbps	
	8DPSK	2402, 2441, 2480	3Mbps	
Number of Hopping Channels	GFSK	2402~2480	1Mbps	1
	π/4 DQPSK	2402~2480	2Mbps	
	8DPSK	2402~2480	3Mbps	
Hopping Channel Separation 20dB and Occupied bandwidth	GFSK	2402, 2441, 2480	1Mbps	1
	π/4 DQPSK	2402, 2441, 2480	2Mbps	
	8DPSK	2402, 2441, 2480	3Mbps	
Dwell Time	GFSK	2402	1Mbps	1
	π/4 DQPSK	2402	2Mbps	
	8DPSK	2402	3Mbps	

NOTE:

1. The EUT was pretested with 3 orientations placed on the table for the radiated emission measurement – X, Y, and Z-plane. The **Z-plane** result was found as the worst case and was shown in this report.
2. The test configurations are listed as follows:
 - 1) Mode 1: Battery mode
 - 2) Mode 2: Charging mode

3 Transmitter Test Results

3.1 Unwanted Emissions into Restricted Frequency Bands

3.1.1 Limit of Unwanted Emissions into Restricted Frequency Bands

Restricted Band Emissions Limit			
Frequency Range (MHz)	Field Strength (uV/m)	Field Strength (dBuV/m)	Measure Distance (m)
0.009~0.490	2400/F(kHz)	48.5 - 13.8	300
0.490~1.705	24000/F(kHz)	33.8 - 23	30
1.705~30.0	30	29	30
30~88	100	40	3
88~216	150	43.5	3
216~960	200	46	3
Above 960	500	54	3

Note 1:
Qusai-Peak value is measured for frequency below 1GHz except for 9–90 kHz, 110–490 kHz frequency band. Peak and average value are measured for frequency above 1GHz. The limit on average radio frequency emission is as above table. The limit on peak radio frequency emissions is 20 dB above the maximum permitted average emission limit

Note 2:
Measurements may be performed at a distance other than what is specified provided. When performing measurements at a distance other than that specified, the results shall be extrapolated to the specified distance using an extrapolation factor as below, Frequency at or above 30 MHz: 20 dB/decade Frequency below 30 MHz: 40 dB/decade.

3.1.2 Test Procedures

1. Measurement is made at a semi-anechoic chamber that incorporates a turntable allowing a EUT rotation of 360°. A continuously-rotating, remotely-controlled turntable is installed at the test site to support the EUT and facilitate determination of the direction of maximum radiation for each EUT emission frequency. The EUT is placed at test table. For emissions testing at or below 1 GHz, the table height is 80 cm above the reference ground plane. For emission measurements above 1 GHz, the table height is 1.5 m
2. Measurement is made with the antenna positioned in both the horizontal and vertical planes of polarization. The measurement antenna is varied in height (1m ~ 4m) above the reference ground plane to obtain the maximum signal strength. Distance between EUT and antenna is 3 m.
3. This investigation is performed with the EUT rotated 360°, the antenna height scanned between 1 m and 4 m, and the antenna rotated to repeat the measurements for both the horizontal and vertical antenna polarizations.

Note:

1. 120kHz measurement bandwidth of test receiver and Quasi-peak detector is for radiated emission below 1GHz.
2. Radiated emission above 1GHz / Peak value
RBW=1MHz, VBW=3MHz and Peak detector
Radiated emission above 1GHz / Average value for harmonics
The average value is: Average = Peak value + 20log(Duty cycle) Where the duty factor is calculated from following formula for DH5 packet type which has worst duty factor:
3.
$$20\log(\text{Duty cycle}) = 20\log \frac{1\text{s} / 1600 * 5}{100\text{ ms}} = -30.1\text{dB}$$
4. Radiated emission above 1GHz / Average value for other emissions
RBW=1MHz, VBW=1/T and Peak detector

3.1.3 Test Setup

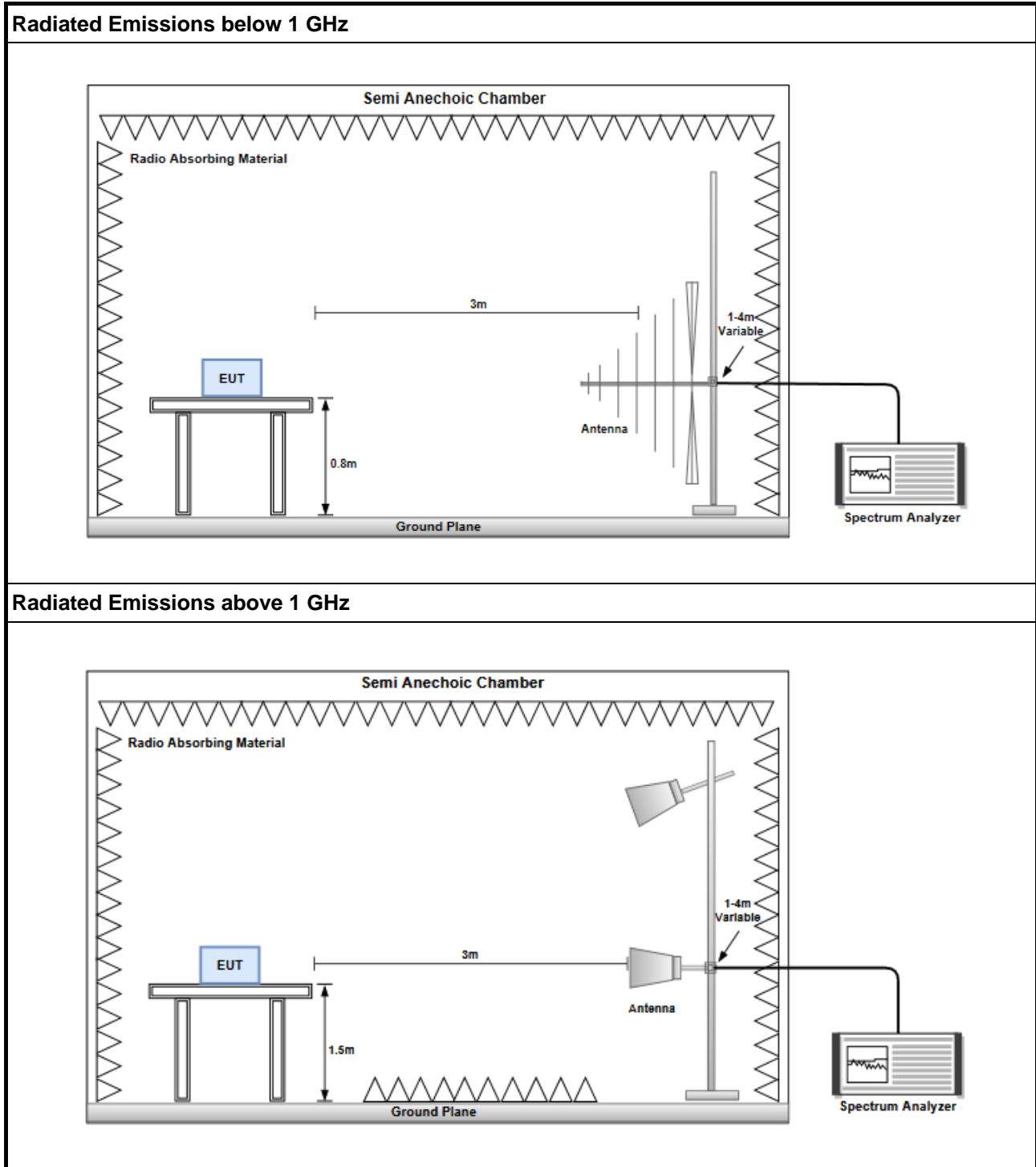

3.1.4 Test Results

Ambient Condition	23-25°C / 62-63%	Tested By	Sean Yu / Brad Wu
--------------------------	------------------	------------------	-------------------

Refer to Appendix A.

3.2 Unwanted Emissions into Non-Restricted Frequency Bands

3.2.1 Limit of Unwanted Emissions into Non-Restricted Frequency Bands

Peak power in any 100 kHz bandwidth outside of the authorized frequency band shall be attenuated by at least 20 dB relative to the maximum in-band peak PSD level in 100 kHz.

3.2.2 Test Procedures

Reference level measurement

1. Set RBW=100kHz, VBW = 300kHz , Detector = Peak, Sweep time = Auto
2. Trace = max hold , Allow Trace to fully stabilize
3. Use the peak marker function to determine the maximum PSD level

Emission level measurement

1. Set RBW=100kHz, VBW = 300kHz , Detector = Peak, Sweep time = Auto
2. Trace = max hold , Allow Trace to fully stabilize
3. Scan Frequency range is up to 25GHz
4. Use the peak marker function to determine the maximum amplitude level

3.2.3 Test Setup

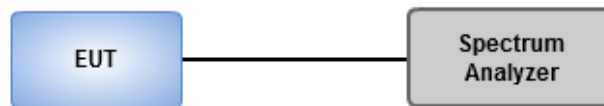

3.2.4 Test Results

Ambient Condition	25°C / 66%	Tested By	Akun Chung
--------------------------	------------	------------------	------------

Refer to Appendix B.

3.3 Conducted Output Power

3.3.1 Limit of Conducted Output Power

- 1 Watt
For frequency hopping systems operating in the 2400–2483.5 MHz band employing at least 75 non overlapping hopping channels, and all frequency hopping systems in the 5725–5850 MHz band.
- 0.125 Watt
For all other frequency hopping systems in the 2400–2483.5 MHz band.
- 0.125 Watt
For Frequency hopping systems operating in the 2400–2483.5 MHz band have hopping channel carrier frequencies that are separated by two-thirds of the 20 dB bandwidth of the hopping channel.

3.3.2 Test Procedures

1. A wideband power meter is used for power measurement. Bandwidth of power sensor and meter is 50MHz
2. If duty cycle of test signal is not 100 %, trigger and gating function of power meter will be enabled to capture transmission burst for measuring output power

3.3.3 Test Setup

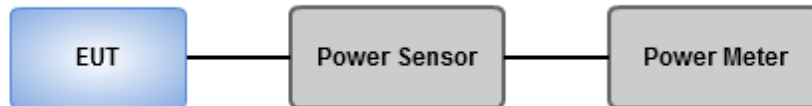

3.3.4 Test Results

Ambient Condition	25°C / 66%	Tested By	Akun Chung
--------------------------	------------	------------------	------------

Refer to Appendix C.

3.4 Number of Hopping Frequency

3.4.1 Limit of Number of Hopping Frequency

Frequency hopping systems in the 2400–2483.5 MHz band shall use at least 15 channels.

3.4.2 Test Procedures

1. Set RBW = 100kHz, VBW = 300kHz, Sweep time = Auto, Detector = Peak Trace max hold.
2. Allow trace to stabilize.

3.4.3 Test Setup

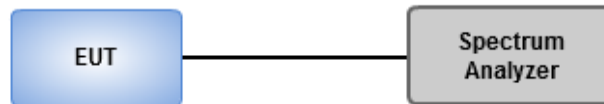

3.4.4 Test Results

Ambient Condition	25°C / 66%	Tested By	Akun Chung
-------------------	------------	-----------	------------

Refer to Appendix D.

3.5 20dB and Occupied Bandwidth

3.5.1 Test Procedures

20dB Bandwidth

1. Set RBW=20kHz, VBW=100kHz, Sweep time = Auto, Detector=Peak , Trace max hold
2. Allow trace to stabilize
3. Measure the maximum width of the emission that is constrained by the frequencies associated with the two outermost amplitude points (upper and lower) that are attenuated by 20 dB relative to the maximum level measured in the fundamental emission.

Occupied Bandwidth

1. Set RBW=20kHz, VBW=100kHz, Sweep time = Auto, Detector=Sample , Trace max hold
2. Allow trace to stabilize
3. Use Occupied bandwidth function of spectrum analyzer to measuring 99% occupied bandwidth

3.5.2 Test Setup

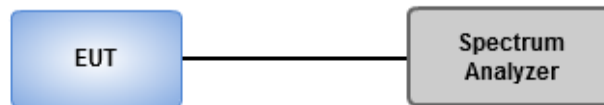

3.5.3 Test Results

Ambient Condition	25°C / 66%	Tested By	Akun Chung
--------------------------	------------	------------------	------------

Refer to Appendix E.

3.6 Channel Separation

3.6.1 Limit of Channel Separation

- Frequency hopping systems shall have hopping channel carrier frequencies separated by a minimum of 25 kHz or the 20 dB bandwidth of the hopping channel, whichever is greater.
- Frequency hopping systems operating in the 2400–2483.5 MHz band may have hopping channel carrier frequencies that are separated by 25 kHz or two-thirds of the 20 dB bandwidth of the hopping channel, whichever is greater.

3.6.2 Test Procedures

1. Set RBW=30kHz, VBW=100kHz, Sweep time = Auto, Detector=Peak Trace max hold
2. Allow trace to stabilize
3. Use the marker-delta function to determine the separation between the peaks of the adjacent channels. The EUT shall show compliance with the appropriate regulatory limit

3.6.3 Test Setup

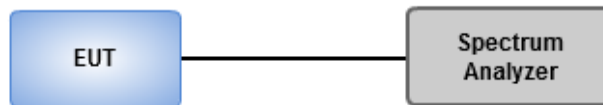

3.6.4 Test Results

Ambient Condition	25°C / 66%	Tested By	Akun Chung
--------------------------	------------	------------------	------------

Refer to Appendix F.

3.7 Number of Dwell Time

3.7.1 Limit of Dwell time

The average time of occupancy on any channel shall not be greater than 0.4 seconds within a period of 0.4 seconds multiplied by the number of hopping channels employed.

3.7.2 Test Procedures

1. Set RBW=300 kHz, VBW=1 MHz, Sweep time=8 ms, Detector=Peak, Span=0 Hz, Trace max hold.
2. Enable gating and trigger function of spectrum analyzer to measure burst on time.
3. Set RBW=300 kHz, VBW=1 MHz, Sweep time=5 s / 2 s, Detector=Peak, Span=0 Hz, Trace max hold.
4. Enable gating and trigger function of spectrum analyzer to measure burst on number of transmission.
5. Set RBW=300 kHz, VBW=1 MHz, Sweep time=31.6 s / 8 s, Detector=Peak, Span=0 Hz, Trace max hold.
6. Enable gating and trigger function of spectrum analyzer to measure burst on number of transmission of entire time cycle.

3.7.3 Test Setup

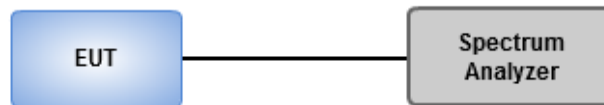

3.7.4 Test Results

Ambient Condition	25°C / 66%	Tested By	Akun Chung
--------------------------	------------	------------------	------------

Refer to Appendix G.

3.8 AC Power Line Conducted Emissions

3.8.1 Limit of AC Power Line Conducted Emissions

Conducted Emissions Limit		
Frequency Emission (MHz)	Quasi-Peak	Average
0.15-0.5	66 - 56 *	56 - 46 *
0.5-5	56	46
5-30	60	50

Note 1: * Decreases with the logarithm of the frequency.

3.8.2 Test Procedures

1. The device is placed on a test table, raised 80 cm above the reference ground plane. The vertical conducting plane is located 40 cm to the rear of the device.
2. The device is connected to line impedance stabilization network (LISN) and other accessories are connected to other LISN. Measured levels of AC power line conducted emission are across the 50 Ω LISN port.
3. AC conducted emission measurements is made over frequency range from 150 kHz to 30 MHz.
4. This measurement was performed with AC 120V/60Hz

3.8.3 Test Setup

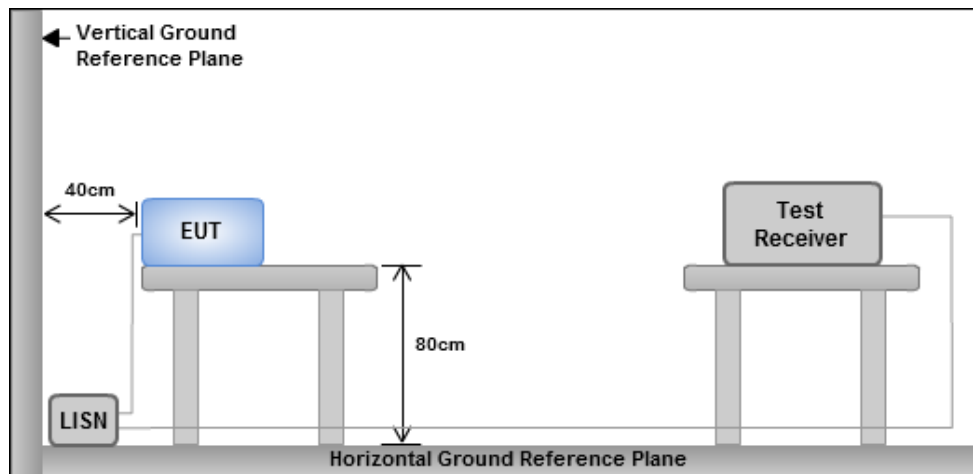

- Note: 1. Support units were connected to second LISN.
 2. Both of LISNs (AMN) are 80 cm from EUT and at least 80 cm from other units and other metal planes

3.8.4 Test Results

Refer to Appendix H.

4 Test laboratory information

Established in 2012, ICC provides foremost EMC & RF Testing and advisory consultation services by our skilled engineers and technicians. Our services employ a wide variety of advanced edge test equipment and one of the widest certification extents in the business.

International Certification Corporation (EMC and Wireless Communication Laboratory), it is our definitive objective is to institute long term, trust-based associations with our clients. The expectation we set up with our clients is based on outstanding service, practical expertise and devotion to a certified value structure. Our passion is to grant our clients with best EMC / RF services by oriented knowledgeable and accommodating staff.

Our Test sites are located at Linkou District and Kwei Shan District. Location map can be found on our website <http://www.icertifi.com.tw>.

Linkou

Tel: 886-2-2601-1640

No.30-2, Ding Fwu Tsuen, Lin Kou
District, New Taipei City, Taiwan
(R.O.C.)

Kwei Shan

Tel: 886-3-271-8666

No.3-1, Lane 6, Wen San 3rd
St., Kwei Shan Dist., Tao Yuan
City 33381, Taiwan (R.O.C.)
No.2-1, Lane 6, Wen San 3rd
St., Kwei Shan Dist., Tao Yuan
City 33381, Taiwan (R.O.C.)

Kwei Shan Site II

Tel: 886-3-271-8640

No.14-1, Lane 19, Wen San 3rd
St., Kwei Shan Dist., Tao Yuan
City 33381, Taiwan (R.O.C.)

If you have any suggestion, please feel free to contact us as below information.

Tel: 886-3-271-8666

Fax: 886-3-318-0345

Email: ICC_Service@icertifi.com.tw

==END==



Summary

Mode	Result	Type	Freq (Hz)	Level (dBuV/m)	Limit (dBuV/m)	Margin (dB)	Condition
Mode 1	Pass	PK	102.57M	28.06	43.50	-15.44	Horizontal
Mode 2	Pass	PK	31.41M	34.36	40.00	-5.64	Vertical



Mode 1

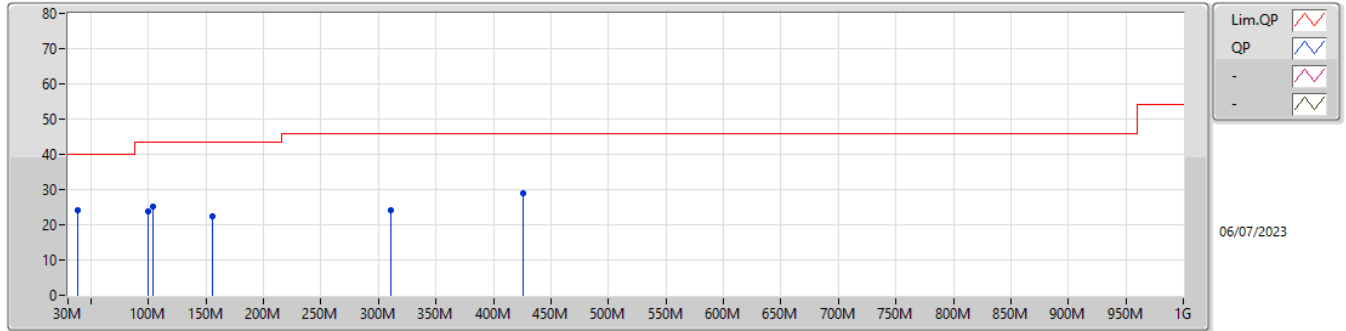

Type	Freq (Hz)	Level (dBuV/m)	Limit (dBuV/m)	Margin (dB)	Factor (dB/m)	Dist (m)	Condition	Azimuth (°)	Height (m)	Comment	Raw (dBuV/m)	AF (dB/m)	CL (dB)	PA (dB)		
PK	38.79M	24.16	40.00	-15.84	-8.81	3	Vertical	-	-	-	32.97	18.60	0.61	28.02		
PK	99.58M	23.86	43.50	-19.64	-13.46	3	Vertical	-	-	-	37.32	14.00	0.92	28.38		
PK	103.54M	25.11	43.50	-18.39	-12.78	3	Vertical	-	-	-	37.89	14.67	0.93	28.38		
PK	155.45M	22.51	43.50	-20.99	-8.81	3	Vertical	-	-	-	31.32	18.51	1.09	28.41		
PK	310.68M	24.01	46.00	-21.99	-7.77	3	Vertical	-	-	-	31.78	19.03	1.61	28.41		
PK	425.47M	29.04	46.00	-16.96	-4.85	3	Vertical	-	-	-	33.89	21.61	1.85	28.31		



Mode 1

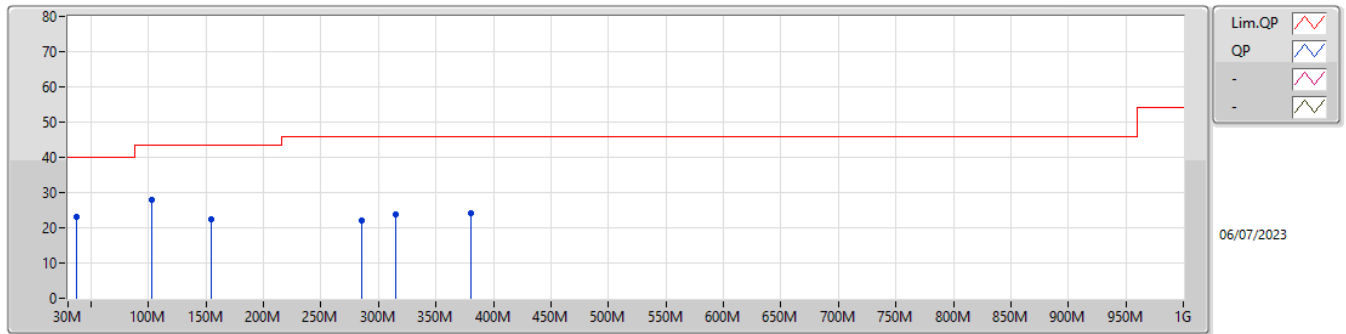

Type	Freq (Hz)	Level (dBuV/m)	Limit (dBuV/m)	Margin (dB)	Factor (dB/m)	Dist (m)	Condition	Azimuth (°)	Height (m)	Comment	Raw (dBuV/m)	AF (dB/m)	CL (dB)	PA (dB)
PK	37.48M	23.16	40.00	-16.84	-8.91	3	Horizontal	-	-	-	32.07	18.50	0.60	28.01
PK	102.57M	28.06	43.50	-15.44	-13.01	3	Horizontal	-	-	-	41.07	14.44	0.93	28.38
PK	154.92M	22.58	43.50	-20.92	-8.74	3	Horizontal	-	-	-	31.32	18.58	1.09	28.41
PK	285.34M	22.09	46.00	-23.91	-8.47	3	Horizontal	-	-	-	30.56	18.41	1.54	28.42
PK	315.48M	23.66	46.00	-22.34	-7.58	3	Horizontal	-	-	-	31.24	19.21	1.62	28.41
PK	380.44M	24.26	46.00	-21.74	-5.98	3	Horizontal	-	-	-	30.24	20.61	1.76	28.35



Mode 2

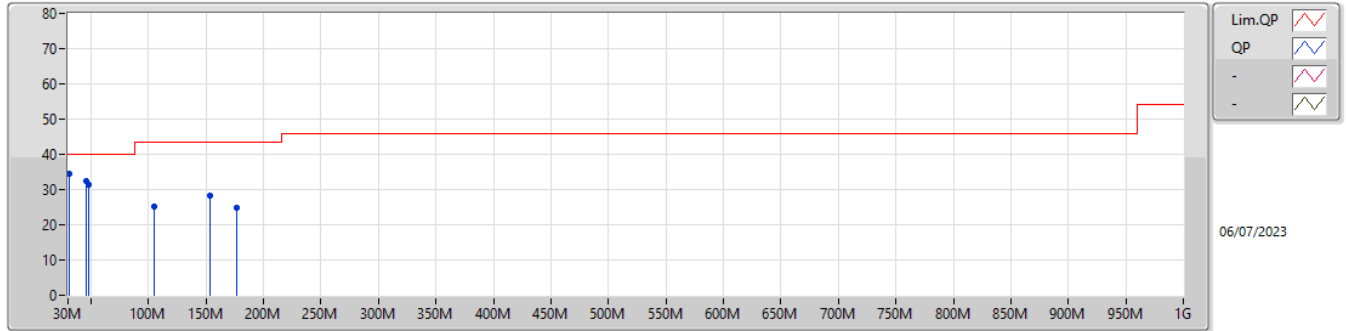

Type	Freq (Hz)	Level (dBuV/m)	Limit (dBuV/m)	Margin (dB)	Factor (dB/m)	Dist (m)	Condition	Azimuth (°)	Height (m)	Comment	Raw (dBuV/m)	AF (dB/m)	CL (dB)	PA (dB)
PK	31.41M	34.36	40.00	-5.64	-9.76	3	Vertical	-	-	-	44.12	17.65	0.57	27.98
PK	45.46M	32.50	40.00	-7.50	-8.15	3	Vertical	-	-	-	40.65	19.25	0.66	28.06
PK	48.28M	31.38	40.00	-8.62	-8.10	3	Vertical	-	-	-	39.48	19.27	0.70	28.07
PK	104.51M	25.20	43.50	-18.30	-12.44	3	Vertical	-	-	-	37.64	15.00	0.94	28.38
PK	153.71M	28.32	43.50	-15.18	-8.95	3	Vertical	-	-	-	37.27	18.37	1.09	28.41
PK	176.2M	24.71	43.50	-18.79	-9.96	3	Vertical	-	-	-	34.67	17.28	1.19	28.43



Mode 2

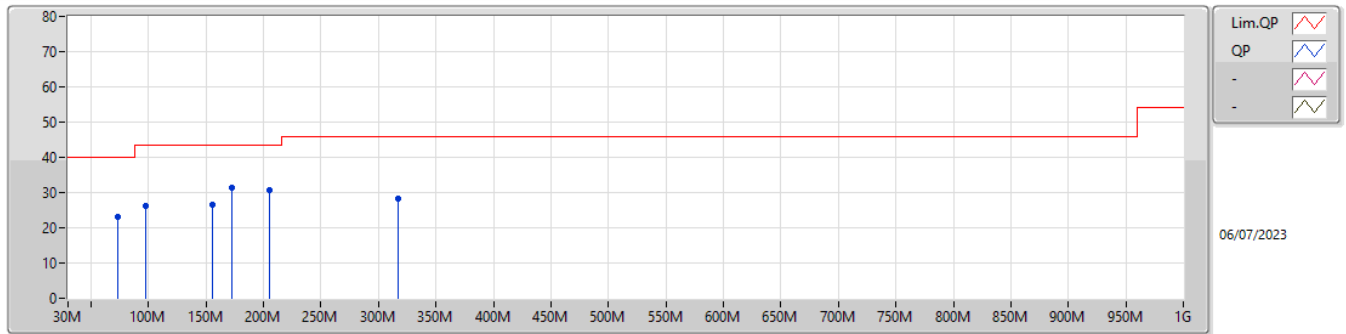

Type	Freq (Hz)	Level (dBuV/m)	Limit (dBuV/m)	Margin (dB)	Factor (dB/m)	Dist (m)	Condition	Azimuth (°)	Height (m)	Comment	Raw (dBuV/m)	AF (dB/m)	CL (dB)	PA (dB)
PK	73.58M	23.21	40.00	-16.79	-12.06	3	Horizontal	-	-	-	35.27	15.33	0.83	28.22
PK	97.48M	26.10	43.50	-17.40	-13.70	3	Horizontal	-	-	-	39.80	13.75	0.91	28.36
PK	155.12M	26.65	43.50	-16.85	-8.74	3	Horizontal	-	-	-	35.39	18.58	1.09	28.41
PK	171.99M	31.22	43.50	-12.28	-9.45	3	Horizontal	-	-	-	40.67	17.80	1.17	28.42
PK	205.72M	30.78	43.50	-12.72	-11.90	3	Horizontal	-	-	-	42.68	15.20	1.34	28.44
PK	316.78M	28.16	46.00	-17.84	-7.54	3	Horizontal	-	-	-	35.70	19.24	1.62	28.40



Unwanted Emissions into Restricted Frequency Bands Above 1GHz

Appendix A.2

Summary

Mode	Result	Type	Freq (Hz)	Level (dBuV/m)	Limit (dBuV/m)	Margin (dB)	Dist (m)	Condition	Azimuth (°)	Height (m)	Comments
2.4-2.4835GHz	-	-	-	-	-	-	-	-	-	-	-
BT-BR(1Mbps)	Pass	AV	2.4835G	38.63	54.00	-15.37	3	Vertical	347	2.59	-
BT-EDR(3Mbps)	Pass	AV	2.4835G	39.40	54.00	-14.60	3	Vertical	346	2.59	-



2.4-2.4835GHz_BT-BR(1Mbps)

2402MHz_TX

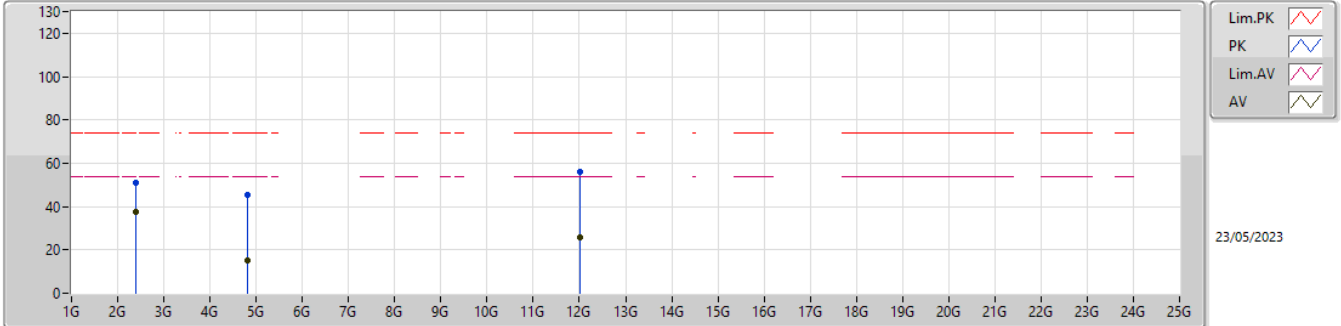

Type	Freq (Hz)	Level (dBuV/m)	Limit (dBuV/m)	Margin (dB)	Raw (dBuV)	Dist (m)	Condition	Azimuth (°)	Height (m)	Comment	AF (dB)	CL (dB)	PA (dB)
PK	2.39G	51.00	74.00	-23.00	55.65	3	Vertical	355	2.63	-	27.72	4.67	37.04
AV	2.39G	37.46	54.00	-16.54	42.11	3	Vertical	355	2.63	-	27.72	4.67	37.04
PK	4.804G	45.17	74.00	-28.83	45.69	3	Vertical	336	1.00	-	31.40	6.71	38.63
AV	4.804G	15.07	54.00	-38.93	15.59	3	Vertical	336	1.00	-	31.40	6.71	38.63
PK	12.01G	55.78	74.00	-18.22	49.65	3	Vertical	5	1.00	-	39.45	9.71	43.03
AV	12.01G	25.68	54.00	-28.32	19.55	3	Vertical	5	1.00	-	39.45	9.71	43.03



2.4-2.4835GHz_BT-BR(1Mbps)

2402MHz_TX

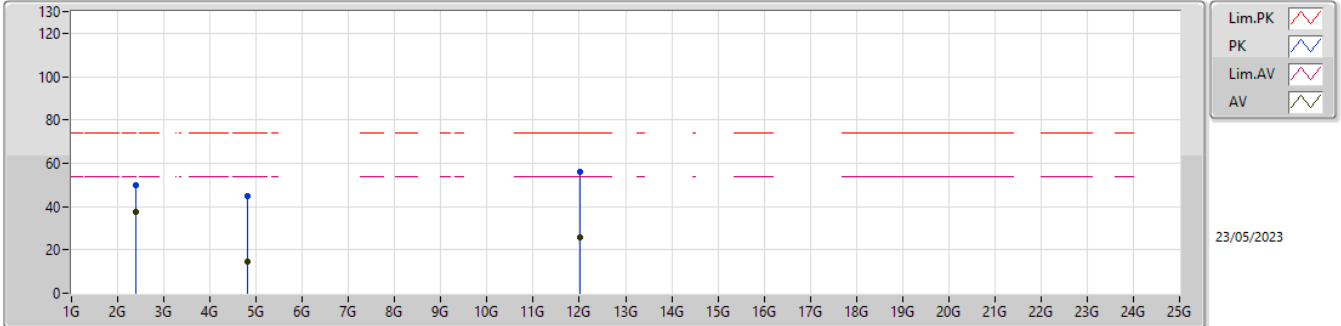

Type	Freq (Hz)	Level (dBuV/m)	Limit (dBuV/m)	Margin (dB)	Raw (dBuV)	Dist (m)	Condition	Azimuth (°)	Height (m)	Comment	AF (dB)	CL (dB)	PA (dB)
PK	2.39G	50.09	74.00	-23.91	54.74	3	Horizontal	353	2.53	-	27.72	4.67	37.04
AV	2.39G	37.29	54.00	-16.71	41.94	3	Horizontal	353	2.53	-	27.72	4.67	37.04
PK	4.804G	44.73	74.00	-29.27	45.25	3	Horizontal	28	1.00	-	31.40	6.71	38.63
AV	4.804G	14.63	54.00	-39.37	15.15	3	Horizontal	28	1.00	-	31.40	6.71	38.63
PK	12.01G	55.81	74.00	-18.19	49.68	3	Horizontal	14	1.00	-	39.45	9.71	43.03
AV	12.01G	25.71	54.00	-28.29	19.58	3	Horizontal	14	1.00	-	39.45	9.71	43.03



2.4-2.4835GHz_BT-BR(1Mbps)

2441MHz_TX

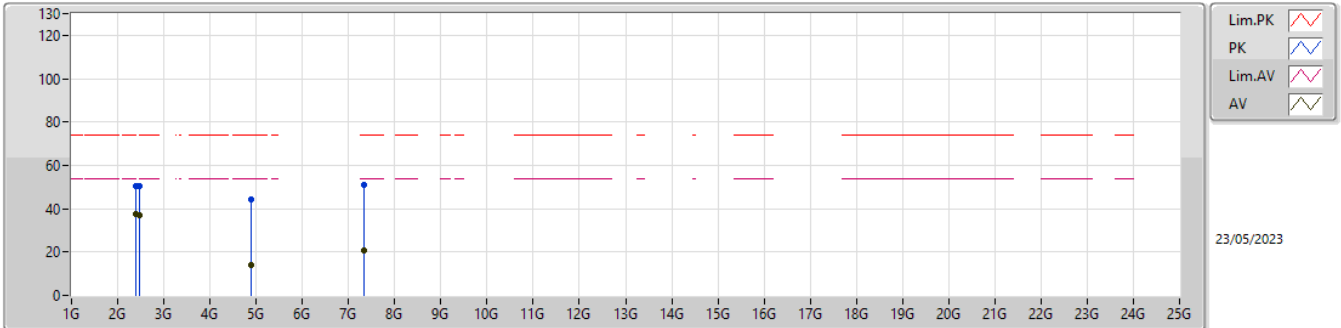

Type	Freq (Hz)	Level (dBuV/m)	Limit (dBuV/m)	Margin (dB)	Raw (dBuV)	Dist (m)	Condition	Azimuth (°)	Height (m)	Comment	AF (dB)	CL (dB)	PA (dB)
PK	2.39G	50.54	74.00	-23.46	55.19	3	Vertical	352	2.63	-	27.72	4.67	37.04
AV	2.39G	37.36	54.00	-16.64	42.01	3	Vertical	352	2.63	-	27.72	4.67	37.04
PK	2.4835G	50.61	74.00	-23.39	55.50	3	Vertical	352	2.63	-	27.50	4.73	37.12
AV	2.4835G	37.00	54.00	-17.00	41.89	3	Vertical	352	2.63	-	27.50	4.73	37.12
PK	4.882G	44.11	74.00	-29.89	44.65	3	Vertical	334	1.00	-	31.40	6.74	38.68
AV	4.882G	14.01	54.00	-39.99	14.55	3	Vertical	334	1.00	-	31.40	6.74	38.68
PK	7.323G	50.84	74.00	-23.16	45.66	3	Vertical	16	1.00	-	36.45	8.23	39.50
AV	7.323G	20.74	54.00	-33.26	15.56	3	Vertical	16	1.00	-	36.45	8.23	39.50



2.4-2.4835GHz_BT-BR(1Mbps)

2441MHz_TX

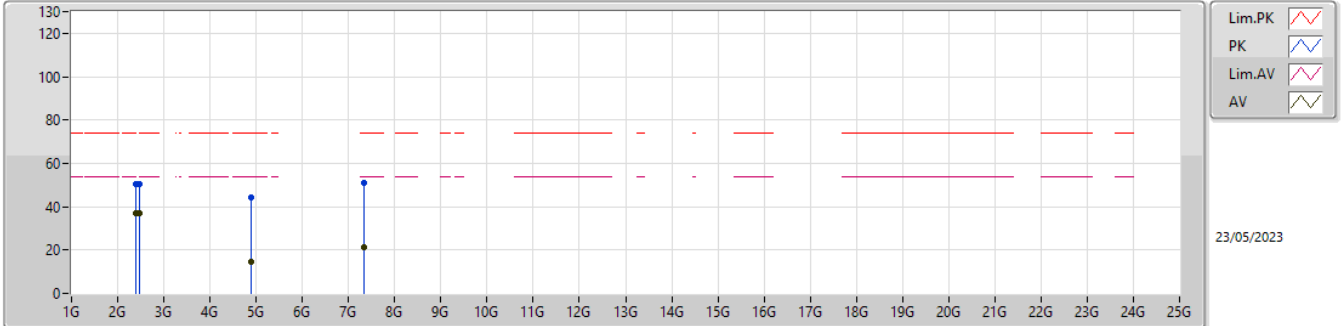

Type	Freq (Hz)	Level (dBuV/m)	Limit (dBuV/m)	Margin (dB)	Raw (dBuV)	Dist (m)	Condition	Azimuth (°)	Height (m)	Comment	AF (dB)	CL (dB)	PA (dB)
PK	2.39G	50.16	74.00	-23.84	54.81	3	Horizontal	353	2.63	-	27.72	4.67	37.04
AV	2.39G	37.00	54.00	-17.00	41.65	3	Horizontal	353	2.63	-	27.72	4.67	37.04
PK	2.4835G	50.57	74.00	-23.43	55.46	3	Horizontal	353	2.63	-	27.50	4.73	37.12
AV	2.4835G	36.85	54.00	-17.15	41.74	3	Horizontal	353	2.63	-	27.50	4.73	37.12
PK	4.882G	44.42	74.00	-29.58	44.96	3	Horizontal	48	1.00	-	31.40	6.74	38.68
AV	4.882G	14.32	54.00	-39.68	14.86	3	Horizontal	48	1.00	-	31.40	6.74	38.68
PK	7.323G	51.12	74.00	-22.88	45.94	3	Horizontal	23	1.00	-	36.45	8.23	39.50
AV	7.323G	21.02	54.00	-32.98	15.84	3	Horizontal	23	1.00	-	36.45	8.23	39.50



2.4-2.4835GHz_BT-BR(1Mbps)

2480MHz_TX

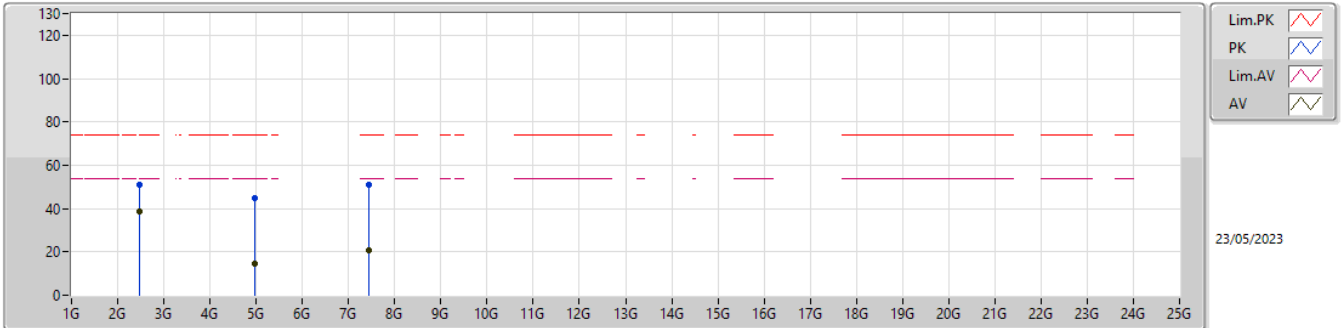

Type	Freq (Hz)	Level (dBuV/m)	Limit (dBuV/m)	Margin (dB)	Raw (dBuV)	Dist (m)	Condition	Azimuth (°)	Height (m)	Comment	AF (dB)	CL (dB)	PA (dB)
PK	2.4835G	51.07	74.00	-22.93	55.96	3	Vertical	347	2.59	-	27.50	4.73	37.12
AV	2.4835G	38.63	54.00	-15.37	43.52	3	Vertical	347	2.59	-	27.50	4.73	37.12
PK	4.96G	44.78	74.00	-29.22	45.22	3	Vertical	336	1.00	-	31.52	6.77	38.73
AV	4.96G	14.68	54.00	-39.32	15.12	3	Vertical	336	1.00	-	31.52	6.77	38.73
PK	7.44G	51.09	74.00	-22.91	45.98	3	Vertical	28	1.00	-	36.48	8.28	39.65
AV	7.44G	20.99	54.00	-33.01	15.88	3	Vertical	28	1.00	-	36.48	8.28	39.65



2.4-2.4835GHz_BT-BR(1Mbps)

2480MHz_TX

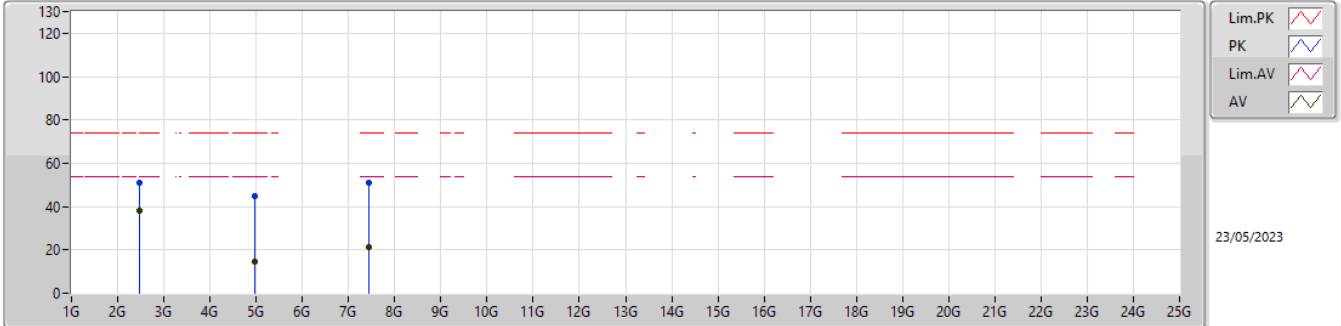

Type	Freq (Hz)	Level (dBuV/m)	Limit (dBuV/m)	Margin (dB)	Raw (dBuV)	Dist (m)	Condition	Azimuth (°)	Height (m)	Comment	AF (dB)	CL (dB)	PA (dB)
PK	2.4835G	50.72	74.00	-23.28	55.61	3	Horizontal	356	2.38	-	27.50	4.73	37.12
AV	2.4835G	38.05	54.00	-15.95	42.94	3	Horizontal	356	2.38	-	27.50	4.73	37.12
PK	4.96G	44.80	74.00	-29.20	45.24	3	Horizontal	35	1.00	-	31.52	6.77	38.73
AV	4.96G	14.70	54.00	-39.30	15.14	3	Horizontal	35	1.00	-	31.52	6.77	38.73
PK	7.44G	51.23	74.00	-22.77	46.12	3	Horizontal	28	1.00	-	36.48	8.28	39.65
AV	7.44G	21.13	54.00	-32.87	16.02	3	Horizontal	28	1.00	-	36.48	8.28	39.65



2.4-2.4835GHz_BT-EDR(3Mbps)

2402MHz_TX

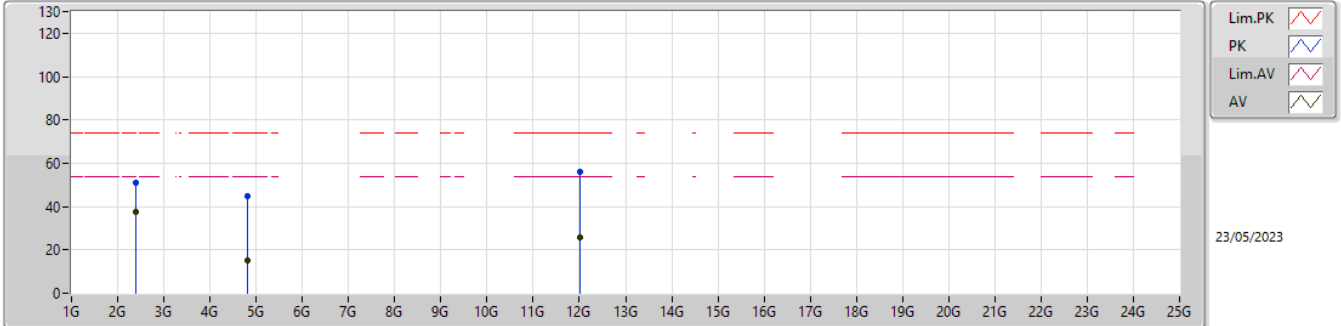

Type	Freq (Hz)	Level (dBuV/m)	Limit (dBuV/m)	Margin (dB)	Raw (dBuV)	Dist (m)	Condition	Azimuth (°)	Height (m)	Comment	AF (dB)	CL (dB)	PA (dB)
PK	2.39G	51.09	74.00	-22.91	55.74	3	Vertical	355	2.62	-	27.72	4.67	37.04
AV	2.39G	37.66	54.00	-16.34	42.31	3	Vertical	355	2.62	-	27.72	4.67	37.04
PK	4.804G	45.06	74.00	-28.94	45.58	3	Vertical	334	1.00	-	31.40	6.71	38.63
AV	4.804G	14.96	54.00	-39.04	15.48	3	Vertical	334	1.00	-	31.40	6.71	38.63
PK	12.01G	55.87	74.00	-18.13	49.74	3	Vertical	18	1.00	-	39.45	9.71	43.03
AV	12.01G	25.77	54.00	-28.23	19.64	3	Vertical	18	1.00	-	39.45	9.71	43.03



2.4-2.4835GHz_BT-EDR(3Mbps)

2402MHz_TX

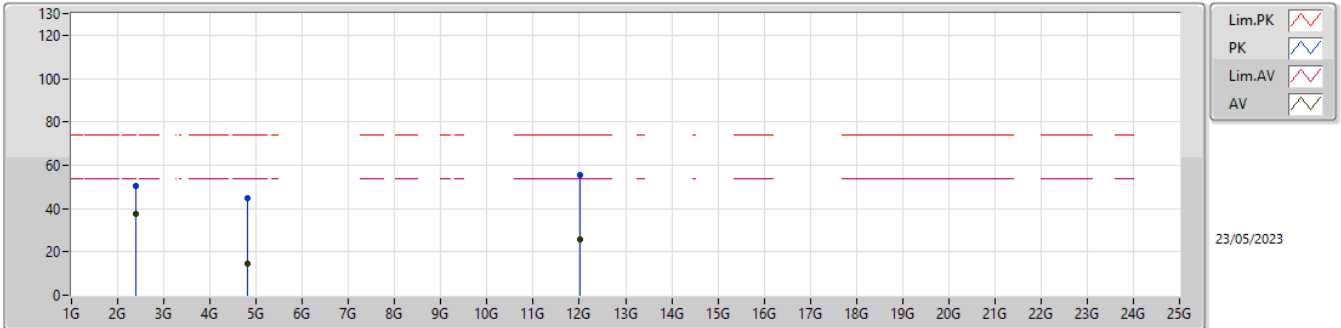

Type	Freq (Hz)	Level (dBuV/m)	Limit (dBuV/m)	Margin (dB)	Raw (dBuV)	Dist (m)	Condition	Azimuth (°)	Height (m)	Comment	AF (dB)	CL (dB)	PA (dB)
PK	2.39G	50.17	74.00	-23.83	54.82	3	Horizontal	354	2.56	-	27.72	4.67	37.04
AV	2.39G	37.46	54.00	-16.54	42.11	3	Horizontal	354	2.56	-	27.72	4.67	37.04
PK	4.804G	44.82	74.00	-29.18	45.34	3	Horizontal	22	1.00	-	31.40	6.71	38.63
AV	4.804G	14.72	54.00	-39.28	15.24	3	Horizontal	22	1.00	-	31.40	6.71	38.63
PK	12.01G	55.68	74.00	-18.32	49.55	3	Horizontal	17	1.00	-	39.45	9.71	43.03
AV	12.01G	25.58	54.00	-28.42	19.45	3	Horizontal	17	1.00	-	39.45	9.71	43.03



2.4-2.4835GHz_BT-EDR(3Mbps)

2441MHz_TX

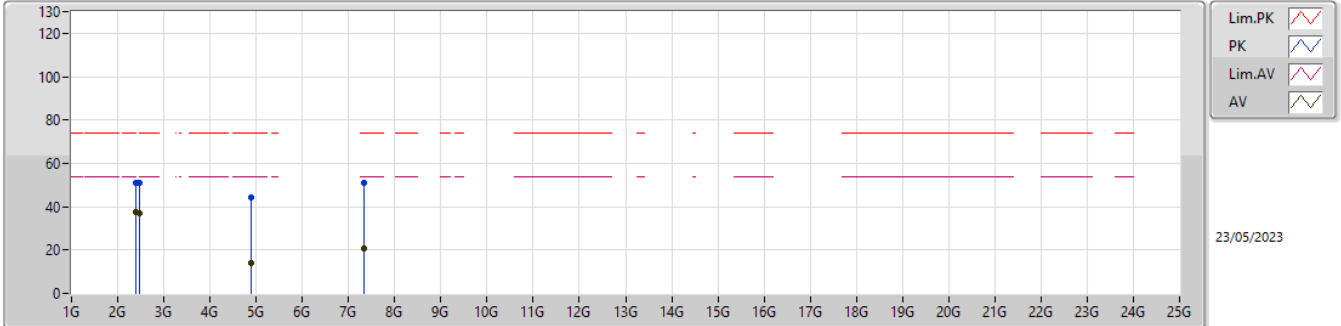

Type	Freq (Hz)	Level (dBuV/m)	Limit (dBuV/m)	Margin (dB)	Raw (dBuV)	Dist (m)	Condition	Azimuth (°)	Height (m)	Comment	AF (dB)	CL (dB)	PA (dB)
PK	2.39G	50.96	74.00	-23.04	55.61	3	Vertical	349	2.62	-	27.72	4.67	37.04
AV	2.39G	37.68	54.00	-16.32	42.33	3	Vertical	349	2.62	-	27.72	4.67	37.04
PK	2.4835G	50.75	74.00	-23.25	55.64	3	Vertical	349	2.62	-	27.50	4.73	37.12
AV	2.4835G	37.03	54.00	-16.97	41.92	3	Vertical	349	2.62	-	27.50	4.73	37.12
PK	4.882G	44.05	74.00	-29.95	44.59	3	Vertical	336	1.00	-	31.40	6.74	38.68
AV	4.882G	13.95	54.00	-40.05	14.49	3	Vertical	336	1.00	-	31.40	6.74	38.68
PK	7.323G	50.82	74.00	-23.18	45.64	3	Vertical	21	1.00	-	36.45	8.23	39.50
AV	7.323G	20.72	54.00	-33.28	15.54	3	Vertical	21	1.00	-	36.45	8.23	39.50



2.4-2.4835GHz_BT-EDR(3Mbps)

2441MHz_TX

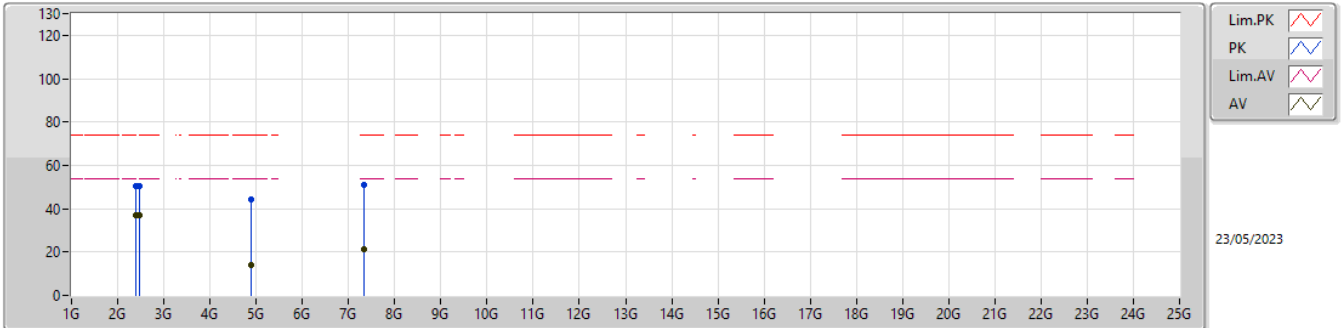

Type	Freq (Hz)	Level (dBuV/m)	Limit (dBuV/m)	Margin (dB)	Raw (dBuV)	Dist (m)	Condition	Azimuth (°)	Height (m)	Comment	AF (dB)	CL (dB)	PA (dB)
PK	2.39G	50.23	74.00	-23.77	54.88	3	Horizontal	354	2.39	-	27.72	4.67	37.04
AV	2.39G	37.07	54.00	-16.93	41.72	3	Horizontal	354	2.39	-	27.72	4.67	37.04
PK	2.4835G	50.46	74.00	-23.54	55.35	3	Horizontal	354	2.39	-	27.50	4.73	37.12
AV	2.4835G	36.79	54.00	-17.21	41.68	3	Horizontal	354	2.39	-	27.50	4.73	37.12
PK	4.882G	44.27	74.00	-29.73	44.81	3	Horizontal	46	1.00	-	31.40	6.74	38.68
AV	4.882G	14.17	54.00	-39.83	14.71	3	Horizontal	46	1.00	-	31.40	6.74	38.68
PK	7.323G	51.14	74.00	-22.86	45.96	3	Horizontal	11	1.00	-	36.45	8.23	39.50
AV	7.323G	21.04	54.00	-32.96	15.86	3	Horizontal	11	1.00	-	36.45	8.23	39.50



2.4-2.4835GHz_BT-EDR(3Mbps)

2480MHz_TX

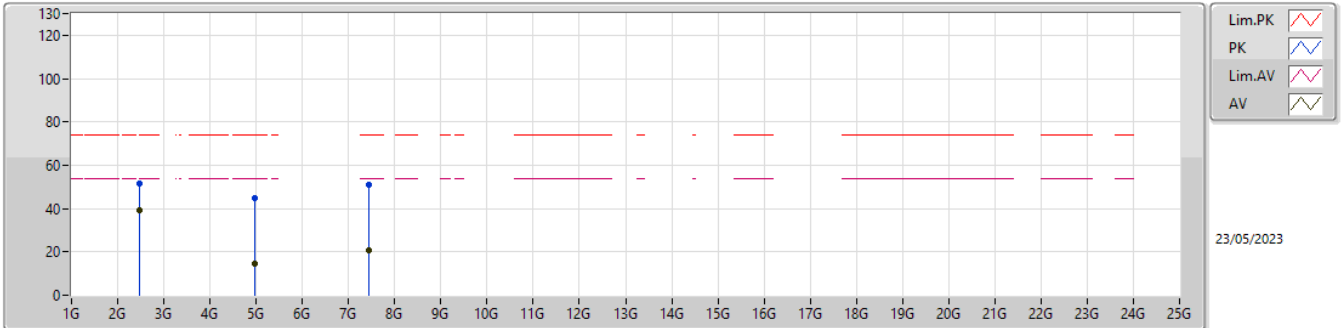

Type	Freq (Hz)	Level (dBuV/m)	Limit (dBuV/m)	Margin (dB)	Raw (dBuV)	Dist (m)	Condition	Azimuth (°)	Height (m)	Comment	AF (dB)	CL (dB)	PA (dB)
PK	2.4835G	51.69	74.00	-22.31	56.58	3	Vertical	346	2.59	-	27.50	4.73	37.12
AV	2.4835G	39.40	54.00	-14.60	44.29	3	Vertical	346	2.59	-	27.50	4.73	37.12
PK	4.96G	44.70	74.00	-29.30	45.14	3	Vertical	332	1.00	-	31.52	6.77	38.73
AV	4.96G	14.60	54.00	-39.40	15.04	3	Vertical	332	1.00	-	31.52	6.77	38.73
PK	7.44G	50.93	74.00	-23.07	45.82	3	Vertical	55	1.00	-	36.48	8.28	39.65
AV	7.44G	20.83	54.00	-33.17	15.72	3	Vertical	55	1.00	-	36.48	8.28	39.65



2.4-2.4835GHz_BT-EDR(3Mbps)

2480MHz_TX

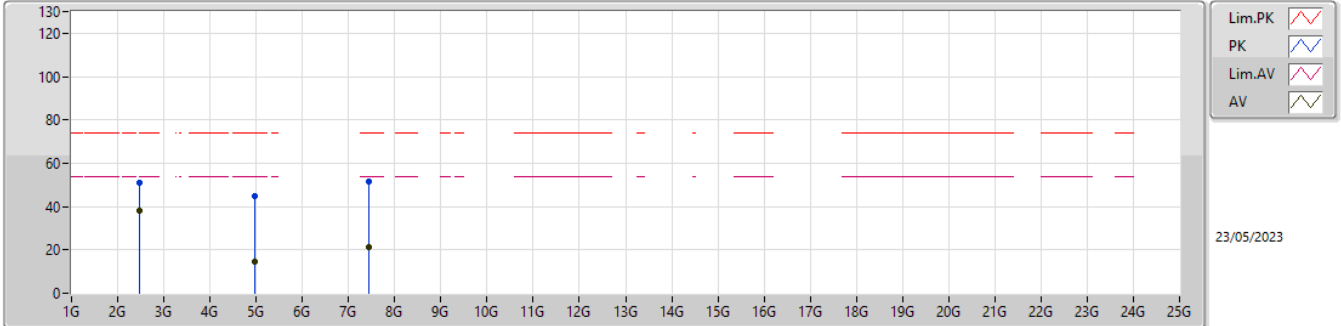

Type	Freq (Hz)	Level (dBuV/m)	Limit (dBuV/m)	Margin (dB)	Raw (dBuV)	Dist (m)	Condition	Azimuth (°)	Height (m)	Comment	AF (dB)	CL (dB)	PA (dB)
PK	2.4835G	50.90	74.00	-23.10	55.79	3	Horizontal	355	2.34	-	27.50	4.73	37.12
AV	2.4835G	38.13	54.00	-15.87	43.02	3	Horizontal	355	2.34	-	27.50	4.73	37.12
PK	4.96G	44.90	74.00	-29.10	45.34	3	Horizontal	29	1.00	-	31.52	6.77	38.73
AV	4.96G	14.80	54.00	-39.20	15.24	3	Horizontal	29	1.00	-	31.52	6.77	38.73
PK	7.44G	51.37	74.00	-22.63	46.26	3	Horizontal	44	1.00	-	36.48	8.28	39.65
AV	7.44G	21.27	54.00	-32.73	16.16	3	Horizontal	44	1.00	-	36.48	8.28	39.65

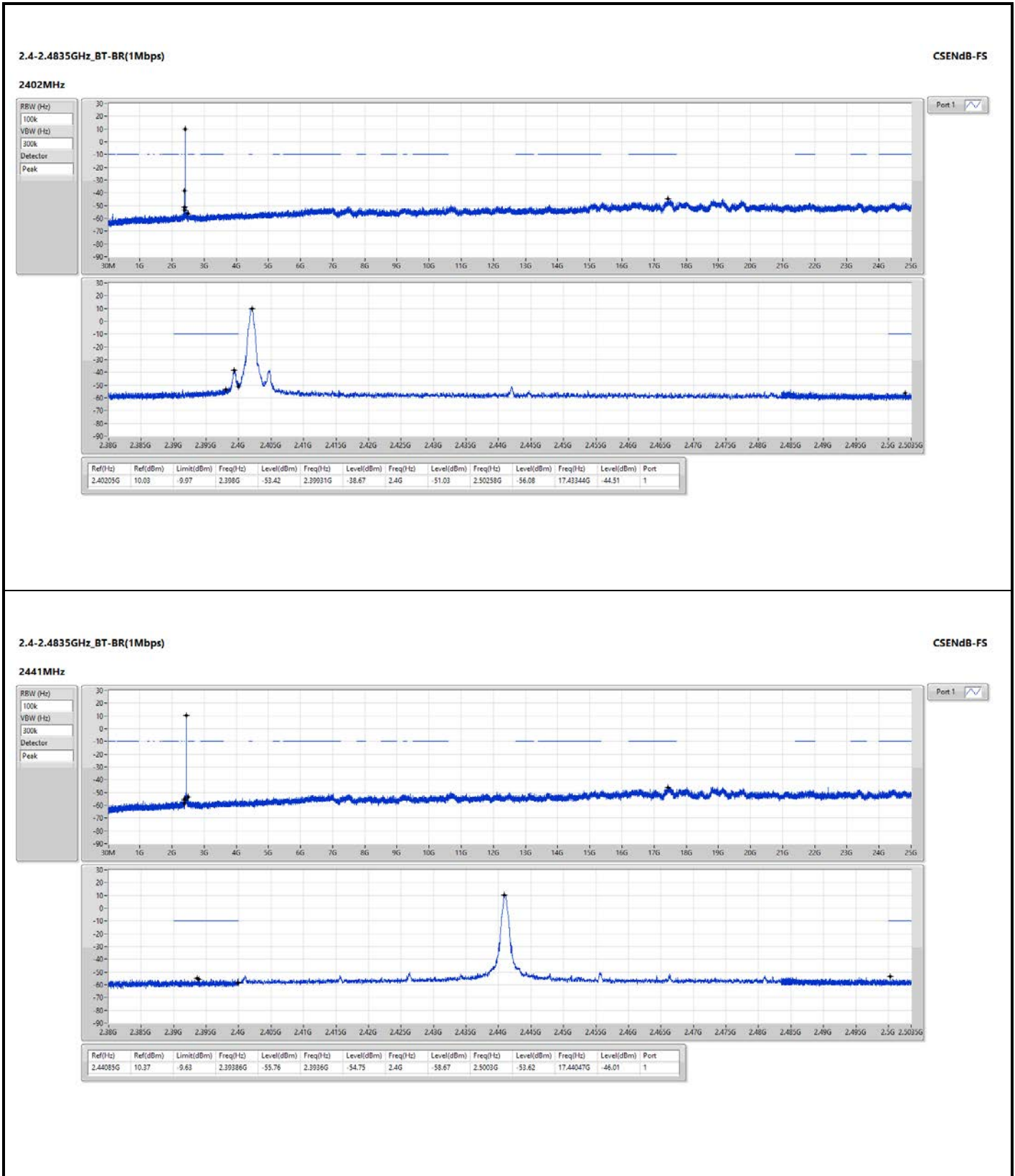

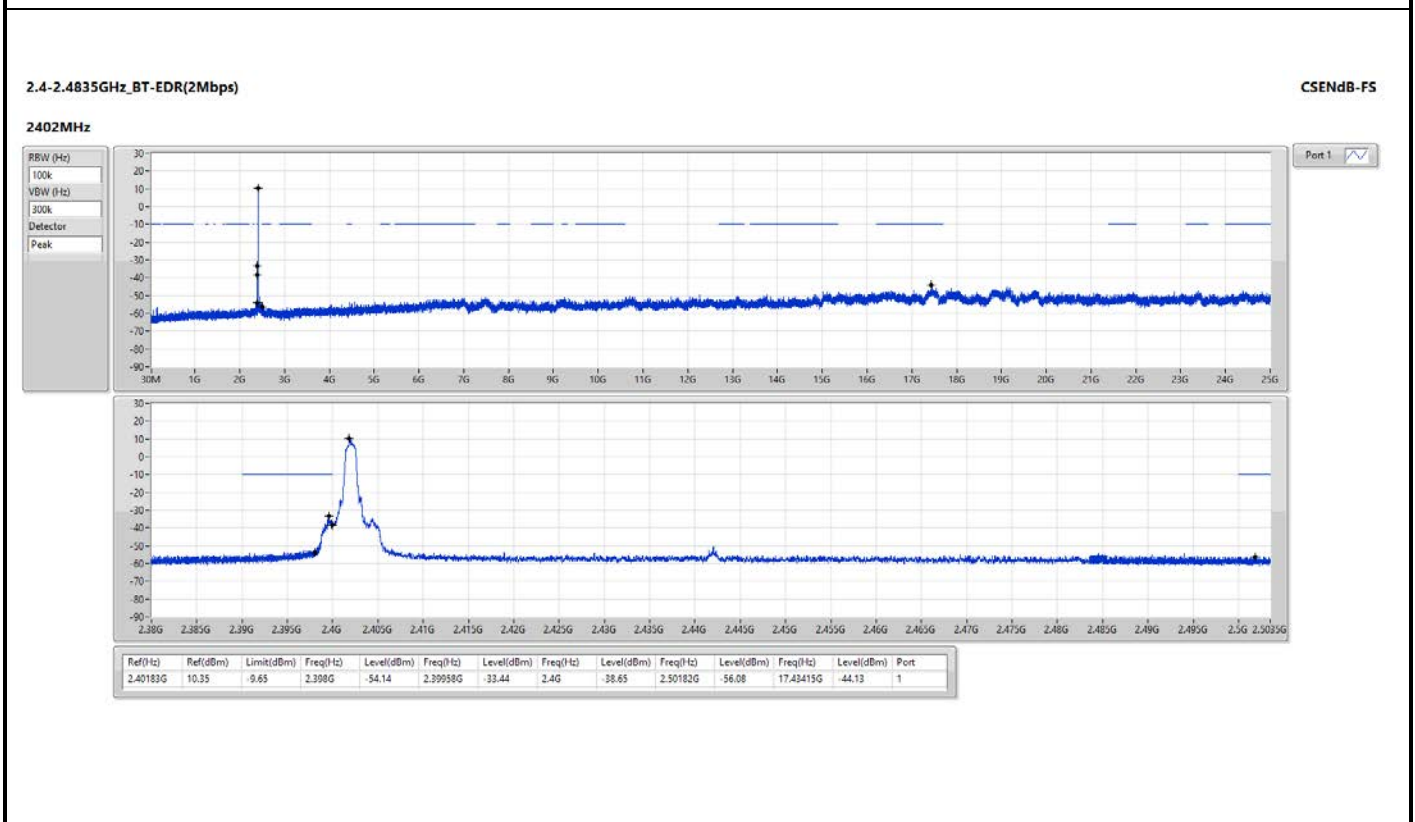
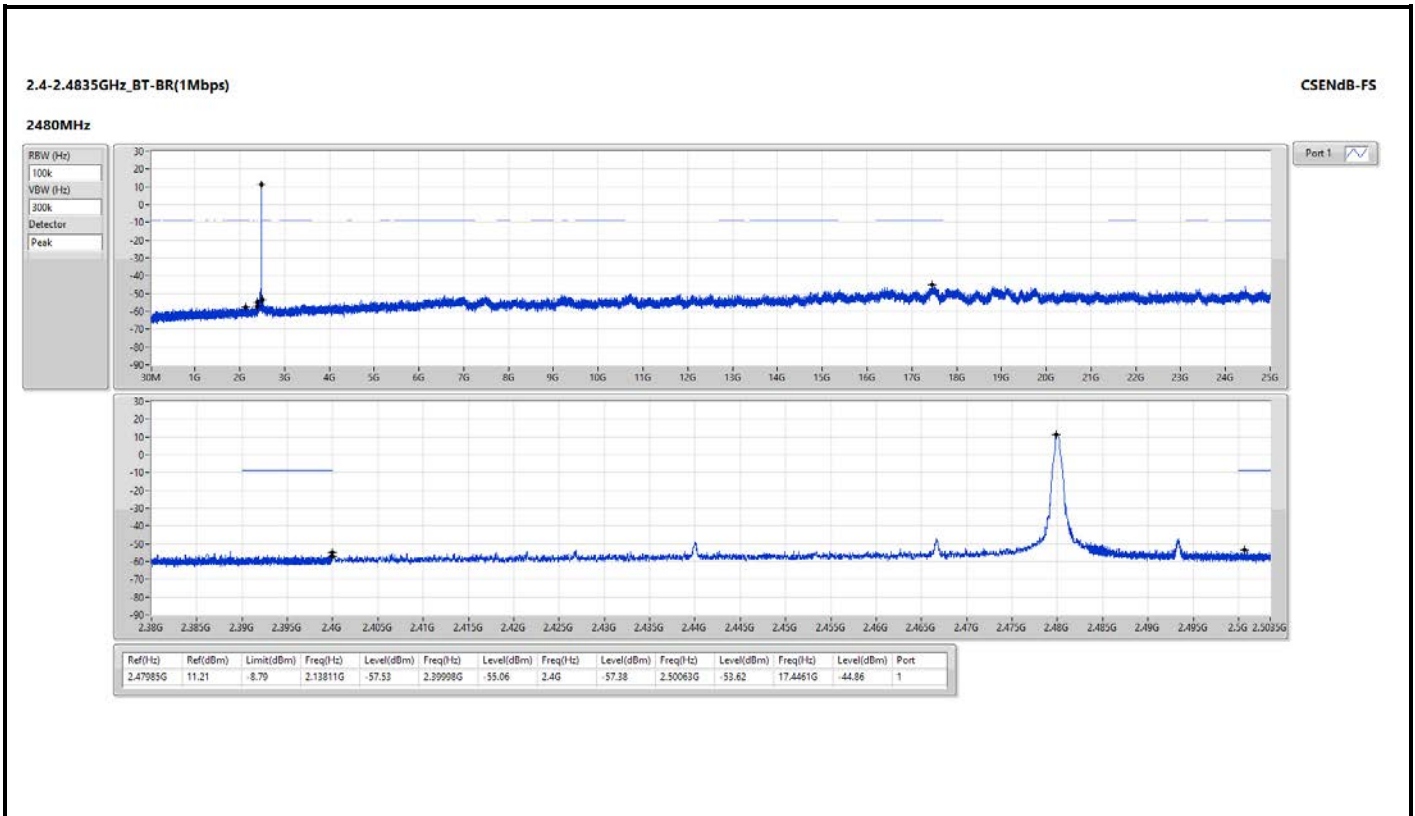

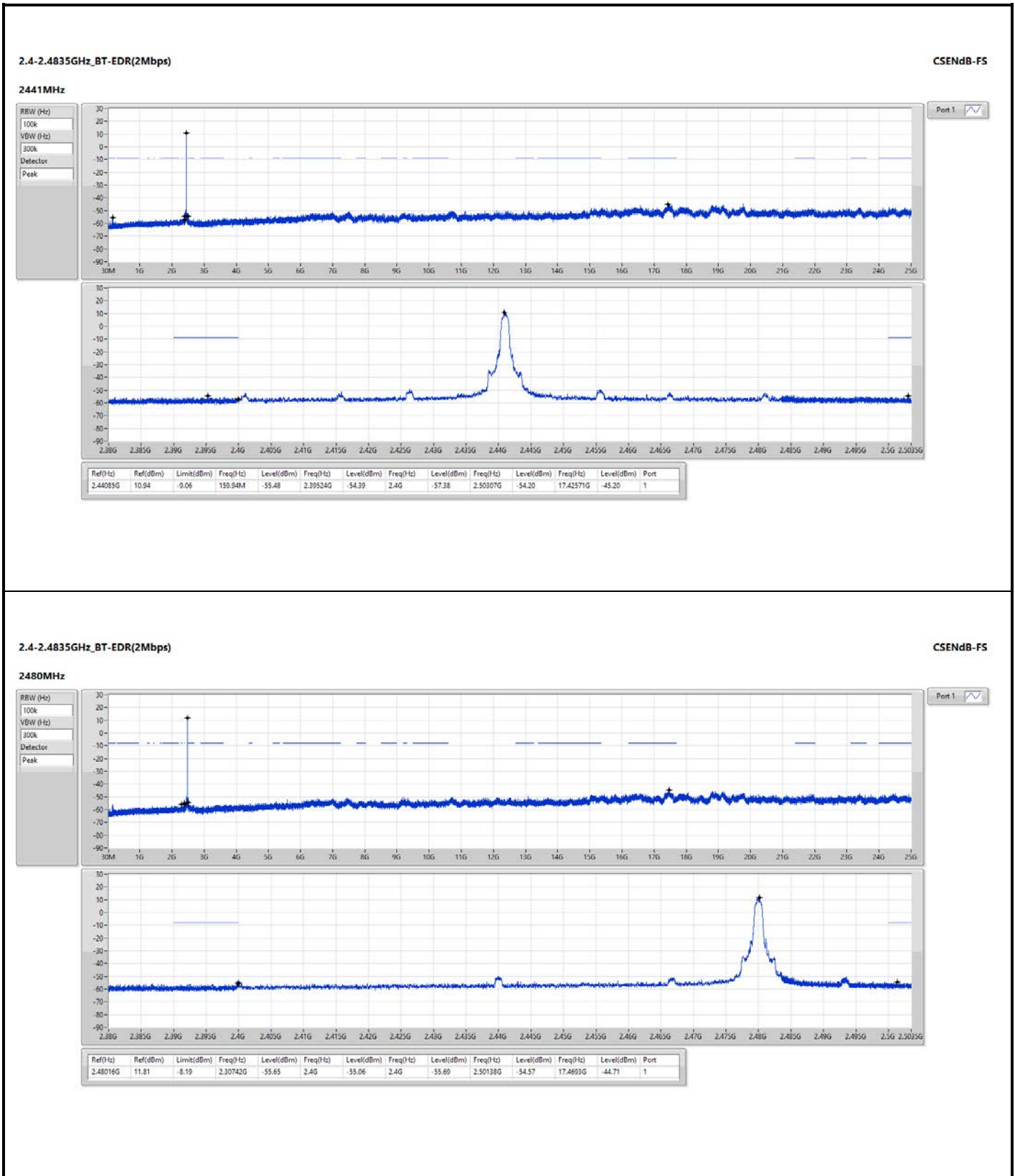

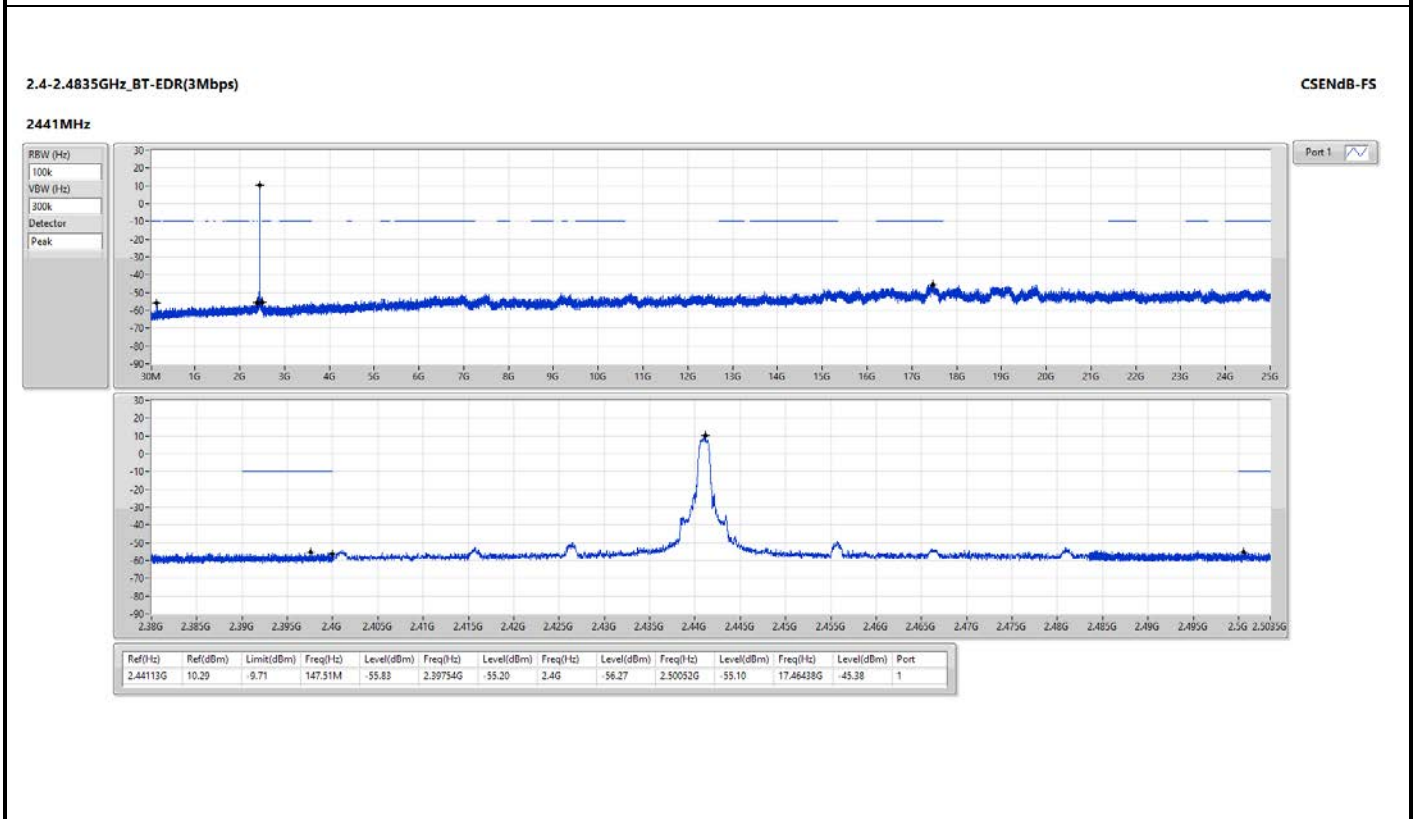
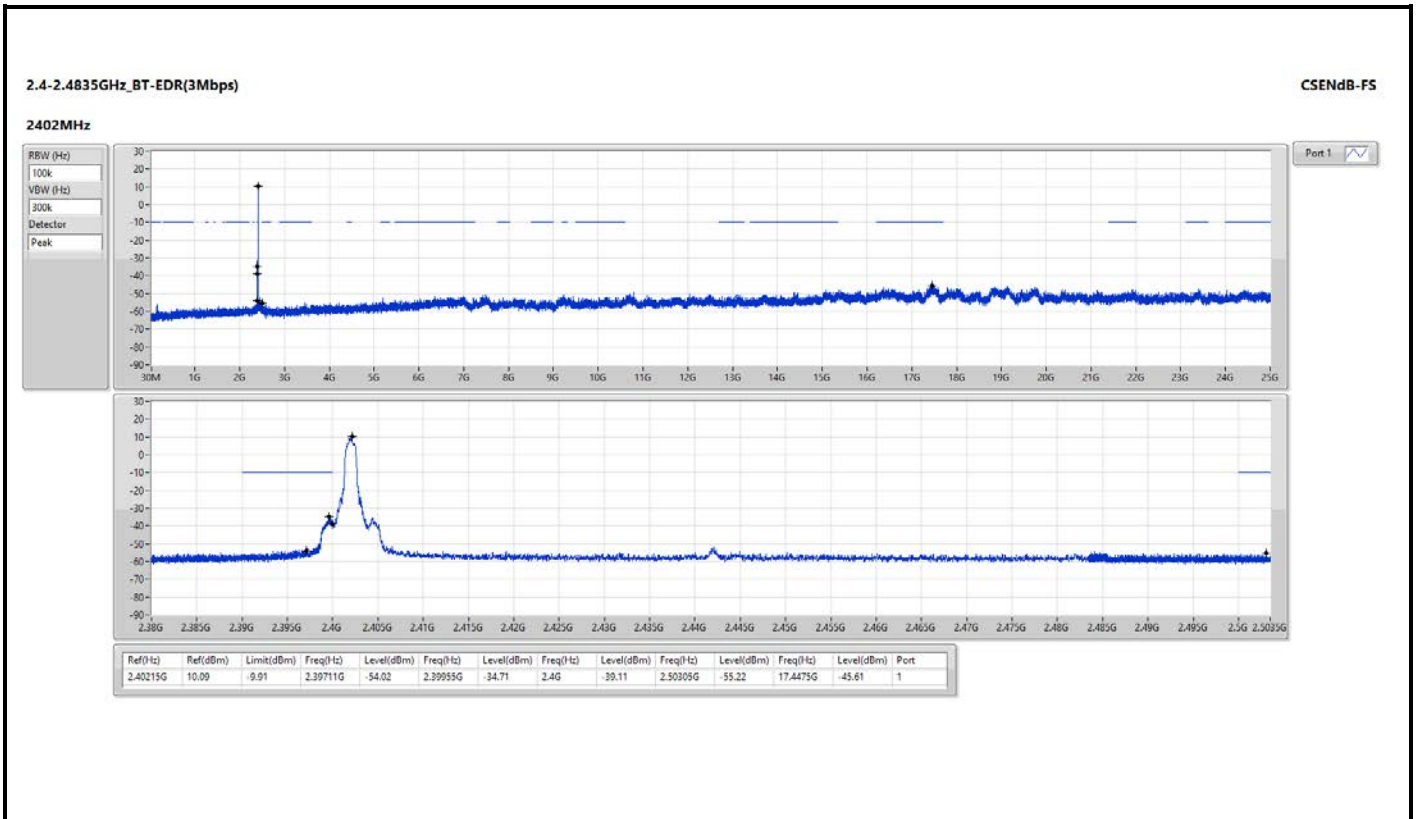

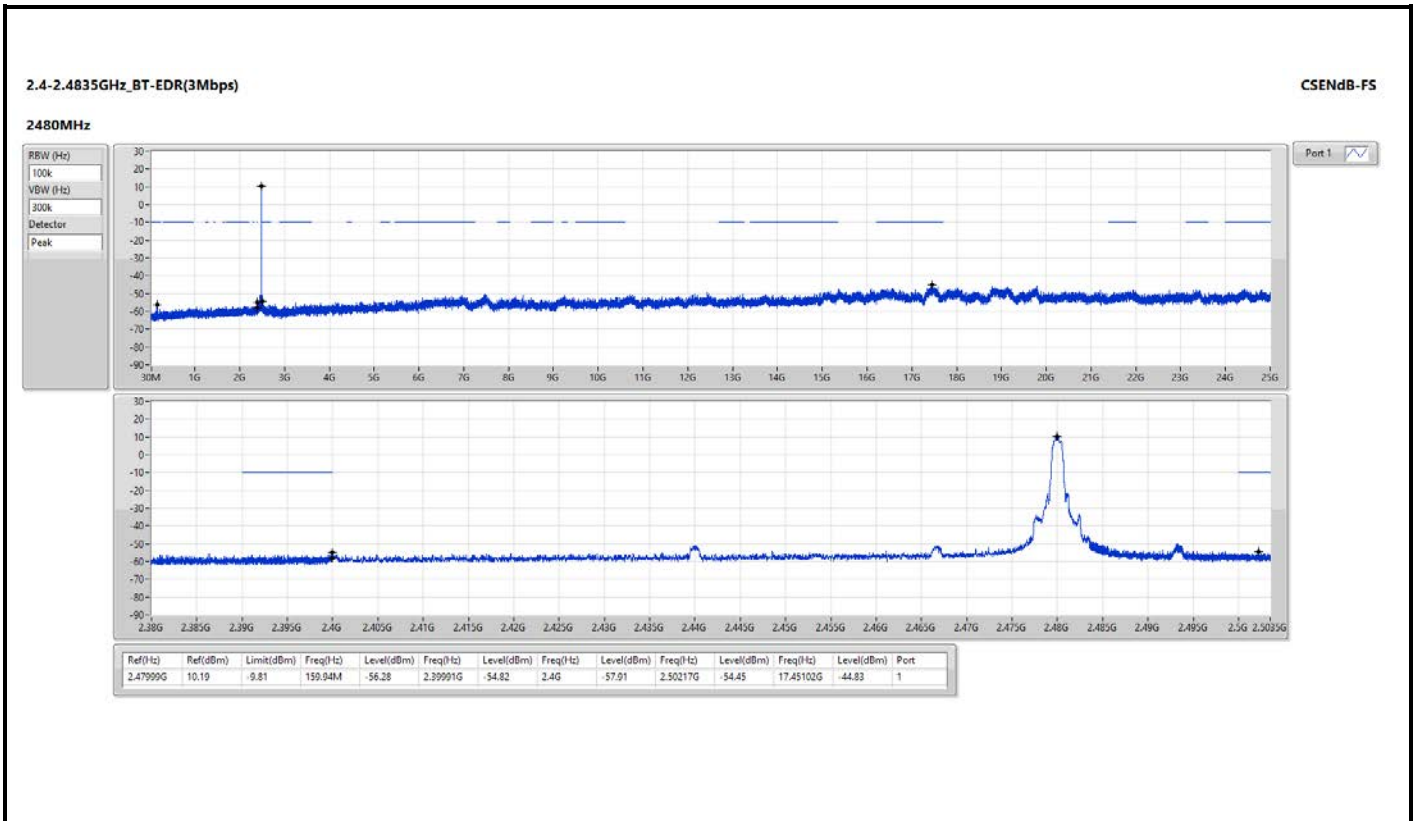

2.4-2.4835GHz_BT-BR(1Mbps)

2402MHz

Hopping Ch Bandedge (Non-restricted Band)

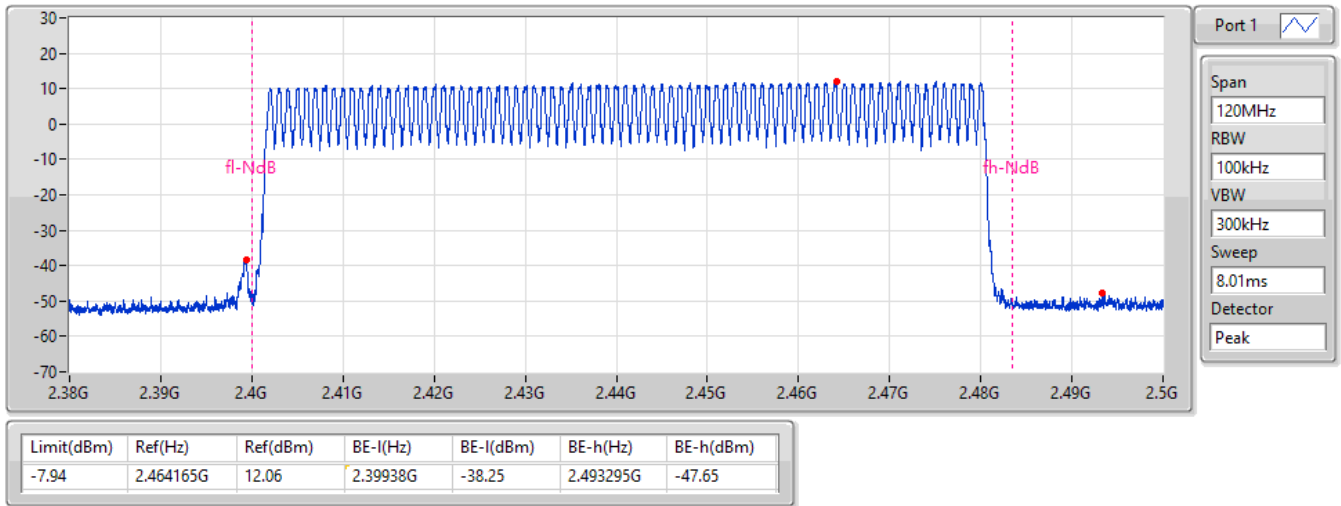

2.4-2.4835GHz_BT-EDR(2Mbps)

2402MHz

Hopping Ch Bandedge (Non-restricted Band)

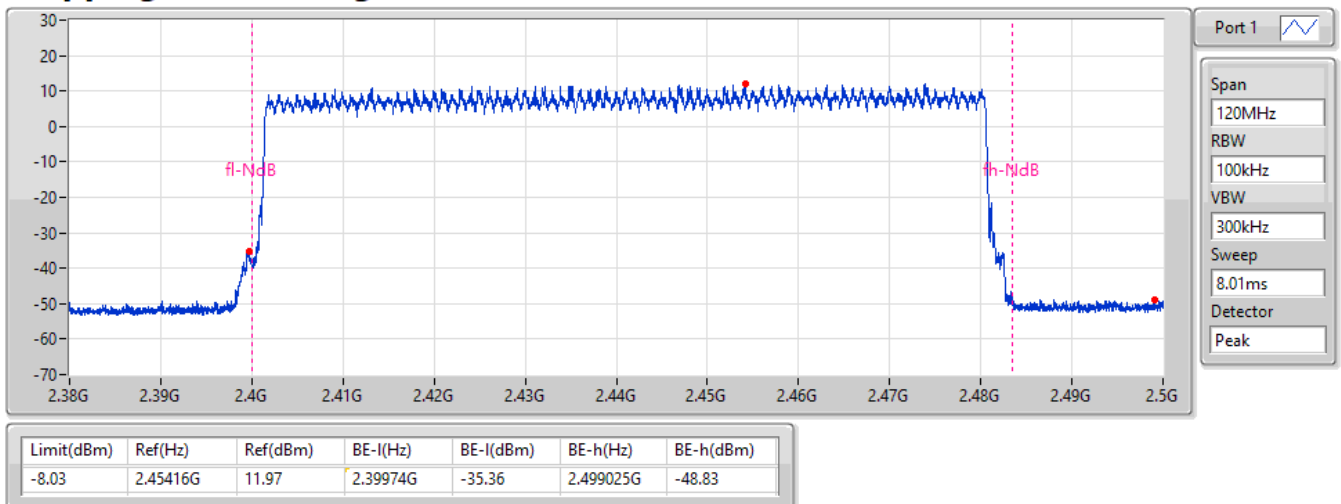

2.4-2.4835GHz_BT-EDR(3Mbps)

2402MHz

Hopping Ch Bandedge (Non-restricted Band)

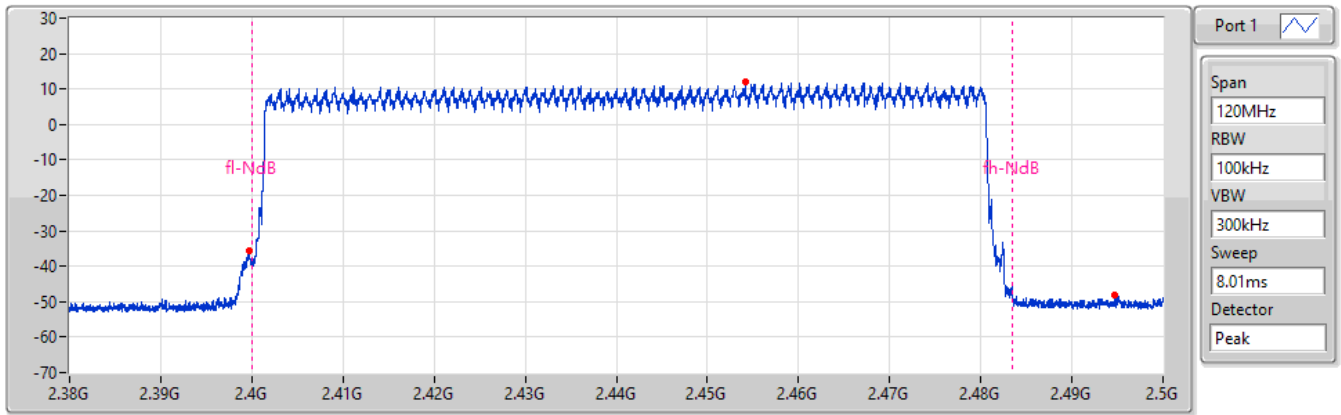

Limit(dBm)	Ref(Hz)	Ref(dBm)	BE-l(Hz)	BE-l(dBm)	BE-h(Hz)	BE-h(dBm)
-8.15	2.45416G	11.85	2.39965G	-35.7	2.494675G	-48.29



Summary

Mode	Total Power (dBm)	Power (W)
2.4-2.4835GHz	-	-
BT-BR(1Mbps)	11.49	0.01409
BT-EDR(2Mbps)	12.96	0.01977
BT-EDR(3Mbps)	13.23	0.02104

Result

Mode	Result	Antenna Gain (dBi)	Total Power (dBm)	Power Limit (dBm)	EIRP (dBm)	EIRP Limit (dBm)
BT-BR(1Mbps)	-	-	-	-	-	-
2402MHz	Pass	-6.31	10.08	21.00	3.77	36.00
2441MHz	Pass	-6.31	10.89	21.00	4.58	36.00
2480MHz	Pass	-6.31	11.49	21.00	5.18	36.00
BT-EDR(2Mbps)	-	-	-	-	-	-
2402MHz	Pass	-6.31	11.39	21.00	5.08	36.00
2441MHz	Pass	-6.31	12.16	21.00	5.85	36.00
2480MHz	Pass	-6.31	12.96	21.00	6.65	36.00
BT-EDR(3Mbps)	-	-	-	-	-	-
2402MHz	Pass	-6.31	11.52	21.00	5.21	36.00
2441MHz	Pass	-6.31	12.34	21.00	6.03	36.00
2480MHz	Pass	-6.31	13.23	21.00	6.92	36.00

DG = Directional Gain; Port X = Port X output power



Conducted Output Power(Average)

Appendix C.2

Summary

Mode	Total Power (dBm)	Power (W)
2.4-2.4835GHz	-	-
BT-BR(1Mbps)	10.95	0.01245
BT-EDR(2Mbps)	10.23	0.01054
BT-EDR(3Mbps)	10.33	0.01079

Result

Mode	Result	Antenna Gain (dBi)	Total Power (dBm)	Power Limit (dBm)	EIRP (dBm)	EIRP Limit (dBm)
BT-BR(1Mbps)	-	-	-	-	-	-
2402MHz	Pass	-6.31	9.55	-	3.24	-
2441MHz	Pass	-6.31	10.35	-	4.04	-
2480MHz	Pass	-6.31	10.95	-	4.64	-
BT-EDR(2Mbps)	-	-	-	-	-	-
2402MHz	Pass	-6.31	8.31	-	2.00	-
2441MHz	Pass	-6.31	8.95	-	2.64	-
2480MHz	Pass	-6.31	10.23	-	3.92	-
BT-EDR(3Mbps)	-	-	-	-	-	-
2402MHz	Pass	-6.31	8.41	-	2.10	-
2441MHz	Pass	-6.31	8.97	-	2.66	-
2480MHz	Pass	-6.31	10.33	-	4.02	-

Note: Average power is for reference only



Summary

Mode	Max-Hop No
2.4-2.4835GHz	-
BT-BR(1Mbps)	79
BT-EDR(2Mbps)	79
BT-EDR(3Mbps)	79

Result

Mode	Result	Hopping No	Limit
BT-BR(1Mbps)	-	-	-
2402MHz	Pass	79	15
BT-EDR(2Mbps)	-	-	-
2402MHz	Pass	79	15
BT-EDR(3Mbps)	-	-	-
2402MHz	Pass	79	15



2.4-2.4835GHz_BT-BR(1Mbps)

Hopping-FS

2402MHz

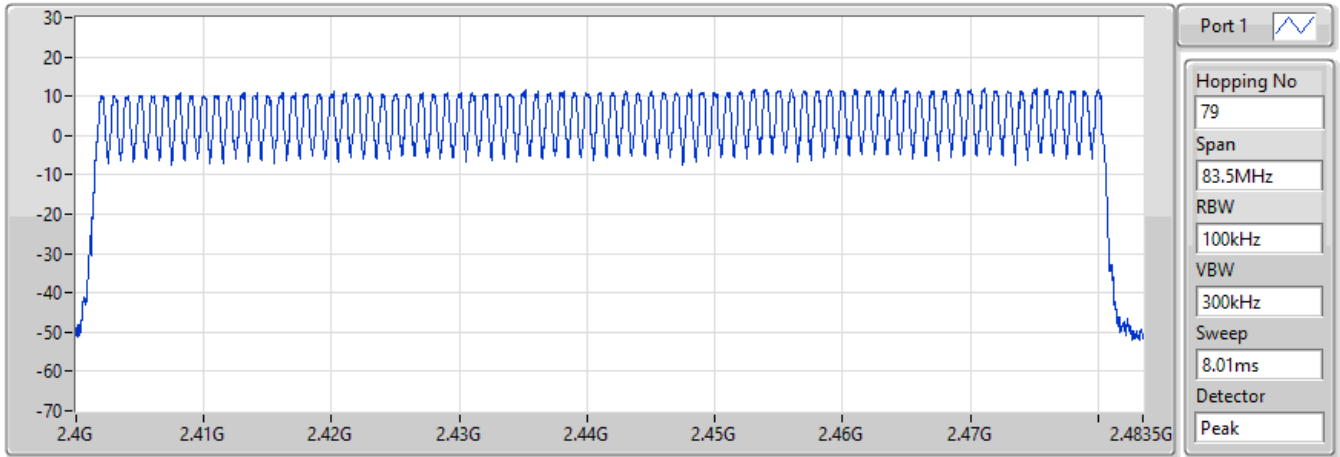

Hopping No	Limit
79	15

2.4-2.4835GHz_BT-EDR(2Mbps)

Hopping-FS

2402MHz

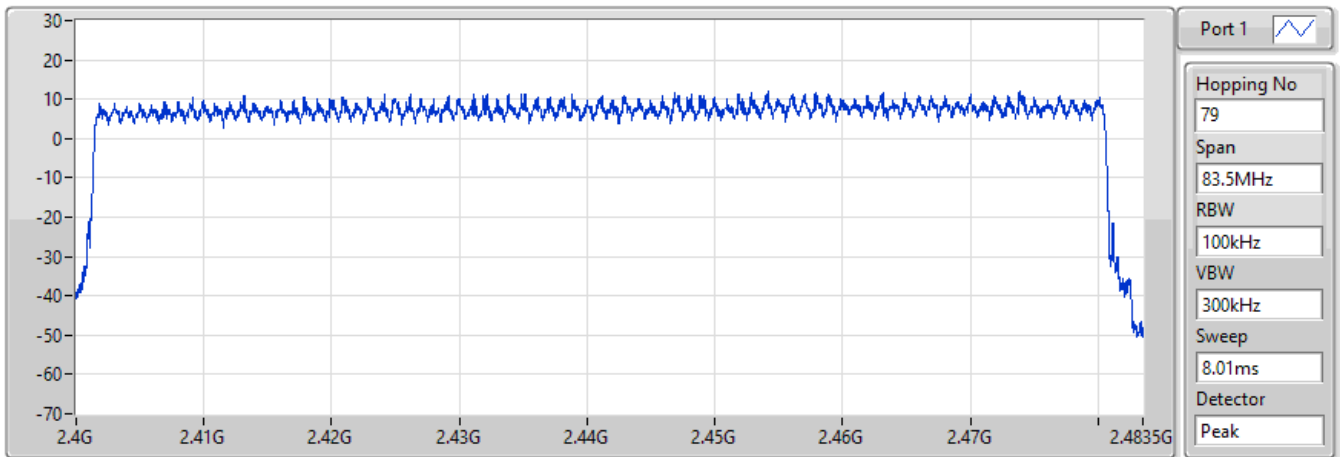

Hopping No	Limit
79	15



2.4-2.4835GHz_BT-EDR(3Mbps)

Hopping-FS

2402MHz

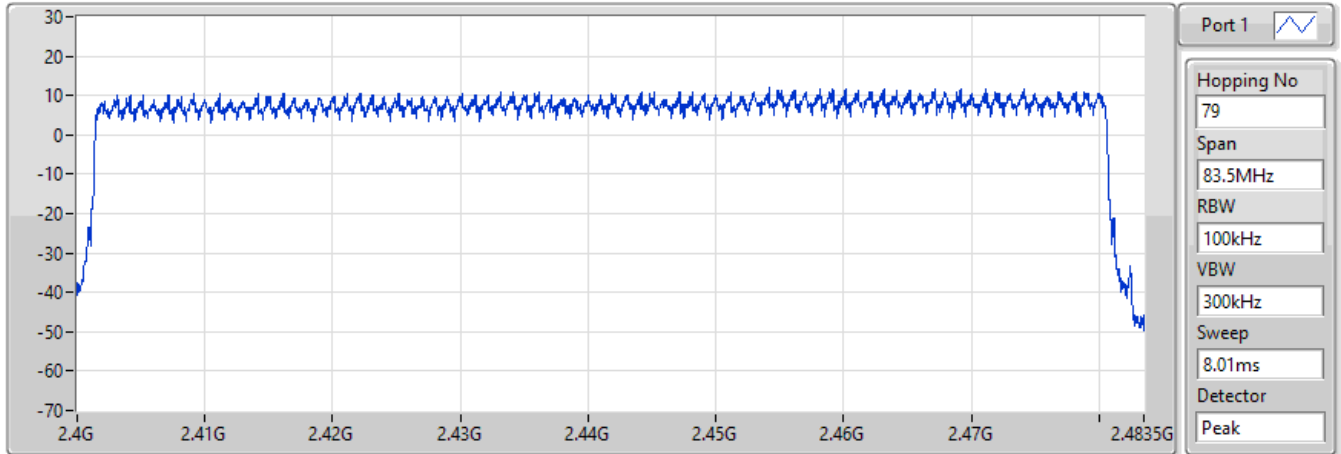

Hopping No	Limit
79	15



Summary

Mode	Max-N dB (Hz)	Max-OBW (Hz)	ITU-Code	Min-N dB (Hz)	Min-OBW (Hz)
2.4-2.4835GHz	-	-	-	-	-
BT-BR(1Mbps)	981.75k	890.805k	891KF1D	979k	888.306k
BT-EDR(2Mbps)	1.326M	1.188M	1M19G1D	1.323M	1.187M
BT-EDR(3Mbps)	1.304M	1.196M	1M20G1D	1.301M	1.193M

Max-N dB = Maximum 20dB down bandwidth; Max-OBW = Maximum 99% occupied bandwidth;
Min-N dB = Minimum 20dB down bandwidth; Min-OBW = Minimum 99% occupied bandwidth

Result

Mode	Result	Limit (Hz)	Port 1-N dB (Hz)	Port 1-OBW (Hz)
BT-BR(1Mbps)	-	-	-	-
2402MHz	Pass	Inf	981.75k	890.805k
2441MHz	Pass	Inf	979k	890.805k
2480MHz	Pass	Inf	979k	888.306k
BT-EDR(2Mbps)	-	-	-	-
2402MHz	Pass	Inf	1.326M	1.187M
2441MHz	Pass	Inf	1.323M	1.187M
2480MHz	Pass	Inf	1.326M	1.188M
BT-EDR(3Mbps)	-	-	-	-
2402MHz	Pass	Inf	1.304M	1.193M
2441MHz	Pass	Inf	1.301M	1.193M
2480MHz	Pass	Inf	1.304M	1.196M

Port X-N dB = Port X 20dB down bandwidth;
Port X-OBW = Port X 99% occupied bandwidth

2.4-2.4835GHz_BT-BR(1Mbps)

EBW-FS

2402MHz

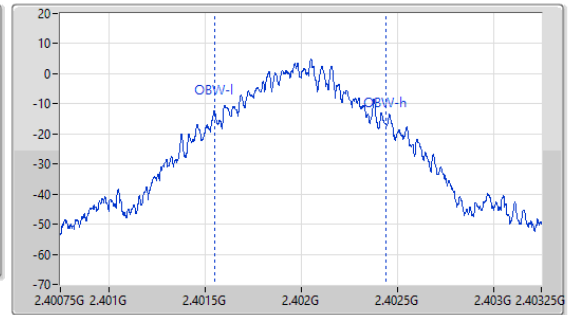
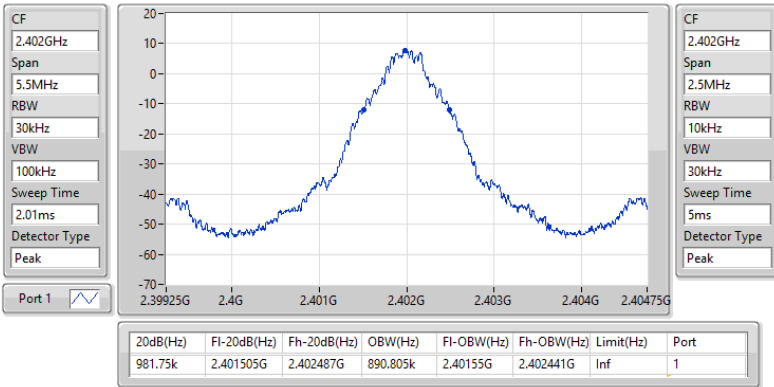

2.4-2.4835GHz_BT-BR(1Mbps)

EBW-FS

2441MHz

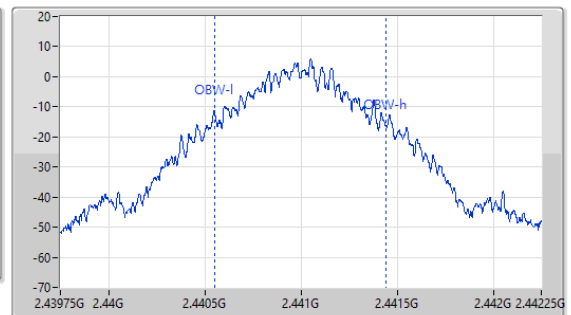
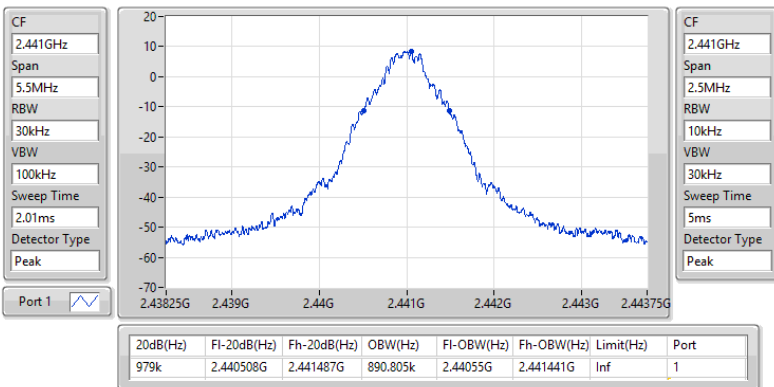



2.4-2.4835GHz_BT-BR(1Mbps)

EBW-FS

2480MHz

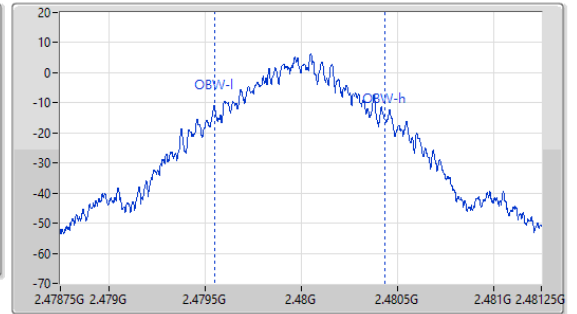
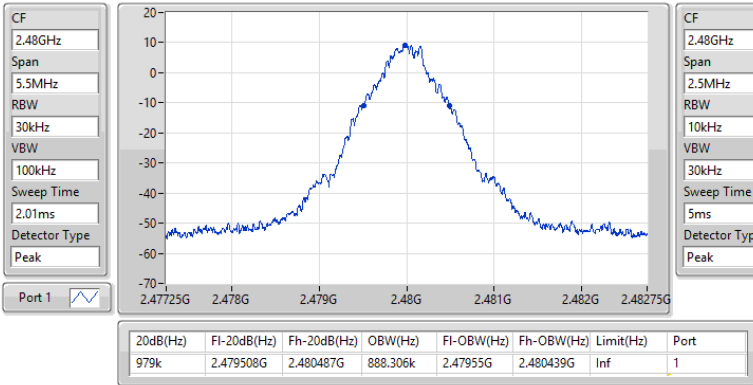

2.4-2.4835GHz_BT-EDR(2Mbps)

EBW-FS

2402MHz

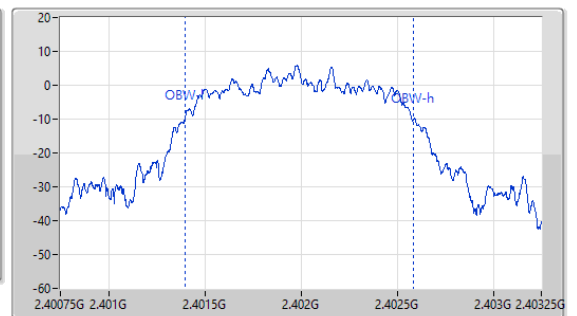
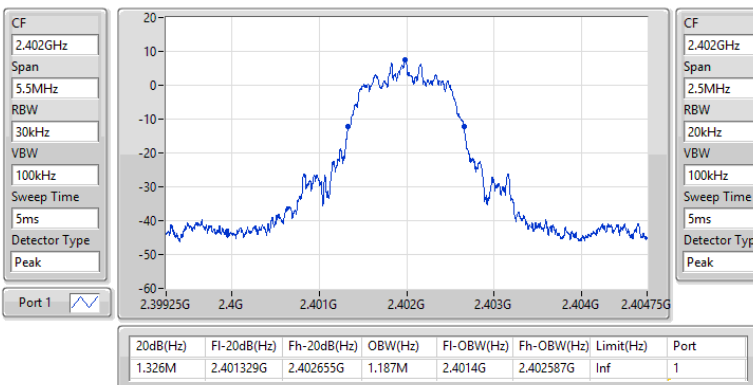



2.4-2.4835GHz_BT-EDR(2Mbps)

EBW-FS

2441MHz

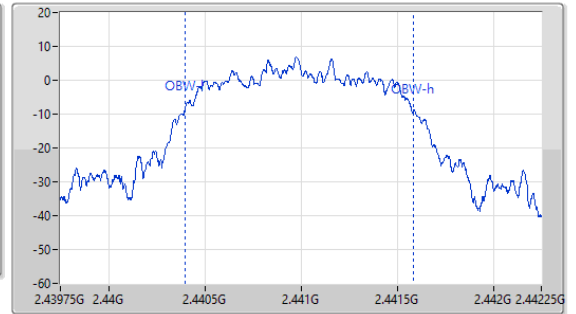
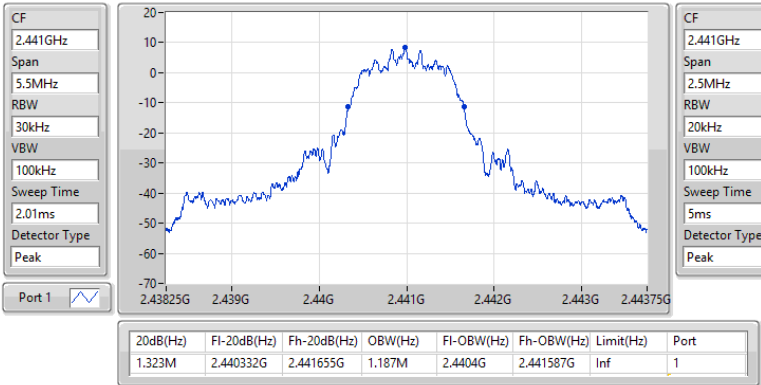

2.4-2.4835GHz_BT-EDR(2Mbps)

EBW-FS

2480MHz

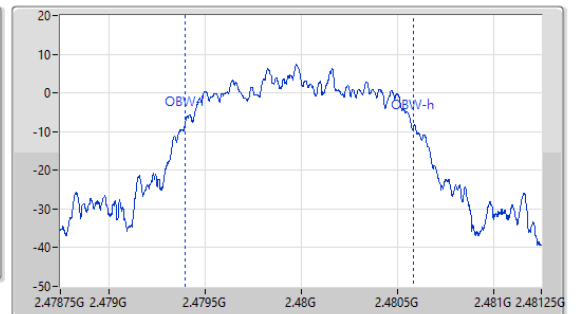
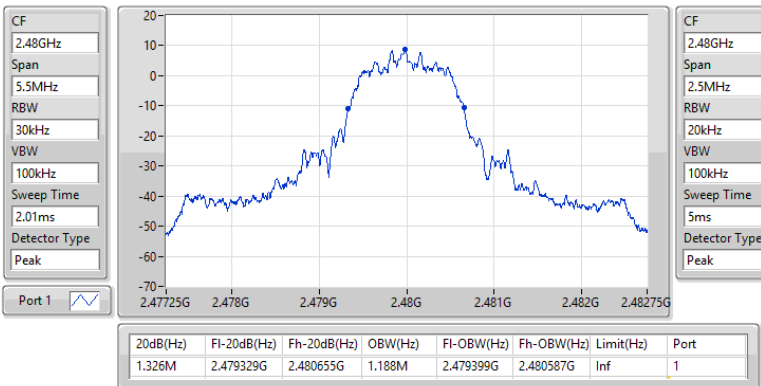

2.4-2.4835GHz_BT-EDR(3Mbps)

EBW-FS

2402MHz

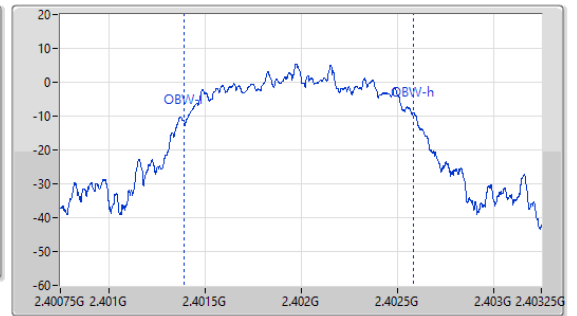
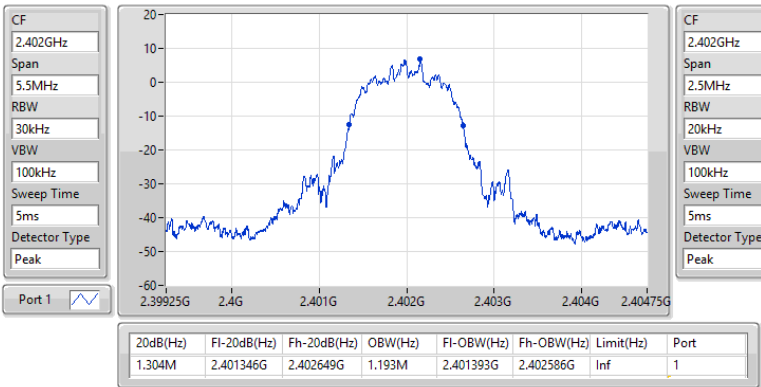

2.4-2.4835GHz_BT-EDR(3Mbps)

EBW-FS

2441MHz

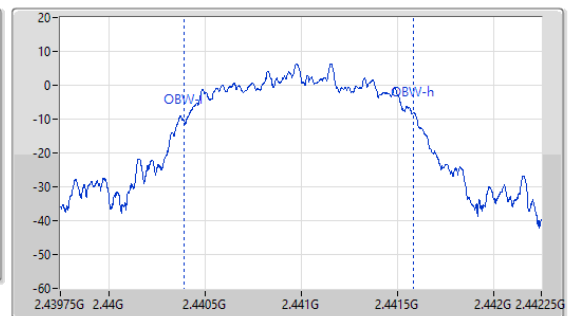
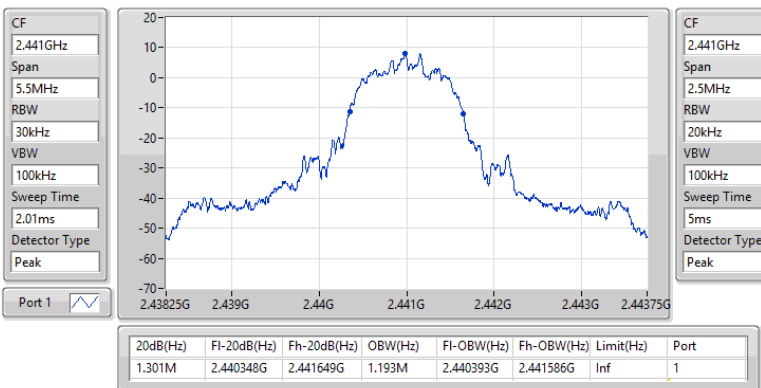

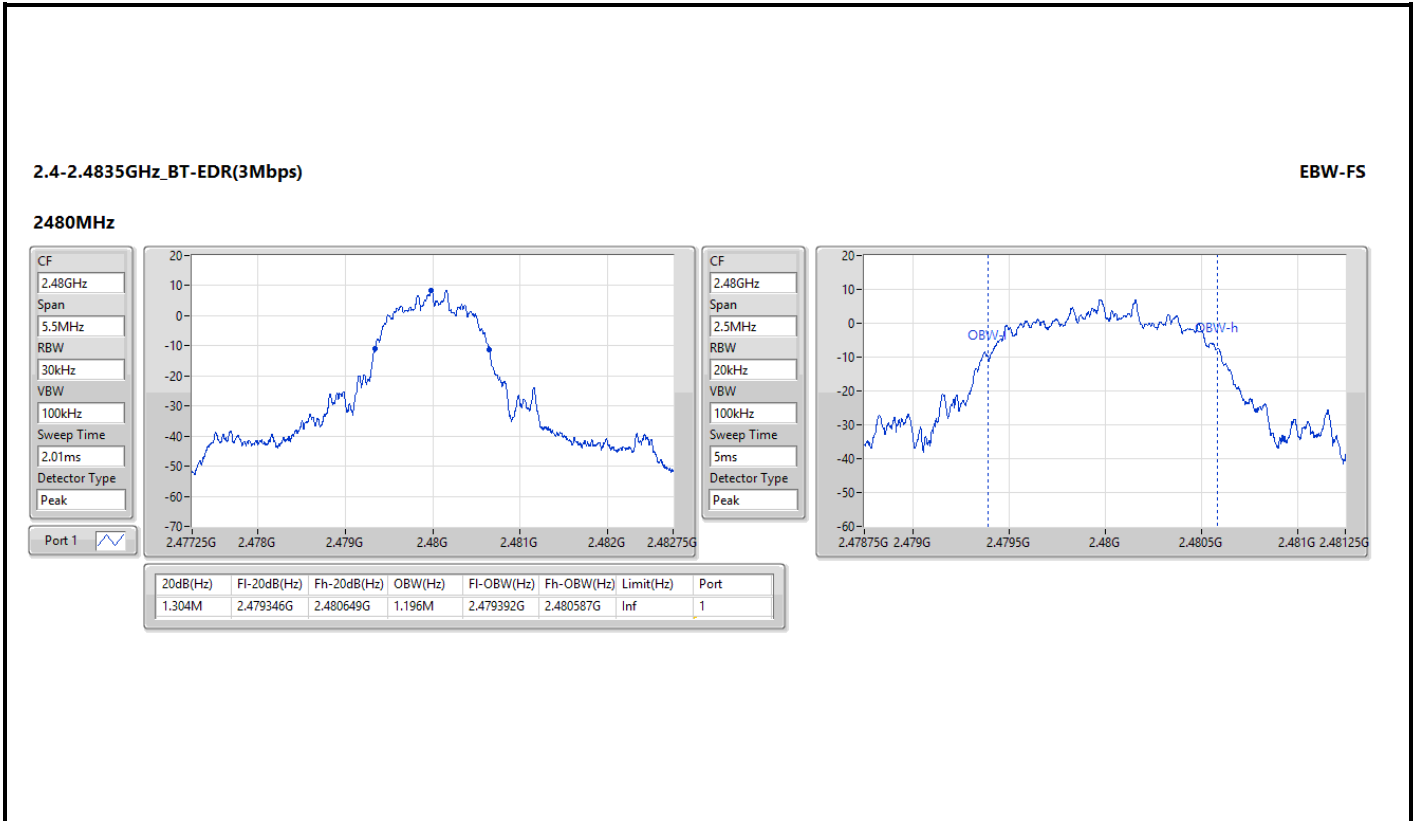



Summary

Mode	Max-Space (Hz)	Min-Space (Hz)
2.4-2.4835GHz	-	-
BT-BR(1Mbps)	1.002M	1.0005M
BT-EDR(2Mbps)	1.002M	1.0005M
BT-EDR(3Mbps)	1.002M	1.0005M

Result

Mode	Result	Fl (Hz)	Fh (Hz)	Ch.Space (Hz)	Limit (Hz)
BT-BR(1Mbps)	-	-	-	-	-
2402MHz	Pass	2.401981G	2.402982G	1.0005M	653.8455k
2441MHz	Pass	2.440984G	2.441985G	1.0005M	652.014k
2480MHz	Pass	2.478981G	2.479983G	1.002M	652.014k
BT-EDR(2Mbps)	-	-	-	-	-
2402MHz	Pass	2.401981G	2.402983G	1.002M	883.116k
2441MHz	Pass	2.440983G	2.441983G	1.0005M	881.118k
2480MHz	Pass	2.478981G	2.479983G	1.002M	883.116k
BT-EDR(3Mbps)	-	-	-	-	-
2402MHz	Pass	2.401983G	2.402985G	1.002M	868.464k
2441MHz	Pass	2.440983G	2.441985G	1.002M	866.466k
2480MHz	Pass	2.478983G	2.479983G	1.0005M	868.464k



2.4-2.4835GHz_BT-BR(1Mbps)

Channel Separation-FS

2.402G/2.403GHz

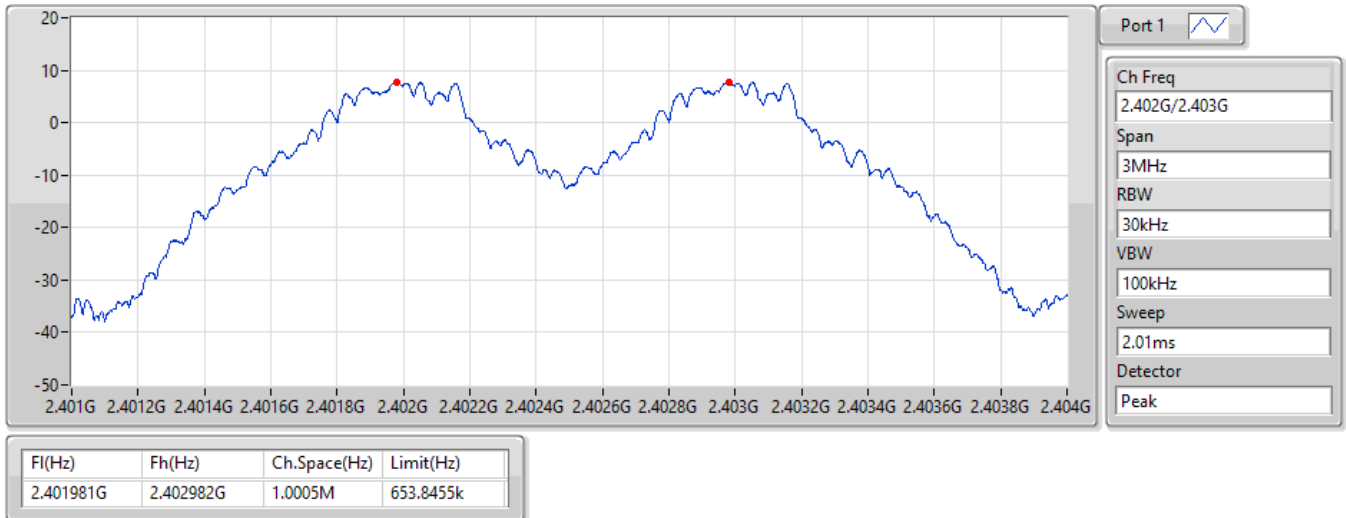

2.4-2.4835GHz_BT-BR(1Mbps)

Channel Separation-FS

2.441G/2.442GHz



2.4-2.4835GHz_BT-BR(1Mbps)

Channel Separation-FS

2.48G/2.479GHz



F1(Hz)	Fh(Hz)	Ch.Space(Hz)	Limit(Hz)
2.478981G	2.479983G	1.002M	652.014k

2.4-2.4835GHz_BT-EDR(2Mbps)

Channel Separation-FS

2.402G/2.403GHz

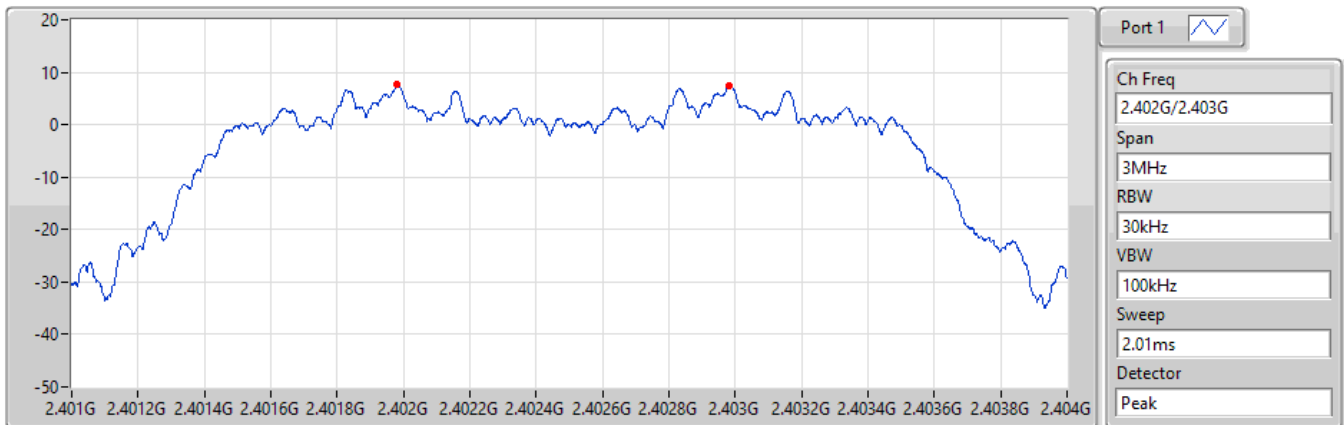

F1(Hz)	Fh(Hz)	Ch.Space(Hz)	Limit(Hz)
2.401981G	2.402983G	1.002M	883.116k

2.4-2.4835GHz_BT-EDR(2Mbps)

Channel Separation-FS

2.441G/2.442GHz

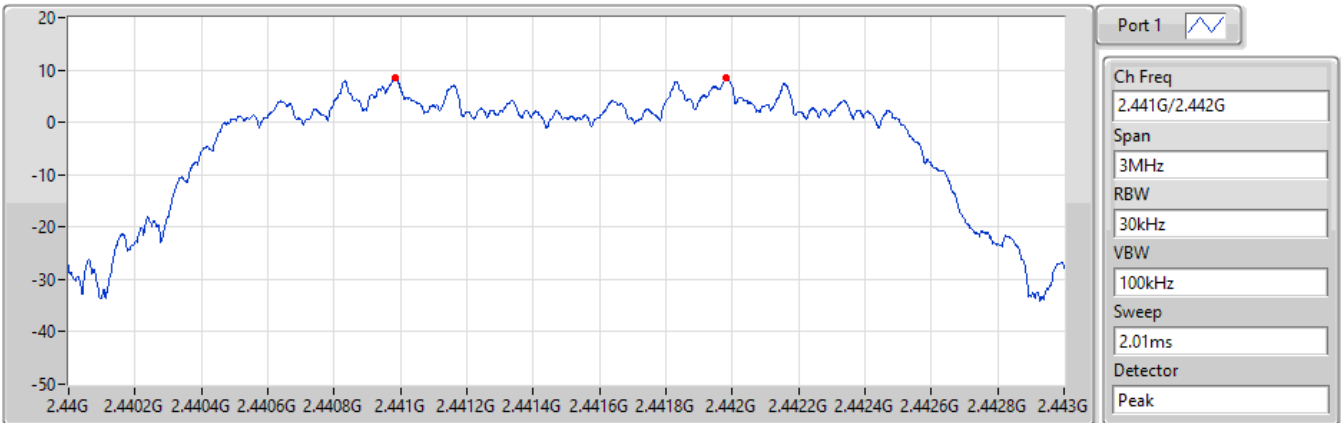

F1(Hz)	Fh(Hz)	Ch.Space(Hz)	Limit(Hz)
2.440983G	2.441983G	1.0005M	881.118k

2.4-2.4835GHz_BT-EDR(2Mbps)

Channel Separation-FS

2.48G/2.479GHz

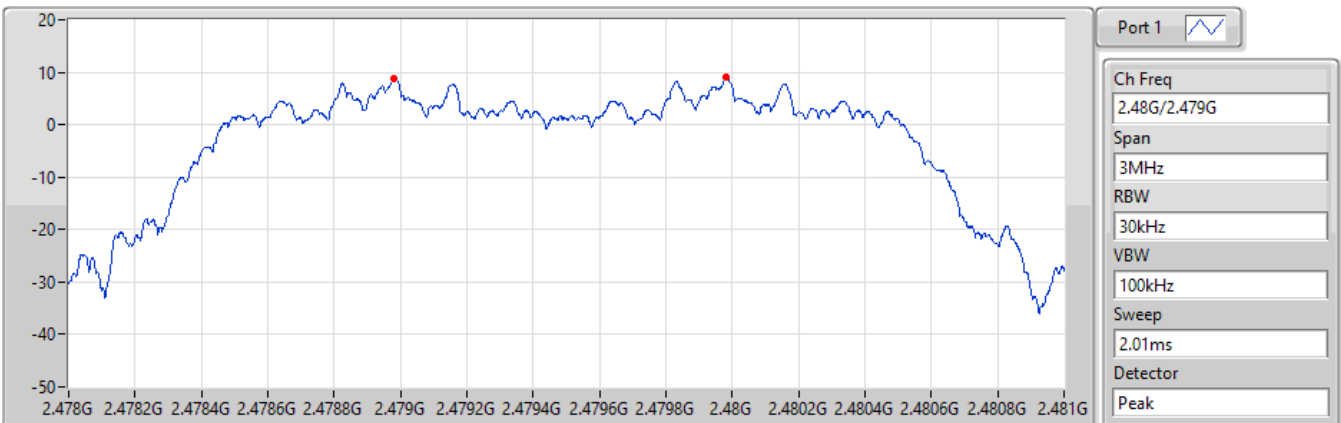

F1(Hz)	Fh(Hz)	Ch.Space(Hz)	Limit(Hz)
2.478981G	2.479983G	1.002M	883.116k



2.4-2.4835GHz_BT-EDR(3Mbps)

Channel Separation-FS

2.402G/2.403GHz

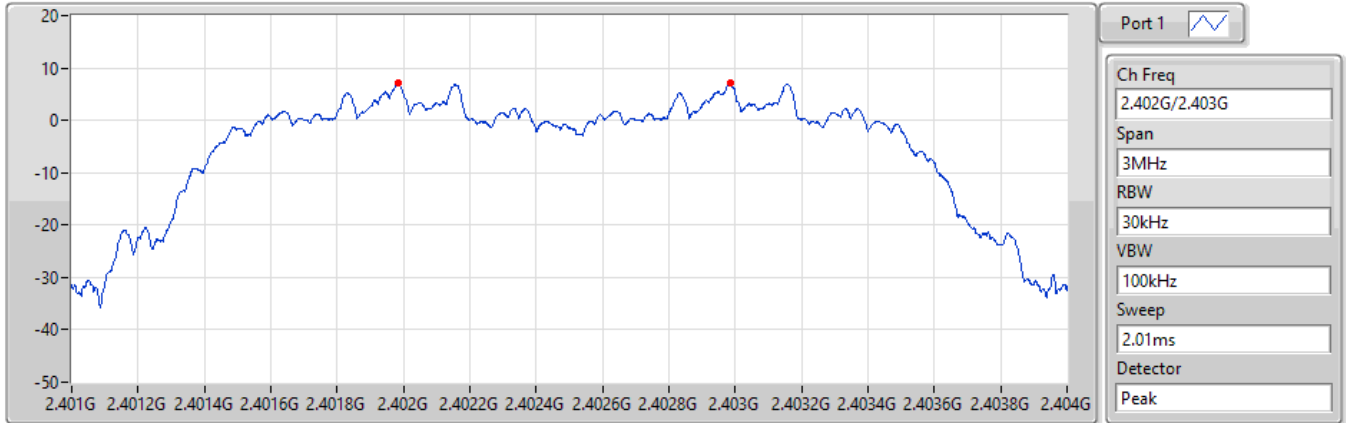

F1(Hz)	Fh(Hz)	Ch.Space(Hz)	Limit(Hz)
2.401983G	2.402985G	1.002M	868.464k

2.4-2.4835GHz_BT-EDR(3Mbps)

Channel Separation-FS

2.441G/2.442GHz

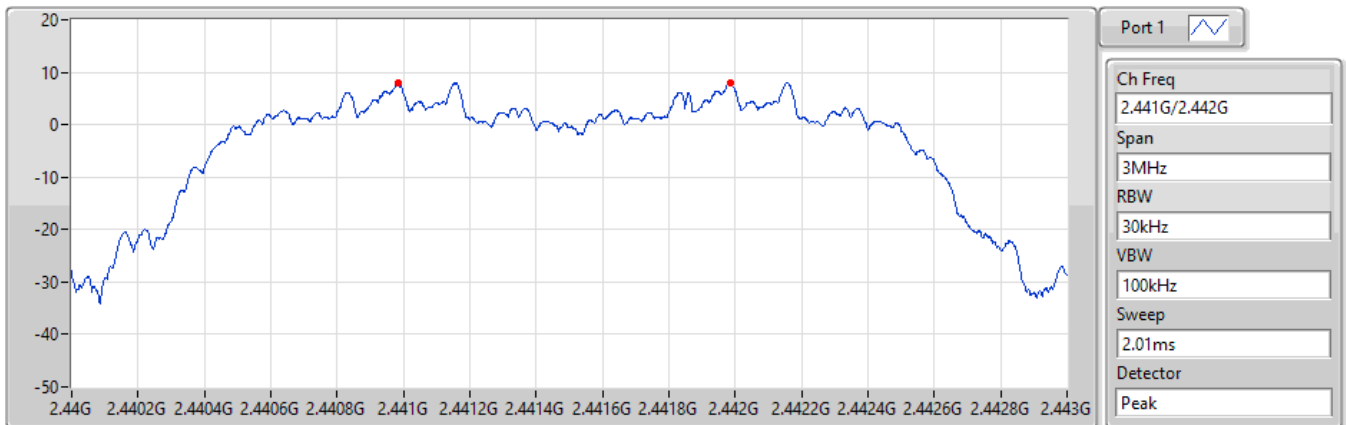

F1(Hz)	Fh(Hz)	Ch.Space(Hz)	Limit(Hz)
2.440983G	2.441985G	1.002M	866.466k



2.4-2.4835GHz_BT-EDR(3Mbps)

Channel Separation-FS

2.48G/2.479GHz

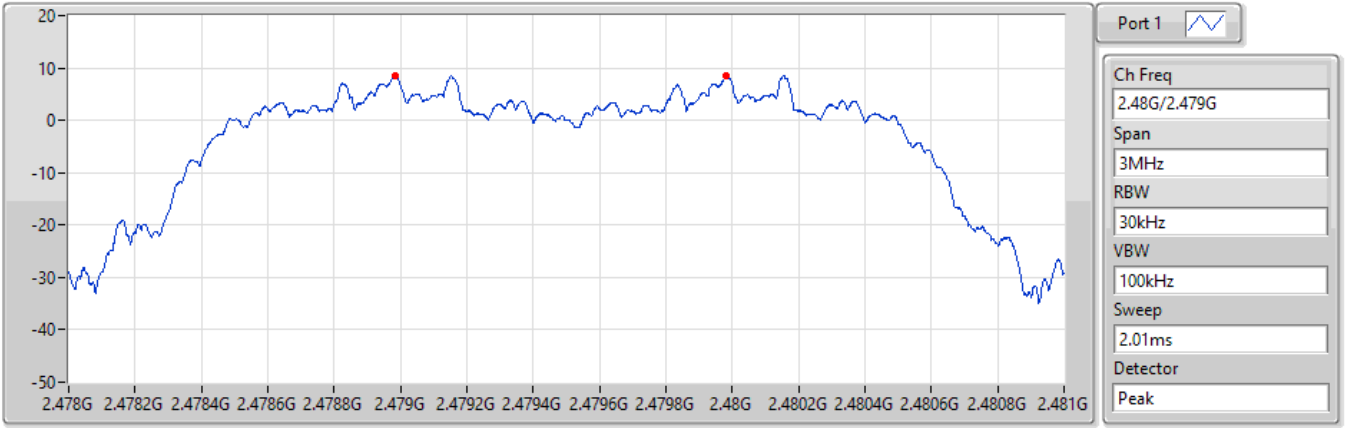

F1(Hz)	Fh(Hz)	Ch.Space(Hz)	Limit(Hz)
2.478983G	2.479983G	1.0005M	868.464k



Summary

Mode	Max-Dwell (s)
2.4-2.4835GHz	-
BT-BR(1Mbps)	345.32006m_DH5
BT-BR-AFH(1Mbps)	299.182m_DH5-AFH
BT-EDR(2Mbps)	346.25068m_DH5
BT-EDR-AFH(2Mbps)	299.598m_DH5-AFH
BT-EDR(3Mbps)	310.28672m_DH5
BT-EDR-AFH(3Mbps)	311.904m_DH5-AFH



Result/ Non AFH mode

Mode	Result	Period (s)	Dwell (s)	Limit (s)	Tx On (ms)	Number of transmission in a 5 s
BT-BR(1Mbps)	-	-	-	-	-	-
2402MHz_DH5	PASS	31.6	0.34532	0.4	2.87575	19
BT-EDR(2Mbps)	-	-	-	-	-	-
2402MHz_DH5	PASS	31.6	0.34625	0.4	2.88350	19
BT-EDR(3Mbps)	-	-	-	-	-	-
2402MHz_DH5	PASS	31.6	0.31029	0.4	2.88800	17

Note 1: Dwell time =Number of transmission in a 5 second x Tx On Time x 6.32

Note 2: DH5 was the worst mode.

Result/ AFH mode

Mode	Result	Period (s)	Dwell (s)	Limit (s)	Tx On (ms)	Number of transmission in a 2 s
BT-BR-AFH(1Mbps)	-	-	-	-	-	-
2402MHz_DH5	PASS	8	0.29918	0.4	2.87675	26
BT-EDR-AFH(2Mbps)	-	-	-	-	-	-
2402MHz_DH5	PASS	8	0.29960	0.4	2.88075	26
BT-EDR-AFH(3Mbps)	-	-	-	-	-	-
2402MHz_DH5	PASS	8	0.31190	0.4	2.88800	27

Note 1: Dwell time =Number of transmission in a 2 second x Tx On Time x 4

Note 2: DH5 was the worst mode.

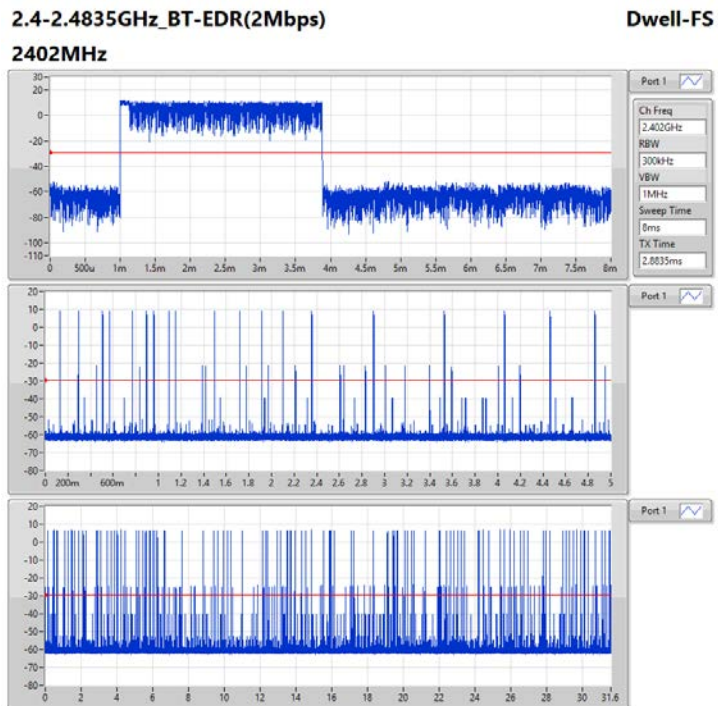
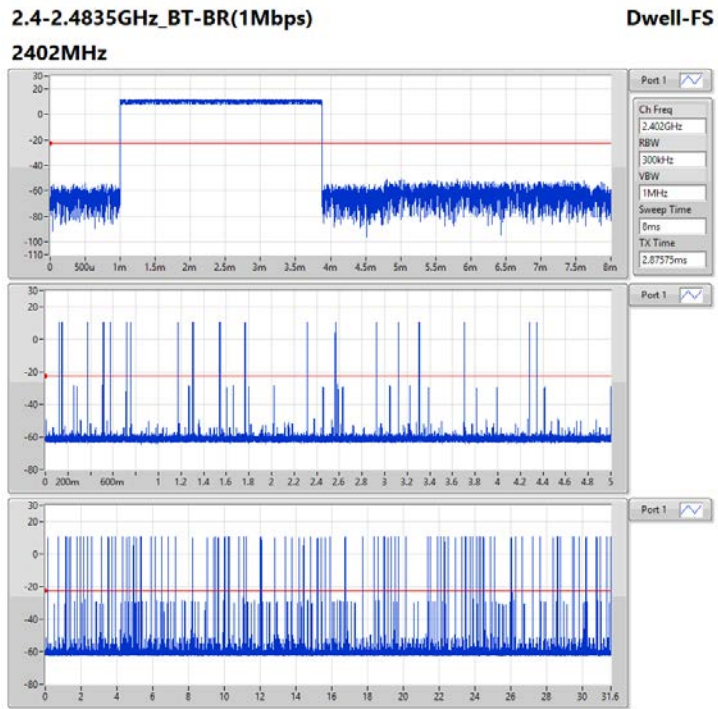

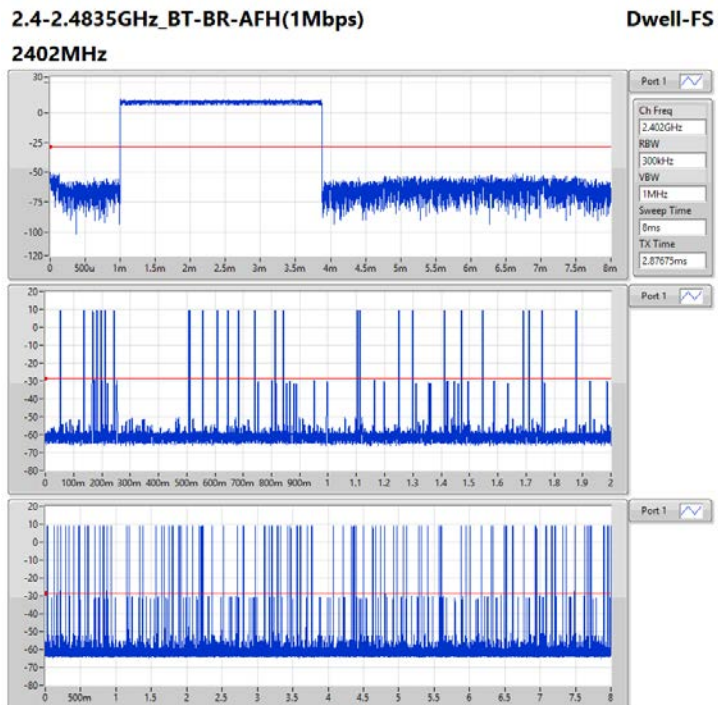
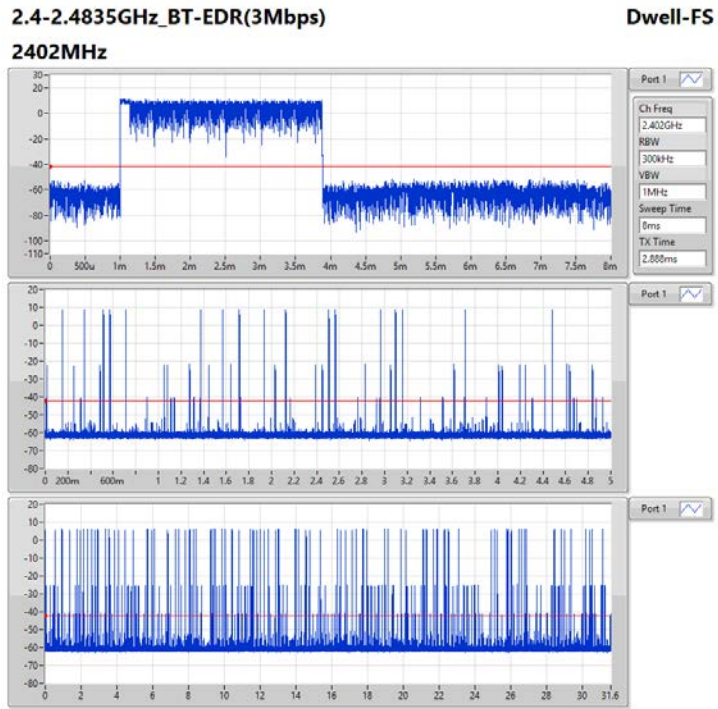

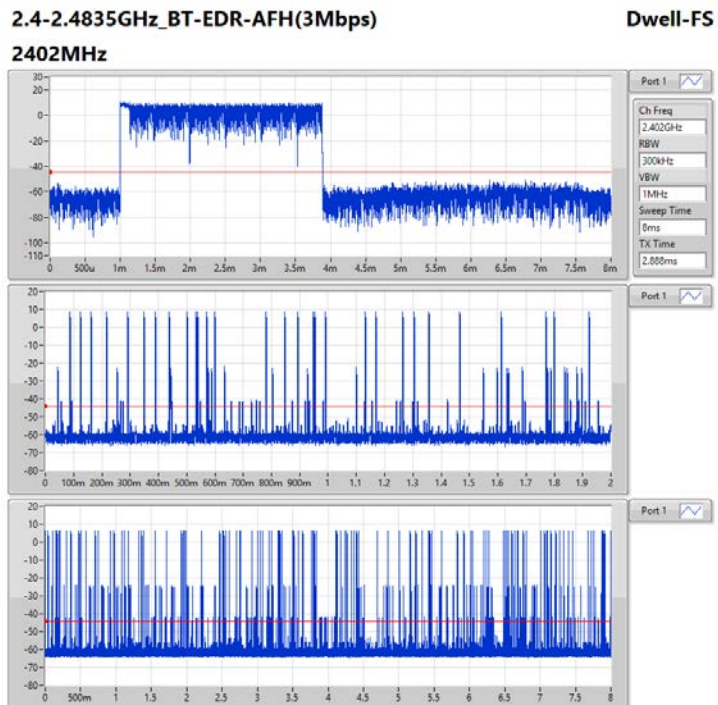



Mode	Charging mode
Power Phase	Line

Test by : Joe Liao Temperature: 21°C Humidity: 63%

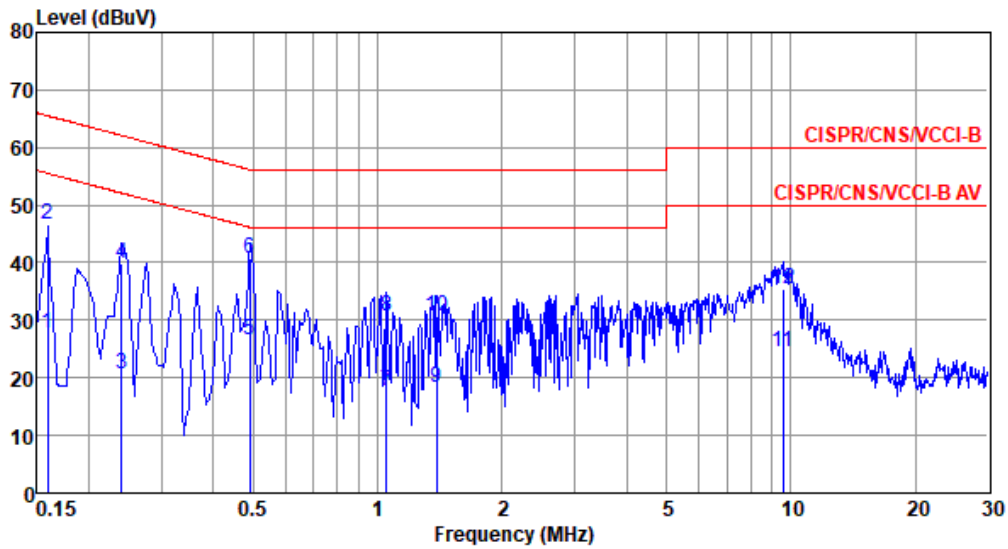

	Freq MHz	Level dBuV	Limit Line dBuV	Over Limit dB	Read Level dBuV	Factor dB	Cable loss dB	Aux dB	Remark
1	0.159	27.63	55.52	-27.89	17.76	9.63	0.06	0.18	Average
2	0.159	46.62	65.52	-18.90	36.75	9.63	0.06	0.18	QP
3	0.240	20.56	52.08	-31.52	10.66	9.62	0.06	0.22	Average
4	0.240	39.87	62.08	-22.21	29.97	9.62	0.06	0.22	QP
5	0.491	26.56	46.14	-19.58	16.56	9.62	0.07	0.31	Average
6*	0.491	40.87	56.14	-15.27	30.87	9.62	0.07	0.31	QP
7	1.049	17.64	46.00	-28.36	7.57	9.63	0.11	0.33	Average
8	1.049	30.58	56.00	-25.42	20.51	9.63	0.11	0.33	QP
9	1.388	18.31	46.00	-27.69	8.22	9.63	0.12	0.34	Average
10	1.388	30.84	56.00	-25.16	20.75	9.63	0.12	0.34	QP
11	9.552	24.43	50.00	-25.57	13.95	9.69	0.35	0.44	Average
12	9.552	35.37	60.00	-24.63	24.89	9.69	0.35	0.44	QP

Note 1: Level (dBuV) = Read Level (dBuV) + LISN Factor (dB) + Cable Loss (dB) + Aux (dB).
 2: Over Limit (dB) = Level (dBuV) – Limit Line (dBuV).



Mode	Charging mode
Power Phase	Neutral

Test by : Joe Liao Temperature: 21°C Humidity: 63%

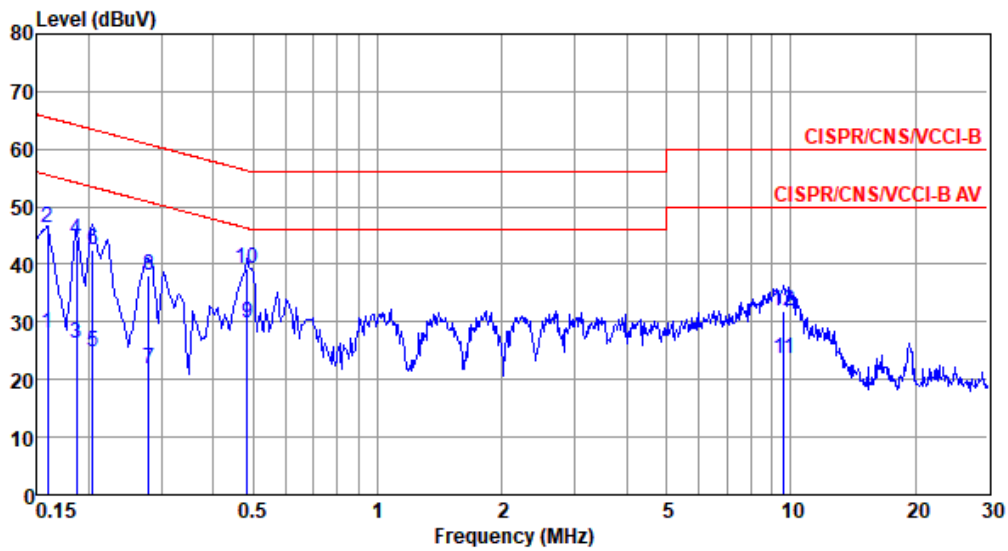

	Freq MHz	Level dBuV	Limit Line dBuV	Over Limit dB	Read Level dBuV	Factor dB	Cable loss dB	Aux dB	Remark
1	0.159	28.00	55.52	-27.52	18.13	9.63	0.06	0.18	Average
2	0.159	46.46	65.52	-19.06	36.59	9.63	0.06	0.18	QP
3	0.186	26.39	54.20	-27.81	16.51	9.63	0.06	0.19	Average
4	0.186	44.18	64.20	-20.02	34.30	9.63	0.06	0.19	QP
5	0.204	24.92	53.45	-28.53	15.04	9.63	0.06	0.19	Average
6	0.204	42.61	63.45	-20.84	32.73	9.63	0.06	0.19	QP
7	0.279	21.92	50.85	-28.93	11.99	9.63	0.06	0.24	Average
8	0.279	38.19	60.85	-22.66	28.26	9.63	0.06	0.24	QP
9*	0.484	29.69	46.27	-16.58	19.69	9.62	0.07	0.31	Average
10	0.484	39.22	56.27	-17.05	29.22	9.62	0.07	0.31	QP
11	9.603	23.51	50.00	-26.49	13.01	9.71	0.35	0.44	Average
12	9.603	31.77	60.00	-28.23	21.27	9.71	0.35	0.44	QP

Note 1: Level (dBuV) = Read Level (dBuV) + LISN Factor (dB) + Cable Loss (dB) + Aux (dB).
 Note 2: Over Limit (dB) = Level (dBuV) – Limit Line (dBuV).