



ROGERS LABS, INC.

4405 West 259th Terrace
Louisburg, KS 66053
Phone / Fax (913) 837-3214

47 CFR, PART 15C - Intentional Radiators
47 CFR Paragraph 15.249 and
Industry Canada RSS-GEN Issue 5 and RSS-210 Issue 10
Application For Grant of Certification

Model: AA4113

2402-2480 MHz (DXX)
Low Power Digital Transmitter

FCC ID: IPH-A4113

IC: 1792A-A4113

Garmin International, Inc.

1200 East 151st Street
Olathe, KS 66062

FCC Designation: US5305
ISED Registration: 3041A-1

Test Report Number: 200922

Test Date: September 22, 2020

Authorized Signatory: *Scot D Rogers*
Scot D. Rogers

This report shall not be reproduced except in full, without the written approval of the laboratory. This report must not be used by the client to claim product certification, approval, or endorsement by NVLAP, NIST, or any agency of the U.S. Government.

Rogers Labs, Inc.
4405 West 259th Terrace
Louisburg, KS 66053
Phone/Fax: (913) 837-3214
Revision 1

Garmin International, Inc.
Model: AA4113
Test: 200922
Test to: CFR47 15C, RSS-Gen RSS-247
File: AA4113 DXX TstRpt 200922

SN's: 3341634221 / 3341634272
FCC ID: IPH-A4113
IC: 1792A-A4113
Date: November 18, 2020
Page 1 of 49

Table of Contents

TABLE OF CONTENTS.....	2
REVISIONS.....	4
EXECUTIVE SUMMARY	5
OPINION / INTERPRETATION OF RESULTS	5
EQUIPMENT TESTED.....	6
Equipment Function	7
Equipment Configuration.....	8
APPLICATION FOR CERTIFICATION.....	9
APPLICABLE STANDARDS.....	10
EQUIPMENT TESTING PROCEDURES	10
AC Line Conducted Emission Test Procedure	10
Radiated Emission Test Procedure.....	10
Antenna Port Conducted Emission Test Procedure.....	11
Diagram 1 Test arrangement for Conducted emissions	12
Diagram 2 Test arrangement for radiated emissions of tabletop equipment.....	13
Diagram 3 Test arrangement for radiated emissions tested on Open Area Test Site (OATS).....	14
Diagram 4 Test arrangement for Antenna Port Conducted emissions	15
TEST SITE LOCATIONS	15
UNITS OF MEASUREMENTS	16
ENVIRONMENTAL CONDITIONS.....	16
STATEMENT OF MODIFICATIONS AND DEVIATIONS	16
INTENTIONAL RADIATORS.....	17
Antenna Requirements	17

Restricted Bands of Operation.....17

Table 1 Radiated Emissions in Restricted Frequency Bands Data Mode 1 BT BR.....18

Table 2 Radiated Emissions in Restricted Frequency Bands Data Mode 2 BT 2EDR19

Table 3 Radiated Emissions in Restricted Frequency Bands Data Mode 3 BT 3EDR20

Summary of Results for Radiated Emissions in Restricted Bands20

AC Line Conducted EMI Procedure21

Figure 1 AC Line Conducted emissions of EUT line 1 (EUT – Computer)..... **Error! Bookmark not defined.**

Figure 2 AC Line Conducted emissions of EUT line 2 (EUT – Computer)..... **Error! Bookmark not defined.**

Table 4 AC Line Conducted Emissions Data L1 (EUT – Computer)..... **Error! Bookmark not defined.**

Table 5 AC Line Conducted Emissions Data L2 (EUT – Computer)..... **Error! Bookmark not defined.**

Summary of Results for AC Line Conducted Emissions Results.....22

General Radiated Emissions Procedure.....25

Table 6 General Radiated Emissions Data26

Summary of Results for General Radiated Emissions26

Operation in the Band 2400 – 2483.5 MHz27

Figure 3 Plot of Transmitter Emissions Operation in 2402-2480 MHz Mode 1 BT BR28

Figure 4 Plot of Transmitter Emissions Operation in 2402-2480 MHz Mode 2 BT 2EDR.....29

Figure 5 Plot of Transmitter Emissions Operation in 2402-2480 MHz Mode 3 BT 3EDR.....30

Figure 6 Plot of Transmitter Emissions Low Band Edge Mode 1 BT BR.....31

Figure 7 Plot of Transmitter Emissions Low Band Edge Mode 2 BT 2EDR31

Figure 8 Plot of Transmitter Emissions Low Band Edge Mode 3 BT 3EDR33

Figure 9 Plot of Transmitter Emissions High Band Edge Mode 1 BT BR34

Figure 10 Plot of Transmitter Emissions High Band Edge Mode 2 BT 2EDR35

Figure 11 Plot of Transmitter Emissions High Band Edge Mode 3 BR 2EDR36

Figure 12 Plot of Transmitter Emissions 99% Occupied Bandwidth Mode 1 BT BR.....37

Figure 13 Plot of Transmitter Emissions 99% Occupied Bandwidth Mode 1 BT 2EDR38

Figure 14 Plot of Transmitter Emissions 99% Occupied Bandwidth Mode 1 BT 3EDR39

Transmitter Emissions Data.....40

Table 7 Transmitter Radiated Emissions Mode 1 BT BR40

Table 8 Transmitter Radiated Emissions Mode 2 BT 2EDR.....41

Table 9 Transmitter Radiated Emissions Mode 3 BT 3EDR.....42

Summary of Results for Transmitter Radiated Emissions of Intentional Radiator43

ANNEX..... 44

Annex A Measurement Uncertainty Calculations.....45

Annex B Test Equipment.....46

Annex C Rogers Qualifications48

Annex D Laboratory Certificate of Accreditation.....49

Revisions

Revision 1 Issued November 18, 2020

Executive Summary

License Exempt Digital Transmission System Intentional Radiator operating under Title 47 Code of Federal Regulations (47 CFR) Paragraph 15.249 and Industry Canada RSS-210 Issue 10 and RSS-GEN Issue 5, low power digital device transmitter operations in the 2400 – 2483.5 MHz frequency band.

Name of Applicant: Garmin International, Inc.
1200 East 151st Street
Olathe, KS 66062

M/N: AA4113

FCC ID: IPH-A4113 IC: 1792A-A4113

Operating Frequency Range: 2402-2480 MHz

Operational communication modes

Mode	Peak Power (dB μ V/m@3m)	Average power (dB μ V/m@3m)	99% OBW (kHz)
Mode 1, BT BR (GFSK)	94.1	82.4	827
Mode 2, BT 2EDR ($\pi/4$ -DQPSK)	93.5	79.7	1164
Mode 3, BT 3EDR (8DPSK)	94.2	80.3	1192

This report addresses EUT Operation as Low Power Device using transmitter modes 1, 2, and 3

Opinion / Interpretation of Results

Tests Performed	Margin (dB)	Results
Restricted Bands 47 CFR 15.205, RSS-210 4.1	-6.8	Complies
Emissions as per 47CFR 15.207, RSS-GEN 8.8	-18.3	Complies
Radiated Emissions 47 CFR 15.209, RSS-GEN 8.9	-11.9	Complies
Harmonic Emissions per 47 CFR 15.249, RSS-210 B.10	-1.5	Complies

Equipment Tested

Model: AA4113

Garmin International, Inc.
1200 East 151st Street
Olathe, KS 66062

Garmin Corporation
No.68, Zhangshu 2nd Rd.
Xizhi Dist., New Taipei City 221, Taiwan, R.O.C.

<u>Equipment</u>	<u>Model / PN</u>	<u>Serial Number</u>
EUT	AA4113	3341634221
EUT2	AA4113	3341634272
Micro USB cable	320-00559-01	N/A
1.5 m USB/power cable	320-1325-00	N/A
Dual USB Power Adapter (CLA)	013-00797-01	N/A
4m power cable	320-01325-10	N/A
8m power cable	320-01325-20	N/A
Parking mode cable	320-00845-04	N/A
Quick power Adapter (QPA)	320-01425-10	N/A
DC Power Supply	BK 1745	209C13
Laptop Computer	Latitude 7480	EFSPSN2
USB Printer	Dell 0N5819	5D1SL61

Operational communication modes

Mode	Transmitter Operation
1	BT BR (GFSK)
2	BT 2EDR ($\pi/4$ -DQPSK)
3	BT 3EDR (8DPSK)
4	BT BLE (GMSK)
5	802.11b (CCK/DSSS)
6	802.11g (OFDM)
7	802.11n (MCS)

Software: 0.49, Sheet metal - Dipole (-1.6 dBi)

Test results in this report relate only to the items tested and operating in modes 1-3. Worst-case configuration data recorded in this report.

Rogers Labs, Inc.
4405 West 259th Terrace
Louisburg, KS 66053
Phone/Fax: (913) 837-3214
Revision 1

Garmin International, Inc.
Model: AA4113
Test: 200922
Test to: CFR47 15C, RSS-Gen RSS-247
File: AA4113 DXX TstRpt 200922

SN's: 3341634221 / 3341634272
FCC ID: IPH-A4113
IC: 1792A-A4113
Date: November 18, 2020
Page 6 of 49

Equipment Function

The EUT is a mobile mounted digital recording device incorporating wireless data transfer. The device incorporates camera sensor and associated circuitry to record images within the lens view angle. The design provides a single connection point for use with the authorized Micro USB interface cable options and a single Micro SD memory card slot. The device offers no other interface options than those presented below in the configuration diagrams. The transmitter provides wireless communication capability across the 2402-2480 MHz frequency band. The design provides wireless communications with compatible Bluetooth® (BT) Basic Rate, 2EDR, 3EDR and Low Energy (BLE), as well as 802.11b/g/n (Wi-Fi) equipment. The product operates from internal battery or external direct current power provided over the micro USB interface port. Power is provided through compatible USB interface cable options and power sources. The design utilizes internal fixed antenna system and offers no provision for antenna replacement or modification. Two samples were provided for testing, one representative of production design, and the other modified for testing purposes replacing the integral antenna with a RF connection port. The test samples were provided with test software (version 0.49) providing test personnel the ability to enable transmitter functions on defined modulations and channels. The test software enabled near 100% transmit duty cycle for testing purposes. The antenna modification offered testing facility the ability to connect test equipment to the temporary antenna port for antenna port conducted emission testing. For testing purposes, the EUT received powered from internal battery as well as external direct current sources (CPU-USB port or DC power supply) and configured to operate in available modes. The EUT was arranged as described by the manufacturer emulating typical user configurations for testing purposes. As requested by the manufacturer and required by regulations, the equipment was tested for compliance using the available configurations with the worst-case data presented. This report documents the performed testing and results for applicable configurations and product modes of operation. Test results in this report relate only to the products described in this report.

Equipment Configuration

- 1) Unit connected to (and powered by) CLA through USB cable

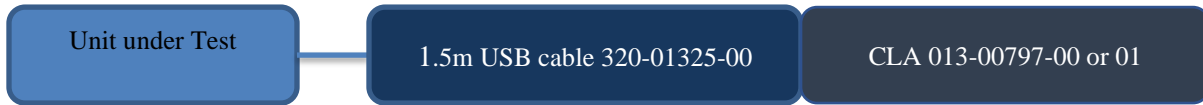

- 2) Unit connected to (and powered by) CLA through USB cable

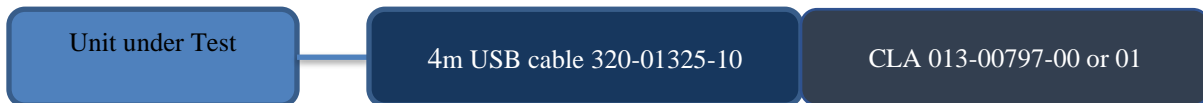

- 3) Unit connected to (and powered by) CLA through USB cable

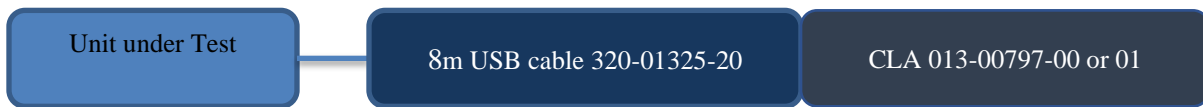

- 4) Unit connected to (and powered by) Computer through USB cable

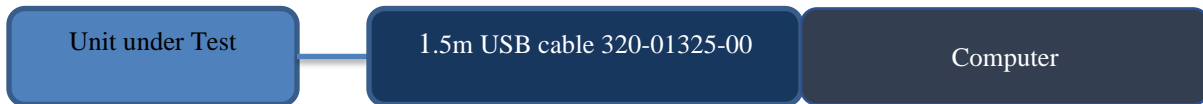

- 5) Unit connected to (and powered by) QPA through USB cable

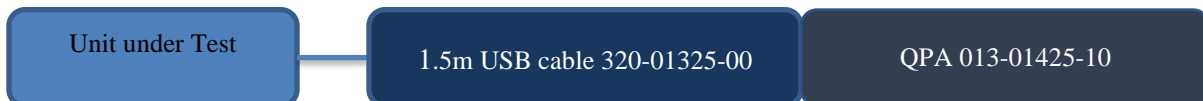

- 6) Unit connected to (and powered by) QPA through USB cable



- 7) Unit connected to (and powered by) QPA through USB cable



- 8) Unit connected to (and powered by) Surveillance Mode Cable



Application for Certification

- (1) Manufacturer: Garmin International, Inc.
1200 East 151st Street
Olathe, KS 66062
- (2) Identification: M/N: AA4113
FCC ID: IPH-A4113 IC: 1792A-A4113
- (3) Instruction Book:
Refer to Exhibit for Instruction Manual.
- (4) Description of Circuit Functions:
Refer to Exhibit of Operational Description.
- (5) Block Diagram with Frequencies:
Refer to Exhibit of Operational Description.
- (6) Report of Measurements:
Report of measurements follows in this Report.
- (7) Photographs: Construction, Component Placement, etc.:
Refer to Exhibit for photographs of equipment.
- (8) List of Peripheral Equipment Necessary for operation. The equipment operates from internal battery power or external direct current power provided from authorized sources. The EUT offers interface port for power and communications as presented in this filing.
- (9) Transition Provisions of 47 CFR 15.37 are not requested.
- (10) Not Applicable. The unit is not a scanning receiver.
- (11) Not Applicable. The EUT does not operate in the 59 – 64 GHz frequency band.
- (12) The equipment is not software defined and this section is not applicable.
- (13) Applications for certification of U-NII devices in the 5.15-5.35 GHz and the 5.47-5.85 GHz bands must include a high-level operational description of the security procedures that control the radio frequency operating parameters and ensure that unauthorized modifications cannot be made. This requirement is not applicable to his DTS device.
- (14) Contain at least one drawing or photograph showing the test set-up for each of the required types of tests applicable to the device for which certification is requested. These drawings or photographs must show enough detail to confirm other information contained in the test report. Any photographs used must be focused originals without glare or dark spots and must clearly show the test configuration used. This information is provided in this report and Test Setup Exhibits provided with the application filing.

Applicable Standards

The following information is submitted in accordance with the eCFR Title 47 Code of Federal Regulations (47CFR), dated September 22, 2020: Part 2, Subpart J, Part 15C Paragraph 15.249, Industry Canada RSS-210 Issue 10, and RSS-GEN Issue 5. Test procedures used are the established Methods of Measurement of Radio-Noise Emissions as described in ANSI C63.10-2013. This report documents compliance for the EUT operations as Low Power Transmitter.

Equipment Testing Procedures

AC Line Conducted Emission Test Procedure

Testing for the AC line-conducted emissions was performed as required in 47CFR 15C, RSS-210 Issue 10 and specified in ANSI C63.10-2013. The test setup, including the EUT, was arranged in the test configurations as presented during testing. The test configuration was placed on a 1 x 1.5-meter bench, 0.8 meters high located in a screen room. The power lines of the system were isolated from the power source using a standard LISN with a 50- μ Hy choke. EMI was coupled to the spectrum analyzer through a 0.1 μ F capacitor internal to the LISN. The LISN was positioned on the floor beneath the wooden bench supporting the EUT. The power lines and cables were draped over the back edge of the table. Refer to diagram one showing typical test arrangement and photographs in exhibits for EUT placement used during testing.

Radiated Emission Test Procedure

Radiated emissions testing was performed as required in 47 CFR 15C, RSS-210 Issue 10, and specified in ANSI C63.10-2013. The EUT was placed on a rotating 0.9 x 1.2-meter platform, elevated as required above the ground plane at a distance of 3 meters from the FSM antenna. EMI energy was maximized by equipment placement permitting orientation in three orthogonal axes, raising, and lowering the FSM antenna, changing the antenna polarization, and by rotating the turntable. Each emission was maximized before data was taken and recorded. The frequency spectrum from 9 kHz to 25,000 MHz was searched for emissions during preliminary investigation. Refer to diagrams two and three showing typical test setup. Refer to photographs in the test setup exhibits for specific EUT placement during testing.

Antenna Port Conducted Emission Test Procedure

The EUT was assembled as required for operation placed on a benchtop. This configuration provided the ability to connect test equipment to the provided test antenna port. Antenna Port conducted emissions testing was performed presented in the regulations and specified in ANSI C63.10-2013. Testing was completed on a laboratory bench in a shielded room. The active antenna port of the device was connected to appropriate attenuation and the spectrum analyzer. Refer to diagram four showing typical test arrangement and photographs in the test setup exhibits for specific EUT placement during testing.

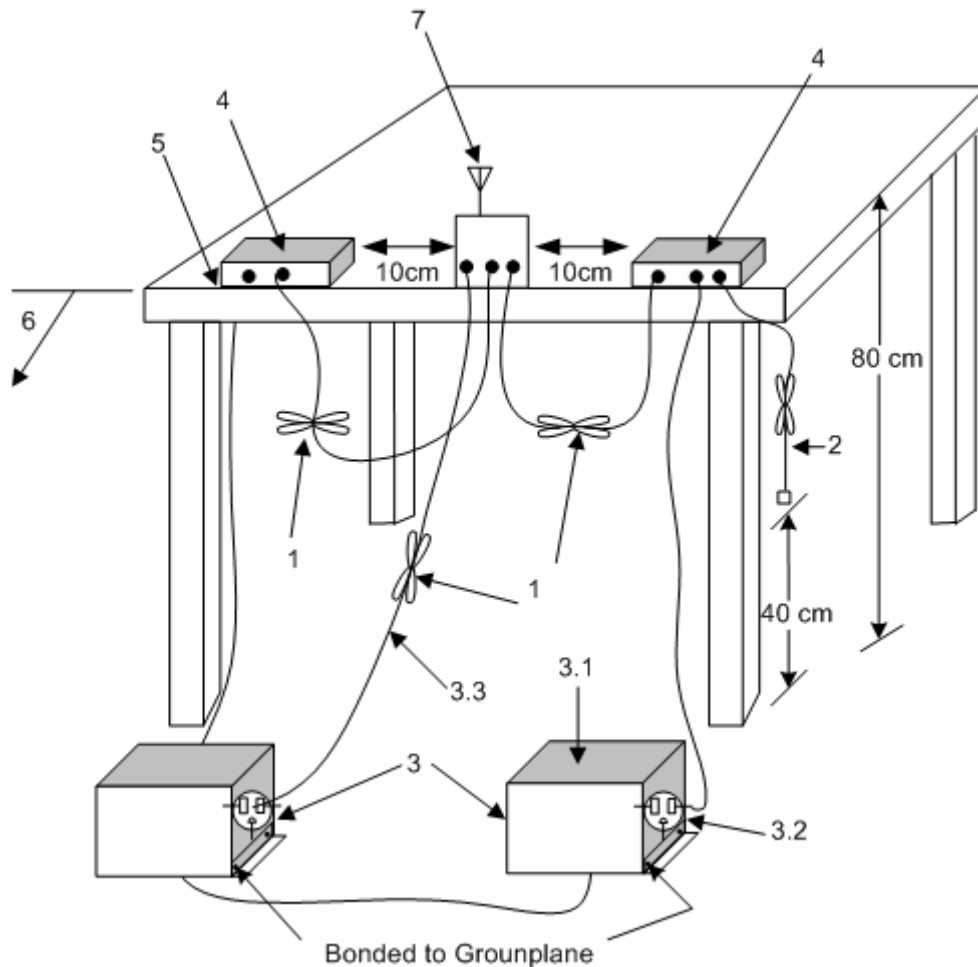

1. Interconnecting cables that hang closer than 40 cm to the ground plane shall be folded back and forth in the center forming a bundle 30 cm to 40 cm long see (see 6.2.3.1).
2. I/O cables that are not connected to an accessory shall be bundled in the center. The end of the cable may be terminated, if required, using the correct terminating impedance. The overall length shall not exceed 1 m (see 6.2.2).
3. EUT connected to one LISN. Unused LISN measuring port connectors shall be terminated in 50 Ω loads. LISN can be placed on top of, or immediately beneath, reference ground plane (see 6.2.2 and 6.2.3).
 - 3.1 All other equipment powered from additional LISN(s).
 - 3.2 Multiple-outlet strip can be used for multiple power cords of non-EUT equipment.
 - 3.3 LISN at least 80 cm from nearest part of EUT chassis.
4. Non-EUT components of EUT system being tested.
5. Rear of EUT, including peripherals, shall all be aligned and flush with rear of tabletop (see 6.2.3.1).
6. Edge of tabletop shall be 40 cm removed from a vertical conducting plane that is bonded to the ground plane (see 6.2.2 for options).
7. Antenna may be integral or detachable. If detachable, the antenna shall be attached for this test.

Diagram 1 Test arrangement for Conducted emissions

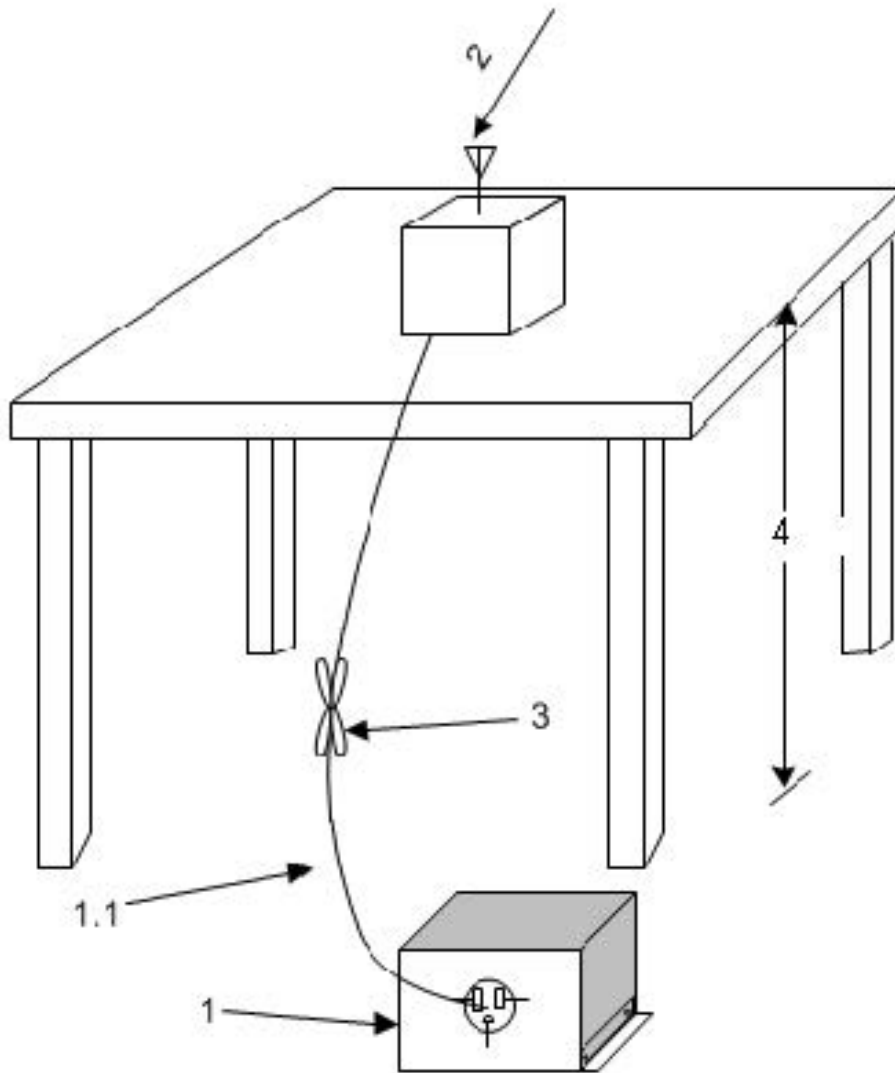

1—A LISN is optional for radiated measurements between 30 MHz and 1000 MHz but not allowed for measurements below 30 MHz and above 1000 MHz (see 6.3.1). If used, then connect EUT to one LISN. Unused LISN measuring port connectors shall be terminated in 50 Ω loads. The LISN may be placed on top of, or immediately beneath, the reference ground plane (see 6.2.2 and 6.2.3.2).

1.1—LISN spaced at least 80 cm from the nearest part of the EUT chassis.

2—Antenna can be integral or detachable, depending on the EUT (see 6.3.1).

3—Interconnecting cables that hang closer than 40 cm to the ground plane shall be folded back and forth in the center forming a bundle 30 cm to 40 cm long (see 6.3.1).

4—For emission measurements at or below 1 GHz, the table height shall be 80 cm. For emission measurements above 1 GHz, the table height shall be 1.5 m for measurements, except as otherwise specified (see 6.3.1 and 6.6.3.1).

Diagram 2 Test arrangement for radiated emissions of tabletop equipment

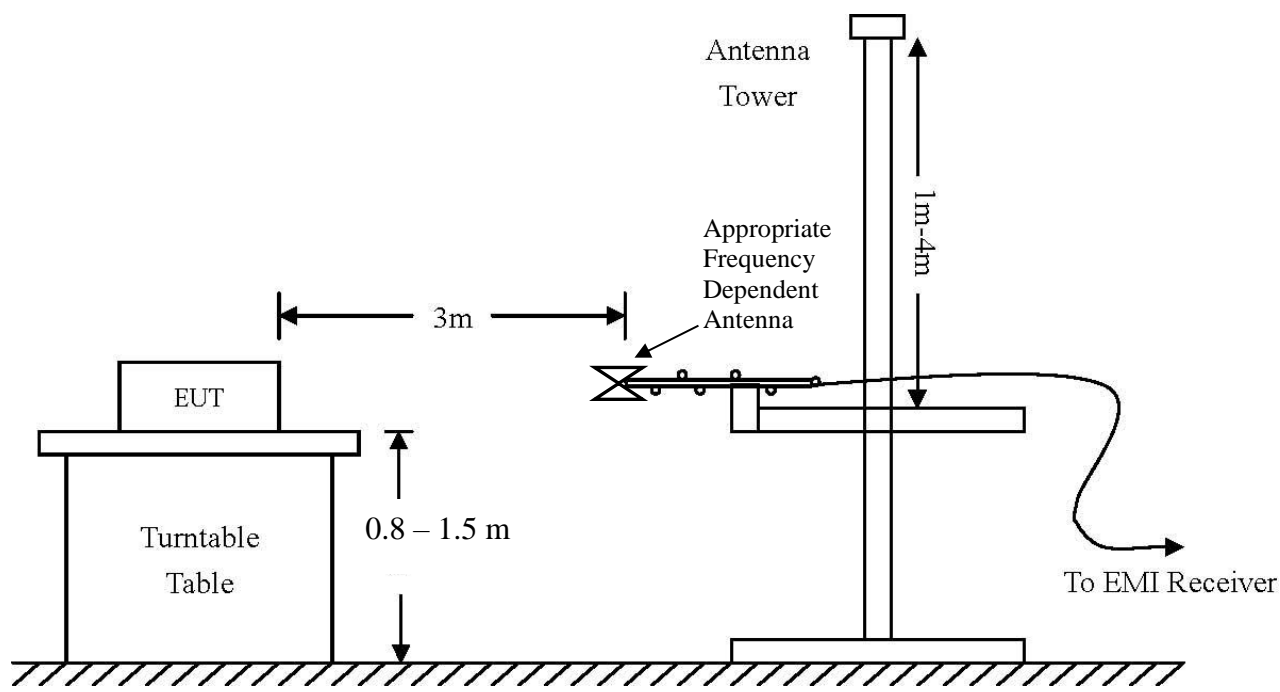

AC Line Conducted Emissions (0.150 -30 MHz)		
RBW	AVG. BW	Detector Function
9 kHz	30 kHz	Peak / Quasi Peak
Emissions (30-1000 MHz)		
RBW	AVG. BW	Detector Function
120 kHz	300 kHz	Peak / Quasi Peak
Emissions (Above 1000 MHz)		
RBW	Video BW	Detector Function
100 kHz	100 kHz	Peak
1 MHz	1 MHz	Peak / Average

Diagram 3 Test arrangement for radiated emissions tested on Open Area Test Site (OATS)

Spectrum Analyzer

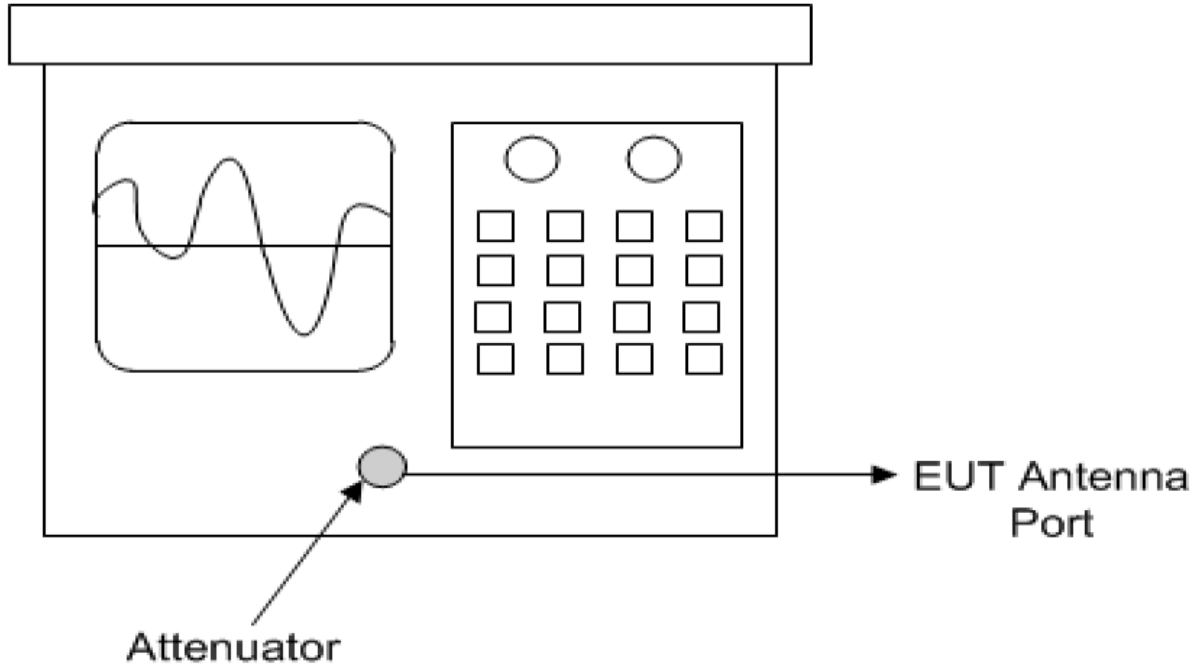

Diagram 4 Test arrangement for Antenna Port Conducted emissions

Test Site Locations

Conducted EMI AC line conducted emissions testing performed in a shielded screen room located at Rogers Labs, Inc., 4405 West 259th Terrace, Louisburg, KS

Antenna port Antenna port conducted emissions testing was performed in a shielded screen room located at Rogers Labs, Inc., 4405 West 259th Terrace, Louisburg, KS

Radiated EMI The radiated emissions tests were performed at the 3 meters, Open Area Test Site (OATS) located at Rogers Labs, Inc., 4405 West 259th Terrace, Louisburg, KS

Registered Site information: FCC Site: US5305, ISED: 3041A, CAB Identifier: US0096

NVLAP Accreditation Lab code 200087-0

Units of Measurements

Conducted EMI Data presented in dB μ V; dB referenced to one microvolt

Antenna port Conducted Data is in dBm; dB referenced to one milliwatt

Radiated EMI Data presented in dB μ V/m; dB referenced to one microvolt per meter

Note: Radiated limit may be expressed for measurement in dB μ V/m when the measurement is taken at a distance of 3 or 10 meters. Data taken for this report was taken at distance of 3 meters.

Sample calculation demonstrates corrected field strength reading for Open Area Test Site using the measurement reading and correcting for receive antenna factor, cable losses, and amplifier gains.

Sample Calculation:

RFS = Radiated Field Strength, FSM = Field Strength Measured

A.F. = Receive antenna factor, Losses = attenuators/cable losses, Gain = amplification gains

RFS (dB μ V/m @ 3m) = FSM (dB μ V) + A.F. (dB/m) + Losses (dB) - Gain (dB)

Environmental Conditions

Ambient Temperature 22.4° C

Relative Humidity 40 %

Atmospheric Pressure 1023.9 mb

Statement of Modifications and Deviations

No modifications to the EUT were required for the equipment to demonstrate compliance with the 47 CFR Part 15C, Industry Canada RSS-210 Issue 10, and RSS-GEN Issue 5 emission requirements. There were no deviations to the specifications.

Intentional Radiators

The following information is submitted supporting compliance with the requirements of 47 CFR, Subpart C, paragraph 15.249, Industry Canada RSS-210 Issue 10 and RSS-GEN Issue 5.

Antenna Requirements

The EUT incorporates integral chip antenna system. Production equipment offers no provision for connection to alternate antenna system. The antenna connection point complies with the unique antenna connection requirements. There are no deviations or exceptions to the specification.

Restricted Bands of Operation

Spurious emissions falling in the restricted frequency bands of operation were measured at the OATS. The EUT utilizes frequency, determining circuitry, which generates harmonics falling in the restricted bands. Emissions were investigated at the OATS, using appropriate antennas or pyramidal horns, amplification stages, and a spectrum analyzer. Peak and average amplitudes of frequencies above 1000 MHz were compared to the required limits with worst-case data presented below. Test procedures of ANSI C63.10-2013 were used during testing. No other significant emission was observed which fell into the restricted bands of operation. Computed emission values consider the received radiated field strength, receive antenna correction factor, amplifier gain stage, and test system cable losses.

Table 1 Radiated Emissions in Restricted Frequency Bands Data Mode 1 BT BR

Frequency in MHz	Horizontal Peak (dBμV/m)	Horizontal Average (dBμV/m)	Vertical Peak (dBμV/m)	Vertical Average (dBμV/m)	Limit @ 3m (dBμV/m)	Horizontal Margin (dB)	Vertical Margin (dB)
2390.0	44.0	30.6	44.8	30.9	54.0	-23.4	-23.1
2483.5	45.5	31.3	44.5	31.3	54.0	-22.7	-22.7
4804.0	49.6	36.3	49.4	36.3	54.0	-17.7	-17.7
4884.0	49.3	36.1	49.5	36.2	54.0	-17.9	-17.8
4960.0	50.0	36.3	49.9	36.3	54.0	-17.7	-17.7
7206.0	53.1	40.4	53.0	40.4	54.0	-13.6	-13.6
7326.0	53.1	40.4	54.3	40.5	54.0	-13.6	-13.5
7440.0	53.8	40.5	53.9	40.5	54.0	-13.5	-13.5
12010.0	59.1	46.7	60.6	46.7	54.0	-7.3	-7.3
12210.0	59.9	47.0	60.2	46.9	54.0	-7.0	-7.1
12400.0	59.7	47.1	60.3	47.2	54.0	-6.9	-6.8

Other emissions present had amplitudes at least 20 dB below the limit. Peak and Quasi-Peak amplitude emissions are recorded for frequency below 1000 MHz. Peak and Average amplitude emissions are recorded for frequency range above 1000 MHz.

Table 2 Radiated Emissions in Restricted Frequency Bands Data Mode 2 BT 2EDR

Frequency in MHz	Horizontal Peak (dBµV/m)	Horizontal Average (dBµV/m)	Vertical Peak (dBµV/m)	Vertical Average (dBµV/m)	Limit @ 3m (dBµV/m)	Horizontal Margin (dB)	Vertical Margin (dB)
2390.0	43.9	30.6	44.4	30.7	54.0	-23.4	-23.3
2483.5	46.2	31.6	44.7	31.2	54.0	-22.4	-22.8
4804.0	49.5	36.3	49.8	36.3	54.0	-17.7	-17.7
4884.0	49.6	36.0	49.0	36.1	54.0	-18.0	-17.9
4960.0	49.2	36.3	49.4	36.3	54.0	-17.7	-17.7
7206.0	53.4	40.3	54.0	40.4	54.0	-13.7	-13.6
7326.0	53.4	40.5	53.7	40.5	54.0	-13.5	-13.5
7440.0	53.3	40.5	53.7	40.5	54.0	-13.5	-13.5
12010.0	60.5	46.6	59.1	46.7	54.0	-7.4	-7.3
12210.0	60.3	46.9	59.9	47.0	54.0	-7.1	-7.0
12400.0	59.9	47.1	59.4	47.0	54.0	-6.9	-7.0

Other emissions present had amplitudes at least 20 dB below the limit. Peak and Quasi-Peak amplitude emissions are recorded for frequency below 1000 MHz. Peak and Average amplitude emissions are recorded for frequency range above 1000 MHz.

Table 3 Radiated Emissions in Restricted Frequency Bands Data Mode 3 BT 3EDR

Frequency in MHz	Horizontal Peak (dBµV/m)	Horizontal Average (dBµV/m)	Vertical Peak (dBµV/m)	Vertical Average (dBµV/m)	Limit @ 3m (dBµV/m)	Horizontal Margin (dB)	Vertical Margin (dB)
2390.0	44.3	30.6	44.7	30.7	54.0	-23.4	-23.3
2483.5	45.2	31.3	45.3	31.2	54.0	-22.7	-22.8
4804.0	49.7	36.3	49.4	36.3	54.0	-17.7	-17.7
4884.0	49.5	36.1	49.8	36.1	54.0	-17.9	-17.9
4960.0	49.6	36.3	49.3	36.3	54.0	-17.7	-17.7
7206.0	53.3	40.4	53.0	40.4	54.0	-13.6	-13.6
7326.0	53.5	40.4	53.6	40.4	54.0	-13.6	-13.6
7440.0	53.4	40.5	53.3	40.5	54.0	-13.5	-13.5
12010.0	59.3	46.7	59.9	46.7	54.0	-7.3	-7.3
12210.0	60.2	47.0	59.6	46.9	54.0	-7.0	-7.1
12400.0	60.2	47.0	60.7	47.1	54.0	-7.0	-6.9

Other emissions present had amplitudes at least 20 dB below the limit. Peak and Quasi-Peak amplitude emissions are recorded for frequency below 1000 MHz. Peak and Average amplitude emissions are recorded for frequency range above 1000 MHz.

Summary of Results for Radiated Emissions in Restricted Bands

The EUT demonstrated compliance with the radiated emissions requirements of 47 CFR Part 15C and RSS-210 Issue 10 Intentional Radiator requirements. The EUT demonstrated a worst-case minimum margin of -6.8 dB below the emissions requirements in restricted frequency bands. Peak, Quasi-peak, and average amplitudes were checked for compliance with the regulations. Worst-case emissions are reported with other emissions found in the restricted frequency bands at least 20 dB below the requirements.

AC Line Conducted EMI Procedure

The EUT was arranged in typical equipment configurations operating from AC power adapter. Testing was performed with the EUT placed on a 1 x 1.5-meter wooden bench 80 cm above the conducting ground plane, floor of a screen room. The bench was positioned 40 cm away from the wall of the screen room. The LISN was positioned on the floor of the screen room 80-cm from the rear of the EUT. Testing for the AC line-conducted emissions were the procedures of ANSI C63.10-2013 paragraph 6. The AC power adapter for the CPU providing power to the EUT was connected to the LISN for AC line-conducted emissions testing. A second LISN was positioned on the floor of the screen room 80-cm from the rear of the supporting equipment of the EUT. All power cords except those providing power to the EUT were then powered from the second LISN. EMI was coupled to the spectrum analyzer through a 0.1 μ F capacitor, internal to the LISN. Power line conducted emissions testing was carried out individually for each current carrying conductor of the EUT. The excess length of lead between the system and the LISN receptacle was folded back and forth to form a bundle not exceeding 40 cm in length. The screen room, conducting ground plane, analyzer, and LISN were bonded together to the protective earth ground. Preliminary testing was performed to identify the frequencies of each of the emissions, which demonstrated the highest amplitudes. The cables were repositioned to obtain maximum amplitude of measured EMI level. Once the worst-case configuration was identified, plots were made of the EMI from 0.15 MHz to 30 MHz then data was recorded with maximum conducted emissions levels.

Refer to figures one and two for plots of the EUT – USB Computer interface configuration #4 AC Line conducted emissions.

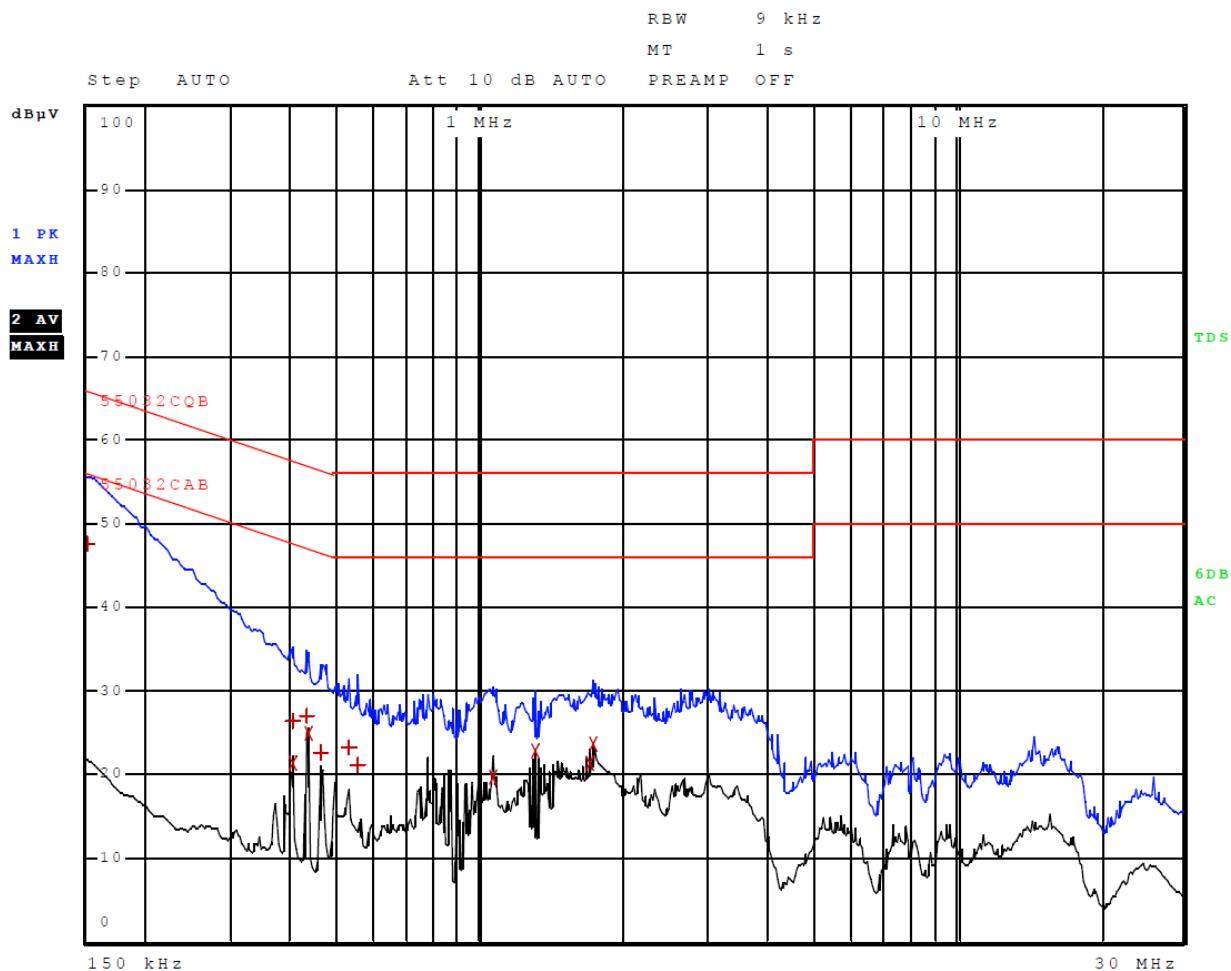

Figure 1 AC Line Conducted emissions of EUT line 1 (EUT – Computer)

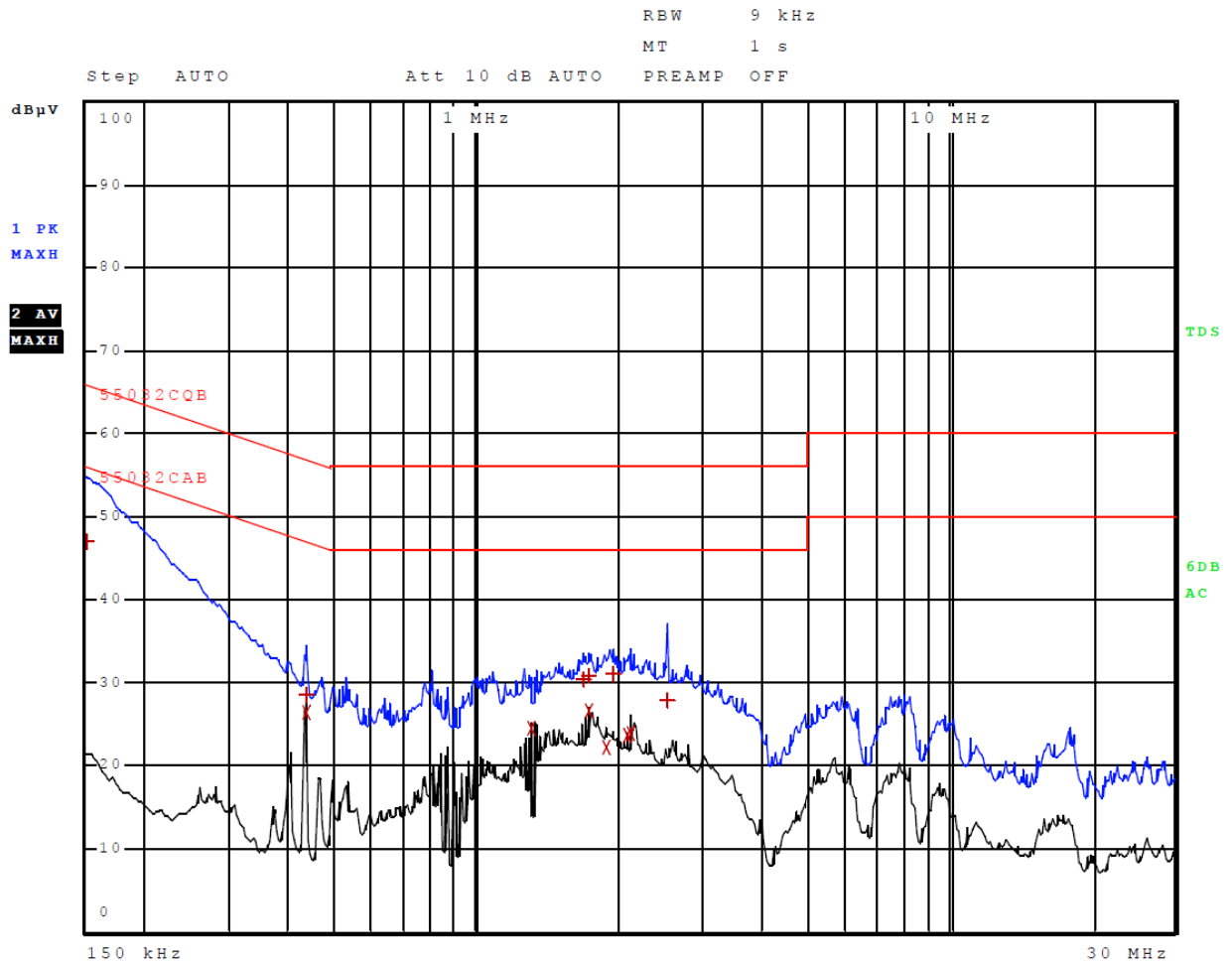

Figure 2 AC Line Conducted emissions of EUT line 2 (EUT – Computer)

Table 5 AC Line Conducted Emissions Data L1 (EUT – Computer)

Trace	Frequency	Level (dBµV)	Detector	Delta Limit/dB
1	150.000000000 kHz	47.67	Quasi Peak	-18.33
1	402.000000000 kHz	26.42	Quasi Peak	-31.39
2	402.000000000 kHz	21.31	Average	-26.50
1	430.000000000 kHz	26.90	Quasi Peak	-30.35
2	434.000000000 kHz	24.86	Average	-22.32
1	462.000000000 kHz	22.48	Quasi Peak	-34.17
1	526.000000000 kHz	23.16	Quasi Peak	-32.84
1	550.000000000 kHz	21.15	Quasi Peak	-34.85
2	1.062000000 MHz	19.66	Average	-26.34
2	1.298000000 MHz	22.83	Average	-23.17
2	1.702000000 MHz	21.26	Average	-24.74
2	1.730000000 MHz	23.74	Average	-22.26

Other emissions present had amplitudes at least 20 dB below the limit.

Table 6 AC Line Conducted Emissions Data L2 (EUT – Computer)

Trace	Frequency	Level (dBµV)	Detector	Delta Limit/dB
1	150.000000000 kHz	47.01	Quasi Peak	-18.99
1	434.000000000 kHz	28.47	Quasi Peak	-28.70
2	434.000000000 kHz	26.28	Average	-20.90
2	1.298000000 MHz	24.48	Average	-21.52
1	1.678000000 MHz	30.34	Quasi Peak	-25.66
2	1.730000000 MHz	26.58	Average	-19.42
1	1.730000000 MHz	30.83	Quasi Peak	-25.17
2	1.886000000 MHz	22.17	Average	-23.83
1	1.950000000 MHz	31.06	Quasi Peak	-24.94
2	2.078000000 MHz	23.58	Average	-22.42
2	2.118000000 MHz	23.80	Average	-22.20
1	2.530000000 MHz	27.85	Quasi Peak	-28.15

Other emissions present had amplitudes at least 20 dB below the limit.

Summary of Results for AC Line Conducted Emissions Results

The EUT demonstrated compliance with the AC Line Conducted Emissions requirements of 47CFR Part 15C and other applicable emissions requirements. The EUT – computer configurations worst-case configuration demonstrated a minimum margin of -18.3 dB below the requirement. Other emissions were present with amplitudes at least 20 dB below the limit and worst-case amplitudes recorded.

General Radiated Emissions Procedure

The EUT was arranged in a typical equipment configuration and operated through all available mode during testing. Preliminary testing was performed in a screen room with the EUT positioned 1 meter from the FSM. Radiated emissions measurements were performed to identify the frequencies, which produced the highest emissions. Each radiated emission was then maximized at the OATS location before final radiated measurements were performed. Final data was taken with the EUT located on the OATS at 3 meters distance between the EUT and the receiving antenna. The frequency spectrum from 9 kHz to 25,000 MHz was searched for general radiated emissions. Measured emission levels were maximized by EUT placement on the table, rotating the turntable through 360 degrees, varying the antenna height between 1 and 4 meters above the ground plane and changing antenna position between horizontal and vertical polarization. Antennas used were Loop from 9 kHz to 30 MHz, Broadband Biconical from 30 to 200 MHz, Biconilog from 30 to 1000 MHz, Log Periodic from 200 MHz to 1 GHz and or double Ridge or pyramidal horns and mixers above 1 GHz, notch filters and appropriate amplifiers and external mixers were utilized.

Table 6 General Radiated Emissions Data

Frequency (MHz)	Horizontal Peak (dB μ V/m)	Horizontal Quasi-Peak (dB μ V/m)	Vertical Peak (dB μ V/m)	Vertical Quasi-Peak (dB μ V/m)	Limit @ 3m (dB μ V/m)	Horizontal Margin (dB)	Vertical Margin (dB)
74.2	29.2	25.6	30.0	26.9	40.0	-14.4	-13.1
110.6	34.1	27.7	30.7	25.7	40.0	-12.3	-14.3
125.0	31.1	28.1	31.8	27.9	40.0	-11.9	-12.1
144.0	27.7	23.4	29.2	23.6	40.0	-16.6	-16.4
187.2	22.1	15.4	27.0	23.4	40.0	-24.6	-16.6
216.0	20.4	15.9	20.8	15.3	40.0	-24.1	-24.7

Other emissions present had amplitudes at least 20 dB below the limit. Peak and Quasi-Peak amplitude emissions are recorded for frequency range below 1000 MHz. Peak and Average amplitude emissions are recorded for frequency range above 1000 MHz.

Summary of Results for General Radiated Emissions

The EUT demonstrated compliance with the radiated emissions requirements of 47 CFR Part 15C paragraph 15.209, RSS-210 Issue 10, and RSS-GEN Issue 5 Intentional Radiators. The EUT configuration demonstrated a minimum margin of -11.9 dB below the requirements. Other emissions were present with amplitudes at least 20 dB below the Limits.

Operation in the Band 2400 – 2483.5 MHz

The transmitter output power; harmonic and general emissions were measured on an open area test site @ 3 meters. The EUT was placed on a turntable elevated as required above the ground plane and at a distance of 3 meters from the FSM antenna. The peak and quasi-peak amplitude of frequencies below 1000 MHz were measured using a spectrum analyzer. The peak and average amplitude of frequencies above 1000 MHz were measured using a spectrum analyzer. The amplitude of each emission was then recorded from the analyzer display. Emissions radiated outside of the specified bands, except for harmonics, shall be attenuated by at least 50 dB below the level of the fundamental or to the general radiated emission limits, whichever is the lesser attenuation. Antenna port emission plots were taken of transmitter performance for reference in this and other documentation using test sample #2. The amplitude of each radiated emission was measured on the OATS at a distance of 3 meters from the FSM antenna testing was performed on sample representative of production with integral antenna (sample #1) with worst-case data provided. The amplitude of each radiated emission was maximized by equipment orientation and placement on the turn table, raising and lowering the FSM (Field Strength Measuring) antenna, changing the FSM antenna polarization, and by rotating the turntable. A Loop antenna was used for measuring emissions from 0.009 to 30 MHz, Biconilog Antenna for 30 to 1000 MHz, Double-Ridge, and/or Pyramidal Horn Antennas from 1 GHz to 25 GHz. Emissions were measured in dB μ V/m @ 3 meters.

Plots were taken of transmitter performance (using sample #2) for reference in this and other documentation displaying compliance with the specifications

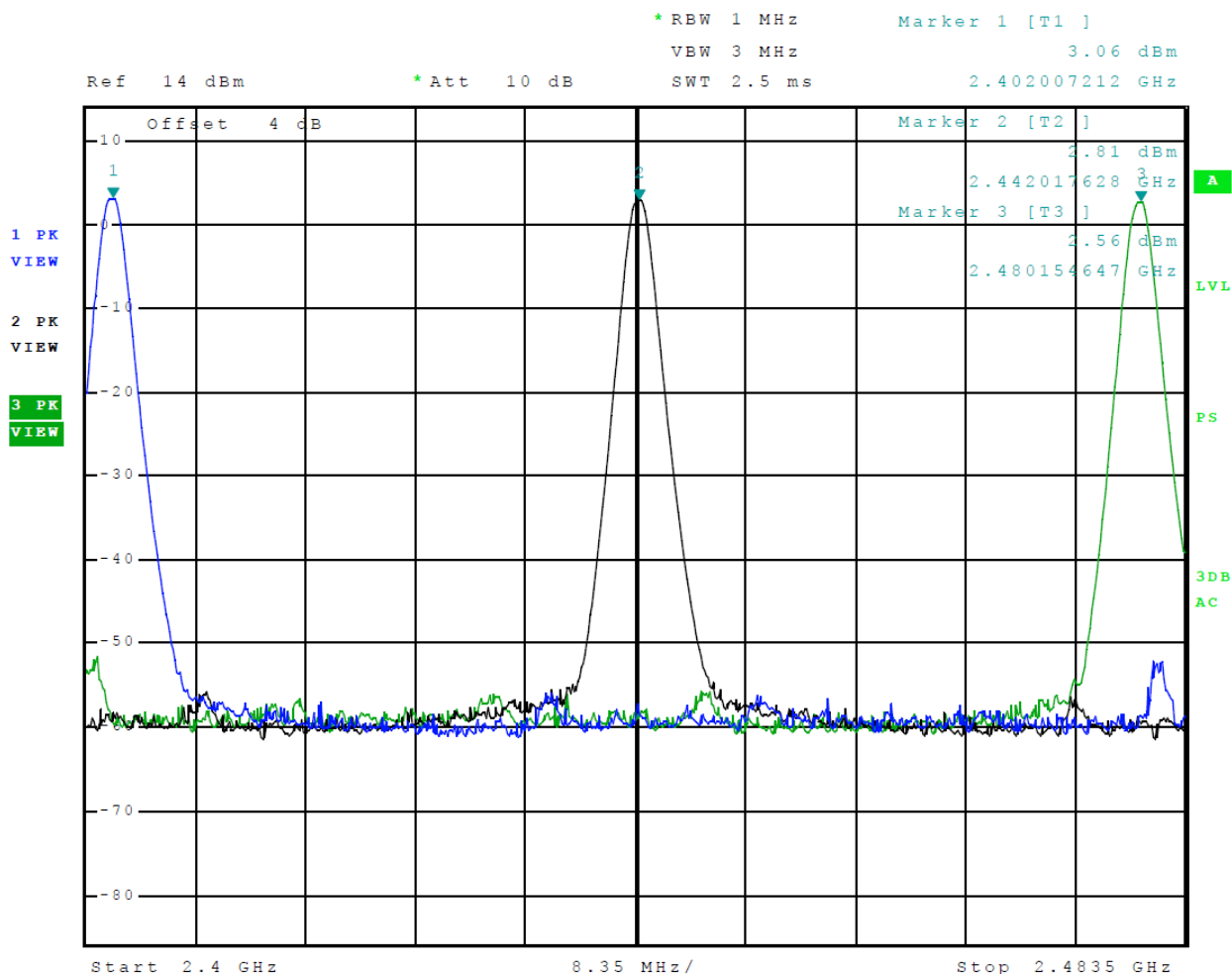

Figure 3 Plot of Transmitter Emissions Operation in 2402-2480 MHz Mode 1 BT BR

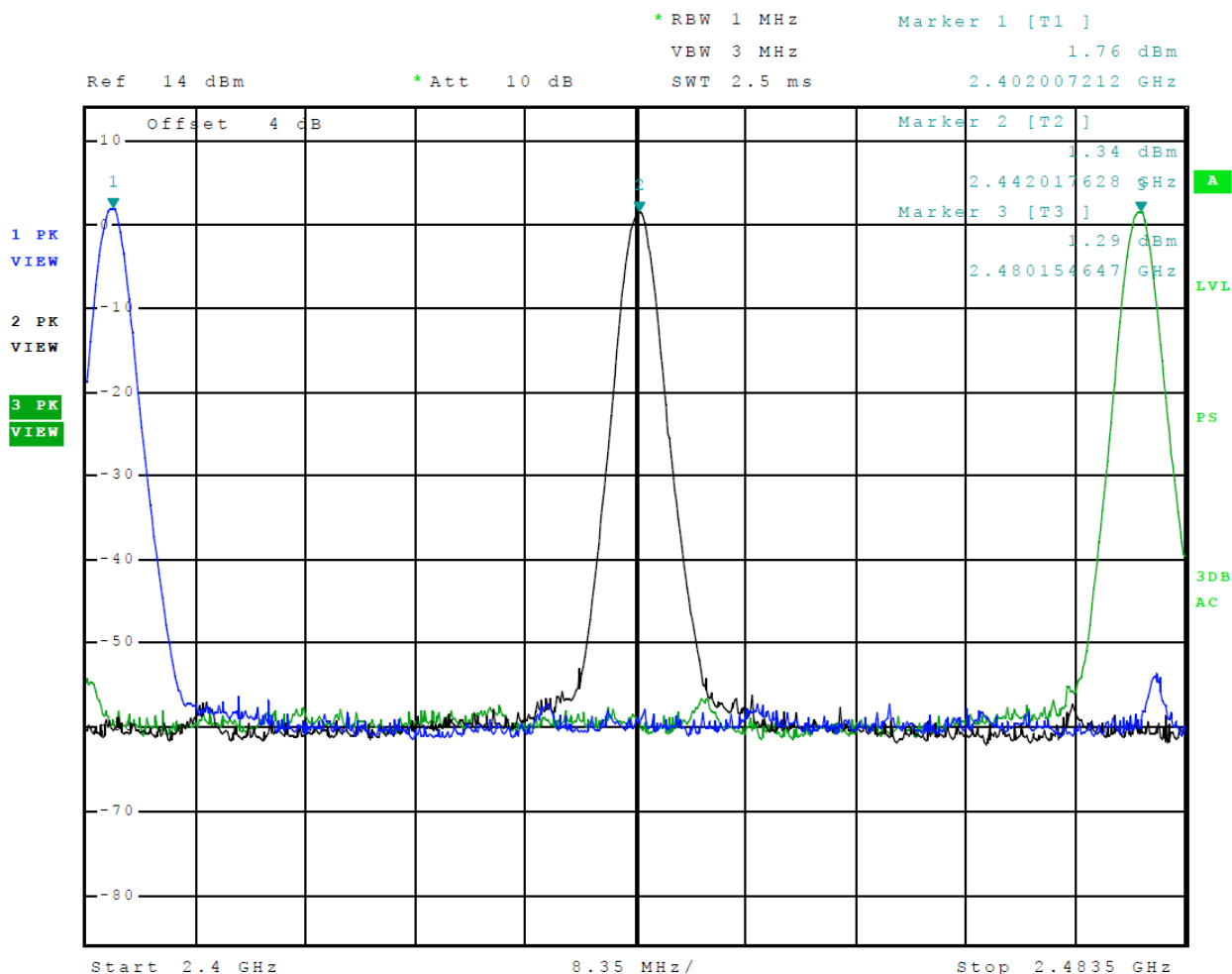

Figure 4 Plot of Transmitter Emissions Operation in 2402-2480 MHz Mode 2 BT 2EDR

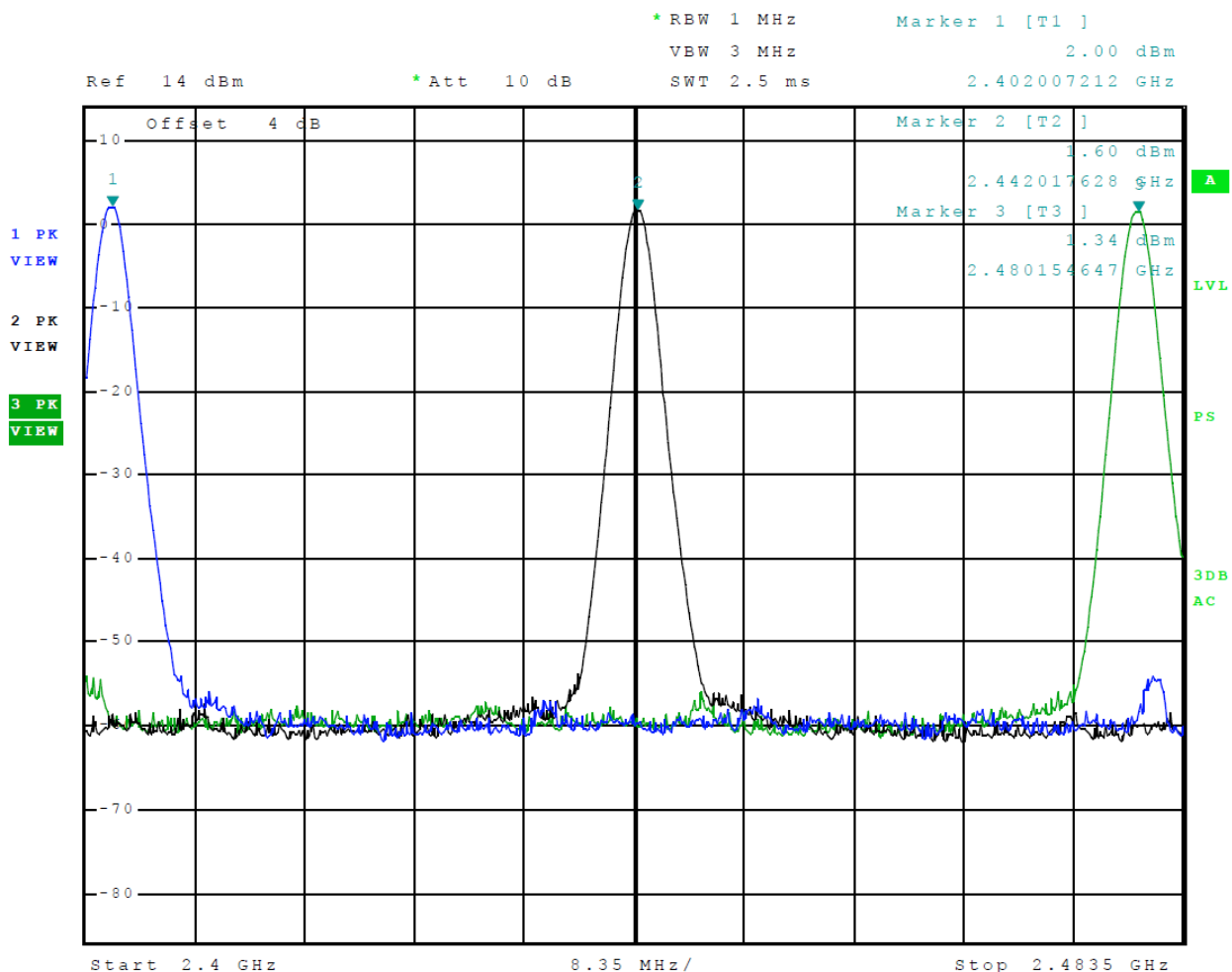

Figure 5 Plot of Transmitter Emissions Operation in 2402-2480 MHz Mode 3 BT 3EDR

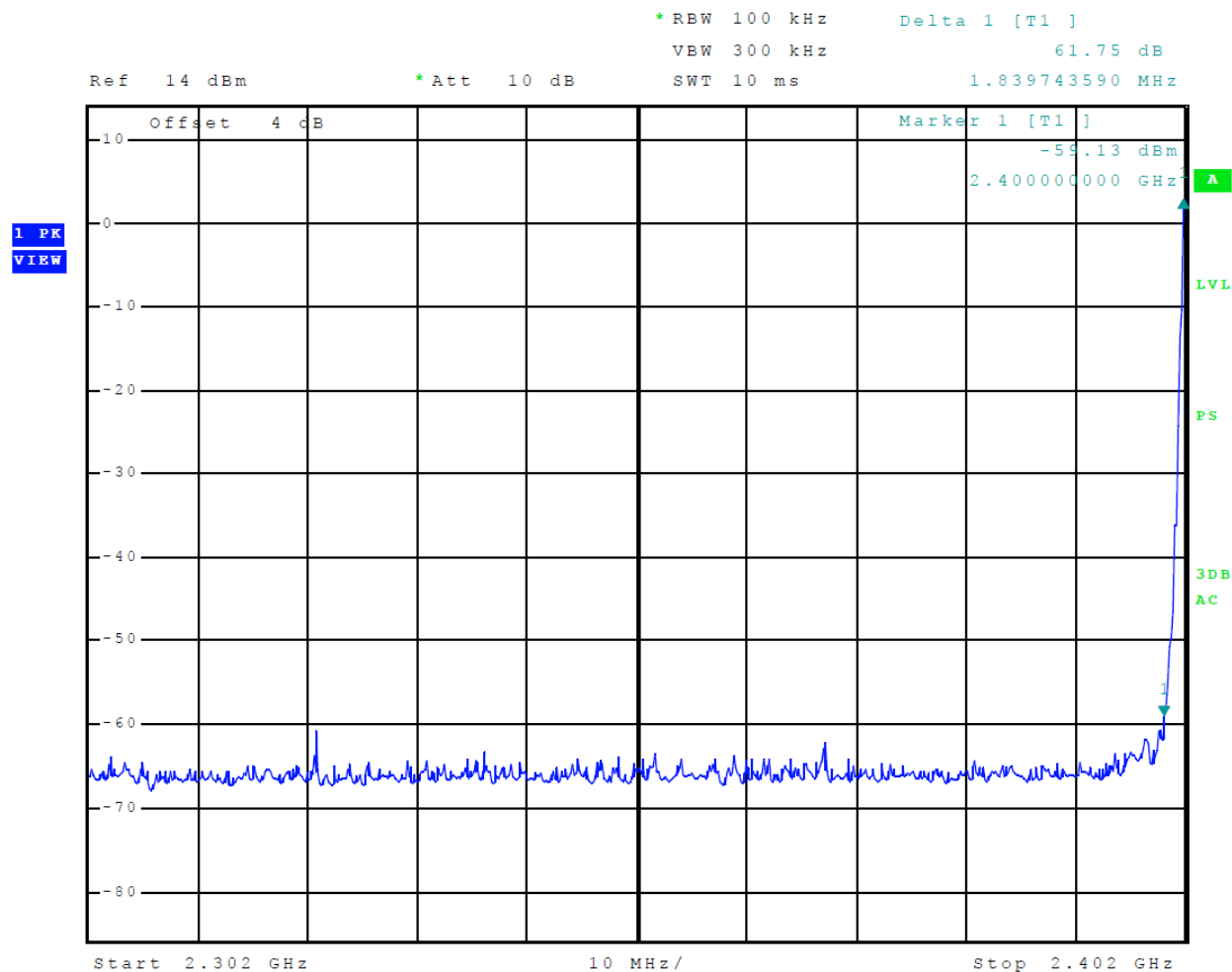

Figure 6 Plot of Transmitter Emissions Low Band Edge Mode 1 BT BR

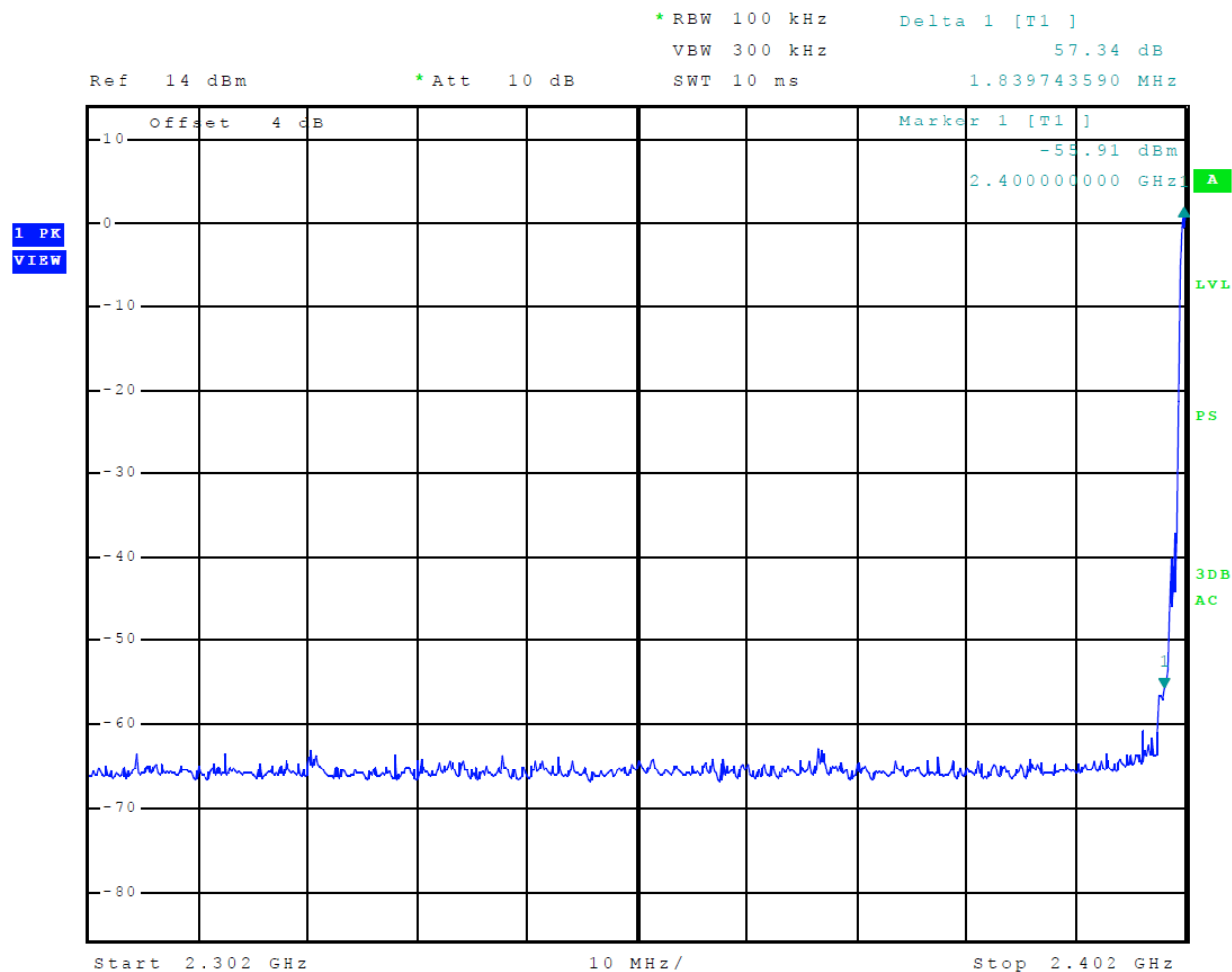

Figure 7 Plot of Transmitter Emissions Low Band Edge Mode 2 BT 2EDR

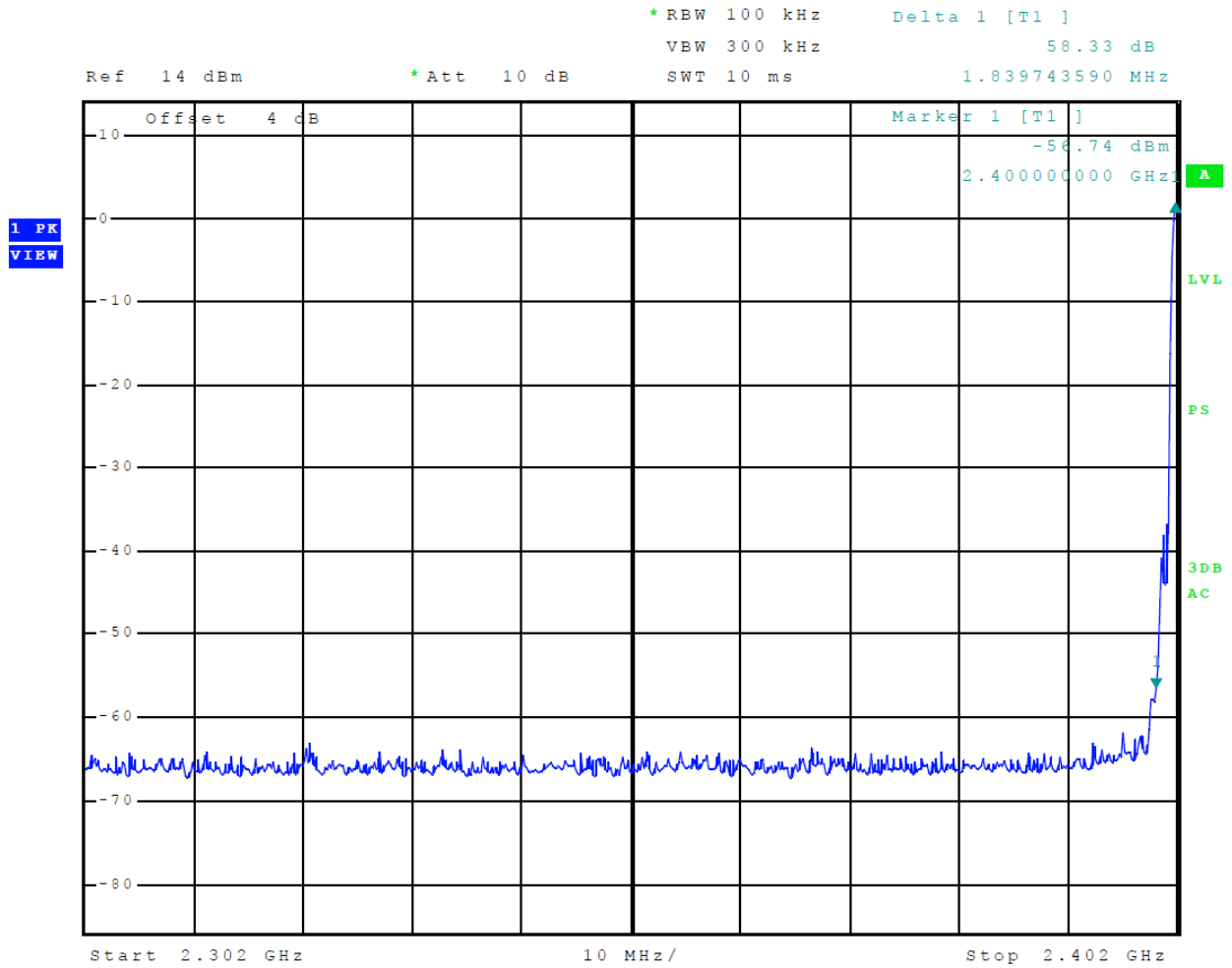

Figure 8 Plot of Transmitter Emissions Low Band Edge Mode 3 BT 3EDR

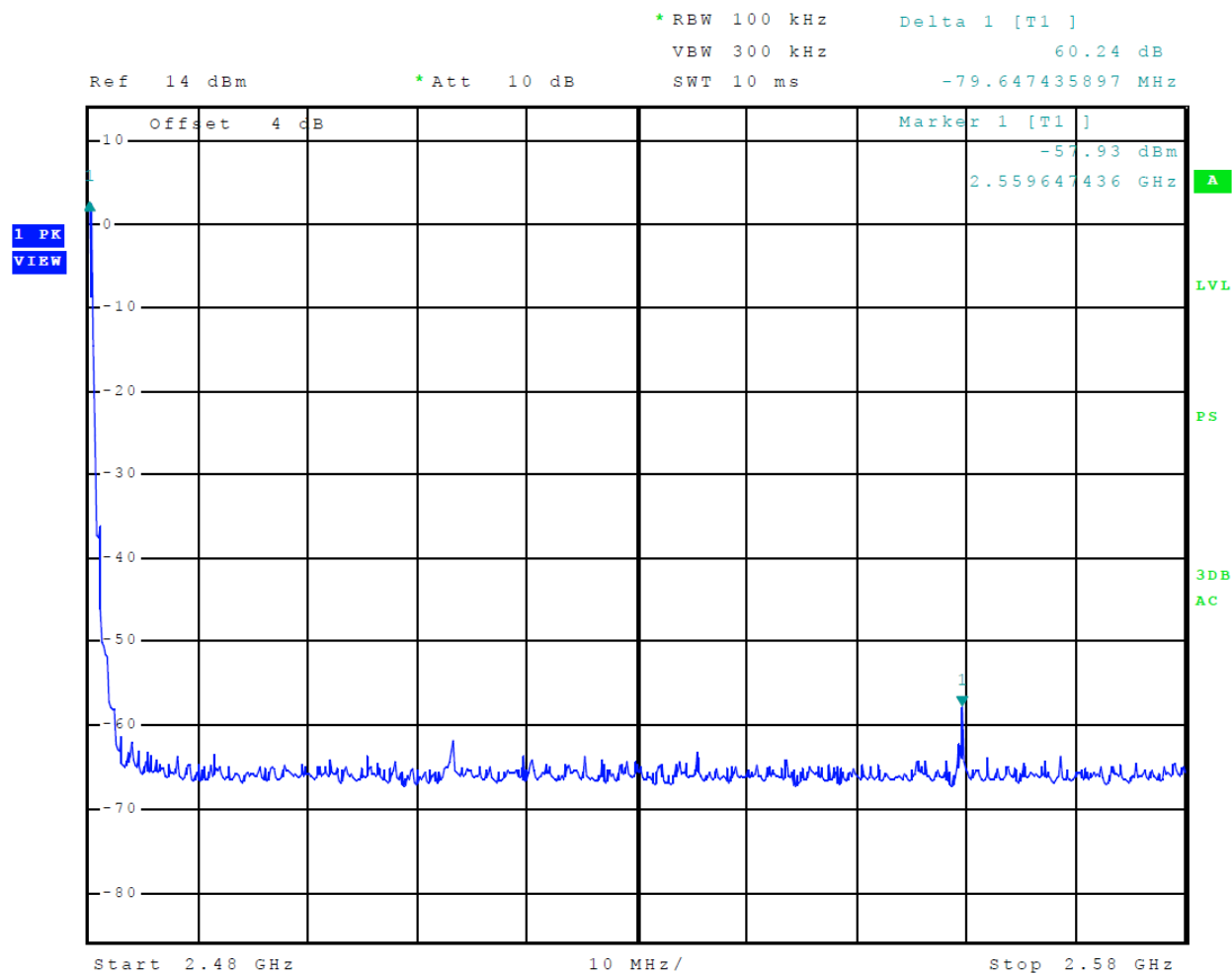

Figure 9 Plot of Transmitter Emissions High Band Edge Mode 1 BT BR

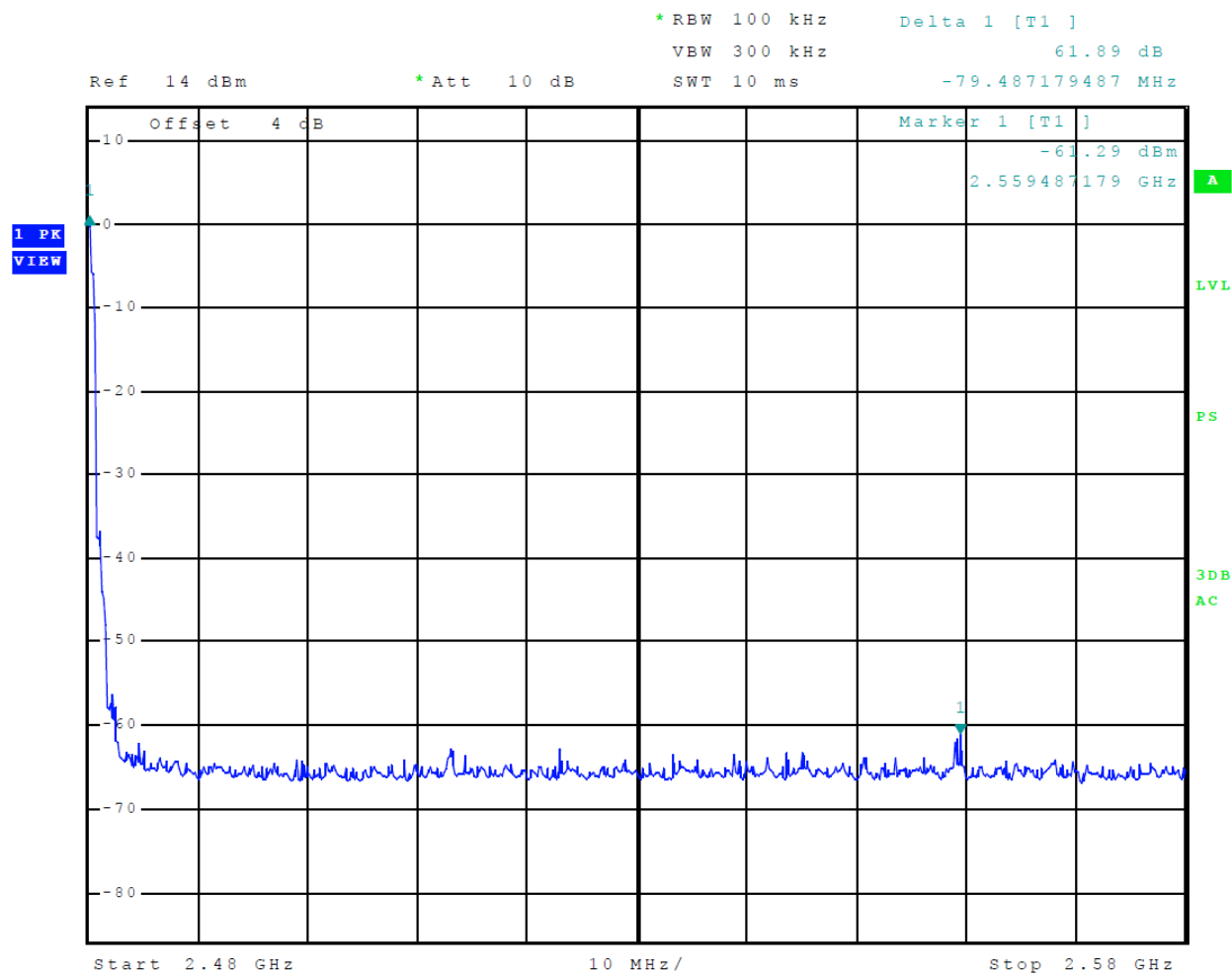

Figure 10 Plot of Transmitter Emissions High Band Edge Mode 2 BT 2EDR

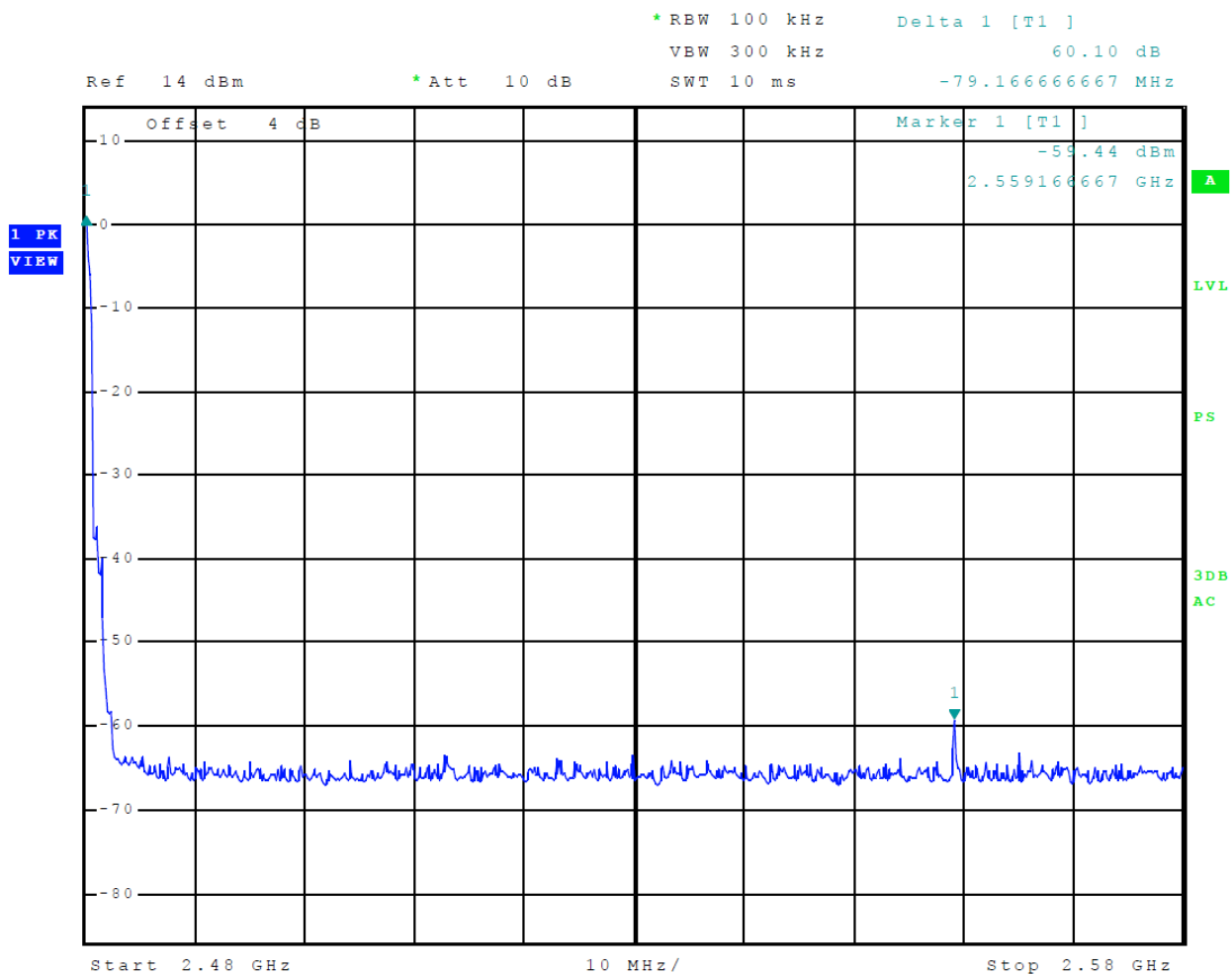

Figure 11 Plot of Transmitter Emissions High Band Edge Mode 3 BR 2EDR

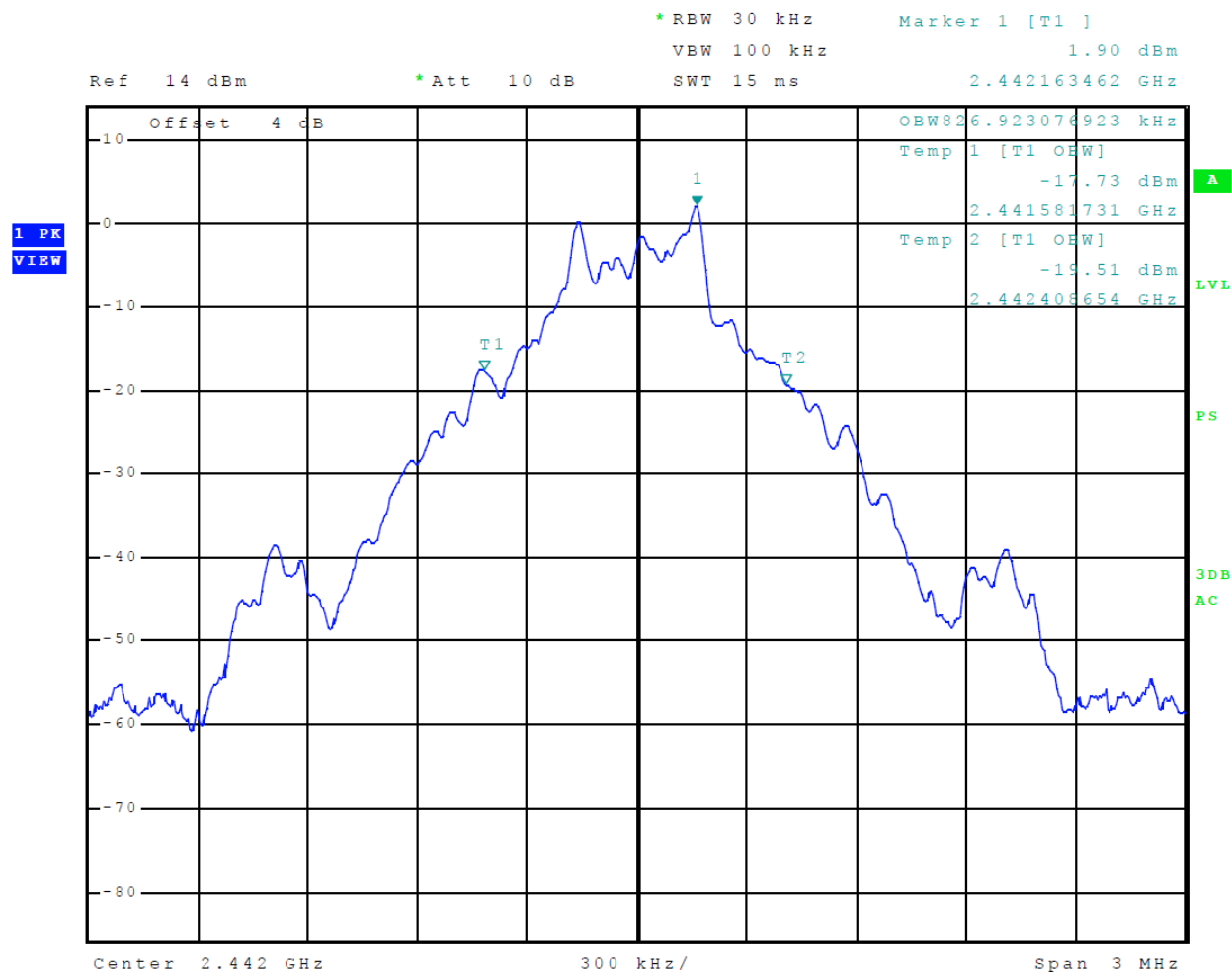

Figure 12 Plot of Transmitter Emissions 99% Occupied Bandwidth Mode 1 BT BR

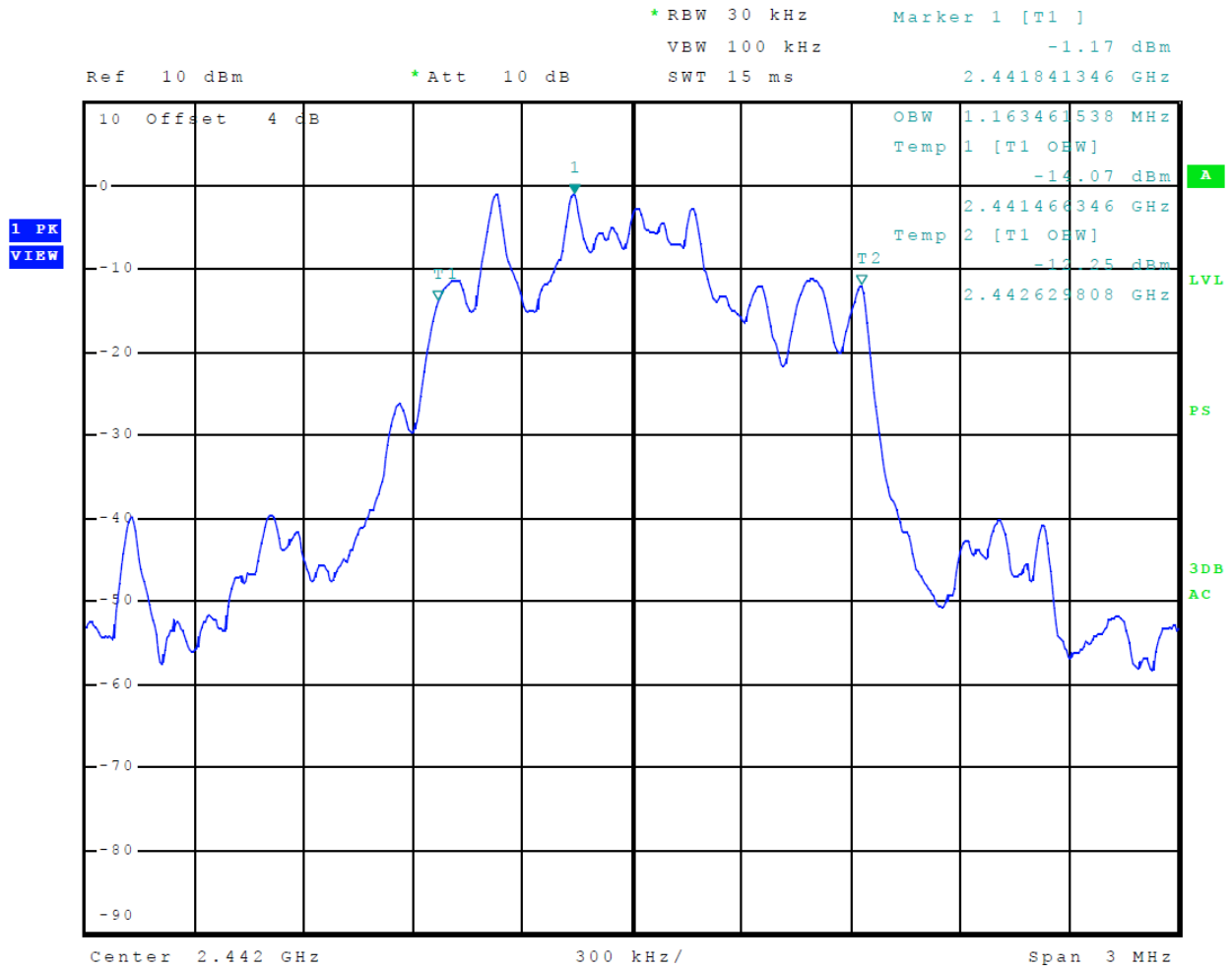

Figure 13 Plot of Transmitter Emissions 99% Occupied Bandwidth Mode 1 BT 2EDR

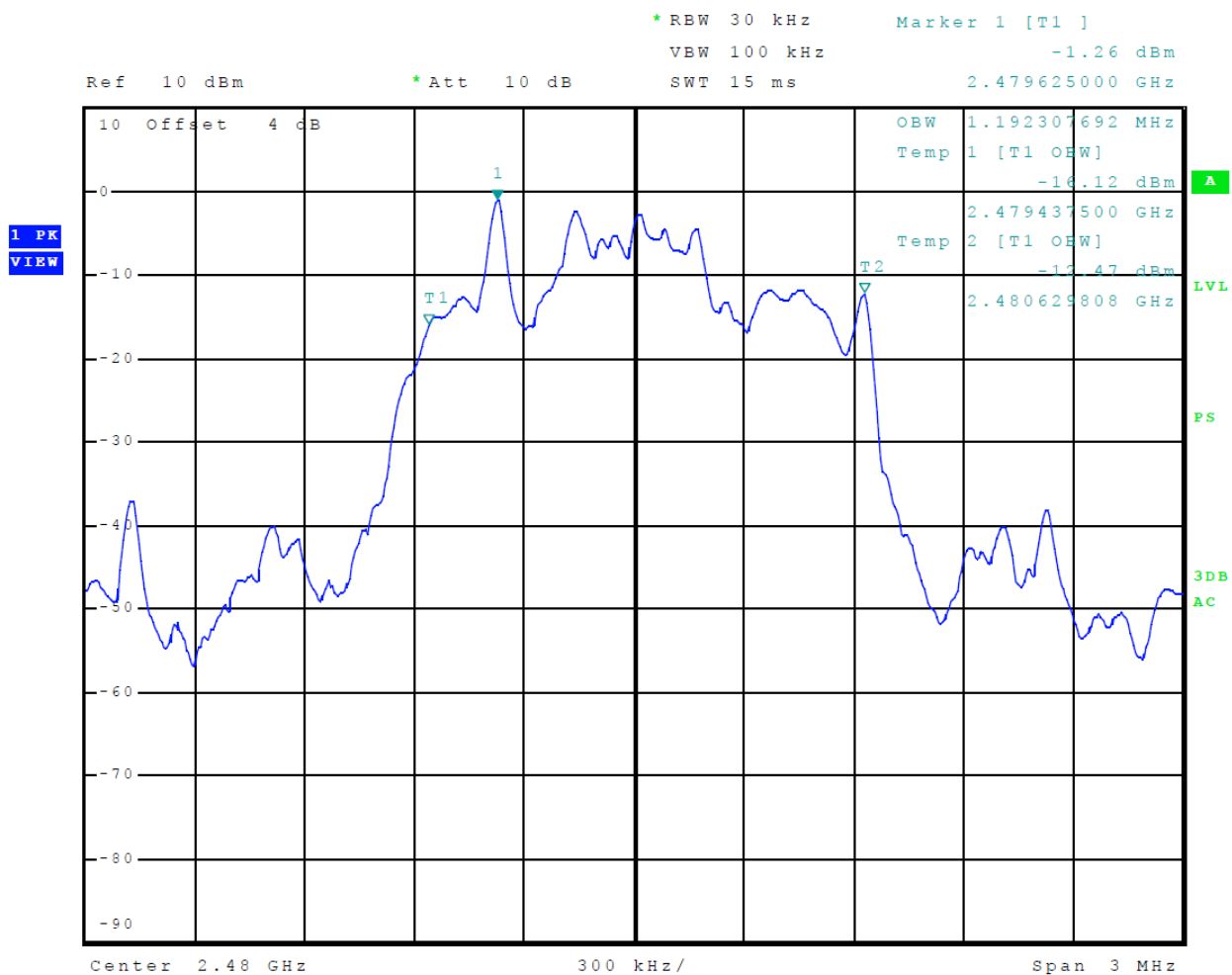

Figure 14 Plot of Transmitter Emissions 99% Occupied Bandwidth Mode 1 BT 3EDR

Transmitter Emissions Data

Table 7 Transmitter Radiated Emissions Mode 1 BT BR

Frequency in MHz	Horizontal Peak (dBµV/m)	Horizontal Average (dBµV/m)	Vertical Peak (dBµV/m)	Vertical Average (dBµV/m)	Limit @ 3m (dBµV/m)	Horizontal Margin (dB)	Vertical Margin (dB)
2402.0	89.5	78.3	88.4	77.2	94.0	-15.7	-16.8
4804.0	49.6	36.3	49.4	36.3	54.0	-17.7	-17.7
7206.0	53.1	40.4	53.0	40.4	54.0	-13.6	-13.6
9608.0	56.2	42.8	55.7	42.8	54.0	-11.2	-11.2
12010.0	59.1	46.7	60.6	46.7	54.0	-7.3	-7.3
14412.0	62.1	49.3	62.0	49.4	54.0	-4.7	-4.6
16814.0	65.4	51.9	64.8	51.8	54.0	-2.1	-2.2
2442.0	94.1	82.4	92.1	80.3	94.0	-11.6	-13.7
4884.0	49.3	36.1	49.5	36.2	54.0	-17.9	-17.8
7326.0	53.1	40.4	54.3	40.5	54.0	-13.6	-13.5
9768.0	55.9	43.0	56.8	42.9	54.0	-11.0	-11.1
12210.0	59.9	47.0	60.2	46.9	54.0	-7.0	-7.1
14652.0	62.8	49.2	62.4	49.2	54.0	-4.8	-4.8
17094.0	65.7	52.5	65.3	52.4	54.0	-1.5	-1.6
2480.0	92.8	81.6	91.1	79.9	94.0	-12.4	-14.1
4960.0	50.0	36.3	49.9	36.3	54.0	-17.7	-17.7
7440.0	53.8	40.5	53.9	40.5	54.0	-13.5	-13.5
9920.0	55.5	42.7	55.9	42.9	54.0	-11.3	-11.1
12400.0	59.7	47.1	60.3	47.2	54.0	-6.9	-6.8
14880.0	61.8	49.0	61.9	49.0	54.0	-5.0	-5.0
17360.0	64.4	51.5	65.3	51.5	54.0	-2.5	-2.5

Other emissions present had amplitudes at least 20 dB below the limit. Peak and Quasi-Peak amplitude emissions are recorded for frequency range below 1000 MHz. Peak and Average amplitude emissions are recorded for frequency range above 1000 MHz.

Rogers Labs, Inc.
 4405 West 259th Terrace
 Louisburg, KS 66053
 Phone/Fax: (913) 837-3214
 Revision 1

Garmin International, Inc.
 Model: AA4113
 Test: 200922
 Test to: CFR47 15C, RSS-Gen RSS-247
 File: AA4113 DXX TstRpt 200922

SN's: 3341634221 / 3341634272
 FCC ID: IPH-A4113
 IC: 1792A-A4113
 Date: November 18, 2020
 Page 40 of 49

Table 8 Transmitter Radiated Emissions Mode 2 BT 2EDR

Frequency in MHz	Horizontal Peak (dBµV/m)	Horizontal Average (dBµV/m)	Vertical Peak (dBµV/m)	Vertical Average (dBµV/m)	Limit @ 3m (dBµV/m)	Horizontal Margin (dB)	Vertical Margin (dB)
2402.0	89.0	75.2	87.7	73.4	94.0	-18.8	-20.6
4804.0	49.5	36.3	49.8	36.3	54.0	-17.7	-17.7
7206.0	53.4	40.3	54.0	40.4	54.0	-13.7	-13.6
9608.0	55.9	42.9	55.9	42.8	54.0	-11.1	-11.2
12010.0	60.5	46.6	59.1	46.7	54.0	-7.4	-7.3
14412.0	62.3	49.3	62.2	49.3	54.0	-4.7	-4.7
16814.0	65.2	51.8	65.3	51.9	54.0	-2.2	-2.1
2442.0	93.5	79.7	90.8	76.4	94.0	-14.3	-17.6
4884.0	49.6	36.0	49.0	36.1	54.0	-18.0	-17.9
7326.0	53.4	40.5	53.7	40.5	54.0	-13.5	-13.5
9768.0	55.9	42.8	55.8	42.9	54.0	-11.2	-11.1
12210.0	60.3	46.9	59.9	47.0	54.0	-7.1	-7.0
14652.0	62.3	49.2	61.9	49.2	54.0	-4.8	-4.8
17094.0	65.1	52.3	65.4	52.4	54.0	-1.7	-1.6
2480.0	92.8	79.1	90.1	76.4	94.0	-14.9	-17.6
4960.0	49.2	36.3	49.4	36.3	54.0	-17.7	-17.7
7440.0	53.3	40.5	53.7	40.5	54.0	-13.5	-13.5
9920.0	55.6	42.9	56.0	42.8	54.0	-11.1	-11.2
12400.0	59.9	47.1	59.4	47.0	54.0	-6.9	-7.0
14880.0	61.7	49.0	61.9	49.0	54.0	-5.0	-5.0
17360.0	64.7	51.5	64.3	51.5	54.0	-2.5	-2.5

Other emissions present had amplitudes at least 20 dB below the limit. Peak and Quasi-Peak amplitude emissions are recorded for frequency range below 1000 MHz. Peak and Average amplitude emissions are recorded for frequency range above 1000 MHz.

Table 9 Transmitter Radiated Emissions Mode 3 BT 3EDR

Frequency in MHz	Horizontal Peak (dBµV/m)	Horizontal Average (dBµV/m)	Vertical Peak (dBµV/m)	Vertical Average (dBµV/m)	Limit @ 3m (dBµV/m)	Horizontal Margin (dB)	Vertical Margin (dB)
2402.0	89.2	75.4	88.1	74.2	94.0	-18.6	-19.8
4804.0	49.7	36.3	49.4	36.3	54.0	-17.7	-17.7
7206.0	53.3	40.4	53.0	40.4	54.0	-13.6	-13.6
9608.0	56.0	42.8	56.6	43.0	54.0	-11.2	-11.0
12010.0	59.3	46.7	59.9	46.7	54.0	-7.3	-7.3
14412.0	62.6	49.3	62.5	49.3	54.0	-4.7	-4.7
16814.0	64.5	51.9	64.8	51.8	54.0	-2.1	-2.2
2442.0	94.2	80.3	91.3	77.0	94.0	-13.7	-17.0
4884.0	49.5	36.1	49.8	36.1	54.0	-17.9	-17.9
7326.0	53.5	40.4	53.6	40.4	54.0	-13.6	-13.6
9768.0	55.4	43.0	56.1	42.9	54.0	-11.0	-11.1
12210.0	60.2	47.0	59.6	46.9	54.0	-7.0	-7.1
14652.0	62.8	49.2	62.9	49.2	54.0	-4.8	-4.8
17094.0	65.1	52.5	65.3	52.4	54.0	-1.5	-1.6
2480.0	93.8	80.1	90.2	76.5	94.0	-13.9	-17.5
4960.0	49.6	36.3	49.3	36.3	54.0	-17.7	-17.7
7440.0	53.4	40.5	53.3	40.5	54.0	-13.5	-13.5
9920.0	56.1	42.8	56.0	43.0	54.0	-11.2	-11.0
12400.0	60.2	47.0	60.7	47.1	54.0	-7.0	-6.9
14880.0	62.3	49.0	61.9	48.9	54.0	-5.0	-5.1
17360.0	64.1	51.4	64.6	51.5	54.0	-2.6	-2.5

Other emissions present had amplitudes at least 20 dB below the limit. Peak and Quasi-Peak amplitude emissions are recorded for frequency range below 1000 MHz. Peak and Average amplitude emissions are recorded for frequency range above 1000 MHz.

Summary of Results for Transmitter Radiated Emissions of Intentional Radiator

The EUT demonstrated compliance with the radiated emissions requirements of FCC 47 CFR Part 15.249, Industry Canada RSS-210 Issue 10 and RSS-GEN Issue 5 Intentional Radiator regulations. The EUT worst-case test sample configuration demonstrated minimum average margin of -11.6 dB below the average emission limit for the fundamental. The EUT worst-case configuration demonstrated minimum radiated harmonic emission margin of -1.5 dB below the limit. No other radiated emissions were found in the restricted bands less than 20 dB below limits than those recorded in this report. Other emissions were present with amplitudes at least 20 dB below the limits.

Annex

- Annex A Measurement Uncertainty Calculations
- Annex B Test Equipment
- Annex C Rogers Qualifications
- Annex D Laboratory Certificate of Accreditation

Annex A Measurement Uncertainty Calculations

The measurement uncertainty was calculated for all measurements listed in this test report according To CISPR 16-4. Result of measurement uncertainty calculations are recorded below. Component and process variability of production devices similar to those tested may result in additional deviations. The manufacturer has the sole responsibility of continued compliance.

Measurement	Expanded Measurement Uncertainty $U_{(lab)}$
3 Meter Horizontal 0.009-1000 MHz Measurements	4.16
3 Meter Vertical 0.009-1000 MHz Measurements	4.33
3 Meter Measurements 1-18 GHz	5.14
3 Meter Measurements 18-40 GHz	5.16
10 Meter Horizontal Measurements 0.009-1000 MHz	4.15
10 Meter Vertical Measurements 0.009-1000 MHz	4.32
AC Line Conducted	1.75
Antenna Port Conducted power	1.17
Frequency Stability	1.00E-11
Temperature	1.6°C
Humidity	3%

Annex B Test Equipment

<u>Equipment</u>	<u>Manufacturer</u>	<u>Model (SN)</u>	<u>Band</u>	<u>Cal Date(m/d/y)</u>	<u>Due</u>
<input checked="" type="checkbox"/> LISN	FCC	FCC-LISN-50-25-10(1PA) (160611)	.15-30MHz	4/21/2020	4/21/2021
<input checked="" type="checkbox"/> LISN	Compliance Design	FCC-LISN-2.Mod.cd,(126)	.15-30MHz	10/14/2019	10/14/2020
<input checked="" type="checkbox"/> Cable	Huber & Suhner Inc.	Sucoflex102ea(L10M)(303073)	9kHz-40 GHz	10/14/2019	10/14/2020
<input type="checkbox"/> Cable	Huber & Suhner Inc.	Sucoflex102ea(1.5M)(303069)	9kHz-40 GHz	10/14/2019	10/14/2020
<input checked="" type="checkbox"/> Cable	Huber & Suhner Inc.	Sucoflex102ea(1.5M)(303070)	9kHz-40 GHz	10/14/2019	10/14/2020
<input checked="" type="checkbox"/> Cable	Belden	RG-58 (L1-CAT3-11509)	9kHz-30 MHz	10/14/2019	10/14/2020
<input checked="" type="checkbox"/> Cable	Belden	RG-58 (L2-CAT3-11509)	9kHz-30 MHz	10/14/2019	10/14/2020
<input checked="" type="checkbox"/> Antenna	Com Power	AL-130 (121055)	.001-30 MHz	10/14/2019	10/14/2020
<input type="checkbox"/> Antenna:	EMCO	6509	.001-30 MHz	10/16/2018	10/16/2020
<input type="checkbox"/> Antenna	ARA	BCD-235-B (169)	20-350MHz	10/14/2019	10/14/2020
<input type="checkbox"/> Antenna:	Schwarzbeck Model:	BBA 9106/VHBB 9124 (9124-627)		4/21/2020	4/21/2021
<input checked="" type="checkbox"/> Antenna	Sunol	JB-6 (A100709)	30-1000 MHz	10/14/2019	10/14/2020
<input type="checkbox"/> Antenna	ETS-Lindgren	3147 (40582)	200-1000MHz	10/14/2019	10/14/2020
<input type="checkbox"/> Antenna:	Schwarzbeck Model:	VULP 9118 A (VULP 9118 A-534)		4/21/2020	4/21/2021
<input checked="" type="checkbox"/> Antenna	ETS-Lindgren	3117 (200389)	1-18 GHz	4/21/2020	4/23/2022
<input type="checkbox"/> Antenna	Com Power	AH-118 (10110)	1-18 GHz	10/14/2019	10/14/2020
<input checked="" type="checkbox"/> Antenna	Com Power	AH-840 (101046)	18-40 GHz	4/21/2020	4/21/2021
<input checked="" type="checkbox"/> Analyzer	Rohde & Schwarz	ESU40 (100108)	20Hz-40GHz	5/15/2020	5/15/2021
<input checked="" type="checkbox"/> Analyzer	Rohde & Schwarz	ESW44 (101534)	20Hz-44GHz	1/27/2020	1/27/2021
<input type="checkbox"/> Analyzer	Rohde & Schwarz	FS-Z60, 90, 140, and 220	40GHz-220GHz	12/22/2017	12/22/2027
<input checked="" type="checkbox"/> Amplifier	Com-Power	PA-010 (171003)	100Hz-30MHz	10/14/2019	10/14/2020
<input checked="" type="checkbox"/> Amplifier	Com-Power	CPPA-102 (01254)	1-1000 MHz	10/14/2019	10/14/2020
<input checked="" type="checkbox"/> Amplifier	Com-Power	PAM-118A (551014)	0.5-18 GHz	10/14/2019	10/14/2020
<input checked="" type="checkbox"/> Amplifier	Com-Power	PAM-840A (461328)	18-40 GHz	10/14/2019	10/14/2020
<input checked="" type="checkbox"/> Power Meter	Agilent	N1911A with N1921A	0.05-40 GHz	4/21/2020	4/21/2021
<input type="checkbox"/> Generator	Rohde & Schwarz	SMB100A6 (100150)	20Hz-6 GHz	4/21/2020	4/21/2021
<input type="checkbox"/> Generator	Rohde & Schwarz	SMBV100A6 (260771)	20Hz-6 GHz	4/21/2020	4/21/2021
<input type="checkbox"/> RF Filter	Micro-Tronics	BRC50722 (009).9G notch	30-18000 MHz	4/21/2020	4/21/2021
<input type="checkbox"/> RF Filter	Micro-Tronics	HPM50114 (017)1.5G HPF	30-18000 MHz	4/21/2020	4/21/2021
<input checked="" type="checkbox"/> RF Filter	Micro-Tronics	HPM50117 (063) 3G HPF	30-18000 MHz	4/21/2020	4/21/2021
<input type="checkbox"/> RF Filter	Micro-Tronics	HPM50105 (059) 6G HPF	30-18000 MHz	4/21/2020	4/21/2021
<input type="checkbox"/> RF Filter	Micro-Tronics	BRM50702 (172) 2G notch	30-18000 MHz	4/21/2020	4/21/2021
<input type="checkbox"/> RF Filter	Micro-Tronics	BRC50703 (G102) 5G notch	30-18000 MHz	4/21/2020	4/21/2021
<input type="checkbox"/> RF Filter	Micro-Tronics	BRC50705 (024) 5G notch	30-18000 MHz	4/21/2020	4/21/2021
<input type="checkbox"/> Attenuator	Fairview	SA6NFNF100W-40 (1625)	30-18000 MHz	4/21/2020	4/18/2021
<input checked="" type="checkbox"/> Attenuator	Mini-Circuits	VAT-3W2+ (1436)	30-6000 MHz	4/21/2020	4/21/2021
<input type="checkbox"/> Attenuator	Mini-Circuits	VAT-3W2+ (1445)	30-6000 MHz	4/21/2020	4/21/2021
<input type="checkbox"/> Attenuator	Mini-Circuits	VAT-3W2+ (1735)	30-6000 MHz	4/21/2020	4/21/2021
<input type="checkbox"/> Attenuator	Mini-Circuits	VAT-6W2+ (1438)	30-6000 MHz	4/21/2020	4/21/2021
<input type="checkbox"/> Attenuator	Mini-Circuits	VAT-6W2+ (1736)	30-6000 MHz	4/21/2020	4/21/2021
<input checked="" type="checkbox"/> Weather station	Davis	6312 (A81120N075)		11/4/2019	11/4/2020

Rogers Labs, Inc.
 4405 West 259th Terrace
 Louisburg, KS 66053
 Phone/Fax: (913) 837-3214
 Revision 1

Garmin International, Inc.
 Model: AA4113
 Test: 200922
 Test to: CFR47 15C, RSS-Gen RSS-247
 File: AA4113 DXX TstRpt 200922

SN's: 3341634221 / 3341634272
 FCC ID: IPH-A4113
 IC: 1792A-A4113
 Date: November 18, 2020
 Page 46 of 49

List of Test Equipment	Calibration	Date (m/d/y)	Due
<input type="checkbox"/> Frequency Counter: Leader LDC-825 (8060153		4/21/2020	4/21/2021
<input type="checkbox"/> LISN: Com-Power Model LI-220A		10/14/2019	10/14/2020
<input type="checkbox"/> LISN: Com-Power Model LI-550C		10/14/2019	10/14/2020
<input type="checkbox"/> ISN: Com-Power Model ISN T-8		4/21/2020	4/21/2021
<input type="checkbox"/> LISN: Fischer Custom Communications Model: FCC-LISN-50-16-2-08		4/21/2020	4/21/2021
<input type="checkbox"/> Cable Huber & Suhner Inc. Sucoflex102ea(1.5M)(303070) 9kHz-40 GHz		10/14/2019	10/14/2020
<input type="checkbox"/> Cable Huber & Suhner Inc. Sucoflex102ea(1.5M)(303072) 9kHz-40 GHz		10/14/2019	10/14/2020
<input type="checkbox"/> Cable Huber & Suhner Inc. Sucoflex102ea(L4M)(281184) 9kHz-40 GHz		10/14/2019	10/14/2020
<input type="checkbox"/> Cable Huber & Suhner Inc. Sucoflex102ea(L10M)(317546)9kHz-40 GHz		10/14/2019	10/14/2020
<input type="checkbox"/> Cable Time Microwave 4M-750HF290-750 (4M) 9kHz-24 GHz		10/14/2019	10/14/2020
<input type="checkbox"/> RF Filter Micro-Tronics BRC17663 (001) 9.3-9.5 notch 30-1800 MHz		4/21/2020	4/21/2021
<input type="checkbox"/> RF Filter Micro-Tronics BRC19565 (001) 9.2-9.6 notch 30-1800 MHz		10/16/2018	4/21/2021
<input type="checkbox"/> Analyzer HP 8562A (3051A05950) 9kHz-125GHz		4/21/2020	4/21/2021
<input type="checkbox"/> Analyzer HP External Mixers11571, 11970 25GHz-110GHz		4/18/2015	4/18/2025
<input type="checkbox"/> Analyzer HP 8591EM (3628A00871)		4/21/2020	4/21/2021
<input type="checkbox"/> Antenna: Solar 9229-1 & 9230-1		2/22/2020	2/22/2021
<input type="checkbox"/> CDN: Com-Power Model CDN325E		10/14/2019	10/14/2020
<input type="checkbox"/> Injection Clamp Luthi Model EM101		10/14/2019	10/14/2020
<input type="checkbox"/> Oscilloscope Scope: Tektronix MDO 4104		2/22/2020	2/22/2021
<input type="checkbox"/> EMC Transient Generator HVT TR 3000		2/22/2020	2/22/2021
<input type="checkbox"/> AC Power Source (Ametech, California Instruments)		2/22/2020	2/22/2021
<input type="checkbox"/> Field Intensity Meter: EFM-018		2/22/2020	2/22/2021
<input type="checkbox"/> ESD Simulator: MZ-15		2/22/2020	2/22/2021
<input type="checkbox"/> R.F. Power Amp ACS 230-50W		not required	
<input type="checkbox"/> R.F. Power Amp EIN Model: A301		not required	
<input type="checkbox"/> R.F. Power Amp A.R. Model: 10W 1010M7		not required	
<input type="checkbox"/> R.F. Power Amp A.R. Model: 50U1000		not required	
<input checked="" type="checkbox"/> Shielded Room		not required	

Annex C Rogers Qualifications

Scot D. Rogers, Engineer

Rogers Labs, Inc.

Mr. Rogers has approximately 35 years' experience in the field of electronics. Working experience includes six years working in the automated controls industry and 6 years working with the design, development and testing of radio communications and electronic equipment.

Positions Held:

Systems Engineer: A/C Controls Mfg. Co., Inc. 6 Years

Electrical Engineer: Rogers Consulting Labs, Inc. 5 Years

Electrical Engineer: Rogers Labs, Inc. Current

Educational Background:

Bachelor of Science Degree in Electrical Engineering from Kansas State University

Bachelor of Science Degree in Business Administration Kansas State University

Several Specialized Training courses and seminars pertaining to Microprocessors and Software programming

Annex D Laboratory Certificate of Accreditation

United States Department of Commerce
National Institute of Standards and Technology



Certificate of Accreditation to ISO/IEC 17025:2017

NVLAP LAB CODE: 200087-0

Rogers Labs, Inc.
Louisburg, KS

*is accredited by the National Voluntary Laboratory Accreditation Program for specific services,
listed on the Scope of Accreditation, for:*

Electromagnetic Compatibility & Telecommunications

*This laboratory is accredited in accordance with the recognized International Standard ISO/IEC 17025:2017.
This accreditation demonstrates technical competence for a defined scope and the operation of a laboratory quality
management system (refer to joint ISO-ILAC-IAF Communique dated January 2009).*

2020-02-25 through 2021-03-31
Effective Dates

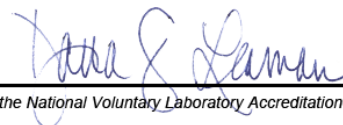

For the National Voluntary Laboratory Accreditation Program

Rogers Labs, Inc.
4405 West 259th Terrace
Louisburg, KS 66053
Phone/Fax: (913) 837-3214
Revision 1

Garmin International, Inc.
Model: AA4113
Test: 200922
Test to: CFR47 15C, RSS-Gen RSS-247
File: AA4113 DXX TstRpt 200922

SN's: 3341634221 / 3341634272
FCC ID: IPH-A4113
IC: 1792A-A4113
Date: November 18, 2020
Page 49 of 49