

Application For Grant of Certification

FOR

FOR

Model: AA2784
2402-2480 MHz
47CFR 15.249 and RSS-210
Low Power Transmitter
FCC ID: IPH-A2784
IC: 1792A-A2784

FOR

Garmin International, Inc.

1200 East 151st Street
Olathe, KS 66062

Test Report Number: 160127
IC Test Site Registration: 3041A-1

Authorized Signatory: *Scot D Rogers*
Scot D. Rogers

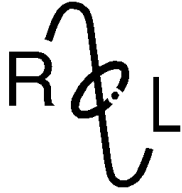

ROGERS LABS, INC.

4405 West 259th Terrace
Louisburg, KS 66053
Phone / Fax (913) 837-3214

Engineering Test Report For Grant of Certification Application

FOR

47 CFR, PART 15C - Intentional Radiators Paragraph 15.249 and
Industry Canada RSS-210 Issue 8, RSS-GEN Issue 4
License Exempt Intentional Radiator

For

Garmin International, Inc.

1200 East 151st Street
Olathe, KS 66062

Model: AA2784

Low Power Transmitter

Frequency Range 2402-2480 MHz
FCC ID#: IPH-A2784
IC: 1792A-A2784

Test Date: January 27, 2016

Certifying Engineer: *Scot D. Rogers*
Scot D. Rogers
Rogers Labs, Inc.
4405 West 259th Terrace
Louisburg, KS 66053
Telephone/Facsimile: (913) 837-3214

This report shall not be reproduced except in full, without the written approval of the laboratory.
This report must not be used by the client to claim product certification, approval, or endorsement by
NVLAP, NIST, or any agency of the Federal Government.

Rogers Labs, Inc.
4405 West 259th Terrace
Louisburg, KS 66053
Phone/Fax: (913) 837-3214
Revision 1

Garmin International, Inc.
Model: AA2784
Test #: 160127
Test to: 47CFR 15C, RSS-210
File: TstRpt AA2784 160127

SN: EUT1
FCC ID: IPH-A2784
IC: 1792A- A2784
Date: February 15, 2016
Page 2 of 30

Table Of Contents

TABLE OF CONTENTS.....	3
REVISIONS.....	4
FORWARD	5
OPINION / INTERPRETATION OF RESULTS	5
EQUIPMENT TESTED.....	5
Equipment Function	5
Equipment Configuration.....	6
APPLICATION FOR CERTIFICATION.....	7
APPLICABLE STANDARDS & TEST PROCEDURES	8
EQUIPMENT TESTING PROCEDURES	8
AC Line Conducted Emission Test Procedure	8
Radiated Emission Test Procedure.....	8
Diagram 1 Test arrangement for radiated emissions of tabletop equipment.....	9
Diagram 2 Test arrangement for radiated emissions tested on Open Area Test Site (OATS).....	10
TEST SITE LOCATIONS	10
LIST OF TEST EQUIPMENT	11
UNITS OF MEASUREMENTS	12
ENVIRONMENTAL CONDITIONS.....	12
INTENTIONAL RADIATORS.....	12
Antenna Requirements	12
Restricted Bands of Operation.....	12
Table 1 Radiated Emissions in Restricted Frequency Bands Data (Mode 1)	13
Table 2 Radiated Emissions in Restricted Frequency Bands Data (Mode 2)	14
Summary of Results for Radiated Emissions in Restricted Bands	14

General Radiated Emissions Procedure.....15

 Table 6 General Radiated Emissions Data 16

Summary of Results for General Radiated Emissions 16

Operation in the Band 2400 – 2483.5 MHz17

 Figure 1 Plot of Transmitter Emissions (Mode 1 Operation in 2402-2480 MHz) 18

 Figure 2 Plot of Transmitter Emissions (Mode 1 99% Occupied Bandwidth) 18

 Figure 3 Plot of Transmitter Emissions (Mode 1 Low Band Edge) 19

 Figure 4 Plot of Transmitter Emissions (Mode 1 High Band Edge)..... 19

 Figure 5 Plot of Transmitter Emissions (Mode 2 Operation in 2402-2480 MHz)20

 Figure 6 Plot of Transmitter Emissions (Mode 2 99% Occupied Bandwidth) 20

 Figure 7 Plot of Transmitter Emissions (Mode 2 Low Band Edge) 21

 Figure 8 Plot of Transmitter Emissions (Mode 2 High Band Edge)..... 21

Transmitter Emissions Data.....22

 Table 1 Transmitter Radiated Emissions (Mode 1) 22

 Table 2 Transmitter Radiated Emissions (Mode 2) 23

Summary of Results for Transmitter Radiated Emissions of Intentional Radiator24

STATEMENT OF MODIFICATIONS AND DEVIATIONS 24

ANNEX..... 25

Annex A Measurement Uncertainty Calculations.....26

Annex B Rogers Labs Test Equipment List.....27

Annex C Rogers Qualifications28

Annex D FCC Site Registration Letter29

Annex E Industry Canada Site Registration Letter30

Revisions

Revision 1 Issued February 15, 2016

Forward

The following information is submitted for consideration in obtaining Grant of Certification for low power intentional radiator per 47 CFR Paragraph 15.249 and Industry Canada RSS-210, low power digital device transmitter operations in the 2400 – 2483.5 MHz frequency band.

Name of Applicant: Garmin International, Inc.
1200 East 151st Street
Olathe, KS 66062

Model: AA2784

FCC ID: IPH-A2784 IC: 1792A-A2784

Operating power: 2402-2480 MHz Maximum Average power 93.9 dB μ V/m @ 3 meters (and peak 94.3 dB μ V/m @ 3 meters, 1,672.5 kHz (99% OBW)

Opinion / Interpretation of Results

Tests Performed	Margin (dB)	Results
Restricted Bands 47CFR 15.205, RSS-210 2.2	-14.2	Complies
AC Line Conducted 47CFR 15.207, RSS-GEN 8.8	N/A	Complies
Radiated Emissions 47CFR 15.209, RSS-GEN 8.9	-25.4	Complies
Harmonic Emissions per 47CFR 15.249, RSS-210 A2.9	-8.6	Complies

Equipment Tested

<u>Equipment</u>	<u>Model / PN</u>	<u>Serial Number</u>
EUT	AA2784	EUT1
EUT #2	AA2784	55714b

Test results in this report relate only to the items tested.

Equipment Function

The EUT is a portable digital device. The device incorporates sensors to log movement, includes a low power transmitter for communications with compliant equipment, and offers no other interface options as presented below in configuration diagrams. The low power transmitter provides operation capability in the 2402-2480 MHz frequency band. The design provides wireless communications in

one of two modes providing wireless interface capabilities with compatible equipment. The product operates from internal replaceable battery only and offers no provision for alternate power sources. The design utilizes internal fixed antenna system and offers no provision for antenna replacement or modification. Two samples were provided for testing, one representative of production design, and the other modified for testing purposes replacing integral antenna with RF connection port. The test samples were provided with test software enabling testing personnel ability to enable transmitter function on defined channels. The antenna modification offered testing facility ability to connect test equipment to the temporary antenna port for antenna port conducted emission testing. The EUT was arranged as described by the manufacturer emulating typical user configurations for testing purposes. The EUT offers no other interface connections than those in the configuration options as presented and described by the manufacturer. For testing purposes, the EUT received powered from new internal battery and configured to operate in available modes. As requested by the manufacturer and required by regulations, the equipment was tested for emissions compliance using the available configurations with the worst-case data presented. The test software was capable of enabling 100% transmission for testing purposes. The production product will not operate at high duty cycles. This report documents compliance testing and results for applicable product modes of operation. Test results in this report relate only to the products described in this report.

Equipment Configuration

1. AA2784 operating off internal Replaceable Internal Battery

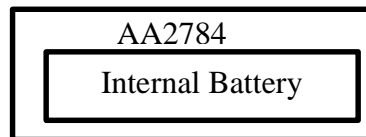

2. AA2784 transmitting data through wireless 2.4 GHz communication (see test procedure document) and powered by internal battery

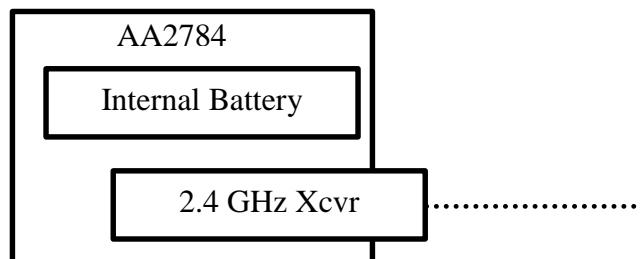

Application for Certification

- (1) Manufacturer: Garmin International, Inc.
1200 East 151st Street
Olathe, KS 66062
- (2) Identification: Model: AA2784
FCC ID: IPH-A2784 IC: 1792A-A2784
- (3) Instruction Book:
Refer to Exhibit for Instruction Manual.
- (4) Description of Circuit Functions:
Refer to Exhibit of Operational Description.
- (5) Block Diagram with Frequencies:
Refer to Exhibit of Operational Description.
- (6) Report of Measurements:
Report of measurements follows in this Report.
- (7) Photographs: Construction, Component Placement, etc.:
Refer to Exhibit for photographs of equipment.
- (8) List of Peripheral Equipment Necessary for operation. The equipment operates from direct current power only as documented in this report. The EUT offers no other connection ports than those presented in this filing.
- (9) Transition Provisions of CFR47 15.37 are not requested.
- (10) Not Applicable. The unit is not a scanning receiver.
- (11) Not Applicable. The EUT does not operate in the 59 – 64 GHz frequency band.
- (12) The equipment is not software defined and this section is not applicable.

Applicable Standards & Test Procedures

In accordance with the Federal Communications Code of Federal Regulations, dated October 1, 2015: Part 2, Subpart J, Paragraphs 2.907, 2.911, 2.913, 2.925, 2.926, 2.1031 through 2.1057, and applicable parts of paragraph 15, Part 15C Paragraph 15.249, and Industry Canada RSS-210 issue 8 operation in the 2400 – 2483.5 MHz Frequency band. Test procedures used are the established Methods of Measurement of Radio-Noise Emissions as described in ANSI C63.10-2013.

Equipment Testing Procedures

AC Line Conducted Emission Test Procedure

Not applicable as this equipment operates solely from direct current power and offers no provision for connection to utility AC power sources.

Radiated Emission Test Procedure

The EUT was placed on a rotating 0.9 x 1.2-meter platform, elevated as required above the ground plane at a distance of 3 meters from the FSM antenna. Radiated emissions testing was performed as required in the regulations and specified in ANSI C63.10-2013. EMI energy was maximized by equipment placement permitting orientation in three orthogonal axes, raising and lowering the FSM antenna, changing the antenna polarization, and by rotating the turntable. Each emission was maximized before data was taken and recorded. The frequency spectrum from 9 kHz to 25,000 MHz was searched for emissions during preliminary investigation. Refer to diagrams one and two showing typical test setup and photographs for equipment arrangement in the test setup exhibits for specific EUT placement during testing.

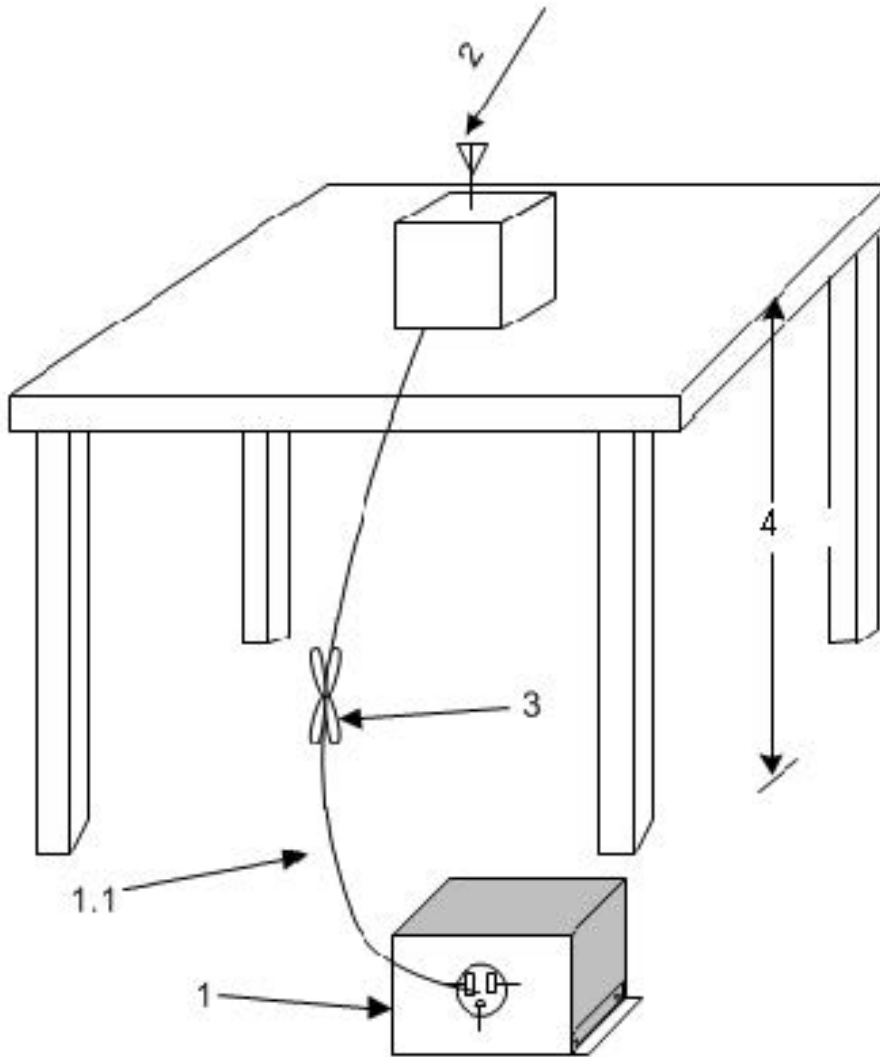

1—A LISN is optional for radiated measurements between 30 MHz and 1000 MHz but not allowed for measurements below 30 MHz and above 1000 MHz (see 6.3.1). If used, then connect EUT to one LISN. Unused LISN measuring port connectors shall be terminated in 50 Ω loads. The LISN may be placed on top of, or immediately beneath, the reference ground plane (see 6.2.2 and 6.2.3.2).

1.1—LISN spaced at least 80 cm from the nearest part of the EUT chassis.

2—Antenna can be integral or detachable, depending on the EUT (see 6.3.1).

3—Interconnecting cables that hang closer than 40 cm to the ground plane shall be folded back and forth in the center forming a bundle 30 cm to 40 cm long (see 6.3.1).

4—For emission measurements at or below 1 GHz, the table height shall be 80 cm. For emission measurements above 1 GHz, the table height shall be 1.5 m for measurements, except as otherwise specified (see 6.3.1 and 6.6.3.1).

Diagram 1 Test arrangement for radiated emissions of tabletop equipment

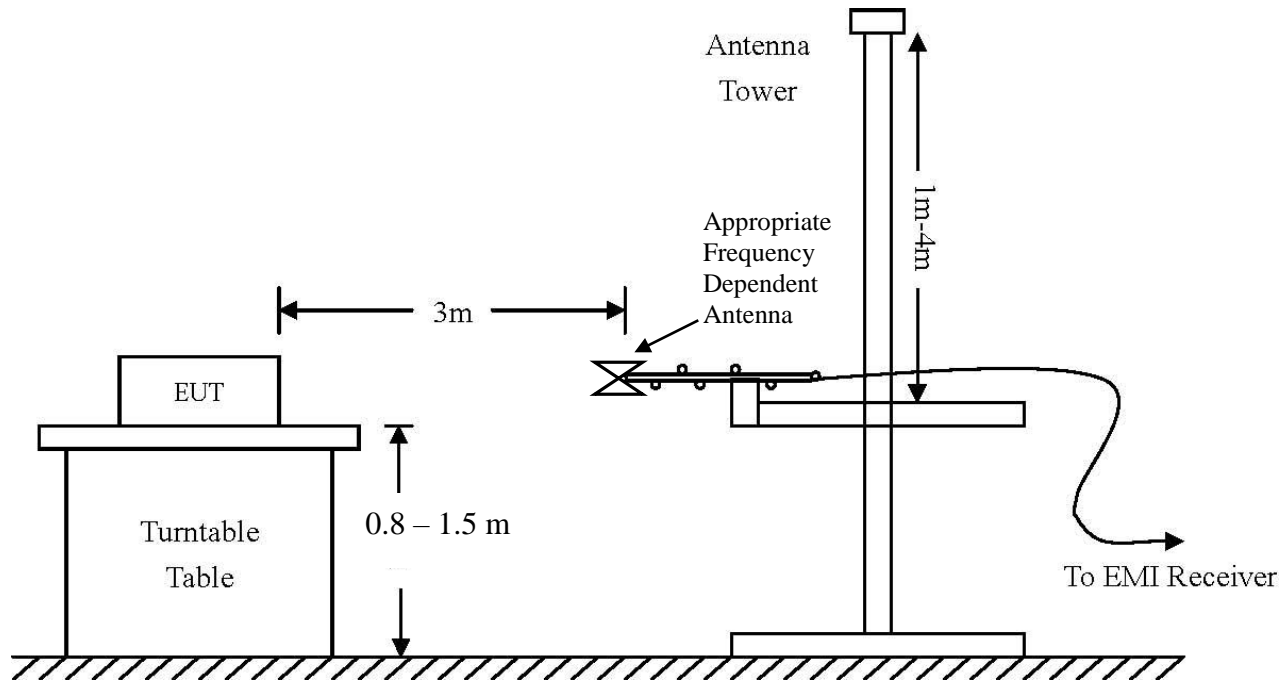

Frequency: 9 kHz-30 MHz	Frequency: 30 MHz- 1 GHZ	Frequency: Above 1 GHz
Loop Antenna	Broadband Biconilog	Horn
RBW = 9 kHz	RBW = 120 kHz	RBW = 1 MHz
VBW = 30 kHz	VBW = 120 kHz	VBW = 1 MHz
Sweep time = Auto	Sweep time = Auto	Sweep time = Auto
Detector = PK, QP	Detector = PK, QP	Detector = PK, AV
Antenna Height 1m	Antenna Height 1-4m	Antenna Height 1-4m

Diagram 2 Test arrangement for radiated emissions tested on Open Area Test Site (OATS)

Test Site Locations

Conducted EMI The AC power line conducted emissions testing performed in a shielded screen room located at Rogers Labs, Inc., 4405 W. 259th Terrace, Louisburg, KS

Radiated EMI The radiated emissions tests were performed at the 3 meters, Open Area Test Site (OATS) located at Rogers Labs, Inc., 4405 W. 259th Terrace, Louisburg, KS

Site Registration Refer to Annex for Site Registration Letters

NVLAP Accreditation Lab code 200087-0

Rogers Labs, Inc.
 4405 West 259th Terrace
 Louisburg, KS 66053
 Phone/Fax: (913) 837-3214
 Revision 1

Garmin International, Inc.
 Model: AA2784
 Test #: 160127
 Test to: 47CFR 15C, RSS-210
 File: TstRpt AA2784 160127

SN: EUT1
 FCC ID: IPH-A2784
 IC: 1792A- A2784
 Date: February 15, 2016
 Page 10 of 30

List of Test Equipment

A Rohde and Schwarz ESU40 and/or Hewlett Packard 8591EM was used as the measuring device for the emissions testing of frequencies below 1 GHz. A Rohde and Schwarz ESU40 and/or Hewlett Packard 8562A Spectrum Analyzer was used as the measuring device for testing the emissions at frequencies above 1 GHz. The analyzer settings used are described in the following table. Refer to the appendix for a complete list of test equipment.

AC Line Conducted Emissions (0.150 -30 MHz)		
RBW	AVG. BW	Detector Function
9 kHz	30 kHz	Peak / Quasi Peak
Emissions (30-1000 MHz)		
RBW	AVG. BW	Detector Function
120 kHz	300 kHz	Peak / Quasi Peak
Emissions (Above 1000 MHz)		
RBW	Video BW	Detector Function
100 kHz	100 kHz	Peak
1 MHz	1 MHz	Peak / Average

<u>Equipment</u>	<u>Manufacturer</u>	<u>Model (SN)</u>	<u>Band</u>	<u>Cal Date</u>	<u>Due</u>
<input type="checkbox"/> LISN	FCC	FCC-LISN-50-2-10(1PA) (160611)	.15-30MHz	6/15	5/16
<input checked="" type="checkbox"/> Cable	Time Microwave	750HF290-750 (L10M)	9kHz-40 GHz	10/15	10/16
<input type="checkbox"/> Cable	Belden	RG-58 (L1-CAT3-11509)	9kHz-30 MHz	10/15	10/16
<input type="checkbox"/> Cable	Belden	RG-58 (L2-CAT3-11509)	9kHz-30 MHz	10/15	10/16
<input type="checkbox"/> Antenna	ARA	BCD-235-B (169)	20-350MHz	10/15	10/16
<input type="checkbox"/> Antenna	EMCO	3147 (40582)	200-1000MHz	10/15	10/16
<input checked="" type="checkbox"/> Antenna	ETS-Lindgren	3117 (200389)	1-18 GHz	5/15	5/17
<input type="checkbox"/> Antenna	Com Power	AH-118 (10110)	1-18 GHz	10/15	10/16
<input checked="" type="checkbox"/> Antenna	Com Power	AH-840 (101046)	18-40 GHz	5/15	5/17
<input checked="" type="checkbox"/> Antenna	EMCO	6509 (9502-1374)	.001-30 MHz	10/15	10/16
<input checked="" type="checkbox"/> Antenna	Sunol	JB-6 (A100709)	30-1000 MHz	10/15	10/16
<input type="checkbox"/> Antenna	EMCO	3143 (9607-1277)	20-1200 MHz	5/15	5/16
<input type="checkbox"/> Analyzer	HP	8591EM (3628A00871)	9kHz-1.8GHz	5/15	5/16
<input type="checkbox"/> Analyzer	HP	8562A (3051A05950)	9kHz-110GHz	5/15	5/16
<input type="checkbox"/> Analyzer	HP External Mixers	11571, 11970	25GHz-110GHz	5/15	5/16
<input checked="" type="checkbox"/> Analyzer	Rohde & Schwarz	ESU40 (100108)	20Hz-40GHz	5/15	5/16
<input checked="" type="checkbox"/> Amplifier	Com-Power	PA-010 (171003)	100Hz-30MHz	10/15	10/16
<input checked="" type="checkbox"/> Amplifier	Com-Power	CPPA-102 (01254)	1-1000 MHz	10/15	10/16
<input checked="" type="checkbox"/> Amplifier	Com-Power	PAM-118A (551014)	0.5-18 GHz	10/15	10/16

Rogers Labs, Inc.
 4405 West 259th Terrace
 Louisburg, KS 66053
 Phone/Fax: (913) 837-3214
 Revision 1

Garmin International, Inc.
 Model: AA2784
 Test #: 160127
 Test to: 47CFR 15C, RSS-210
 File: TstRpt AA2784 160127

SN: EUT1
 FCC ID: IPH-A2784
 IC: 1792A- A2784
 Date: February 15, 2016
 Page 11 of 30

Units of Measurements

Conducted EMI Data is in dB μ V; dB referenced to one microvolt

Radiated EMI Data is in dB μ V/m; dB/m referenced to one microvolt per meter

Sample Calculation:

RFS = Radiated Field Strength, FSM = Field Strength Measured

A.F. = Receive antenna factor, Gain = amplification gains and/or cable losses

RFS (dB μ V/m @ 3m) = FSM (dB μ V) + A.F. (dB) - Gain (dB)

Environmental Conditions

Ambient Temperature	22.4° C
Relative Humidity	40%
Atmospheric Pressure	997.0 mb

Intentional Radiators

The following information is submitted in support demonstration of compliance with the requirements of 47CFR, Subpart C, paragraph 15.249, Industry Canada RSS-210 Issue 8 and RSS-GEN Issue 4.

Antenna Requirements

The EUT incorporates integral antenna system and offers no provision for connection to alternate antenna system. The antenna connection point complies with the unique antenna connection requirements. The unique antenna connection requirements are fulfilled. There are no deviations or exceptions to the specification.

Restricted Bands of Operation

Spurious emissions falling in the restricted frequency bands of operation were measured at the OATS. The EUT utilizes frequency, determining circuitry, which generates harmonics falling in the restricted bands. Emissions were investigated at the OATS, using appropriate antennas or pyramidal horns, amplification stages, and a spectrum analyzer. Peak and average amplitudes of frequencies above 1000 MHz were compared to the required limits with worst-case data presented below. Test procedures of ANSI C63.10-2013 were used during testing. No other significant emission was observed which fell into the restricted bands of operation. Computed emission values take into account the received radiated field strength, receive antenna correction factor, amplifier gain stage, and test system cable losses.

Rogers Labs, Inc.
4405 West 259th Terrace
Louisburg, KS 66053
Phone/Fax: (913) 837-3214
Revision 1

Garmin International, Inc.
Model: AA2784
Test #: 160127
Test to: 47CFR 15C, RSS-210
File: TstRpt AA2784 160127

SN: EUT1
FCC ID: IPH-A2784
IC: 1792A- A2784
Date: February 15, 2016
Page 12 of 30

Table 1 Radiated Emissions in Restricted Frequency Bands Data (Mode 1)

Frequency in MHz	Horizontal Peak (dBµV/m)	Horizontal Quasi-Peak (dBµV/m)	Horizontal Average (dBµV/m)	Vertical Peak (dBµV/m)	Vertical Quasi-Peak (dBµV/m)	Vertical Average (dBµV/m)	Limit @ 3m (dBµV/m)
2390.0	42.9	N/A	26.9	49.2	N/A	27.1	54.0
2483.5	42.2	N/A	27.1	41.1	N/A	28.6	54.0
4804.0	44.0	N/A	31.1	44.2	N/A	31.1	54.0
4882.0	44.1	N/A	32.0	47.6	N/A	39.8	54.0
4960.0	44.3	N/A	30.6	44.6	N/A	32.4	54.0
7206.0	46.2	N/A	33.1	45.8	N/A	33.3	54.0
7323.0	46.6	N/A	33.8	47.0	N/A	34.5	54.0
7440.0	45.8	N/A	33.1	46.6	N/A	33.8	54.0
12010.0	50.7	N/A	38.1	51.8	N/A	38.4	54.0
12205.0	52.1	N/A	38.9	51.6	N/A	38.7	54.0
12400.0	52.4	N/A	39.2	51.2	N/A	38.8	54.0

Other emissions present had amplitudes at least 20 dB below the limit. Peak and Quasi-Peak amplitude emissions are recorded for frequency range below 1000 MHz. Peak and Average amplitude emissions are recorded for frequency range above 1000 MHz.

Table 2 Radiated Emissions in Restricted Frequency Bands Data (Mode 2)

Frequency in MHz	Horizontal Peak (dBµV/m)	Horizontal Quasi-Peak (dBµV/m)	Horizontal Average (dBµV/m)	Vertical Peak (dBµV/m)	Vertical Quasi-Peak (dBµV/m)	Vertical Average (dBµV/m)	Limit @ 3m (dBµV/m)
2390.0	40.3	N/A	27.0	40.4	N/A	27.2	54.0
2483.5	40.7	N/A	28.0	41.1	N/A	28.0	54.0
4804.0	44.6	N/A	31.3	45.3	N/A	31.5	54.0
4884.0	44.1	N/A	31.3	44.5	N/A	31.3	54.0
4960.0	45.1	N/A	31.4	44.4	N/A	31.4	54.0
7206.0	44.3	N/A	31.2	44.5	N/A	31.3	54.0
7326.0	45.6	N/A	33.0	45.7	N/A	32.8	54.0
7440.0	45.6	N/A	33.1	46.0	N/A	33.0	54.0
12010.0	51.6	N/A	38.5	51.4	N/A	38.7	54.0
12210.0	51.6	N/A	38.6	52.1	N/A	38.7	54.0
12400.0	51.1	N/A	38.3	51.5	N/A	38.6	54.0

Other emissions present had amplitudes at least 20 dB below the limit. Peak and Quasi-Peak amplitude emissions are recorded for frequency range below 1000 MHz. Peak and Average amplitude emissions are recorded for frequency range above 1000 MHz.

Summary of Results for Radiated Emissions in Restricted Bands

The EUT demonstrated compliance with the radiated emissions requirements of 47CFR Part 15C and RSS-210 Intentional Radiator requirements. The EUT demonstrated a worst-case minimum margin of -14.2 dB below the emissions requirements in restricted frequency bands. Peak, Quasi-peak, and average amplitudes were checked for compliance with the regulations. Worst-case emissions are reported with other emissions found in the restricted frequency bands at least 20 dB below the requirements.

General Radiated Emissions Procedure

The EUT was arranged in a typical equipment configuration and operated through all available modes during testing. Preliminary testing was performed in a screen room with the EUT positioned 1 meter from the FSM. Radiated emissions measurements were performed to identify the frequencies, which produced the highest emissions. Each radiated emission was then maximized at the OATS location before final radiated emissions measurements were performed. Final data was taken with the EUT located at the OATS at a distance of 3 meters between the EUT and the receiving antenna. The frequency spectrum from 9 kHz to 25,000 MHz was searched for general radiated emissions. Measured emission levels were maximized by EUT placement on the table, rotating the turntable through 360 degrees, varying the antenna height between 1 and 4 meters above the ground plane and changing antenna position between horizontal and vertical polarization. Antennas used were Loop from 9 kHz to 30 MHz, Broadband Biconical from 30 to 200 MHz, Biconilog from 30 to 1000 MHz, Log Periodic from 200 MHz to 1 GHz and or double Ridge or pyramidal horns and mixers above 1 GHz, notch filters and appropriate amplifiers and external mixers were utilized.

Table 6 General Radiated Emissions Data

Frequency in MHz	Horizontal Peak (dB μ V/m)	Horizontal Quasi-Peak (dB μ V/m)	Horizontal Average (dB μ V/m)	Vertical Peak (dB μ V/m)	Vertical Quasi-Peak (dB μ V/m)	Vertical Average (dB μ V/m)	Limit @ 3m (dB μ V/m)
Mode 1							
2390.0	42.9	N/A	26.9	49.2	N/A	27.1	54.0
2483.5	42.2	N/A	27.1	41.1	N/A	28.6	54.0
Mode 2							
2390.0	40.3	N/A	27.0	40.4	N/A	27.2	54.0
2483.5	40.7	N/A	28.0	41.1	N/A	28.0	54.0

Other emissions present had amplitudes at least 20 dB below the limit. Peak and Quasi-Peak amplitude emissions are recorded for frequency range below 1000 MHz. Peak and Average amplitude emissions are recorded for frequency range above 1000 MHz.

Summary of Results for General Radiated Emissions

The EUT demonstrated compliance with the radiated emissions requirements of CFR47 Part 15C paragraph 15.209 and RSS-210 Intentional Radiators. The EUT demonstrated a minimum margin of -25.4 dB below the requirements. Other emissions were present with amplitudes at least 20 dB below the Limits.

Operation in the Band 2400 – 2483.5 MHz

The transmitter output power; harmonic and general emissions were measured on an open area test site @ 3 meters. The EUT was placed on a turntable elevated as required above the ground plane and at a distance of 3 meters from the FSM antenna. The table permitted orientation of the EUT in each of three orthogonal axis positions during testing. The peak and quasi-peak amplitude of frequencies below 1000 MHz were measured using a spectrum analyzer. The peak and average amplitude of frequencies above 1000 MHz were measured using a spectrum analyzer. The amplitude of each emission was then recorded from the analyzer display. Emissions radiated outside of the specified bands, except for harmonics, shall be attenuated by at least 50 dB below the level of the fundamental or to the general radiated emission limits, whichever is the lesser attenuation. Plots were taken of transmitter performance for reference in this and other documentation. Refer to figures one through eight showing plots taken of the 2402-2480 MHz performance displaying compliance with the specifications. The amplitude of each radiated emission was measured on the OATS at a distance of 3 meters from the FSM antenna (testing was performed on sample 1 representative of production with integral antenna). The amplitude of each radiated emission was maximized by equipment placement (orientation in three orthogonal axis), raising, and lowering the FSM antenna, changing the antenna polarization, and by rotating the turntable by varying the FSM antenna height, polarization, and by rotating the turntable. A Loop antenna was used for measuring emissions from 0.009 to 30 MHz, Biconilog Antenna for 30 to 1000 MHz, Double-Ridge, and/or Pyramidal Horn Antennas from 1 GHz to 25 GHz. Emissions were measured in dB μ V/m @ 3 meters.

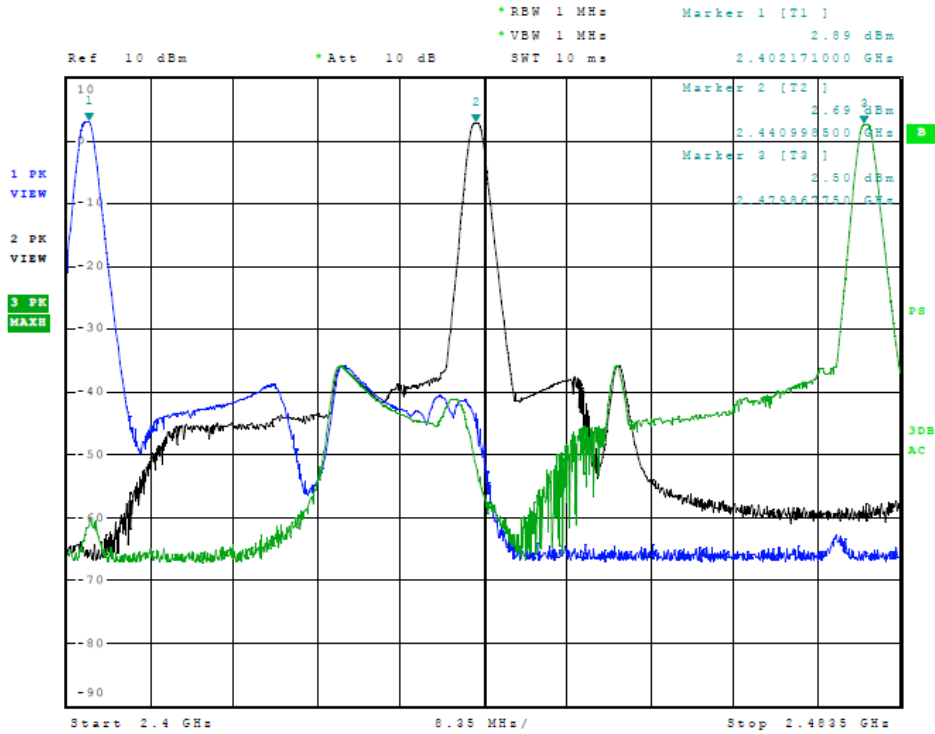

Figure 1 Plot of Transmitter Emissions (Mode 1 Operation in 2402-2480 MHz)

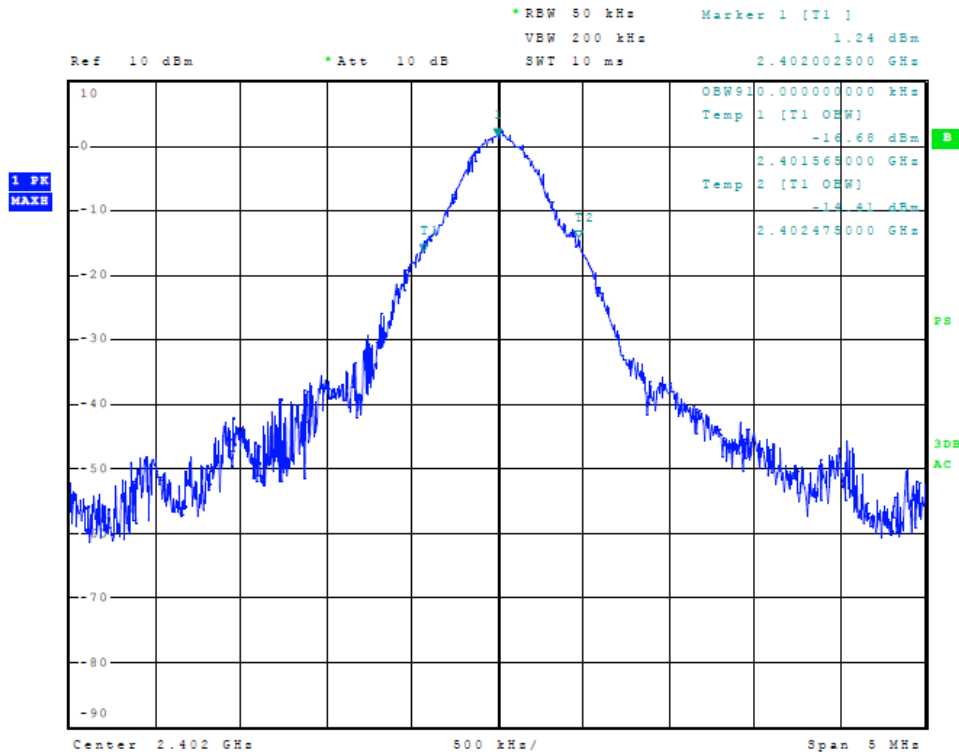

Figure 2 Plot of Transmitter Emissions (Mode 1 99% Occupied Bandwidth)

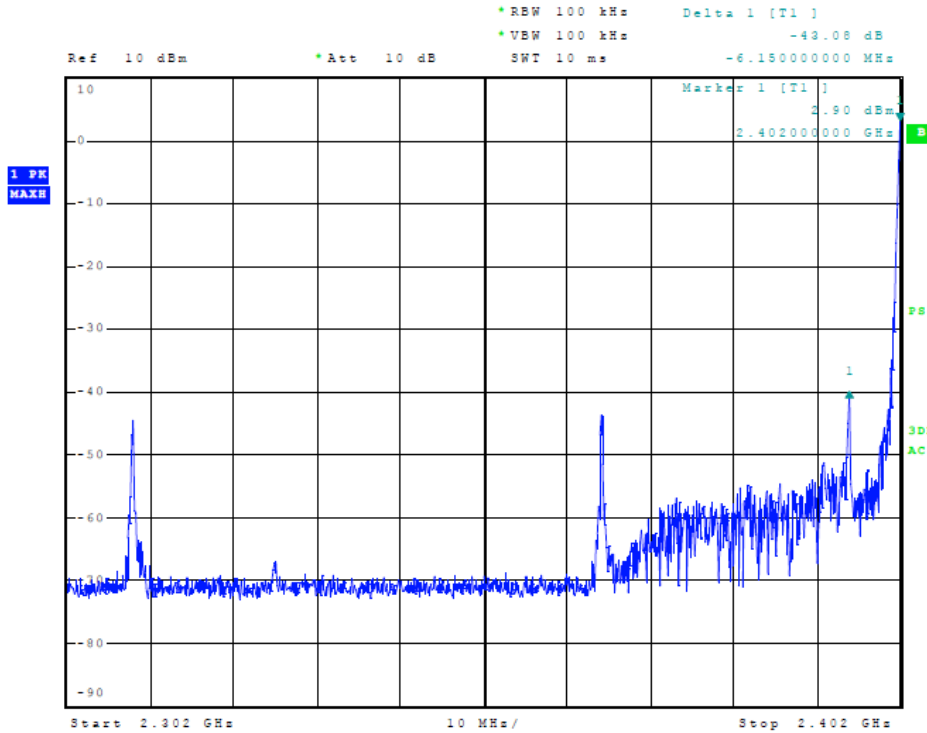

Figure 3 Plot of Transmitter Emissions (Mode 1 Low Band Edge)

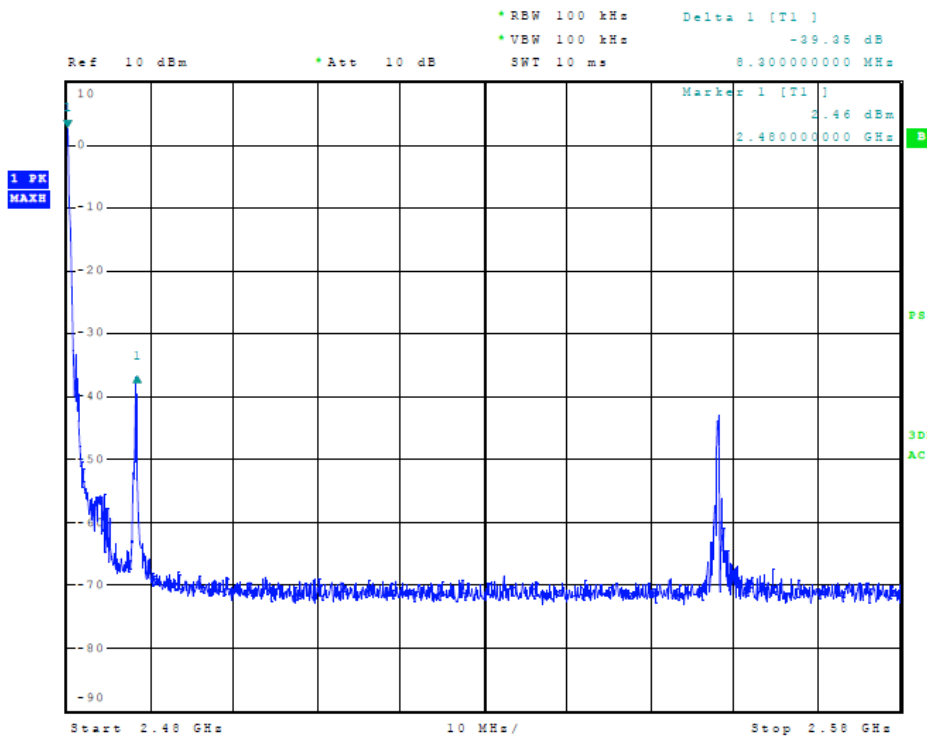

Figure 4 Plot of Transmitter Emissions (Mode 1 High Band Edge)

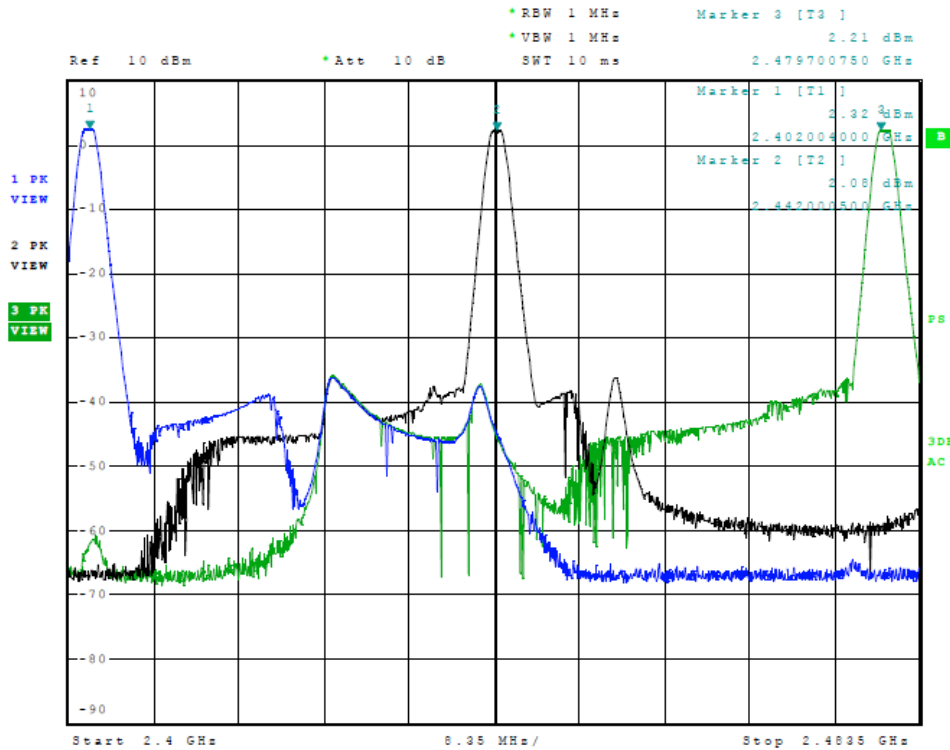

Figure 5 Plot of Transmitter Emissions (Mode 2 Operation in 2402-2480 MHz)

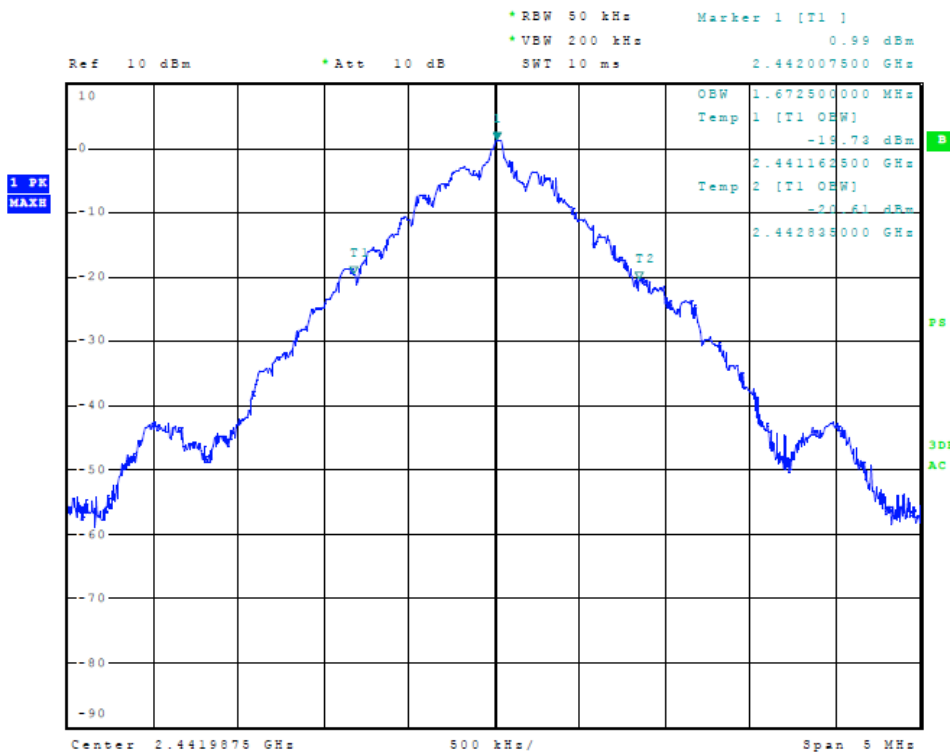

Figure 6 Plot of Transmitter Emissions (Mode 2 99% Occupied Bandwidth)

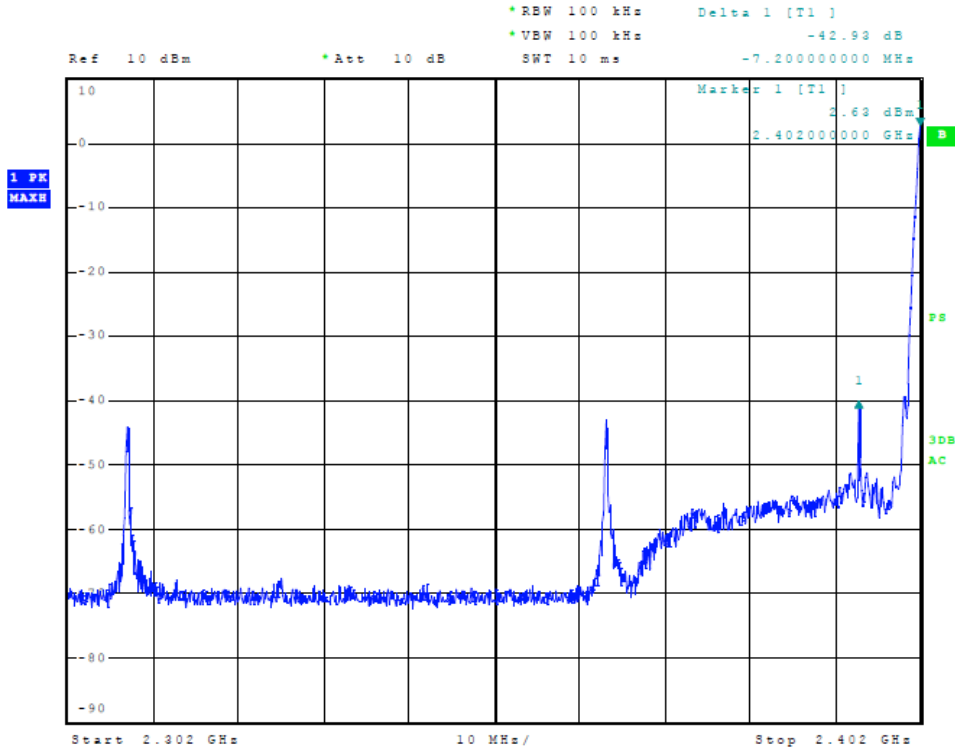

Figure 7 Plot of Transmitter Emissions (Mode 2 Low Band Edge)

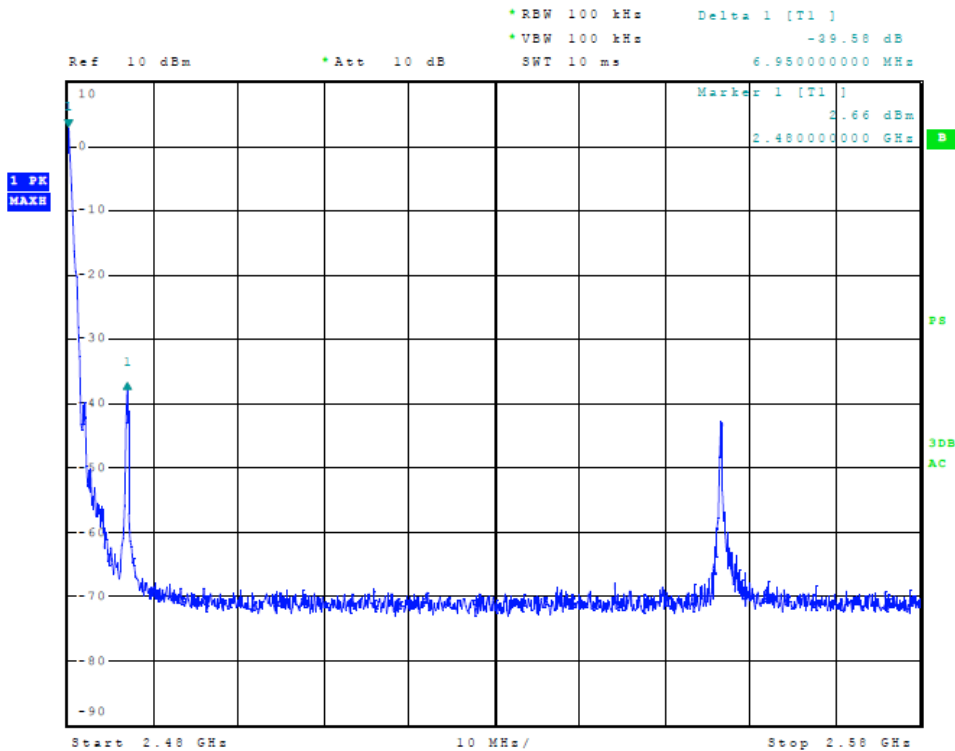

Figure 8 Plot of Transmitter Emissions (Mode 2 High Band Edge)

Transmitter Emissions Data

Table 1 Transmitter Radiated Emissions (Mode 1)

Frequency in MHz	Horizontal Peak (dBμV/m)	Horizontal Quasi-Peak (dBμV/m)	Horizontal Average (dBμV/m)	Vertical Peak (dBμV/m)	Vertical Quasi-Peak (dBμV/m)	Vertical Average (dBμV/m)	Limit @ 3m (dBμV/m)
2402.0	87.9	N/A	85.5	92.1	N/A	91.0	94.0
4804.0	44.0	N/A	31.1	44.2	N/A	31.1	54.0
7206.0	46.2	N/A	33.1	45.8	N/A	33.3	54.0
9608.0	47.0	N/A	34.6	47.4	N/A	34.7	54.0
12010.0	50.7	N/A	38.1	51.8	N/A	38.4	54.0
14412.0	53.9	N/A	40.5	53.1	N/A	40.5	54.0
16814.0	58.2	N/A	45.2	58.9	N/A	45.3	54.0
2441.0	87.2	N/A	85.2	92.1	N/A	90.7	94.0
4882.0	44.1	N/A	32.0	47.6	N/A	39.8	54.0
7323.0	46.6	N/A	33.8	47.0	N/A	34.5	54.0
9764.0	47.3	N/A	34.1	46.6	N/A	34.0	54.0
12205.0	52.1	N/A	38.9	51.6	N/A	38.7	54.0
14646.0	53.6	N/A	40.8	53.5	N/A	40.5	54.0
17087.0	56.6	N/A	43.5	56.8	N/A	43.6	54.0
2480.0	86.6	N/A	85.2	91.7	N/A	90.5	94.0
4960.0	44.3	N/A	30.6	44.6	N/A	32.4	54.0
7440.0	45.8	N/A	33.1	46.6	N/A	33.8	54.0
9920.0	47.0	N/A	34.0	46.3	N/A	33.9	54.0
12400.0	52.4	N/A	39.2	51.2	N/A	38.8	54.0
14880.0	53.3	N/A	40.4	53.3	N/A	40.3	54.0
17360.0	56.8	N/A	44.2	57.2	N/A	44.2	54.0

Other emissions present had amplitudes at least 20 dB below the limit. Peak and Quasi-Peak amplitude emissions are recorded for frequency range below 1000 MHz. Peak and Average amplitude emissions are recorded for frequency range above 1000 MHz.

Table 2 Transmitter Radiated Emissions (Mode 2)

Frequency in MHz	Horizontal Peak (dBµV/m)	Horizontal Quasi-Peak (dBµV/m)	Horizontal Average (dBµV/m)	Vertical Peak (dBµV/m)	Vertical Quasi-Peak (dBµV/m)	Vertical Average (dBµV/m)	Limit @ 3m (dBµV/m)
2402.0	94.3	N/A	93.9	93.0	N/A	92.1	94.0
4804.0	44.6	N/A	31.3	45.3	N/A	31.5	54.0
7206.0	44.3	N/A	31.2	44.5	N/A	31.3	54.0
9608.0	47.8	N/A	34.5	48.3	N/A	34.6	54.0
12010.0	51.6	N/A	38.5	51.4	N/A	38.7	54.0
14412.0	53.4	N/A	40.4	53.6	N/A	40.4	54.0
16814.0	58.8	N/A	45.2	59.4	N/A	45.4	54.0
2442.0	91.2	N/A	90.4	91.6	N/A	90.6	94.0
4884.0	44.1	N/A	31.3	44.5	N/A	31.3	54.0
7326.0	45.6	N/A	33.0	45.7	N/A	32.8	54.0
9768.0	47.1	N/A	34.6	47.4	N/A	34.6	54.0
12210.0	51.6	N/A	38.6	52.1	N/A	38.7	54.0
14652.0	53.4	N/A	40.6	54.6	N/A	40.9	54.0
17094.0	55.8	N/A	43.1	55.8	N/A	43.1	54.0
2480.0	91.4	N/A	90.6	91.1	N/A	90.2	94.0
4960.0	45.1	N/A	31.4	44.4	N/A	31.4	54.0
7440.0	45.6	N/A	33.1	46.0	N/A	33.0	54.0
9920.0	46.7	N/A	34.2	47.4	N/A	34.3	54.0
12400.0	51.1	N/A	38.3	51.5	N/A	38.6	54.0
14880.0	54.5	N/A	41.4	54.4	N/A	41.5	54.0
17360.0	56.9	N/A	44.1	56.5	N/A	44.1	54.0

Other emissions present had amplitudes at least 20 dB below the limit. Peak and Quasi-Peak amplitude emissions are recorded for frequency range below 1000 MHz. Peak and Average amplitude emissions are recorded for frequency range above 1000 MHz.

Summary of Results for Transmitter Radiated Emissions of Intentional Radiator

The EUT demonstrated compliance with the radiated emissions requirements of FCC 47 CFR Part 15.249, Industry Canada RSS-210, RSS-GEN, and other applicable Intentional Radiator regulations. The EUT worst-case test sample configuration demonstrated minimum average margin of -0.1 dB below the average emission limit. The EUT worst-case configuration demonstrated minimum radiated harmonic emission margin of -8.6 dB below the limits. No other radiated emissions were found in the restricted bands less than 20 dB below limits than those recorded in this report. Other emissions were present with amplitudes at least 20 dB below the limits.

Statement of Modifications and Deviations

No modifications to the EUT were required for the equipment to demonstrate compliance with the CFR47 Part 15C , Industry Canada RSS-210, and RSS-GEN emission requirements. There were no deviations to the specifications.

Annex

- Annex A Measurement Uncertainty Calculations
- Annex B Rogers Labs Test Equipment List
- Annex C Rogers Qualifications
- Annex D FCC Site Registration Letter
- Annex E Industry Canada Site Registration Letter

Annex A Measurement Uncertainty Calculations

Measurement uncertainty calculations were made for the laboratory. Result of measurement uncertainty calculations are recorded below for AC line conducted and radiated emission measurements.

Measurement Uncertainty	U _(E)	U _(lab)
3 Meter Horizontal 30-200 MHz Measurements	2.08	4.16
3 Meter Vertical 30-200 MHz Measurements	2.16	4.33
3 Meter Vertical Measurements 200-1000 MHz	2.99	5.97
10 Meter Horizontal Measurements 30-200 MHz	2.07	4.15
10 Meter Vertical Measurements 30-200 MHz	2.06	4.13
10 Meter Horizontal Measurements 200-1000 MHz	2.32	4.64
10 Meter Vertical Measurements 200-1000 MHz	2.33	4.66
3 Meter Measurements 1-6 GHz	2.57	5.14
3 Meter Measurements 6-18 GHz	2.58	5.16
AC Line Conducted	1.72	3.43

Annex B Rogers Labs Test Equipment List

List of Test Equipment	Calibration	Date	Due
Spectrum Analyzer: Rohde & Schwarz ESU40		5/15	5/16
Spectrum Analyzer: HP 8562A, HP Adapters: 11518, 11519, and 11520		5/15	5/16
Mixers: 11517A, 11970A, 11970K, 11970U, 11970V, 11970W			
Spectrum Analyzer: HP 8591EM		5/15	5/16
Antenna: EMCO Biconilog Model: 3143		5/15	5/16
Antenna: Sunol Biconilog Model: JB6		10/15	10/16
Antenna: EMCO Log Periodic Model: 3147		10/15	10/16
Antenna: Com Power Model: AH-118		10/15	10/16
Antenna: Com Power Model: AH-840		5/15	5/17
Antenna: Antenna Research Biconical Model: BCD 235		10/15	10/16
Antenna: EMCO 6509		10/15	10/16
LISN: Compliance Design Model: FCC-LISN-2.Mod.cd, 50 µHy/50 ohm/0.1 µf		10/15	10/16
R.F. Preamp CPPA-102		10/15	10/16
Attenuator: HP Model: HP11509A		10/15	10/16
Attenuator: Mini Circuits Model: CAT-3		10/15	10/16
Attenuator: Mini Circuits Model: CAT-3		10/15	10/16
Cable: Belden RG-58 (L1)		10/15	10/16
Cable: Belden RG-58 (L2)		10/15	10/16
Cable: Belden 8268 (L3)		10/15	10/16
Cable: Time Microwave: 4M-750HF290-750		10/15	10/16
Cable: Time Microwave: 10M-750HF290-750		10/15	10/16
Frequency Counter: Leader LDC825		2/15	2/16
Oscilloscope Scope: Tektronix 2230		2/15	2/16
Wattmeter: Bird 43 with Load Bird 8085		2/15	2/16
Power Supplies: Sorensen SRL 20-25, SRL 40-25, DCR 150, DCR 140		2/15	2/16
R.F. Generators: HP 606A, HP 8614A, HP 8640B		2/15	2/16
R.F. Power Amp 65W Model: 470-A-1010		2/15	2/16
R.F. Power Amp 50W M185- 10-501		2/15	2/16
R.F. Power Amp A.R. Model: 10W 1010M7		2/15	2/16
R.F. Power Amp EIN Model: A301		2/15	2/16
LISN: Compliance Eng. Model 240/20		2/15	2/16
LISN: Fischer Custom Communications Model: FCC-LISN-50-16-2-08		2/15	2/16
Antenna: EMCO Dipole Set 3121C		2/15	2/16
Antenna: C.D. B-101		2/15	2/16
Antenna: Solar 9229-1 & 9230-1		2/15	2/16
Audio Oscillator: H.P. 201CD		2/15	2/16
ELGAR Model: 1751		2/15	2/16
ELGAR Model: TG 704A-3D		2/15	2/16
ESD Test Set 2010i		2/15	2/16
Fast Transient Burst Generator Model: EFT/B-101		2/15	2/16
Field Intensity Meter: EFM-018		2/15	2/16
KEYTEK Ecat Surge Generator		2/15	2/16
Shielded Room 5 M x 3 M x 3.0 M			

Annex C Rogers Qualifications

Scot D. Rogers, Engineer

Rogers Labs, Inc.

Mr. Rogers has approximately 17 years' experience in the field of electronics. Engineering experience includes six years in the automated controls industry and remaining years working with the design, development and testing of radio communications and electronic equipment.

Positions Held

Systems Engineer: A/C Controls Mfg. Co., Inc. 6 Years

Electrical Engineer: Rogers Consulting Labs, Inc. 5 Years

Electrical Engineer: Rogers Labs, Inc. Current

Educational Background

- 1) Bachelor of Science Degree in Electrical Engineering from Kansas State University.
- 2) Bachelor of Science Degree in Business Administration Kansas State University.
- 3) Several Specialized Training courses and seminars pertaining to Microprocessors and Software programming.

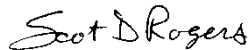

Scot D. Rogers

Annex D FCC Site Registration Letter

FEDERAL COMMUNICATIONS COMMISSION

**Laboratory Division
7435 Oakland Mills Road
Columbia, MD 21046**

April 16, 2015

Registration Number: 90910

Rogers Labs, Inc.
4405 West 259th Terrace
Louisburg, KS 66053

Attention: Scot Rogers,

Re: Measurement facility located at Louisburg
3 & 10 meter site
Date of Renewal: April 16, 2015

Dear Sir or Madam:

Your request for renewal of the registration of the subject measurement facility has been received. The information submitted has been placed in your file and the registration has been renewed. The name of your organization will remain on the list of facilities whose measurement data will be accepted in conjunction with applications for Certification under Parts 15 or 18 of the Commission's Rules. Please note that the file must be updated for any changes made to the facility and the registration must be renewed at least every three years.

Measurement facilities that have indicated that they are available to the public to perform measurement services on a fee basis may be found on the FCC website www.fcc.gov under E-Filing, OET Equipment Authorization Electronic Filing, Test Firms.

Sincerely,

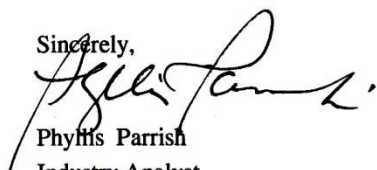

Phyllis Parrish
Industry Analyst

Rogers Labs, Inc.
4405 West 259th Terrace
Louisburg, KS 66053
Phone/Fax: (913) 837-3214
Revision 1

Garmin International, Inc.
Model: AA2784
Test #: 160127
Test to: 47CFR 15C, RSS-210
File: TstRpt AA2784 160127

SN: EUT1
FCC ID: IPH-A2784
IC: 1792A- A2784
Date: February 15, 2016
Page 29 of 30

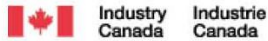
Annex E Industry Canada Site Registration Letter



June 08, 2015

OUR FILE: 46405-3041
Authorization No: 010277847-001

Rogers Labs Inc.
4405 West 259th Terrace
Louisburg, KS
USA
66053

Attention: Mr. Scot D. Rogers

Dear Sir:

The Bureau has received your application for the renewal of 3m OATS. Be advised that the information received was satisfactory to Industry Canada. The following number(s) is now associated to the site(s) for which registration / renewal was sought (**Site# 3041A-1**). Please reference the appropriate site number in the body of test reports containing measurements performed on the site. In addition, please keep for your records the following information;

- The company address code associated to the site(s) located at the above address is: **3041A**

Furthermore, to obtain or renew a unique site number, the applicant shall demonstrate that the site has been accredited to ANSI C63.4-2009 or later. A scope of accreditation indicating the accreditation by a recognized accreditation body to ANSI C63.4-2009 or later shall be accepted. Please indicate in a letter the previous assigned site number if applicable and the type of site (example: 3 metre OATS or 3 metre chamber). If the test facility is not accredited to ANSI C63.4-2009 or later, the test facility shall submit test data demonstrating full compliance with the ANSI standard. The Bureau will evaluate the filing to determine if recognition shall be granted.

The frequency for re-validation of the test site and the information that is required to be filed or retained by the testing party shall comply with the requirements established by the accrediting organization. However, in all cases, test site re-validation shall occur on an interval not to exceed **three years**. There is no fee or form associated with an OATS filing. OATS submissions are encouraged to be submitted electronically to the Bureau using the following URL; http://strategis.ic.gc.ca/epic/internet/inceb-bhst.nsf/en/h_tt00052e.html.

If you have any questions, you may contact the Bureau by e-mail at certification.bureau@ic.gc.ca Please reference our file and submission number above for all correspondence.

Yours sincerely,

A handwritten signature in black ink that reads "Bill Payn".

Bill Payn
For: Wireless Laboratory Manager
Certification and Engineering Bureau
3701 Carling Ave., Building 94
P.O. Box 11490, Station AH@
Ottawa, Ontario K2H 8S2
Email: certification.bureau@ic.gc.ca

Rogers Labs, Inc.
4405 West 259th Terrace
Louisburg, KS 66053
Phone/Fax: (913) 837-3214
Revision 1

Garmin International, Inc.
Model: AA2784
Test #: 160127
Test to: 47CFR 15C, RSS-210
File: TstRpt AA2784 160127

SN: EUT1
FCC ID: IPH-A2784
IC: 1792A- A2784
Date: February 15, 2016
Page 30 of 30