



Test Report Serial Number:	45461845 R1.0
Test Report Date:	3 April 2023
Project Number:	1623

EMC Test Report - New Certification

Applicant:



Garmin International Inc.
1200 East 151 St
Olathe, KS, 66062
USA

FCC ID:

IPH-A04523

Product Model Number / HVIN

A04523

IC Registration Number

-

Product Marketing Name / PMN

A04523

In Accordance With:

CFR Title 47, Part 15 Subpart C (§15.247), Part 15 Subpart B

Digital Transmission System (DTS)

Approved By:

Ben Hewson, President

Celltech Labs Inc.
 21-364 Lougheed Rd.
 Kelowna, BC, V1X 7R8
 Canada



Test Lab Certificate: 2470.01



**Industry
Canada**

IC Registration 3874A



FCC Registration: CA3874

This report shall not be reproduced in any form without the expressed written consent of Celltech Labs Inc.

Table of Contents

1.0 REVISION HISTORY	5
2.0 CLIENT AND DUT INFORMATION	6
3.0 SCOPE.....	7
4.0 TEST SUMMARY.....	8
5.0 NORMATIVE REFERENCES	10
6.0 FACILITIES AND ACCREDITATIONS	11
7.0 OCCUPIED BANDWIDTH	12
8.0 DTS BANDWIDTH	21
9.0 ANTENNA PORT CONDUCTED POWER, (DTS).....	30
10.0 ANTENNA PORT CONDUCTED POWER, (DSS)	32
11.0 POWER SPECTRAL DENSITY.....	34
12.0 FHSS NUMBER OF HOPPING CHANNELS.....	43
13.0 FHSS CHANNEL SEPARATION.....	49
14.0 FHSS TIME OF OCCUPANCY.....	55
15.0 CONDUCTED SPURIOUS EMISSIONS -BAND EDGE.....	67
16.0 CONDUCTED SPURIOUS EMISSIONS	82
17.0 RADIATED TX SPURIOUS EMISSIONS, RESTRICTED BAND	84
18.0 RADIATED RX SPURIOUS EMISSIONS	88
19.0 POWER LINE CONDUCTED EMISSIONS	91
APPENDIX A – TEST SETUP DRAWINGS	96
APPENDIX B – EQUIPMENT LIST AND CALIBRATION.....	101
APPENDIX C – MEASUREMENT INSTRUMENT UNCERTAINTY.....	102
END OF REPORT.....	102
APPENDIX D – CONDUCTED POWER MEASUREMENT PLOTS.....	103
APPENDIX E – CONDUCTED SPURIOUS EMISSIONS MEASUREMENT PLOTS	103
APPENDIX F – RADIATED TX EMISSIONS MEASUREMENT PLOTS.....	103
APPENDIX G – RADIATED RX EMISSIONS MEASUREMENT PLOTS.....	103

Table of Figures

Figure A.1 – Test Setup – Conducted Measurements.....	96
Figure A.2 – Test Setup Radiated Measurements 9kHzMHz – 30MHz	97
Figure A.3 – Test Setup Radiated Measurements 30MHz – 1GHz.....	98
Figure A.4 – Test Setup Radiated Measurements 30MHz – 1GHz, Signal Substitution	98
Figure A.5 – Test Setup Radiated Measurements 1 – 18GHz,	99
Figure A.6 – Test Setup Radiated Measurements 18 – 26.5GHz,	99
Figure A.7 – Test Setup Conducted Emissions Measurements	100

Table of Plots

Plot 7.1 – Occupied Bandwidth, 802.11b.....	13
Plot 7.2 – Occupied Bandwidth, 802.11g.....	14
Plot 7.3 – Occupied Bandwidth, 802.11n.....	15
Plot 7.4 – Occupied Bandwidth, BT BR.....	17
Plot 7.5 – Occupied Bandwidth, BT 2EDR.....	18
Plot 7.6 – Occupied Bandwidth, BT 3EDR.....	19
Plot 8.1 – 6dB DTS Bandwidth 802.11b.....	22
Plot 8.2 – 6dB DTS Bandwidth 802.11g.....	23
Plot 8.3 – 6dB DTS Bandwidth 802.11n.....	24
Plot 8.4 – 6dB DTS Bandwidth, BT BR.....	26
Plot 8.5 – 6dB DTS Bandwidth, BT 2EDR.....	27
Plot 8.6 – 6dB DTS Bandwidth, BT 3EDR.....	28
Plot 11.1 – Power Spectral Density, 802.11b.....	35
Plot 11.2 – Power Spectral Density, 802.11g.....	36
Plot 11.3 – Power Spectral Density, 802.11n.....	37
Plot 11.4 – Power Spectral Density, BT BR.....	39
Plot 11.5 – Power Spectral Density, BT 2EDR.....	40
Plot 11.6 – Power Spectral Density, BT 3EDR.....	41
Plot 12.1 – Number of Hopping Channels, BT BR.....	44
Plot 12.2 – Number of Hopping Channels, BT BR.....	45
Plot 12.3 – Number of Hopping Channels, BT 2EDR.....	46
Plot 12.4 – Number of Hopping Channels, BT 2EDR.....	47
Plot 13.1 – 20dB BW, BT BR.....	50
Plot 13.2 – FHSS Channel Separation, BT BR.....	51
Plot 13.3 – 20dB BW, BT 2EDR.....	52
Plot 13.4 – FHSS Channel Separation, BT 2EDR.....	53
Plot 14.1 – Time of Occupancy, DH1, 2-DH1, 3-DH1, DM1.....	56
Plot 14.2 – Time of Occupancy, DH1, 2-DH1, 3-DH1, DM1.....	57
Plot 14.3 – Time of Occupancy, DH3, 2-DH3, 3-DH3, DM3.....	58
Plot 14.4 – Time of Occupancy, DH3, 2-DH3, 3-DH3, DM3.....	59
Plot 14.5 – Time of Occupancy, DH5, 2-DH5, 3-DH5, DM5.....	60
Plot 14.6 – Time of Occupancy, DH5, 2-DH5, 3-DH5, DM5.....	61
Plot 14.7 – Time of Occupancy, EV4.....	62
Plot 14.8 – Time of Occupancy, EV4.....	63
Plot 14.9 – Time of Occupancy, EV5.....	64
Plot 14.10 – Time of Occupancy, EV5.....	65
Plot 15.1 – Band Edge, 802.11b.....	68
Plot 15.2 – Band Edge, 802.11b.....	69
Plot 15.3 – Band Edge, 802.11g.....	70
Plot 15.4 – Band Edge, 802.11g.....	71
Plot 15.5 – Band Edge, 802.11n.....	72
Plot 15.6 – Band Edge, 802.11n.....	73
Plot 15.7 – Band Edge, BT BR.....	75
Plot 15.8 – Band Edge, BT BR.....	76
Plot 15.9 – Band Edge, BT 2EDR.....	77
Plot 15.10 – Band Edge, BT 2EDR.....	78
Plot 15.11 – Band Edge, BT 3EDR.....	79
Plot 15.12 – Band Edge, BT 3EDR.....	80
Plot 19.1 – Power Line Conducted Emissions, Line 1.....	92
Plot 19.2 – Power Line Conducted Emissions, Line 2.....	93

Table of Tables

<i>Table 7.1 – Summary of Occupied Bandwidth Measurements, (DTS)</i>	16
<i>Table 7.2 – Summary of Occupied Bandwidth Measurements (DSS)</i>	20
<i>Table 8.1 – Summary of 6dB DTS Bandwidth Measurements, (DTS)</i>	25
<i>Table 8.2 – Summary of 6dB DTS Bandwidth Measurements, (DSS)</i>	29
<i>Table 9.1 – Summary of Conducted Power Measurements, (DTS)</i>	31
<i>Table 10.1 – Summary of Conducted Power Measurements, (DSS)</i>	33
<i>Table 11.1 – Summary of Power Spectral Density Measurements, (DTS)</i>	38
<i>Table 11.2 – Summary of Power Spectral Density Measurements, (DSS)</i>	42
<i>Table 12.2 – Summary of FHSS Number of Hopping Channels</i>	48
<i>Table 13.1 – Summary of FHSS Channel Separation</i>	54
<i>Table 14.1 – Summary of FHSS Time of Occupancy</i>	66
<i>Table 15.1 – Summary of Spurious Emission Measurements – Band Edge, (DTS)</i>	74
<i>Table 15.2 – Summary of Spurious Emission Measurements – Band Edge, DSS</i>	81
<i>Table 16.1 – Summary of Conducted Spurious Emissions, (DTS)</i>	83
<i>Table 16.2 – Summary of Conducted Spurious Emissions, (DSS)</i>	83
<i>Table 17.1 – Summary of Radiated Tx Spurious Emissions, Restricted Band, (DTS)</i>	85
<i>Table 17.2 – Summary of Radiated Tx Spurious Emissions, (DTS)</i>	86
<i>Table 17.2 – Summary of Radiated Tx Spurious Emissions, (DSS)</i>	87
<i>Table 18.1 – Summary of Radiated Rx Spurious Emissions, (DTS)</i>	89
<i>Table 18.2 – Summary of Radiated Rx Spurious Emissions, (DSS)</i>	90
<i>Table 19.1 – Summary of Power Line Conducted Emissions – L1</i>	94
<i>Table 19.1 – Summary of Power Line Conducted Emissions – L2</i>	95
<i>Table A.1 – Conducted Measurement Setup</i>	96
<i>Table A.2 – Radiated Emissions Measurement Equipment</i>	97
<i>Table A.3 – Setup – Conducted Emissions Equipment List</i>	100

1.0 REVISION HISTORY

Revision History					
Samples Tested By:		Art Voss, P.Eng.	Date(s) of Evaluation:		15 January - 13 February, 2023
Report Prepared By:		Art Voss, P.Eng.	Report Reviewed By:		Ben Hewson
Report Revision	Description of Revision	Revised Section	Revised By	Revision Date	
0.1	Draft	n/a	Art Voss	20 March 2023	
1.0	Initial Release	n/a	Art Voss	3 April 2023	

2.0 CLIENT AND DUT INFORMATION

Client Information	
Applicant Name	Garmin International Inc.
Applicant Address	1200 East 151 St
	Olathe, KS, 66062
	USA
DUT Information	
Device Identifier(s):	FCC ID: IPH-A04523
Device Model(s) / HVIN:	A04523
Device Marketing Name / PMN:	A04523
Test Sample Serial No.:	3430507583 - Conducted, 3433247654 - OTA
Device Type:	Extremity Worn Digital Transceiver
Equipment Class:	Digital Transmission Systems (DTS)
	Spread Spectrum Transmitter (DSS)
	Low Power Communication Device (DXX)
	Global Navigation Satellite System (GNSS) Receivers
	NFC - Low Power Communication Device Transmitter (DXX)
Transmit Frequency Range:	WiFi (DTS): 2412-2462MHz
	BT/BLE/ANT: 2402-2480MHz
	NFC: 13.56MHz
Manuf. Max. Rated Output Power:	WiFi - Digital Transmission System (DTS): 17.78dBm
	BlueTooth - Spread Spectrum Transmitter (DSS): 11.11dBm
	BLE/ANT - Low Power Communication Device Transmitter (DXX): 2.10dBm
	NFC - Low Power Communication Device Transmitter (DXX): 55.19dBuV/m
Antenna Type and Gain:	-5.06dBi Max
Modulation:	WiFi: DSSS, OFDM, CCK, MCS0-7
	BT BR: GFSK
	BT EDR: Pi/4-DQPSK, 8DPSK
	BLE: GMSK
	ANT: GFSK
DUT Power Source:	3VDC Rechargeable Li-Ion
DUT Dimensions [LxWxH]	H x W x D: 47mm dia x 4.5mm
Deviation(s) from standard/procedure:	None
Modification of DUT:	None

3.0 SCOPE

Preface:

This Certification Report was prepared on behalf of:

Garmin International Inc.

, (the '*Applicant*'), in accordance with the applicable Federal Communications Commission (FCC) CFR 47 and Innovation, Scientific and Economic Development (ISED) Canada rules parts and regulations (the '*Rules*'). The scope of this investigation was limited to only the equipment, devices and accessories (the '*Equipment*') supplied by the *Applicant*. The tests and measurements performed on this *Equipment* were only those set forth in the applicable *Rules* and/or the Test and Measurement Standards they reference. The *Rules* applied and the Test and Measurement Standards used during this evaluation appear in the Normative References section of this report. The limits set forth in the technical requirements of the applicable *Rules* were applied to the measurement results obtained during this evaluation and, unless otherwise noted, these limits were used as the Pass/Fail criteria. The Pass/Fail statements made in this report apply to only the tests and measurements performed on only the *Equipment* tested during this evaluation. Where applicable and permissible, information including test and measurement data and/or results from previous evaluations of same or similar equipment, devices and/or accessories may be cited in this report.

Device:

The Garmin Model/HVIN: A04523 is an extremity worn digital transceiver device consisting of a WiFi, BlueTooth (BT), BlueTooth Low Energy (BLE), Adaptive Network Topology (ANT) and Near Field Communication (NFC) transceivers. The WiFi and BT/BLE/ANT transceivers share the same antenna and cannot simultaneously transmit.

Requirement:

The transceivers of this *equipment* are subject to emissions evaluation in accordance with FCC: 47 CFR 2, 15C. As per FCC 47 CFR §2.1093, an RF Exposure (SAR) evaluation is required for this *Equipment* and the results of the RF Exposure (SAR) evaluation appear in a separate report.

Application:

This is an application for a New Certification.

Scope:



The scope of this investigation is limited to the evaluation and reporting of the wanted and spurious emissions in accordance with the rule parts cited in Normative References section of this report.

4.0 TEST SUMMARY

TEST SUMMARY					
Section	Description of Test	Procedure Reference	Applicable Rule Part(s) FCC	Test Date	Result
7.0	Occupied Bandwidth	ANSI C63.10-2013 KDB 558074 D01v05	§2.1049	15, 21 Jan 2023	Pass
8.0	DTS Bandwidth	ANSI C63.10-2013 KDB 558074 D01v05	§15.247(a)(2)	22 Jan 2023	Pass
9.0	Conducted Power (Fundamental)	ANSI C63.10-2013 KDB 558074 D01v05	§2.1046 §15.247(b)(3)	15 Jan, 8 Feb 2023	Pass
10.0	Conducted Power (Fundamental)	ANSI C63.10-2013 KDB 558074 D01v05	§2.1046 §15.247(b)(1)	15 Jan, 8 Feb 2023	Pass
11.0	Power Spectral Density	ANSI C63.10-2013 KDB 558074 D01v05	§15.247(e)	19, 23 Jan 2023	Pass
12.0	FHSS Hopping Characteristics	ANSI C63.4-2014 KDB 558074 D01v05	§15.247(a)(1)(iii)	20 Jan, 9 Feb 2023	Pass
13.0	FHSS Channel Separation	ANSI C63.4-2014 KDB 558074 D01v05	§15.247(a)(1)	20 Jan, 9 Feb 2023	Pass
14.0	FHSS Time of Occupancy	ANSI C63.4-2014 KDB 558074 D01v05	§15.247(a)(1)(iii)	20 Jan, 9 Feb 2023	Pass
15.0	Conducted Tx Spurious Emissions Band Edge	ANSI C63.10-2013 KDB 558074 D01v05	§2.1051 §15.247(d)	20 Jan, 13 Feb 2023	Pass
16.0	Conducted Tx Spurious Emissions	ANSI C63.10-2013 KDB 558074 D01v05	§2.1051 §15.247(d)	22 Jan 2023	Pass
17.0	Radiated Tx Spurious Emissions And Restricted Band	ANSI C63.4-2014 KDB 558074 D01v05	§15.109 §15.247(d)	31 Jan 2023	Pass
18.0	Radiated Rx Spurious Emissions	ANSI C63.4-2014 KDB 558074 D01v05	§15.109	31 Jan 2023	Pass
19.0	Power Line Conducted Emissions	ANSI C63.4-2014	§15.107	25 Jan 2023	Pass

Test Station Day Log					
Date	Ambient Temp (°C)	Relative Humidity (%)	Barometric Pressure (kPa)	Test Station	Tests Performed Section(s)
15 Jan 2023	21.6	17	101.6	EMC	7, 9, 10,
19 Jan 2023	22.1	18	101.2	EMC	11
20 Jan 2023	22.6	16	101.5	EMC	12, 13, 14, 15
21 Jan 2023	21.9	18	101.4	EMC	7
22 Jan 2023	22.1	18	101.3	EMC	8, 16
23 Jan 2023	22.5	17	101.1	EMC	11
25 Jan 2023	17.2	52	102.1	LISN	19
31 Jan 2023	0.0	87	101.5	OATS	17, 18
8 Feb 2023	22.5	16	101.0	EMC	9
9 Feb 2023	22.1	17	101.4	EMC	12, 13, 14
13 Feb 2023	21.9	18	102.4	EMC	15

EMC - EMC Test Bench **SAC** - Semi-Anechoic Chamber
OATS - Open Area Test Site **TC** - Temperature Chamber
LISN - LISN Test Area **ESD** - ESD Test Bench
IMM - Immunity Test Area **RI** - Radiated Immunity Chamber

<p>I attest that the data reported herein is true and accurate within the tolerance of the Measurement Instrument Uncertainty; that all tests and measurements were performed in accordance with accepted practices or procedures; and that all tests and measurements were performed by me or by trained personnel under my direct supervision. The results of this investigation are based solely on the test sample(s) provided by the client which were not adjusted, modified or altered in any manner whatsoever, except as required to carry out specific tests or measurements. This test report has been completed in accordance with ISO/IEC 17025.</p>	 <hr/> <p>Art Voss, P.Eng. Technical Manager Celltech Labs Inc. 14 February 2023 <hr/>Date</p> 
---	--

5.0 NORMATIVE REFERENCES

Normative References	
ISO/IEC 17025:2017	General requirements for the competence of testing and calibration laboratories
ANSI C63.4-2014	American National Standard of Procedures for Methods of Measurement of Radio-Noise Emissions from Low-Voltage Electric and Electronic Equipment in the Range of 9kHz to 40GHz
ANSI C63.10-2013	American National Standard of Procedures for Compliance Testing of Unlicensed Wireless Devices
CFR	Code of Federal Regulations Title 47: Telecommunication Part 2: Frequency Allocations and Radio Treaty Matters; General Rules and Regulations
CFR	Code of Federal Regulations Title 47: Telecommunication Part 15: Radio Frequency Devices Subpart B: Unintentional Radiators
CFR	Code of Federal Regulations Title 47: Telecommunication Part 15: Radio Frequency Devices Sub Part C (15.247) Intentional Radiators
FCC KDB 558074 D01v05r02	OET Major Guidance Publications, Knowledge Data Base Guidance for Performing Compliance Measurements on Digital Transmission Systems (DTS) Operating Under Section 15.247

6.0 FACILITIES AND ACCREDITATIONS

Facility and Accreditation:

The facilities used to evaluate this device outlined in this report are located at 21-364 Lougheed Road, Kelowna, British Columbia, Canada V1X 7R8. The radiated emissions site (OATS) conforms to the requirements set forth in ANSI C63.4 and is filed and listed with the FCC under Test Firm Registration Number CA3874 and Innovation, Science and Economic Development Canada under Test Site File Number ISED 3874A. Celltech is accredited to ISO 17025, through accrediting body A2LA and with certificate 2470.01.

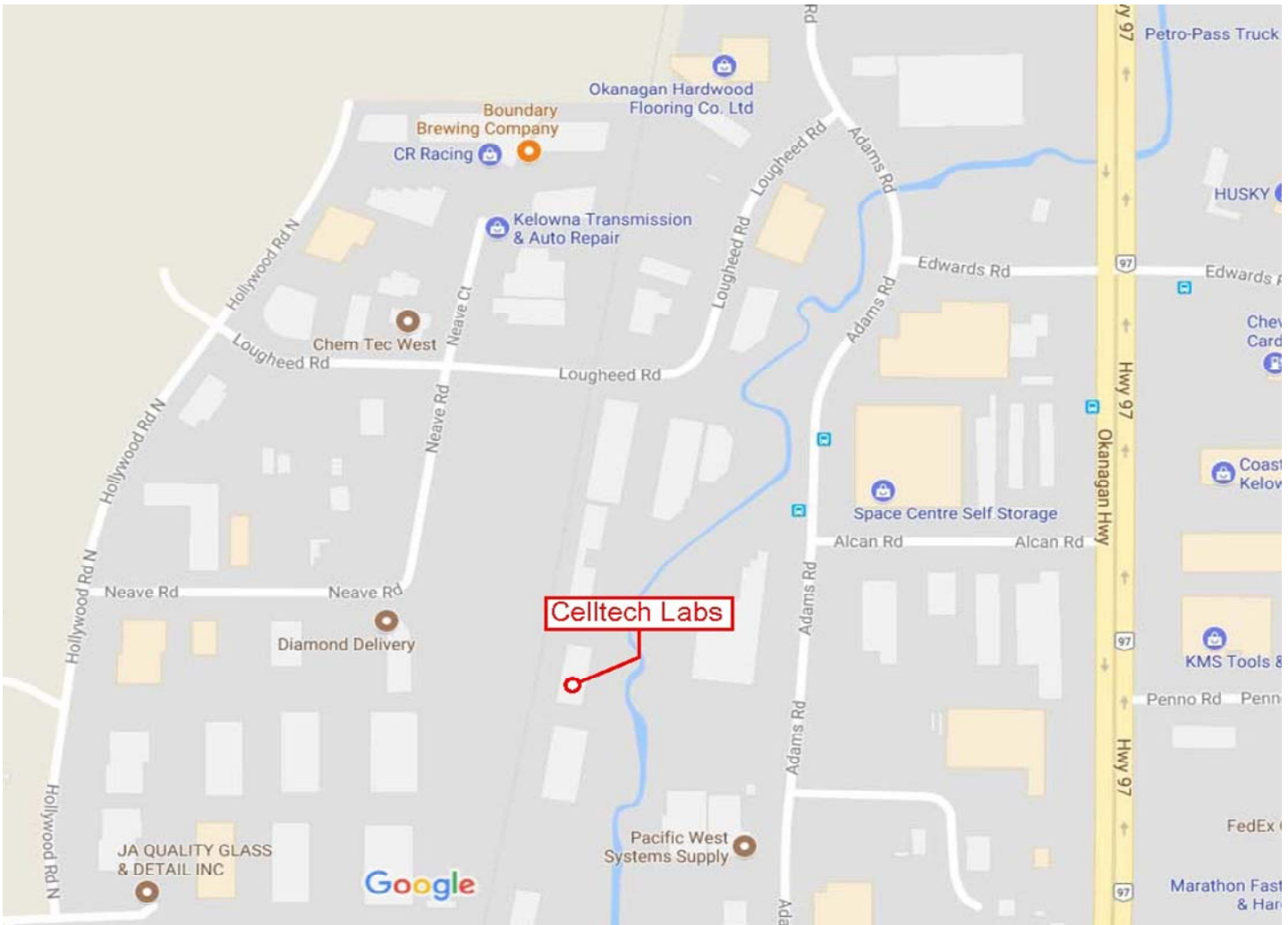

7.0 OCCUPIED BANDWIDTH

Test Procedure

Normative Reference	FCC 47 CFR §2.1046, §15.247(b)(3), RSS-Gen (6.1.2), RSS-247 (5.4)(d), KDB 558074 (8.3.2.1), ANSI C63.10 (6.9.3)
----------------------------	--

General Procedure

KDB 558074 (8.3.2.1)	<p>8.3.2.1 General</p> <p>Section 15.247 permits the maximum conducted (average) output power to be measured as an alternative to the maximum peak conducted output power for demonstrating compliance to the limit. When this option is exercised, the measured power is to be referenced to the OBW rather than the DTS bandwidth.</p>
C63.10 (6.9.3)	<p>6.9.3 Occupied bandwidth—power bandwidth (99%) measurement procedure</p> <p>The occupied bandwidth is the frequency bandwidth such that, below its lower and above its upper frequency limits, the mean powers are each equal to 0.5% of the total mean power of the given emission. The following procedure shall be used for measuring 99% power bandwidth:</p> <ol style="list-style-type: none"> The instrument center frequency is set to the nominal EUT channel center frequency. The frequency span for the spectrum analyzer shall be between 1.5 times and 5.0 times the OBW. The nominal IF filter bandwidth (3 dB RBW) shall be in the range of 1% to 5% of the OBW, and VBW shall be approximately three times the RBW, unless otherwise specified by the applicable requirement. Set the reference level of the instrument as required, keeping the signal from exceeding the maximum input mixer level for linear operation. In general, the peak of the spectral envelope shall be more than $[10 \log (OBW/RBW)]$ below the reference level. Specific guidance is given in 4.1.5.2. Step a) through step c) might require iteration to adjust within the specified range. Video averaging is not permitted. Where practical, a sample detection and single sweep mode shall be used. Otherwise, peak detection and max hold mode (until the trace stabilizes) shall be used. Use the 99% power bandwidth function of the instrument (if available) and report the measured bandwidth.

Test Setup	Appendix A - Figure A.1
-------------------	--------------------------------

Measurement Procedure

The DUT was connected to a Spectrum Analyzer (SA) via a 30dB attenuator connected to the DUT's antenna port. The SA was configured as described above using the 99% Occupied Bandwidth function. The output power of the DUT was set to the manufacturer's highest output power setting at the Low, Mid and High frequency channels as permitted by the device. The DUT was set to transmit at its maximum Duty Cycle. The 99% Occupied Bandwidth was measured and recorded and used for the basis for measuring the Conducted Output Power (See Section 10.0) and Power Spectral Density (See Section 11.0).

Plot 7.1 – Occupied Bandwidth, 802.11b

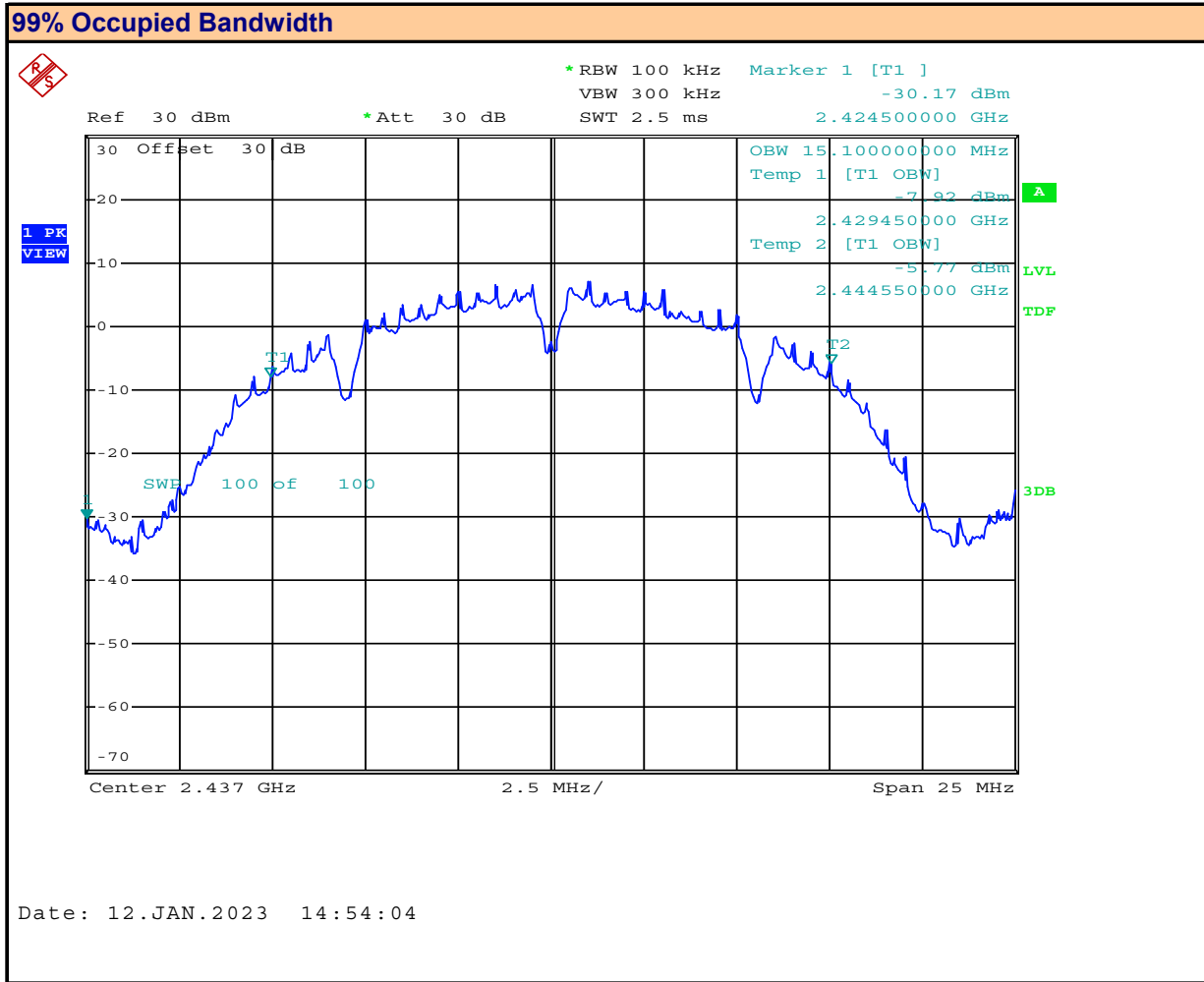

Channel:
 Mode:

Channel Frequency: MHz
 Modulation:
 Measured Occupied Bandwidth: MHz

Plot 7.2 – Occupied Bandwidth, 802.11g

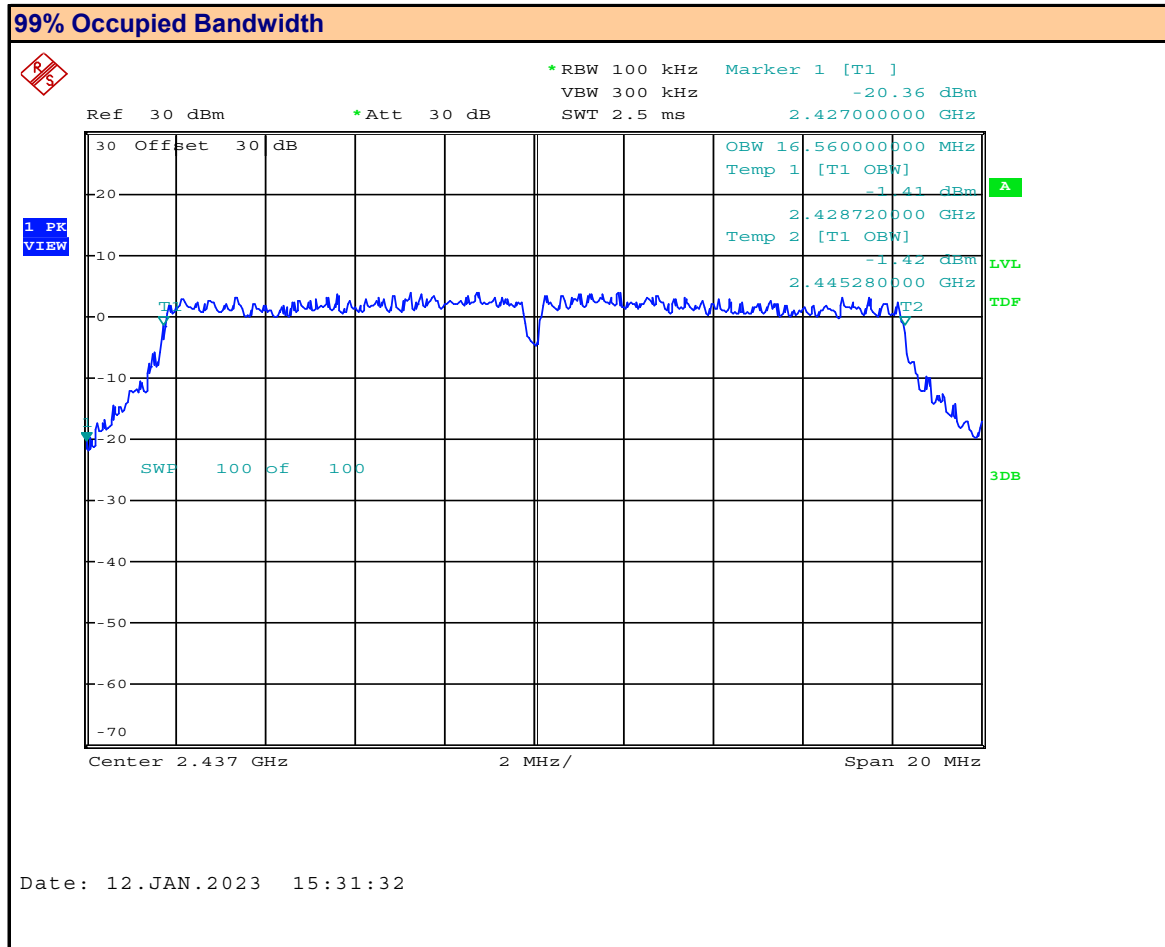

Channel:
 Mode:

Channel Frequency: MHz
 Modulation:
 Measured Occupied Bandwidth: MHz

Plot 7.3 – Occupied Bandwidth, 802.11n

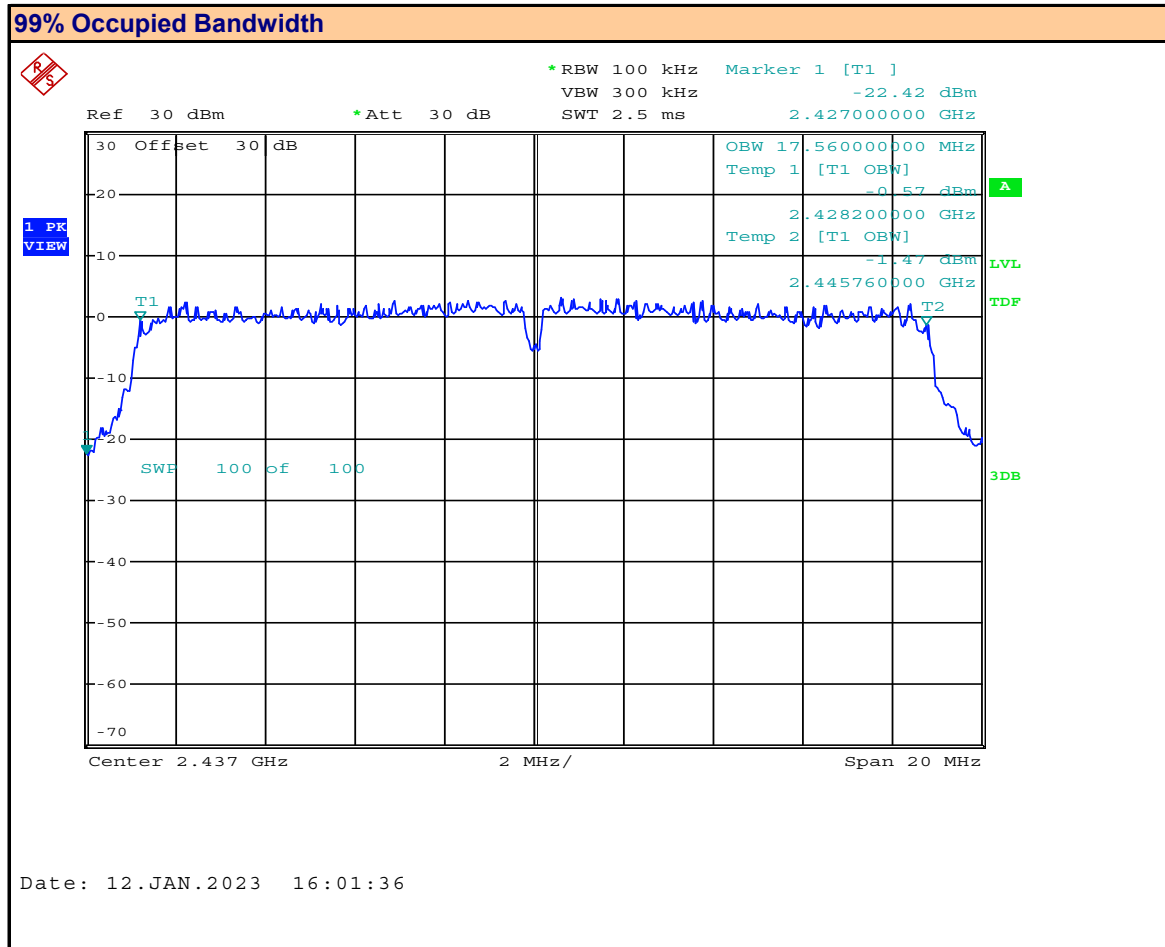

Channel:
 Mode:

Channel Frequency: MHz
 Modulation:
 Measured Occupied Bandwidth: MHz

Table 7.1 – Summary of Occupied Bandwidth Measurements, (DTS)

99% Occupied Bandwidth Results:					
Channel Number	Channel Frequency (MHz)	Mode	Modulation	Measured Occupied Bandwidth (MHz)	Emission Designator
6	2437.0	802.11b	DSSS 5.5	15.1	15M1D1D
6	2437.0	802.11g	OFDM12	16.6	16M6D1D
6	2437.0	802.11n	MCS0	17.6	17M6D1D
Result:					Complies

Plot 7.4 – Occupied Bandwidth, BT BR

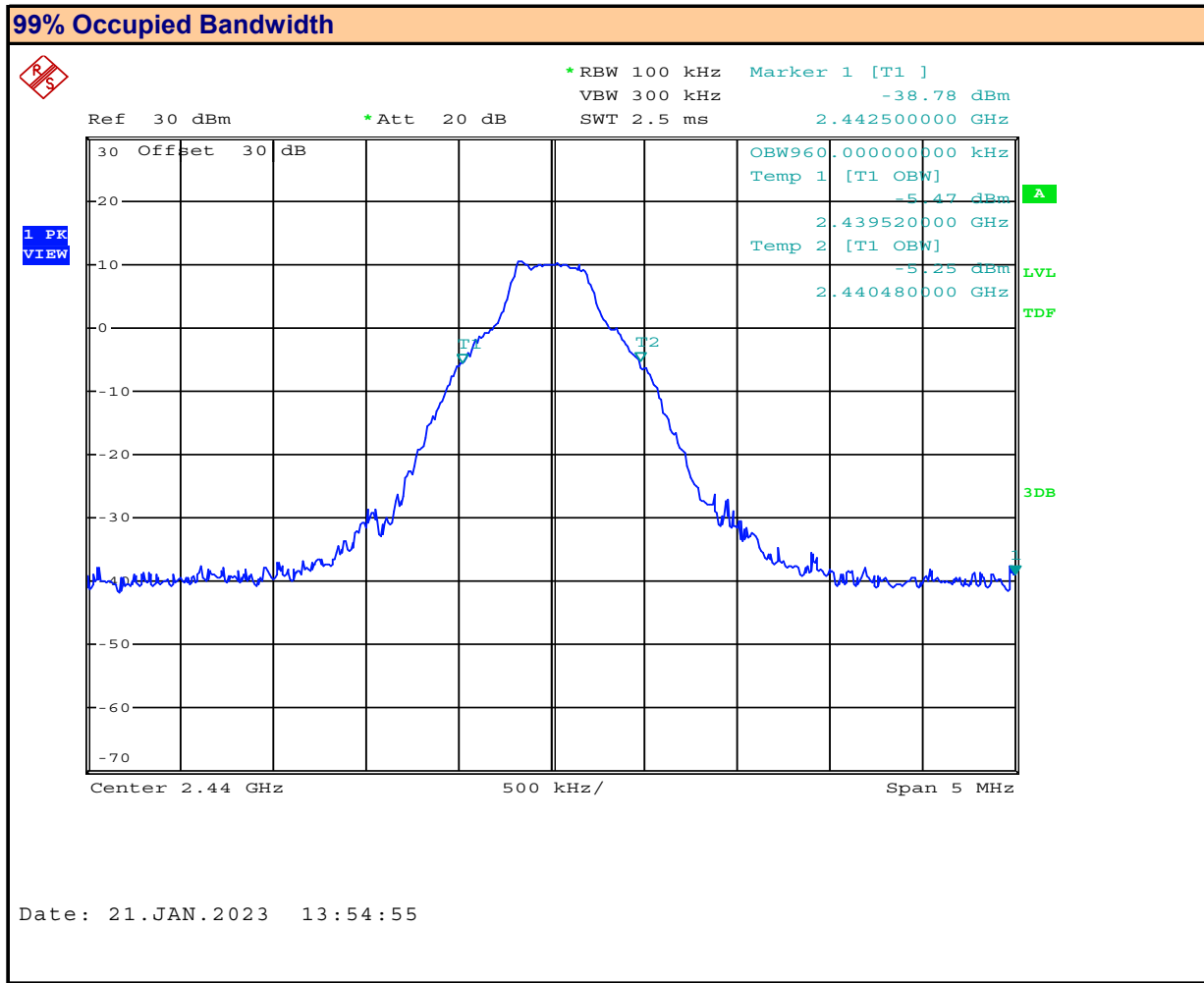

Channel:
 Mode:

Channel Frequency: MHz
 Modulation:

Measured Occupied Bandwidth: MHz

Plot 7.5 – Occupied Bandwidth, BT 2EDR

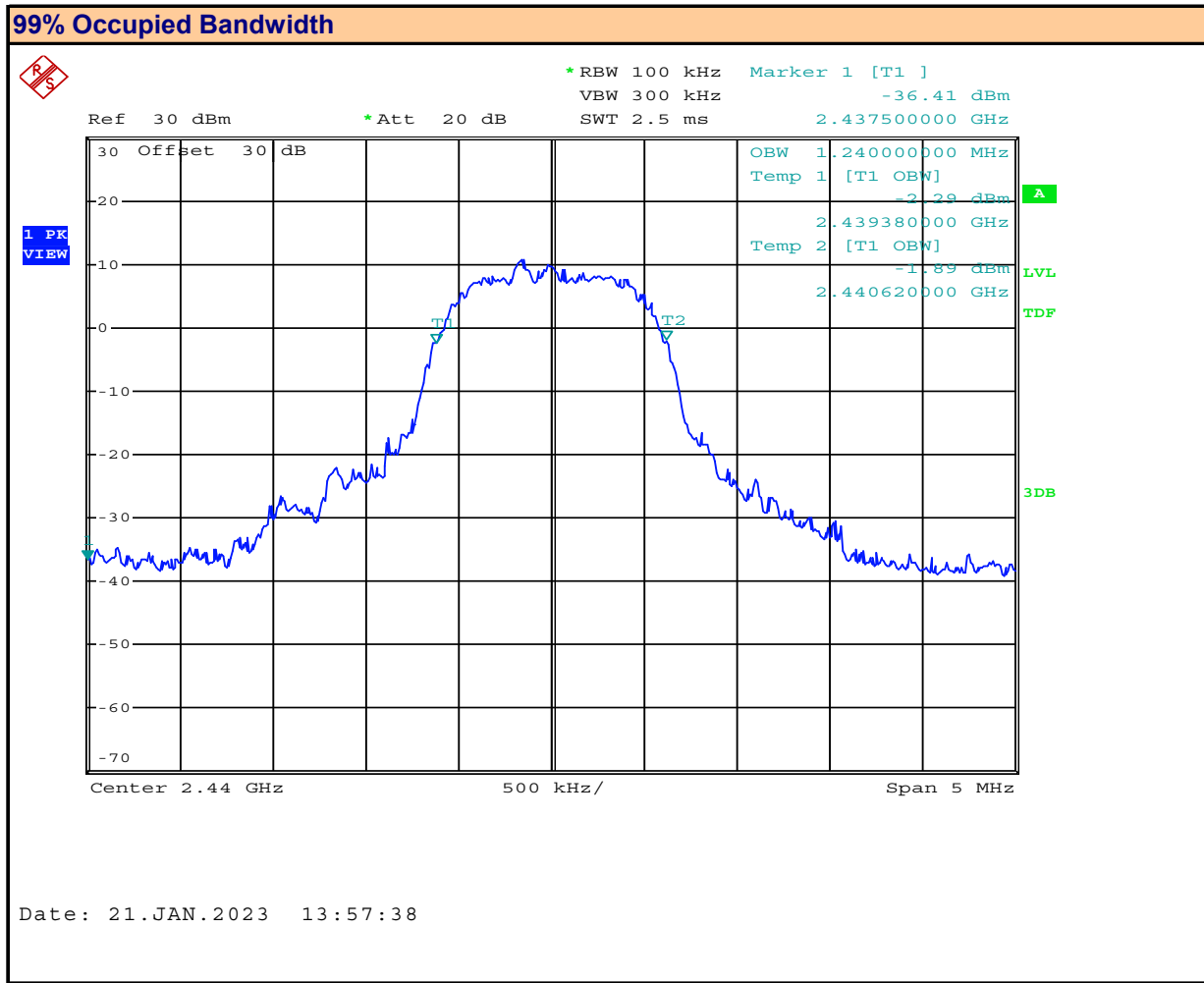

Channel:
 Mode:

Channel Frequency: MHz
 Modulation:
 Measured Occupied Bandwidth: MHz

Plot 7.6 – Occupied Bandwidth, BT 3EDR

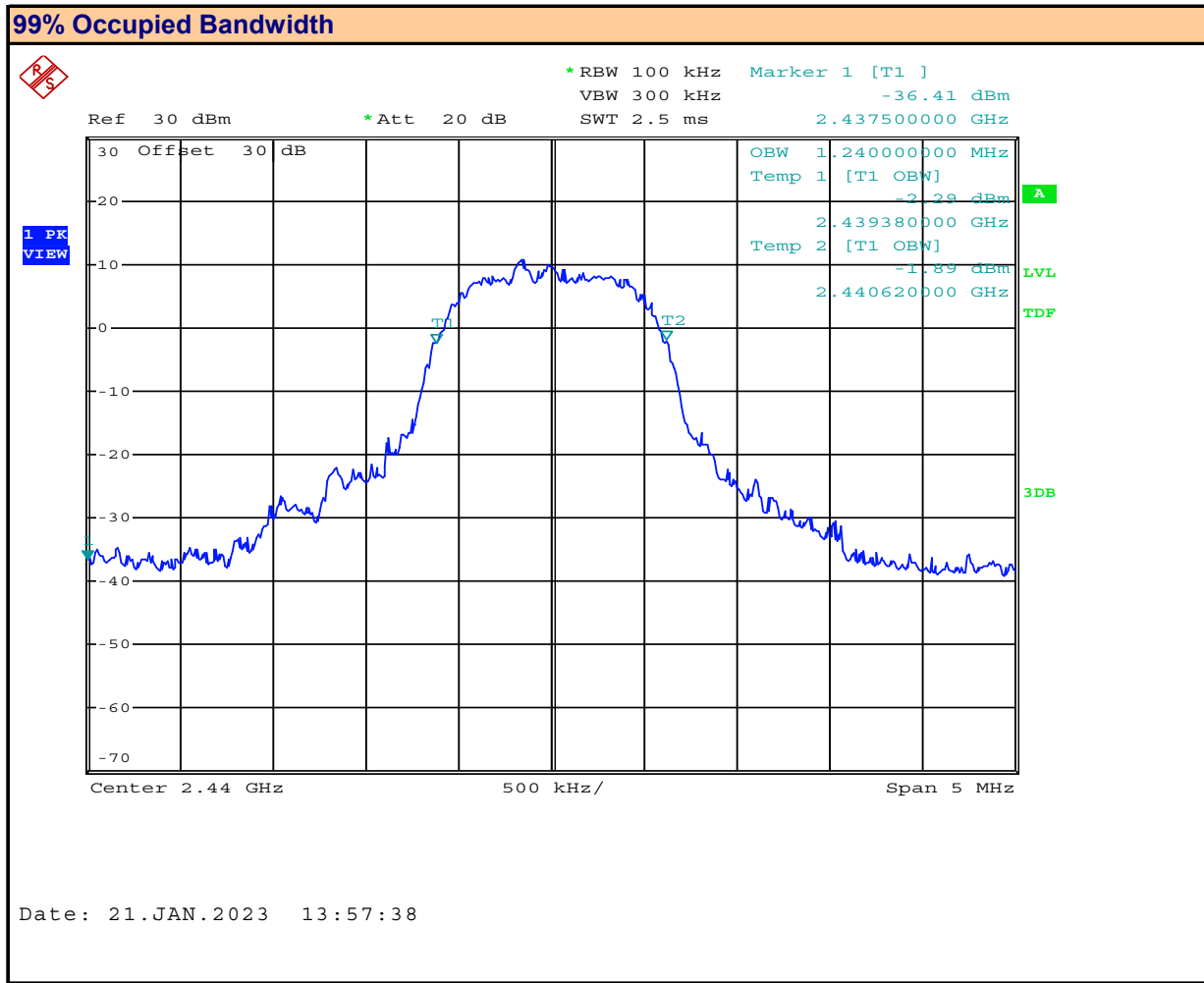

Channel:
 Mode:

Channel Frequency: MHz
 Modulation:
 Measured Occupied Bandwidth: MHz

Table 7.2 – Summary of Occupied Bandwidth Measurements (DSS)

99% Occupied Bandwidth Results:					
Channel Number	Channel Frequency (MHz)	Mode	Modulation	Measured Occupied Bandwidth (MHz)	Emission Designator
38	2440.0	BT BR	GFSK	0.960	960KF1D
38	2440.0	BT 2EDR	Pi/4-DQPSK	1.240	1M24G1D
38	2440.0	BT 3EDR	8-DSPK	1.240	1M24G1D
Result:					Complies

8.0 DTS BANDWIDTH

Test Procedure

Normative Reference	FCC 47 CFR §2.1049, §15.247(a)(2), RSS-Gen (6.7), RSS-247 (5.2)(a), KDB 558074 (8.2), ANSI C63.10 (11.8.2)
----------------------------	---

Limits

47 CFR §15.247(a)(2)	(a) Operation under the provisions of this Section is limited to frequency hopping and digitally modulated intentional radiators that comply with the following provisions: (2) Systems using digital modulation techniques may operate in the 902-928 MHz, 2400-2483.5 MHz, and 5725-5850 MHz bands. The minimum 6 dB bandwidth shall be at least 500 kHz.
RSS-247 (5.2)(a)	5.2 Digital transmission systems DTSs include systems that employ digital modulation techniques resulting in spectral characteristics similar to direct sequence systems. The following applies to the bands 902-928 MHz and 2400 - 2483.5 MHz: a) The minimum 6 dB bandwidth shall be 500 kHz.
KDB 558074 (8.2) C63.10 (11.8.2)	8.2 Option 2 The automatic bandwidth measurement capability of an instrument may be employed using the X dB bandwidth mode with X set to 6 dB, if the functionality described above (i.e., RBW = 100 kHz, VBW ≥ 3 X RBW, peak detector with maximum hold) is implemented by the instrumentation function. When using this capability, care shall be taken so that the bandwidth measurement is not influenced by any intermediate power nulls in the fundamental emission that might be ≥ 6 dB.

Test Setup	Appendix A Figure A.1
-------------------	-------------------------------------

Measurement Procedure

The DUT was connected to a Spectrum Analyzer (SA) via a 30dB attenuator connected to the DUT's antenna port. The SA was configured as above using the Automatic 6dB Cursor Bandwidth measurement. The output power of the DUT was set to the manufacturer's highest output power setting at the Low, Mid and High frequency channels as permitted by the device. The DUT was set to transmit at 100% Duty Cycle.

Plot 8.1 – 6dB DTS Bandwidth 802.11b

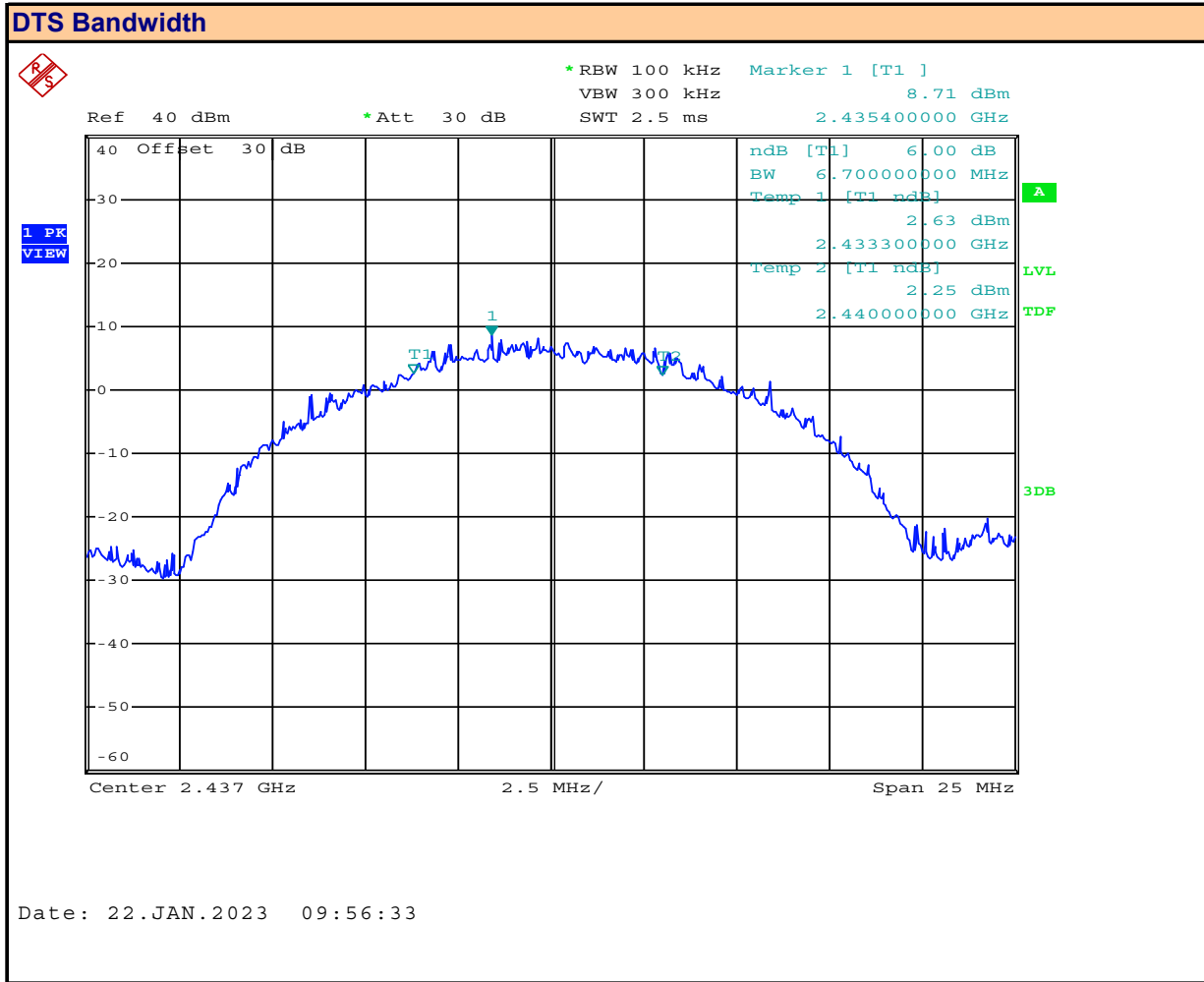

Channel:
 Mode:

Channel Frequency: MHz
 Modulation:
 Measured DTS Bandwidth: MHz

Plot 8.2 – 6dB DTS Bandwidth 802.11g

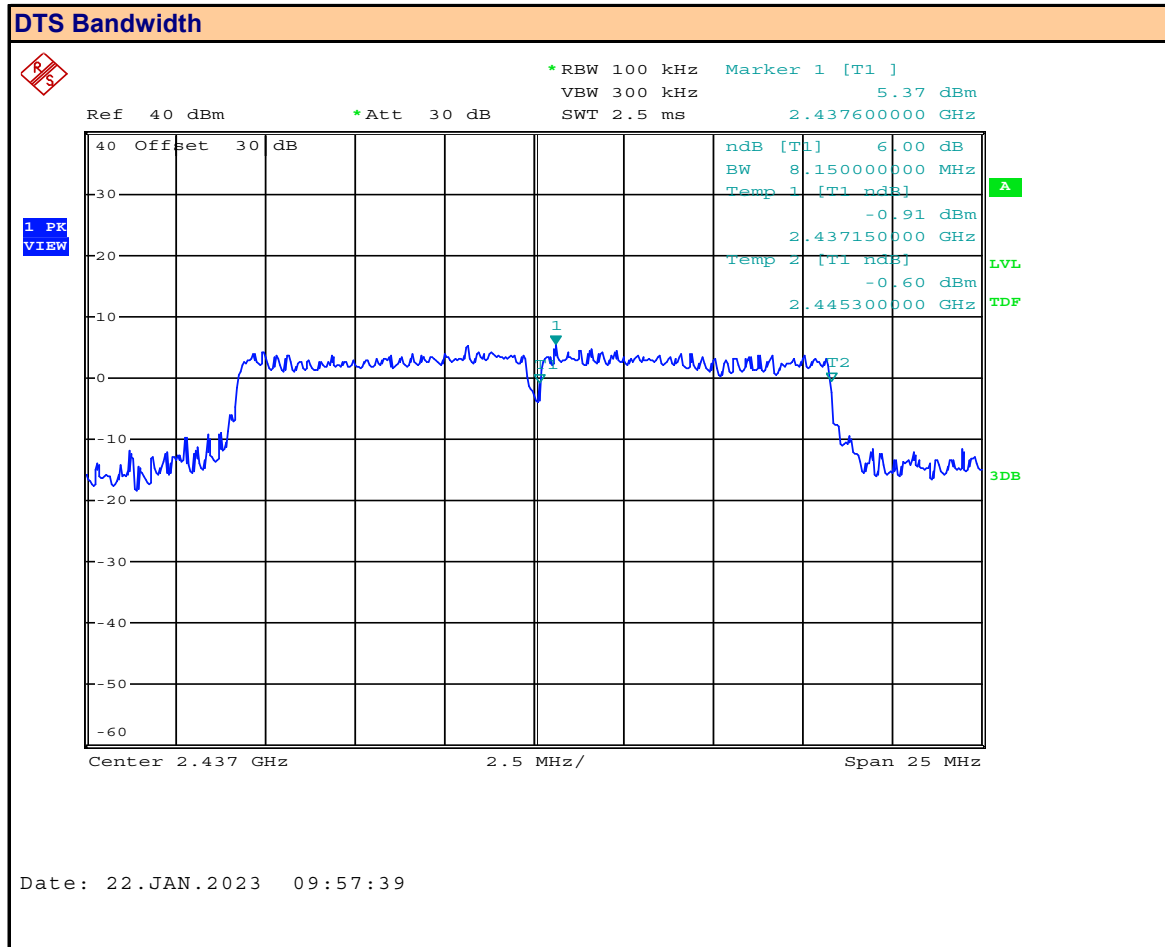

Channel:
 Mode:

Channel Frequency: MHz
 Modulation:
 Measured DTS Bandwidth: MHz

Plot 8.3 – 6dB DTS Bandwidth 802.11n

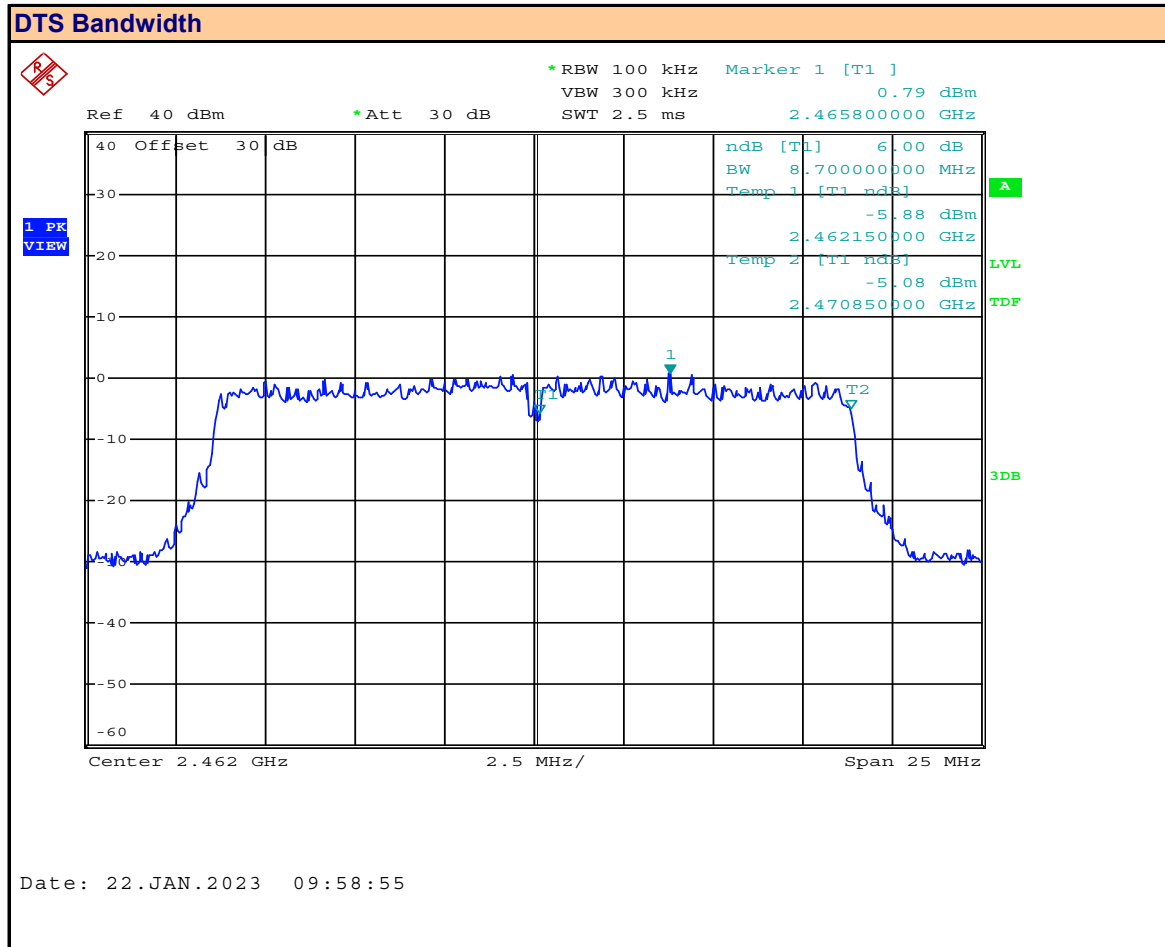

Channel:
 Mode:

Channel Frequency: MHz
 Modulation:
 Measured DTS Bandwidth: MHz

Table 8.1 – Summary of 6dB DTS Bandwidth Measurements, (DTS)

DTS Bandwidth Results:						
Channel Number	Channel Frequency (MHz)	Mode	Modulation	Measured DTS Bandwidth (MHz)	Minimum DTS Bandwidth (MHz)	Margin (MHz)
6	2437.0	802.11b	DSSS 5.5	6.7	0.50	6.2
6	2437.0	802.11g	OFDM12	16.3		15.8
6	2437.0	802.11n	MCS0	17.4		16.9
					Result:	Complies

Plot 8.4 – 6dB DTS Bandwidth, BT BR

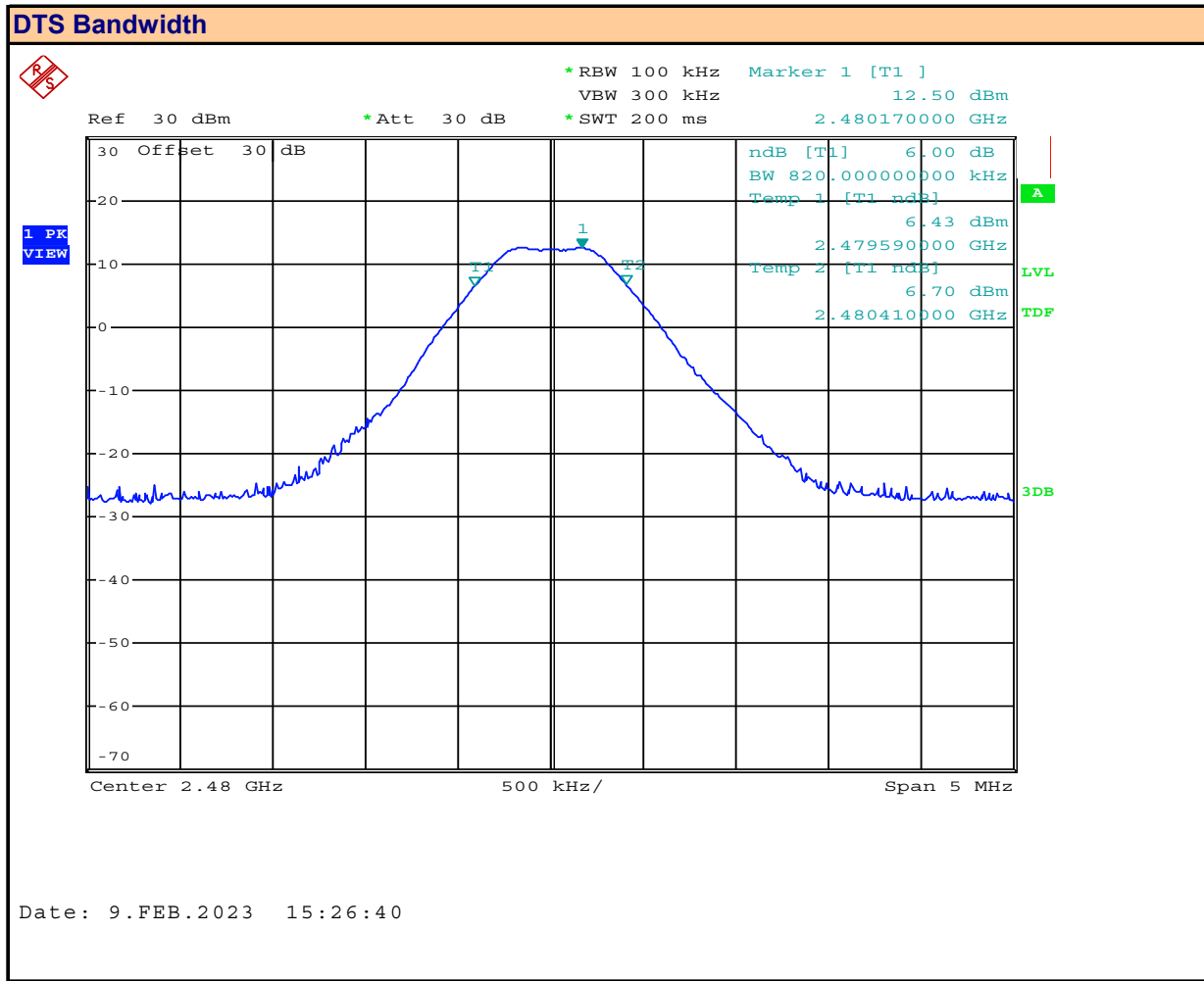

Channel:
 Mode:

Channel Frequency: MHz
 Modulation:
 Measured DTS Bandwidth: MHz

Plot 8.5 – 6dB DTS Bandwidth, BT 2EDR

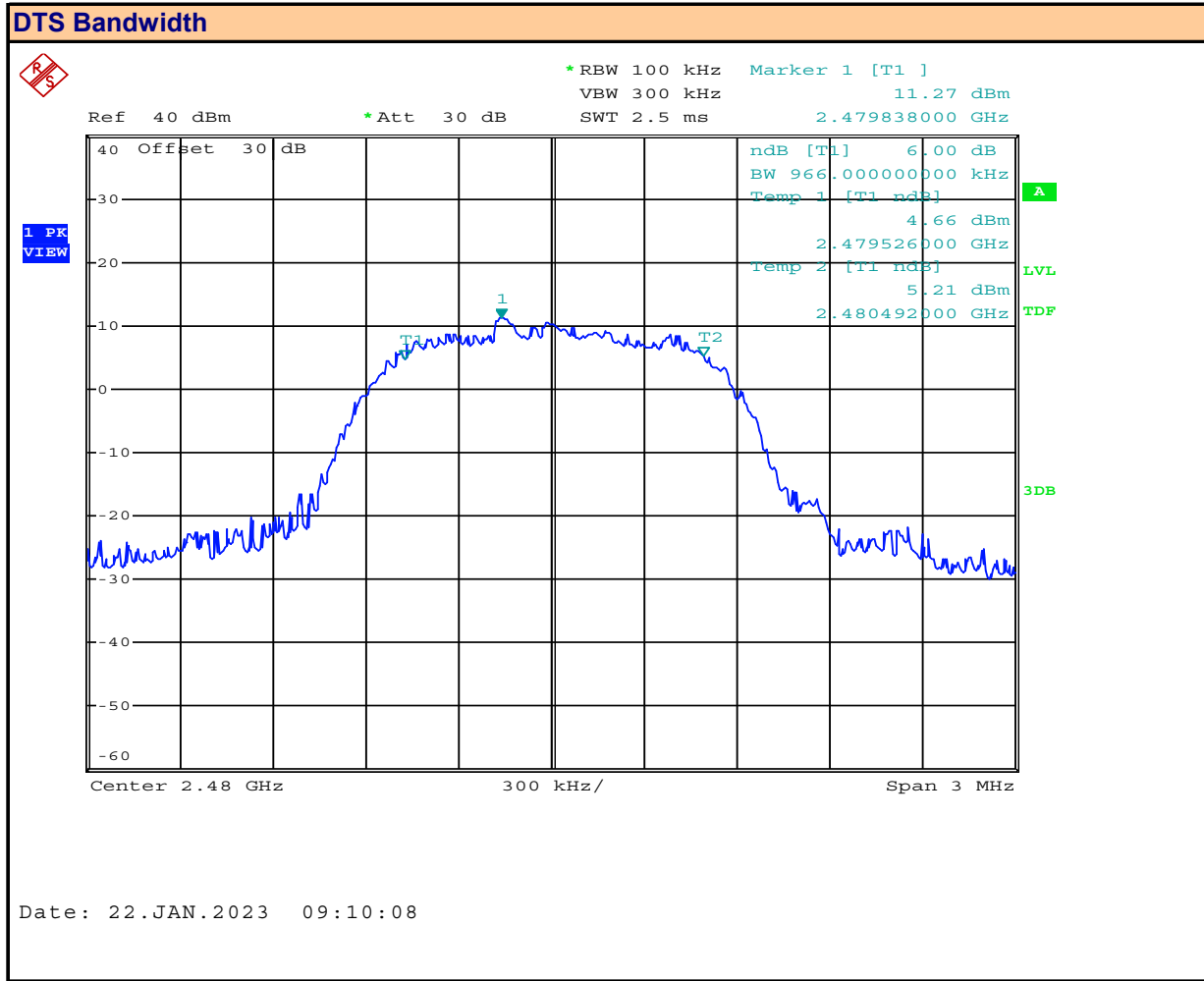

Channel:
 Mode:

Channel Frequency: MHz
 Modulation:
 Measured DTS Bandwidth: MHz

Plot 8.6 – 6dB DTS Bandwidth, BT 3EDR



Channel:
 Mode:

Channel Frequency: MHz
 Modulation:
 Measured DTS Bandwidth: MHz

Table 8.2 – Summary of 6dB DTS Bandwidth Measurements, (DSS)

DTS Bandwidth Results:						
Channel Number	Channel Frequency (MHz)	Mode	Modulation	Measured DTS Bandwidth (MHz)	Minimum DTS Bandwidth (MHz)	Margin (MHz)
78	2480.0	BT BR	GFSK	0.468	0.500	0.820
78	2480.0	BT 2EDR	Pi/4-DQPSK	0.966		0.466
78	2480.0	BT 3EDR	8-DPSK	0.960		0.460
					Result:	Complies

9.0 ANTENNA PORT CONDUCTED POWER, (DTS)

Test Procedure

Normative Reference	FCC 47 CFR §2.1046, §15.247(b)(3), RSS-Gen (6.1.2), RSS-247 (5.4)(d), KDB 558074 (8.3.2), ANSI C63.10 (11.9.2.2.2)
----------------------------	---

Limits

47 CFR §15.247(b)(3)	(b) The maximum peak conducted output power of the intentional radiator shall not exceed the following: (3) For systems using digital modulation in the 902-928 MHz, 2400-2483.5 MHz, and 5725-5850 MHz bands: 1 Watt. As an alternative to a peak power measurement, compliance with the one Watt limit can be based on a measurement of the maximum conducted output power.
RSS-247 (5.4)(d)	5.4 Transmitter output power and equivalent isotropically radiated power (e.i.r.p.) Devices shall comply with the following requirements, where applicable: d) For DTSs employing digital modulation techniques operating in the bands 902-928 MHz and 2400-2483.5 MHz, the maximum peak conducted output power shall not exceed 1W. The e.i.r.p. shall not exceed 4 W, except as provided in section 5.4(e). As an alternative to a peak power measurement, compliance can be based on a measurement of the maximum conducted output power.

Table 9.1 – Summary of Conducted Power Measurements, (DTS)

See Appendix D for Measurement Plots

Conducted Power Measurement Results:													
Channel Number	Channel Frequency (MHz)	Mode	Modulation	Measured Power [P _{Meas}] (dBm)	Measured Power (W)	Conducted Limit [P _{Lim}] (dBm)	Conducted Margin (dB)	Antenna Gain (dBi)	EIRP [E _{Meas}] (dBm)	EIRP (W)	EIRP Limit [E _{Lim}] (dBm)	EIRP Margin (dB)	
6	2437.00	802.11b	CCK 1MB	16.99	0.0500	30.00	13.0	-5.06	11.93	0.0156	36	24.1	
			CCK 2MB	17.03	0.0505		13.0		11.97	0.0157		24.0	
			DSSS 5.5	17.12	0.0515		12.9		12.06	0.0161		23.9	
			DSSS 11	16.88	0.0488		13.1		11.82	0.0152		24.2	
1	2412.00	802.11g	OFDM12	DSSS 5.5	16.65		0.0462		13.4	11.59		0.0144	24.4
11	2462.00			16.92	0.0492		13.1		11.86	0.0153		24.1	
1	2412.00			17.70	0.0589		12.3		12.64	0.0184		23.4	
6	2437.00			17.78	0.0600		12.2		12.72	0.0187		23.3	
11	2462.00	802.11n	MCS0	17.28	0.0535		12.7		12.22	0.0167		23.8	
1	2412.00			15.78	0.0378		14.2		10.72	0.0118		25.3	
6	2437.00			15.78	0.0378		14.2		10.72	0.0118		25.3	
11	2462.00			15.80	0.0380		14.2		10.74	0.0119		25.3	
Result:											Complies		

Conducted Margin = P_{Limit} - P_{Meas}

10.0 ANTENNA PORT CONDUCTED POWER, (DSS)

Test Procedure

Normative Reference	FCC 47 CFR §2.1046, §15.247(b)(3), RSS-Gen (6.1.2), RSS-247 (5.4)(d), KDB 558074 (8.3.2), ANSI C63.10 (11.9.2.2.2)
----------------------------	---

Limits

47 CFR §15.247(b)(3)	(b) The maximum peak conducted output power of the intentional radiator shall not exceed the following: (3) For systems using digital modulation in the 902-928 MHz, 2400-2483.5 MHz, and 5725-5850 MHz bands: 1 Watt. As an alternative to a peak power measurement, compliance with the one Watt limit can be based on a measurement of the maximum conducted output power.
RSS-247 (5.4)(d)	5.4 Transmitter output power and equivalent isotropically radiated power (e.i.r.p.) Devices shall comply with the following requirements, where applicable: d) For DTSSs employing digital modulation techniques operating in the bands 902-928 MHz and 2400-2483.5 MHz, the maximum peak conducted output power shall not exceed 1W. The e.i.r.p. shall not exceed 4 W, except as provided in section 5.4(e). As an alternative to a peak power measurement, compliance can be based on a measurement of the maximum conducted output power.

Table 10.1 – Summary of Conducted Power Measurements, (DSS)

See Appendix D for Measurement Plots

Conducted Power Measurement Results:												
Channel Number	Channel Frequency (MHz)	Mode	Modulation	Measured Power [P _{Meas}] (dBm)	Measured Power (W)	Conducted Limit [P _{Lim}] (dBm)	Conducted Margin (dB)	Antenna Gain (dBi)	EIRP [E _{Meas}] (dBm)	EIRP (W)	EIRP Limit [E _{Lim}] (dBm)	EIRP Margin (dB)
0	2402.00	BT BR	GFSK	11.04	0.0127	30.00	19.0	-5.06	5.98	0.0040	36	30.0
38	2440.00			11.11	0.0129		18.9		6.05	0.0040		30.0
78	2480.00			11.13	0.0130		18.9		6.07	0.0040		29.9
0	2402.00	BT EDR2	Pi/4-DQPSK	10.11	0.0103		19.9		5.05	0.0032		31.0
38	2440.00			10.21	0.0105		19.8		5.15	0.0033		30.9
78	2480.00			10.23	0.0105		19.8		5.17	0.0033		30.8
0	2402.00	BT EDR3	8-DPSK	10.11	0.0103		19.9		5.05	0.0032		31.0
38	2440.00			10.11	0.0103		19.9		5.05	0.0032		31.0
78	2480.00			10.12	0.0103		19.9		5.06	0.0032		30.9
Result:											Complies	

Conducted Margin = $P_{Lim} - P_{Meas}$

Conducted Margin = $E_{Lim} - E_{Meas}$

11.0 POWER SPECTRAL DENSITY

Test Procedure	
Normative Reference	FCC 47 CFR §15.247(e), RSS-247 (5.2)(b), KDB 558074 (10.3), ANSI C63.10 (11.10.3)
Limits	
47 CFR §15.247(e)	(e) For digitally modulated systems, the power spectral density conducted from the intentional radiator to the antenna shall not be greater than 8 dBm in any 3 kHz band during any time interval of continuous transmission. This power spectral density shall be determined in accordance with the provisions of paragraph (b) of this section. The same method of determining the conducted output power shall be used to determine the power spectral density.
RSS-247 (5.2)(b)	b) The transmitter power spectral density conducted from the transmitter to the antenna shall not be greater than 8 dBm in any 3 kHz band during any time interval of continuous transmission. This power spectral density shall be determined in accordance with the provisions of section 5.4(d), (i.e. the power spectral density shall be determined using the same method as is used to determine the conducted output power).
KDB 558074 (10.3) C63.10 (11.10.3)	<p>Method AVGPS-1 (trace averaging with EUT transmitting at full power throughout each sweep)</p> <p>This procedure may be used when the maximum (average) conducted output power was used to demonstrate compliance to the output power limit. This is the baseline method for determining the maximum (average) conducted PSD level. If the instrument has an RMS power averaging detector, it must be used; otherwise, use the sample detector. The EUT must be configured to transmit continuously (duty cycle $\geq 98\%$); otherwise sweep triggering/signal gating must be implemented to ensure that measurements are made only when the EUT is transmitting at its maximum power control level (no transmitter off time is to be considered).</p> <ul style="list-style-type: none"> a) Set instrument center frequency to DTS channel center frequency. b) Set span to at least 1.5 X OBW. c) Set RBW to: $3\text{ kHz} \leq \text{RBW} \leq 100\text{ kHz}$. d) Set VBW $\geq 3 \times \text{RBW}$. e) Detector = RMS f) Ensure that the number of measurement points in the sweep $\geq 2 \times \text{span}/\text{RBW}$. g) Sweep time = auto couple. h) Employ trace averaging (RMS) mode over a minimum of 100 traces. i) Use the peak marker function to determine the maximum amplitude level. j) If measured value exceeds limit, reduce RBW (no less than 3 kHz) and repeat (note that this may require zooming in on the emission of interest and reducing the span in order to meet the minimum measurement point requirement as the RBW is reduced).
Test Setup	Appendix A Figure A.1

Measurement Procedure

The DUT was connected to a Spectrum Analyzer (SA) via a 30dB attenuator connected to the DUT's antenna port. The SA was configured as described above. Number of Sweep Points $\geq 2 \times \text{Span} / \text{RBW} = 2 \times (1.5\text{MHz} / 3\text{kHz}) = 1000$, the SA was configured for 1001 Points. The output power of the DUT was set to the manufacturer's highest output power setting at the Low, Mid and High frequency channels as permitted by the device. The DUT was set to transmit at 100% Duty Cycle. The Power Spectral Density was measured and recorded.

Plot 11.1 – Power Spectral Density, 802.11b

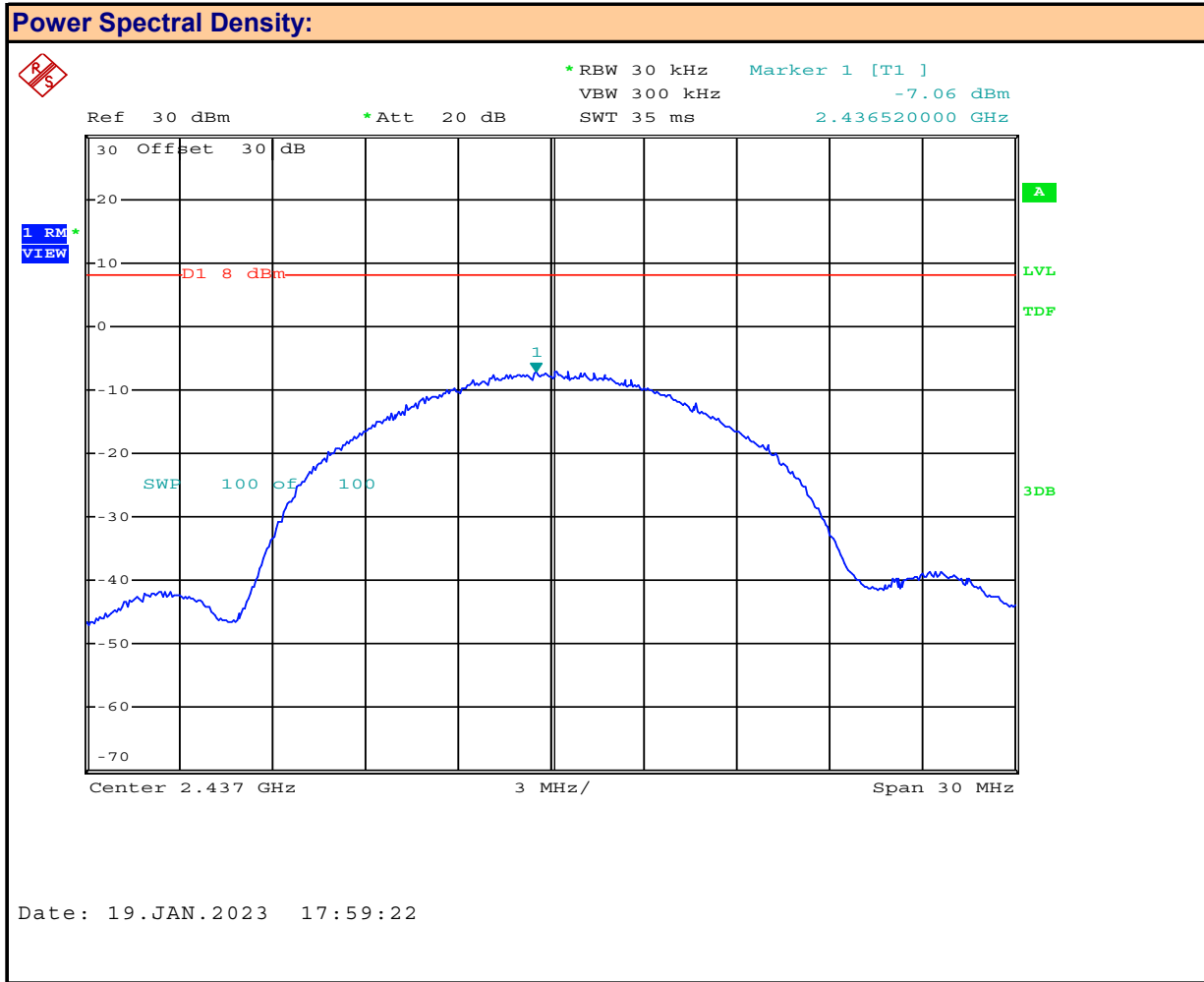

Channel:
 Mode:

Channel Frequency: MHz
 Modulation:
 Measured PSD: dBm

Plot 11.2 – Power Spectral Density, 802.11g

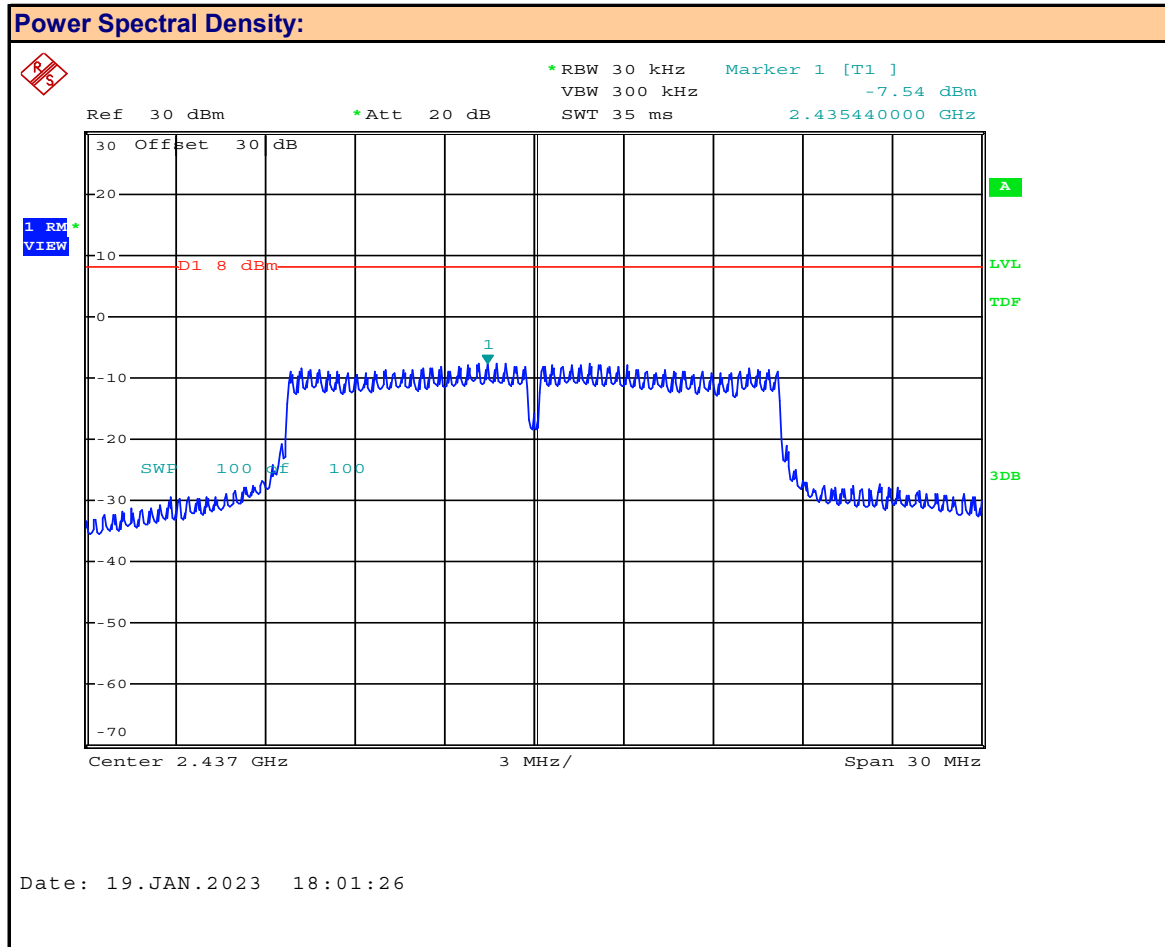

Channel:
 Mode:

Channel Frequency: MHz
 Modulation:
 Measured PSD: dBm

Plot 11.3 – Power Spectral Density, 802.11n

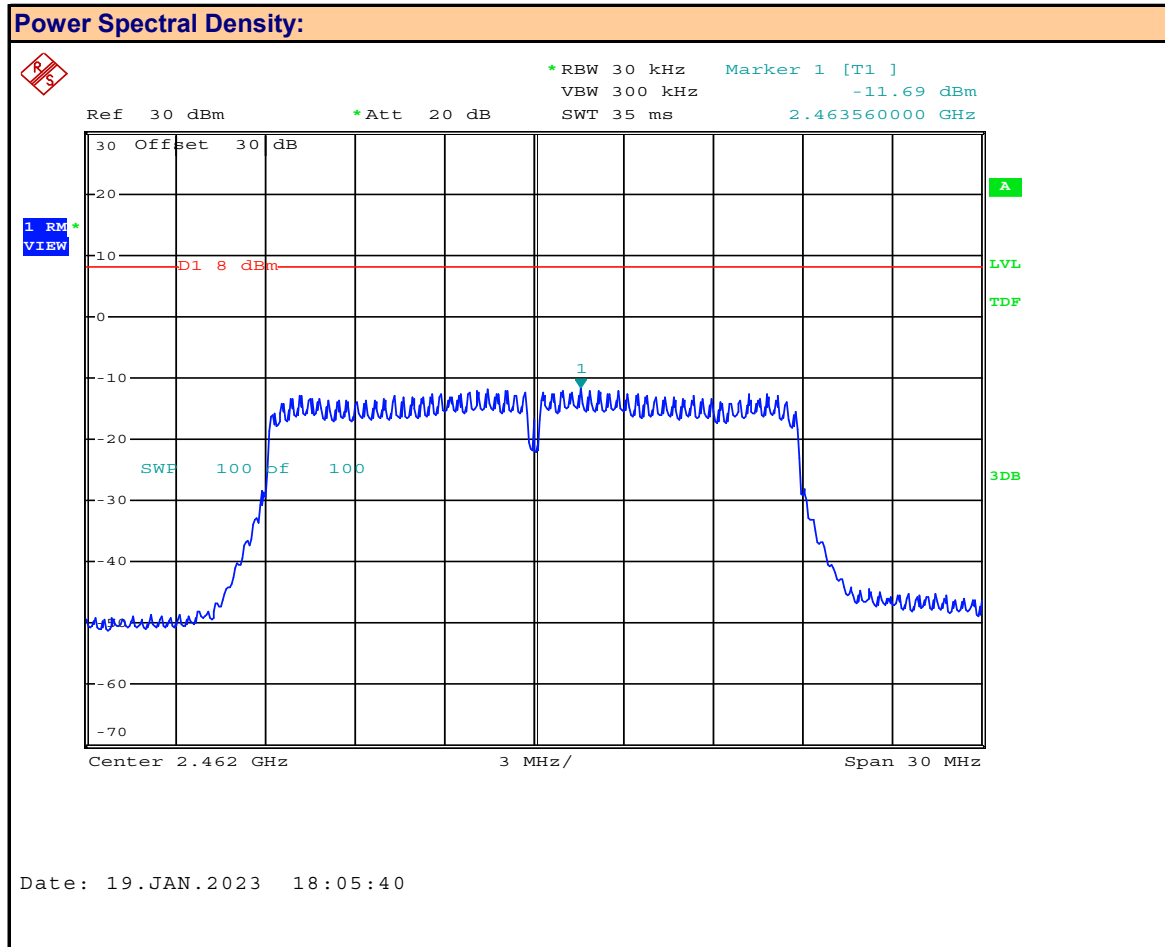

Channel:
 Mode:

Channel Frequency: MHz
 Modulation:
 Measured PSD: dBm

Table 11.1 – Summary of Power Spectral Density Measurements, (DTS)

Conducted Power Measurement Results:						
Channel Number	Channel Frequency (MHz)	Mode	Modulation	Measured PSD [P_{Meas}] (dBm)	Conducted Limit [P_{Lim}] (dBm)	Margin (dB)
6	2437.00	802.11b	DSSS 5.5	-7.06	8.00	15.1
6	2437.00	802.11g	OFDM 12	-7.54		15.5
6	2437.00	802.11n	MCS0	-11.69		19.7
					Result:	Complies

Conducted Margin = $P_{Limit} - P_{Meas}$

Plot 11.4 – Power Spectral Density, BT BR

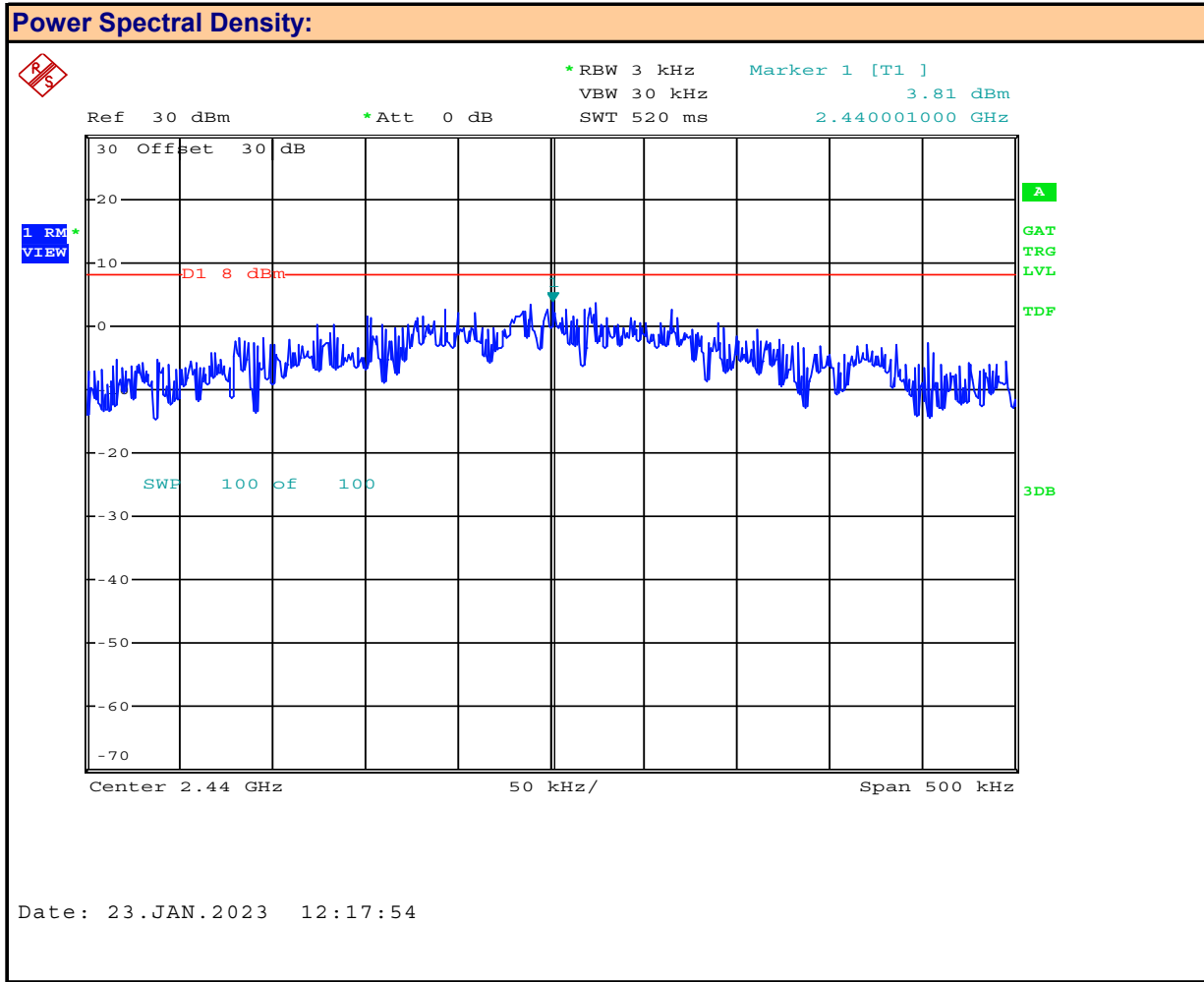

Channel:
 Mode:

Channel Frequency: MHz
 Modulation:
 Measured PSD: dBm

Plot 11.5 – Power Spectral Density, BT 2EDR

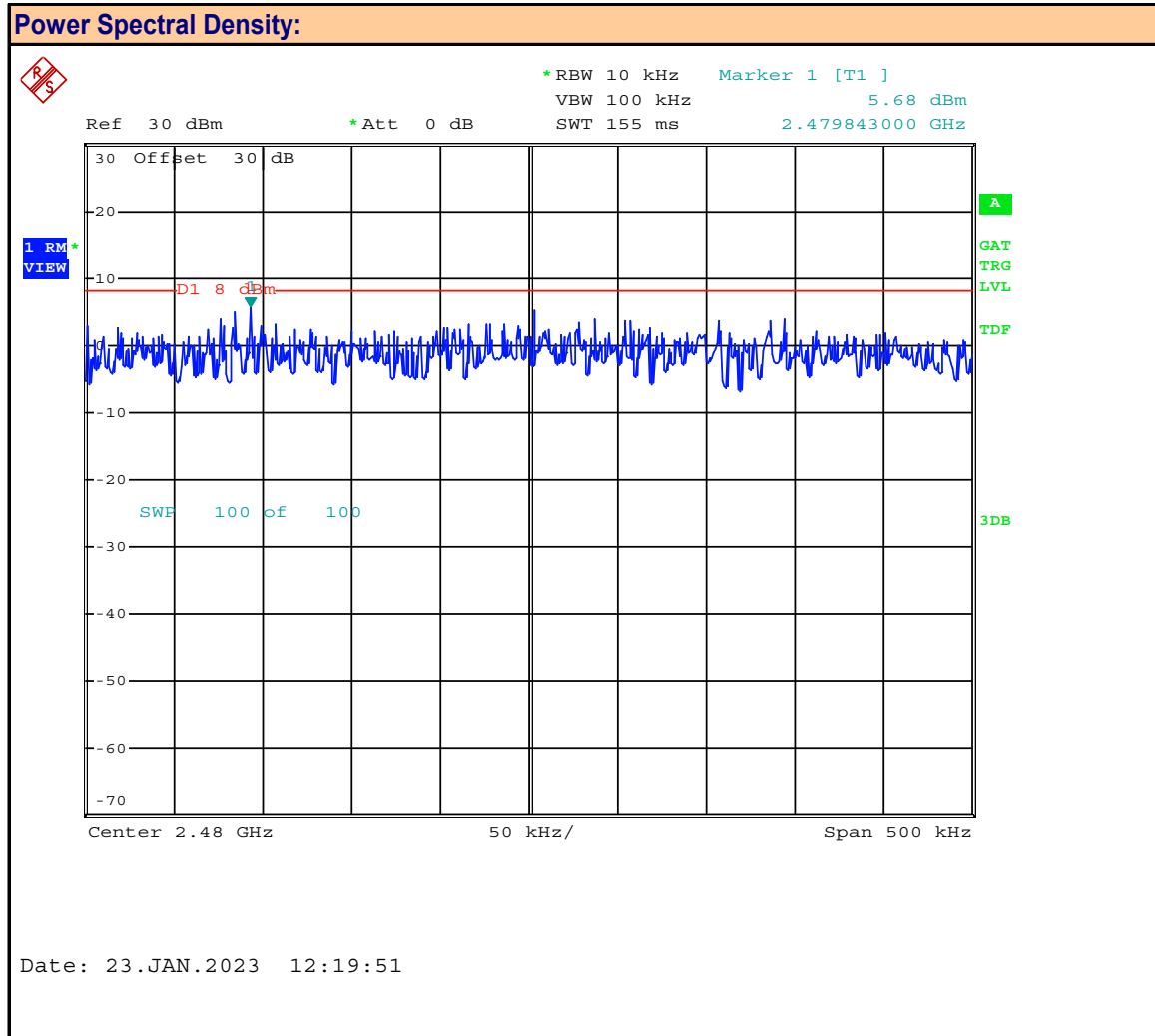

Channel: **78**

Mode: **BT 2EDR**

Channel Frequency: **2480** MHz

Modulation: **pi/4-DQPSK**

Measured PSD: **5.68** dBm

Plot 11.6 – Power Spectral Density, BT 3EDR

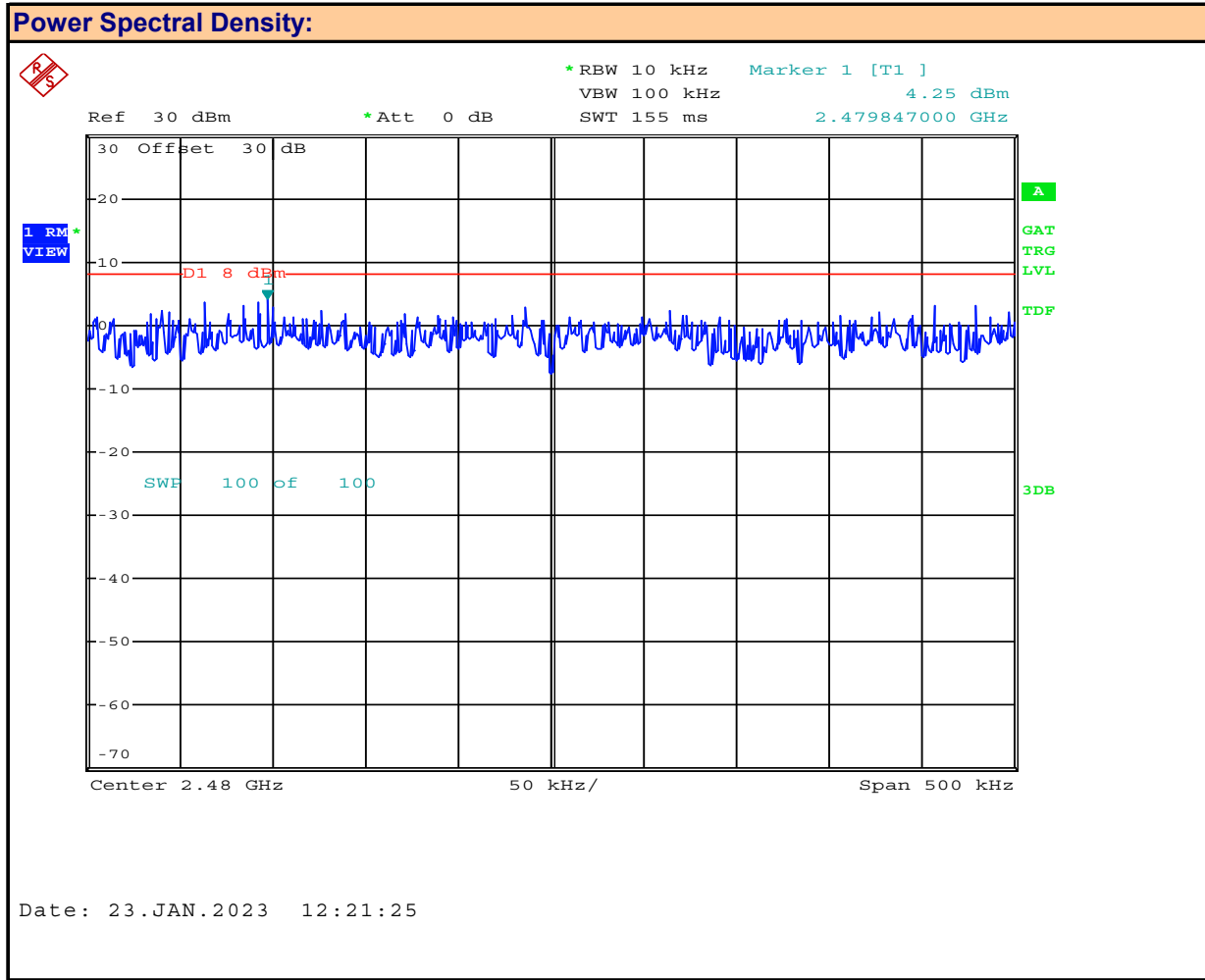

Channel:
 Mode:

Channel Frequency: MHz
 Modulation:
 Measured PSD: dBm

Table 11.2 – Summary of Power Spectral Density Measurements, (DSS)

Conducted Power Measurement Results:						
Channel Number	Channel Frequency (MHz)	Mode	Modulation	Measured PSD [P_{Meas}] (dBm)	Conducted Limit [P_{Lim}] (dBm)	Margin (dB)
38	2440.00	BT BR	GFSK	3.81	8.00	4.2
78	2480.00	BT 2EDR	pi/4-DQPSK	5.68		2.3
78	2480.00	BT 3EDR	8-DPSK	4.25		3.8
Result:						Complies

Conducted Margin = $P_{Limit} - P_{Meas}$

12.0 FHSS NUMBER OF HOPPING CHANNELS

Test Procedure

Normative	FCC 47 CFR §15.247, RSS-247
Reference	KDB 558074, ANSI C63.10

Limits

47 CFR §15.247(a)(1)	(iii) Frequency hopping systems in the 2400-2483.5 MHz band shall use at least 15 channels. The average time of occupancy on any channel shall not be greater than 0.4 seconds within a period of 0.4 seconds multiplied by the number of hopping channels employed. Frequency hopping systems may avoid or suppress transmissions on a particular hopping frequency provided that a minimum of 15 channels are used.
RSS-247 (5.1)(d)	5.1 Frequency hopping systems (FHS) The following applies to FHSs in each of the three bands: FHSs operating in the band 2400-2483.5 MHz shall use at least 15 hopping channels. The average time of occupancy on any channel shall not be greater than 0.4 seconds within a period of 0.4 seconds, multiplied by the number of hopping channels employed. Transmissions on particular hopping frequencies may be avoided or suppressed provided that at least 15 hopping channels are used.

Plot 12.1 – Number of Hopping Channels, BT BR

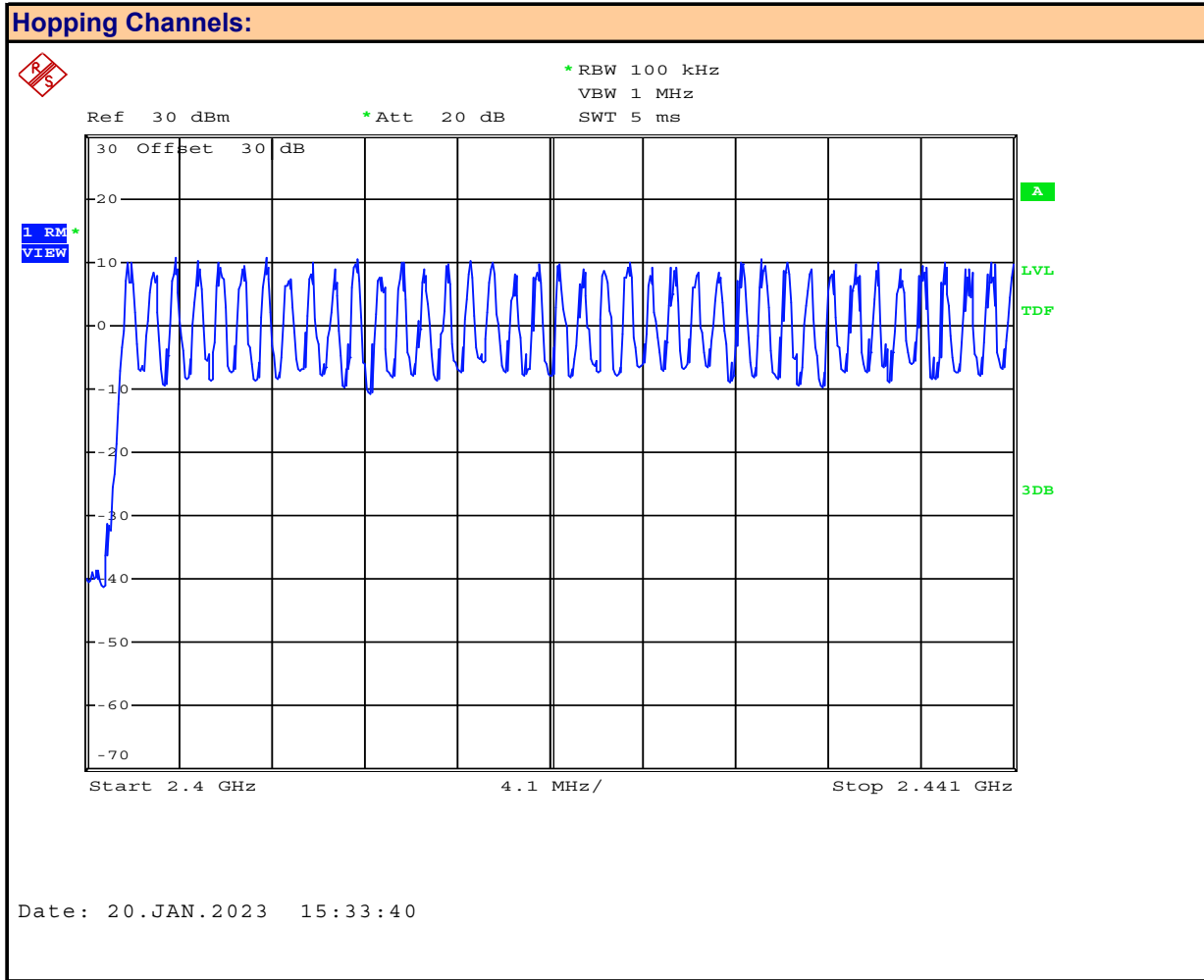

Channel:
 Mode:

Channel Frequency: MHz
 Modulation:
 Number of Hopping Channels

Plot 12.2 – Number of Hopping Channels, BT BR

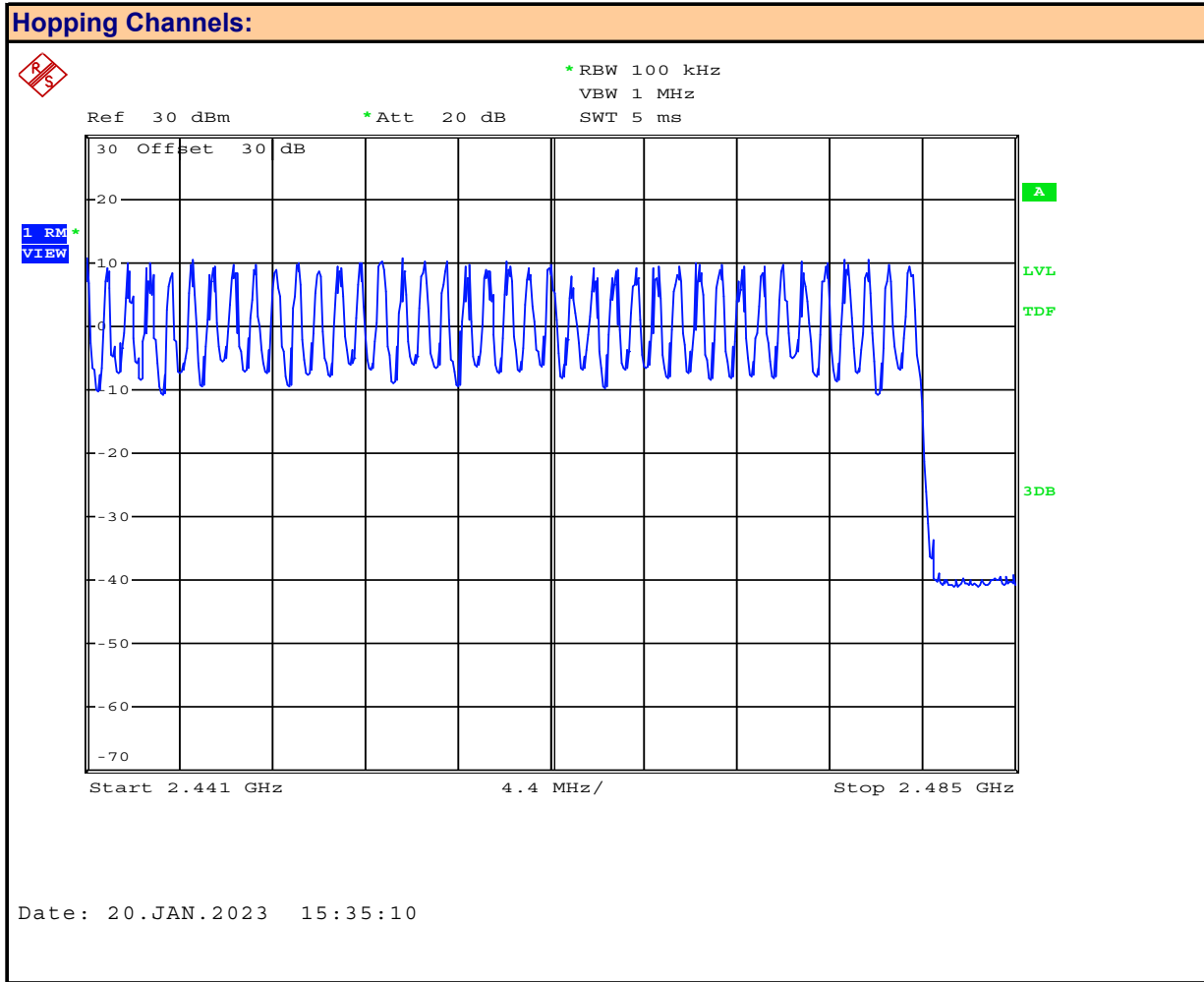

Channel:
 Mode:

Channel Frequency: MHz
 Modulation:
 Number of Hopping Channels

Plot 12.3 – Number of Hopping Channels, BT 2EDR

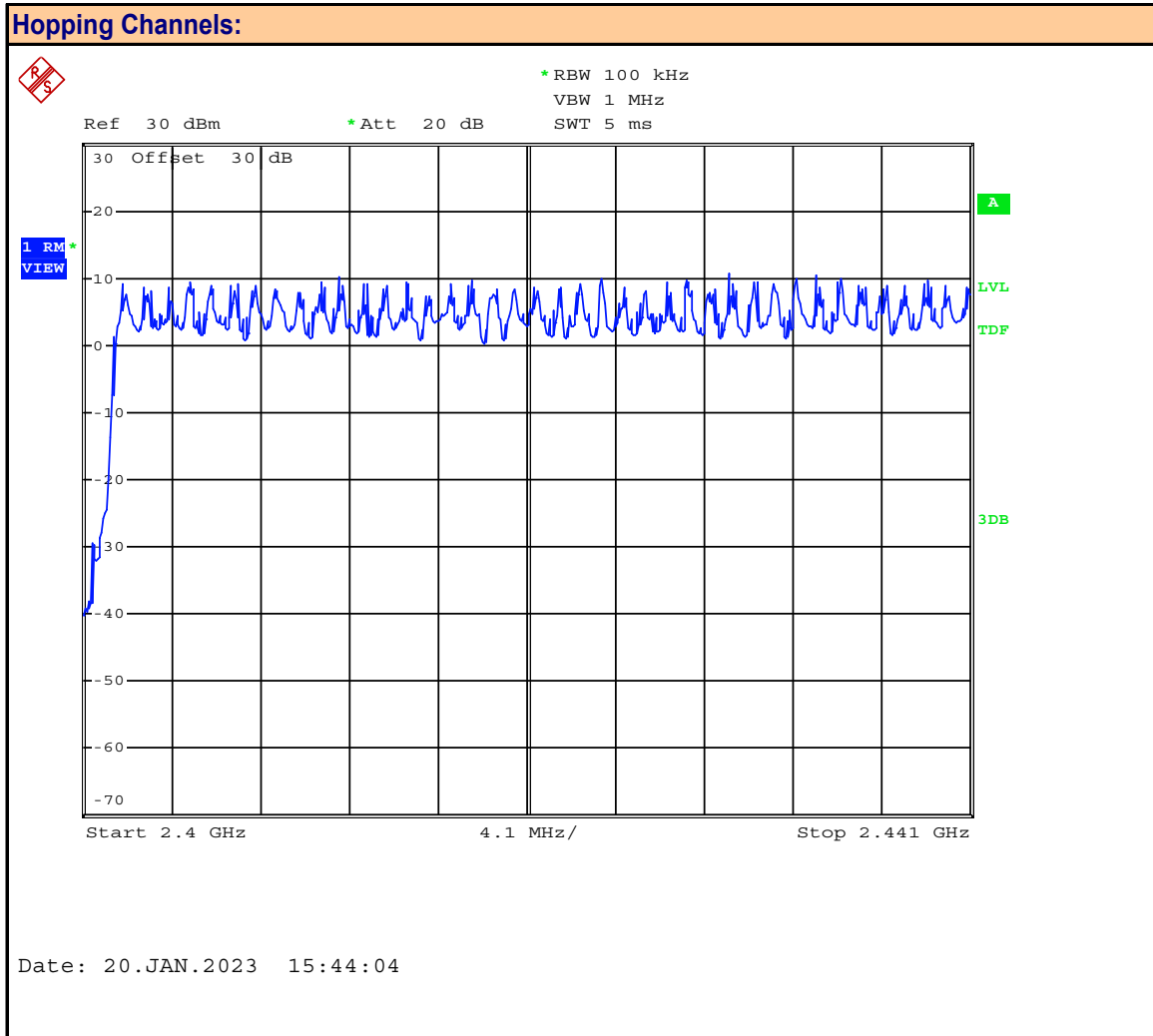

Channel:

Channel Frequency: MHz

Mode:

Modulation:

Number of Hopping Channels

Plot 12.4 – Number of Hopping Channels, BT 2EDR

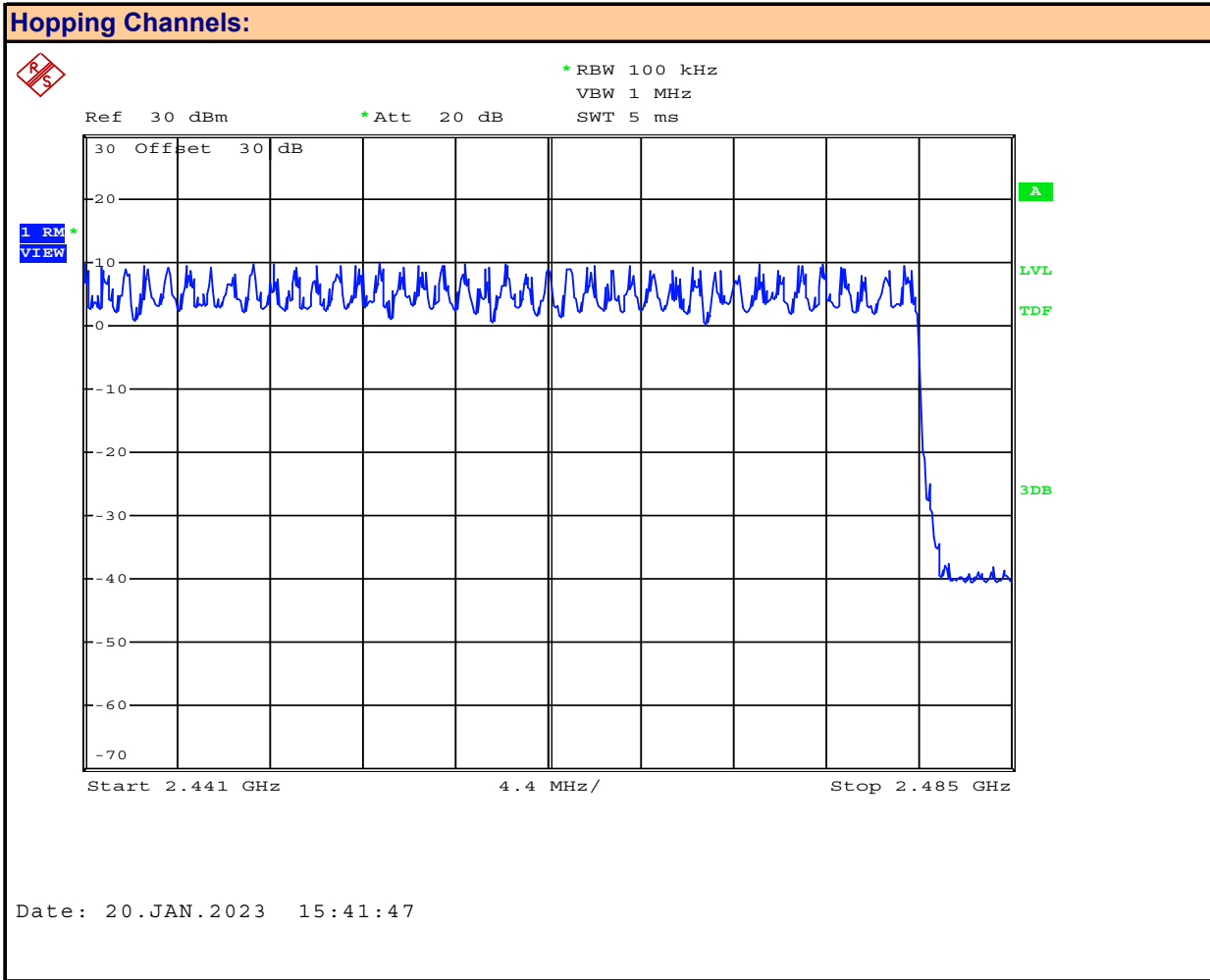

Channel:
 Mode:

Channel Frequency: MHz
 Modulation:
 Number of Hopping Channels

Table 12.2 – Summary of FHSS Number of Hopping Channels

Hopping Channel Results DSS		
Frequency Range (MHz)	Modulation	Number of Hopping Channels
2400-2441	Pi/4-DQPSK	40
2441-2485	Pi/4-DQPSK	39
Total:		79
2400-2441	GFSK	40
2441-2485	GFSK	39
Total:		79
Result:		Complies

13.0 FHSS CHANNEL SEPARATION

Test Procedure

Normative	FCC 47 CFR §15.247, RSS-247
Reference	KDB 558074, ANSI C63.10

Limits

47 CFR §15.247(a)(1)	(1) Frequency hopping systems shall have hopping channel carrier frequencies separated by a minimum of 25 kHz or the 20 dB bandwidth of the hopping channel, whichever is greater. Alternatively, frequency hopping systems operating in the 2400- 2483.5 MHz band may have hopping channel carrier frequencies that are separated by 25 kHz or two-thirds of the 20 dB bandwidth of the hopping channel, whichever is greater, provided the systems operate with an output power no greater than 125 mW.
RSS-247 (5.1)(db)	5.1 Frequency hopping systems (FHS) The following applies to FHSs in each of the three bands: FHSs shall have hopping channel carrier frequencies separated by a minimum of 25 kHz or the 20 dB bandwidth of the hopping channel, whichever is greater. Alternatively, FHSs operating in the band 2400-2483.5 MHz may have hopping channel carrier frequencies that are separated by 25 kHz or two thirds of the 20 dB bandwidth of the hopping channel, whichever is greater, provided that the systems operate with an output power no greater than 0.125 W.

Plot 13.1 – 20dB BW, BT BR



Channel:
 Mode:

Channel Frequency: MHz
 Modulation:
 Measured 20dB Bandwidth: MHz

Plot 13.2 – FHSS Channel Separation, BT BR

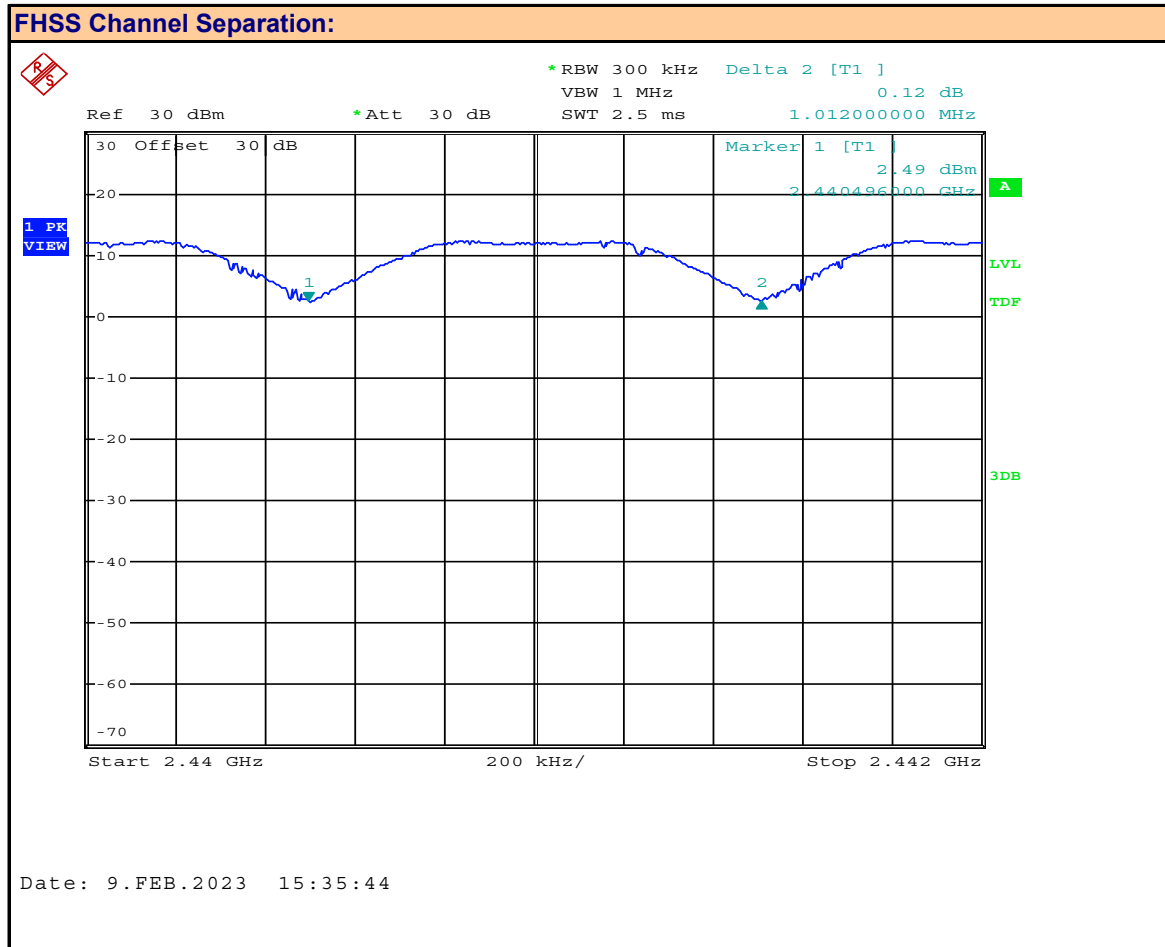

Channel:
 Mode:

Channel Frequency: MHz
 Modulation:
 Measured Channel Separation: MHz

Plot 13.3 – 20dB BW, BT 2EDR

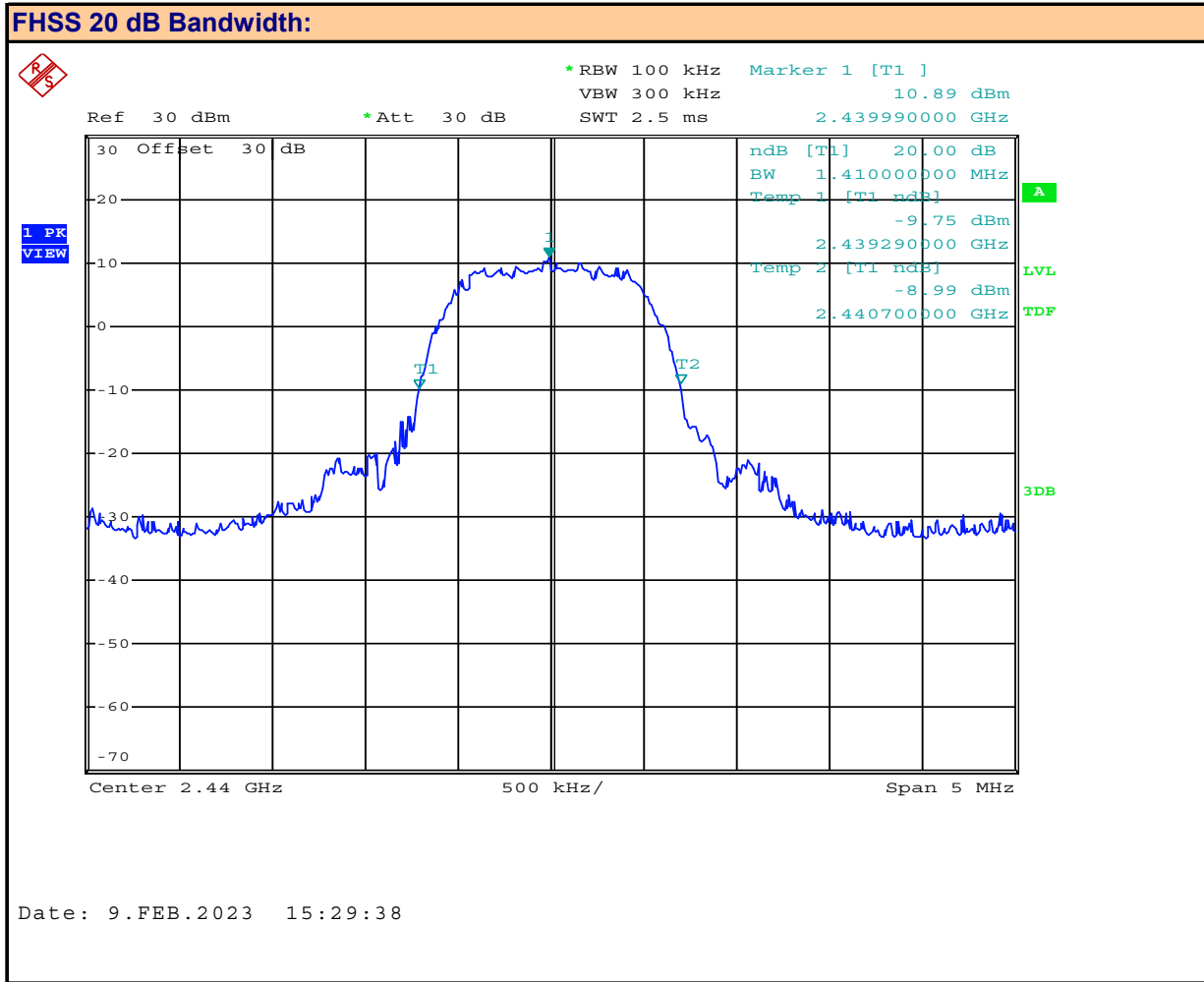

Channel:
 Mode:

Channel Frequency: MHz
 Modulation:
 Measured 20dB Bandwidth: MHz

Plot 13.4 – FHSS Channel Separation, BT 2EDR

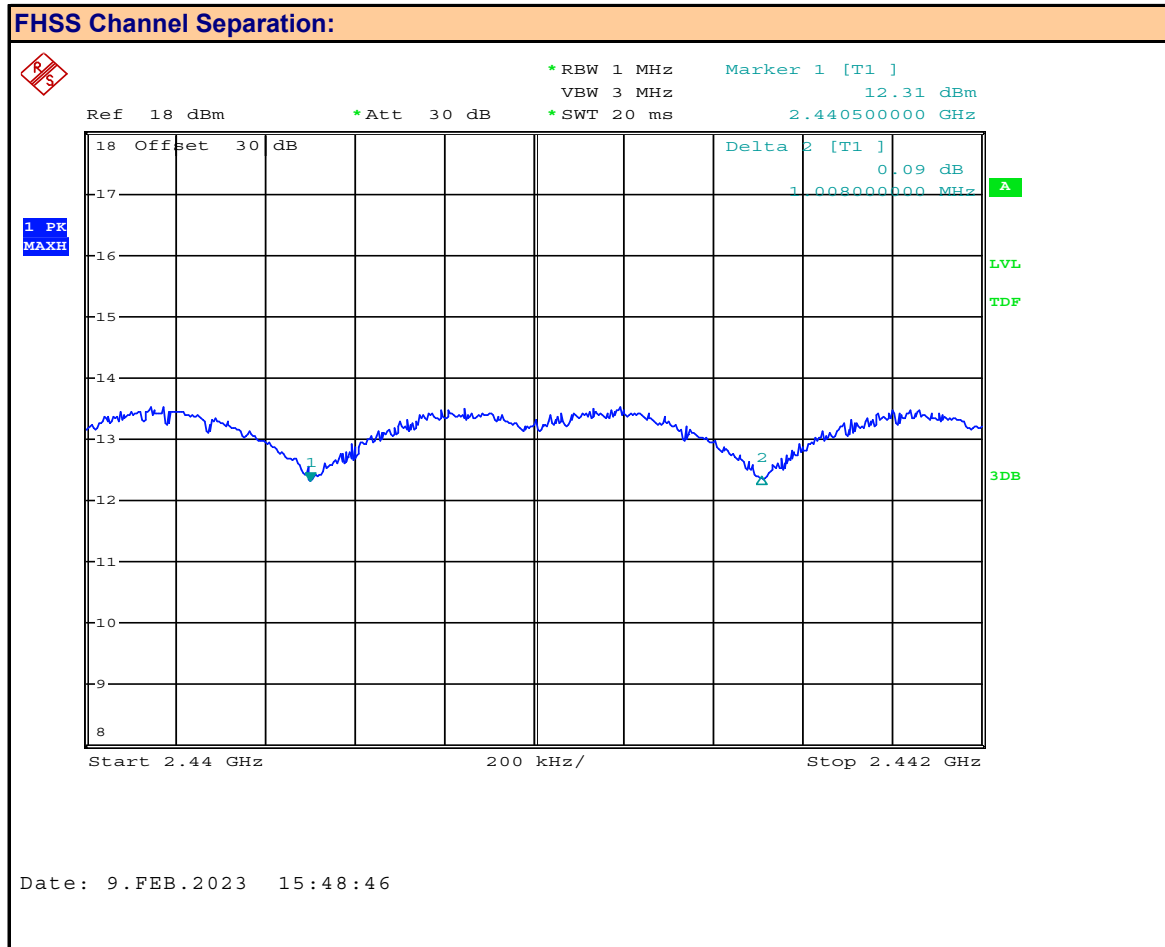

Channel:
 Mode:

Channel Frequency: MHz
 Modulation:
 Measured Channel Separation: MHz

Table 13.1 – Summary of FHSS Channel Separation

Hopping Channel Separation Results DSS				
Modulation	20dB BW (MHz)	Channel Separation (MHz)	Minimum Bandwidth (MHz)	Margin (MHz)
8-DPSK	1.14	1.012	0.760	0.252
Pi/4-DQPSK	1.41	1.008	0.940	0.068
Result:				Complies

Minimum Bandwidth = 20dB BW X 2/3

Margin = Channel Separation - Minimum Bandwidth

14.0 FHSS TIME OF OCCUPANCY

Test Procedure

Normative	FCC 47 CFR §15.247, RSS-247
Reference	KDB 558074, ANSI C63.10

Limits

47 CFR §15.247(a)(1)	(iii) Frequency hopping systems in the 2400-2483.5 MHz band shall use at least 15 channels. The average time of occupancy on any channel shall not be greater than 0.4 seconds within a period of 0.4 seconds multiplied by the number of hopping channels employed. Frequency hopping systems may avoid or suppress transmissions on a particular hopping frequency provided that a minimum of 15 channels are used.
RSS-247 (5.1)(d)	5.1 Frequency hopping systems (FHS) FHSs operating in the band 2400-2483.5 MHz shall use at least 15 hopping channels. The average time of occupancy on any channel shall not be greater than 0.4 seconds within a period of 0.4 seconds, multiplied by the number of hopping channels employed. Transmissions on particular hopping frequencies may be avoided or suppressed provided that at least 15 hopping channels are used.

Plot 14.1 – Time of Occupancy, DH1, 2-DH1, 3-DH1, DM1

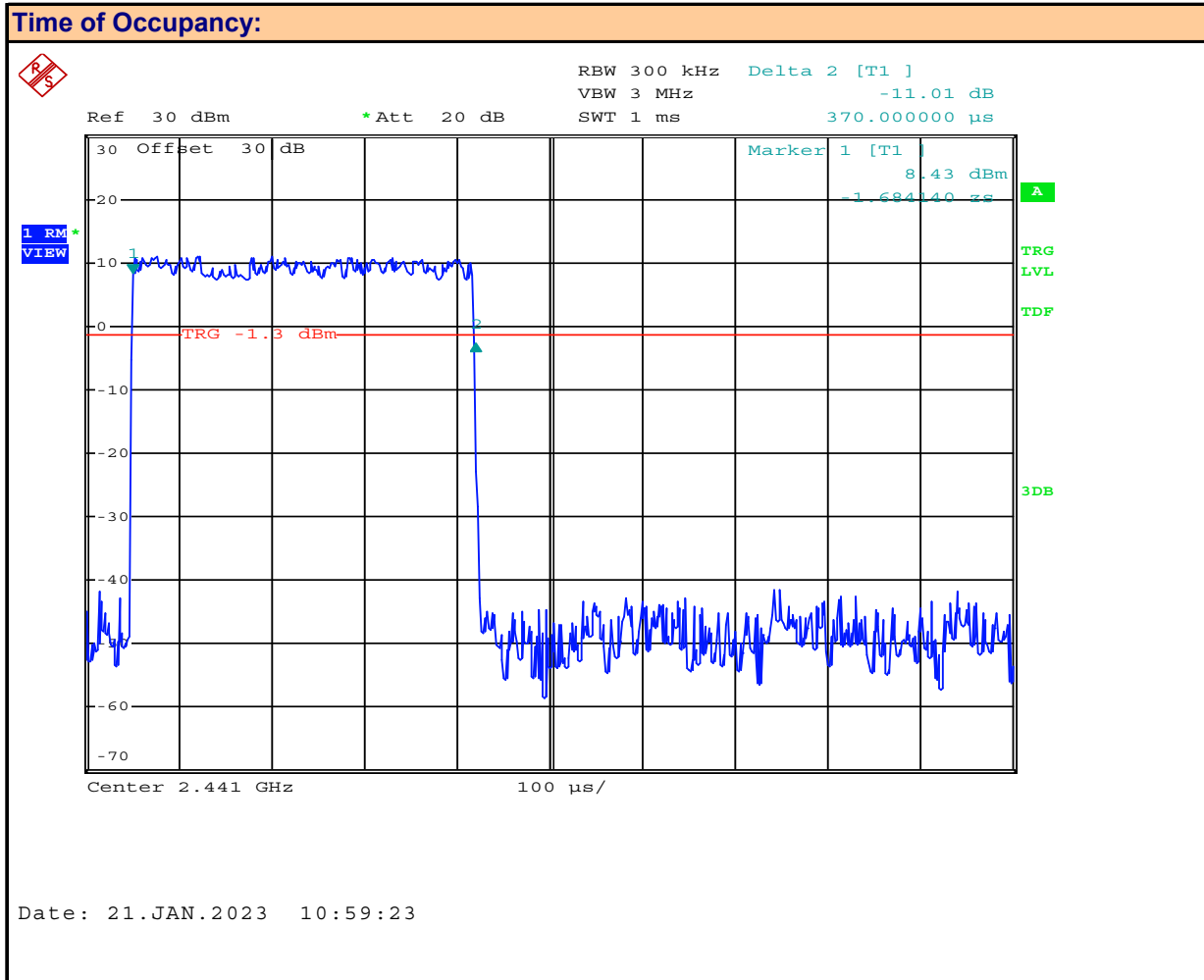

Packet: **DH1, DM1, 2-DH1, 3-DH1**

Measured On-Time: **370** μ Sec

Plot 14.2 – Time of Occupancy, DH1, 2-DH1, 3-DH1, DM1

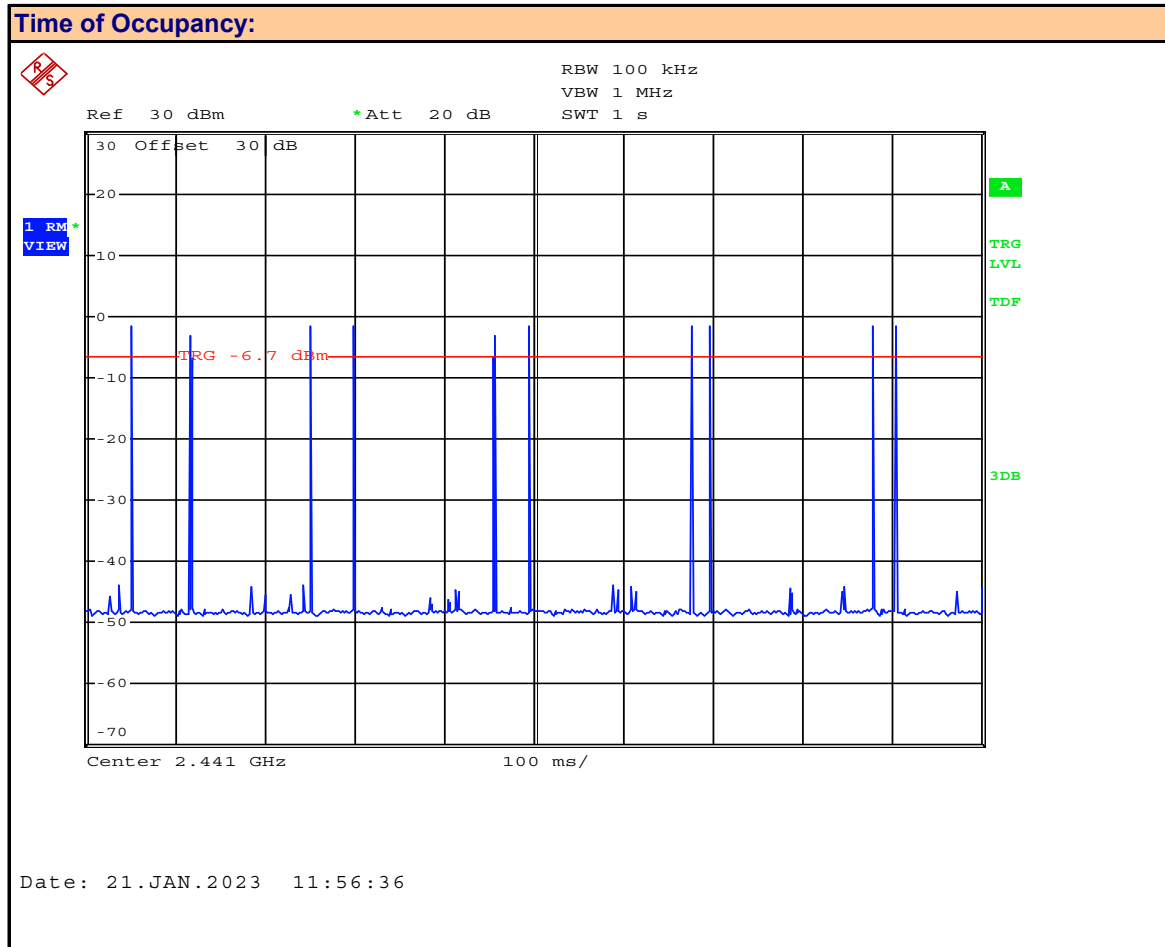

Packet: **DH1, DM1, 2-DH1, 3-DH1**

Transmit Count **10** /1000mSec

Plot 14.3 – Time of Occupancy, DH3, 2-DH3, 3-DH3, DM3

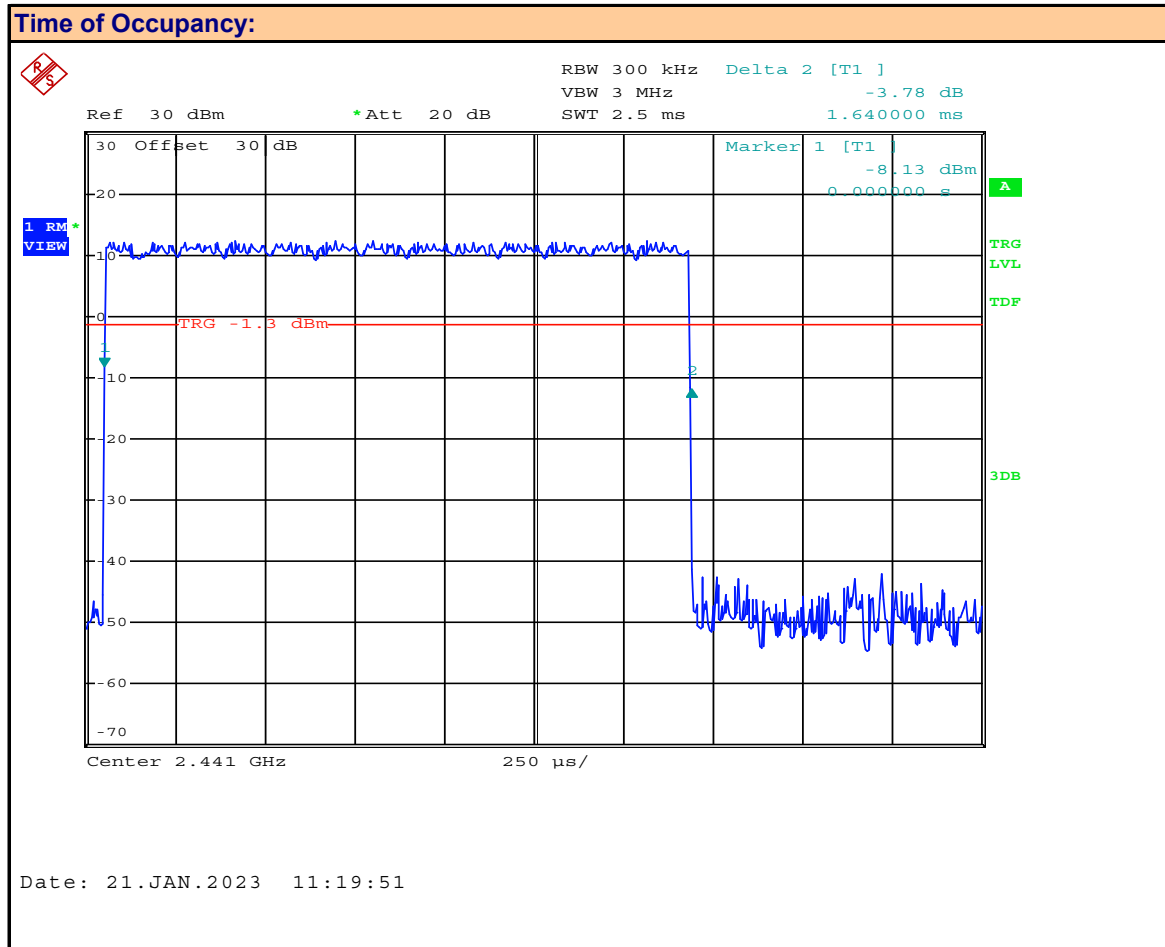

Packet: **DH3, DM3, 2-DH3, 3-DH3**

Measured On-Time: **1.64** mSec

Plot 14.4 – Time of Occupancy, DH3, 2-DH3, 3-DH3, DM3

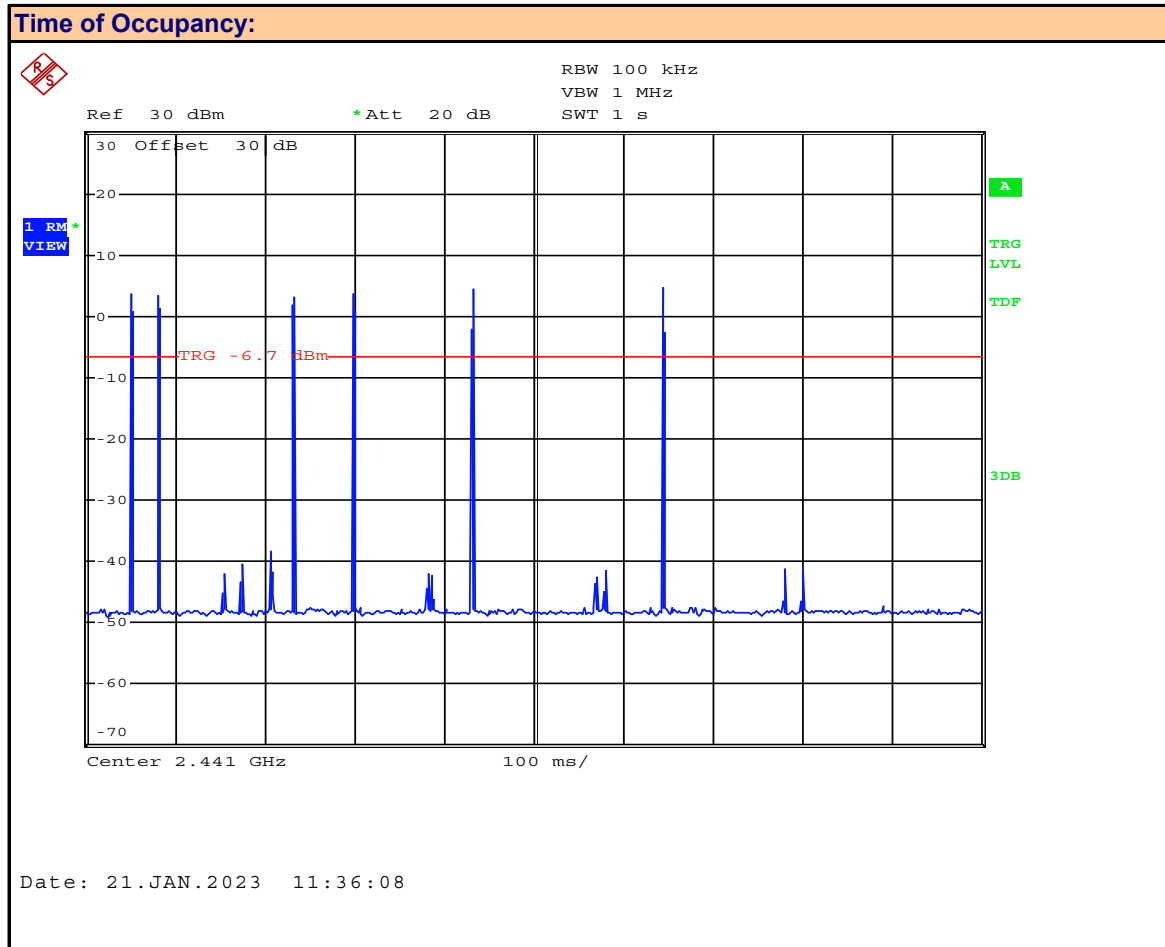

Packet: **DH3, DM3, 2-DH3, 3-DH3**

Transmit Count **6** /1000mSec

Plot 14.5 – Time of Occupancy, DH5, 2-DH5, 3-DH5, DM5

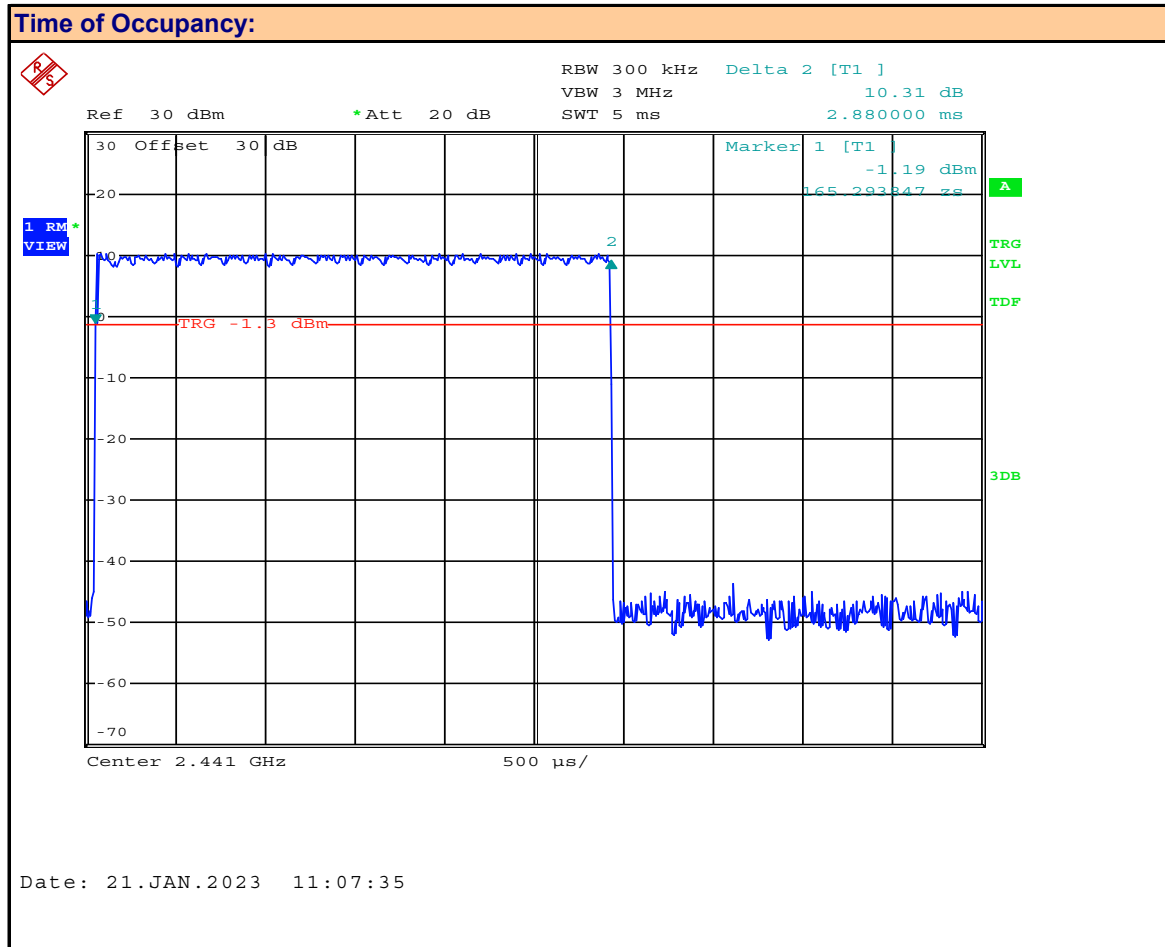

Packet: **DH5, DM5, 2-DH5, 3-DH5**

Measured On-Time: **2.88** mSec

Plot 14.6 – Time of Occupancy, DH5, 2-DH5, 3-DH5, DM5

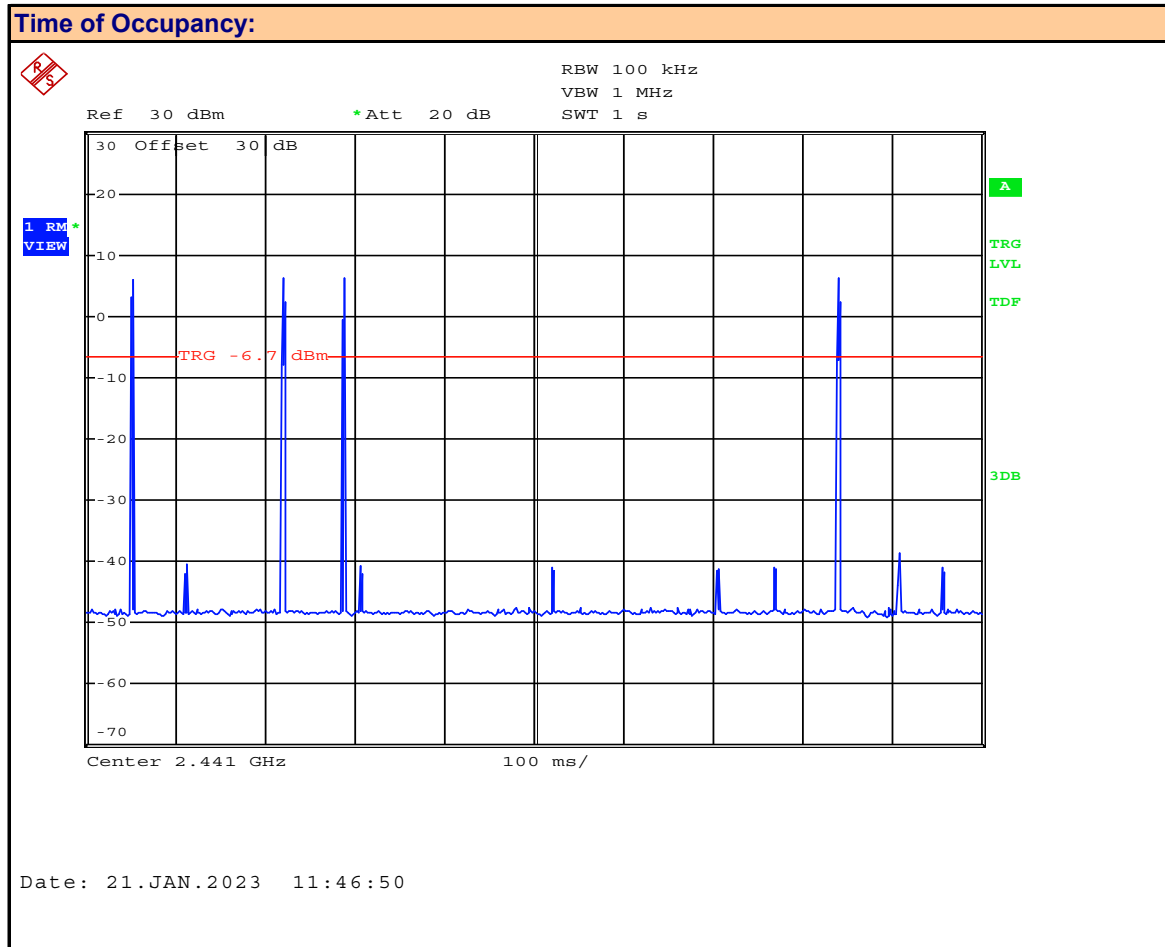

Packet: **DH5, DM5, 2-DH5, 3-DH5**

Transmit Count **4** /100mSec

Plot 14.7 – Time of Occupancy, EV4

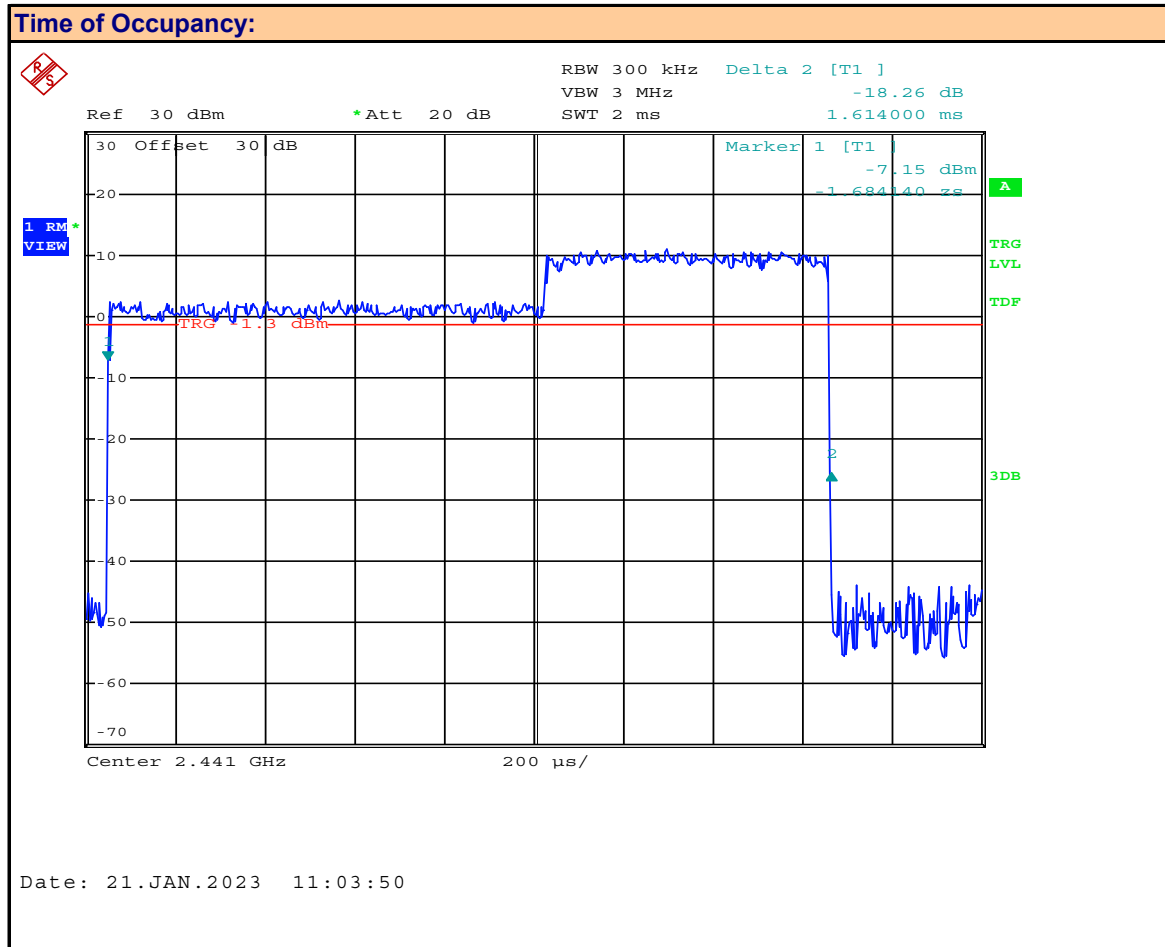

Packet: **EV4**

Measured On-Time: **1.614** mSec

Plot 14.8 – Time of Occupancy, EV4

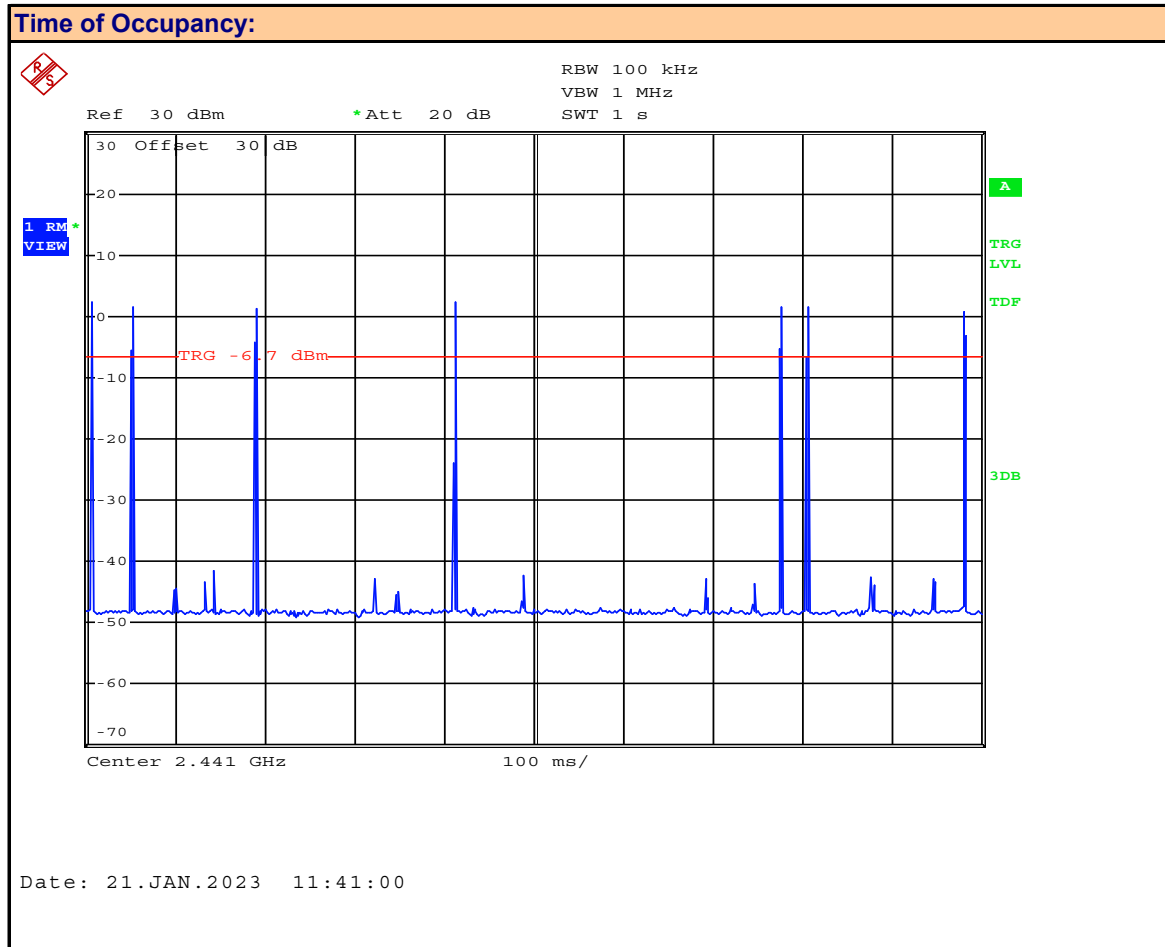

Packet: **EV4**

Transmit Count **7** /100mSec

Plot 14.9 – Time of Occupancy, EV5

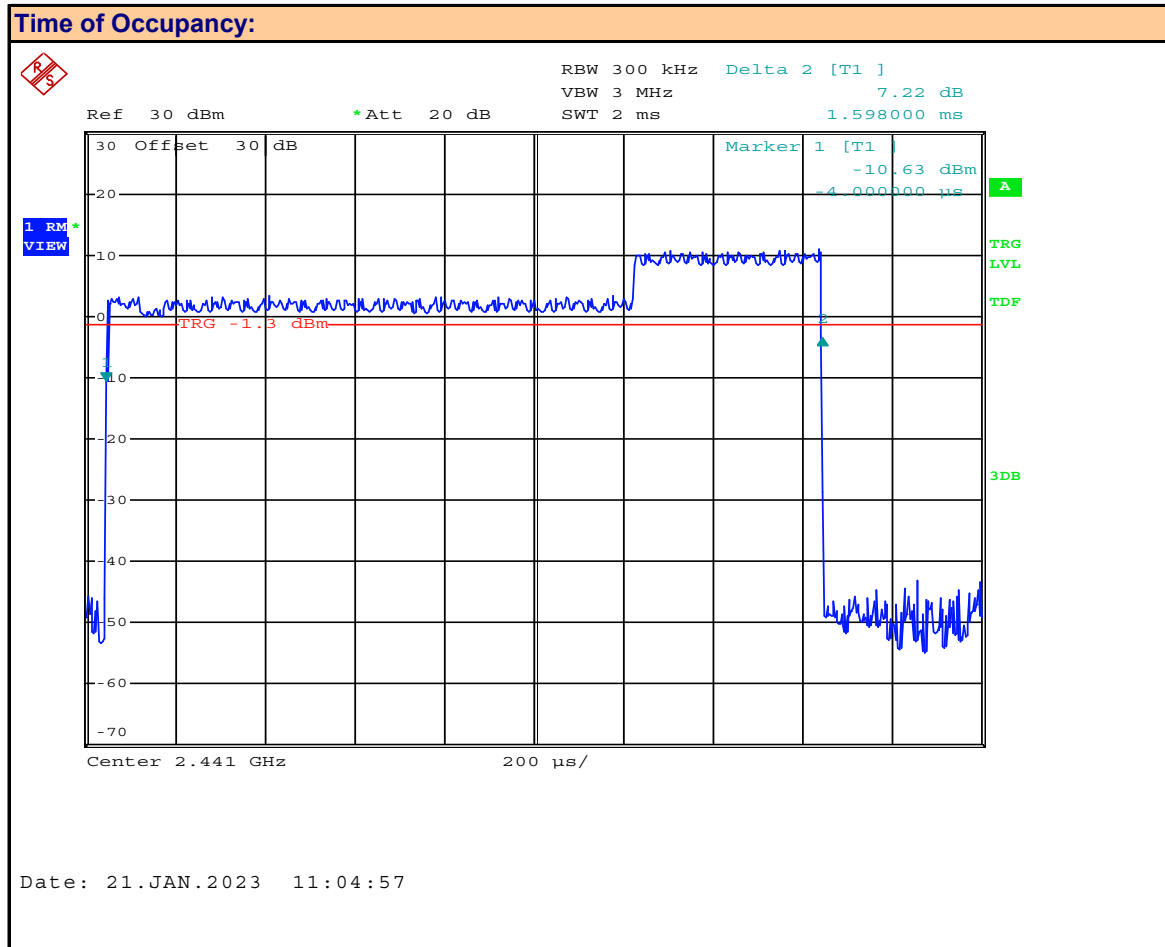

Packet: **EV5**

Measured On-Time: **1.598** mSec

Plot 14.10 – Time of Occupancy, EV5

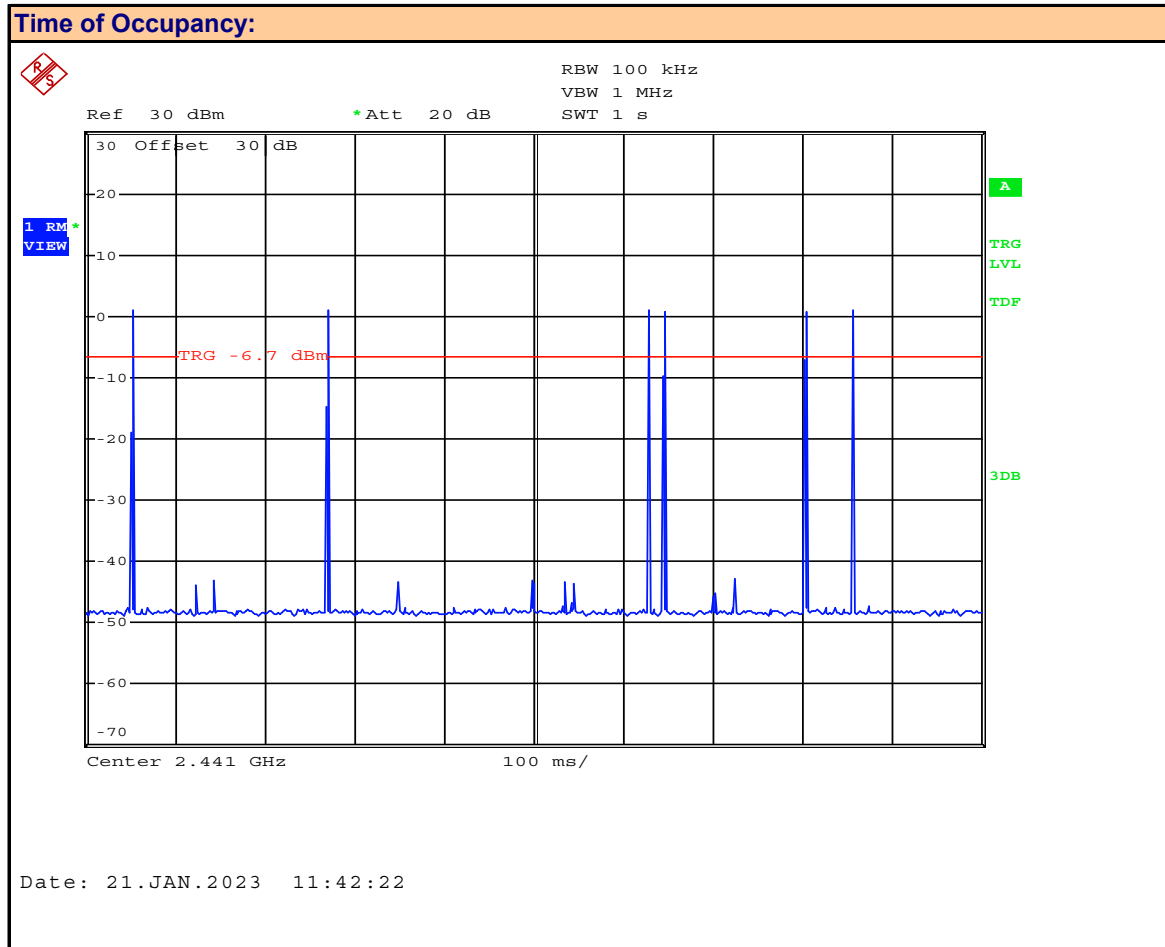

Packet: **EV5**

Transmit Count **6** /1000mSec

Table 14.1 – Summary of FHSS Time of Occupancy

Accumulated Time of Occupancy										
Channel Frequency (MHz)	Packet	Channel On Time [t _{on}] (mSec)	Number of Transmits per Period [N _{Tx}]	Time of Period Occupancy [T _{Occ}] (mSec)	Observation Period [T _P] (mSec)	Number of Hopping Channels [N _{Hop}]	Required Observation Period [T _{Rqd}] (mSec)	Accumulated Time of Occupancy [T _{Acc}] (mSec)	Limit [Limit] (mSec)	Margin (mSec)
2441	DH1	0.370	10	3.700	1000	79	31600	116.92	400	283
	DH3	1.640	6	9.840				310.94		89
	DH5	2.880	4	11.520				364.03		36
	EV4	1.614	7	11.298				357.02		43
	DH5	1.598	6	9.588				302.98		97
Result:									Complies	

Time of Period Occupancy [T_{POcc}] = Channel On Time [t_{on}] x Number of Transmits per Period [N_{Tx}]

Required Observation Period [T_{Rqd}] = Number of Hopping Channels [N_{Hop}] x 0.4Sec (400mSec)

Accumulated Time of Occupancy [T_{Acc}] = Time of Period Occupancy [T_{Occ}] x Required Observation Period [T_{Rqd}] / Observation Period [T_P]

Margin = Limit - [T_{Acc}]

15.0 CONDUCTED SPURIOUS EMISSIONS -BAND EDGE

Test Procedure

Normative Reference	FCC 47 CFR §2.1051, §15.247(d), RSS-Gen (6.13), RSS-247 (5.5),
	KDB 558074 (11.3), ANSI C63.10 (11.11.3)

Limits

47 CFR §15.247(d)	(d) In any 100 kHz bandwidth outside the frequency band in which the spread spectrum or digitally modulated intentional radiator is operating, the radio frequency power that is produced by the intentional radiator shall be at least 20 dB below that in the 100 kHz bandwidth within the band that contains the highest level of the desired power, based on either an RF conducted or a radiated measurement, provided the transmitter demonstrates compliance with the peak conducted power limits. If the transmitter complies with the conducted power limits based on the use of RMS averaging over a time interval, as permitted under paragraph (b)(3) of this section, the attenuation required under this paragraph shall be 30 dB instead of 20 dB. Attenuation below the general limits specified in §15.209(a) is not required.
KDB 558074 (11.3) C63.10 (11.11.3)	<p>11.1 General</p> <p>The DTS rules specify that in any 100 kHz bandwidth outside of the authorized frequency band, the power shall be attenuated according to the following conditions:</p> <p>b) If maximum conducted (average) output power was used to demonstrate compliance as described in 9.2, then the peak power in any 100 kHz bandwidth outside of the authorized frequency band shall be attenuated by at least 30 dB relative to the maximum in-band peak PSD level in 100 kHz (i.e., 30 dBc).</p> <p>11.2 Reference level measurement</p> <p>a) Set instrument center frequency to DTS channel center frequency.</p> <p>b) Set the span to $\geq 1.5 \times DTS \text{ bandwidth}$.</p> <p>c) Set the RBW = 100 kHz.</p> <p>d) Set the VBW $\geq 3 \times RBW$.</p> <p>e) Detector = peak.</p> <p>f) Sweep time = auto couple.</p> <p>g) Trace mode = max hold.</p> <p>h) Allow trace to fully stabilize.</p> <p>i) Use the peak marker function to determine the maximum PSD level.</p> <p>Note that the channel found to contain the maximum PSD level can be used to establish the reference</p>

Plot 15.1 – Band Edge, 802.11b

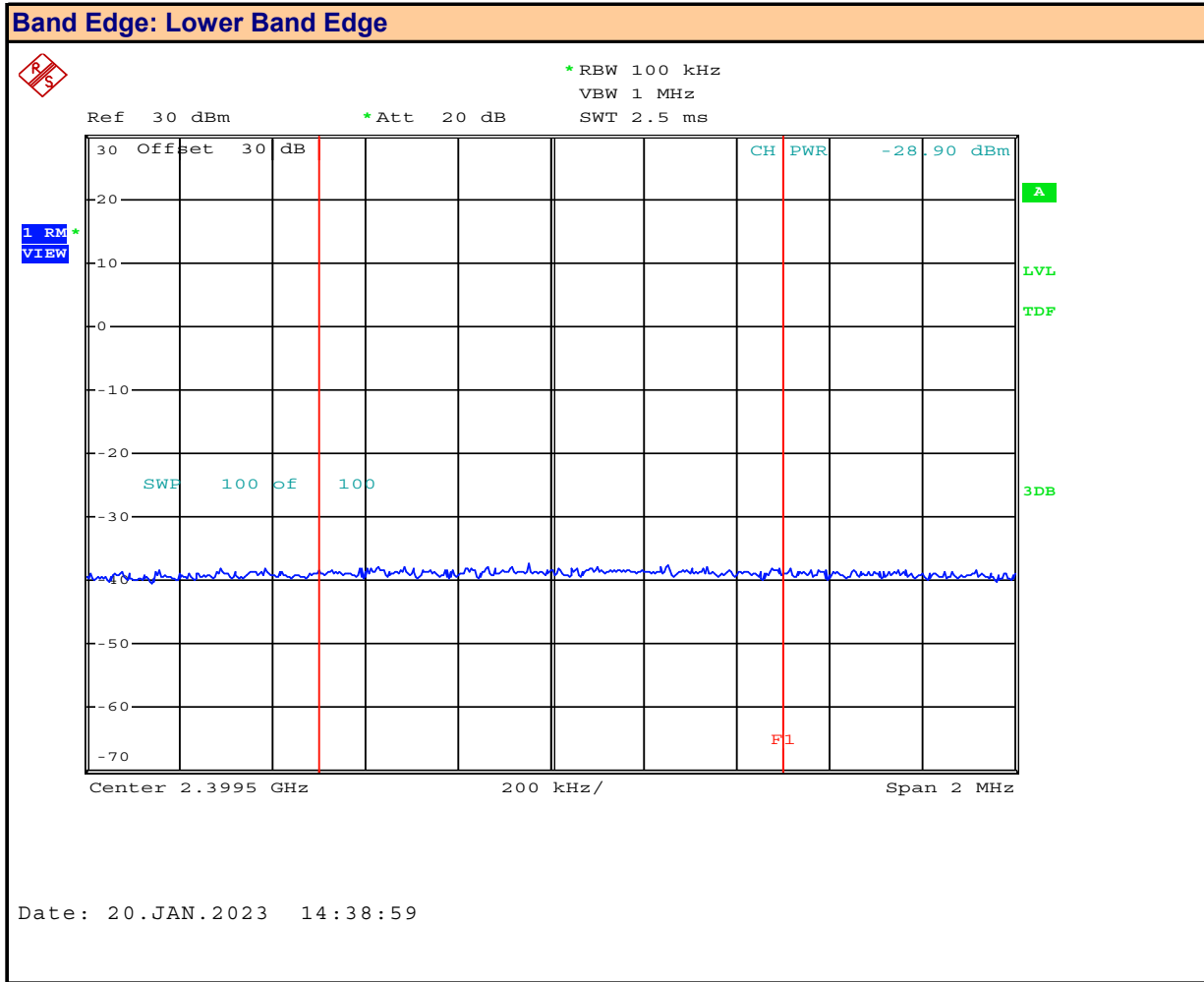

Channel:
 Mode:

Channel Frequency: MHz
 Modulation:
 Emission Power: dBm

Plot 15.2 – Band Edge, 802.11b

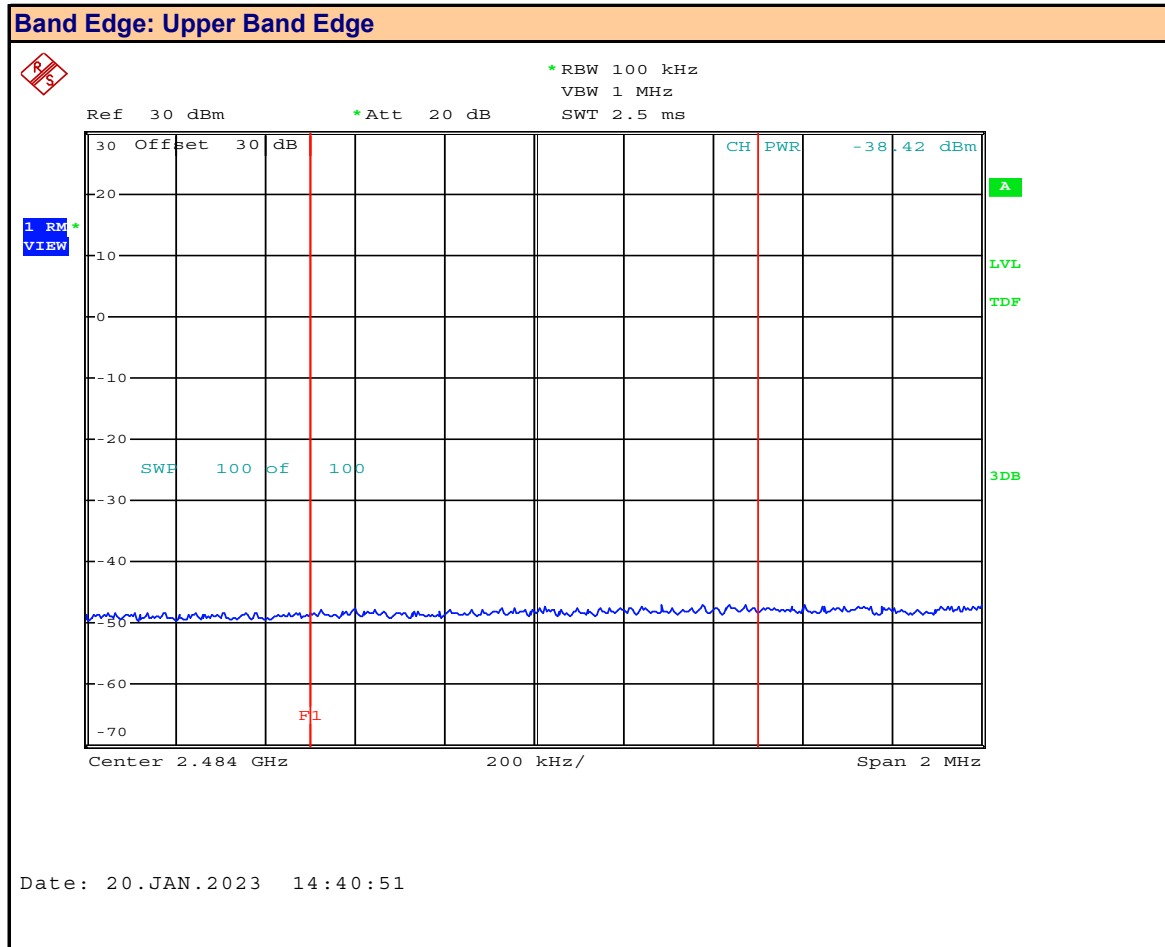

Channel:
 Mode:

Channel Frequency: MHz
 Modulation:
 Emission Power: dBm

Plot 15.3 – Band Edge, 802.11g

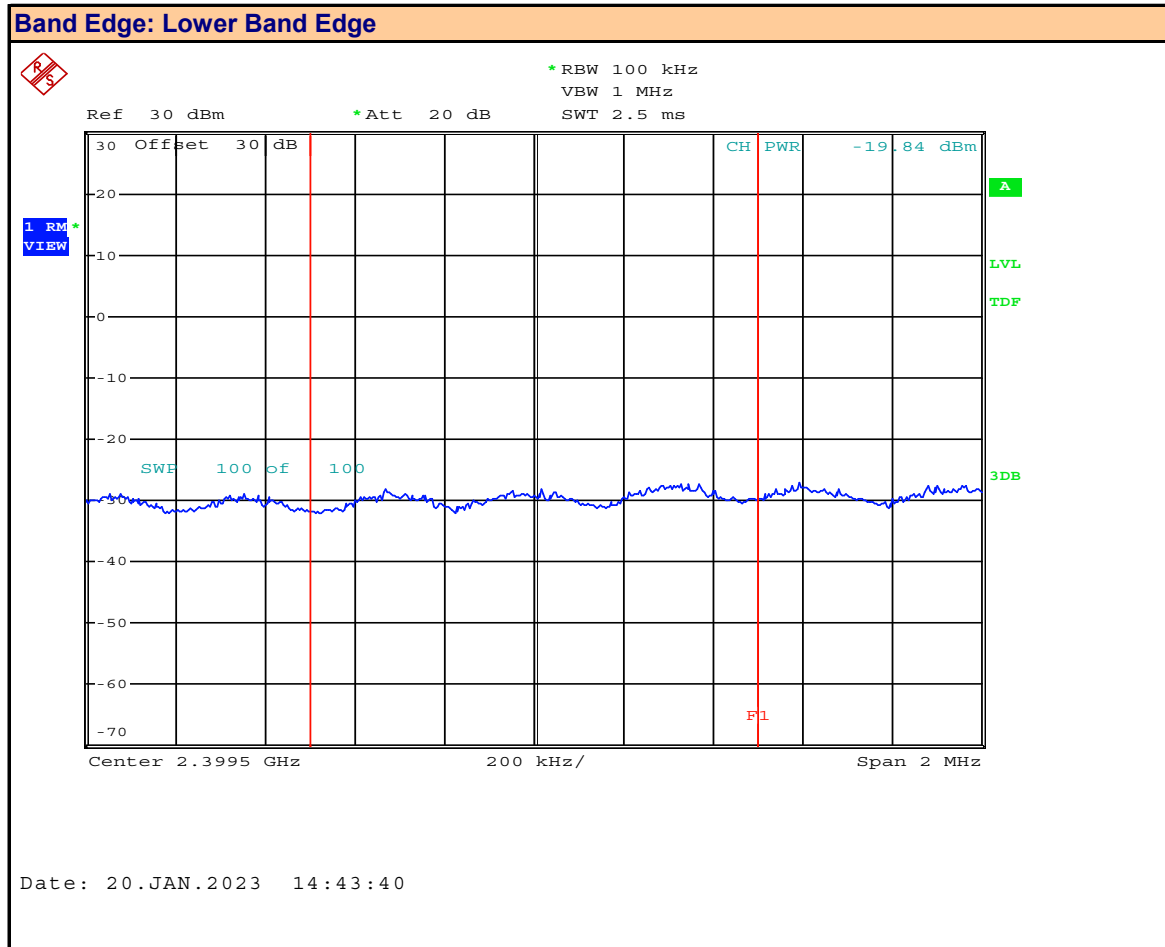

Channel:
 Mode:

Channel Frequency: MHz
 Modulation:
 Emission Power: dBm

Plot 15.4 – Band Edge, 802.11g



Channel:
 Mode:

Channel Frequency: MHz
 Modulation:
 Emission Power: dBm

Plot 15.5 – Band Edge, 802.11n

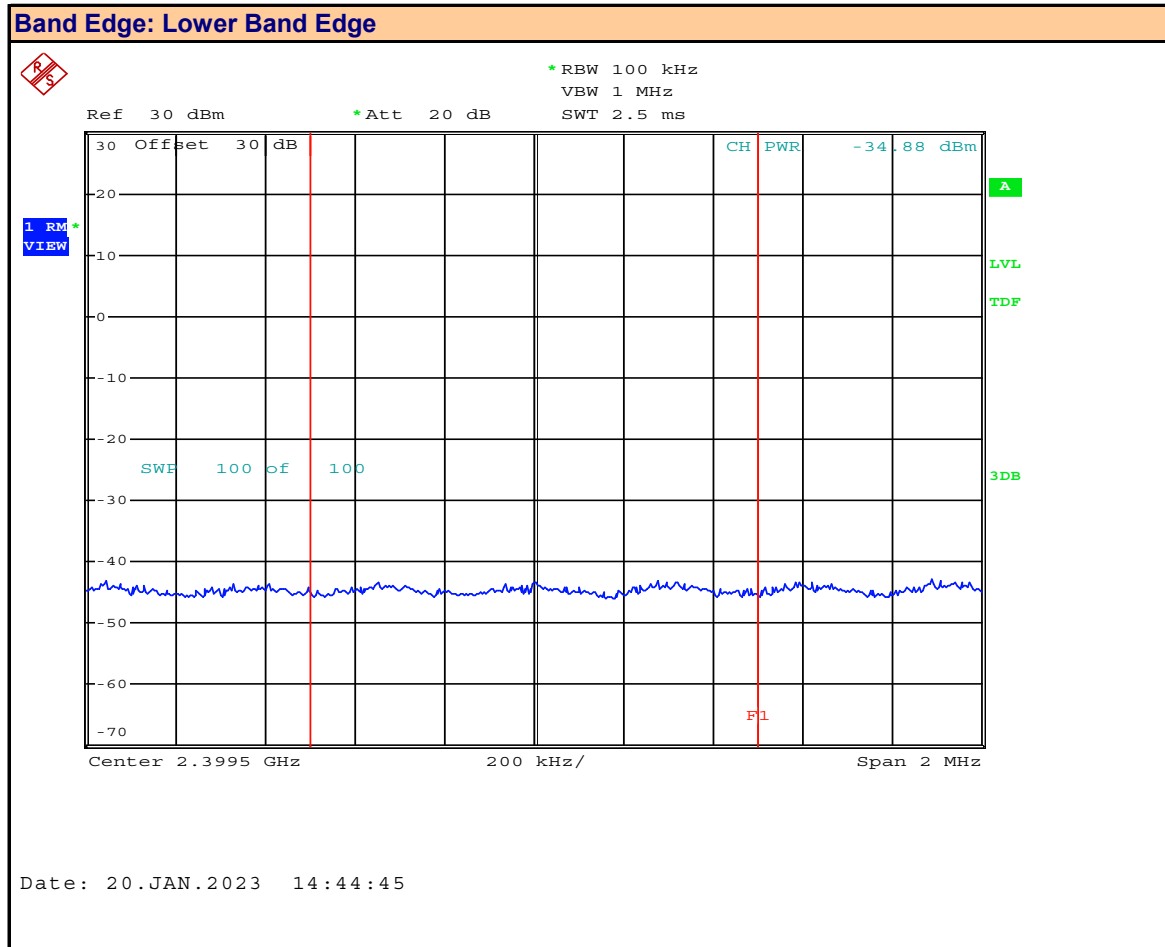

Date: 20.JAN.2023 14:44:45

Channel:
 Mode:

Channel Frequency: MHz
 Modulation:
 Emission Power: dBm

Plot 15.6 – Band Edge, 802.11n

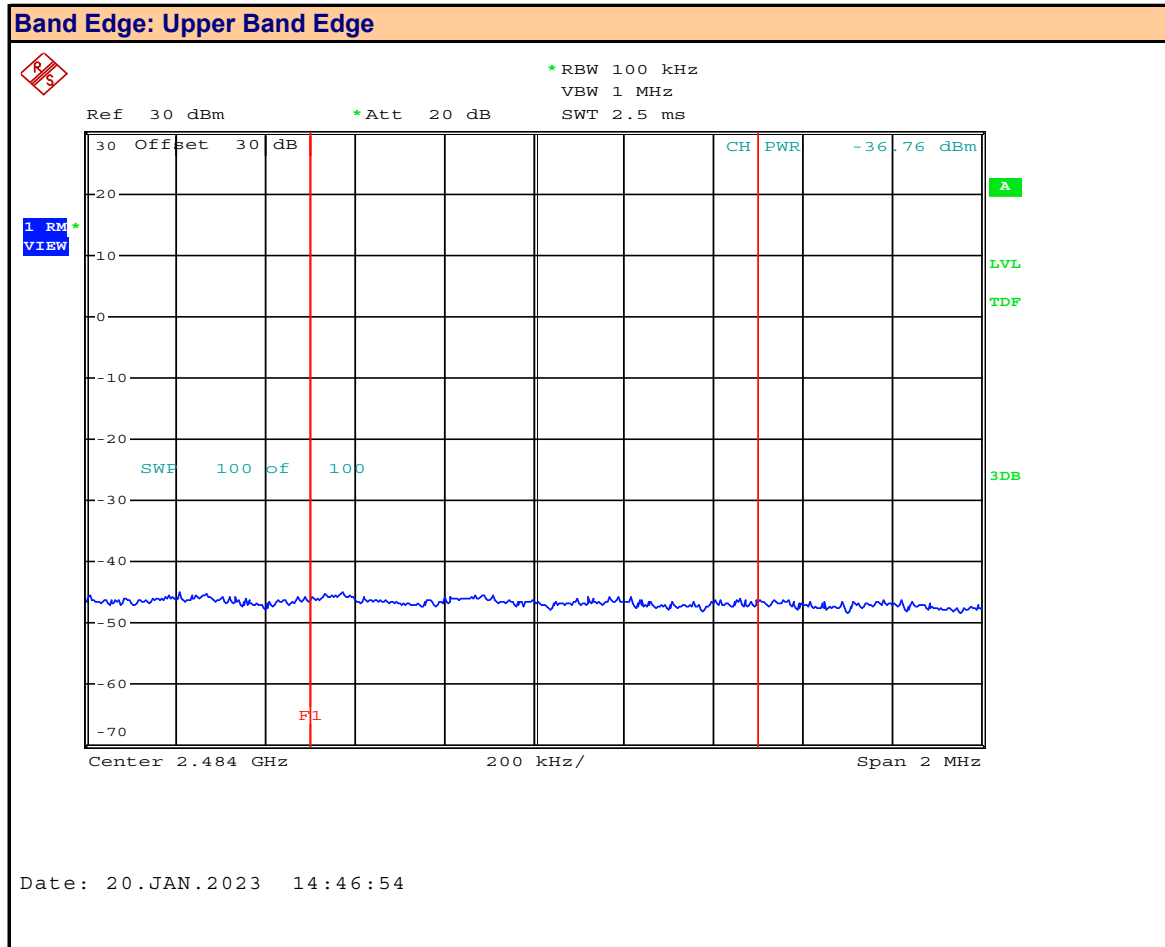

Channel:
 Mode:

Channel Frequency: MHz
 Modulation:
 Emission Power: dBm

Table 15.1 – Summary of Spurious Emission Measurements – Band Edge, (DTS)

Band Edge Measurement Results: 802.11											
Mode	Channel Number	Frequency (MHz)	Modulation	Emission Power [P _{Em}] (dBm)	Antenna Gain [G _T] (dBi)	Emission EIRP [E _{Em}] (dBm)	Fundamental Power [P _{Fund}] (dBm)	Fundamental EIRP [E _{Fund}] (dBm)	Attenuation [Atten] (dB)	Limit (dB)	Margin (dB)
802.11b	1	2402.00	DSSS 5.5	-28.90	-5.06	-33.96	17.12	12.06	46.02	30	16.0
	11	2462.00		-38.42		-43.48	17.12	12.06	55.54	30	25.5
802.11g	1	2402.00	OFDM12	-19.84		-24.90	17.78	12.72	37.62	30	7.6
	11	2462.00		-26.66		-31.72	17.78	12.72	44.44	30	14.4
802.11n	1	2402.00	MCS0	-34.88		-39.94	15.80	10.74	50.68	30	20.7
	11	2462.00		-36.76		-41.82	15.80	10.74	52.56	30	22.6
									Result:	Complies	

Emission [E_{Em}] = [P_{Em}] + [G_T]

Fundamental EIRP [E_{Fund}] = [P_{Fund}] + [G_T]

Attenuation [Atten] = [E_{Fund}] - [E_{Em}]

Margin = Attenuation - Limit

Plot 15.7 – Band Edge, BT BR

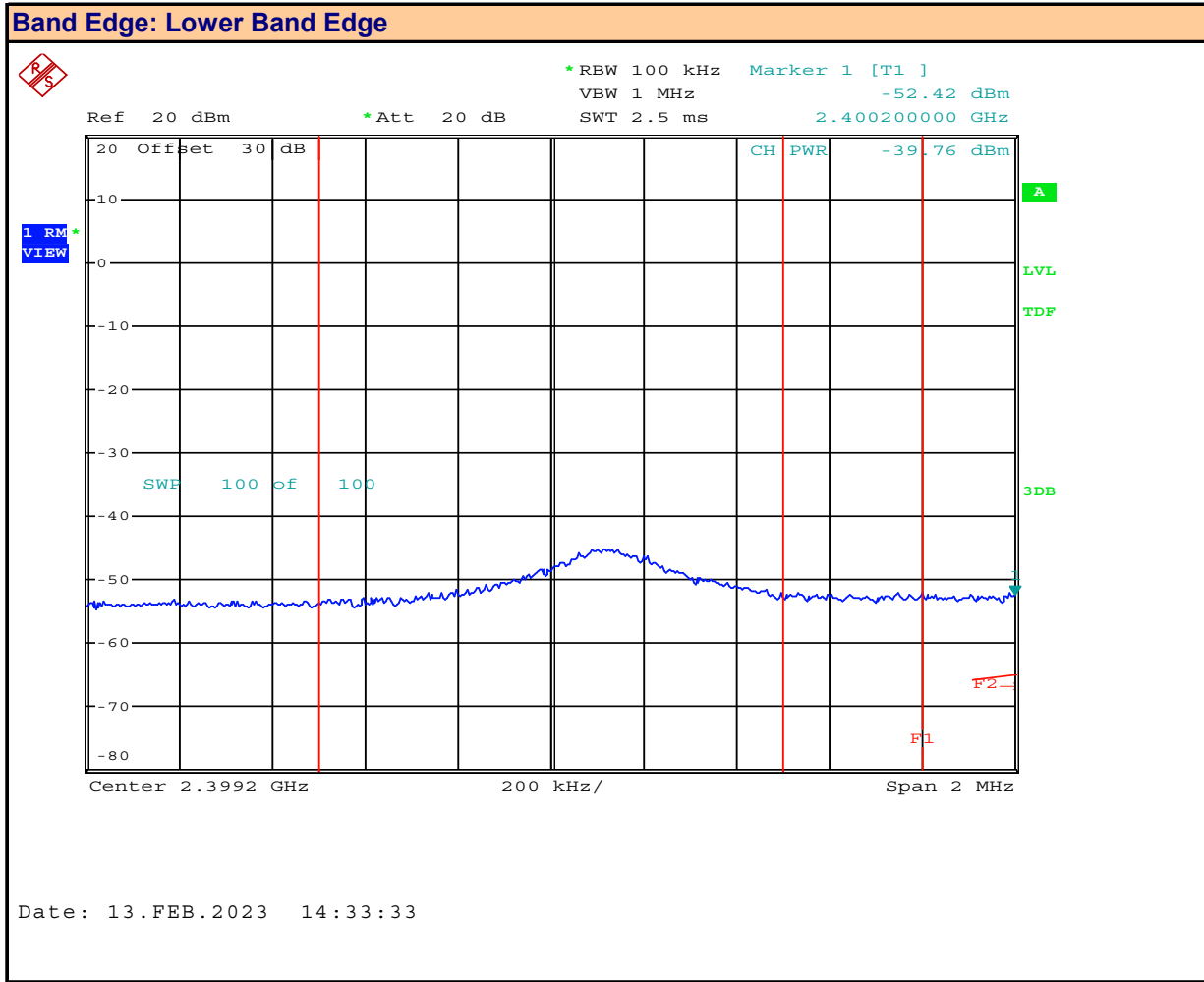

Channel:
 Mode:

Channel Frequency: MHz
 Modulation:
 Emission Power: dBm

Plot 15.9 – Band Edge, BT 2EDR

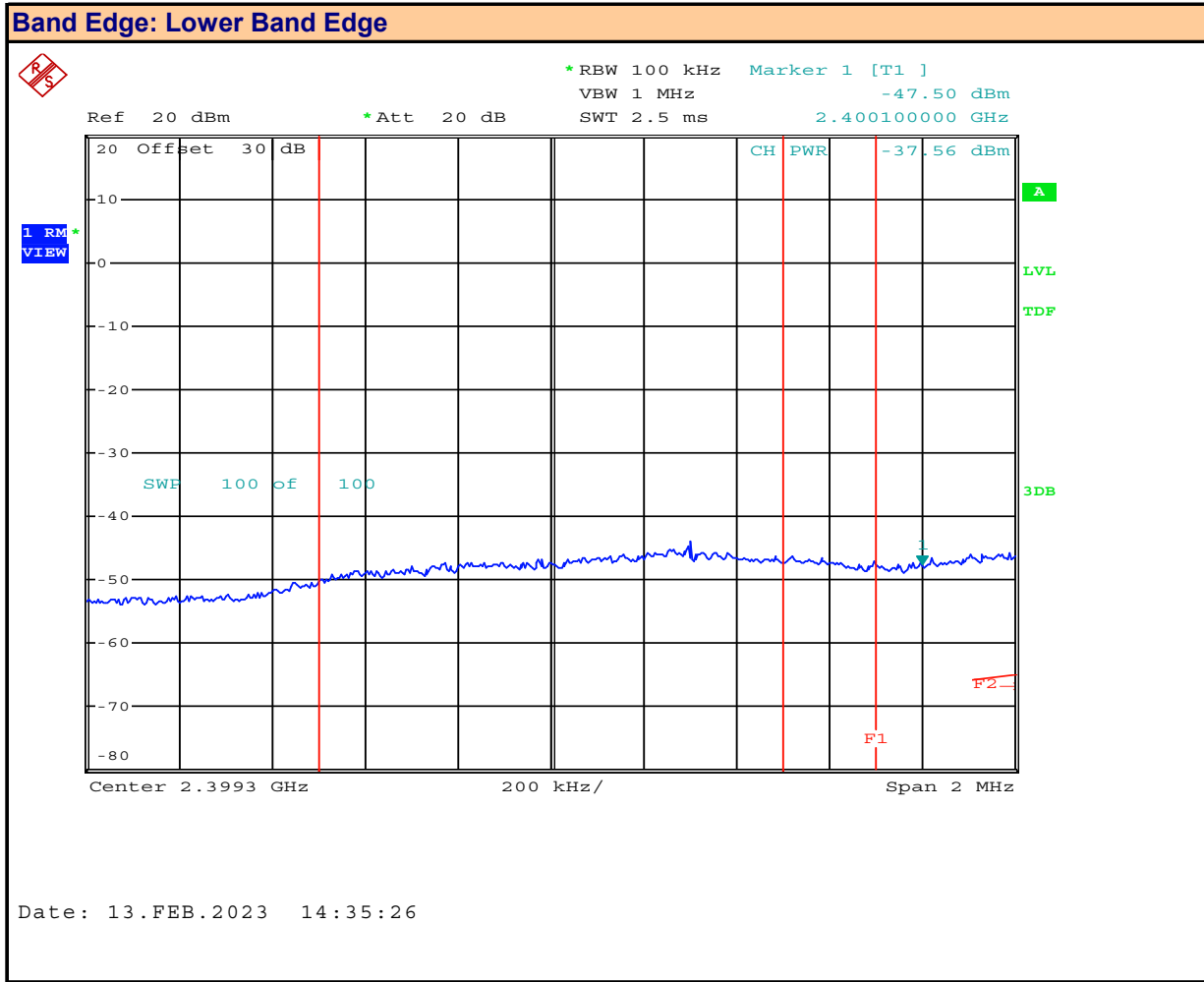

Channel:
 Mode:

Channel Frequency: MHz
 Modulation:
 Emission Power: dBm

Plot 15.10 – Band Edge, BT 2EDR

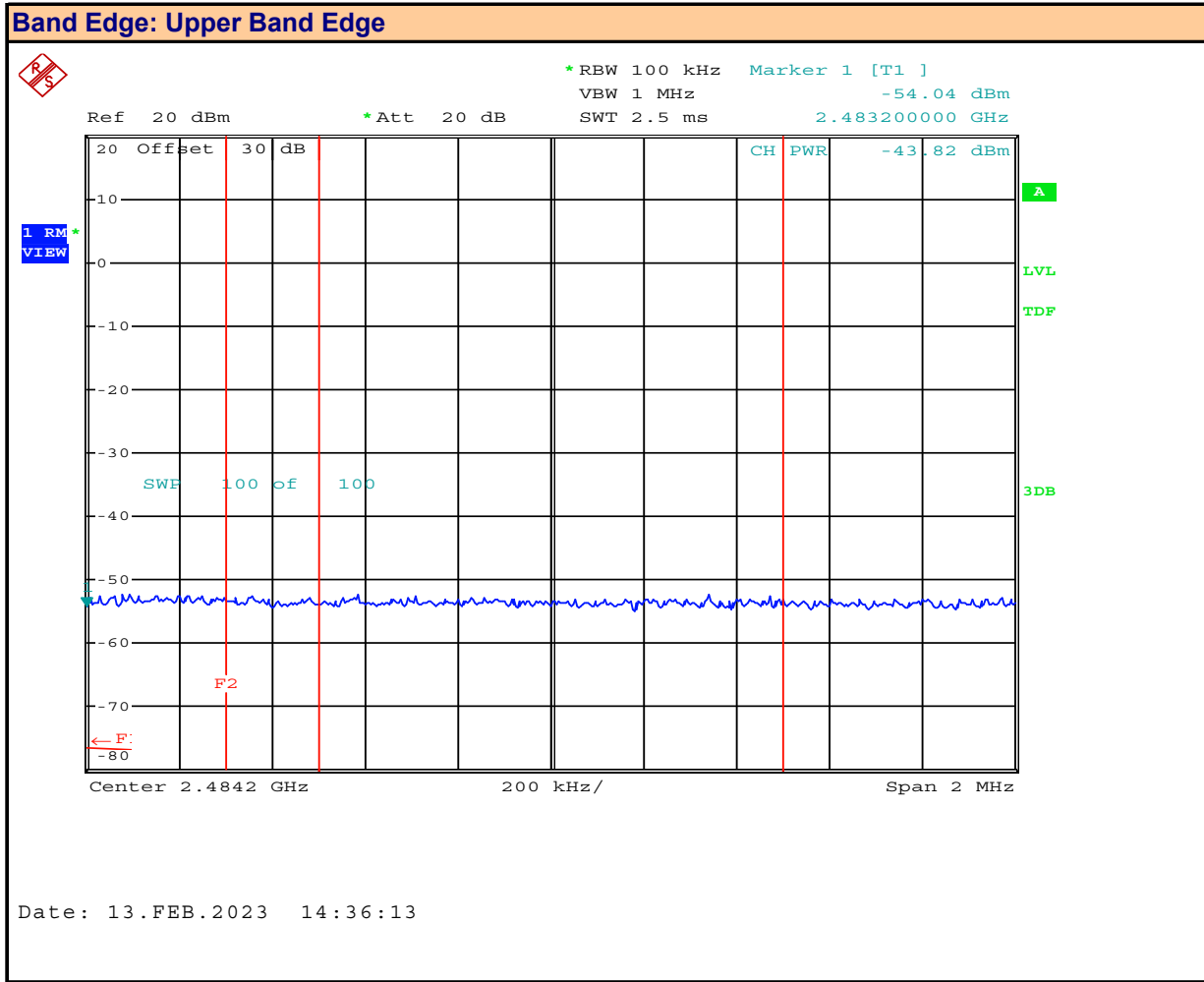

Channel:
 Mode:

Channel Frequency: MHz
 Modulation:
 Emission Power: dBm

Plot 15.12 – Band Edge, BT 3EDR

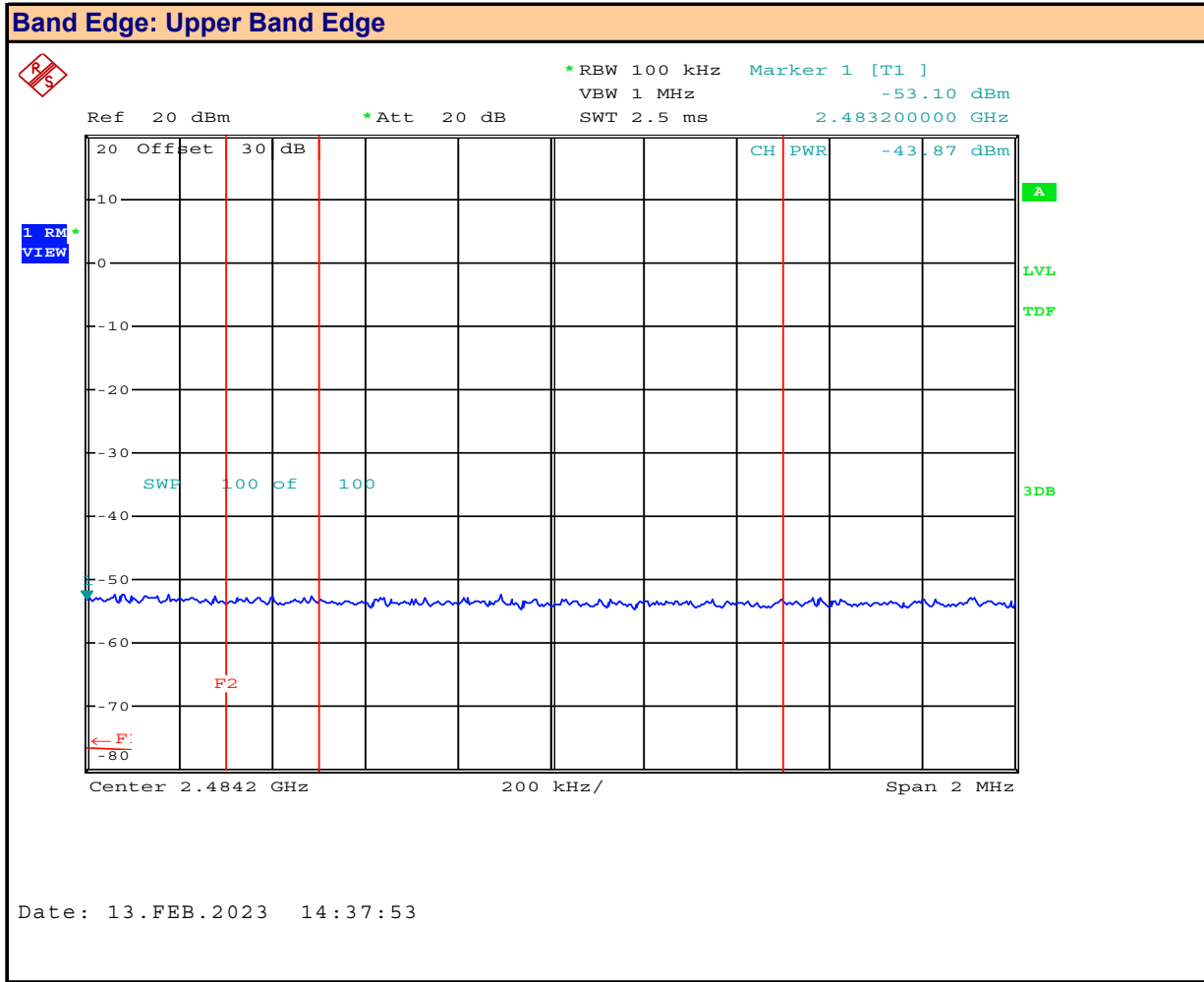

Channel:
 Mode:

Channel Frequency: MHz
 Modulation:
 Emission Power: dBm

Table 15.2 – Summary of Spurious Emission Measurements – Band Edge, DSS

Band Edge Measurement Results: 802.11													
Mode	Channel Number	Frequency (MHz)	Modulation	Emission Power [P _{Em}] (dBm)	Antenna Gain [G _T] (dBi)	Emission EIRP [E _{Em}] (dBm)	Fundamental Power [P _{Fund}] (dBm)	Fundamental EIRP [E _{Fund}] (dBm)	Attenuation [Atten] (dB)	Limit (dB)	Margin (dB)		
BT BR	0	2402.00	GFSK	-39.76	-5.06	-44.82	11.04	5.98	50.80	30	20.8		
	78	2480.00		-34.77		-39.83	11.13	6.07	45.90		15.9		
BT 2EDR	0	2402.00	Pi/4-DQPSK	-37.56		-42.62	10.11	5.05	47.67		17.7		
	78	2480.00		-43.82		-48.88	10.23	5.17	54.05		24.1		
BT 3EDR	0	2402.00	8-DPSK	-37.73		-42.79	10.11	5.05	47.84		17.8		
	78	2480.00		-43.87		-48.93	10.12	5.06	53.99		24.0		
Result:											Complies		

Emission [E_{Em}] = [P_{Em}] + [G_T]

Fundamental EIRP [E_{Fund}] = [P_{Fund}] + [G_T]

Attenuation [Atten] = [E_{Fund}] - [E_{Em}]

Margin = Attenuation - Limit

16.0 CONDUCTED SPURIOUS EMISSIONS

Test Procedure

Normative Reference	FCC 47 CFR §2.1051, §15.247(d), RSS-Gen (6.13), RSS-247 (5.5),
	KDB 558074 (11.3), ANSI C63.10 (11.11.3)

Limits

47 CFR §15.247(d)	(d) In any 100 kHz bandwidth outside the frequency band in which the spread spectrum or digitally modulated intentional radiator is operating, the radio frequency power that is produced by the intentional radiator shall be at least 20 dB below that in the 100 kHz bandwidth within the band that contains the highest level of the desired power, based on either an RF conducted or a radiated measurement, provided the transmitter demonstrates compliance with the peak conducted power limits. If the transmitter complies with the conducted power limits based on the use of RMS averaging over a time interval, as permitted under paragraph (b)(3) of this section, the attenuation required under this paragraph shall be 30 dB instead of 20 dB. Attenuation below the general limits specified in §15.209(a) is not required.
KDB 558074 (11.3) C63.10 (11.11.3)	<p>11.1 General</p> <p>The DTS rules specify that in any 100 kHz bandwidth outside of the authorized frequency band, the power shall be attenuated according to the following conditions:</p> <p>b) If maximum conducted (average) output power was used to demonstrate compliance as described in 9.2, then the peak power in any 100 kHz bandwidth outside of the authorized frequency band shall be attenuated by at least 30 dB relative to the maximum in-band peak PSD level in 100 kHz (i.e., 30 dBc).</p> <p>11.2 Reference level measurement</p> <p>a) Set instrument center frequency to DTS channel center frequency.</p> <p>b) Set the span to $\geq 1.5 \times DTS \text{ bandwidth}$.</p> <p>c) Set the RBW = 100 kHz.</p> <p>d) Set the VBW $\geq 3 \times RBW$.</p> <p>e) Detector = peak.</p> <p>f) Sweep time = auto couple.</p> <p>g) Trace mode = max hold.</p> <p>h) Allow trace to fully stabilize.</p> <p>i) Use the peak marker function to determine the maximum PSD level.</p> <p>Note that the channel found to contain the maximum PSD level can be used to establish the reference</p>

Table 16.1 – Summary of Conducted Spurious Emissions, (DTS)

See Appendix E for Measurement Plots

Conducted Spurious Emissions Measurement Results:									
Mode	Channel Number	Frequency (MHz)	Modulation	Emission Power [P _{Em}] (dBm)	Emission Frequency (MHz)	Reference Measurement [P _{Fund}] (dBm)	Attenuation [Atten] (dB)	Limit (dB)	Margin (dB)
802.11g	6	2437.00	OFDM12	-32.09	58.9	10.00	42.09	30	12.1
				-31.07	235.6		41.07		11.1
				-30.92	500.8		40.92		10.9
				-31.05	728		41.05		11.1
				-31.53	926.4		41.53		11.5
				14.39	Fundamental		-		-
				ND	-		-		-
				ND	-		-		-
				ND	-		-		-
				ND	-		-		-
				10.00	Reference	-	-	-	
Result:								Complies	

Attenuation [Atten] = [P_{Fund}] - [P_{Em}]
 Margin = Attenuation - Limit
 ND = None Detected

Table 16.2 – Summary of Conducted Spurious Emissions, (DSS)

See Appendix E for Measurement Plots

Conducted Spurious Emissions Measurement Results:									
Mode	Channel Number	Frequency (MHz)	Modulation	Emission Power [P _{Em}] (dBm)	Emission Frequency (MHz)	Reference Measurement [P _{Fund}] (dBm)	Attenuation [Atten] (dB)	Limit (dB)	Margin (dB)
BT BR	78	2480.00	GFSK	-31.95	189.12	9.93	41.88	30	11.9
				-31.89	394		41.82		11.8
				-31.99	467.2		41.92		11.9
				-31.63	754.4		41.56		11.6
				-31.90	996.8		41.83		11.8
Result:								Complies	

Attenuation [Atten] = [P_{Fund}] - [P_{Em}]
 Margin = Attenuation - Limit
 ND = None Detected

17.0 RADIATED TX SPURIOUS EMISSIONS, RESTRICTED BAND

Test Procedure

Normative Reference	FCC 47 CFR §2.1051, §15.247(d), §15.205(a), §15.205(c), §15.209(a)
	KDB 558074 (8.6), ANSI C63.10 (11.12)

Limits

47 CFR §15.247(d)	(d) In any 100 kHz bandwidth outside the frequency band in which the spread spectrum or digitally modulated intentional radiator is operating, the radio frequency power that is produced by the intentional radiator shall be at least 20 dB below that in the 100 kHz bandwidth within the band that contains the highest level of the desired power, based on either an RF conducted or a radiated measurement, provided the transmitter demonstrates compliance with the peak conducted power limits. If the transmitter complies with the conducted power limits based on the use of RMS averaging over a time interval, as permitted under paragraph (b)(3) of this section, the attenuation required under this paragraph shall be 30 dB instead of 20 dB. Attenuation below the general limits specified in §15.209(a) is not required. In addition, radiated emissions which fall in the restricted bands, as defined in §15.205(a), must also comply with the radiated emission limits specified in §15.209(a) (see §15.205(c)).																
47 CFR §15.209(a)	<p>§15.209 Radiated emission limits; general requirements.</p> <p>(a) Except as provided elsewhere in this subpart, the emissions from an intentional radiator shall not exceed the field strength levels specified in the following table:</p> <table border="1"> <thead> <tr> <th>Frequency (MHz)</th> <th>Field Strength (microvolts/meter)</th> </tr> </thead> <tbody> <tr> <td>0.009 - 0.490</td> <td>2400/F (kHz) @300m</td> </tr> <tr> <td>0.490 - 1.705</td> <td>24000/F (kHz) @30m</td> </tr> <tr> <td>1.705 - 30</td> <td>30 @ 30m</td> </tr> <tr> <td>30 - 88</td> <td>100 @3m</td> </tr> <tr> <td>88 - 216</td> <td>150 @3m</td> </tr> <tr> <td>216 - 960</td> <td>200 @3m</td> </tr> <tr> <td>Above 960</td> <td>500 @3m</td> </tr> </tbody> </table>	Frequency (MHz)	Field Strength (microvolts/meter)	0.009 - 0.490	2400/F (kHz) @300m	0.490 - 1.705	24000/F (kHz) @30m	1.705 - 30	30 @ 30m	30 - 88	100 @3m	88 - 216	150 @3m	216 - 960	200 @3m	Above 960	500 @3m
Frequency (MHz)	Field Strength (microvolts/meter)																
0.009 - 0.490	2400/F (kHz) @300m																
0.490 - 1.705	24000/F (kHz) @30m																
1.705 - 30	30 @ 30m																
30 - 88	100 @3m																
88 - 216	150 @3m																
216 - 960	200 @3m																
Above 960	500 @3m																

Table 17.1 – Summary of Radiated Tx Spurious Emissions, Restricted Band, (DTS)

Summary of Radiated Tx (Restricted Band) Measurements											
Mode	Modulation	Channel	Frequency (MHz)	Polarity	Emission Frequency (MHz)	Avg Power (dBuV/m)	Limit		Peak Power (dBuV/m)	Limit	
							Avg (dBuV/m)	Margin (dB)		Peak (dBuV/m)	Margin (dB)
802.11b	DSSS 5.5	1	2412	H	2390	50.08	54.00	3.92	59.05	74.00	14.95
				V		49.85	54.00	4.15	59.81	74.00	14.19
		11	2462	H	2483.5	50.01	54.00	3.99	61.44	74.00	12.56
				V		50.06	54.00	3.94	60	74.00	14.00
802.11g	OFDM12	1	2412	H	2390	51.88	54.00	2.12	64.05	74.00	9.95
				V		53.141	54.00	0.86	67.72	74.00	6.28
		11	2462	H	2483.5	52.54	54.00	1.46	64.92	74.00	9.08
				V		52.3	54.00	1.70	64.86	74.00	9.14
802.11n	MCS0	1	2412	H	2390	52.03	54.00	1.97	62.56	74.00	11.44
				V		51.27	54.00	2.73	61.95	74.00	12.05
		11	2462	H	2483.5	52.61	54.00	1.39	63.91	74.00	10.09
				V		51.53	54.00	2.47	63.05	74.00	10.95

No Other Emissions within 20dB of the limit observed.

Table 17.2 – Summary of Radiated Tx Spurious Emissions, (DTS)

See Appendix F for Measurement Plots

Summary of Radiated Tx Emissions											
Measured Frequency Range (MHz)	Channel Frequency	Antenna Polarization	Emission Frequency (MHz)	Measured Emission [E _{Meas}] (dBuV)	Antenna ACF [ACF] (dB)	Cable Loss [L _C] (dB)	Amplifier Gain [G _A] (dB)	Corrected Emission [E _{Corr}] (dBuV/m)	Limit (dBuV)	Margin (dB)	
30-1000MHz	2412.0	Horizontal	31.9	8.46	22.91	0.68	0.00 (3)	32.1 (2)	40.0	7.9	
30-1000MHz	2412.0	Horizontal	54.6	8.21	11.39	0.79	0.00 (3)	20.4 (2)	40.0	19.6	
30-1000MHz	2412.0	Horizontal	57.0	8.04	10.90	0.80	0.00 (3)	19.7 (2)	40.0	20.3	
30-1000MHz	2412.0	Horizontal	158.8	9.50	15.50	1.20	0.00 (3)	26.2 (2)	43.5	17.3	
30-1000MHz	2412.0	Horizontal	925.1	9.11	29.91	2.98	0.00 (3)	42.0 (2)	46.0	4.0	
30-1000MHz	2412.0	Horizontal	926.5	9.19	30.00	2.98	0.00 (3)	42.2 (2)	46.0	3.9	
30-1000MHz	2412.0	Vertical	729.1	8.51	28.30	2.66	0.00 (3)	39.5 (2)	46.0	6.6	
30-1000MHz	2412.0	Vertical	904.8	9.36	29.30	2.93	0.00 (3)	41.6 (2)	46.0	4.4	
30-1000MHz	2412.0	Vertical	906.9	8.91	29.39	2.94	0.00 (3)	41.2 (2)	46.0	4.8	
30-1000MHz	2412.0	Vertical	908.3	8.80	29.50	2.94	0.00 (3)	41.2 (2)	46.0	4.8	
30-1000MHz	2412.0	Vertical	909.0	8.84	29.50	2.94	0.00 (3)	41.3 (2)	46.0	4.7	
30-1000MHz	2412.0	Vertical	909.7	8.84	29.50	2.94	0.00 (3)	41.3 (2)	46.0	4.7	
30-1000MHz	2412.0	Vertical	910.4	8.84	29.46	2.95	0.00 (3)	41.2 (2)	46.0	4.8	
1 - 3GHz	2412.0	Horizontal	ND	ND (1)	27.40	4.58	0.00 (3)	ND	54.0	n/a	
1 - 3GHz	2412.0	Vertical	ND	ND (1)	27.40	4.58	0.00 (3)	ND	54.0	n/a	
3-13GHz	2412.0	Horizontal	ND	ND (1)	36.76	9.86	0.00 (3)	ND	54.0	n/a	
3-13GHz	2412.0	Vertical	ND	ND (1)	36.76	9.86	0.00 (3)	ND	54.0	n/a	
13-18GHz	2412.0	Horizontal	ND	ND (1)	38.75	16.54	0.00 (3)	ND	54.0	n/a	
13-18GHz	2412.0	Vertical	ND	ND (1)	38.75	16.54	0.00 (3)	ND	54.0	n/a	
18-26GHz	2412.0	Horizontal	ND	ND (1)	43.50	21.86	26.00	ND	54.0	n/a	
18-26GHz	2412.0	Vertical	ND	ND (1)	43.50	21.86	26.00	ND	54.0	n/a	
Results:									Complies		

(1) No Emissions Detected (ND) above ambient or within 20dB of the limit

(2) Antenna ACF, Cable Loss and Amplifier Gain corrected in Spectrum Analyzer Transducer Factor

(3) External Amplifier not used

$$E_{Corr} = E_{Meas} + ACF + L_C - G_A$$

Table 17.2 – Summary of Radiated Tx Spurious Emissions, (DSS)

See Appendix F for Measurement Plots

Summary of Radiated Tx Emissions											
Measured Frequency Range (MHz)	Channel Frequency	Antenna Polarization	Emission Frequency	Measured Emission [E _{Meas}] (dBuV)	Antenna ACF [ACF] (dB)	Cable Loss [L _C] (dB)	Amplifier Gain [G _A] (dB)	Corrected Emission [E _{Corr}] (dBuV/m)	Limit (dBuV)	Margin (dB)	
30-1000MHz	2440.0	Horizontal	32.43	8.13	22.64	0.68	0.00 (3)	31.5 (2)	40.0	8.5	
30-1000MHz	2440.0	Horizontal	54.57	7.74	11.39	0.79	0.00 (3)	19.9 (2)	40.0	20.1	
30-1000MHz	2440.0	Horizontal	68.07	7.32	11.21	0.85	0.00 (3)	19.4 (2)	40.0	20.6	
30-1000MHz	2440.0	Horizontal	73.47	7.67	11.65	0.87	0.00 (3)	20.2 (2)	40.0	19.8	
30-1000MHz	2440.0	Horizontal	841.10	9.04	29.60	2.84	0.00 (3)	41.5 (2)	46.0	4.5	
30-1000MHz	2440.0	Horizontal	867.70	8.41	29.40	2.88	0.00 (3)	40.7 (2)	46.0	5.3	
30-1000MHz	2440.0	Horizontal	920.90	8.60	29.80	2.97	0.00 (3)	41.4 (2)	46.0	4.7	
30-1000MHz	2440.0	Horizontal	925.10	8.62	29.91	2.98	0.00 (3)	41.5 (2)	46.0	4.5	
30-1000MHz	2440.0	Vertical	729.10	8.51	28.30	2.66	0.00 (3)	39.5 (2)	46.0	6.6	
30-1000MHz	2440.0	Vertical	909.00	8.69	29.50	2.94	0.00 (3)	41.1 (2)	46.0	4.9	
1 - 3GHz	2440.0	Horizontal	ND	ND (1)	27.40	4.58	0.00 (3)	ND	54.0	n/a	
1 - 3GHz	2440.0	Vertical	ND	ND (1)	27.40	4.58	0.00 (3)	ND	54.0	n/a	
3-13GHz	2440.0	Horizontal	ND	ND (1)	36.76	9.86	0.00 (3)	ND	54.0	n/a	
3-13GHz	2440.0	Vertical	ND	ND (1)	36.76	9.86	0.00 (3)	ND	54.0	n/a	
13-18GHz	2440.0	Horizontal	ND	ND (1)	38.75	16.54	0.00 (3)	ND	54.0	n/a	
13-18GHz	2440.0	Vertical	ND	ND (1)	38.75	16.54	0.00 (3)	ND	54.0	n/a	
18-26GHz	2440.0	Horizontal	ND	ND (1)	43.50	21.86	26.00	ND	54.0	n/a	
18-26GHz	2440.0	Vertical	ND	ND (1)	43.50	21.86	26.00	ND	54.0	n/a	
Results:									Complies		

(1) No Emissions Detected (ND) above ambient or within 20dB of the limit

(2) Antenna ACF, Cable Loss and Amplifier Gain corrected in Spectrum Analyzer Transducer Factor

(3) External Amplifier not used

$$E_{Corr} = E_{Meas} + ACF + L_C - G_A$$

18.0 RADIATED RX SPURIOUS EMISSIONS

Test Procedure

Normative Reference	FCC 47 CFR §15.109, ICES-003(6.2) ANSI C63.4:2014
----------------------------	--

Limits

47 CFR §15.109	(a) Except for Class A digital devices, the field strength of radiated emissions from unintentional radiators at a distance of 3 meters shall not exceed the following values: 30-88MHz: 40dBuV/m 88-216MHz: 43.5dBuV/m 216-960MHz: 46dBuV/m > 960MHz: 54dBuV/m
ICES-003(6.2.1)	6.2.1 - Radiated Emissions Limits Below 1 GHz Class B: ITE that does not meet the conditions for Class A operation shall comply with the Class B radiated limits set out in Table 5 determined at a distance of 3 metres. 30-88MHz: 40dBuV/m 88-216MHz: 43.5dBuV/m 216-960MHz: 46dBuV/m > 960MHz: 54dBuV/m

Test Setup	Appendix A Figure A.2
-------------------	-------------------------------------

Measurement Procedure

The DUT was set up as per ANSI C63.4:2014. Emissions were scanned between 30MHz and 1000MHz. The turntable was rotated 360 degrees and the antenna was elevated to 4m to optimize the measured emissions.

Table 18.1 – Summary of Radiated Rx Spurious Emissions, (DTS)

See Appendix G Measurement Plots

Summary of Radiated Rx Emissions											
Measured Frequency Range (MHz)	Channel Frequency	Antenna Polarization	Emission Frequency	Measured Emission [E _{Meas}] (dBuV)	Antenna ACF [ACF] (dB)	Cable Loss [L _C] (dB)	Amplifier Gain [G _A] (dB)	Corrected Emission [E _{Corr}] (dBuV/m)	Limit (dBuV)	Margin (dB)	
30-1000MHz	-	Horizontal	ND	ND (1)	0.00	0.00	0.00 (3)	ND (2)	46.0	n/a	
30-1000MHz	-	Vertical	ND	ND (1)	0.00	0.00	0.00 (3)	ND (2)	43.5	n/a	
1 - 3GHz	-	Horizontal	ND	ND (1)	27.40	4.58	0.00 (3)	ND	54.0	n/a	
1 - 3GHz	-	Vertical	ND	ND (1)	27.40	4.58	0.00 (3)	ND	54.0	n/a	
3-13GHz	-	Horizontal	ND	ND (1)	36.76	9.86	0.00 (3)	ND	54.0	n/a	
3-13GHz	-	Vertical	ND	ND (1)	36.76	9.86	0.00 (3)	ND	54.0	n/a	
13-18GHz	-	Horizontal	ND	ND (1)	38.75	16.54	0.00 (3)	ND	54.0	n/a	
13-18GHz	-	Vertical	ND	ND (1)	38.75	16.54	0.00 (3)	ND	54.0	n/a	
18-26GHz	-	Horizontal	ND	ND (1)	43.50	21.86	26.00	ND	54.0	n/a	
18-26GHz	-	Vertical	ND	ND (1)	43.50	21.86	26.00	ND	54.0	n/a	
Results:									Complies		

(1) No Emissions Detected (ND) above ambient or within 20dB of the limit

(2) Antenna ACF, Cable Loss and Amplifier Gain corrected in Spectrum Analyzer Transducer Factor

(3) External Amplifier not used

$$E_{\text{Corr}} = E_{\text{Meas}} + \text{ACF} + L_{\text{C}} - G_{\text{A}}$$

Table 18.2 – Summary of Radiated Rx Spurious Emissions, (DSS)

See Appendix G Measurement Plots

Summary of Radiated Rx Emissions											
Measured Frequency Range (MHz)	Channel Frequency	Antenna Polarization	Emission Frequency	Measured Emission [E _{Meas}] (dBuV)	Antenna ACF [ACF] (dB)	Cable Loss [L _C] (dB)	Amplifier Gain [G _A] (dB)	Corrected Emission [E _{Corr}] (dBuV/m)	Limit (dBuV)	Margin (dB)	
30-1000MHz	-	Horizontal	ND	ND (1)	0.00	0.00	0.00 (3)	ND (2)	46.0	n/a	
30-1000MHz	-	Vertical	ND	ND (1)	0.00	0.00	0.00 (3)	ND (2)	43.5	n/a	
1 - 3GHz	-	Horizontal	ND	ND (1)	27.40	4.58	0.00 (3)	ND	54.0	n/a	
1 - 3GHz	-	Vertical	ND	ND (1)	27.40	4.58	0.00 (3)	ND	54.0	n/a	
3-13GHz	-	Horizontal	ND	ND (1)	36.76	9.86	0.00 (3)	ND	54.0	n/a	
3-13GHz	-	Vertical	ND	ND (1)	36.76	9.86	0.00 (3)	ND	54.0	n/a	
13-18GHz	-	Horizontal	ND	ND (1)	38.75	16.54	0.00 (3)	ND	54.0	n/a	
13-18GHz	-	Vertical	ND	ND (1)	38.75	16.54	0.00 (3)	ND	54.0	n/a	
18-26GHz	-	Horizontal	ND	ND (1)	43.50	21.86	26.00	ND	54.0	n/a	
18-26GHz	-	Vertical	ND	ND (1)	43.50	21.86	26.00	ND	54.0	n/a	
Results:									Complies		

(1) No Emissions Detected (ND) above ambient or within 20dB of the limit

(2) Antenna ACF, Cable Loss and Amplifier Gain corrected in Spectrum Analyzer Transducer Factor

(3) External Amplifier not used

$$E_{Corr} = E_{Meas} + ACF + L_C - G_A$$

19.0 POWER LINE CONDUCTED EMISSIONS

Test Procedure	
Normative Reference	FCC 47 CFR §15.107, ICES-003(6.1) ANSI C63.4-2014
Limits	
47 CFR §15.107	(a) Except for Class A digital devices, for equipment that is designed to be connected to the public utility (AC) power line, the radio frequency voltage that is conducted back onto the AC power line on any frequency or frequencies within the band 150 kHz to 30 MHz shall not exceed the limits in the following table, as measured using a 50 µH/50 ohms line impedance stabilization network (LISN). Compliance with the provisions of this paragraph shall be based on the measurement of the radio frequency voltage between each power line and ground at the power terminal. The lower limit applies at the band edges. 0.15-0.5MHz: 66-56 dBuV Quasi Peak, 56-46 dBuV Average, Decreases with the logarithm of the frequency 0.5 - 5.0 MHz: 56 dBuV Quasi Peak, 46 dBuV Average 5.0 - 30.0 MHz: 60 dBuV Quasi Peak, 50 dBuV Average
ICES-003(6.1)	6.1 - AC Power Line Conducted Emissions Limits Class B: ITE that does not meet the conditions for Class A operation shall comply with the Class B radiated limits set out in Table 2. 0.15-0.5MHz: 66-56 dBuV Quasi Peak, 56-46 dBuV Average, Decreases with the logarithm of the 0.5 - 5.0 MHz: 56 dBuV Quasi Peak, 46 dBuV Average 5.0 - 30.0 MHz: 60 dBuV Quasi Peak, 50 dBuV Average
Test Setup	Appendix A Figure A.7

Plot 19.1 – Power Line Conducted Emissions, Line 1

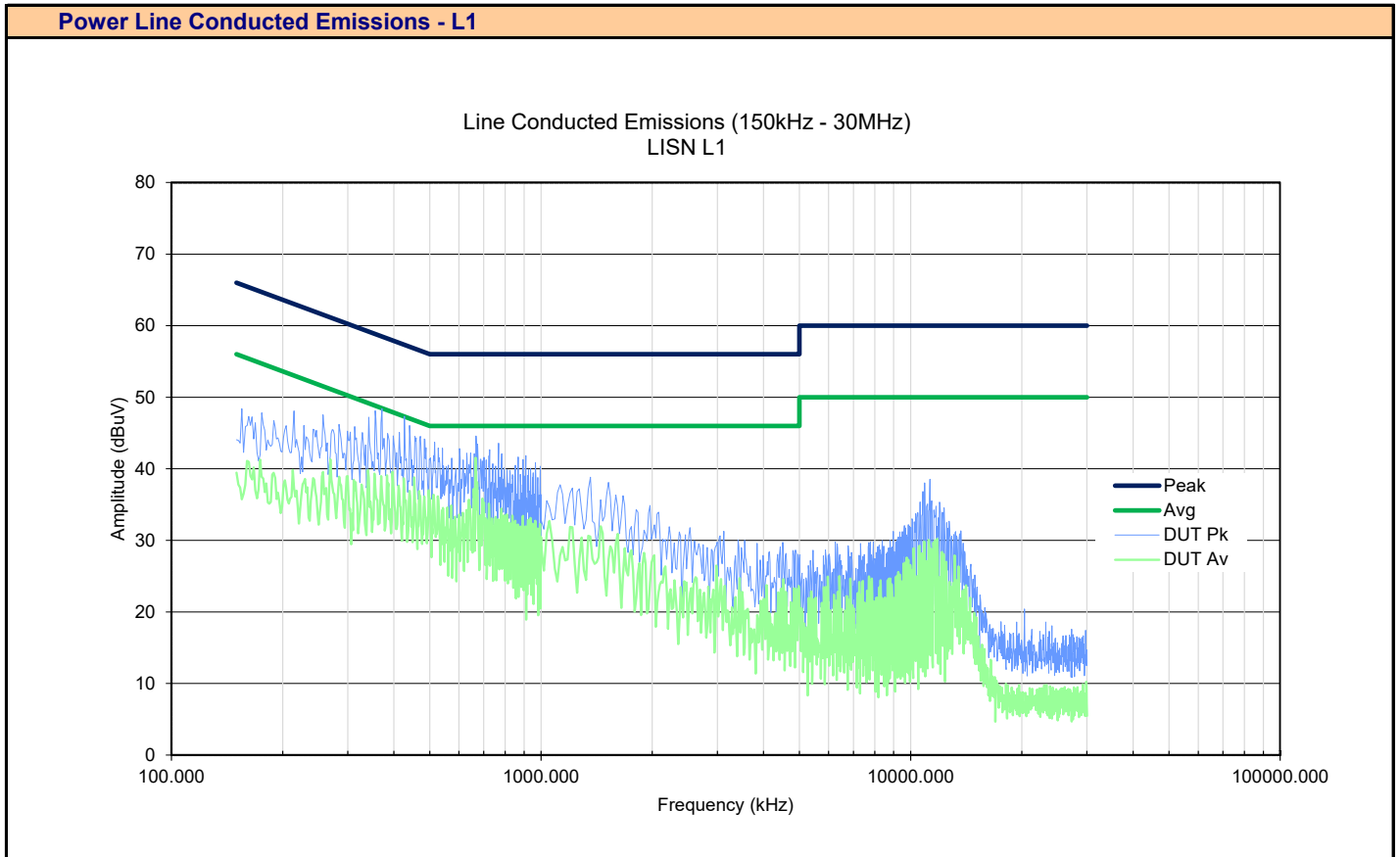

Channel:	6	Channel Frequency:	2437 MHz
Mode:	802.11b	Modulation:	CCK 1MB
Emission Frequency:	371kHz	Measured Channel Power:	48.38 dBuV

Plot 19.2 – Power Line Conducted Emissions, Line 2

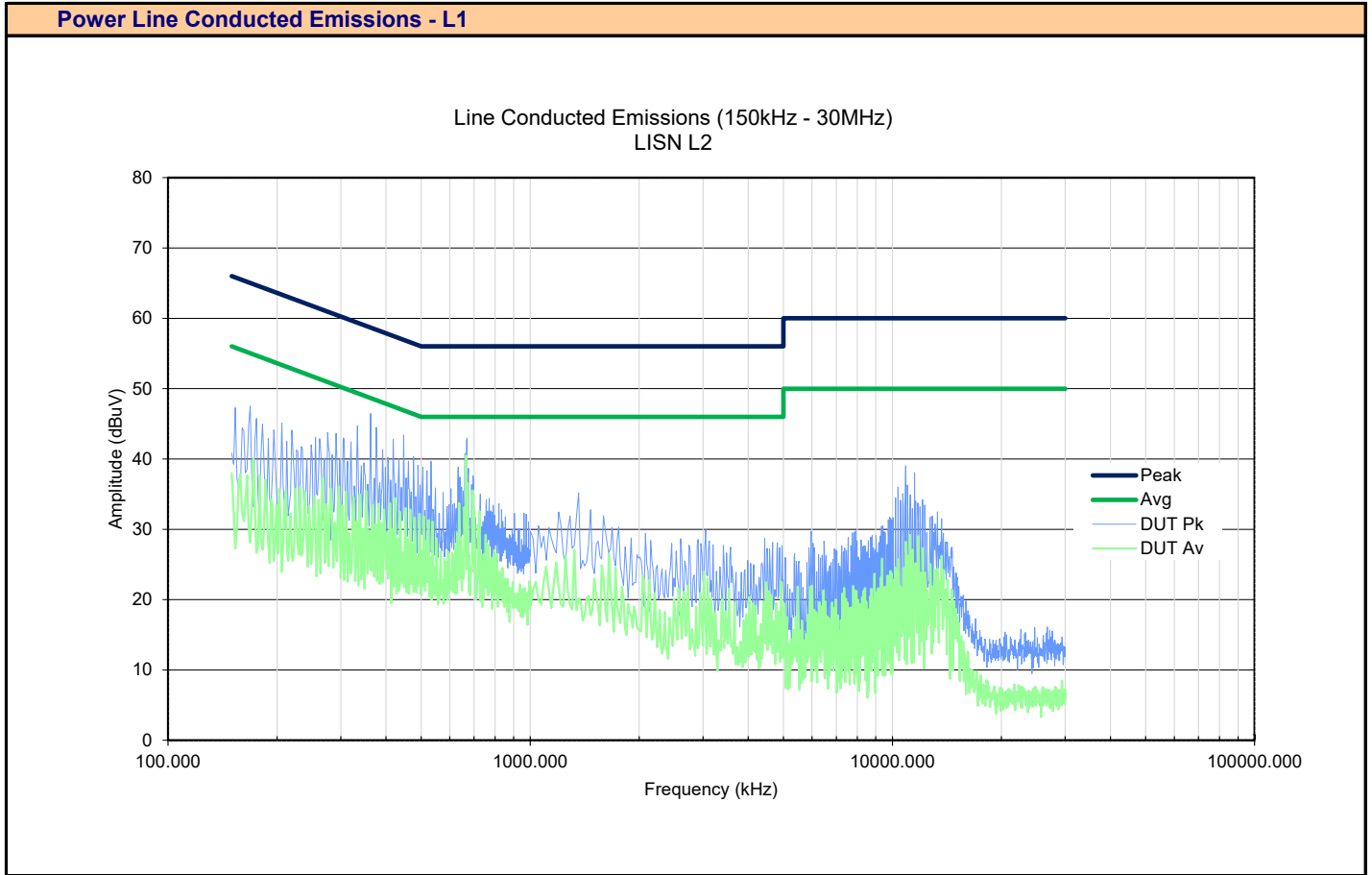

Channel:	6	Channel Frequency:	2437 MHz
Mode:	802.11b	Modulation:	CCK 1MB
Emission Frequency:	362.5kHz	Measured Channel Power:	46.46 dBuV

Table 19.1 – Summary of Power Line Conducted Emissions – L1

Summary of Power Line Conducted Tx Emissions											
Measured Frequency Range (MHz)	Channel Frequency (MHz)	LISN Port	Emission Frequency [f _{Emm}] (kHz)	Measured Emission [E _{Meas}] (dBuV)	Detector*	Insertion Loss [L _{LISN}] (dB)	Cable Loss [L _C] (dB)	Amplifier Gain [G _A] (dB)	Corrected Emission [E _{Corr}] (dBuV)	Limit (dBuV)	Margin (dB)
150kHz - 30MHz	2437.0	L1	371.00 kHz	48.38	Peak	0.30	0.26	0.00 (3)	48.94 (2)	58.0	9.1
Results:										Complies	

* In accordance with FCC §15.35 and ANSI C63.4, a Peak detector may be used to demonstrate compliance to Quasi-Peak limits provided the Resolution Bandwidth (RBW) is equal to or greater than Quasi-Peak bandwidth. The Detector RBW employed was ≥ 9kHz.

(2) LISN Insertion Loss, Cable Loss and Amplifier Gain corrected in Spectrum Analyzer Transducer Factor

(3) External Amplifier not used

$$E_{Corr} = E_{Meas} + L_{LISN} + L_C - G_A$$

Class B QP Limit = 56 - 20Log (f_{Emm}/500) for f_{Emm} = 150kHz to 500kHz

Class B Avg Limit = 46 - 20Log (f_{Emm}/500) for f_{Emm} = 150kHz to 500kHz

Class A QP Limit = 79dBuV for f_{Emm} = 150kHz to 500kHz

Class A Avg Limit = 66dBuV for f_{Emm} = 150kHz to 500kHz

$$\text{Margin} = \text{Limit} - E_{Corr}$$

Table 19.1 – Summary of Power Line Conducted Emissions – L2

Summary of Power Line Conducted Tx Emissions											
Measured Frequency Range (MHz)	Channel Frequency (MHz)	LISN Port	Emission Frequency [f _{Emm}] (kHz)	Measured Emission [E _{Meas}] (dBuV)	Detector*	Insertion Loss [L _{LISN}] (dB)	Cable Loss [L _C] (dB)	Amplifier Gain [G _A] (dB)	Corrected Emission [E _{Corr}] (dBuV)	Limit (dBuV)	Margin (dB)
150kHz - 30MHz	2437.0	L2	362.50 kHz	46.46	Peak	0.30	0.26	0.00 (3)	47.02 (2)	58.6	11.6
Results:										Complies	

* In accordance with FCC §15.35 and ANSI C63.4, a Peak detector may be used to demonstrate compliance to Quasi-Peak limits provided the Resolution Bandwidth (RBW) is equal to or greater than Quasi-Peak bandwidth. The Detector RBW employed was ≥ 9kHz.

(2) LISN Insertion Loss, Cable Loss and Amplifier Gain corrected in Spectrum Analyzer Transducer Factor

(3) External Amplifier not used

$$E_{Corr} = E_{Meas} + L_{LISN} + L_C - G_A$$

Class B QP Limit = 56 - 20Log (f_{Emm}/500) for f_{Emm} = 150kHz to 500kHz

Class B Avg Limit = 46 - 20Log (f_{Emm}/500) for f_{Emm} = 150kHz to 500kHz

Class A QP Limit = 79dBuV for f_{Emm} = 150kHz to 500kHz

Class A Avg Limit = 66dBuV for f_{Emm} = 150kHz to 500kHz

$$\text{Margin} = \text{Limit} - E_{Corr}$$

APPENDIX A – TEST SETUP DRAWINGS

Table A.1 – Conducted Measurement Setup

Equipment List				
Asset Number	Manufacturer	Model Number	Serial Number	Description
00241	R&S	FSU40	100500	Spectrum Analyzer
00263	Koaxis	KP10-1.00M-TD	263	1m Armoured Cable

Figure A.1 – Test Setup – Conducted Measurements

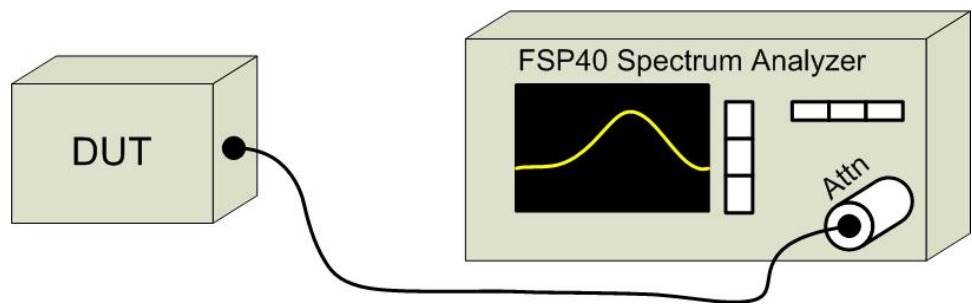

Table A.2 – Radiated Emissions Measurement Equipment

Equipment List				
Asset Number	Manufacturer	Model Number	Serial Number	Description
00050	Chase	CBL-6111A	1607	Bilog Antenna
00034	ETS	3115	6267	Double Ridged Guide Horn
00035	ETS	3115	6276	Double Ridged Guide Horn
00085	EMCO	6502	9203-2724	Loop Antenna
00161	Waveline Inc.	889		Standard Gain Horn 18-26GHz
00162	Waveline Inc.	889		Standard Gain Horn 18-26GHz
00165	Waveline Inc.	801-KF		Waveguide Adapter 18-26GHz
00166	Waveline Inc.	801-KF		Waveguide Adapter 18-26GHz
00333	HP	85685A	3010A01095	RF Preselector
00049	HP	85650A	2043A00162	Quasi-peak Adapter
00051	HP	8566B	2747A05510	Spectrum Analyzer
00241	R&S	FSU40	100500	Spectrum Analyzer
00265	Miteq	JS32-00104000-58-5P	1939850	Microwave L/N Amplifier
00071	EMCO	2090	9912-1484	Multi-Device Controller
00072	EMCO	2075	0001-2277	Mini-mast
00073	EMCO	2080	0002-1002	Turn Table
00263	Koaxis	KP10-1.00M-TD	263	1m Armoured Cable
00263B	Koaxis	KP10-1.00M-TD	263B	1m Armoured Cable
00275	TMS	LMR400	n/a	25m Cable
00278	TILE	34G3	n/a	TILE Test Software

Figure A.2 – Test Setup Radiated Measurements 9kHzMHz – 30MHz

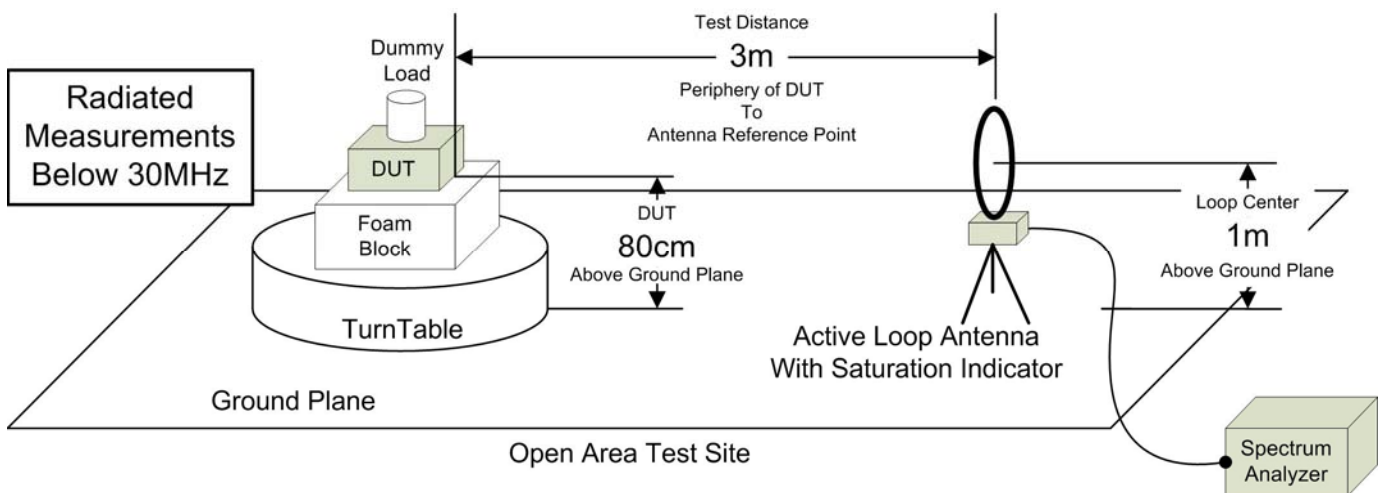

Figure A.3 – Test Setup Radiated Measurements 30MHz – 1GHz

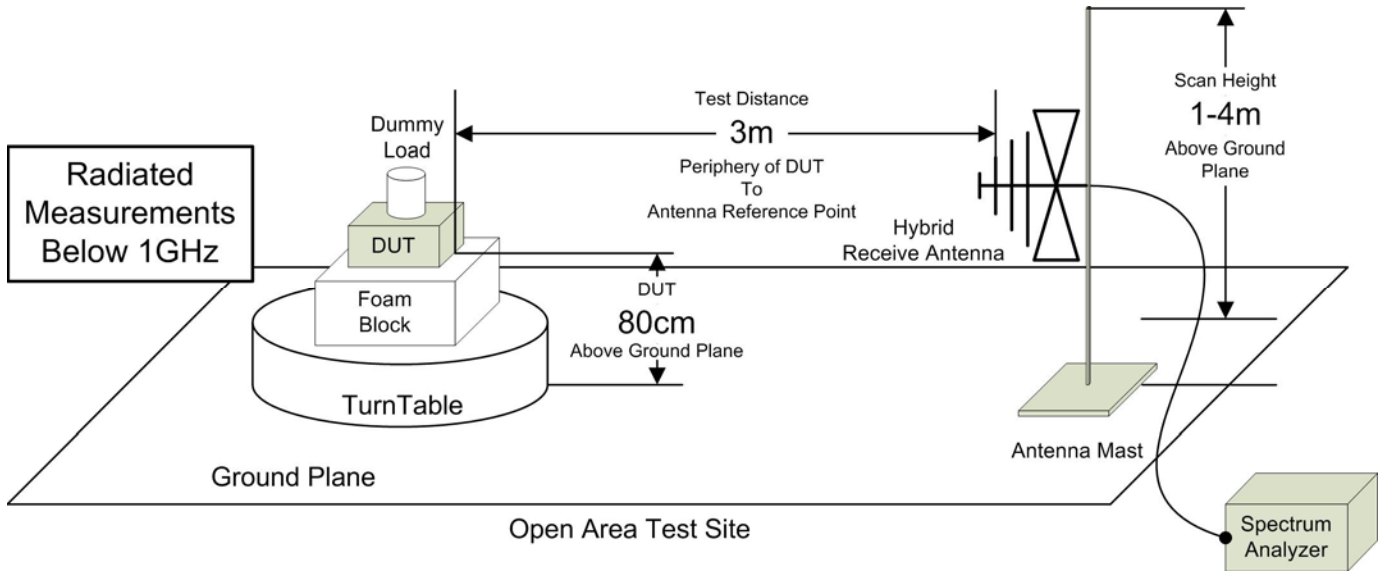

Figure A.4 – Test Setup Radiated Measurements 30MHz – 1GHz, Signal Substitution

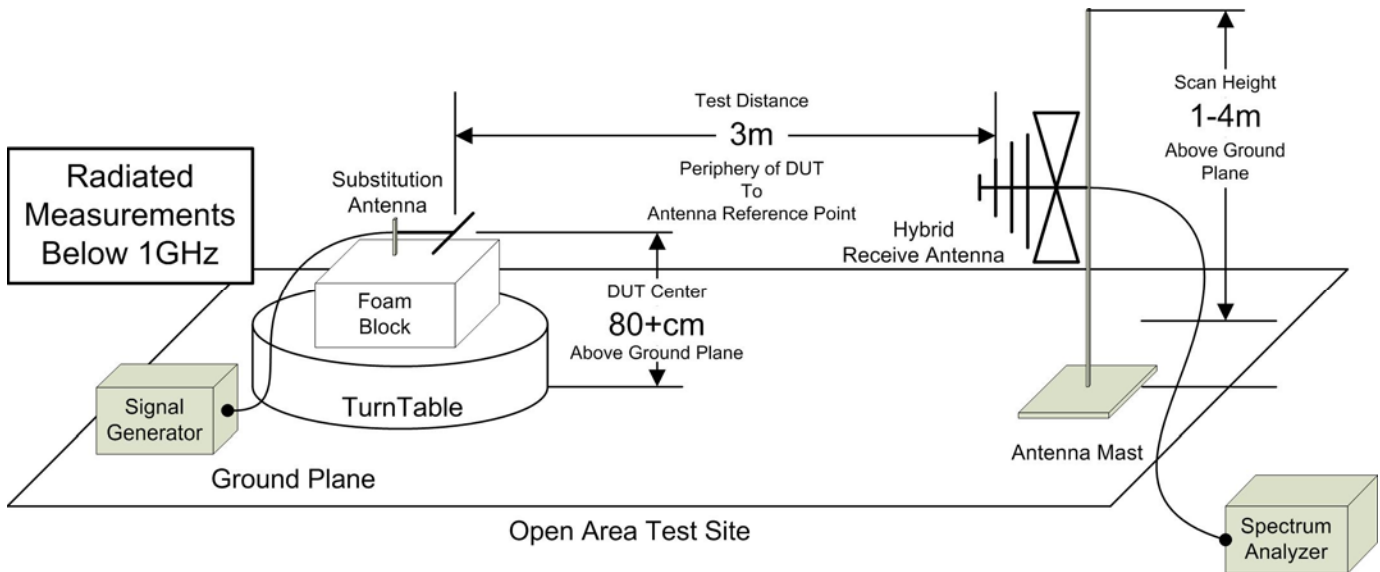

Figure A.5 – Test Setup Radiated Measurements 1 – 18GHz,

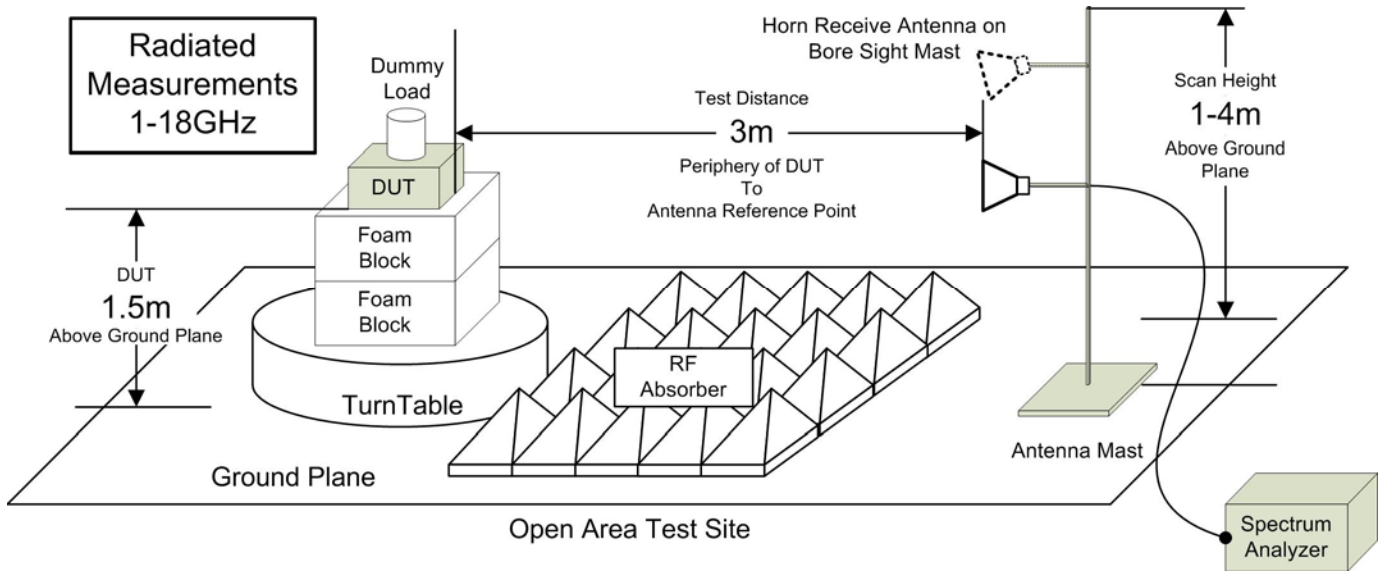

Figure A.6 – Test Setup Radiated Measurements 18 – 26.5GHz,

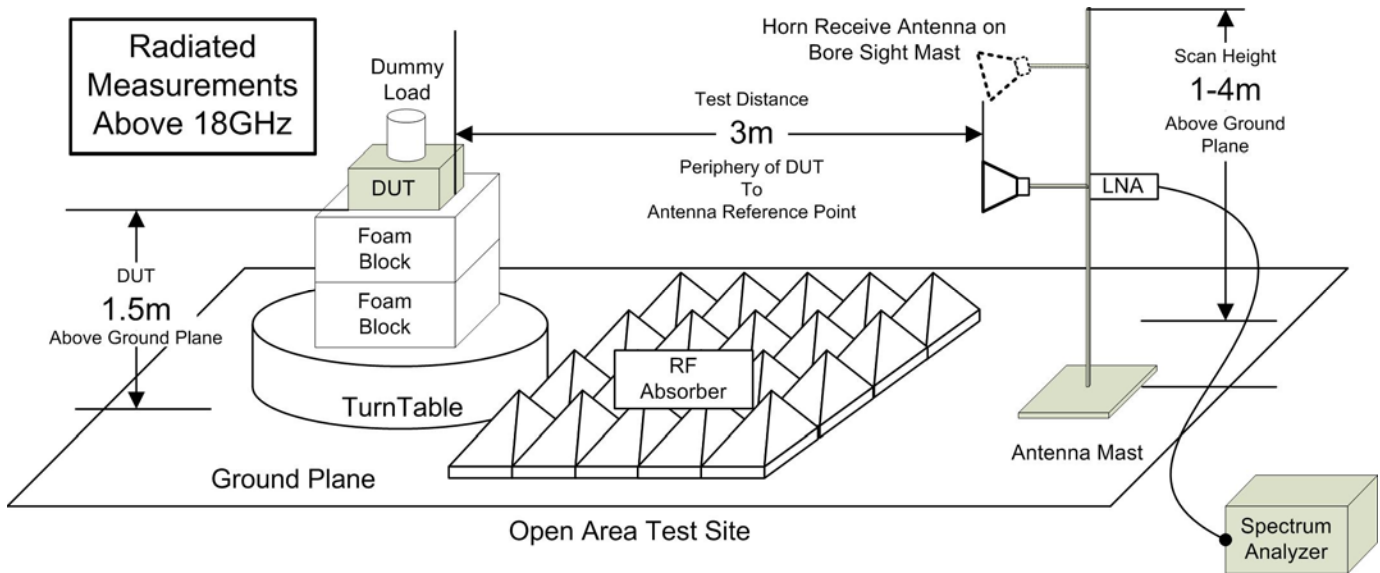

Table A.3 – Setup – Conducted Emissions Equipment List

Equipment List				
Asset Number	Manufacturer	Model Number	Serial Number	Description
00333	HP	85685A	3010A01095	RF Preselector
00049	HP	85650A	2043A00162	Quasi-peak Adapter
00051	HP	8566B	2747A05510	Spectrum Analyzer
00223	HP	8901A	3749A07154	Modulation Analyzer
00257	Com-Power	LI-215A	191934	LISN
00276	TMS	LMR400	n/a	4m Cable

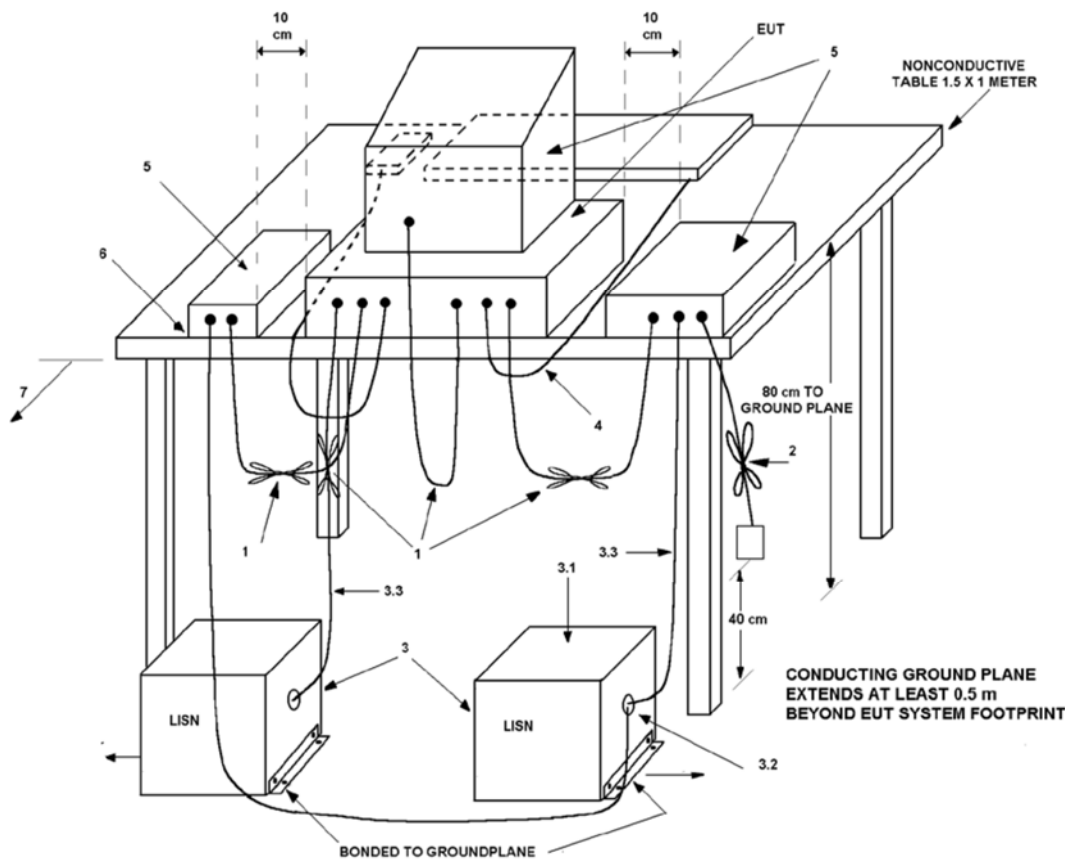

Figure A.7 – Test Setup Conducted Emissions Measurements

APPENDIX B – EQUIPMENT LIST AND CALIBRATION

Equipment List					Last	Calibration	Calibration
Asset Number	Manufacturer	Model Number	Serial Number	Description	Calibrated	Interval	Due
00050	Chase	CBL-6111A	1607	Bilog Antenna	16 Nov 2020	Triennial	16 Nov 2023
00035	ETS	3115	6276	Double Ridged Guide Horn	4 Mar 2022	Triennial	4 Mar 2025
00085	EMCO	6502	9203-2724	Loop Antenna	6 Sep 2022	Triennial	6 Sep 2025
00333	HP	85685A	3010A01095	RF Preselector	23 Jun 2020	Triennial	30 Jun 2023
00049	HP	85650A	2043A00162	Quasi-peak Adapter	23 Jun 2020	Triennial	23 Jun 2023
00051	HP	8566B	2747A05510	Spectrum Analyzer	23 Jun 2020	Triennial	23 Jun 2023
00241	R&S	FSU40	100500	Spectrum Analyzer	10 Aug 2021	Triennial	10 Aug 2024
00005	HP	8648D	3847A00611	Signal Generator	23 Jun 2020	Triennial	23 Jun 2023
00003	HP	53181A	3736A05175	Frequency Counter	23 Jun 2020	Triennial	23 Jun 2023
00257	Com-Power	LI-215A	191934	LISN	27 Dec 2021	Triennial	27 Dec 2024
00071	EMCO	2090	9912-1484	Multi-Device Controller	n/a	n/a	n/a
00072	EMCO	2075	0001-2277	Mini-mast	n/a	n/a	n/a
00073	EMCO	2080	0002-1002	Turn Table	n/a	n/a	n/a
00081	ESPEC	ECT-2	0510154-B	Environmental Chamber	NCR	n/a	CNR
00234	VWR	61161-378	140320430	Temp/Humidity Meter	New	Triennial	New
00263	Koaxis	KP10-1.00M-TD	263	1m Armoured Cable	COU	n/a	COU
00264	Koaxis	KP10-7.00M-TD	264	7m Armoured Cable	COU	n/a	COU
00275	TMS	LMR400	n/a	25m Cable	COU	n/a	COU
00276	TMS	LMR400	n/a	4m Cable	COU	n/a	COU
00278	TILE	34G3	n/a	TILE Test Software	NCR	n/a	NCR

NCR: No Calibration Required

COU: Calibrate On Use

APPENDIX C – MEASUREMENT INSTRUMENT UNCERTAINTY

CISPR 16-4 Measurement Uncertainty (U_{LAB})	
This uncertainty represents an expanded uncertainty expressed at approximately the 95% confidence interval using a coverage factor of k=2	
Radiated Emissions 30MHz - 200MHz	
U _{LAB} = 5.14dB U _{CISPR} = 6.3dB	
Radiated Emissions 200MHz - 1000MHz	
U _{LAB} = 5.90dB U _{CISPR} = 6.3dB	
Radiated Emissions 1GHz - 6GHz	
U _{LAB} = 4.80dB U _{CISPR} = 5.2dB	
Radiated Emissions 6GHz - 18GHz	
U _{LAB} = 5.1dB U _{CISPR} = 5.5dB	
Power Line Conducted Emissions 9kHz to 150kHz	
U _{LAB} = 2.96dB U _{CISPR} = 3.8dB	
Power Line Conducted Emissions 150kHz to 30MHz	
U _{LAB} = 3.12dB U _{CISPR} = 3.4dB	
If the calculated uncertainty U _{lab} is less than U _{CISPR} then:	
1	Compliance is deemed to occur if NO measured disturbance exceeds the disturbance limit
2	Non-Compliance is deemed to occur if ANY measured disturbance EXCEEDS the disturbance limit
If the calculated uncertainty U _{lab} is greater than U _{CISPR} then:	
3	Compliance is deemed to occur if NO measured disturbance, increased by (U _{lab} - U _{CISPR}), exceeds the disturbance limit
4	Non-Compliance is deemed to occur if ANY measured disturbance, increased by (U _{lab} - U _{CISPR}), EXCEEDS the disturbance limit

Other Measurement Uncertainties (U_{LAB})	
RF Conducted Emissions 9kHz - 40GHz	
U _{LAB} = 1.0dB U _{CISPR} = n/a	
Frequency/Bandwidth 9kHz - 40GHz	
U _{LAB} = 0.1ppm U _{CISPR} = n/a	
Temperature	
U _{LAB} = 1°C U _{CISPR} = n/a	

END OF REPORT

APPENDIX D – CONDUCTED POWER MEASUREMENT PLOTS

APPENDIX E – CONDUCTED SPURIOUS EMISSIONS MEASUREMENT PLOTS

APPENDIX F – RADIATED TX EMISSIONS MEASUREMENT PLOTS

APPENDIX G – RADIATED RX EMISSIONS MEASUREMENT PLOTS