

Rogers Labs, a division of The Compatibility Center LLC

7915 Nieman Rd.
Lenexa, KS 66214
Phone / Fax (913) 660-0666

47CFR, PART 15C - Intentional Radiators
47CFR Paragraph 15.247 and
Industry Canada RSS-247 Issue 3 and RSS-GEN Issue 5
Application For Grant of Certification
Model: A04854
2402-2480 and 2412-2462 MHz Digital Transmission System (DTS)

FCC ID: IPH-04854
IC: 1792A-04854

Garmin International, Inc.

1200 East 151st Street
Olathe, KS 66062
Tim Olson
Senior Compliance Engineer

Test Report Number: 240211

Test Date: February 11, 2024

Authorized Signatory: 

Patrick Powell
Rogers Labs, a division of The Compatibility Center LLC
FCC Designation: US5305
ISED Registration: 3041A

This report shall not be reproduced except in full, without the written approval of the laboratory. This report must not be used by the client to claim product certification, approval, or endorsement by NVLAP, NIST, or any agency of the U.S. Government.

TABLE OF CONTENTS..... 2

REVISIONS..... 5

EXECUTIVE SUMMARY 6

OPINION / INTERPRETATION OF RESULTS 7

EQUIPMENT TESTED..... 9

 Equipment Operational Modes.....10

 Equipment Function11

 Equipment Configuration.....12

APPLICATION FOR CERTIFICATION..... 13

TEST SITE LOCATIONS 14

UNITS OF MEASUREMENTS 14

ENVIRONMENTAL CONDITIONS..... 15

STATEMENT OF MODIFICATIONS AND DEVIATIONS 15

APPLICABLE STANDARDS..... 15

INTENTIONAL RADIATORS..... 16

 Antenna Requirements16

TEST PROCEDURES..... 16

 AC Line Conducted Emission Test Procedure16

 Radiated Emission Procedure16

 Antenna Port Conducted Emission Test Procedure.....17

 Diagram 1 Test arrangement for power-line conducted emissions.....17

 Diagram 2 Test arrangement for radiated emissions of tabletop equipment.....18

 Diagram 3 Test arrangement for radiated emissions tested in Semi-Anechoic Chamber (SAC) and Outdoor Area Test Site (OATS)20

Diagram 4 Test arrangement for Antenna Port Conducted emissions.....21

RESTRICTED BANDS OF OPERATION 21

Table 1 Radiated Emissions in Restricted Frequency Bands Data Mode 2, BT 2EDR.....22

Table 2 Radiated Emissions in Restricted Frequency Bands Data Mode 3, BT 3EDR.....23

Table 3 Radiated Emissions in Restricted Frequency Bands Data Mode 4, BT BLE24

Table 4 Radiated Emissions in Restricted Frequency Bands Data Mode 5, 802.11b25

Table 5 Radiated Emissions in Restricted Frequency Bands Data Mode 6, 802.11g26

Table 6 Radiated Emissions in Restricted Frequency Bands Data Mode 7, 802.11n27

Summary of Results for Radiated Emissions in Restricted Bands27

AC LINE CONDUCTED EMI PROCEDURE..... 27

Figure 1 AC Line Conducted Emissions Data L1 (#3, EUT – Computer).....29

Figure 2 AC Line Conducted Emissions Data L2 (#3, EUT – Computer).....30

Table 7 AC Line Conducted Emissions Data L1 (#3, EUT – Computer).....30

Table 8 AC Line Conducted Emissions Data L2 (#3, EUT – Computer).....31

Summary of Results for AC Line Conducted Emissions31

GENERAL RADIATED EMISSIONS PROCEDURE..... 32

Table 9a General Radiated Emissions Data – Worst Case (Horizontal Polarization)32

Table 9b General Radiated Emissions Data – Worst Case (Vertical Polarization).....33

Summary of Results for General Radiated Emissions33

OPERATION IN THE BAND 2400 – 2483.5 MHZ 34

Figure 3 Plot of Transmitter Operation in 2402-2480 MHz Mode 2, BT 2EDR.....35

Figure 4 Plot of Transmitter Operation in 2402-2480 MHz Mode 3, BT 3EDR.....36

Figure 5 Plot of Transmitter Operation in 2402-2480 MHz Mode 4, BT BLE37

Figure 6 Plot of Transmitter Operation in 2402-2480 MHz Mode 5, 802.11b38

Figure 7 Plot of Transmitter Operation in 2402-2480 MHz Mode 6, 802.11g39

Figure 8 Plot of Transmitter Operation in 2402-2480 MHz Mode 7, 802.11n40

Figure 9 Plot of Emissions Low Band Edge Mode 2, BT 2EDR.....41

Figure 10 Plot of Emissions Low Band Edge Mode 3, BT 3EDR.....42

Figure 11 Plot of Emissions Low Band Edge Mode 4, BT BLE43

Figure 12 Plot of Emissions Low Band Edge Mode 4, 802.11b44

Figure 13 Plot of Emissions Low Band Edge Mode 4, 802.11g.....45

Figure 14 Plot of Emissions Low Band Edge Mode 4, 802.11n46

Figure 15 Plot of Transmitter Emissions High Band Edge Mode 2, BT 2EDR47

Figure 16 Plot of Transmitter Emissions High Band Edge Mode 3, BT 3EDR48

Figure 17 Plot of Transmitter Emissions High Band Edge Mode 4, BT BLE.....49

Figure 18 Plot of Transmitter Emissions High Band Edge Mode 5, 802.11b.....50

Figure 19 Plot of Transmitter Emissions High Band Edge Mode 6, 802.11g.....51

Figure 20 Plot of Transmitter Emissions High Band Edge Mode 7, 802.11n.....52

Figure 21 Plot of 6-dB Occupied Bandwidth Mode 2, BT 2EDR.....53

Figure 22 Plot of 99% Occupied Bandwidth Mode 2, BT 2EDR.....54

Figure 23 Plot of 6-dB Occupied Bandwidth Mode 3, BT 3EDR.....55

Figure 24 Plot of 99% Occupied Bandwidth Mode 3, BT 3EDR56

Figure 25 Plot of 6-dB Occupied Bandwidth Mode 4, BT BLE57

Figure 26 Plot of 99% Occupied Bandwidth Mode 4, BT BLE.....58

Figure 27 Plot of 6-dB Occupied Bandwidth Mode 5, 802.11b59

Figure 28 Plot of 99% Occupied Bandwidth Mode 5, 802.11b.....60

Figure 29 Plot of 6-dB Occupied Bandwidth Mode 6, 802.11g.....61

Figure 30 Plot of 99% Occupied Bandwidth Mode 6, 802.11g.....62

Figure 31 Plot of 6-dB Occupied Bandwidth Mode 7, 802.11n63

Figure 32 Plot of 99% Occupied Bandwidth Mode 7, 802.11n.....64

Figure 33 Plot of Transmitter Power Spectral Density Mode 2, BT 2EDR65

Figure 34 Plot of Transmitter Power Spectral Density Mode 3, BT 3EDR66

Figure 35 Plot of Transmitter Power Spectral Density Mode 4, BT BLE67

Figure 36 Plot of Transmitter Power Spectral Density Mode 5, 802.11b68

Figure 37 Plot of Transmitter Power Spectral Density Mode 6, 802.11g69

Figure 38 Plot of Transmitter Power Spectral Density Mode 7, 802.11n70

TRANSMITTER EMISSIONS DATA..... 71

Table 10 Transmitter Radiated Emissions Mode 2, BT 2EDR71

Table 11 Transmitter Radiated Emissions Mode 3, BT 3EDR72

Table 12 Transmitter Radiated Emissions Mode 4, BT BLE73

Table 13 Transmitter Radiated Emissions Mode 5, 802.11b74

Table 14 Transmitter Radiated Emissions Mode 6, 802.11g75

Table 15 Transmitter Radiated Emissions Mode 7, 802.11n76

Table 16 Transmitter Antenna Port Conducted Data modes 2 through 477

Table 17 Transmitter Antenna Port Conducted Data modes 5 through 778

Summary of Results for Transmitter Radiated Emissions of Intentional Radiator.....78

ANNEX..... 79

Annex A Measurement Uncertainty Calculations.....80

Annex B Test Equipment.....81

Annex C Laboratory Certificate of Accreditation.....83

Revisions

Revision 1 Issued May 28, 2024

Executive Summary

The following information is submitted for consideration in obtaining Grant of Certification for License Exempt Digital Transmission System Intentional Radiator operating under Code of Federal Regulations Title 47 (47CFR) Part 15C paragraph 15.247, Industry Canada RSS-247 Issue 3, and RSS-GEN Issue 5, operation in the 2400 – 2483.5 MHz band.

Name of Applicant: Garmin International, Inc.
 1200 East 151st Street
 Olathe, KS 66062

PMN: A04854

FCC ID: IPH-04854 IC: 1792A-04854

Operating Frequency Range: 2402-2480 MHz

A04854 was chosen for transmitter configuration testing and used for final measurements.

Operational communication modes 2 through 7:

Mode	Power (Watts)	99% OBW (kHz)	6-dB OBW (kHz)
Mode 2, BT (2EDR $\pi/4$ DQPSK)	0.004	1,205.3	1,072.5
Mode 3, BT (3EDR 8DPSK)	0.004	1,197.0	1,072.5
Mode 4, BT BLE (GMSK)	0.004	1,054.5	720.0
Mode 5, 802.11b	0.048	11,512.5	8,605.0
Mode 6, 802.11g	0.040	17,040.0	16,000.0
Mode 7, 802.11n	0.047	18,160.0	17,110.0

This report addresses EUT Operations as Digital Transmission System using transmitter modulations in modes 2 through 7. Note, the production device utilizes a non-user accessible integral antenna system with 3.5 dBi gain.

Opinion / Interpretation of Results

Tests Performed	Margin (dB)	Results
Restricted Band Emissions 15.205, RSS-GEN, RSS-247	-0.5	Complies
AC Line Emissions as per 47CFR 15.207, RSS-GEN 8.8	-11.18	Complies
Radiated Emissions 47 CFR 15.209, RSS-GEN 8.9	-5.3	Complies
Harmonic Emissions per 47CFR 15.247, RSS-247	-0.2	Complies
Power Spectral Density per 47CFR 15.247, RSS-247	-11.0	Complies

Tests performed include:

47CFR 15.247

(a) (2) Systems using digital modulation techniques may operate in the 902-928 MHz, 2400-2483.5 MHz, and 5725-5850 MHz bands. The minimum 6 dB bandwidth shall be at least 500 kHz.

(b) The maximum peak conducted output power of the intentional radiator shall not exceed the following:

(3) For systems using digital modulation in the 902-928 MHz, 2400-2483.5 MHz, and 5725-5850 MHz bands: 1 Watt. As an alternative to a peak power measurement, compliance with the one-Watt limit can be based on a measurement of the maximum conducted output power. Maximum Conducted Output Power is defined as the total transmit power delivered to all antennas and antenna elements averaged across all symbols in the signaling alphabet when the transmitter is operating at its maximum power control level. Power must be summed across all antennas and antenna elements. The average must not include any time intervals during which the transmitter is off or is transmitting at a reduced power level. If multiple modes of operation are possible (e.g., alternative modulation methods), the *maximum conducted output power* is the highest total transmit power occurring in any mode.

(d) In any 100 kHz bandwidth outside the frequency band in which the spread spectrum or digitally modulated intentional radiator is operating, the radio frequency power that is produced by the intentional radiator shall be at least 20 dB below that in the 100 kHz bandwidth within the band that contains the highest level of the desired power, based on either an RF conducted or a radiated measurement, provided the transmitter demonstrates compliance with the peak conducted power limits. If the transmitter complies with the conducted power limits based on the use of RMS averaging over a time interval, as permitted under paragraph (b)(3) of this section, the attenuation required under this paragraph shall be 30 dB instead of 20 dB. Attenuation below the general limits specified in §15.209(a) is not required. In addition, radiated emissions which fall in the

restricted bands, as defined in §15.205(a), must also comply with the radiated emission limits specified in §15.209(a) (see §15.205(c)).

(e) For digitally modulated systems, the power spectral density conducted from the intentional radiator to the antenna shall not be greater than 8 dBm in any 3 kHz band during any time interval of continuous transmission. This power spectral density shall be determined in accordance with the provisions of paragraph (b) of this section. The same method of determining the conducted output power shall be used to determine the power spectral density.

RSS-247 Issue 3

5.2 Digital transmission systems

DTS's include systems that employ digital modulation techniques resulting in spectral characteristics similar to direct sequence systems. The following applies to the bands 902-928 MHz and 2400-2483.5 MHz

- a) The minimum 6 dB bandwidth shall be 500 kHz.
- b) The transmitter power spectral density conducted from the transmitter to the antenna shall not be greater than 8 dBm in any 3 kHz band during any time interval of continuous transmission. This power spectral density shall be determined in accordance with the provisions of section 5.4(d), (i.e., the power spectral density shall be determined using the same method as is used to determine the conducted output power).

5.4 Transmitter output power and equivalent isotropically radiated power (e.i.r.p.) requirements

Devices shall comply with the following requirements, where applicable:

- d) For DTS's employing digital modulation techniques operating in the bands 902-928 MHz and 2400-2483.5 MHz, the maximum peak conducted output power shall not exceed 1 W. The e.i.r.p. shall not exceed 4 W, except as provided in section 5.4(e).

5.5 Unwanted emissions

In any 100 kHz bandwidth outside the frequency band in which the spread spectrum or digitally modulated device is operating, the RF power that is produced shall be at least 20 dB below that in the 100 kHz bandwidth within the band that contains the highest level of the desired power, based on either an RF conducted or a radiated measurement, provided that the transmitter demonstrates compliance with the peak conducted power limits. If the transmitter complies with the conducted power limits based on the use of root-mean-square averaging over a time interval, as permitted under section 5.4(d), the attenuation required shall be 30 dB instead of 20 dB. Attenuation below the general field strength limits specified in RSS-Gen is not required.

Equipment Tested

Model: A04854

Garmin International, Inc.

1200 East 151st Street

Olathe, KS 66062

<u>Equipment</u>	<u>Model / PN</u>	<u>Serial Number</u>
EUT Tx Radiated #1	A04854	8BV000017
EUT Antenna Port Conducted #2	A04854	8BW000009
Power Mount	011-05511-60	N/A
Power Mount w/ video & traffic	011-05511-00	N/A
USB Cable	320-01545-00	N/A
CLA	320-01372-00	N/A
Bare wire 10 pin power cable	320-01372-02	N/A
DC Power Supply	BK 1745	209C13
Laptop Computer	Latitude 7480	EFSPSN2
USB Printer	Dell 0N5819	5D1SL61

Test results in this report relate only to the items tested. Worst-case configuration data recorded in this report.

The design may operate one transmitter chain at a time and is not capable of simultaneous transmission on more than one port.

Software (FVIN): 1.01 or higher; Antennas: 2.4 GHz PIFA (3.5 dBi), 5.1 GHz PIFA (4.1 dBi), 5.7 GHz PIFA (3.7 dBi)

Equipment Operational Modes

Mode	Transmitter Operation
1	BT BR (GFSK)
2	BT (2EDR $\pi/4$ DQPSK)
3	BT (3EDR 8DPSK)
4	BT BLE (GMSK)
5	802.11b
6	802.11g
7	802.11n
8	U-NII-1 802.11a
9	U-NII-1 802.11n
10	U-NII-1 802.11n40
11	U-NII-1 802.11ac80
12	U-NII-3 802.11a
13	U-NII-3 802.11n
14	U-NII-3 802.11n40
15	U-NII-3 802.11ac80

Equipment Function

The EUT is a GPS receiver, graphical display, and user interface unit providing GPS reception, graphical display of location, navigation, and other information for the user. The design offers use as a hand-held, transportation mounted or portable configuration for use in navigational applications. The design incorporates transmitter circuitry operating in the 2402-2480, 5150-5250, and 5725-5850 MHz frequency bands. The typical use configuration has the EUT attached to a magnetic power mount which provides connection to external power and other optional inputs/outputs. The design provides a Micro SD Card slot and USB-C interface port as presented below and wireless communications with compatible equipment. The EUT operates from direct current power provided external power or internal rechargeable battery. External power may be supplied through the magnetic power mount and installation vehicle, 12-V TA DC power cable, AC/DC power adapter, or compliant USB interface as documented in this report. The EUT was arranged as described by the manufacturer emulating typical user configurations for testing purposes. The EUT offers no other interface connections than those presented in the configuration options as described by the manufacturer and presented below. For testing purposes, the EUT received power from both internal and external power options and configurations. During testing, the test system was configured to operate in a manufacturer defined mode. The manufacturer provided test software for testing transmitter and equipment function. The software provided the ability to operate the transmitters at near 100% duty cycle for testing purposes. The testing mode of operation exceeds typical duty cycle operation of production equipment. As requested by the manufacturer the equipment was tested for emissions compliance using the available configurations with the worst-case data presented. Test results in this report relate only to the products described in this report.

Equipment Configuration

- 1) Unit operating off internal battery

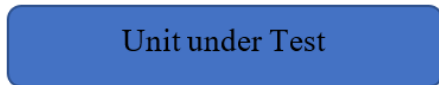

- 2) Unit connected through power mount, and power cable assembly (GPN: 320-01372-00 or 320-1372-02)



- 3) Unit connected to Computer USB port through cable assembly (GPN: 320-01462-00)



- 4) Unit connected to through power mount, and power cable assembly (GPN: 320-01372-00 or 320-1372-02)



Application for Certification

- (1) Manufacturer: Garmin International, Inc.
1200 East 151st Street
Olathe, KS 66062
- (2) Identification: HVIN: A04854
FCC ID: IPH-04854 IC: 1792A-04854
- (3) Instruction Book:
Refer to Exhibit for Instruction Manual.
- (4) Description of Circuit Functions:
Refer to Exhibit of Operational Description.
- (5) Block Diagram with Frequencies:
Refer to Exhibit of Operational Description.
- (6) Report of Measurements:
Report of measurements follows in this Report.
- (7) Photographs: Construction, Component Placement, etc.:
Refer to Exhibit for photographs of equipment.
- (8) List of Peripheral Equipment Necessary for operation. The equipment operates from external direct current power provided from installation vehicle. The EUT provides interface ports for power, loads and communications as presented in this filing.
- (9) Transition Provisions of 47CFR 15.37 are not requested.
- (10) Not Applicable. The unit is not a scanning receiver.
- (11) Not Applicable. The EUT does not operate in the 59 – 64 GHz frequency band.
- (12) The equipment is not software defined and this section is not applicable.
- (13) Applications for certification of U-NII devices in the 5.15-5.35 GHz and the 5.47-5.85 GHz bands must include a high-level operational description of the security procedures that control the radio frequency operating parameters and ensure that unauthorized modifications cannot be made. This requirement is not applicable to his DTS device.
- (14) Contain at least one drawing or photograph showing the test set-up for each of the required types of tests applicable to the device for which certification is requested. These drawings or photographs must show enough detail to confirm other information contained in the test report. Any photographs used must be focused originals without glare or dark spots and must clearly show the test configuration used. This information is provided in this report and Test Setup Exhibits provided with the application filing.

Test Site Locations

Conducted EMI AC line conducted emissions testing performed in a shielded screen room located at Rogers Labs, a division of The Compatibility Center LLC, 7915 Nieman Rd., Lenexa, KS (or satellite location).

Antenna port Antenna port conducted emissions testing was performed in a shielded screen room located at Rogers Labs, a division of The Compatibility Center LLC, 7915 Nieman Rd., Lenexa, KS (or satellite location).

Radiated EMI The radiated emissions tests were performed at the 3 meters Semi-Anechoic Chamber (SAC) located at Rogers Labs, a division of The Compatibility Center LLC, 7915 Nieman Rd., Lenexa, KS or at the 3 meters Outdoor Area Test Site (OATS) in the satellite location.

Registered Site information: FCC Site: US5305, ISED: 3041A, CAB Identifier: US0096

NVLAP Accreditation Lab code 200087-0

Units of Measurements

Conducted EMI Data presented in dBμV; dB referenced to one microvolt

Antenna port Conducted Data is in dBm; dB referenced to one milliwatt

Radiated EMI Data presented in dBμV/m; dB referenced to one microvolt per meter

Note: The limit is expressed for a measurement in dBμV/m when the measurement is taken at a distance of 3 or 10 meters. Data taken for this report was taken at distance of 3 meters. Sample calculation demonstrates corrected field strength reading for Semi-Anechoic Chamber using the measurement reading and correcting for receive antenna factor, cable losses, and amplifier gains.

Sample Calculation:

RFS = Radiated Field Strength, FSM = Field Strength Measured

A.F. = Receive antenna factor, Losses = attenuators/cable losses, Gain = amplification gains

$RFS (dB\mu V/m @ 3m) = FSM (dB\mu V) + A.F. (dB/m) + Losses (dB) - Gain (dB)$

Frequency: 9 kHz-30 MHz	Frequency: 30 MHz- 1 GHZ	Frequency: Above 1 GHZ
-------------------------	--------------------------	------------------------

Loop Antenna	Broadband Biconilog	Horn
RBW = 9 kHz	RBW = 120 kHz	RBW = 1 MHz
VBW = 30 kHz	VBW = 500 kHz	VBW = 3 MHz
Sweep time = Auto	Sweep time = Auto	Sweep time = Auto
Detector = PK, QP	Detector = PK, QP	Detector = PK, AV
Antenna Height 1m	Antenna Height 1-4m	Antenna Height 1-4m

Environmental Conditions

Ambient Temperature 22.6° C
 Relative Humidity 43.0 %
 Atmospheric Pressure 1010.9 mb

Statement of Modifications and Deviations

No modifications to the EUT were required for the equipment to demonstrate compliance with the 47CFR Part 15C, Industry Canada RSS-247 Issue 3, and RSS-GEN Issue 5 emission requirements. There were no deviations to the specifications.

Applicable Standards

The following information is submitted in accordance with the eCFR (electronic Title 47 Code of Federal Regulations) (47CFR), dated February 15, 2024: Part 2, Subpart J, Part 15C Paragraph 15.247, RSS-247 Issue 3, and RSS-GEN Issue 5. Test procedures used are the established Methods of Measurement of Radio-Noise Emissions as described in ANSI C63.10-2013. This report documents compliance for the EUT operations as Digital Transmission Systems operation.

Intentional Radiators

The following information is submitted supporting compliance with the requirements of 47CFR, Subpart C, paragraph 15.247, Industry Canada RSS-247 Issue 3, and RSS-GEN Issue 5.

Antenna Requirements

The EUT incorporates integral non-user accessible system. Production equipment offers no provision for connection to alternate antenna system. The antenna connection point complies with the unique antenna connection requirements. There are no deviations or exceptions to the specification.

Test Procedures

AC Line Conducted Emission Test Procedure

Testing for the AC line-conducted emissions were performed as required in CFR47 15B, RSS-GEN, and directed in ANSI C63.4-2014. The test setup, including the EUT, was arranged in the test configurations as presented during testing. The test configuration was placed on a 1 x 1.5-meter bench, 0.8 meters high located in a screen room. The power lines of the system were isolated from the power source using a standard LISN with a 50- μ Hy choke. EMI was coupled to the spectrum analyzer through a 0.1 μ F capacitor internal to the LISN. The LISN was positioned on the floor beneath the wooden bench supporting the EUT. The power lines and cables were draped over the back edge of the table. Refer to diagram one showing typical test arrangement and photographs in the test setup exhibit for EUT placement used during testing.

Radiated Emission Procedure

Radiated emissions testing was performed as required in 47CFR 15C, RSS-247 Issue 3, RSS-GEN and specified in ANSI C63.10-2013. The EUT was placed on a rotating 0.9 x 1.2-meter platform, elevated as required above the ground plane at a distance of 3 meters from the FSM antenna. EMI energy was maximized by equipment placement permitting orientation in three orthogonal axes, raising, and lowering the FSM antenna, changing the antenna polarization, and by rotating the turntable. Each emission was maximized before data was taken and recorded. The frequency spectrum from 9 kHz to 25,000 MHz was searched for emissions

during preliminary investigation. Refer to diagrams two and three showing typical test setup. Refer to photographs in the test setup exhibits for specific EUT placement during testing.

Antenna Port Conducted Emission Test Procedure

The EUT was assembled as required for operation placed on a benchtop. This configuration provided the ability to connect test equipment to the provided test antenna port. Antenna Port conducted emissions testing was performed presented in the regulations and specified in ANSI C63.10-2013. Testing was completed on a laboratory bench in a shielded room. The active antenna port of the device was connected to appropriate attenuation and the spectrum analyzer. Refer to diagram 4 showing typical test arrangement and photographs in the test setup exhibits for specific EUT placement during testing.

Diagram 1 Test arrangement for power-line conducted emissions

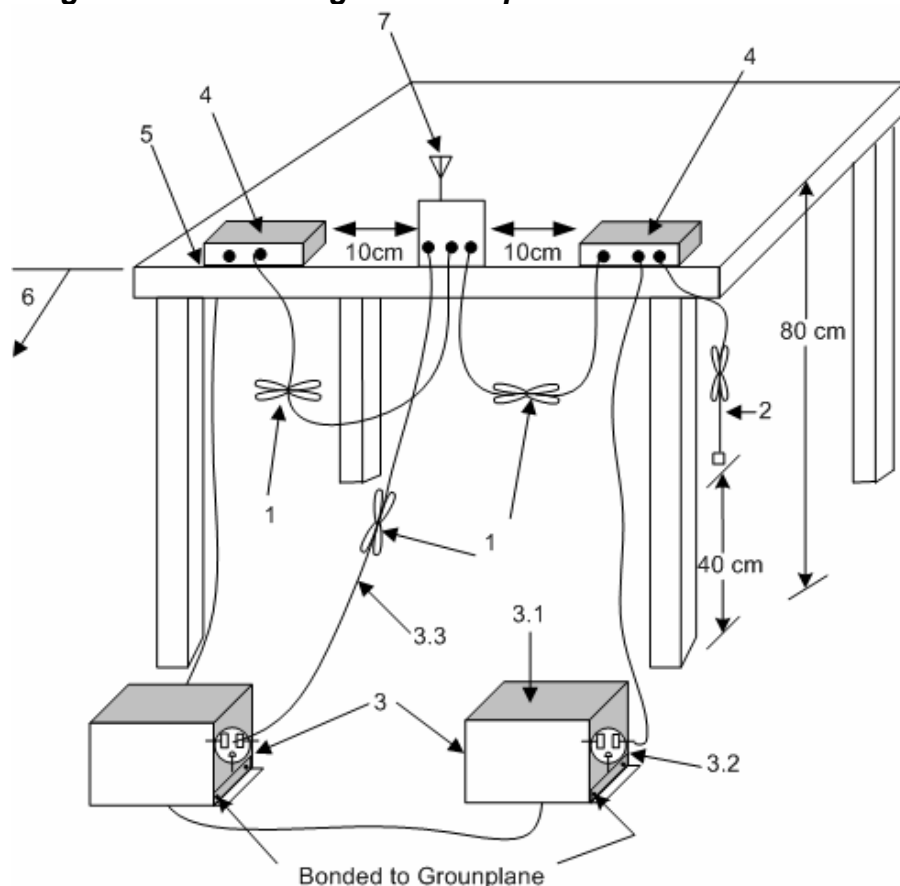

- 1. Interconnecting cables that hang closer than 40 cm to the ground plane shall be folded back and forth in the center forming a bundle 30 cm to 40 cm long see (see 6.2.3.1).

2. I/O cables that are not connected to an accessory shall be bundled in the center. The end of the cable may be terminated, if required, using the correct terminating impedance. The overall length shall not exceed 1 m (see 6.2.2).
3. EUT connected to one LISN. Unused LISN measuring port connectors shall be terminated in 50 Ω loads. LISN can be placed on top of, or immediately beneath, reference ground plane (see 6.2.2 and 6.2.3).
 - 3.1 All other equipment powered from additional LISN(s).
 - 3.2 Multiple-outlet strip can be used for multiple power cords of non-EUT equipment.
 - 3.3 LISN at least 80 cm from nearest part of EUT chassis.
4. Non-EUT components of EUT system being tested.
5. Rear of EUT, including peripherals, shall all be aligned and flush with rear of tabletop (see 6.2.3.1).
6. Edge of tabletop shall be 40 cm removed from a vertical conducting plane that is bonded to the ground plane (see 6.2.2 for options).
7. Antenna may be integral or detachable. If detachable, the antenna shall be attached for this test

Diagram 2 Test arrangement for radiated emissions of tabletop equipment

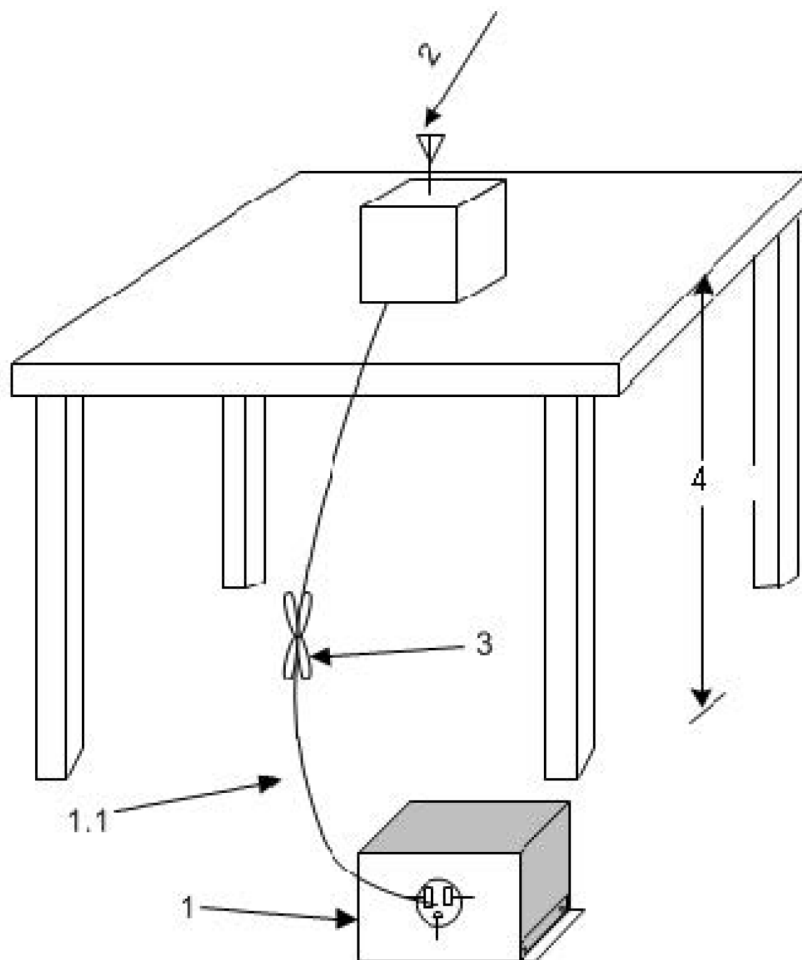

1. A LISN is optional for radiated measurements between 30 MHz and 1000 MHz but not allowed for measurements below 30 MHz and above 1000 MHz (see 6.3.1). If used, then connect EUT to one LISN. Unused LISN measuring port connectors shall be terminated in 50 Ω loads. The LISN may be placed on top of, or immediately beneath, the reference ground plane (see 6.2.2 and 6.2.3.2).
 - 1.1. LISN spaced at least 80 cm from the nearest part of the EUT chassis.
2. Antenna can be integral or detachable, depending on the EUT (see 6.3.1).
3. Interconnecting cables that hang closer than 40 cm to the ground plane shall be folded back and forth in the center forming a bundle 30 cm to 40 cm long (see 6.3.1).
4. For emission measurements at or below 1 GHz, the table height shall be 80 cm. For emission measurements above 1 GHz, the table height shall be 1.5 m for measurements, except as otherwise specified (see 6.3.1 and 6.6.3.1).

Diagram 3 Test arrangement for radiated emissions tested in Semi-Anechoic Chamber (SAC) and Outdoor Area Test Site (OATS)

Below 1 GHz

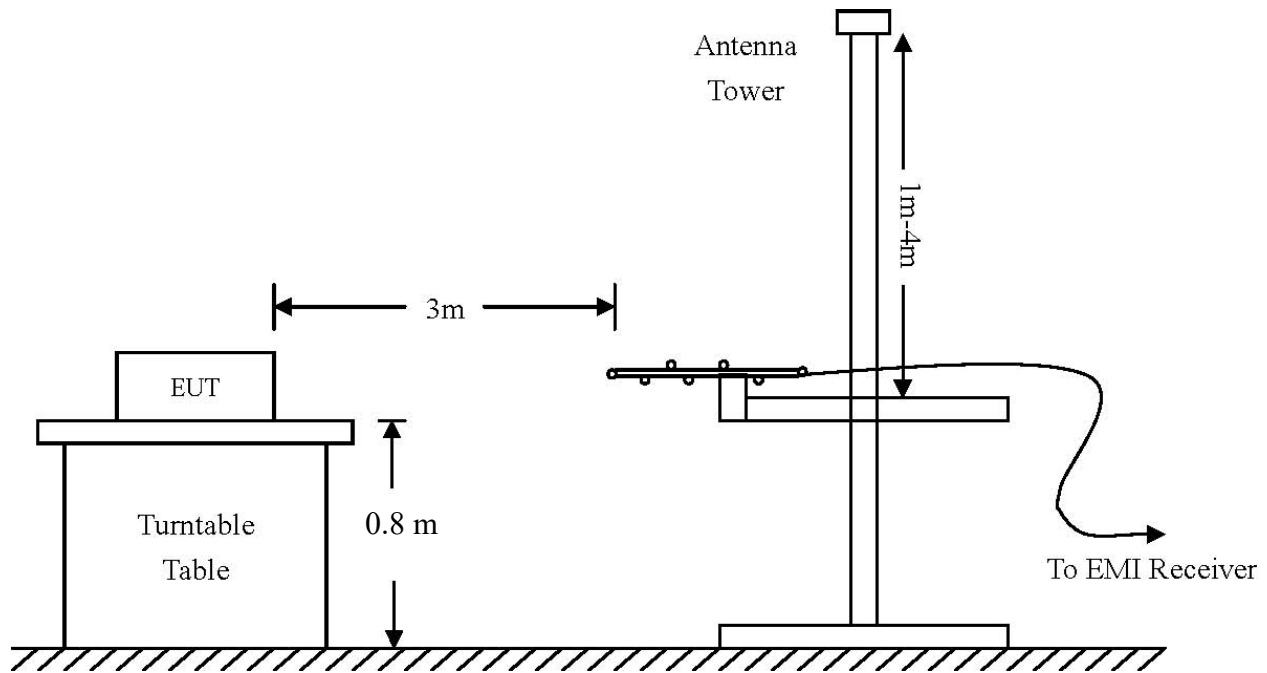

Above 1 GHz:

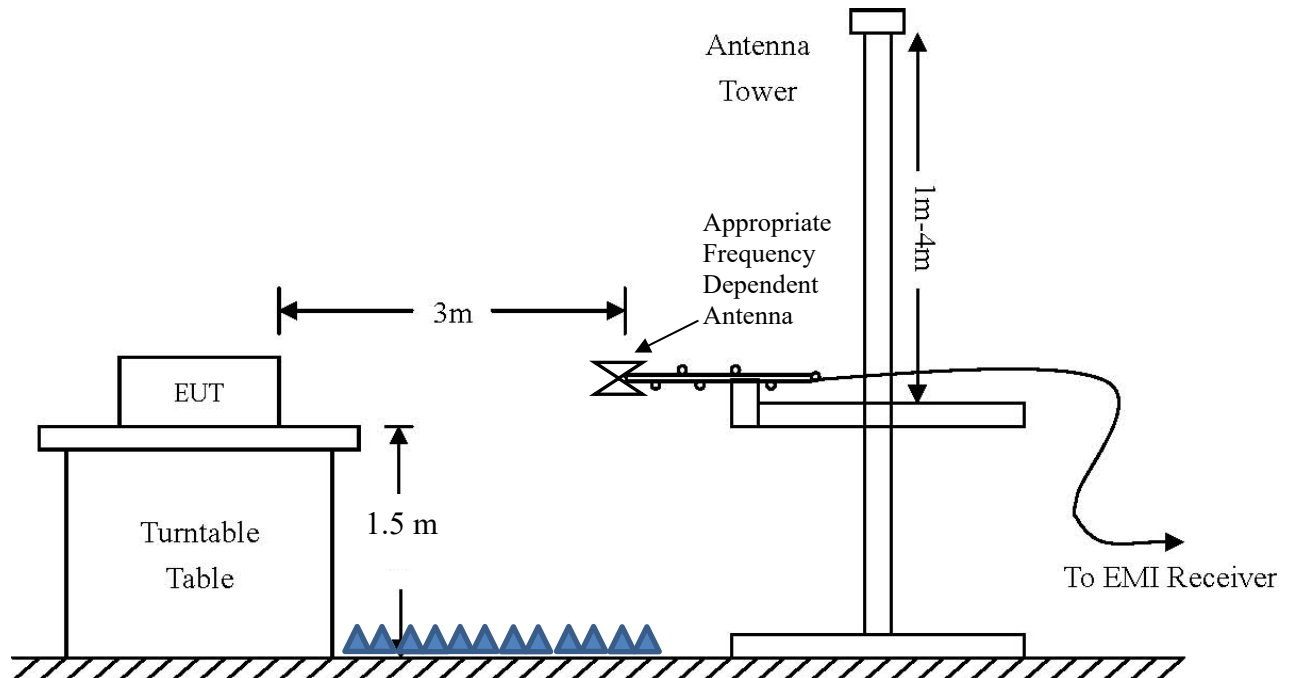
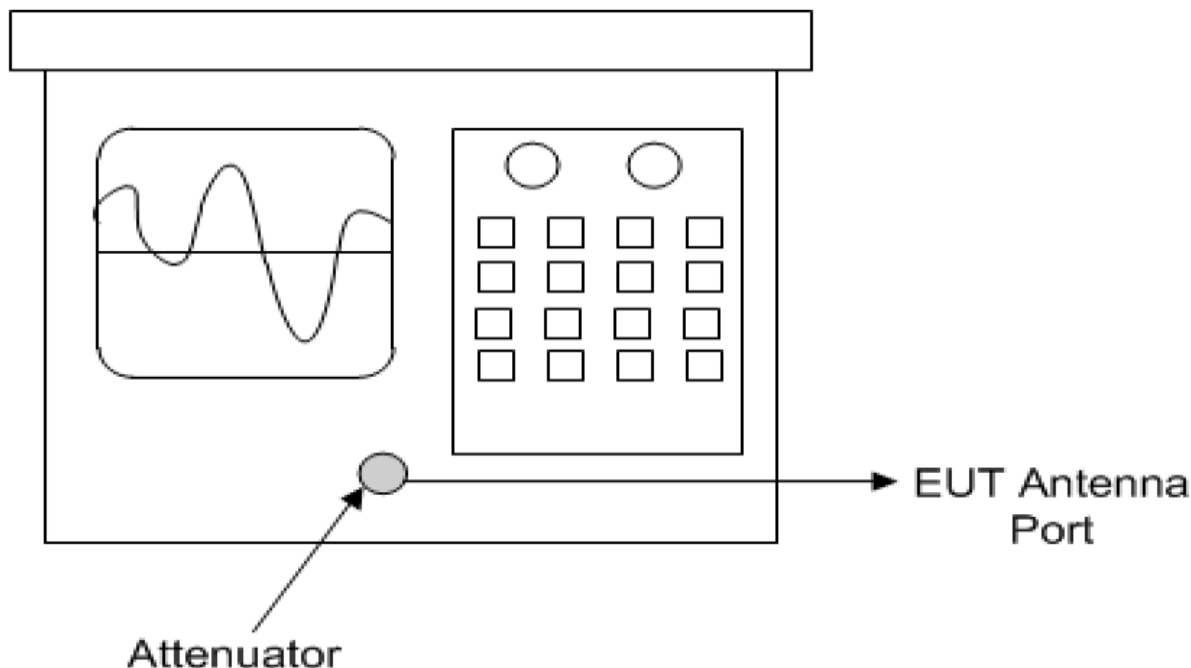

Diagram 4 Test arrangement for Antenna Port Conducted emissions
Spectrum Analyzer



Restricted Bands of Operation

Spurious emissions falling in the restricted frequency bands of operation were measured at the SAC. The EUT utilizes frequency, determining circuitry, which generates harmonics falling in the restricted bands. Emissions were investigated at the SAC, using appropriate antennas or pyramidal horns, amplification stages, and a spectrum analyzer. Peak and average amplitudes of frequencies above 1000 MHz were compared to the required limits with worst-case data presented below. Test procedures of ANSI C63.10-2013 were used during testing. No other significant emission was observed which fell into the restricted bands of operation. Computed emission values consider the received radiated field strength, receive antenna correction factor, amplifier gain stage, and test system cable losses.

Table 1 Radiated Emissions in Restricted Frequency Bands Data Mode 2, BT 2EDR

Frequency in MHz	Horizontal Peak (dBμV/m)	Horizontal Average (dBμV/m)	Vertical Peak (dBμV/m)	Vertical Average (dBμV/m)	Limit @ 3m (dBμV/m)	Horizontal Margin (dB)	Vertical Margin (dB)
2390.0	48.1	34.6	48.9	34.5	54.0	-19.4	-19.5
2483.5	49.3	35.5	49.8	35.7	54.0	-18.5	-18.3
4804.0	50.9	36.9	50.7	36.9	54.0	-17.1	-17.1
4880.0	51.2	37.0	50.9	37.0	54.0	-17.0	-17.0
4960.0	51.4	37.3	51.3	37.5	54.0	-16.7	-16.5
7206.0	54.6	41.4	54.6	41.3	54.0	-12.6	-12.7
7320.0	55.4	41.4	55.1	41.4	54.0	-12.6	-12.6
7440.0	55.6	41.3	55.4	41.3	54.0	-12.7	-12.7
12010.0	60.1	46.9	60.4	46.8	54.0	-7.1	-7.2
12200.0	60.6	47.3	61.1	47.3	54.0	-6.7	-6.7
12400.0	61.1	47.3	60.7	47.3	54.0	-6.7	-6.7

Other emissions present had amplitudes at least 20 dB below the limit. Peak and Quasi-Peak amplitude emissions are recorded for frequency below 1000 MHz. Peak and Average amplitude emissions are recorded for frequency range above 1000 MHz.

Table 2 Radiated Emissions in Restricted Frequency Bands Data Mode 3, BT 3EDR

Frequency in MHz	Horizontal Peak (dBμV/m)	Horizontal Average (dBμV/m)	Vertical Peak (dBμV/m)	Vertical Average (dBμV/m)	Limit @ 3m (dBμV/m)	Horizontal Margin (dB)	Vertical Margin (dB)
2390.0	48.3	34.5	48.2	34.4	54.0	-19.5	-19.6
2483.5	49.7	35.5	35.5	35.9	54.0	-18.5	-18.1
4824.0	50.0	36.4	50.9	36.4	54.0	-17.6	-17.6
4874.0	50.3	36.7	50.3	36.8	54.0	-17.3	-17.2
4924.0	50.4	36.5	50.3	36.7	54.0	-17.5	-17.3
7236.0	54.7	41.3	54.9	41.3	54.0	-12.7	-12.7
7311.0	55.3	41.5	55.5	41.4	54.0	-12.5	-12.6
7386.0	55.7	41.3	55.5	41.4	54.0	-12.7	-12.6
12060.0	60.9	47.4	60.9	47.3	54.0	-6.6	-6.7
12185.0	62.1	47.9	61.8	47.9	54.0	-6.1	-6.1
12310.0	61.2	47.9	61.4	47.9	54.0	-6.1	-6.1

Other emissions present had amplitudes at least 20 dB below the limit. Peak and Quasi-Peak amplitude emissions are recorded for frequency below 1000 MHz. Peak and Average amplitude emissions are recorded for frequency range above 1000 MHz.

Table 3 Radiated Emissions in Restricted Frequency Bands Data Mode 4, BT BLE

Frequency in MHz	Horizontal Peak (dB μ V/m)	Horizontal Average (dB μ V/m)	Vertical Peak (dB μ V/m)	Vertical Average (dB μ V/m)	Limit @ 3m (dB μ V/m)	Horizontal Margin (dB)	Vertical Margin (dB)
2390.0	48.1	34.6	47.9	34.5	54.0	-19.4	-19.5
2483.5	49.3	35.5	49.1	35.5	54.0	-18.5	-18.5
4824.0	50.5	36.4	50.6	36.6	54.0	-17.6	-17.4
4874.0	50.5	36.8	50.6	36.8	54.0	-17.2	-17.2
4924.0	50.4	36.6	50.2	36.7	54.0	-17.4	-17.3
7236.0	54.9	41.6	55.3	41.3	54.0	-12.4	-12.7
7311.0	56.5	42.8	55.0	41.5	54.0	-11.2	-12.5
7386.0	55.3	41.3	55.0	41.4	54.0	-12.7	-12.6
12060.0	61.3	47.5	60.8	47.5	54.0	-6.5	-6.5
12185.0	62.0	48.2	61.6	48.2	54.0	-5.8	-5.8
12310.0	61.5	47.9	61.5	47.8	54.0	-6.1	-6.2

Other emissions present had amplitudes at least 20 dB below the limit. Peak and Quasi-Peak amplitude emissions are recorded for frequency below 1000 MHz. Peak and Average amplitude emissions are recorded for frequency range above 1000 MHz.

Table 4 Radiated Emissions in Restricted Frequency Bands Data Mode 5, 802.11b

Frequency in MHz	Horizontal Peak (dB μ V/m)	Horizontal Average (dB μ V/m)	Vertical Peak (dB μ V/m)	Vertical Average (dB μ V/m)	Limit @ 3m (dB μ V/m)	Horizontal Margin (dB)	Vertical Margin (dB)
2390.0	51.6	36.9	49.9	36.3	54.0	-17.1	-17.7
2483.5	49.4	35.6	52.5	36.9	54.0	-18.4	-17.1
4824.0	51.7	37.0	51.8	38.0	54.0	-17.0	-16.0
4874.0	50.8	37.0	51.1	37.3	54.0	-17.0	-16.7
4924.0	51.6	37.5	51.3	37.2	54.0	-16.5	-16.8
7236.0	55.6	41.5	56.0	41.4	54.0	-12.5	-12.6
7311.0	56.0	42.1	55.4	41.6	54.0	-11.9	-12.4
7386.0	55.6	41.6	54.7	41.6	54.0	-12.4	-12.4
12060.0	61.0	47.3	60.8	47.2	54.0	-6.7	-6.8
12185.0	61.2	46.5	60.7	46.5	54.0	-7.5	-7.5
12310.0	61.7	47.6	61.1	47.6	54.0	-6.4	-6.4

Other emissions present had amplitudes at least 20 dB below the limit. Peak and Quasi-Peak amplitude emissions are recorded for frequency below 1000 MHz. Peak and Average amplitude emissions are recorded for frequency range above 1000 MHz.

Table 5 Radiated Emissions in Restricted Frequency Bands Data Mode 6, 802.11g

Frequency in MHz	Horizontal Peak (dB μ V/m)	Horizontal Average (dB μ V/m)	Vertical Peak (dB μ V/m)	Vertical Average (dB μ V/m)	Limit @ 3m (dB μ V/m)	Horizontal Margin (dB)	Vertical Margin (dB)
2390.0	65.3	45.7	66.4	45.9	54.0	-8.3	-8.1
2483.5	59.2	41.3	67.7	48.8	54.0	-12.7	-5.2
4824.0	50.9	37.0	51.0	37.2	54.0	-17.0	-16.8
4874.0	51.3	37.2	51.6	37.1	54.0	-16.8	-16.9
4924.0	50.6	37.1	51.3	37.1	54.0	-16.9	-16.9
7236.0	55.5	41.6	55.6	41.5	54.0	-12.4	-12.5
7311.0	56.5	42.2	55.7	41.6	54.0	-11.8	-12.4
7386.0	55.2	41.7	54.7	41.7	54.0	-12.3	-12.3
12060.0	60.7	47.1	60.7	47.2	54.0	-6.9	-6.8
12185.0	60.0	46.5	60.3	46.6	54.0	-7.5	-7.4
12310.0	61.3	47.8	61.9	47.7	54.0	-6.2	-6.3

Other emissions present had amplitudes at least 20 dB below the limit. Peak and Quasi-Peak amplitude emissions are recorded for frequency below 1000 MHz. Peak and Average amplitude emissions are recorded for frequency range above 1000 MHz.

Table 6 Radiated Emissions in Restricted Frequency Bands Data Mode 7, 802.11n

Frequency in MHz	Horizontal Peak (dB μ V/m)	Horizontal Average (dB μ V/m)	Vertical Peak (dB μ V/m)	Vertical Average (dB μ V/m)	Limit @ 3m (dB μ V/m)	Horizontal Margin (dB)	Vertical Margin (dB)
2390.0	71.9	52.1	73.1	53.4	54.0	-1.9	-0.6
2483.5	69.5	48.8	74.6	53.5	54.0	-5.2	-0.5
4824.0	50.9	37.1	51.4	37.2	54.0	-16.9	-16.8
4874.0	50.9	37.2	51.8	37.2	54.0	-16.8	-16.8
4924.0	51.2	37.2	50.7	37.2	54.0	-16.8	-16.8
7236.0	55.1	41.5	55.3	41.5	54.0	-12.5	-12.5
7311.0	56.7	42.4	55.0	41.7	54.0	-11.6	-12.3
7386.0	55.5	42.0	55.3	41.8	54.0	-12.0	-12.2
12060.0	61.2	47.5	60.6	47.4	54.0	-6.5	-6.6
12185.0	60.6	46.8	60.4	46.7	54.0	-7.2	-7.3
12310.0	61.6	47.9	61.5	47.9	54.0	-6.1	-6.1

Other emissions present had amplitudes at least 20 dB below the limit. Peak and Quasi-Peak amplitude emissions are recorded for frequency below 1000 MHz. Peak and Average amplitude emissions are recorded for frequency range above 1000 MHz.

Summary of Results for Radiated Emissions in Restricted Bands

The EUT demonstrated compliance with the radiated emissions requirements of 47CFR Part 15C and RSS-247 Issue 3 Intentional Radiator requirements. The EUT demonstrated a worst-case minimum margin of -0.5 dB below the emissions requirements in restricted frequency bands. Peak, Quasi-peak, and average amplitudes were checked for compliance with the regulations. Worst-case emissions are reported with other emissions found in the restricted frequency bands at least 20 dB below the requirements.

AC Line Conducted EMI Procedure

The EUT was arranged in typical equipment configurations as offered by manufacturer and presented above in equipment configuration. AC Line Conducted emission testing was

performed with the EUT placed on a 1 x 1.5-meter bench 80 cm above the conducting ground plane, floor of a screen room. The bench was positioned 40 cm away from the wall of the screen room. The LISN was positioned on the floor of the screen room 80-cm from the rear of the EUT. Testing for the AC line-conducted emissions followed the procedures of ANSI C63.10-2013. The EUT was configured as presented in the AC Line conducted configurations as directed by the manufacturer and presented above in equipment configuration. The AC adapter for the EUT was connected to the LISN for AC line-conducted emissions testing. A second LISN was positioned on the floor of the screen room 80-cm from the rear of the supporting equipment of the test configuration. All power cords except the EUT were then powered from the second LISN. EMI was coupled to the spectrum analyzer through a 0.1 μ F capacitor, internal to the LISN. Power line conducted emissions testing was carried out individually for each current carrying conductor of the EUT. The excess length of lead between the system and the LISN receptacle was folded back and forth to form a bundle not exceeding 40 cm in length. The screen room, conducting ground plane, analyzer, and LISN were bonded together to the protective earth ground. Preliminary testing was performed to identify the frequencies of each of the emissions, which demonstrated the highest amplitudes. The cables were repositioned to obtain maximum amplitude of measured EMI level. Once the worst-case configuration was identified, plots were made of the EMI from 0.15 MHz to 30 MHz and data recorded.

Refer to figure one and two for plots of the Configuration #3 EUT – USB Computer interface AC Line conducted emissions.

Figure 1 AC Line Conducted Emissions Data L1 (#3, EUT – Computer)

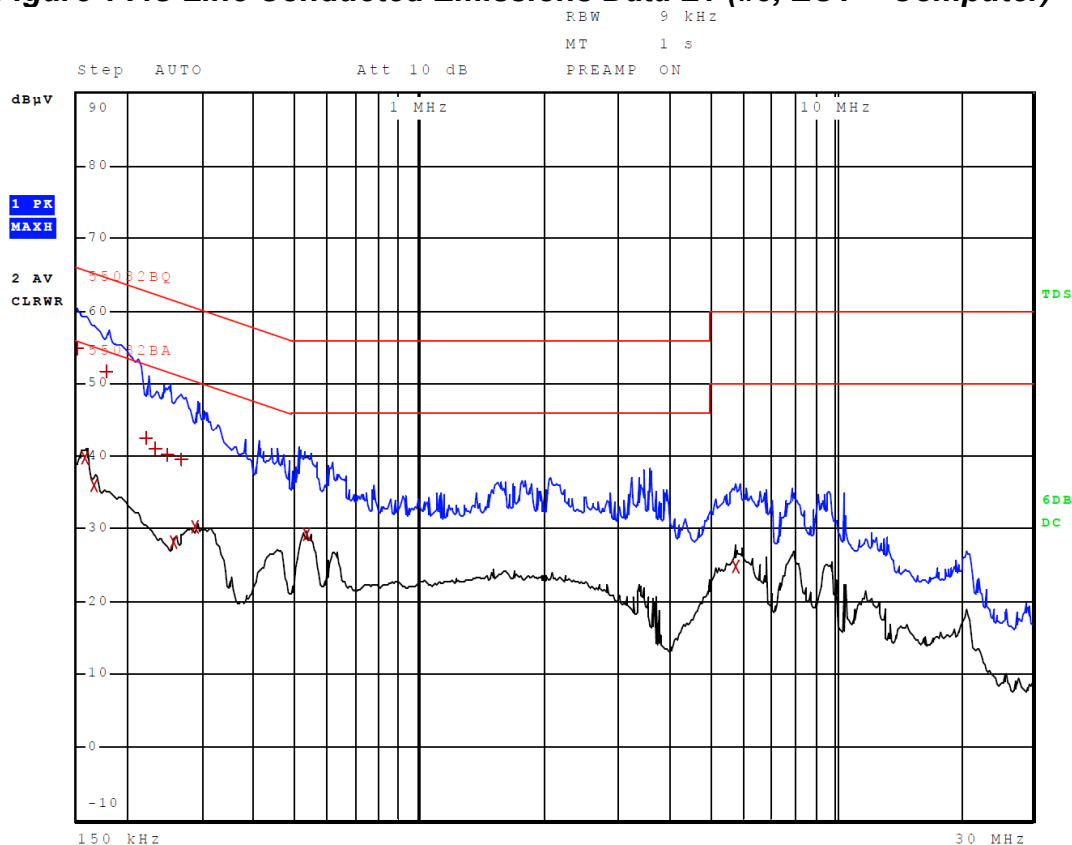

Other emissions present had amplitudes at least 20 dB below the limit.

Figure 2 AC Line Conducted Emissions Data L2 (#3, EUT – Computer)

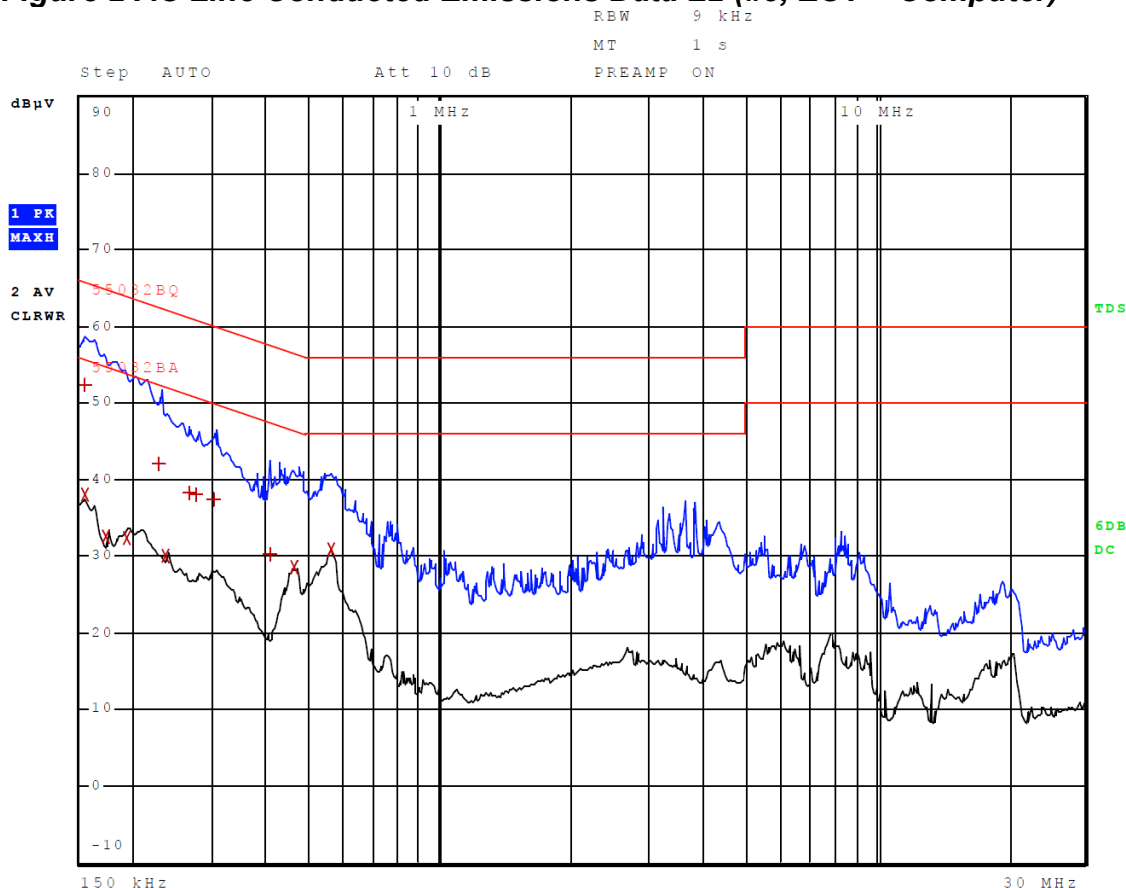

Other emissions present had amplitudes at least 20 dB below the limit.

Table 7 AC Line Conducted Emissions Data L1 (#3, EUT – Computer)

Trace	Frequency	Level (dBµV)	Detector	Delta Limit/dB
1	150.000000000 kHz	54.82	Quasi Peak	-11.18
2	158.000000000 kHz	39.59	Average	-15.98
2	166.000000000 kHz	35.97	Average	-19.19
1	178.000000000 kHz	51.58	Quasi Peak	-13.00
1	222.000000000 kHz	42.34	Quasi Peak	-20.41
1	234.000000000 kHz	40.93	Quasi Peak	-21.38
1	250.000000000 kHz	40.17	Quasi Peak	-21.59
2	258.000000000 kHz	28.13	Average	-23.36
1	266.000000000 kHz	39.42	Quasi Peak	-21.82
2	290.000000000 kHz	30.19	Average	-20.33
2	530.000000000 kHz	29.20	Average	-16.80
2	5.767900000 MHz	24.70	Average	-25.30

Other emissions present had amplitudes at least 20 dB below the limit.

Table 8 AC Line Conducted Emissions Data L2 (#3, EUT – Computer)

Trace	Frequency	Level (dBµV)	Detector	Delta Limit/dB
2	154.000000000 kHz	38.10	Average	-17.68
1	154.000000000 kHz	52.21	Quasi Peak	-13.57
2	174.000000000 kHz	32.54	Average	-22.23
2	194.000000000 kHz	32.25	Average	-21.61
1	230.000000000 kHz	42.04	Quasi Peak	-20.41
2	238.000000000 kHz	29.92	Average	-22.25
1	266.000000000 kHz	38.30	Quasi Peak	-22.94
1	278.000000000 kHz	37.95	Quasi Peak	-22.93
1	306.000000000 kHz	37.47	Quasi Peak	-22.61
1	406.000000000 kHz	30.23	Quasi Peak	-27.50
2	466.000000000 kHz	28.47	Average	-18.12
2	562.000000000 kHz	30.76	Average	-15.24

Other emissions present had amplitudes at least 20 dB below the limit.

Summary of Results for AC Line Conducted Emissions

The EUT demonstrated compliance with the AC Line Conducted Emissions requirements of 47CFR Part 15C, RSS-247 and RSS-Gen. The EUT configuration #3 demonstrated a minimum margin of -11.18 dB below the requirement. Other emissions were present with amplitudes at least 20 dB below the limit and worst-case amplitudes recorded.

General Radiated Emissions Procedure

Testing for the radiated emissions were performed as specified in CFR47 15B, RSS-GEN, and directed in ANSI C63.4-2014. For testing purposes, the EUT was arranged as presented in the applicable configuration diagrams above and operated through all modes as presented.

Exploratory radiated emissions measurements were performed in the SAC chamber or screen room, finding maximized emissions over frequency, EUT orientation, antenna height and polarity. This data is then used to focus the final radiated emissions measurements on these maximized points.

Final radiated emissions data were taken with the EUT located in the OATS or SAC at distance of 3 meters between the EUT and the receiving antenna. The frequency spectrum from 9 kHz to 6,000 MHz was searched for radiated emissions. Measured emission levels were maximized by EUT placement on the table, changing cable location, rotating the turntable through 360 degrees, varying the antenna height between 1 and 4 meters above the ground plane and changing antenna position between horizontal and vertical polarization. Antennas used were Loop, Biconical, Broadband Biconilog, Log Periodic, and Double Ridge or Pyramidal Horns and mixers above 1 GHz.

Table 9a General Radiated Emissions Data – Worst Case (Horizontal Polarization)

Frequency (MHz)	Peak (dB μ V/m)	Quasi-Peak (dB μ V/m)	Limit @ 3m (dB μ V/m)	Margin (dBm)
94.8	39.5	34.7	40.0	-5.3
296.1	43.6	38.6	47.0	-8.4
319.6	34.1	26.3	47.0	-20.7
352.4	35.5	28.7	47.0	-18.3
358.0	32.0	24.0	47.0	-23.0
531.1	37.2	31.1	47.0	-15.9

Other emissions present had amplitudes at least 20 dB below the limit. Peak and Quasi-Peak amplitude emissions are recorded for frequency range below 1000 MHz. Peak and Average amplitude emissions are recorded for frequency range above 1000 MHz.

Table 9b General Radiated Emissions Data – Worst Case (Vertical Polarization)

Frequency (MHz)	Peak (dB μ V/m)	Quasi-Peak (dB μ V/m)	Limit @ 3m (dB μ V/m)	Margin (dBm)
95.1	34.5	29.8	-40.0	-10.2
294.9	38.4	17.6	-47.0	-29.4
320.7	30.1	25.5	-47.0	-21.5
351.7	40.0	31.4	-47.0	-15.6
357.5	37.6	25.9	-47.0	-21.2
533.0	39.7	30.0	-47.0	-17.0

Other emissions present had amplitudes at least 20 dB below the limit. Peak and Quasi-Peak amplitude emissions are recorded for frequency range below 1000 MHz. Peak and Average amplitude emissions are recorded for frequency range above 1000 MHz.

Summary of Results for General Radiated Emissions

The EUT demonstrated compliance with the radiated emissions requirements of 47CFR Part 15C paragraph 15.209, RSS-247 Issue 3, and RSS-GEN Issue 5 Intentional Radiators. The EUT configuration demonstrated a minimum margin of -5.3 dB below the requirements. Other emissions were present with amplitudes at least 20 dB below the Limits.

Operation in the Band 2400 – 2483.5 MHz

Test procedures of ANSI C63.10-2013 paragraph 6, and KDB 558074 were used during transmitter testing. Test sample EUT Antenna Port Conducted #2 was provided for testing antenna port conducted emissions. This sample was modified by replacing the internal antenna with a 50-ohm antenna port connector and attenuator for testing purposes. The transmitter peak and average power was measured at the antenna port using a wideband RF power meter as described in KDB 558074 and ANSI C63.10-2013. Average power measured did not include any time intervals during which the transmitter was off or transmitting at a reduced power level. The peak Power Spectral Density (PKPSD) was measured as defined in KDB 558074 and ANSI C63.10-2013. DTS Emission bandwidth was measured as described in KDB 558074 and ANSI C63.10-2013. The amplitude of each harmonic and general radiated emission was measured on the SAC at distance of 3 meters from the FSM antenna (radiated emission testing was performed on EUT Tx Radiated #1 representative of production equipment with integral antenna). The EUT was positioned on supporting turntable elevated as required above the ground plane, at a distance of 3 meters from the FSM antenna. Radiated emission investigations were performed from 9 kHz to 25,000 MHz. Each radiated emission was maximized by varying the FSM antenna height and polarization, and by rotating the turntable. The worst-case amplitude of each emission was then recorded from the analyzer display. The peak and quasi-peak amplitude of frequencies below 1000 MHz were measured using a spectrum analyzer. The peak and average amplitude of frequencies above 1000 MHz were measured using a spectrum analyzer. A Loop antenna was used for measuring emissions from 0.009 to 30 MHz, Biconilog Antenna for 30 to 1000 MHz, Double-Ridge, and/or Pyramidal Horn Antennas from 1 GHz to 25 GHz. Radiated Emissions were measured in dB μ V/m @ 3 meters. Plots were taken of transmitter performance (using EUT Antenna Port Conducted #2) for reference in this and other documentation. These are shown in figures three through thirty eight.

Figure 3 Plot of Transmitter Operation in 2402-2480 MHz Mode 2, BT 2EDR

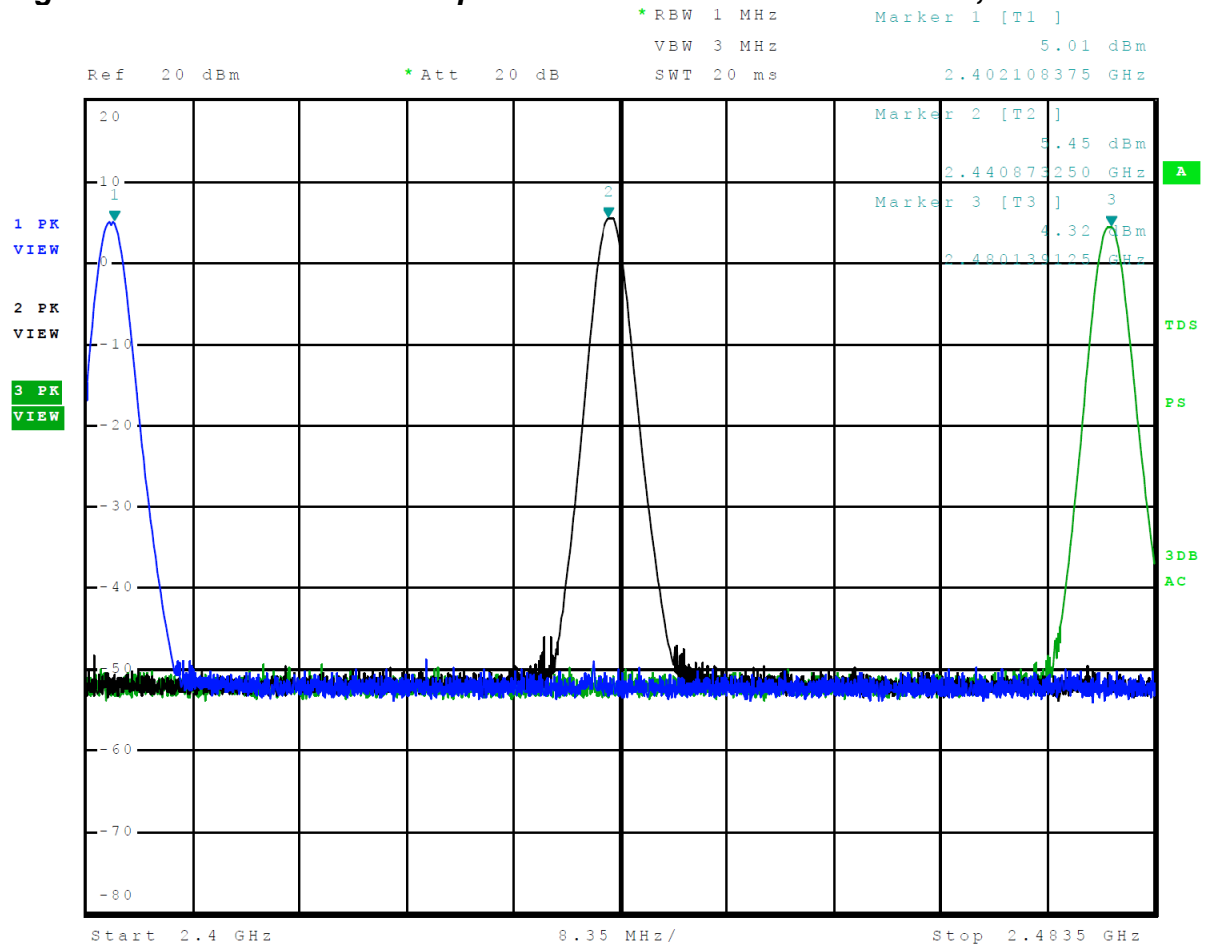

Figure 4 Plot of Transmitter Operation in 2402-2480 MHz Mode 3, BT 3EDR

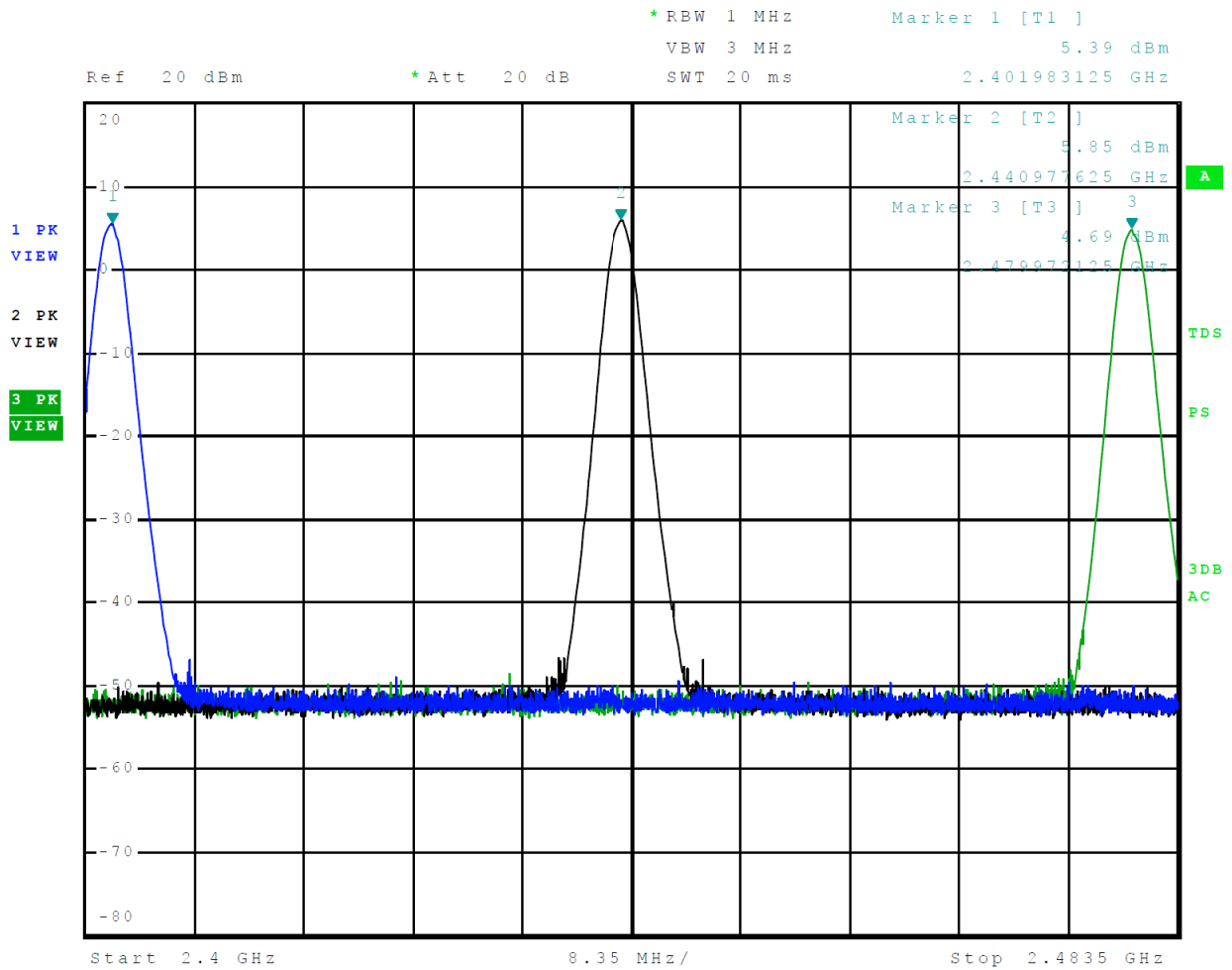

Figure 5 Plot of Transmitter Operation in 2402-2480 MHz Mode 4, BT BLE

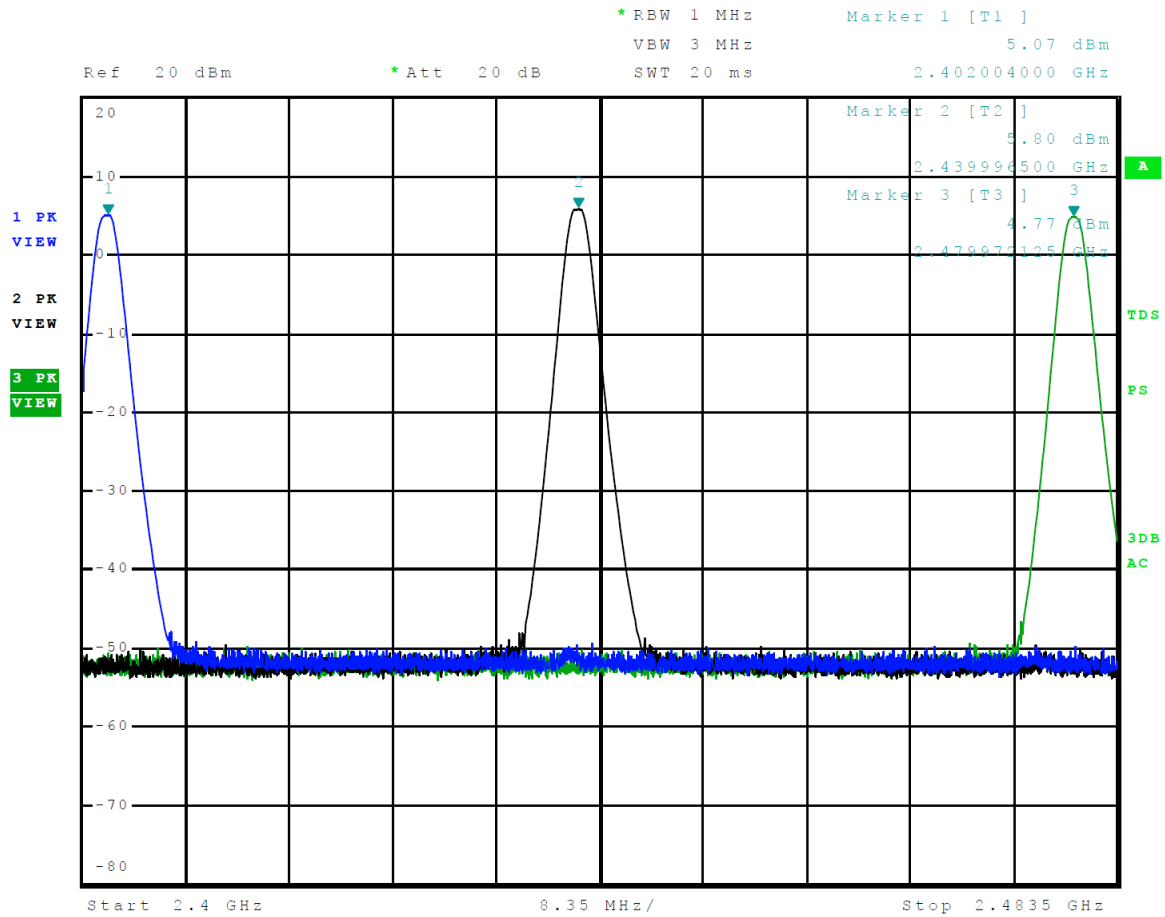

Figure 6 Plot of Transmitter Operation in 2402-2480 MHz Mode 5, 802.11b

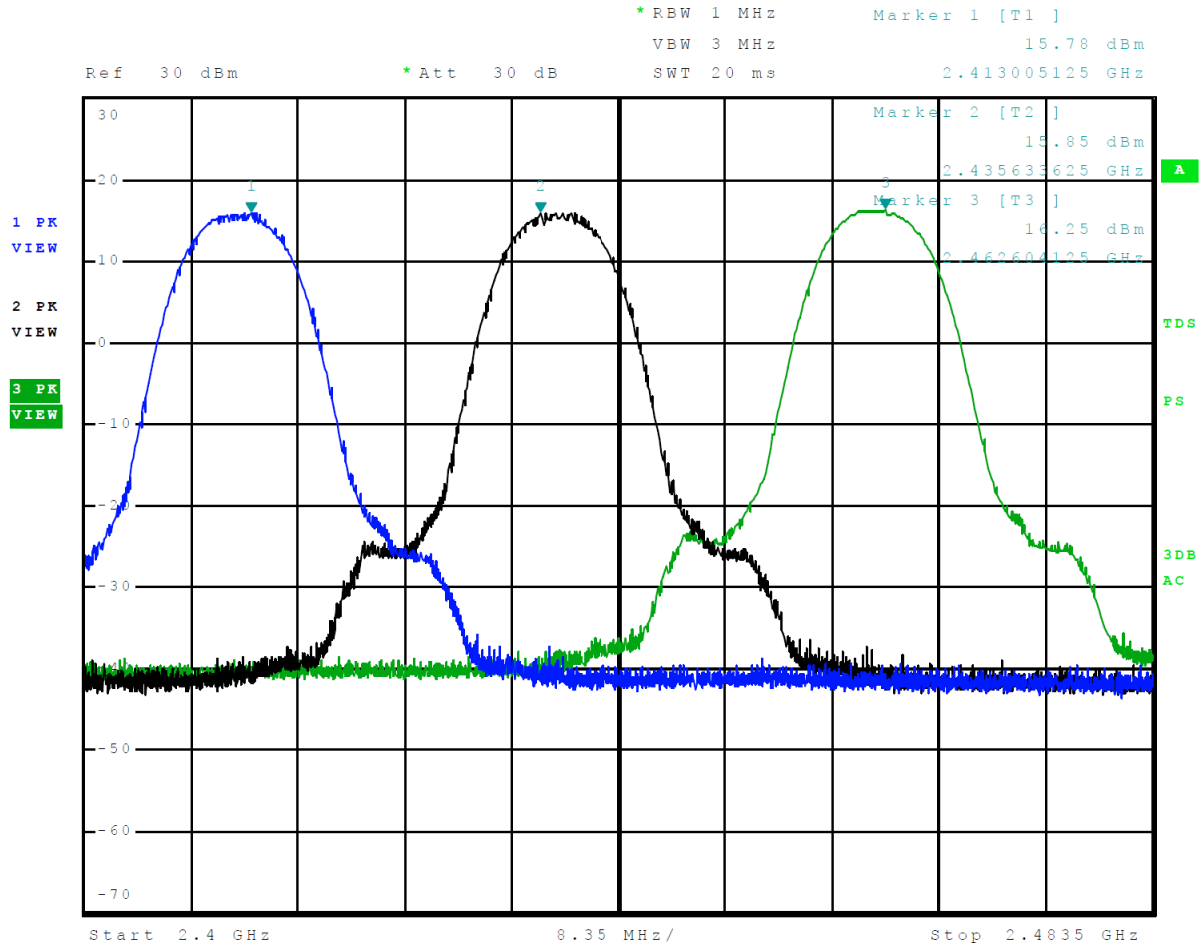

Figure 7 Plot of Transmitter Operation in 2402-2480 MHz Mode 6, 802.11g

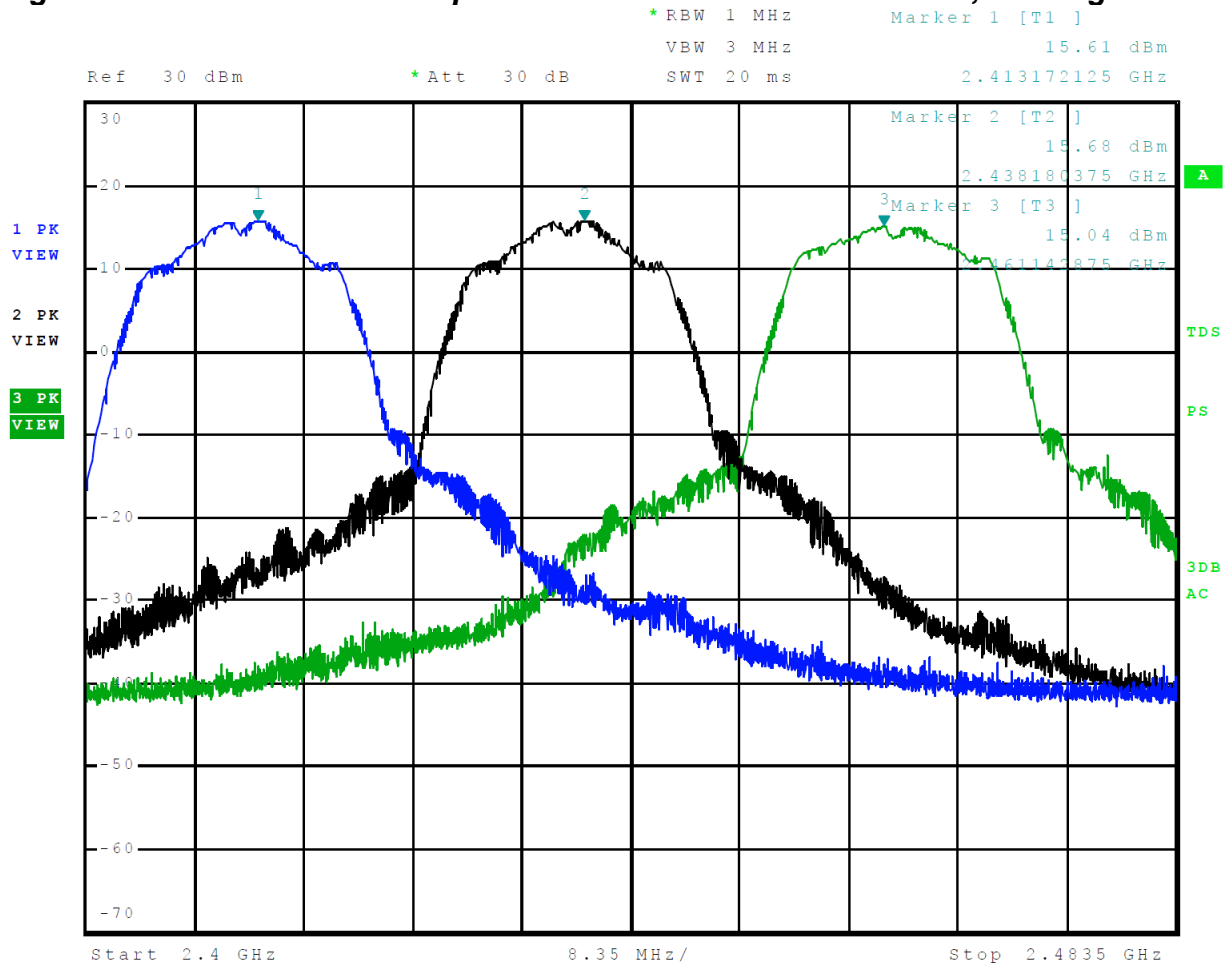

Figure 8 Plot of Transmitter Operation in 2402-2480 MHz Mode 7, 802.11n

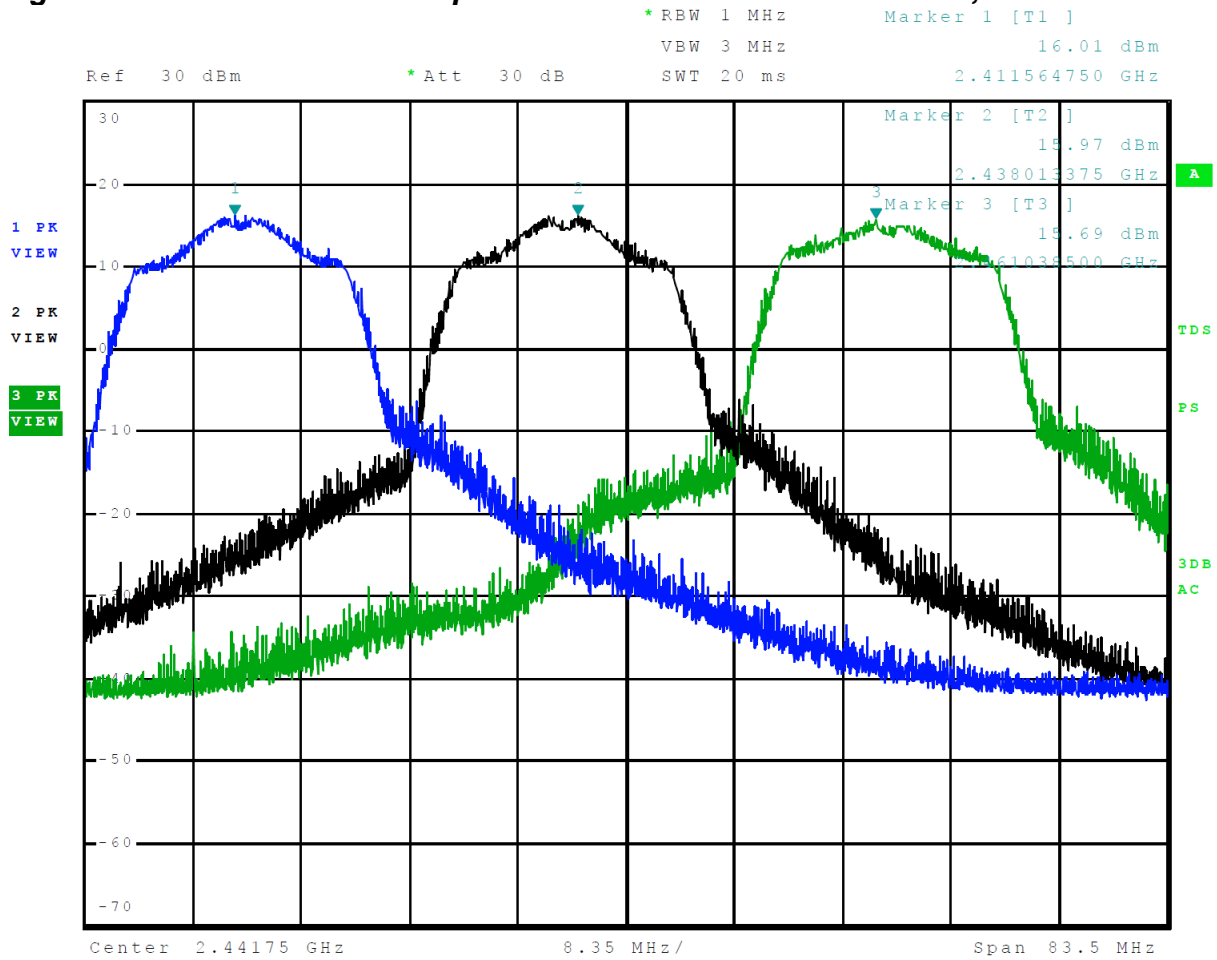

Figure 9 Plot of Emissions Low Band Edge Mode 2, BT 2EDR

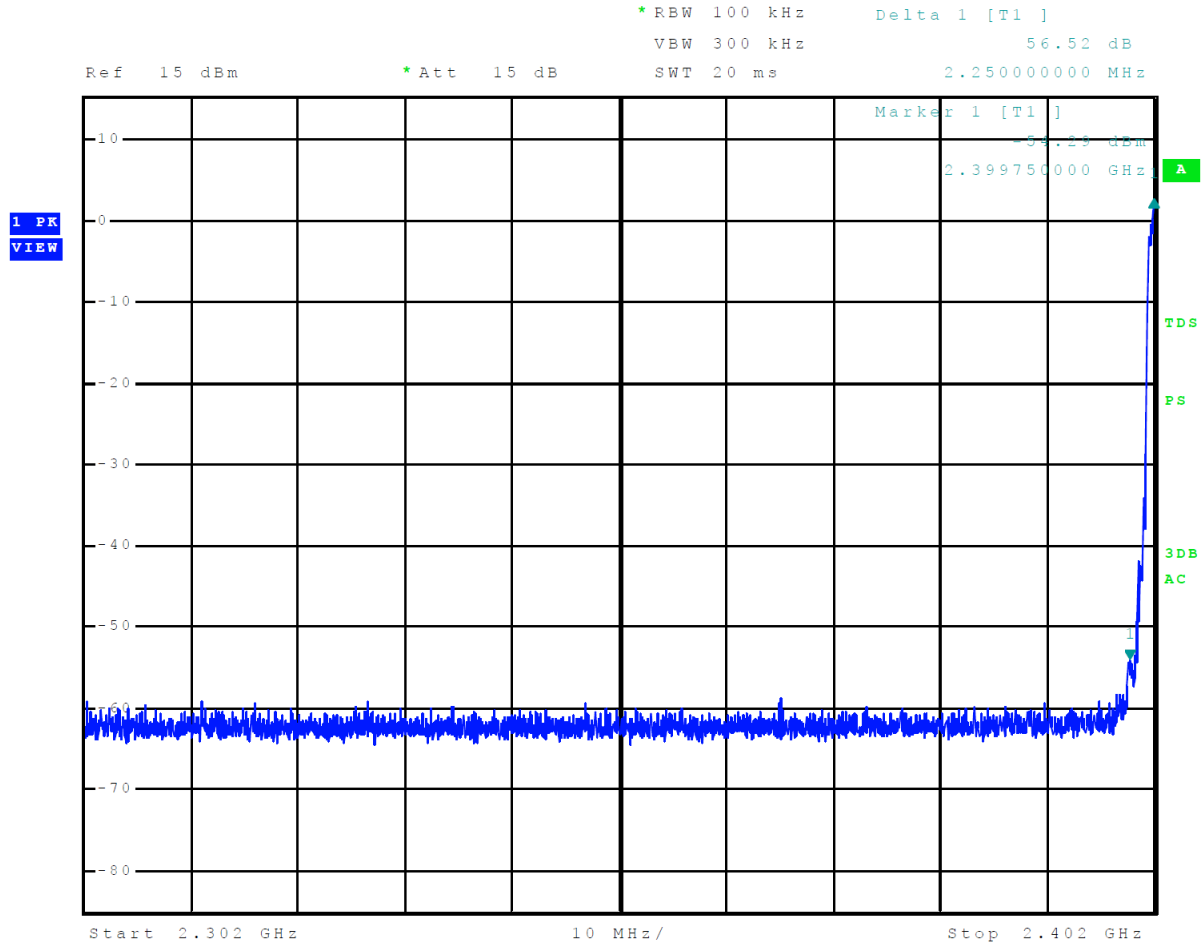

Figure 10 Plot of Emissions Low Band Edge Mode 3, BT 3EDR

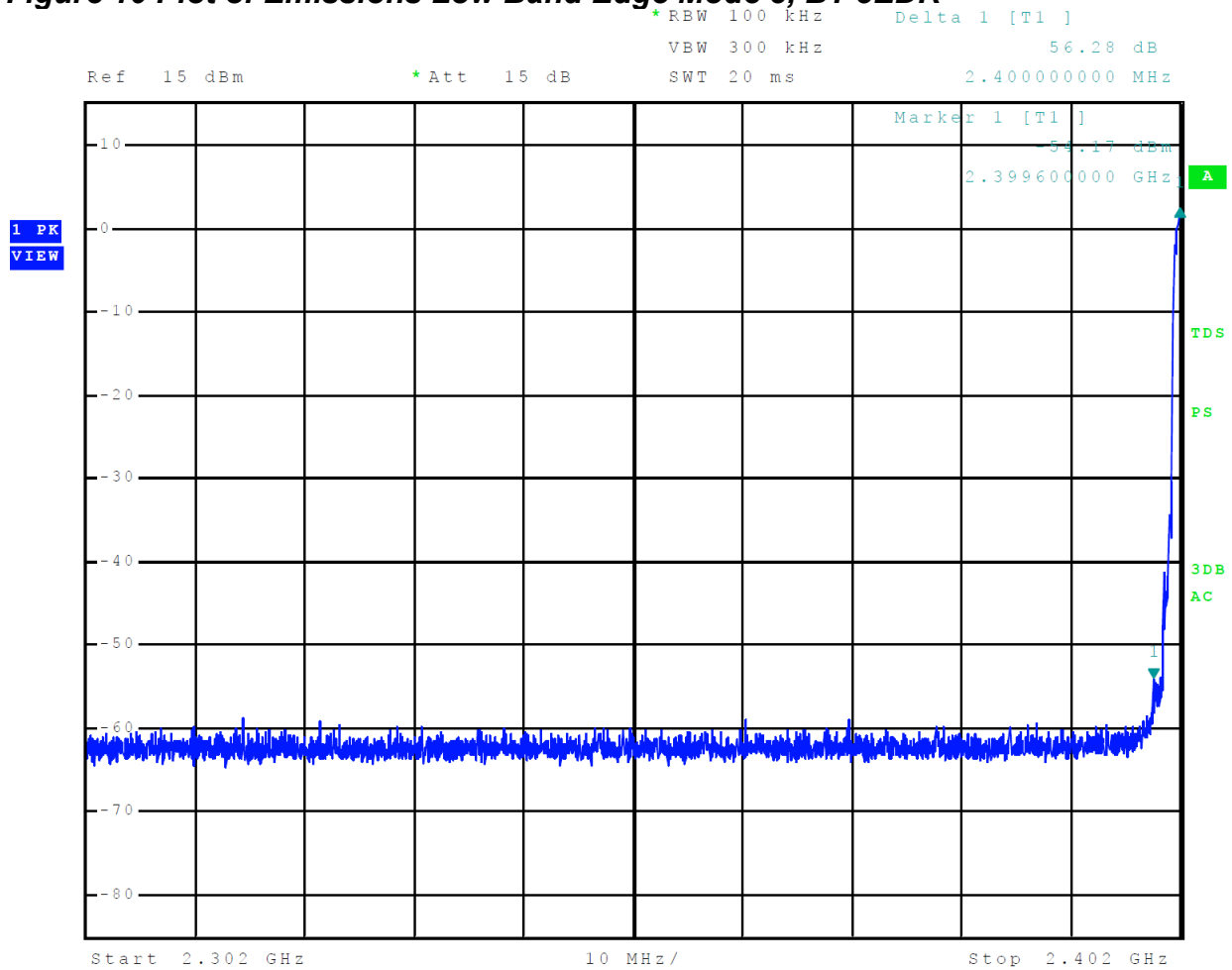

Figure 11 Plot of Emissions Low Band Edge Mode 4, BT BLE

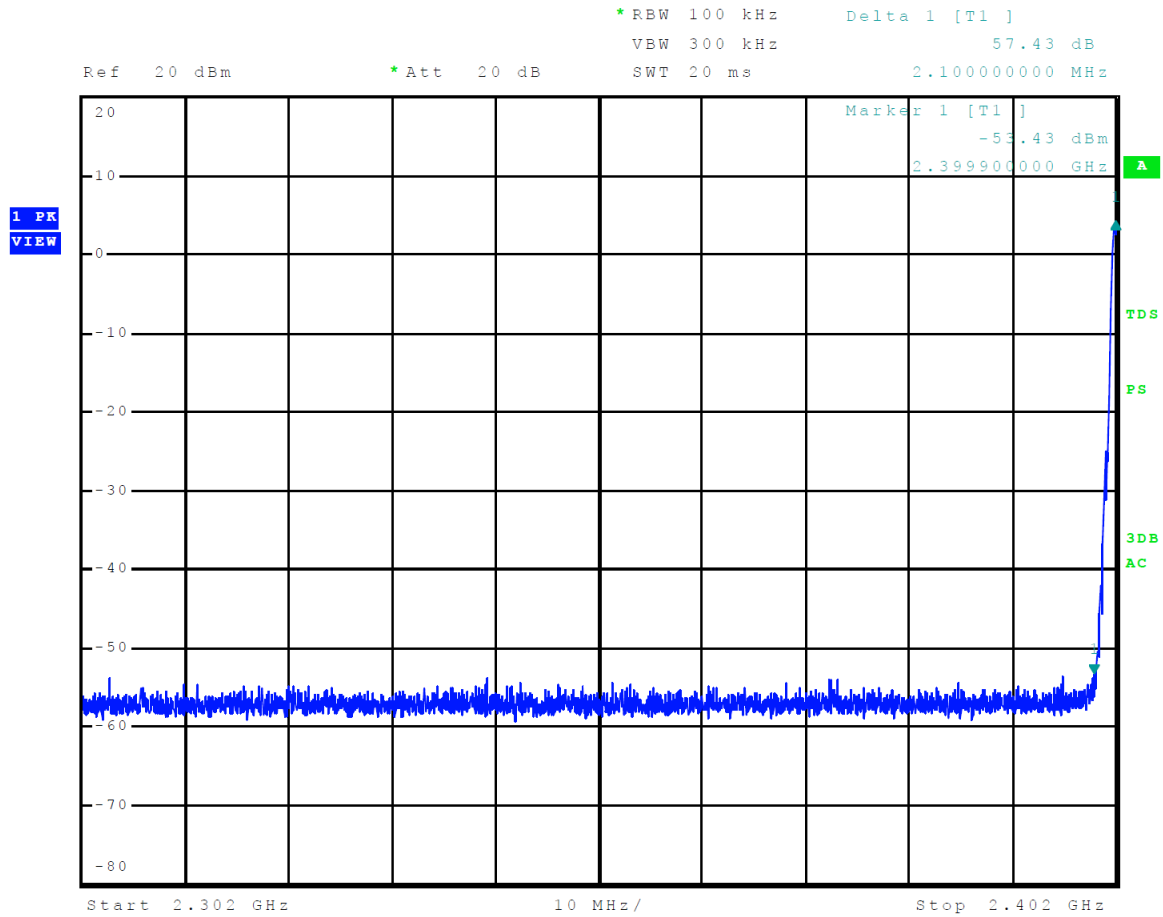

Figure 12 Plot of Emissions Low Band Edge Mode 4, 802.11b

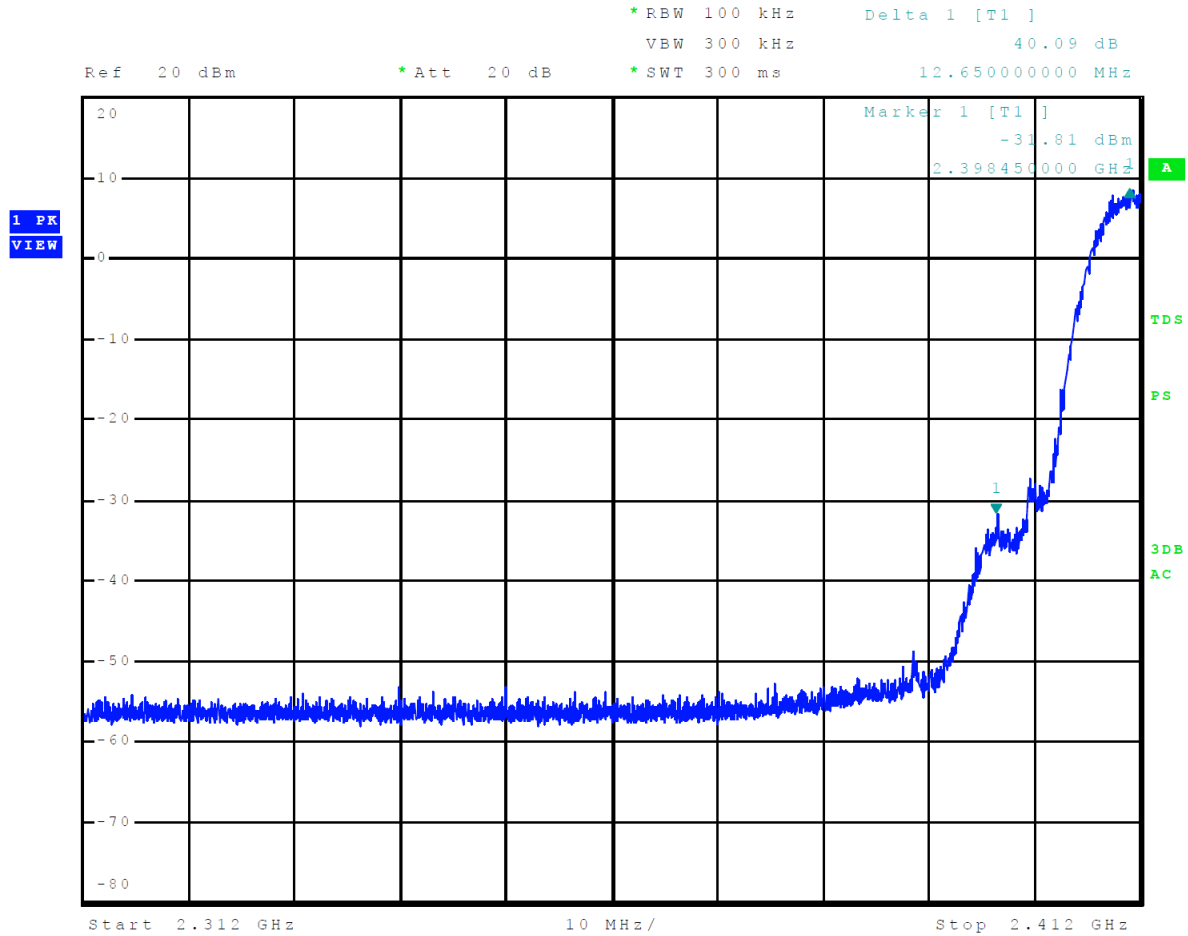

Figure 13 Plot of Emissions Low Band Edge Mode 4, 802.11g

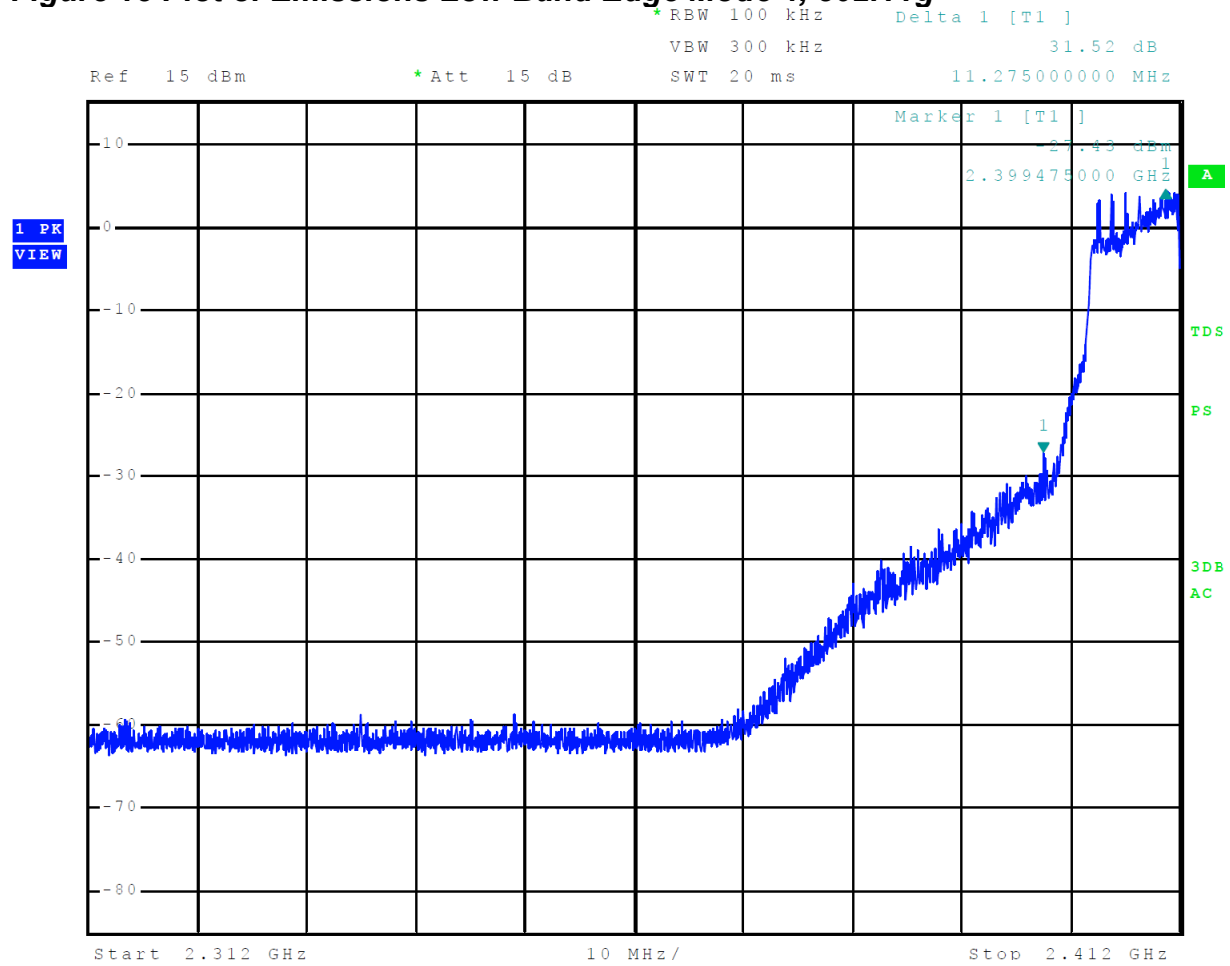

Figure 14 Plot of Emissions Low Band Edge Mode 4, 802.11n

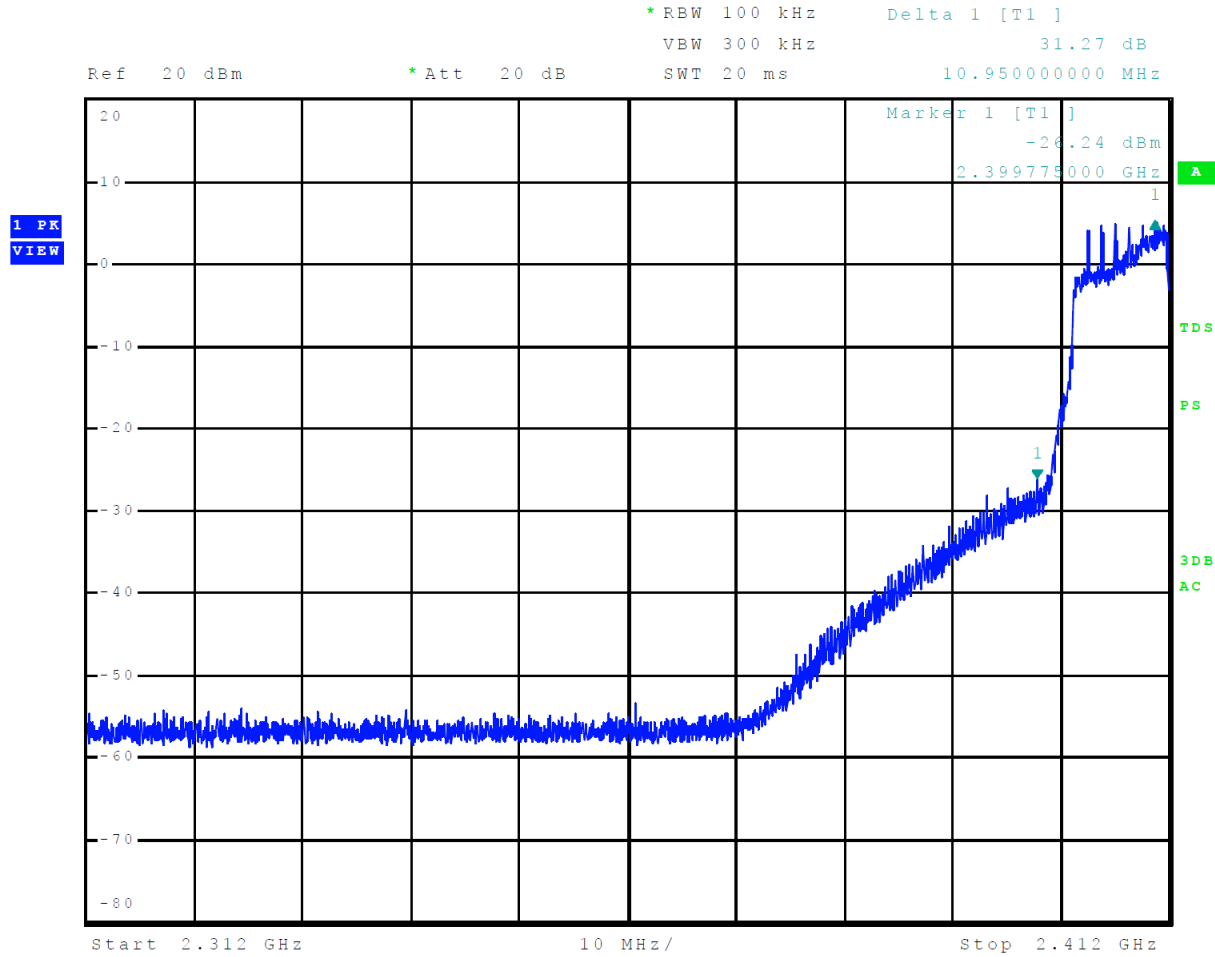

Figure 15 Plot of Transmitter Emissions High Band Edge Mode 2, BT 2EDR

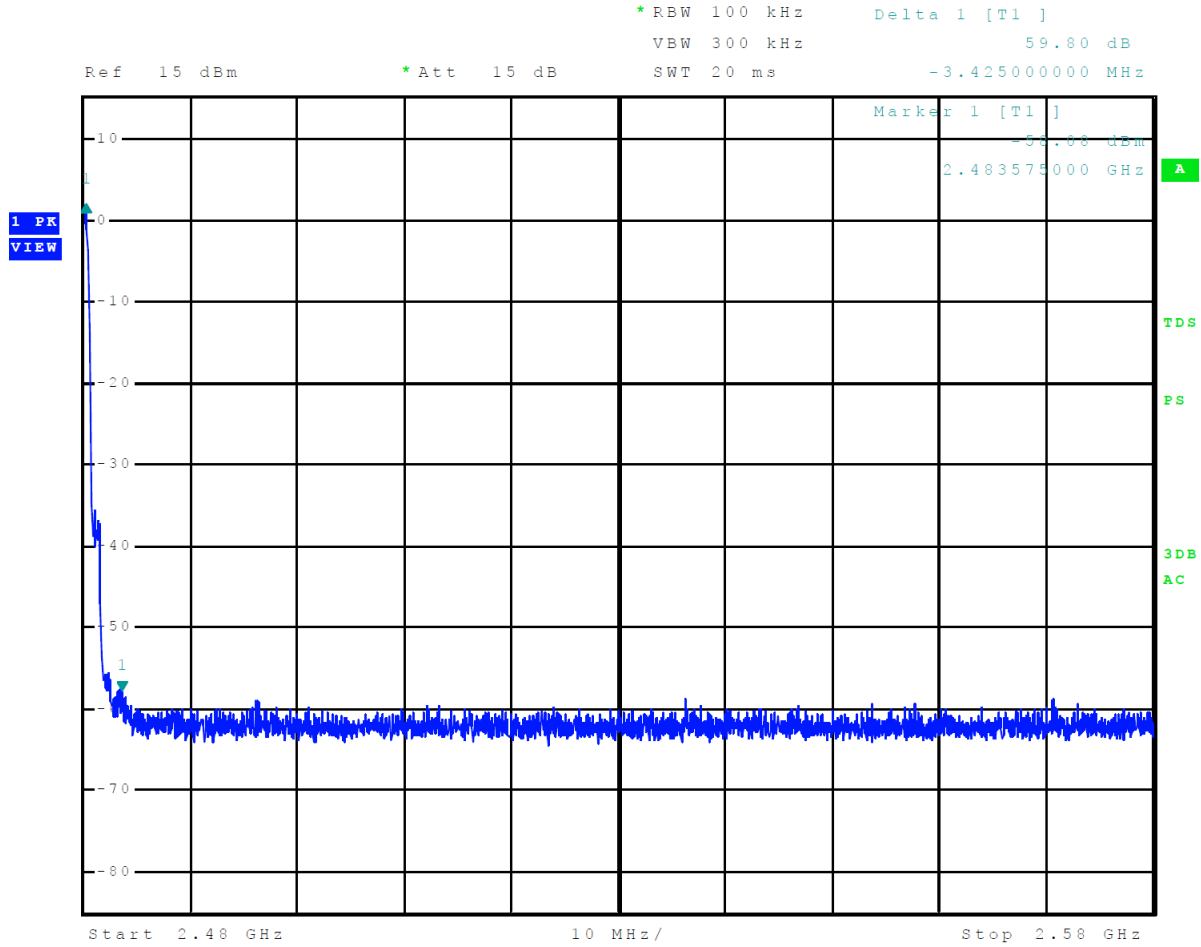

Figure 16 Plot of Transmitter Emissions High Band Edge Mode 3, BT 3EDR

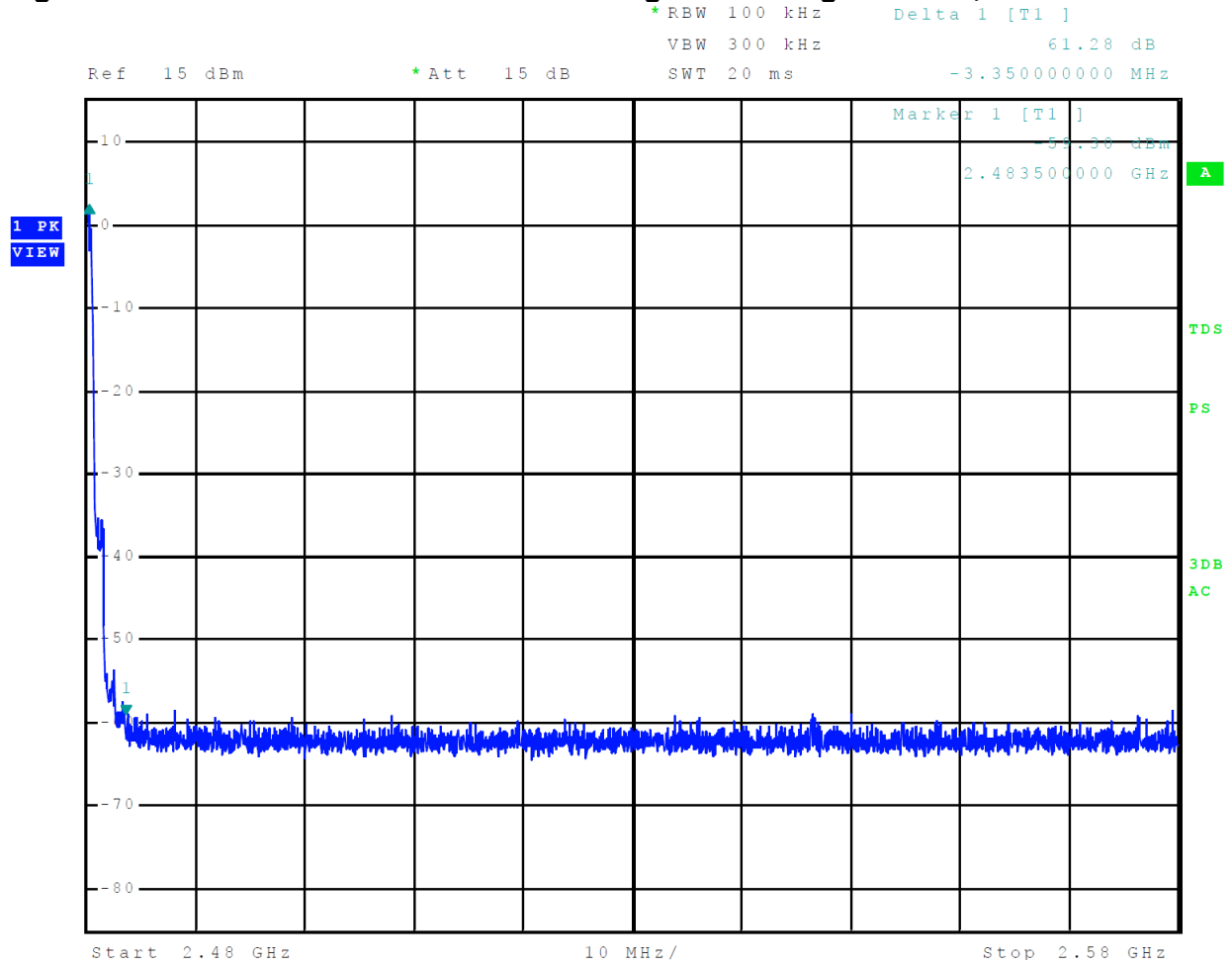

Figure 17 Plot of Transmitter Emissions High Band Edge Mode 4, BT BLE

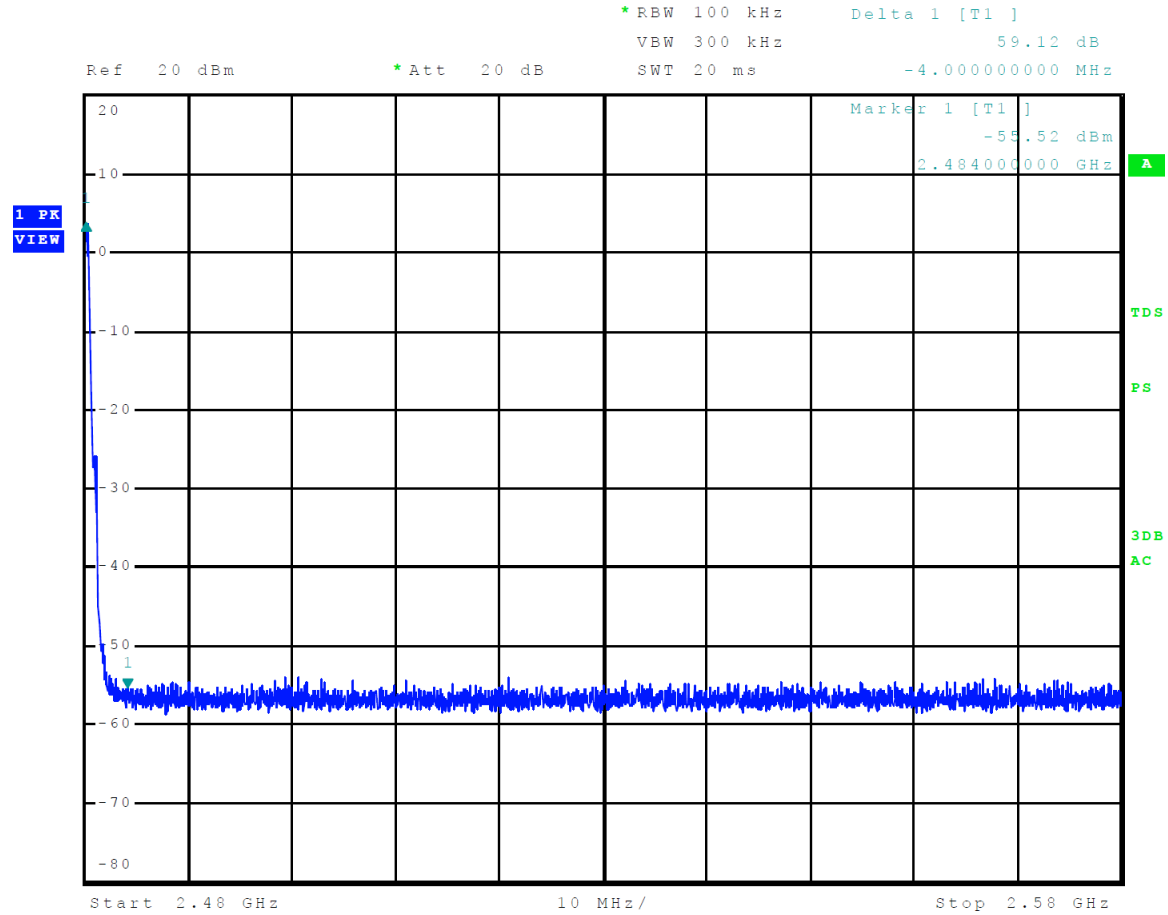

Figure 18 Plot of Transmitter Emissions High Band Edge Mode 5, 802.11b

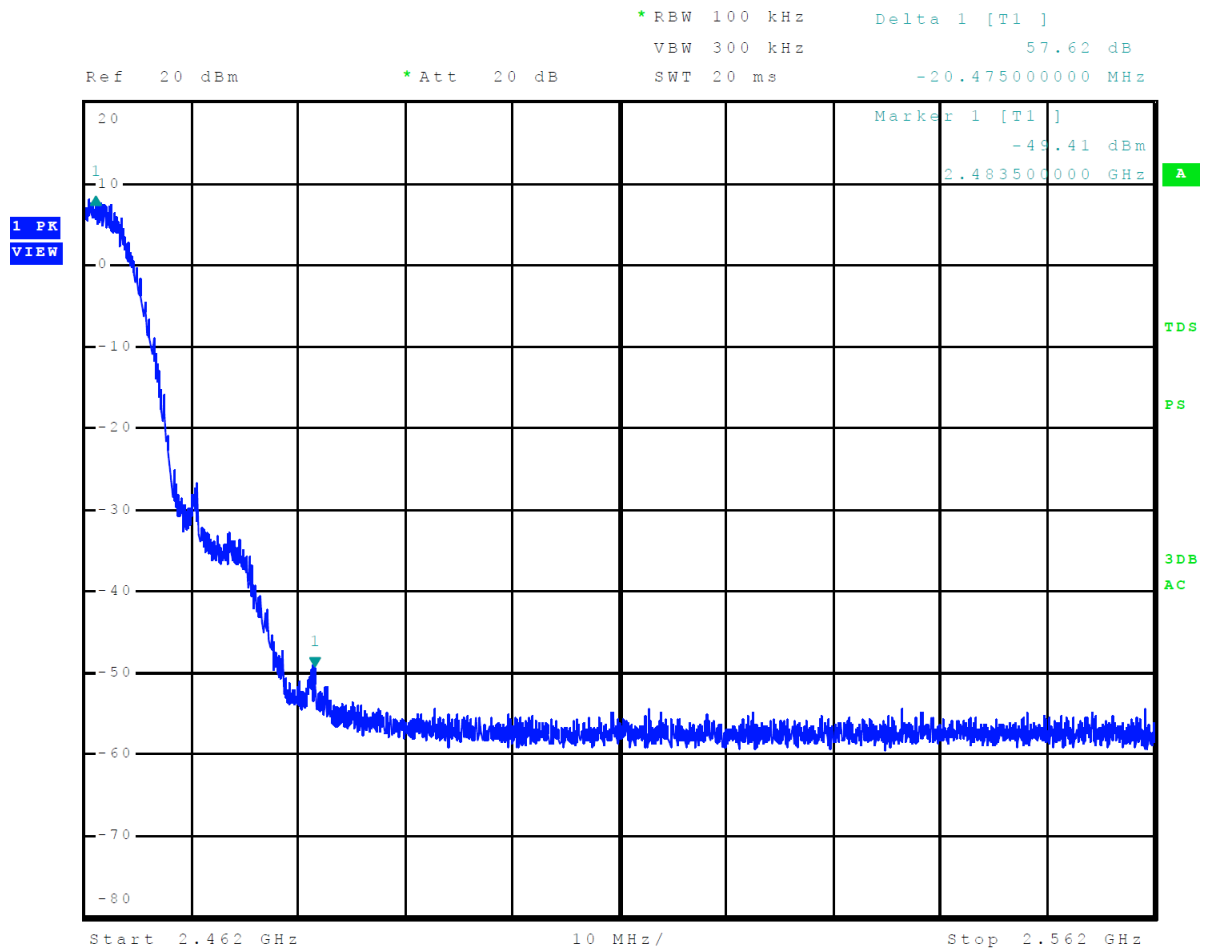

Figure 19 Plot of Transmitter Emissions High Band Edge Mode 6, 802.11g

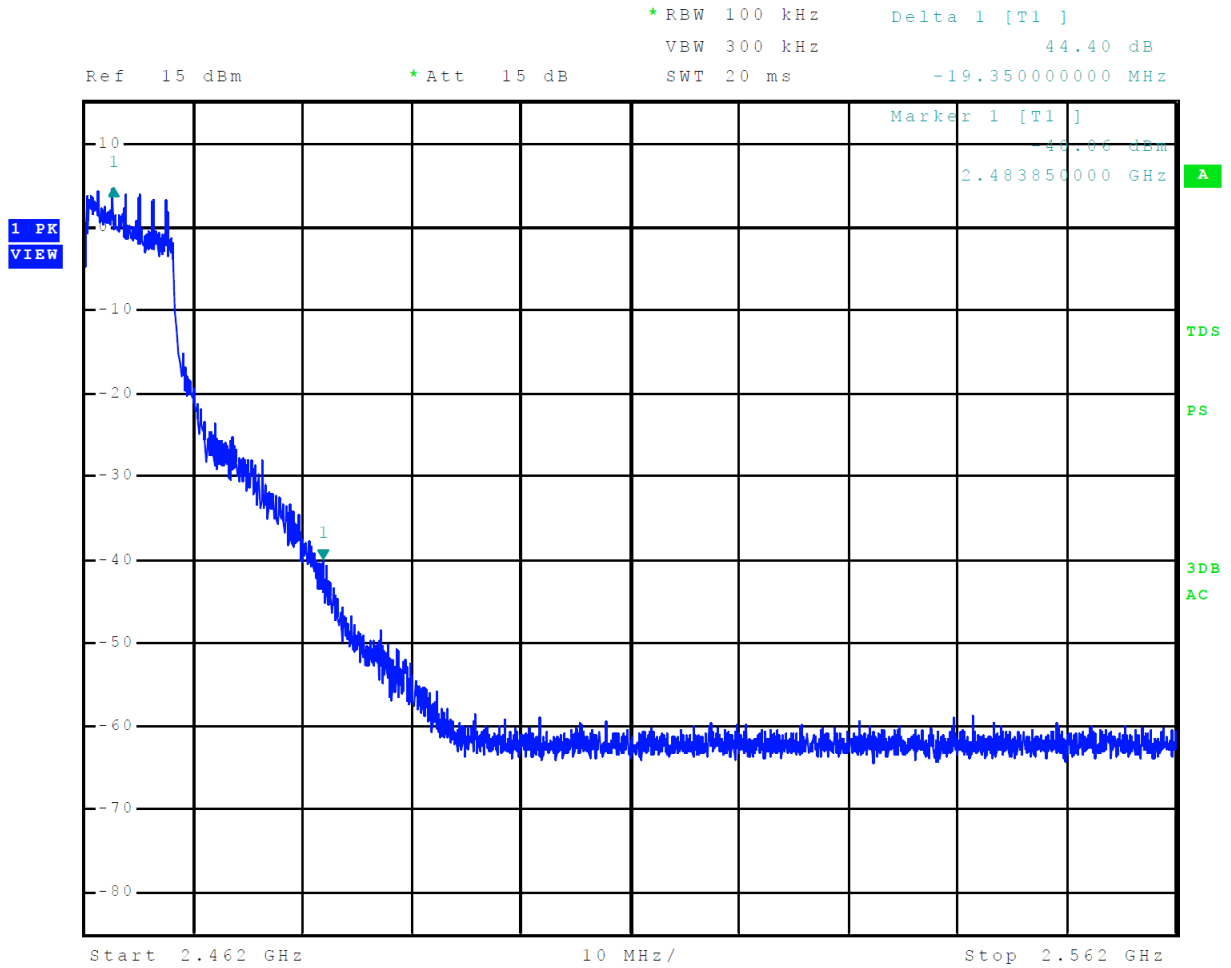

Figure 20 Plot of Transmitter Emissions High Band Edge Mode 7, 802.11n

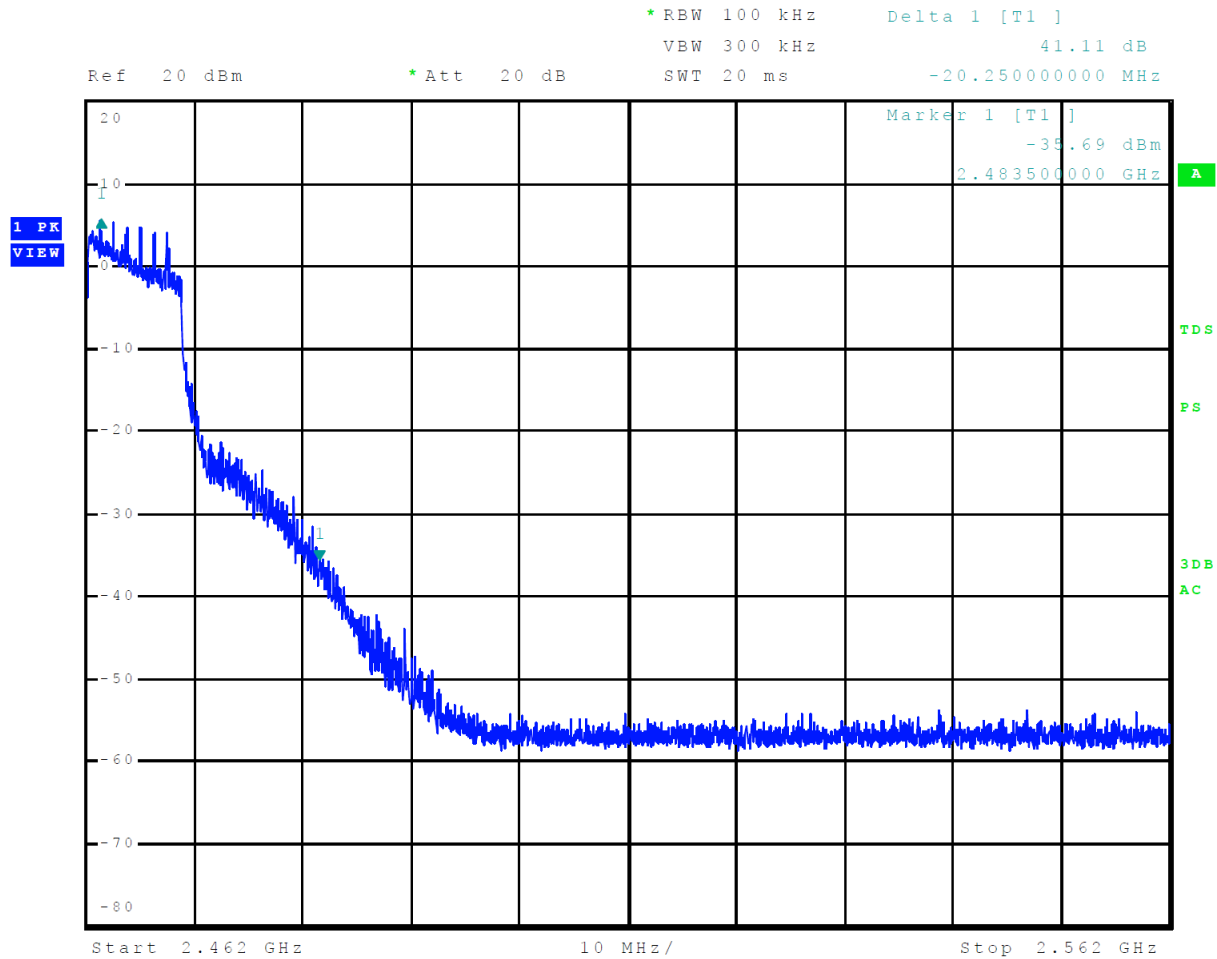

Figure 21 Plot of 6-dB Occupied Bandwidth Mode 2, BT 2EDR

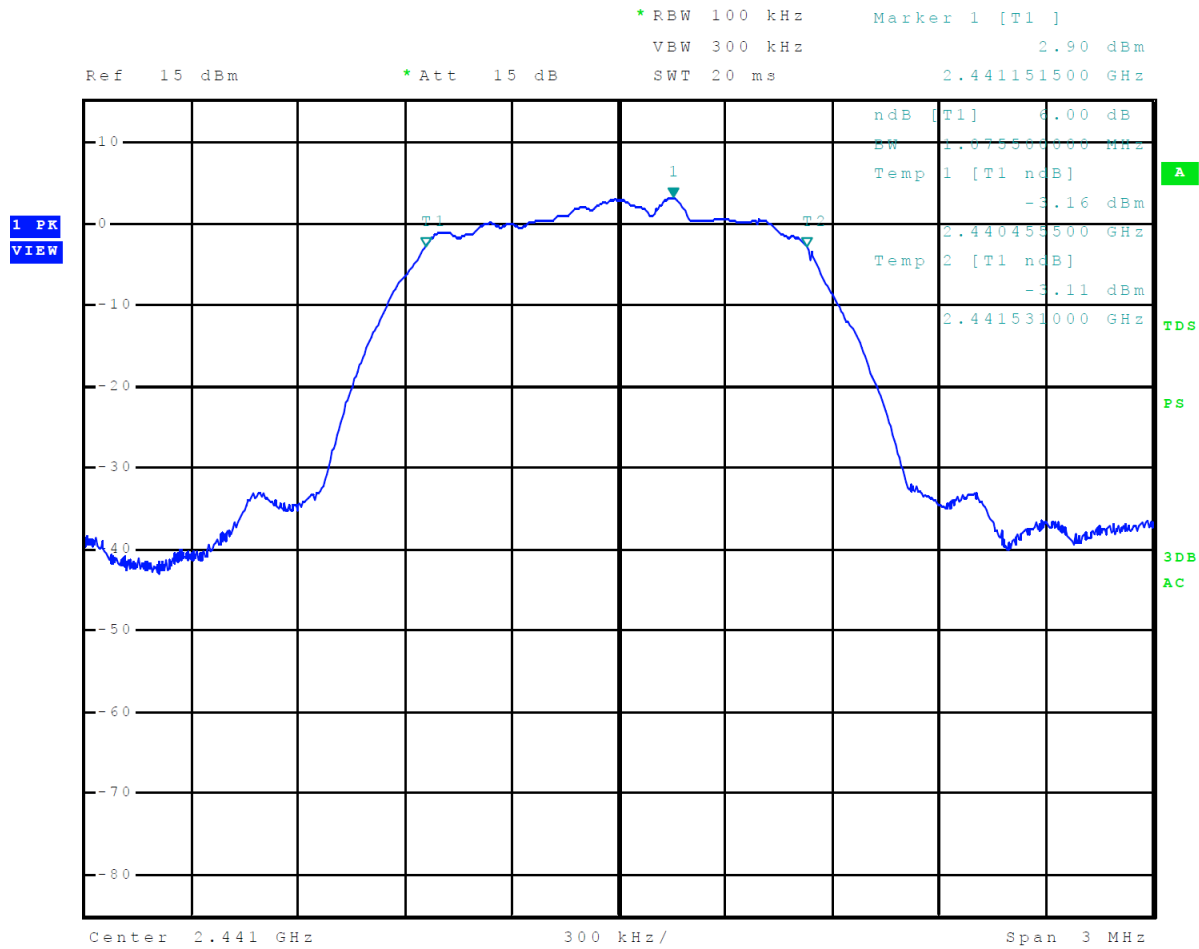

Figure 22 Plot of 99% Occupied Bandwidth Mode 2, BT 2EDR

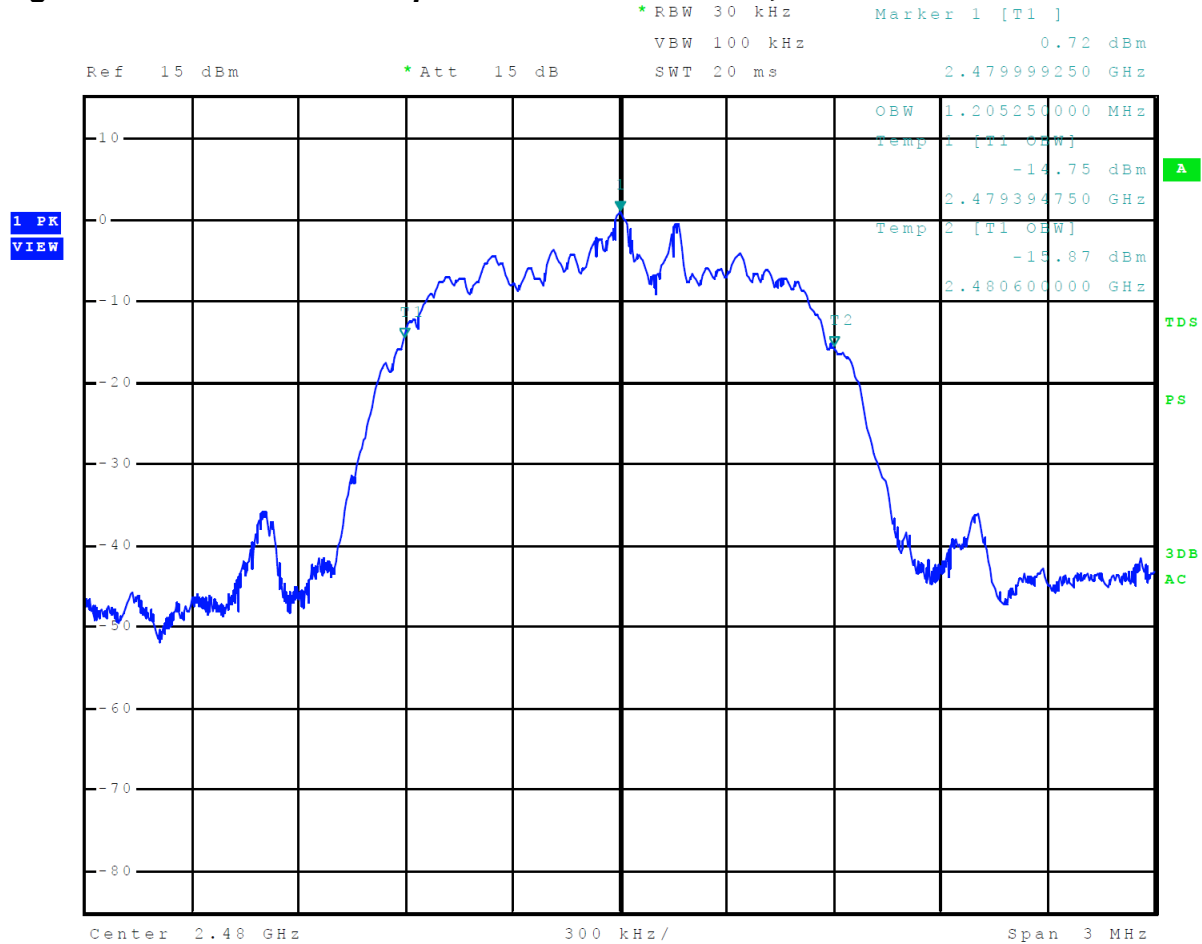

Figure 23 Plot of 6-dB Occupied Bandwidth Mode 3, BT 3EDR

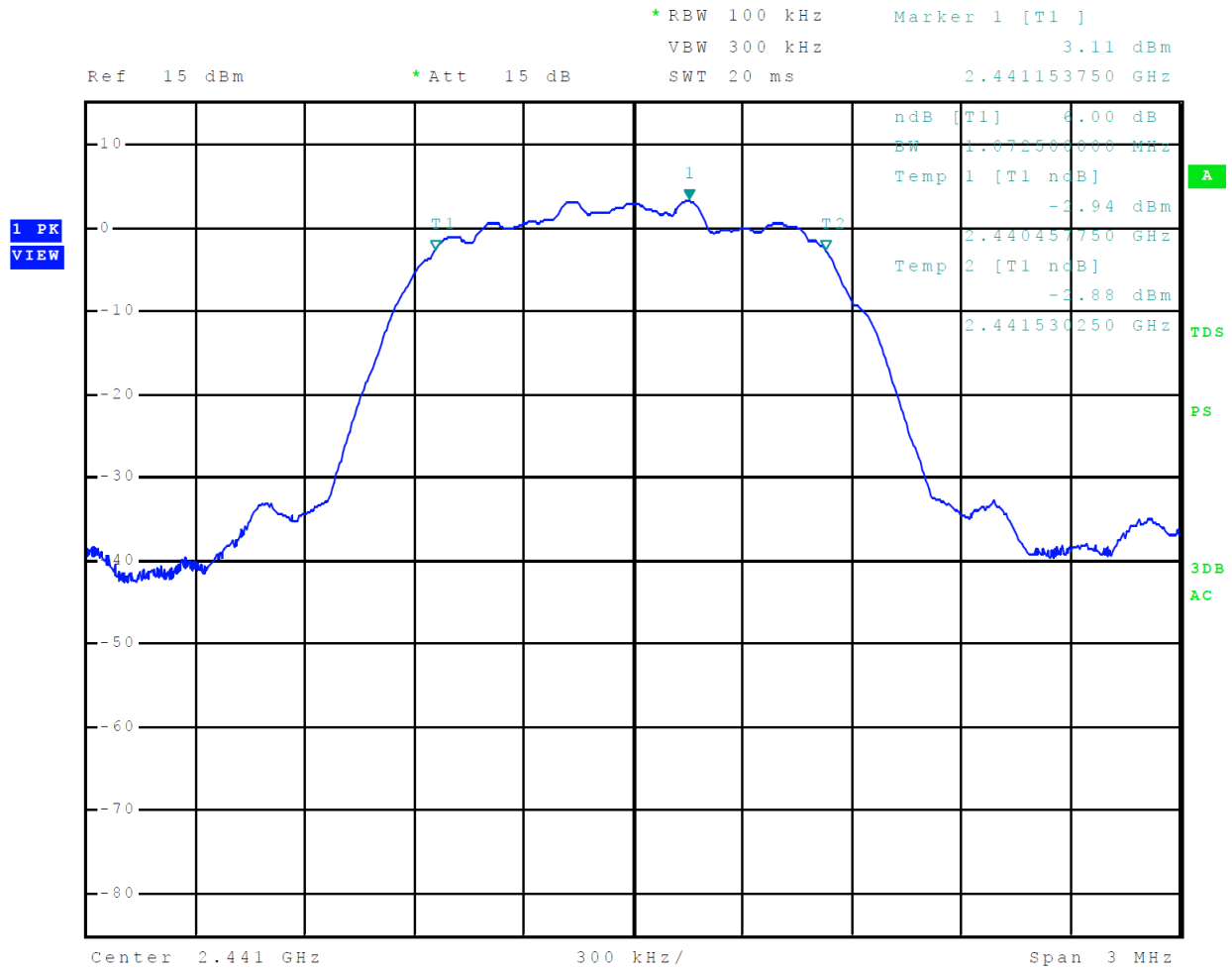

Figure 24 Plot of 99% Occupied Bandwidth Mode 3, BT 3EDR

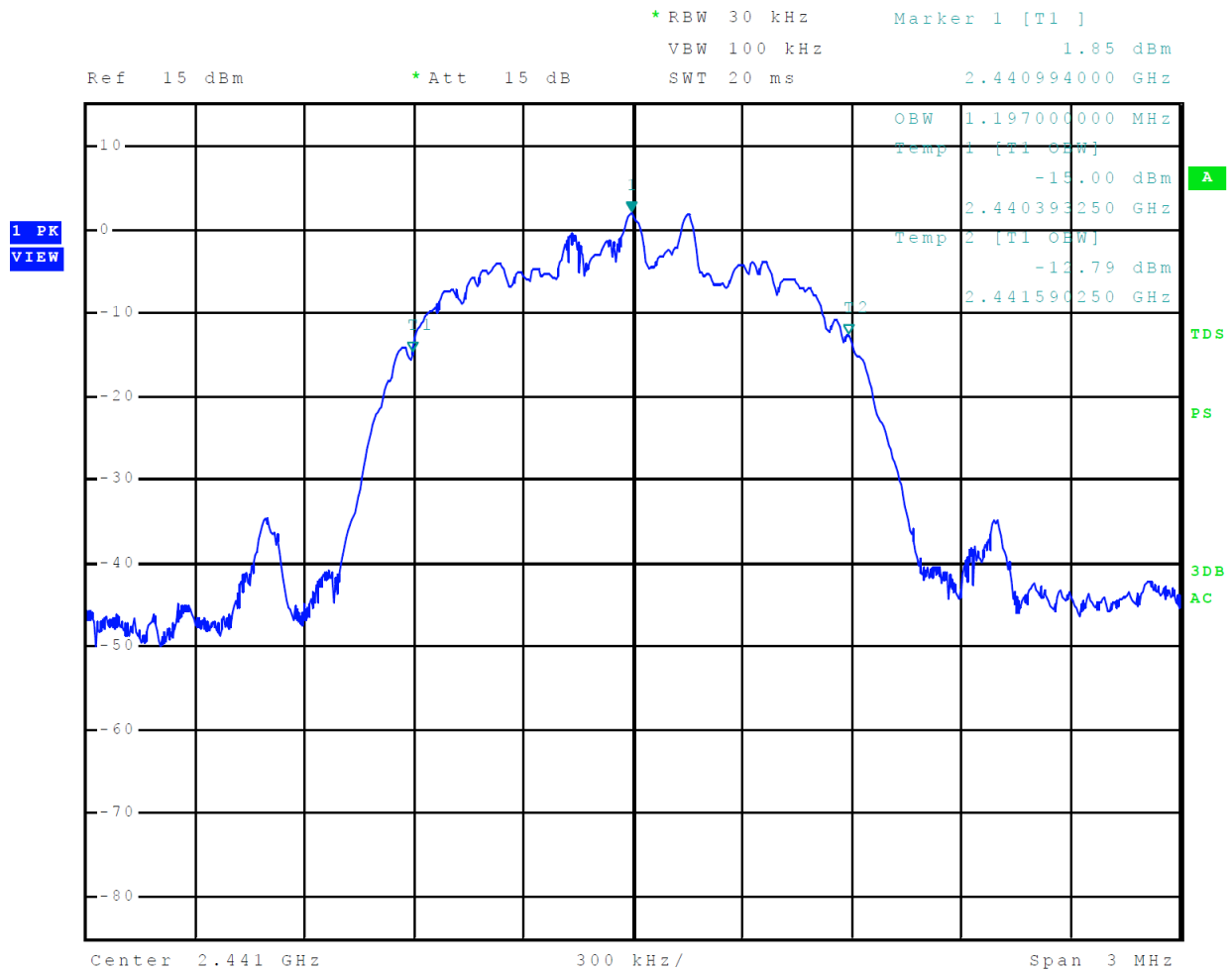

Figure 25 Plot of 6-dB Occupied Bandwidth Mode 4, BT BLE

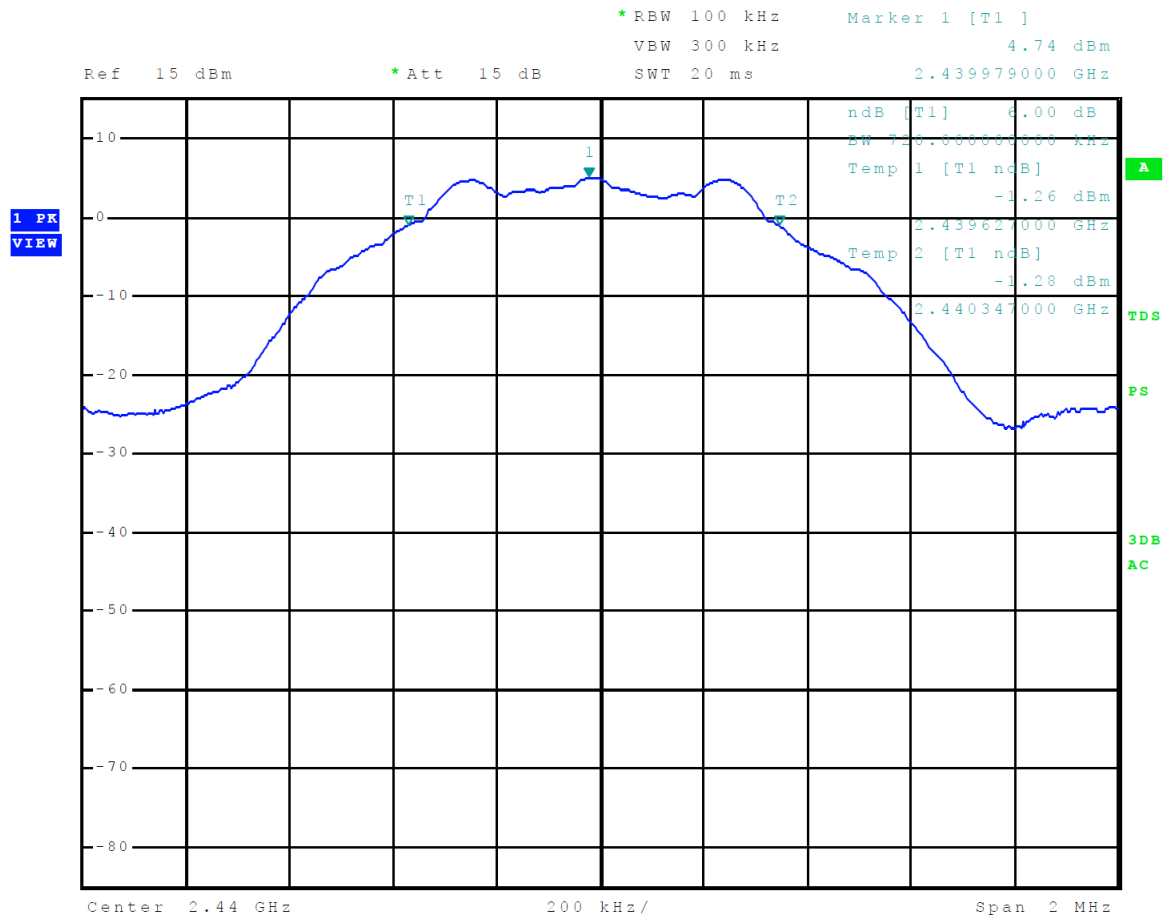

Figure 26 Plot of 99% Occupied Bandwidth Mode 4, BT BLE

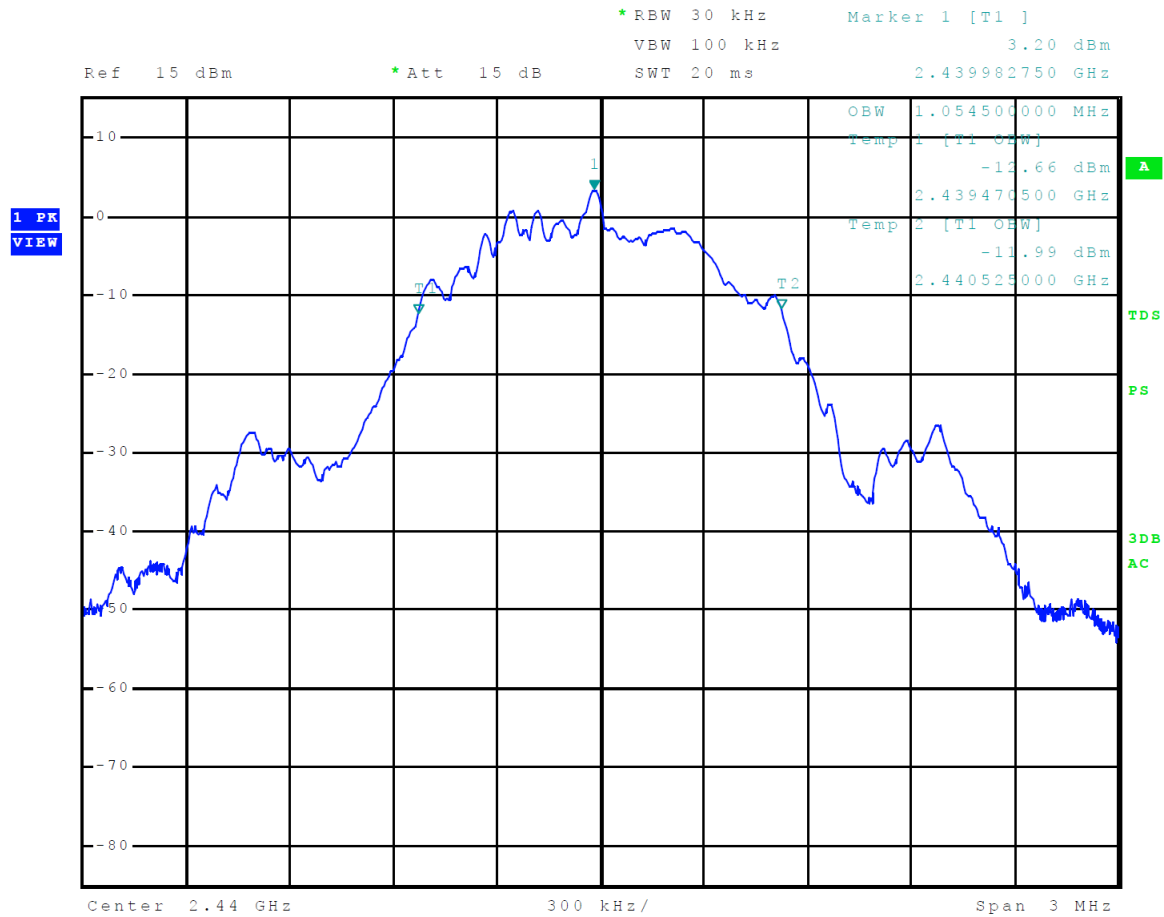

Figure 27 Plot of 6-dB Occupied Bandwidth Mode 5, 802.11b

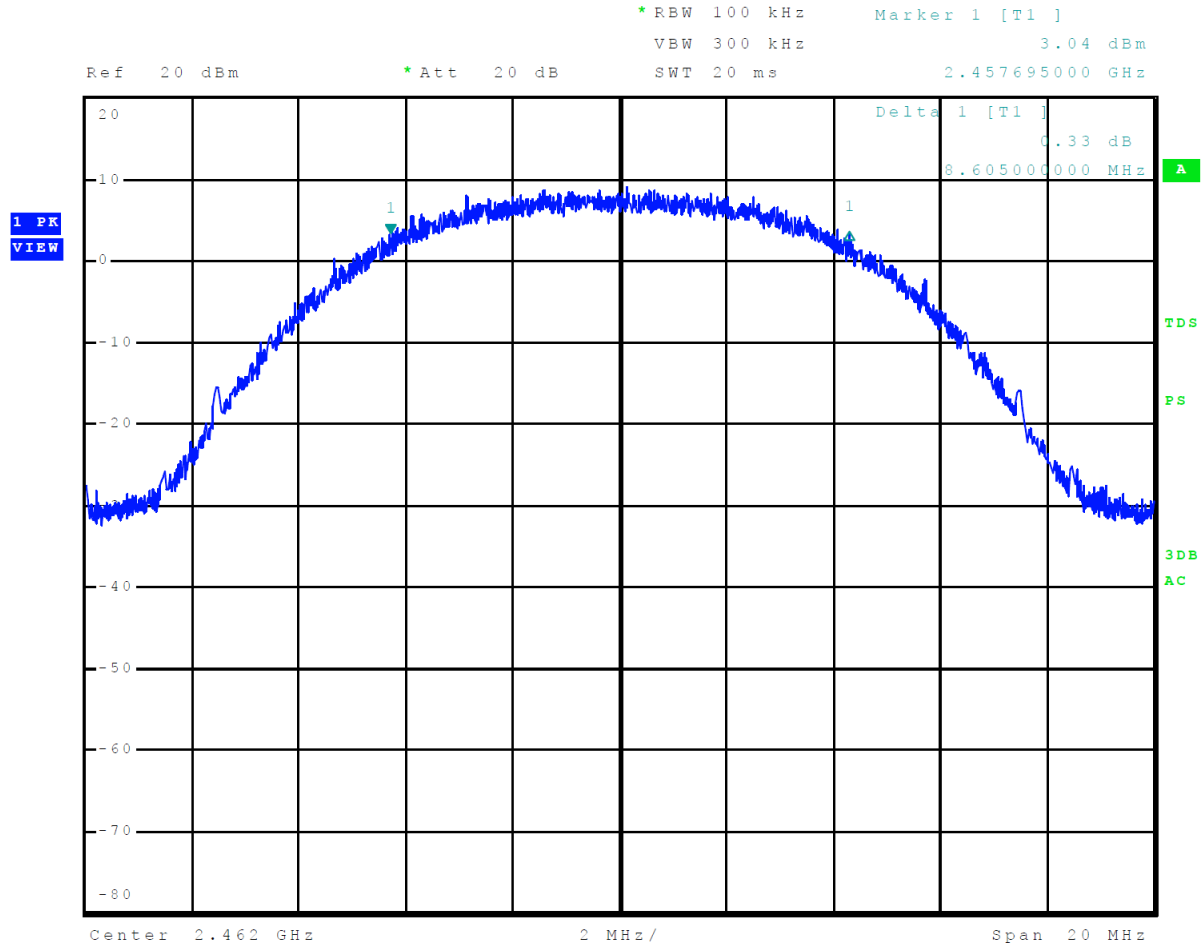

Figure 28 Plot of 99% Occupied Bandwidth Mode 5, 802.11b

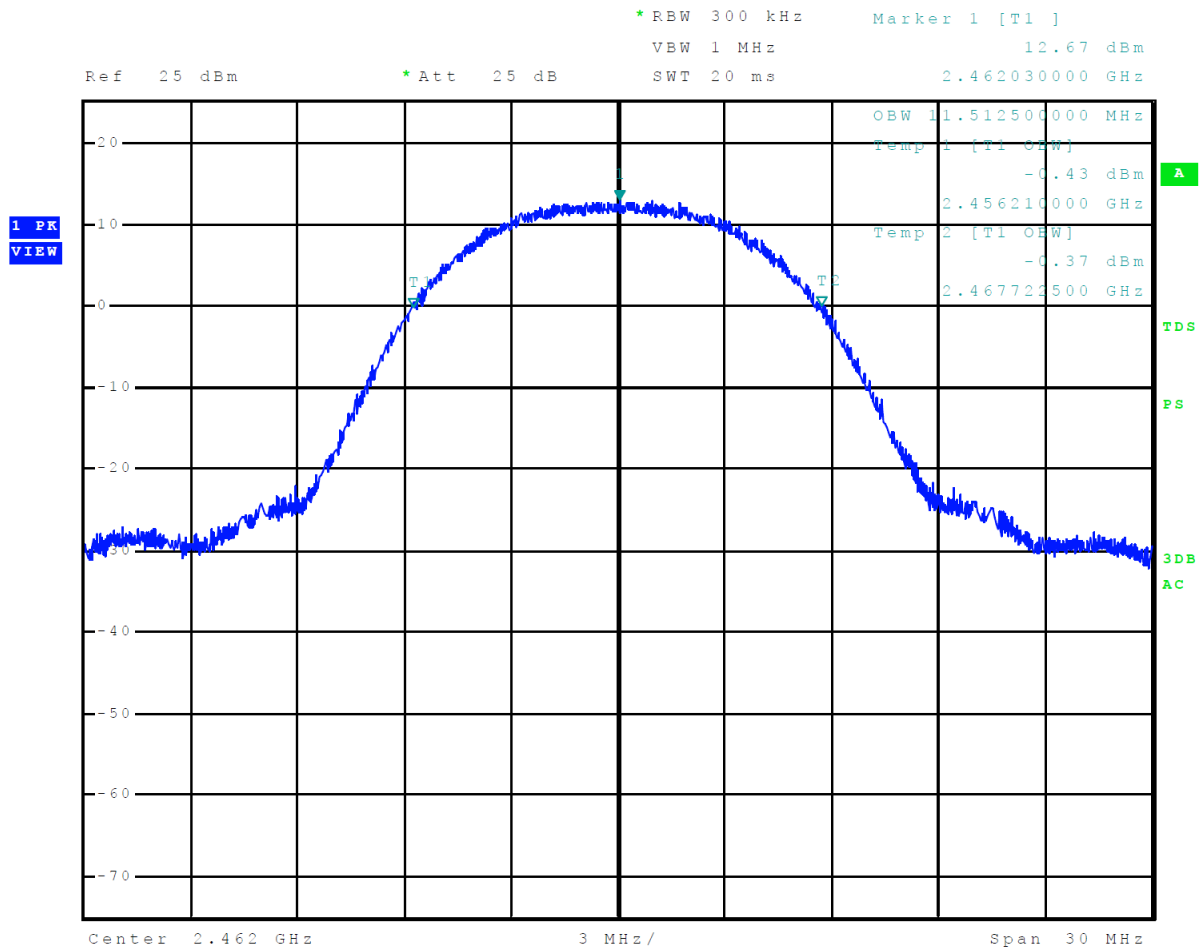

Figure 29 Plot of 6-dB Occupied Bandwidth Mode 6, 802.11g

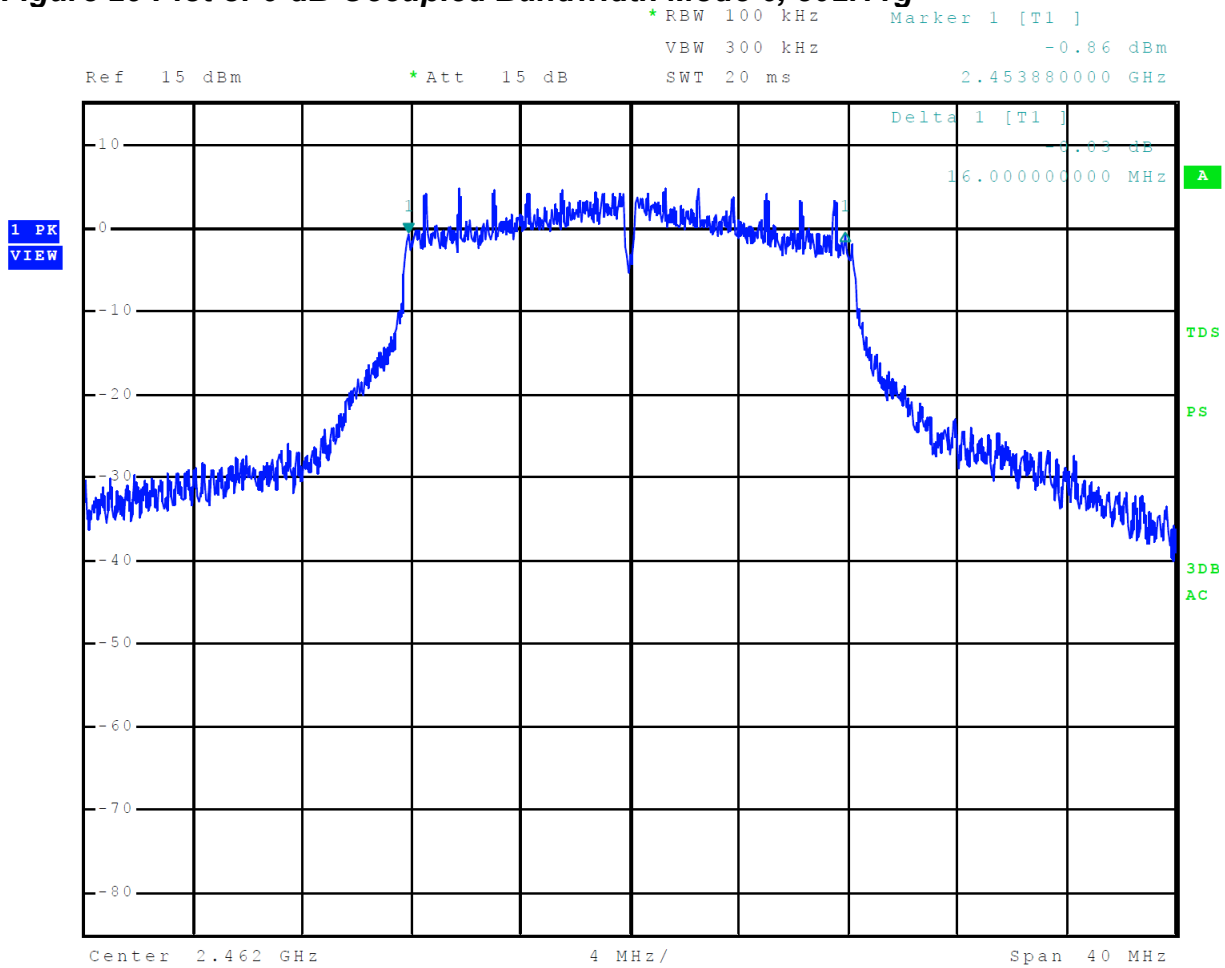

Figure 30 Plot of 99% Occupied Bandwidth Mode 6, 802.11g

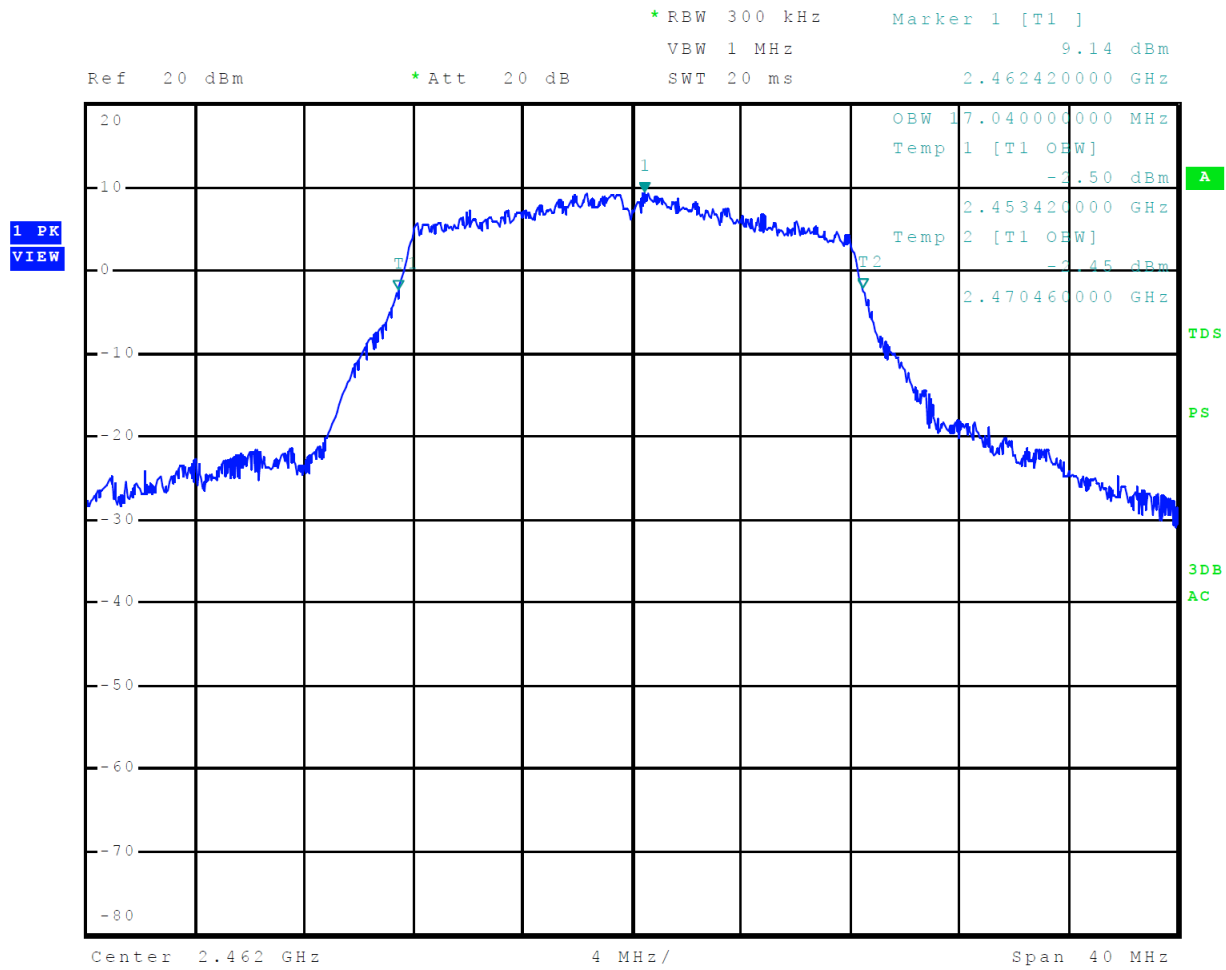

Figure 31 Plot of 6-dB Occupied Bandwidth Mode 7, 802.11n

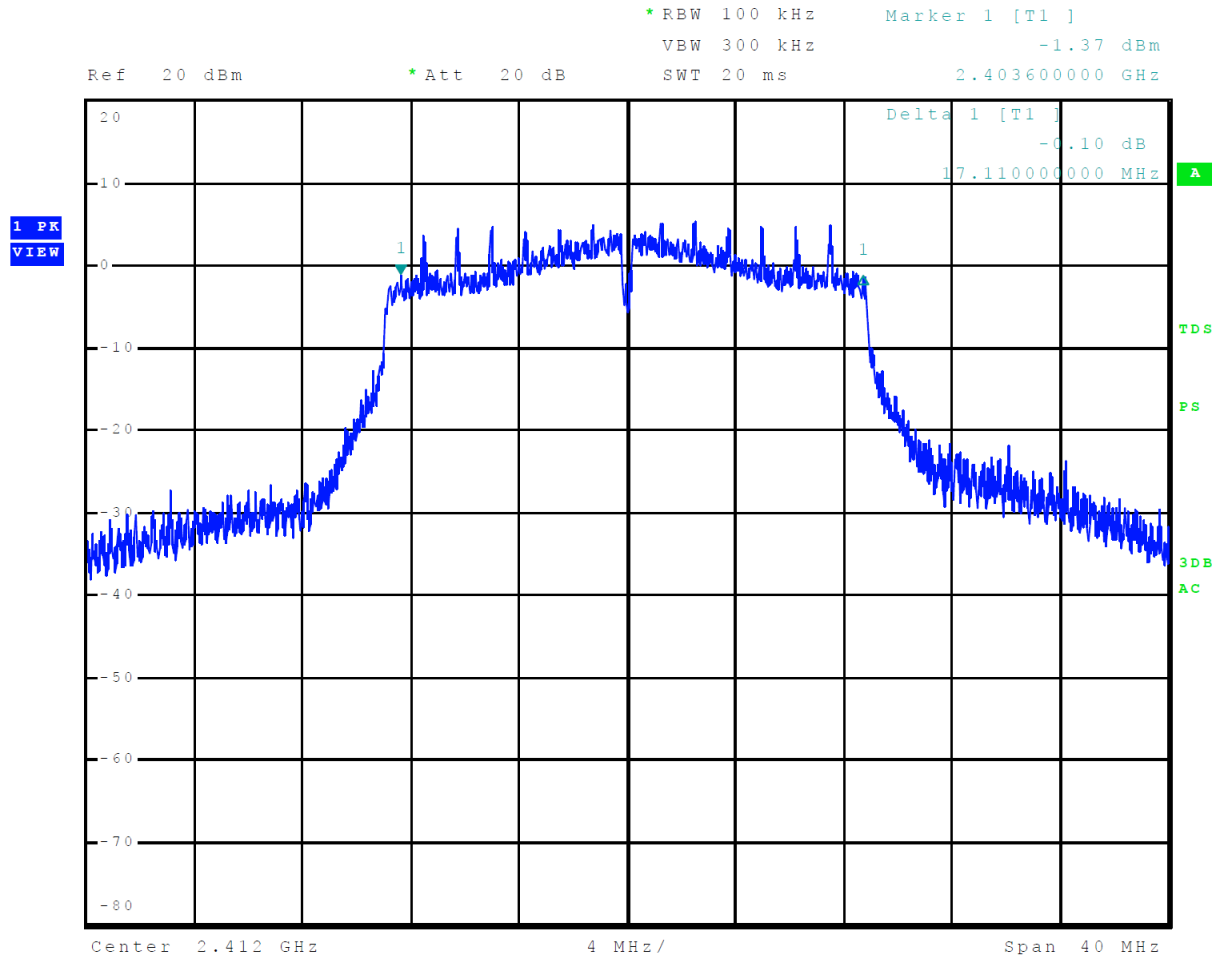

Figure 32 Plot of 99% Occupied Bandwidth Mode 7, 802.11n

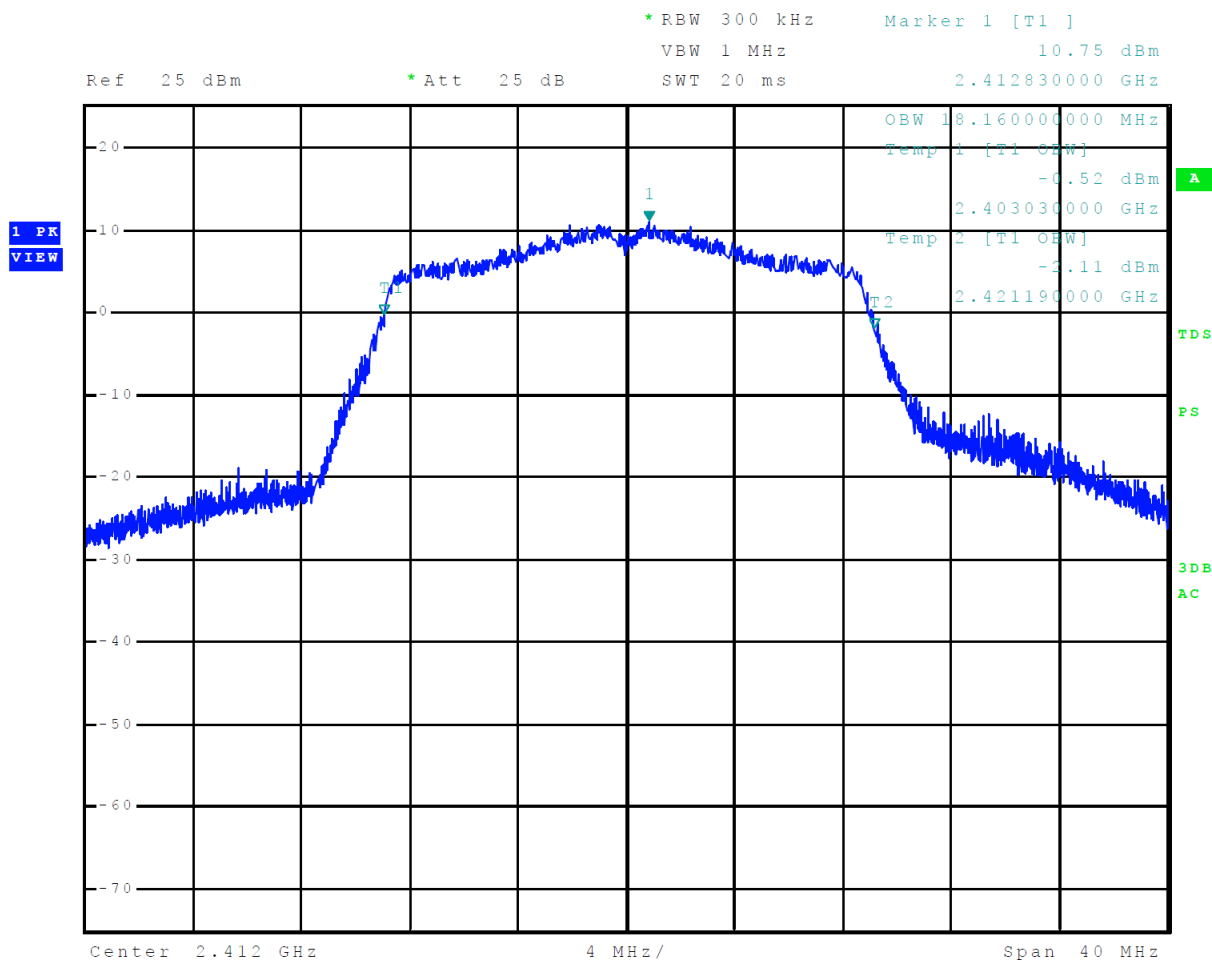

Figure 33 Plot of Transmitter Power Spectral Density Mode 2, BT 2EDR

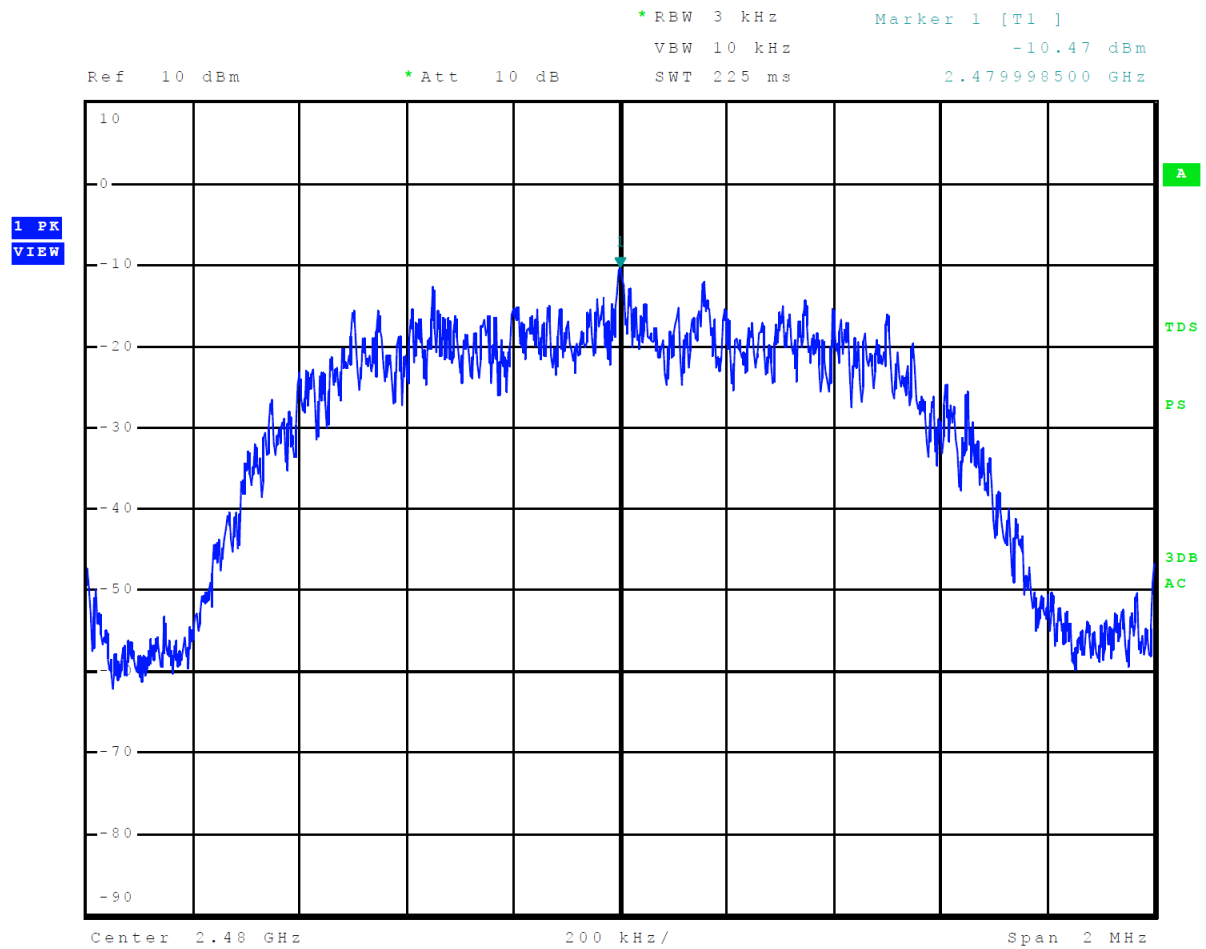

Figure 34 Plot of Transmitter Power Spectral Density Mode 3, BT 3EDR

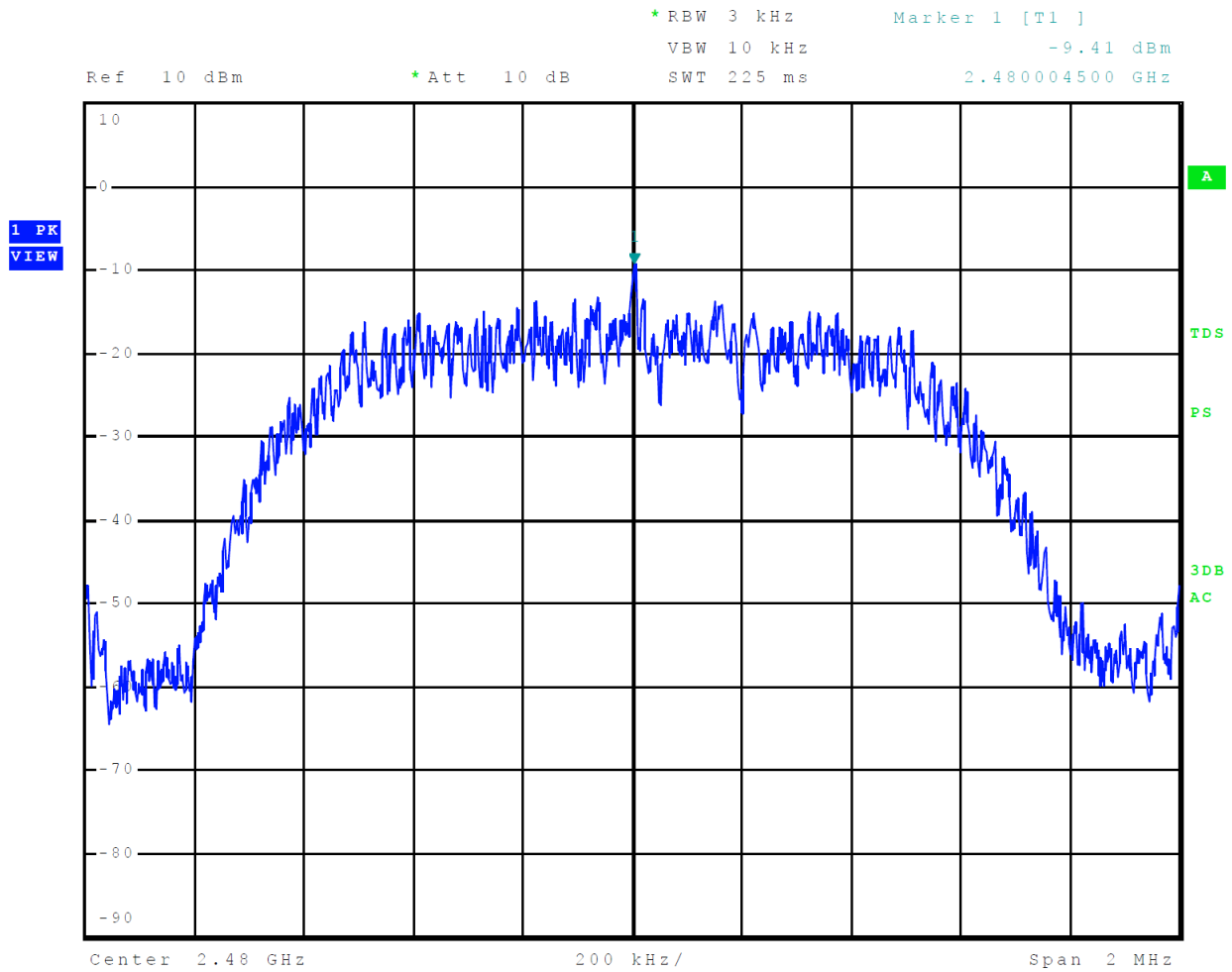

Figure 35 Plot of Transmitter Power Spectral Density Mode 4, BT BLE

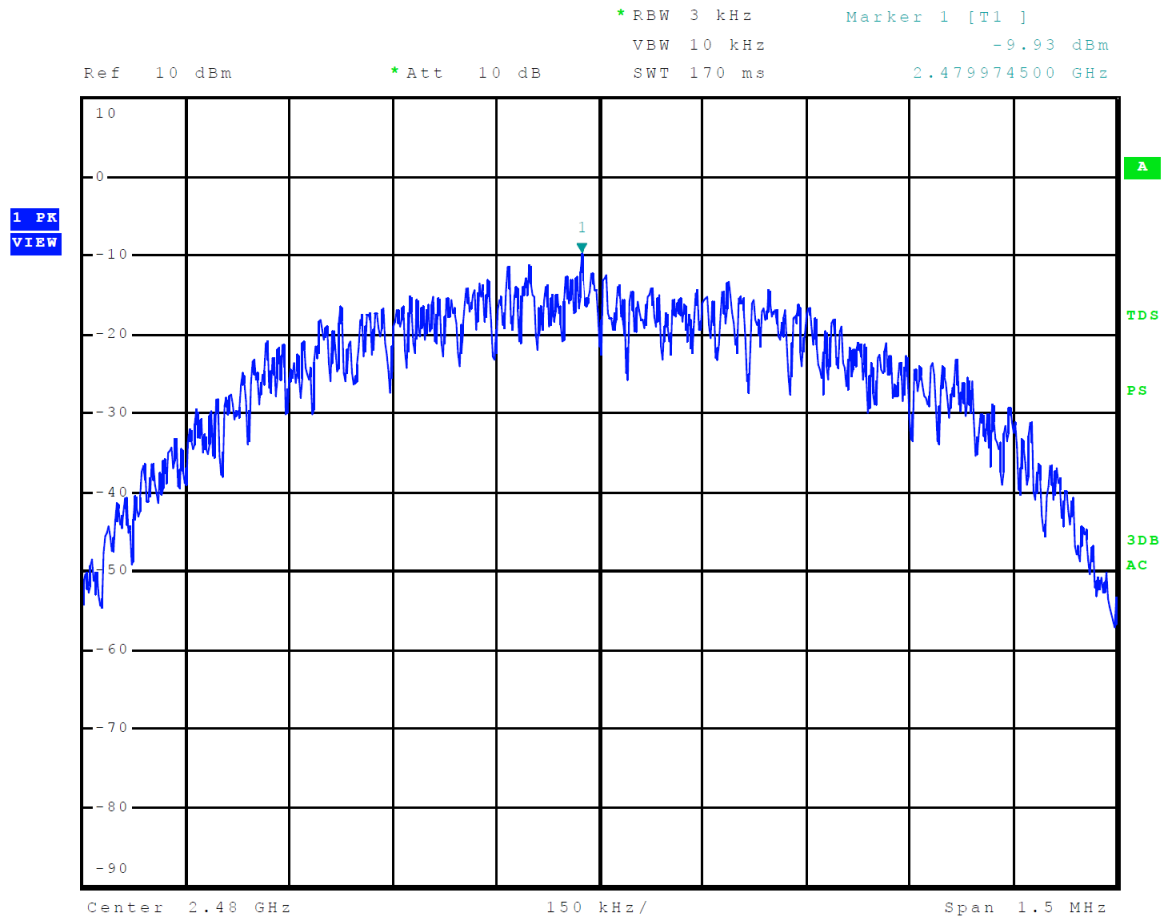

Figure 36 Plot of Transmitter Power Spectral Density Mode 5, 802.11b

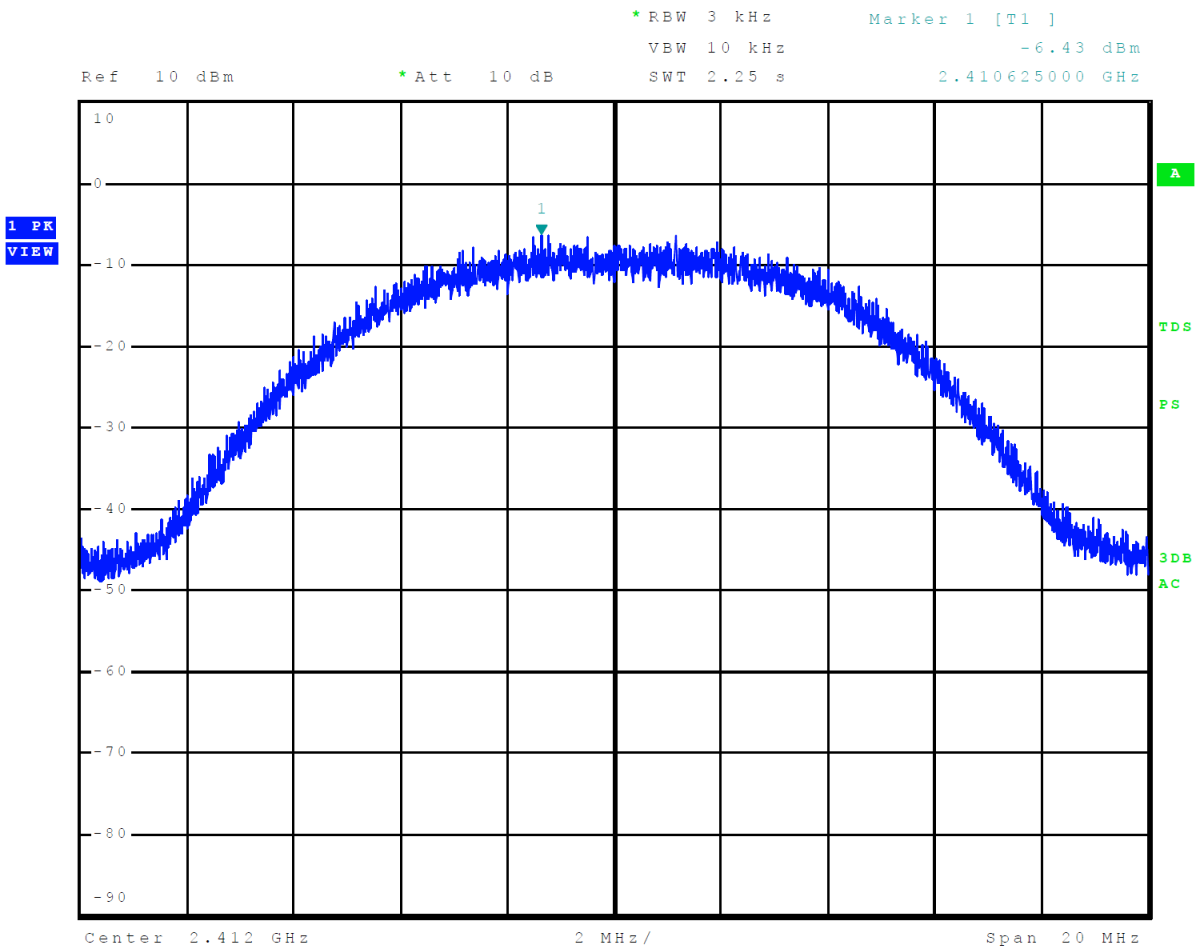

Figure 37 Plot of Transmitter Power Spectral Density Mode 6, 802.11g

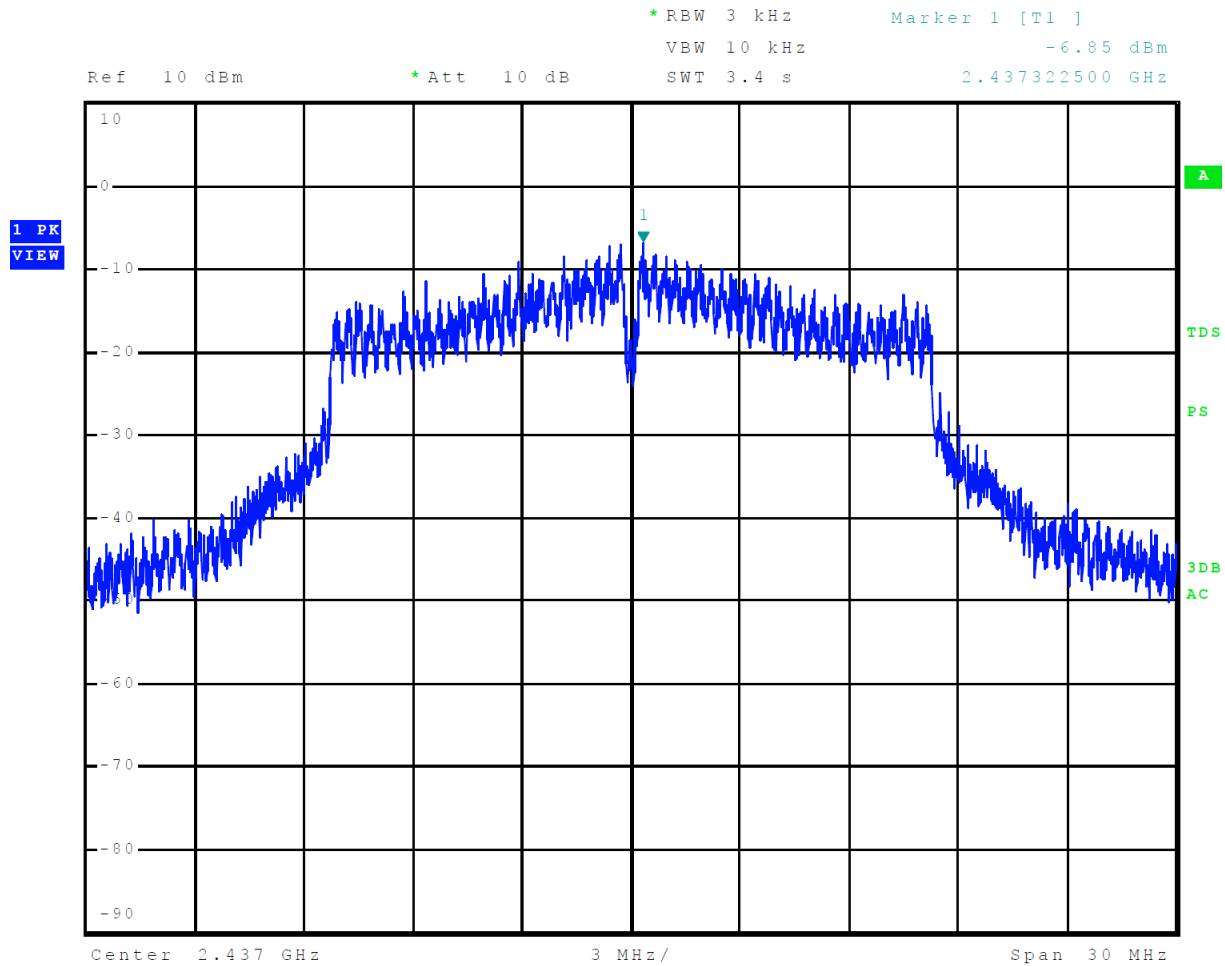
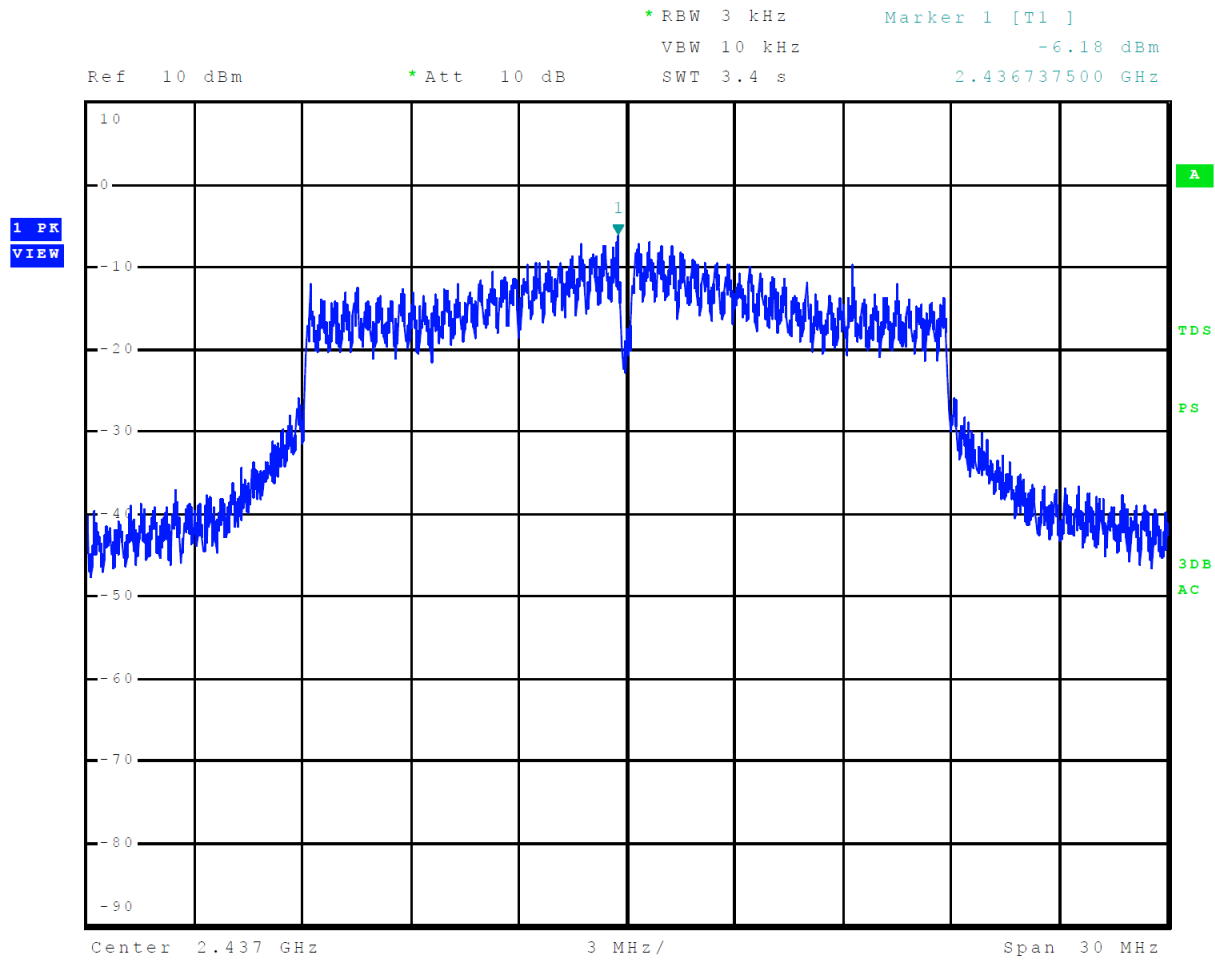

Figure 38 Plot of Transmitter Power Spectral Density Mode 7, 802.11n



Transmitter Emissions Data

Table 10 Transmitter Radiated Emissions Mode 2, BT 2EDR

Frequency in MHz	Horizontal Peak (dB μ V/m)	Horizontal Average (dB μ V/m)	Vertical Peak (dB μ V/m)	Vertical Average (dB μ V/m)	Limit @ 3m (dB μ V/m)	Horizontal Margin (dB)	Vertical Margin (dB)
2402.0	--	--	--	--	--	--	--
4804.0	50.9	36.9	50.7	36.9	54.0	-17.1	-17.1
7206.0	54.6	41.4	54.6	41.3	54.0	-12.6	-12.7
9608.0	58.0	44.7	58.9	44.7	54.0	-9.3	-9.3
12010.0	60.1	46.9	60.4	46.8	54.0	-7.1	-7.2
14412.0	60.3	47.0	61.1	46.9	54.0	-7.0	-7.1
16814.0	66.3	52.9	66.6	52.8	54.0	-1.1	-1.2
2440.0	--	--	--	--	--	--	--
4880.0	51.2	37.0	50.9	37.0	54.0	-17.0	-17.0
7320.0	55.4	41.4	55.1	41.4	54.0	-12.6	-12.6
9760.0	58.4	44.5	58.4	44.5	54.0	-9.5	-9.5
12200.0	60.6	47.3	61.1	47.3	54.0	-6.7	-6.7
14640.0	62.5	48.8	62.3	48.8	54.0	-5.2	-5.2
17080.0	66.6	53.1	66.8	53.1	54.0	-0.9	-0.9
2480.0	--	--	--	--	--	--	--
4960.0	51.4	37.3	51.3	37.5	54.0	-16.7	-16.5
7440.0	55.6	41.3	55.4	41.3	54.0	-12.7	-12.7
9920.0	58.5	44.9	58.9	45.0	54.0	-9.1	-9.0
12400.0	61.1	47.3	60.7	47.3	54.0	-6.7	-6.7
14880.0	62.6	49.0	62.4	49.0	54.0	-5.0	-5.0
17360.0	66.1	52.4	65.9	52.4	54.0	-1.6	-1.6

Other emissions present had amplitudes at least 20 dB below the limit. Peak and Quasi-Peak amplitude emissions are recorded for frequency below 1000 MHz. Peak and Average amplitude emissions are recorded for frequency range above 1000 MHz.

Table 11 Transmitter Radiated Emissions Mode 3, BT 3EDR

Frequency in MHz	Horizontal Peak (dBµV/m)	Horizontal Average (dBµV/m)	Vertical Peak (dBµV/m)	Vertical Average (dBµV/m)	Limit @ 3m (dBµV/m)	Horizontal Margin (dB)	Vertical Margin (dB)
2412.0	--	--	--	--	--	--	--
4824.0	50.0	36.4	50.9	36.4	54.0	-17.6	-17.6
7236.0	54.7	41.3	54.9	41.3	54.0	-12.7	-12.7
9648.0	58.7	44.9	58.6	45.0	54.0	-9.1	-9.0
12060.0	60.9	47.4	60.9	47.3	54.0	-6.6	-6.7
14472.0	61.8	47.2	60.9	47.2	54.0	-6.8	-6.8
16884.0	67.5	53.7	67.1	53.6	54.0	-0.3	-0.4
2437.0	--	--	--	--	--	--	--
4874.0	50.3	36.7	50.3	36.8	54.0	-17.3	-17.2
7311.0	55.3	41.5	55.5	41.4	54.0	-12.5	-12.6
9748.0	58.2	44.8	59.2	44.8	54.0	-9.2	-9.2
12185.0	62.1	47.9	61.8	47.9	54.0	-6.1	-6.1
14622.0	63.7	49.6	63.2	49.6	54.0	-4.4	-4.4
17059.0	67.3	53.5	66.7	53.5	54.0	-0.5	-0.5
2462.0	--	--	--	--	--	--	--
4924.0	50.4	36.5	50.3	36.7	54.0	-17.5	-17.3
7386.0	55.7	41.3	55.5	41.4	54.0	-12.7	-12.6
9848.0	58.9	45.1	59.0	45.1	54.0	-8.9	-8.9
12310.0	61.2	47.9	61.4	47.9	54.0	-6.1	-6.1
14772.0	62.5	49.1	62.8	49.1	54.0	-4.9	-4.9
17234.0	67.3	53.2	66.6	53.2	54.0	-0.8	-0.8

Other emissions present had amplitudes at least 20 dB below the limit. Peak and Quasi-Peak amplitude emissions are recorded for frequency below 1000 MHz. Peak and Average amplitude emissions are recorded for frequency range above 1000 MHz.

Table 12 Transmitter Radiated Emissions Mode 4, BT BLE

Frequency in MHz	Horizontal Peak (dBµV/m)	Horizontal Average (dBµV/m)	Vertical Peak (dBµV/m)	Vertical Average (dBµV/m)	Limit @ 3m (dBµV/m)	Horizontal Margin (dB)	Vertical Margin (dB)
2412.0	--	--	--	--	--	--	--
4824.0	50.5	36.4	50.6	36.6	54.0	-17.6	-17.4
7236.0	54.9	41.6	55.3	41.3	54.0	-12.4	-12.7
9648.0	58.6	44.9	58.5	44.9	54.0	-9.1	-9.1
12060.0	61.3	47.5	60.8	47.5	54.0	-6.5	-6.5
14472.0	61.4	47.3	60.8	47.3	54.0	-6.7	-6.7
16884.0	68.0	53.8	67.7	53.8	54.0	-0.2	-0.2
2437.0	--	--	--	--	--	--	--
4874.0	50.5	36.8	50.6	36.8	54.0	-17.2	-17.2
7311.0	56.5	42.8	55.0	41.5	54.0	-11.2	-12.5
9748.0	57.7	44.3	58.0	44.3	54.0	-9.7	-9.7
12185.0	62.0	48.2	61.6	48.2	54.0	-5.8	-5.8
14622.0	63.0	49.5	63.0	49.4	54.0	-4.5	-4.6
17059.0	66.6	53.3	67.0	53.3	54.0	-0.7	-0.7
2462.0	--	--	--	--	--	--	--
4924.0	50.4	36.6	50.2	36.7	54.0	-17.4	-17.3
7386.0	55.3	41.3	55.0	41.4	54.0	-12.7	-12.6
9848.0	58.4	45.1	58.8	45.1	54.0	-8.9	-8.9
12310.0	61.5	47.9	61.5	47.8	54.0	-6.1	-6.2
14772.0	63.4	49.1	62.8	49.1	54.0	-4.9	-4.9
17234.0	66.8	53.2	67.2	53.1	54.0	-0.8	-0.9

Other emissions present had amplitudes at least 20 dB below the limit. Peak and Quasi-Peak amplitude emissions are recorded for frequency below 1000 MHz. Peak and Average amplitude emissions are recorded for frequency range above 1000 MHz.

Table 13 Transmitter Radiated Emissions Mode 5, 802.11b

Frequency in MHz	Horizontal Peak (dBμV/m)	Horizontal Average (dBμV/m)	Vertical Peak (dBμV/m)	Vertical Average (dBμV/m)	Limit @ 3m (dBμV/m)	Horizontal Margin (dB)	Vertical Margin (dB)
2412.0	--	--	--	--	--	--	--
4824.0	51.7	37.0	51.8	38.0	54.0	-17.0	-16.0
7236.0	55.6	41.5	56.0	41.4	54.0	-12.5	-12.6
9648.0	59.0	45.3	59.2	46.2	54.0	-8.7	-7.8
12060.0	61.0	47.3	60.8	47.2	54.0	-6.7	-6.8
14472.0	61.8	48.4	61.9	48.4	54.0	-5.6	-5.6
16884.0	66.2	52.0	65.8	52.1	54.0	-2.0	-1.9
2437.0	--	--	--	--	--	--	--
4874.0	50.8	37.0	51.1	37.3	54.0	-17.0	-16.7
7311.0	56.0	42.1	55.4	41.6	54.0	-11.9	-12.4
9748.0	59.1	45.6	58.3	44.5	54.0	-8.4	-9.5
12185.0	61.2	46.5	60.7	46.5	54.0	-7.5	-7.5
14622.0	61.4	47.9	61.5	48.0	54.0	-6.1	-6.0
17059.0	65.3	51.9	65.0	51.8	54.0	-2.1	-2.2
2462.0	--	--	--	--	--	--	--
2462.0	51.6	37.5	51.3	37.2	54.0	-16.5	-16.8
4924.0	55.6	41.6	54.7	41.6	54.0	-12.4	-12.4
7386.0	59.0	45.4	59.1	45.4	54.0	-8.6	-8.6
9848.0	61.7	47.6	61.1	47.6	54.0	-6.4	-6.4
12310.0	61.3	48.2	61.7	48.2	54.0	-5.8	-5.8
14772.0	65.8	52.2	66.1	52.2	54.0	-1.8	-1.8

Other emissions present had amplitudes at least 20 dB below the limit. Peak and Quasi-Peak amplitude emissions are recorded for frequency below 1000 MHz. Peak and Average amplitude emissions are recorded for frequency range above 1000 MHz.

Table 14 Transmitter Radiated Emissions Mode 6, 802.11g

Frequency in MHz	Horizontal Peak (dBμV/m)	Horizontal Average (dBμV/m)	Vertical Peak (dBμV/m)	Vertical Average (dBμV/m)	Limit @ 3m (dBμV/m)	Horizontal Margin (dB)	Vertical Margin (dB)
2412.0	--	--	--	--	--	--	--
4824.0	50.9	37.0	51.0	37.2	54.0	-17.0	-16.8
7236.0	55.5	41.6	55.6	41.5	54.0	-12.4	-12.5
9648.0	59.6	45.3	59.9	47.2	54.0	-8.7	-6.8
12060.0	60.7	47.1	60.7	47.2	54.0	-6.9	-6.8
14472.0	61.8	48.3	62.3	48.3	54.0	-5.7	-5.7
16884.0	65.4	52.0	65.6	52.0	54.0	-2.0	-2.0
2437.0	--	--	--	--	--	--	--
4874.0	51.3	37.2	51.6	37.1	54.0	-16.8	-16.9
7311.0	56.5	42.2	55.7	41.6	54.0	-11.8	-12.4
9748.0	58.8	45.2	58.8	44.6	54.0	-8.8	-9.4
12185.0	60.0	46.5	60.3	46.6	54.0	-7.5	-7.4
14622.0	61.7	48.0	61.7	48.0	54.0	-6.0	-6.0
17059.0	65.6	51.9	65.2	51.8	54.0	-2.1	-2.2
2462.0	--	--	--	--	--	--	--
2462.0	50.6	37.1	51.3	37.1	54.0	-16.9	-16.9
4924.0	55.2	41.7	54.7	41.7	54.0	-12.3	-12.3
7386.0	59.3	45.6	59.3	45.5	54.0	-8.4	-8.5
9848.0	61.3	47.8	61.9	47.7	54.0	-6.2	-6.3
12310.0	62.8	48.4	62.1	48.3	54.0	-5.6	-5.7
14772.0	66.0	52.4	65.9	52.3	54.0	-1.6	-1.7

Other emissions present had amplitudes at least 20 dB below the limit. Peak and Quasi-Peak amplitude emissions are recorded for frequency below 1000 MHz. Peak and Average amplitude emissions are recorded for frequency range above 1000 MHz.

Table 15 Transmitter Radiated Emissions Mode 7, 802.11n

Frequency in MHz	Horizontal Peak (dB μ V/m)	Horizontal Average (dB μ V/m)	Vertical Peak (dB μ V/m)	Vertical Average (dB μ V/m)	Limit @ 3m (dB μ V/m)	Horizontal Margin (dB)	Vertical Margin (dB)
2412.0	--	--	--	--	--	--	--
4824.0	50.9	37.1	51.4	37.2	54.0	-16.9	-16.8
7236.0	55.1	41.5	55.3	41.5	54.0	-12.5	-12.5
9648.0	59.6	45.3	59.7	46.7	54.0	-8.7	-7.3
12060.0	61.2	47.5	60.6	47.4	54.0	-6.5	-6.6
14472.0	62.1	48.6	62.5	48.6	54.0	-5.4	-5.4
16884.0	65.5	52.3	65.6	52.2	54.0	-1.7	-1.8
2437.0	--	--	--	--	--	--	--
4874.0	50.9	37.2	51.8	37.2	54.0	-16.8	-16.8
7311.0	56.7	42.4	55.0	41.7	54.0	-11.6	-12.3
9748.0	58.9	45.6	58.0	44.6	54.0	-8.4	-9.4
12185.0	60.6	46.8	60.4	46.7	54.0	-7.2	-7.3
14622.0	62.8	48.3	61.5	48.0	54.0	-5.7	-6.0
17059.0	66.5	52.3	65.9	52.0	54.0	-1.7	-2.0
2462.0	--	--	--	--	--	--	--
2462.0	51.2	37.2	50.7	37.2	54.0	-16.8	-16.8
4924.0	55.5	42.0	55.3	41.8	54.0	-12.0	-12.2
7386.0	59.4	45.7	59.0	45.6	54.0	-8.3	-8.4
9848.0	61.6	47.9	61.5	47.9	54.0	-6.1	-6.1
12310.0	62.6	48.6	61.8	48.5	54.0	-5.4	-5.5
14772.0	66.3	52.6	66.1	52.5	54.0	-1.4	-1.5

Other emissions present had amplitudes at least 20 dB below the limit. Peak and Quasi-Peak amplitude emissions are recorded for frequency below 1000 MHz. Peak and Average amplitude emissions are recorded for frequency range above 1000 MHz.

Table 16 Transmitter Antenna Port Conducted Data modes 2 through 4

Frequency MHz	Antenna Port Average Output Power (Watts)	99% Occupied Bandwidth (kHz)	6-dB Occupied Bandwidth (kHz)	Peak Power Spectral Density (dBm)
Mode 2, BT 2EDR				
2402	0.003	1,204.5	1,074.8	-9.9
2440	0.004	1,204.5	1,075.5	-9.4
2480	0.003	1,205.3	1,072.5	-10.5
Mode 3, BT 3EDR				
2412	0.003	1,197.0	1,070.3	-8.8
2437	0.004	1,197.0	1,072.5	-8.4
2462	0.003	1,197.0	1,071.0	-9.4
Mode 4, BT BLE				
2412	0.003	1,053.8	715.5	-9.5
2437	0.004	1,054.5	720.0	-8.8
2462	0.003	1,054.5	718.5	-9.9

Table 17 Transmitter Antenna Port Conducted Data modes 5 through 7

Frequency MHz	Antenna Port Average Output Power (Watts)	99% Occupied Bandwidth (kHz)	6-dB Occupied Bandwidth (kHz)	Peak Power Spectral Density (dBm)
Mode 5, 802.11b				
2412	0.045	11,415.0	8,360.0	-6.4
2437	0.046	11,467.0	8,345.0	-6.0
2462	0.048	11,512.5	8,605.0	-6.0
Mode 6, 802.11g				
2412	0.037	16,940.0	15,959.0	-7.7
2437	0.039	16,860.0	15,720.0	-6.9
2462	0.040	17,040.0	16,000.0	-7.3
Mode 7, 802.11n				
2412	0.045	18,160.0	17,110.0	-7.3
2437	0.045	18,000.0	15,510.0	-6.2
2462	0.047	18,160.0	16,526.4	-7.9

Summary of Results for Transmitter Radiated Emissions of Intentional Radiator

The EUT demonstrated compliance with the radiated and conducted emission requirements of 47CFR Subpart 15C Paragraph 15.247, RSS-247 Issue 3 and RSS-GEN Issue 5 emission requirements for Digital Transmission Systems. The highest average output power measured at the antenna port for modes 2 through 7 was 0.048 Watts. The highest peak power spectral density measured at the antenna port for modes 2 through 7 presented a minimum margin of -11.0 dB below the requirements. The EUT demonstrated a minimum margin of -0.2 dB below the harmonic emissions requirements. There were no other significantly measurable emissions in the restricted bands other than those recorded in this report. Other emissions were present with amplitudes at least 20 dB below the requirements. There were no other deviations or exceptions to the requirements.

Annex

- Annex A Measurement Uncertainty Calculations
- Annex B Test Equipment
- Annex C Laboratory Certificate of Accreditation

Annex A Measurement Uncertainty Calculations

The measurement uncertainty was calculated for all measurements listed in this test report according To CISPR 16–4. Result of measurement uncertainty calculations are recorded below. Component and process variability of production devices similar to those tested may result in additional deviations. The manufacturer has the sole responsibility of continued compliance.

Measurement	Expanded Measurement Uncertainty $U_{(lab)}$
3 Meter Horizontal 0.009-1000 MHz Measurements	4.16
3 Meter Vertical 0.009-1000 MHz Measurements	4.33
3 Meter Measurements 1-18 GHz	5.46
3 Meter Measurements 18-40 GHz	5.16
10 Meter Horizontal Measurements 0.009-1000 MHz	4.15
10 Meter Vertical Measurements 0.009-1000 MHz	4.32
AC Line Conducted	1.75
Antenna Port Conducted power	1.17
Frequency Stability	1.00E-11
Temperature	1.6°C
Humidity	3%

Annex B Test Equipment

Equipment	Manufacturer	Model (SN)	Band	Last Cal Date	Next Cal Due
<input type="checkbox"/> AC Power Source	Ametech / California Instruments	??	N/A	2/18/2023	2/18/2024
<input type="checkbox"/> Amplifier	Com-Power	PA-010 (171003)	100Hz-30MHz	9/26/2023	9/26/2024
<input type="checkbox"/> Amplifier	Com-Power	CPPA-102 (01254)	1-1000 MHz	9/26/2023	9/26/2024
<input checked="" type="checkbox"/> Amplifier	Com-Power	PAM-118A (551014)	0.5-18 GHz	9/26/2023	9/26/2024
<input checked="" type="checkbox"/> Amplifier	Com-Power	PAM-840A (461328)	18-40 GHz	9/26/2023	9/26/2024
<input checked="" type="checkbox"/> Analyzer	Rohde & Schwarz	ESU40 (100108)	20Hz-40GHz	6/26/2023	6/26/2024
<input checked="" type="checkbox"/> Analyzer	Rohde & Schwarz	ESW44 (101534)	20Hz-44GHz	1/26/2024	1/26/2025
<input type="checkbox"/> Analyzer	Rohde & Schwarz	FS-Z60, 90, 140, and 220	40GHz-220GHz	12/22/2017	12/22/2027
<input checked="" type="checkbox"/> Analyzer	HP	8562A (3051A05950)	9kHz-125GHz	3/25/2024	3/25/2025
<input checked="" type="checkbox"/> Antenna	Com Power	AL-130 (121055)	.001-30 MHz	9/26/2023	9/26/2024
<input type="checkbox"/> Antenna	ARA	BCD-235-B (169)	20-350MHz	9/26/2023	9/26/2024
<input checked="" type="checkbox"/> Antenna	Sunol	JB-6 (A100709)	30-1000 MHz	11/8/2023	11/8/2024
<input type="checkbox"/> Antenna	ETS-Lindgren	3147 (40582)	200-1000MHz	9/26/2023	10/11/2024
<input checked="" type="checkbox"/> Antenna	ETS-Lindgren	3117 (200389)	1-18 GHz	3/25/2024	3/25/2026
<input checked="" type="checkbox"/> Antenna	Com Power	AH-118 (10110)	1-18 GHz	10/11/2022	10/11/2024
<input checked="" type="checkbox"/> Antenna	Com Power	AH-1840 (101046)	18-40 GHz	3/27/2023	3/27/2025
<input type="checkbox"/> Antenna	EMCO	6509	.001-30 MHz	10/11/2022	10/11/2024
<input type="checkbox"/> Antenna	Solar	9229-1 & 9230-1	??	2/18/2023	2/18/2024
<input type="checkbox"/> Attenuator	Fairview	SA6NFnF100W-40 (1625)	30-18000 MHz	3/25/2024	3/25/2025
<input checked="" type="checkbox"/> Attenuator	Mini-Circuits	VAT-3W2+ (1436)	30-6000 MHz	3/25/2024	3/25/2025
<input checked="" type="checkbox"/> Attenuator	Mini-Circuits	VAT-3W2+ (1445)	30-6000 MHz	3/25/2024	3/25/2025
<input checked="" type="checkbox"/> Attenuator	Mini-Circuits	VAT-3W2+ (1735)	30-6000 MHz	3/25/2024	3/25/2025
<input type="checkbox"/> Attenuator	Mini-Circuits	VAT-6W2+ (1438)	30-6000 MHz	3/25/2024	3/25/2025
<input type="checkbox"/> Attenuator	Mini-Circuits	VAT-6W2+ (1736)	30-6000 MHz	3/25/2024	3/25/2025
<input checked="" type="checkbox"/> Cable	Huber & Suhner Inc.	Sucoflex102ea(L10M)(303073)	9kHz-40Ghz	9/26/2023	9/26/2024
<input checked="" type="checkbox"/> Cable	Huber & Suhner Inc.	Sucoflex102ea(1.5M)(303069)	9kHz-40Ghz	9/26/2023	9/26/2024
<input type="checkbox"/> Cable	Huber & Suhner Inc.	Sucoflex102ea(1.5M)(303070)	9kHz-40Ghz	9/26/2023	9/26/2024
<input checked="" type="checkbox"/> Cable	Belden	RG-58 (L1-CAT3-11509)	9kHz-30 MHz	9/26/2023	9/26/2024
<input type="checkbox"/> Cable	Belden	RG-58 (L2-CAT3-11509)	9kHz-30 MHz	9/26/2023	9/26/2024
<input checked="" type="checkbox"/> Cable	Huber & Suhner Inc.	Sucoflex102ea(1.5M)(303072) 9kHz-40 GHz	9kHz-40Ghz	9/26/2023	9/26/2024
<input checked="" type="checkbox"/> Cable	Huber & Suhner Inc.	Sucoflex102ea(L1M)(281183) 9kHz-40 GHz	9kHz-40Ghz	9/26/2023	9/26/2024
<input checked="" type="checkbox"/> Cable	Huber & Suhner Inc.	Sucoflex102ea(L4M)(281184) 9kHz-40 GHz	9kHz-40Ghz	9/26/2023	9/26/2024
<input checked="" type="checkbox"/> Cable	Huber & Suhner Inc.	Sucoflex102ea(L10M)(317546)9kHz-40 GHz	9kHz-40Ghz	9/26/2023	9/26/2024
<input checked="" type="checkbox"/> Cable	Time Microwave	4M-750HF290-750 (S/N-L4M)	9kHz-24 GHz	9/26/2023	9/26/2024
<input type="checkbox"/> Cable	Mini-Circuits	KBL-2M-LOW+ (23090329)	9kHz-40Ghz	3/25/2024	3/25/2025

Equipment	Manufacturer	Model (SN)	Band	Last Cal Date	Next Cal Due
<input type="checkbox"/> CDN	Com-Power	CDN325E		10/11/2022	10/11/2024
<input type="checkbox"/> EMC Transient Generator HVT	EMC?	TR3000		2/18/2023	2/18/2024
<input type="checkbox"/> ESD Simulator	??	MZ-15	N/A	2/18/2023	2/18/2024
<input type="checkbox"/> Field Intensity Meter	??	EFM-018	??	2/18/2023	2/18/2024
<input type="checkbox"/> Frequency Counter	Leader	LDC-825	??	3/28/2023	3/28/2025
<input checked="" type="checkbox"/> Generator	Rohde & Schwarz	SMB100A6 (100150)	20Hz-6 GHz	3/25/2024	3/25/2025
<input checked="" type="checkbox"/> Generator	Rohde & Schwarz	SMBV100A6 (260771)	20Hz-6 GHz	3/25/2024	3/25/2025
<input type="checkbox"/> ISN	Com-Power	ISN T-8 (600111)	??	3/25/2024	3/25/2025
<input checked="" type="checkbox"/> LISN	Fischer Custom Communications	FCC-LISN-50-25-10(1PA) (160611)	.15-30MHz	3/25/2024	3/25/2025
<input type="checkbox"/> LISN	Fischer Custom Communications	FCC-LISN-50-16-2-08		3/25/2024	3/25/2025
<input type="checkbox"/> LISN	Compliance Design	FCC-LISN-2.Mod.cd,(126)	.15-30MHz	9/26/2023	10/11/2024
<input type="checkbox"/> LISN	Com-Power	LI-220A	??	3/29/2023	3/29/2025
<input checked="" type="checkbox"/> LISN	Com-Power	LI-550C	??	9/26/2023	10/11/2024
<input type="checkbox"/> Oscilloscope Scope	Tektronix	MDO 4104	??	2/18/2023	2/18/2024
<input checked="" type="checkbox"/> Power meter	Agilent	N1911A with N1921A	0.05-40 GHz	3/28/2023	3/28/2025
<input checked="" type="checkbox"/> Pwr Sensor	Rohde & Schwarz	NRP33T	0.05-33 GHz	9/26/2023	9/26/2025
<input checked="" type="checkbox"/> RF Filter	Micro-Tronics	BRC50722 (009).9G notch	30-18000 MHz	3/25/2024	3/25/2025
<input type="checkbox"/> RF Filter	Micro-Tronics	HPM50114 (017)1.5G HPF	30-18000 MHz	3/25/2024	3/25/2025
<input type="checkbox"/> RF Filter	Micro-Tronics	HPM50117 (063) 3G HPF	30-18000 MHz	3/25/2024	3/25/2025
<input type="checkbox"/> RF Filter	Micro-Tronics	HPM50105 (059) 6G HPF	30-18000 MHz	3/25/2024	3/25/2025
<input checked="" type="checkbox"/> RF Filter	Micro-Tronics	BRM50702 (172) 2G notch	30-18000 MHz	3/25/2024	3/25/2025
<input checked="" type="checkbox"/> RF Filter	Micro-Tronics	BRC50703 (G102) 5G notch	30-18000 MHz	3/25/2024	3/25/2025
<input checked="" type="checkbox"/> RF Filter	Micro-Tronics	BRC50705 (024) 5G notch	30-18000 MHz	3/25/2024	3/25/2025
<input type="checkbox"/> RF Filter	Micro-Tronics	BRC17663 (001)	9.3-9.5 notch 30-1800 MHz	3/28/2023	3/28/2025
<input type="checkbox"/> RF Filter	Micro-Tronics	BRC19565 (001)	9.2-9.6 notch 30-1800 MHz	3/28/2023	3/28/2025
<input type="checkbox"/> Wave Form Generator	Keysight	33512B (MY57400128)	??	3/29/2022	3/25/2026
<input type="checkbox"/> Weather station	Davis	6152 (A70927D44N)	N/A	7/13/2022	7/14/2024
<input checked="" type="checkbox"/> Generator	Rohde & Schwarz	SMBV100A6 (101844)	20Hz-6 GHz	3/07/2024	9/17/2025

Annex C Laboratory Certificate of Accreditation

3/18/24 through 3/31/25:

United States Department of Commerce
 National Institute of Standards and Technology



Certificate of Accreditation to ISO/IEC 17025:2017

NVLAP LAB CODE: 200087-0

Rogers Labs, a division of The Compatibility Center LLC
 Lenexa, KS

*is accredited by the National Voluntary Laboratory Accreditation Program for specific services,
 listed on the Scope of Accreditation, for:*

Electromagnetic Compatibility & Telecommunications

*This laboratory is accredited in accordance with the recognized International Standard ISO/IEC 17025:2017.
 This accreditation demonstrates technical competence for a defined scope and the operation of a laboratory quality
 management system (refer to joint ISO-ILAC-IAF Communique dated January 2009).*

2024-03-18 through 2025-03-31
 Effective Dates



 For the National Voluntary Laboratory Accreditation Program

3/16/23 through 3/31/24:

United States Department of Commerce
 National Institute of Standards and Technology



Certificate of Accreditation to ISO/IEC 17025:2017

NVLAP LAB CODE: 200087-0

Rogers Labs, a division of The Compatibility Center LLC
 Lenexa, KS

*is accredited by the National Voluntary Laboratory Accreditation Program for specific services,
 listed on the Scope of Accreditation, for:*

Electromagnetic Compatibility & Telecommunications

*This laboratory is accredited in accordance with the recognized International Standard ISO/IEC 17025:2017.
 This accreditation demonstrates technical competence for a defined scope and the operation of a laboratory quality
 management system (refer to joint ISO-ILAC-IAF Communique dated January 2009).*

2023-03-16 through 2024-03-31
 Effective Dates



 For the National Voluntary Laboratory Accreditation Program