

ROGERS LABS, INC.

4405 West 259th Terrace
Louisburg, KS 66053
Phone / Fax (913) 837-3214

47CFR, PART 15C - Intentional Radiators 47CFR Paragraph 15.249 and Industry Canada RSS-GEN Issue 5 and RSS-210 Issue 10 Application For Grant of Certification

Model: 04797

2402-2480 MHz

Low Power Digital Transmitter (DXX)

FCC ID: IPH-04797

IC: 1792A-04797

Garmin International, Inc.

1200 East 151st Street
Olathe, KS 66062

FCC Designation: US5305

ISED Registration: 3041A

Test Report Number: 230721A

Test Date: July 21, 2023

Authorized Signatory: *Scot D. Rogers*

Scot D. Rogers

This report shall not be reproduced except in full, without the written approval of the laboratory. This report must not be used by the client to claim product certification, approval, or endorsement by NVLAP, NIST, or any agency of the U.S. Government.

Rogers Labs, Inc.
4405 West 259th Terrace
Louisburg, KS 66053
Phone/Fax: (913) 837-3214
Revision 1

Garmin International, Inc.
HVIN: A04797, B04797
Test: 230721A
Test to: 47CFR 15C, RSS-Gen RSS-210
File: A04797 DXX TstRpt 230721A

FCC ID: IPH-04797
IC: 1792A-04797
SN's: 3449473321, 3449472678
Date: October 9, 2023
Page 1 of 30

TABLE OF CONTENTS..... 2

REVISIONS..... 3

EXECUTIVE SUMMARY 4

OPINION / INTERPRETATION OF RESULTS 5

EQUIPMENT TESTED..... 5

 Equipment Operational Modes.....6

 Equipment Function6

 Equipment Configuration.....7

APPLICATION FOR CERTIFICATION..... 8

APPLICABLE STANDARDS..... 9

EQUIPMENT TESTING PROCEDURES 9

 AC Line Conducted Emission Test Procedure9

 Radiated Emission Test Procedure.....9

 Antenna Port Conducted Emission Test Procedure.....9

 Diagram 1 Test arrangement for radiated emissions of tabletop equipment.....10

 Diagram 2 Test arrangement for radiated emissions tested on Open Area Test Site (OATS).....11

 Diagram 3 Test arrangement for Antenna Port Conducted emissions.....12

TEST SITE LOCATIONS 12

UNITS OF MEASUREMENTS 13

ENVIRONMENTAL CONDITIONS..... 13

STATEMENT OF MODIFICATIONS AND DEVIATIONS 13

INTENTIONAL RADIATORS..... 14

 Antenna Requirements14

 Restricted Bands of Operation.....14

Table 1 Radiated Emissions in Restricted Frequency Bands Data Mode 1 ANT (GFSK)..... 15

Summary of Results for Radiated Emissions in Restricted Bands15

General Radiated Emissions Procedure.....16

Table 2 General Radiated Emissions Data17

Summary of Results for General Radiated Emissions17

Operation in the Band 2400 – 2483.5 MHz18

Figure 1 Plot of Transmitter Emissions in 2402-2480 MHz Mode 1 ANT (GFSK)..... 19

Figure 2 Plot of Transmitter Emissions Low Band Edge Mode 1 ANT (GFSK)20

Figure 3 Plot of Transmitter Emissions High Band Edge Mode 1 ANT (GFSK)21

Figure 4 Plot of Transmitter 99% Occupied Bandwidth Mode 1 ANT (GFSK)22

Transmitter Emissions Data.....23

Table 3 Transmitter Radiated Emissions Mode 1 ANT (GFSK).....23

Summary of Results for Transmitter Radiated Emissions of Intentional Radiator.....24

ANNEX..... 25

Annex A Measurement Uncertainty Calculations.....26

Annex B Test Equipment.....27

Annex C Rogers Qualifications29

Annex D Laboratory Certificate of Accreditation.....30

Revisions

Revision 1 Issued Issued October 9, 2023

Executive Summary

License Exempt Digital Transmission System Intentional Radiator operating under Title 47 Code of Federal Regulations (47 CFR) Paragraph 15.249 and Industry Canada RSS-210 Issue 10 and RSS-GEN Issue 5, Low Power (DXX) Digital Device transmitter operations in the 2400 – 2483.5 MHz frequency band.

Name of Applicant: Garmin International, Inc.
1200 East 151st Street
Olathe, KS 66062

PMN: HVIN: A04797, B04797
FCC ID: IPH-04797 IC: 1792A-04797
Operating Frequency Range: 2402-2480 MHz

A04797 was chosen for transmitter configuration testing and used for final measurements.

Operational communication mode 1.

Mode	Peak Power (dB μ V/m@3m)	Average power (dB μ V/m@3m)	99% OBW (kHz)
Mode 1, ANT (GFSK)	93.3	88.5	1,044.0

This report addresses EUT Operations as Low Power Transmitter (DXX) using transmitter modulation using mode 1. Note, the production device utilizes a non-user accessible integral antenna system with 3.1 dBi gain.

Opinion / Interpretation of Results

Tests Performed	Margin (dB)	Results
Restricted Bands 47 CFR 15.205, RSS-210 4.1	-1.9	Complies
Emissions as per 47CFR 15.207, RSS-GEN 8.8	N/A	N/A
Radiated Emissions 47 CFR 15.209, RSS-GEN 8.9	-2.2	Complies
Harmonic Emissions per 47 CFR 15.249, RSS-210 B.10	-5.5	Complies

Equipment Tested

Model: 04797

Garmin International, Inc.
1200 East 151st Street
Olathe, KS 66062

<u>Equipment</u>	<u>Model / PN</u>	<u>Serial Number</u>
EUT Tx Radiated	A04797	3449473321
EUT General Emissions	A04797	3449473321
EUT Antenna Port Conducted	B04797	3449472678
DC power Cable (<80cm)	Garmin 2-pin	N/A
DC power Cable (2cm)	Garmin 2-pin	N/A
Garmin XDRCR	Garmin Transducer	N/A
Garmin Network	Garmin Network	N/A
DC Power Supply	BK 1745	209C13

Test results in this report relate only to the items tested. Worst-case configuration data recorded in this report.

Software: 32.68, Antenna: 2.4 GHz non-user accessible providing 3.1 dBi gain

Equipment Operational Modes

Mode	Transmitter Operation
1	ANT (GFSK)
2	BT BLE (GMSK)
3	802.11b (DSSS/CCK)
4	802.11g, (OFDM)
5	802.11n (MCS)

Equipment Function

The EUT is a transceiver with display and GNSS. The radio supports 802.11b, 802.11g, 802.11n, BLE and ANT transmit and receive. For more detailed feature descriptions, please refer to the manufacturer’s specifications or user’s manual. This report is intended to cover both A04797 and B04797. The typical use configuration has the EUT and powered from direct current power. The design provides interface capability as presented below and wireless communications with compatible equipment. The EUT was arranged as described by the manufacturer emulating typical user configurations for testing purposes. The EUT offers no other interface connections than those presented in the configuration options as described by the manufacturer and presented below. For testing purposes, the EUT received power from external direct current power supply. During testing, the test system was configured to operate in a manufacturer defined modes. The manufacturer provided test software for testing transmitter and equipment function. The software provided the ability to operate the transmitters at near 100% duty cycle for testing purposes. The testing mode of operation exceeds typical duty cycle operation of production equipment. As requested by the manufacturer the equipment was tested for emissions compliance using the available configurations with the worst-case data presented. Test results in this report relate only to the products described in this report.

Equipment Configuration

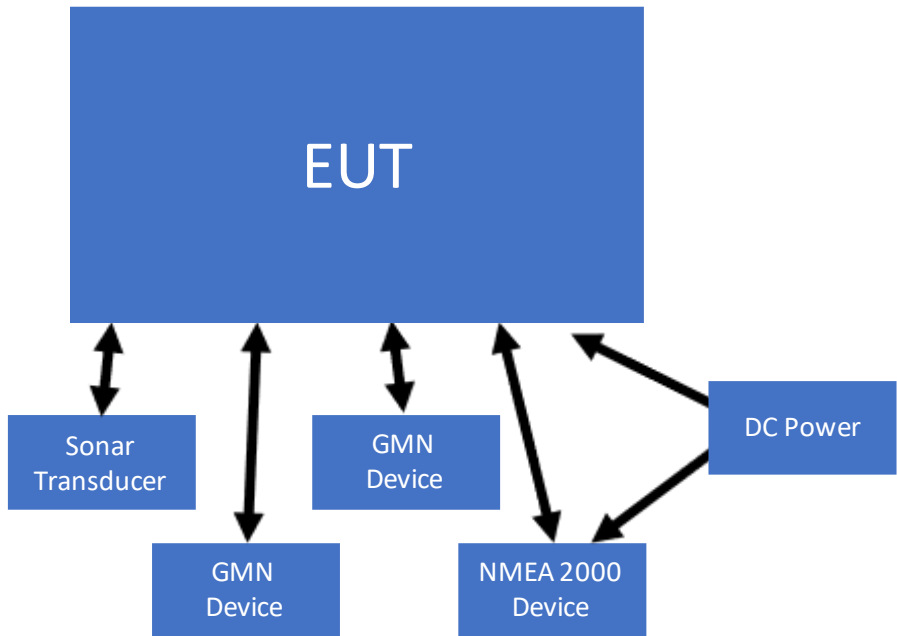

Application for Certification

- (1) Manufacturer: Garmin International, Inc.
1200 East 151st Street
Olathe, KS 66062
- (2) Identification: HVIN: A04797, B04797
FCC ID: IPH-04797 IC: 1792A-04797
- (3) Instruction Book:
Refer to Exhibit for Instruction Manual.
- (4) Description of Circuit Functions:
Refer to Exhibit of Operational Description.
- (5) Block Diagram with Frequencies:
Refer to Exhibit of Operational Description.
- (6) Report of Measurements:
Report of measurements follows in this Report.
- (7) Photographs: Construction, Component Placement, etc.:
Refer to Exhibit for photographs of equipment.
- (8) List of Peripheral Equipment Necessary for operation. The equipment operates from external direct current power provided from installation vehicle. The EUT provides interface ports for power, loads and communications as presented in this filing.
- (9) Transition Provisions of 47 CFR 15.37 are not requested.
- (10) Not Applicable. The unit is not a scanning receiver.
- (11) Not Applicable. The EUT does not operate in the 59 – 64 GHz frequency band.
- (12) The equipment is not software defined and this section is not applicable.
- (13) Applications for certification of U-NII devices in the 5.15-5.35 GHz and the 5.47-5.85 GHz bands must include a high-level operational description of the security procedures that control the radio frequency operating parameters and ensure that unauthorized modifications cannot be made. This requirement is not applicable to his DTS device.
- (14) Contain at least one drawing or photograph showing the test set-up for each of the required types of tests applicable to the device for which certification is requested. These drawings or photographs must show enough detail to confirm other information contained in the test report. Any photographs used must be focused originals without glare or dark spots and must clearly show the test configuration used. This information is provided in this report and Test Setup Exhibits provided with the application filing.

Applicable Standards

The following information is submitted in accordance with the eCFR Title 47 Code of Federal Regulations (47CFR), dated July 21, 2023: Part 2, Subpart J, Part 15C Paragraph 15.249, Industry Canada RSS-210 Issue 10, and RSS-GEN Issue 5. Test procedures used are the established Methods of Measurement of Radio-Noise Emissions as described in ANSI C63.10-2013. This report documents compliance with the EUT operations as Low Power Transmitter (DXX).

Equipment Testing Procedures

AC Line Conducted Emission Test Procedure

The design operates from Direct Current power only and offers no provision to interface with Utility AC Power systems. Therefore, No AC Line conducted emissions testing was required or preformed.

Radiated Emission Test Procedure

Radiated emissions testing was performed as required in 47 CFR 15C, RSS-210 Issue 10, and specified in ANSI C63.10-2013. The EUT was placed on a rotating 0.9 x 1.2-meter platform, elevated as required above the ground plane at a distance of 3 meters from the FSM antenna. EMI energy was maximized by equipment placement permitting orientation in three orthogonal axes, raising, and lowering the FSM antenna, changing the antenna polarization, and by rotating the turntable. Each emission was maximized before data was taken and recorded. The frequency spectrum from 9 kHz to 25,000 MHz was searched for emissions during preliminary investigation. Refer to diagrams one and two showing typical test setup. Refer to photographs in the test setup exhibits for specific EUT placement during testing.

Antenna Port Conducted Emission Test Procedure

The EUT was assembled as required for operation placed on a benchtop. This configuration provided the ability to connect test equipment to the provided test antenna port. Antenna Port conducted emissions testing was performed presented in the regulations and specified in ANSI C63.10-2013. Testing was completed on a laboratory bench in a shielded room. The active antenna port of the device was connected to appropriate attenuation and the spectrum analyzer. Refer to diagram three showing typical test arrangement and photographs in the test setup exhibits for specific EUT placement during testing.

Diagram 1 Test arrangement for radiated emissions of tabletop equipment

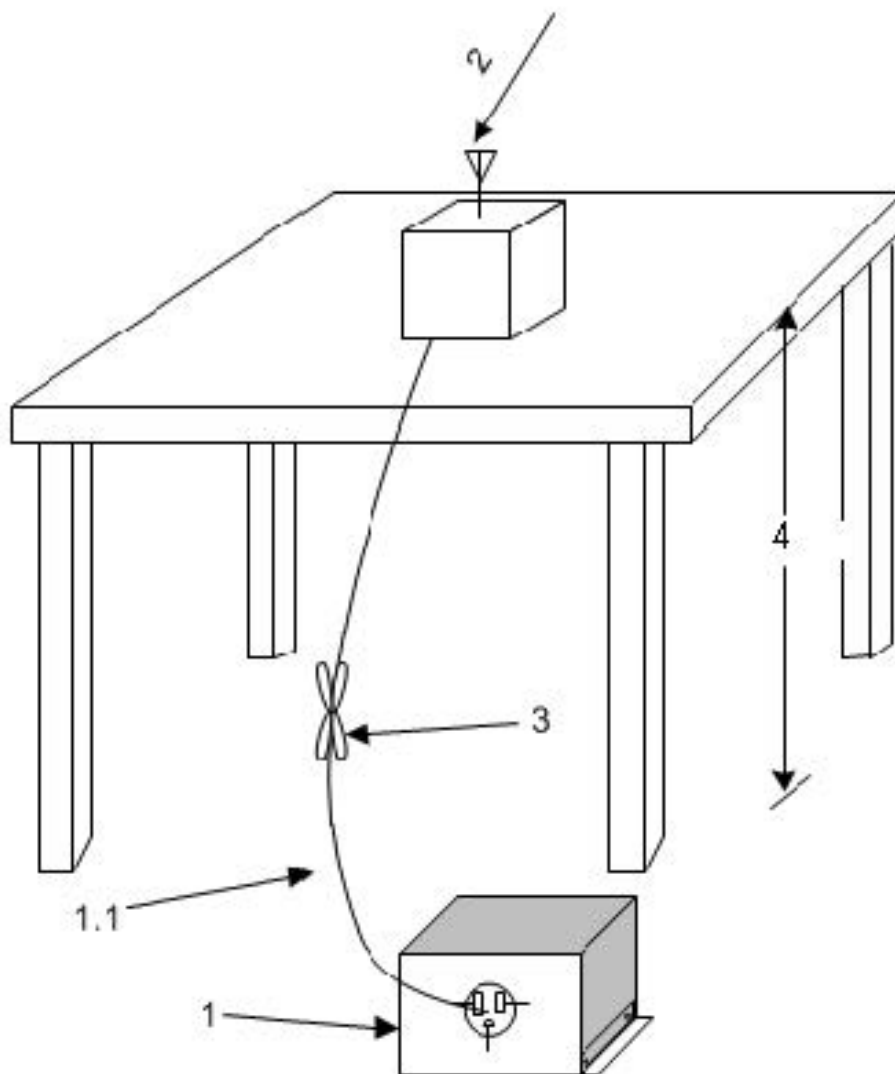

1—A LISN is optional for radiated measurements between 30 MHz and 1000 MHz but not allowed for measurements below 30 MHz and above 1000 MHz (see 6.3.1). If used, then connect EUT to one LISN. Unused LISN measuring port connectors shall be terminated in 50 Ω loads. The LISN may be placed on top of, or immediately beneath, the reference ground plane (see 6.2.2 and 6.2.3.2).

1.1—LISN spaced at least 80 cm from the nearest part of the EUT chassis.

2—Antenna can be integral or detachable, depending on the EUT (see 6.3.1).

3—Interconnecting cables that hang closer than 40 cm to the ground plane shall be folded back and forth in the center forming a bundle 30 cm to 40 cm long (see 6.3.1).

4—For emission measurements at or below 1 GHz, the table height shall be 80 cm. For emission measurements above 1 GHz, the table height shall be 1.5 m for measurements, except as otherwise specified (see 6.3.1 and 6.6.3.1).

Diagram 2 Test arrangement for radiated emissions tested on Open Area Test Site (OATS)

Test arrangement for radiated emissions Below 1 GHz

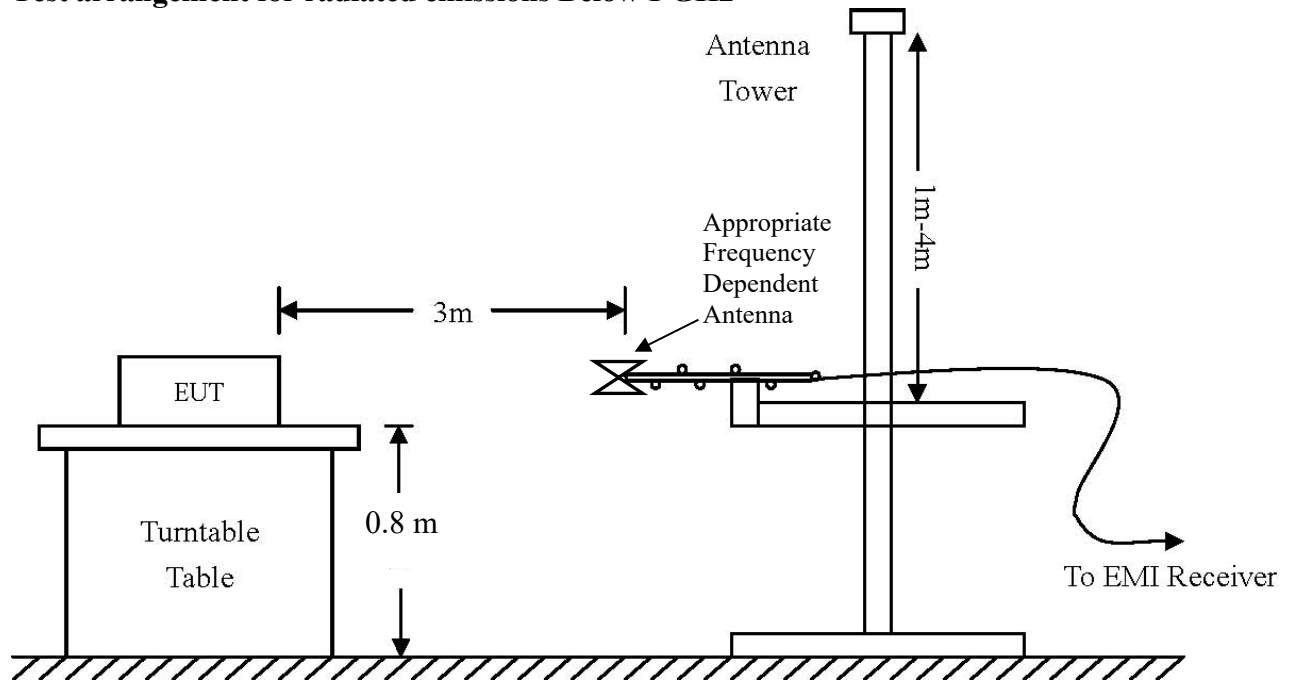

Test arrangement for radiated emissions Above 1 GHz

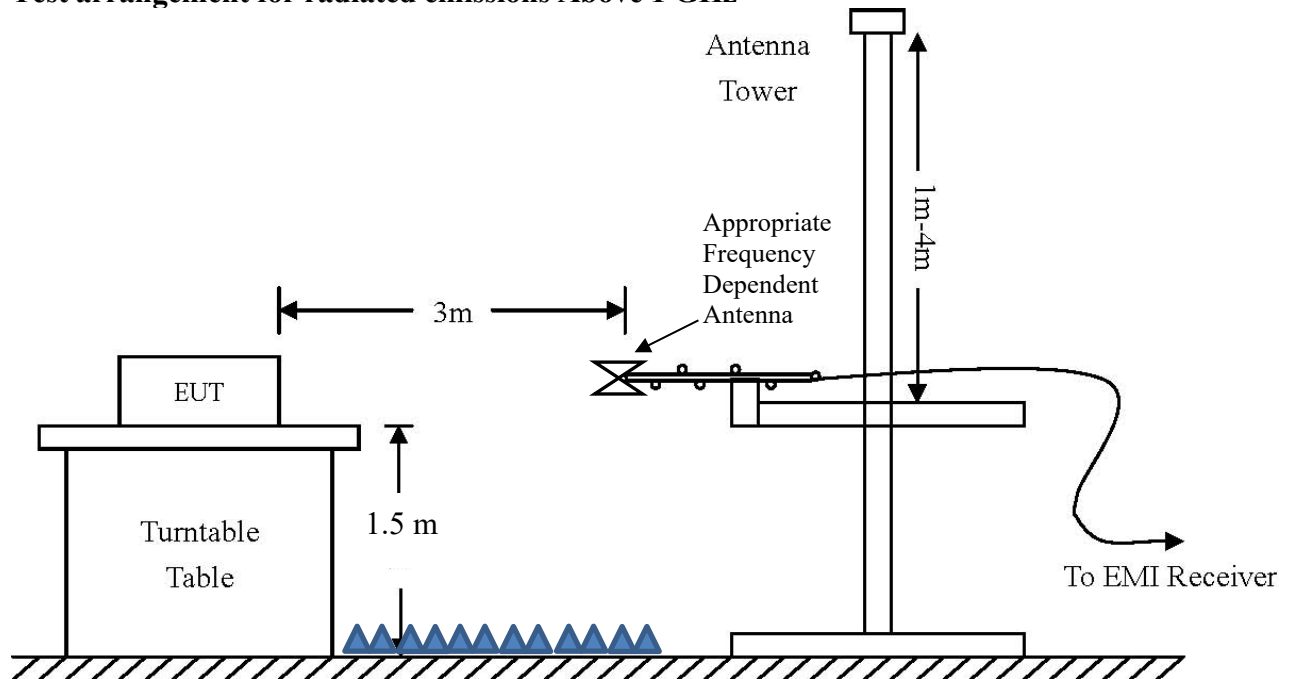
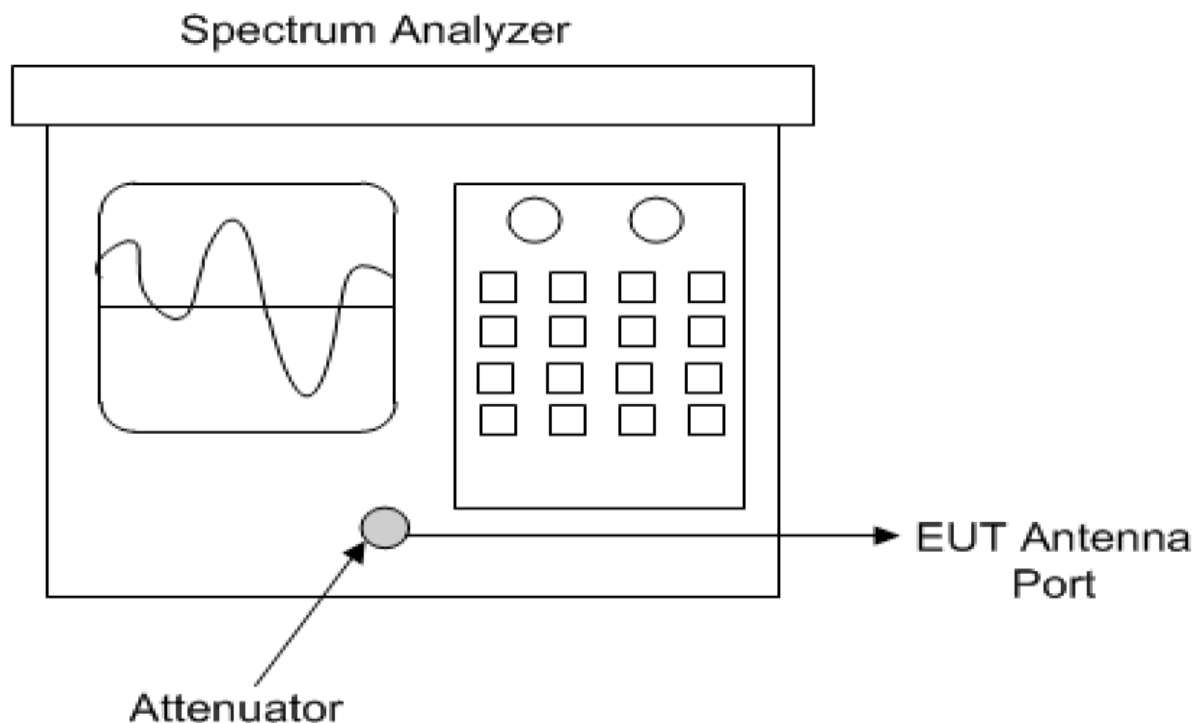

Diagram 3 Test arrangement for Antenna Port Conducted emissions



Test Site Locations

Conducted EMI AC line conducted emissions testing performed in a shielded screen room located at Rogers Labs, Inc., 4405 West 259th Terrace, Louisburg, KS

Antenna port Antenna port conducted emissions testing was performed in a shielded screen room located at Rogers Labs, Inc., 4405 West 259th Terrace, Louisburg, KS

Radiated EMI The radiated emissions tests were performed at the 3 meters, Open Area Test Site (OATS) located at Rogers Labs, Inc., 4405 West 259th Terrace, Louisburg, KS

Registered Site information: FCC Site: US5305, ISED: 3041A, CAB Identifier: US0096

NVLAP Accreditation Lab code 200087-0

Units of Measurements

Conducted EMI Data presented in dB μ V; dB referenced to one microvolt

Antenna port Conducted Data is in dBm; dB referenced to one milliwatt

Radiated EMI Data presented in dB μ V/m; dB referenced to one microvolt per meter

Note: Radiated limit may be expressed for measurement in dB μ V/m when the measurement is taken at a distance of 3 or 10 meters. Data taken for this report was taken at distance of 3 meters.

Sample calculation demonstrates corrected field strength reading for Open Area Test Site using the measurement reading and correcting for receive antenna factor, cable losses, and amplifier gains.

Sample Calculation:

RFS = Radiated Field Strength, FSM = Field Strength Measured

A.F. = Receive antenna factor, Losses = attenuators/cable losses, Gain = amplification gains

$RFS (dB\mu V/m @ 3m) = FSM (dB\mu V) + A.F. (dB/m) + Losses (dB) - Gain (dB)$

Environmental Conditions

Ambient Temperature 23.9° C

Relative Humidity 42.0 %

Atmospheric Pressure 1022.6 mb

Statement of Modifications and Deviations

No modifications to the EUT were required for the equipment to demonstrate compliance with the 47 CFR Part 15C, Industry Canada RSS-210 Issue 10, and RSS-GEN Issue 5 emission requirements. There were no deviations to the specifications.

Intentional Radiators

The following information is submitted supporting compliance with the requirements of 47 CFR, Subpart C, paragraph 15.249, Industry Canada RSS-210 Issue 10, and RSS-GEN Issue 5.

Antenna Requirements

The EUT incorporates integral non-user accessible systems. Production equipment offers no provision for connection to alternate antenna system. The antenna connection point complies with the unique antenna connection requirements. There are no deviations or exceptions to the specification.

Restricted Bands of Operation

Spurious emissions falling in the restricted frequency bands of operation were measured at the OATS. The EUT utilizes frequency, determining circuitry, which generates harmonics falling in the restricted bands. Emissions were investigated at the OATS, using appropriate antennas or pyramidal horns, amplification stages, and receiver / spectrum analyzer. Peak and average amplitudes of frequencies above 1000 MHz were compared to the required limits with worst-case data presented below. Test procedures of ANSI C63.10-2013 were used during testing. No other significant emission was observed which fell into the restricted bands of operation. Computed emission values consider the received radiated field strength, receive antenna correction factor, amplifier gain stage, and test system cable losses.

Table 1 Radiated Emissions in Restricted Frequency Bands Data Mode 1 ANT (GFSK)

Frequency in MHz	Horizontal Peak (dBμV/m)	Horizontal Average (dBμV/m)	Vertical Peak (dBμV/m)	Vertical Average (dBμV/m)	Limit @ 3m (dBμV/m)	Horizontal Margin (dB)	Vertical Margin (dB)
2390.0	44.8	30.7	43.7	30.7	54.0	-23.3	-23.3
2483.5	44.8	31.7	46.4	31.9	54.0	-22.3	-22.1
4804.0	49.3	36.3	49.8	36.3	54.0	-17.7	-17.7
4914.0	49.2	36.3	49.1	36.5	54.0	-17.7	-17.5
4960.0	49.5	36.4	49.5	36.4	54.0	-17.6	-17.6
7206.0	53.2	40.2	52.9	40.1	54.0	-13.8	-13.9
7371.0	53.2	40.0	53.3	40.4	54.0	-14.0	-13.6
7440.0	53.4	40.4	52.8	40.4	54.0	-13.6	-13.6
12010.0	58.8	45.9	58.4	45.9	54.0	-8.1	-8.1
12285.0	60.1	47.3	60.2	47.5	54.0	-6.7	-6.5
12400.0	59.5	47.0	60.1	47.0	54.0	-7.0	-7.0

Other emissions present had amplitudes at least 20 dB below the limit. Peak and Quasi-Peak amplitude emissions are recorded for frequency below 1000 MHz. Peak and Average amplitude emissions are recorded for frequency range above 1000 MHz.

Summary of Results for Radiated Emissions in Restricted Bands

The EUT demonstrated compliance with the radiated emissions requirements of 47CFR Part 15C and RSS-210 Issue 10 Intentional Radiator requirements. The EUT demonstrated a worst-case minimum margin of -6.5 dB below the emissions requirements in restricted frequency bands. Peak, Quasi-peak, and average amplitudes were checked for compliance with the regulations. Worst-case emissions are reported with other emissions found in the restricted frequency bands at least 20 dB below the requirements.

General Radiated Emissions Procedure

The EUT was arranged in a manufacturer defined equipment configuration and operated with transmitter active during testing. Preliminary testing was performed in a screen room with the EUT positioned 1 meter from the FSM. Radiated emissions measurements were performed to identify the frequencies which produced the highest emissions. Each radiated emission was then maximized at the OATS location before final radiated measurements were performed. Final data was taken with the EUT located on the OATS at 3 meters distance between the EUT and the receiving antenna. The frequency spectrum from 9 kHz to 25,000 MHz was searched for general radiated emissions. Measured emission levels were maximized by EUT placement on the table, rotating the turntable through 360 degrees, varying the antenna height between 1 and 4 meters above the ground plane and changing antenna position between horizontal and vertical polarization. Antennas used were Loop from 9 kHz to 30 MHz, Broadband Biconical from 30 to 200 MHz, Biconilog from 30 to 1000 MHz, Log Periodic from 200 MHz to 1 GHz and or double Ridge or pyramidal horns and mixers above 1 GHz, notch filters and appropriate amplifiers and external mixers were utilized.

Table 2 General Radiated Emissions Data

Frequency (MHz)	Horizontal Peak (dBµV/m)	Horizontal Quasi-Peak (dBµV/m)	Vertical Peak (dBµV/m)	Vertical Quasi-Peak (dBµV/m)	Limit @ 3m (dBµV/m)	Horizontal Margin (dB)	Vertical Margin (dB)
58.1	47.6	33.3	51.6	36.3	40.0	-6.7	-3.7
63.4	46.5	36.5	48.5	34.3	40.0	-3.5	-5.7
67.7	41.8	36.5	51.6	37.3	40.0	-3.5	-2.7
78.5	44.7	34.6	46.1	32.4	40.0	-5.4	-7.6
83.0	44.4	34.4	53.1	36.9	40.0	-5.6	-3.1
110.5	41.5	29.5	41.7	28.6	43.5	-14.0	-14.9
123.7	37.7	31.9	44.8	33.8	43.5	-11.6	-9.7
125.0	42.5	38.0	40.9	37.4	43.5	-5.5	-6.1
137.1	35.5	29.8	37.6	29.2	43.5	-13.7	-14.3
165.8	32.7	29.0	32.4	21.9	43.5	-14.5	-21.6
250.0	43.4	40.6	38.2	35.9	46.0	-5.4	-10.1
259.8	38.7	36.5	31.6	28.9	46.0	-9.5	-17.1
277.7	45.5	43.8	37.9	35.6	46.0	-2.2	-10.4
356.8	48.3	37.8	40.9	27.3	46.0	-8.2	-18.7
450.0	42.9	39.9	42.2	40.2	46.0	-6.1	-5.8
750.1	43.6	39.5	45.5	39.9	46.0	-6.5	-6.1

Other emissions present had amplitudes at least 20 dB below the limit. Peak and Quasi-Peak amplitude emissions are recorded for frequency range below 1000 MHz. Peak and Average amplitude emissions are recorded for frequency range above 1000 MHz.

Summary of Results for General Radiated Emissions

The EUT demonstrated compliance with the radiated emissions requirements of 47CFR Part 15C paragraph 15.209, RSS-210 Issue 10, and RSS-GEN Issue 5 Intentional Radiators. The EUT worst-case transmitter configuration demonstrated a minimum margin of -2.2 dB below the requirements. Other emissions were present with amplitudes at least 20 dB below the Limits.

Operation in the Band 2400 – 2483.5 MHz

The transmitter output power, harmonic, and general emissions were measured on an Open Area Test Site (OATS) @ 3 meters. The amplitude of radiated emission was measured on the OATS at distance of 3 meters from the FSM antenna (radiated emission testing was performed on sample #1) representative of production equipment with integral antennas. The EUT was placed on a turntable elevated as required above the ground plane and at a distance of 3 meters from the FSM antenna. The peak and quasi-peak amplitude of frequencies below 1000 MHz were measured using a spectrum analyzer. The peak and average amplitude of frequencies above 1000 MHz were measured using a spectrum analyzer. The amplitude of each emission was then recorded from the analyzer display. Emissions radiated outside of the specified bands, except for harmonics, shall be attenuated by at least 50 dB below the level of the fundamental or to the general radiated emission limits, whichever is the lesser attenuation. Antenna port emission plots were taken of transmitter performance for reference in this and other documentation using test sample #4. The amplitude of each radiated emission was maximized by equipment orientation and placement on the turn table, raising and lowering the FSM (Field Strength Measuring) antenna, changing the FSM antenna polarization, and by rotating the turntable. A Loop antenna was used for measuring emissions from 0.009 to 30 MHz, Biconilog Antenna for 30 to 1000 MHz, Double-Ridge, and/or Pyramidal Horn Antennas from 1 GHz to 25 GHz. Emissions were measured in dB μ V/m @ 3 meters.

Refer to figures one through four showing plots of mode 1 taken of the 2402-2480 MHz transmitter operation displaying compliance with the specifications.

Figure 1 Plot of Transmitter Emissions in 2402-2480 MHz Mode 1 ANT (GFSK)

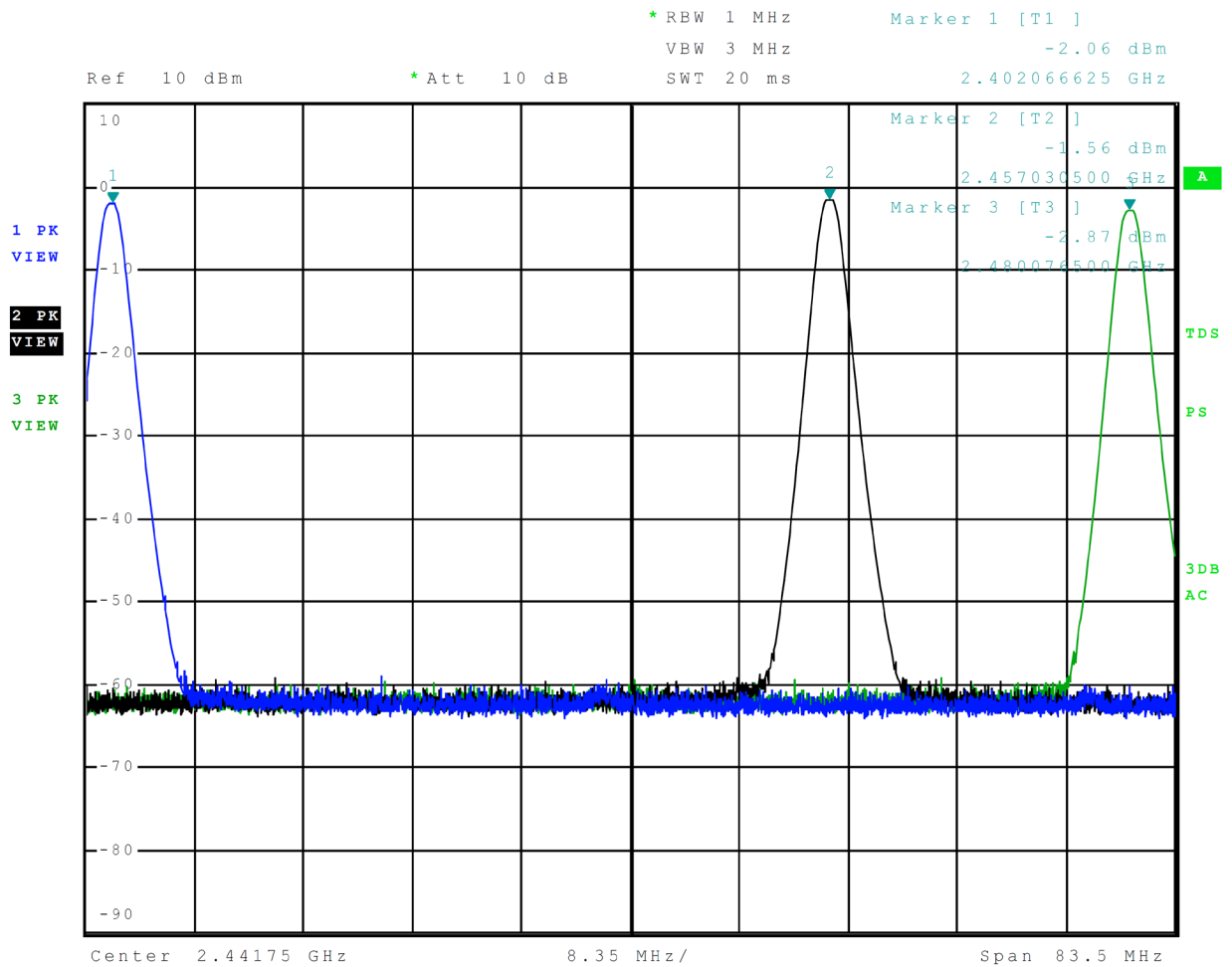

Figure 2 Plot of Transmitter Emissions Low Band Edge Mode 1 ANT (GFSK)

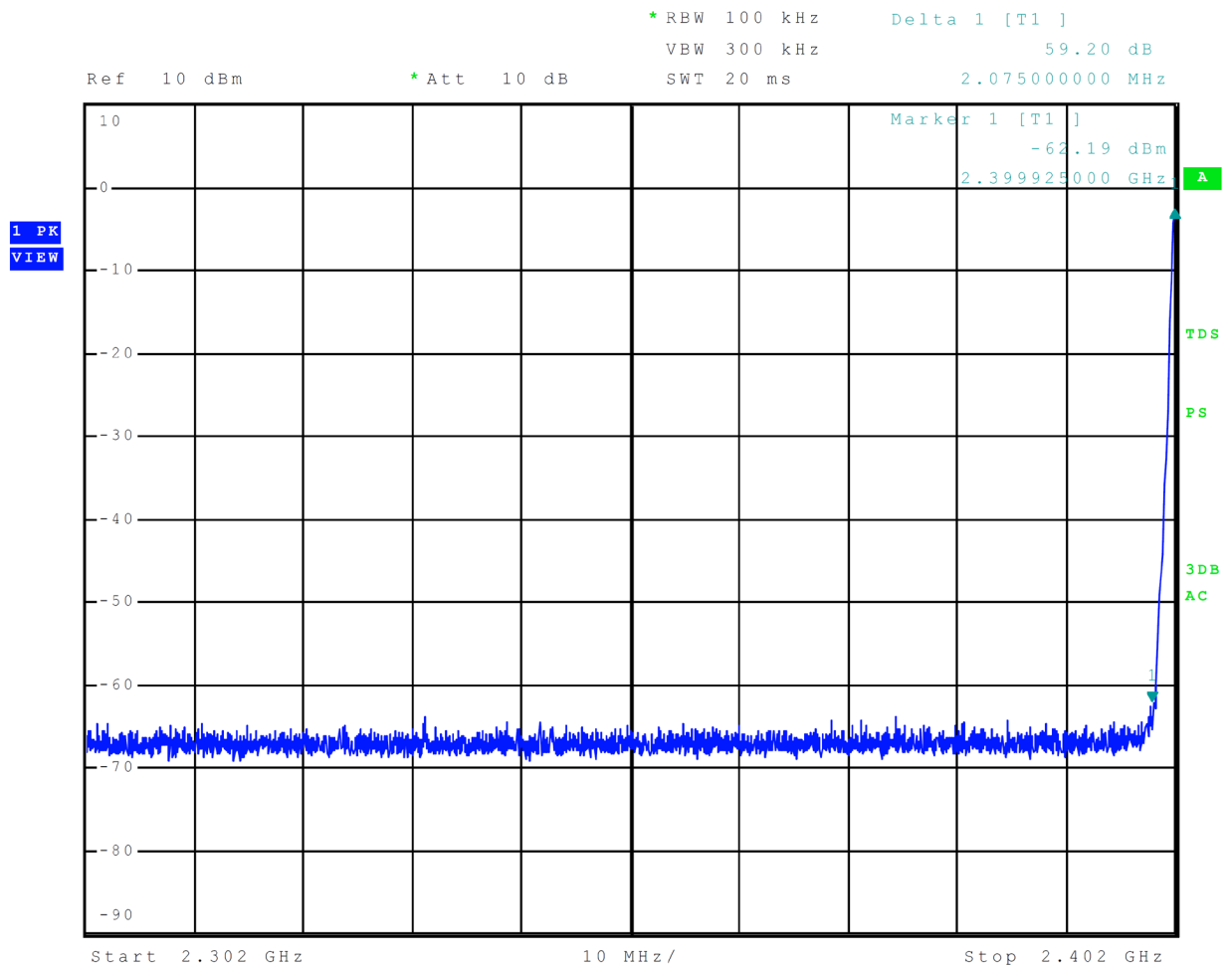

Figure 3 Plot of Transmitter Emissions High Band Edge Mode 1 ANT (GFSK)

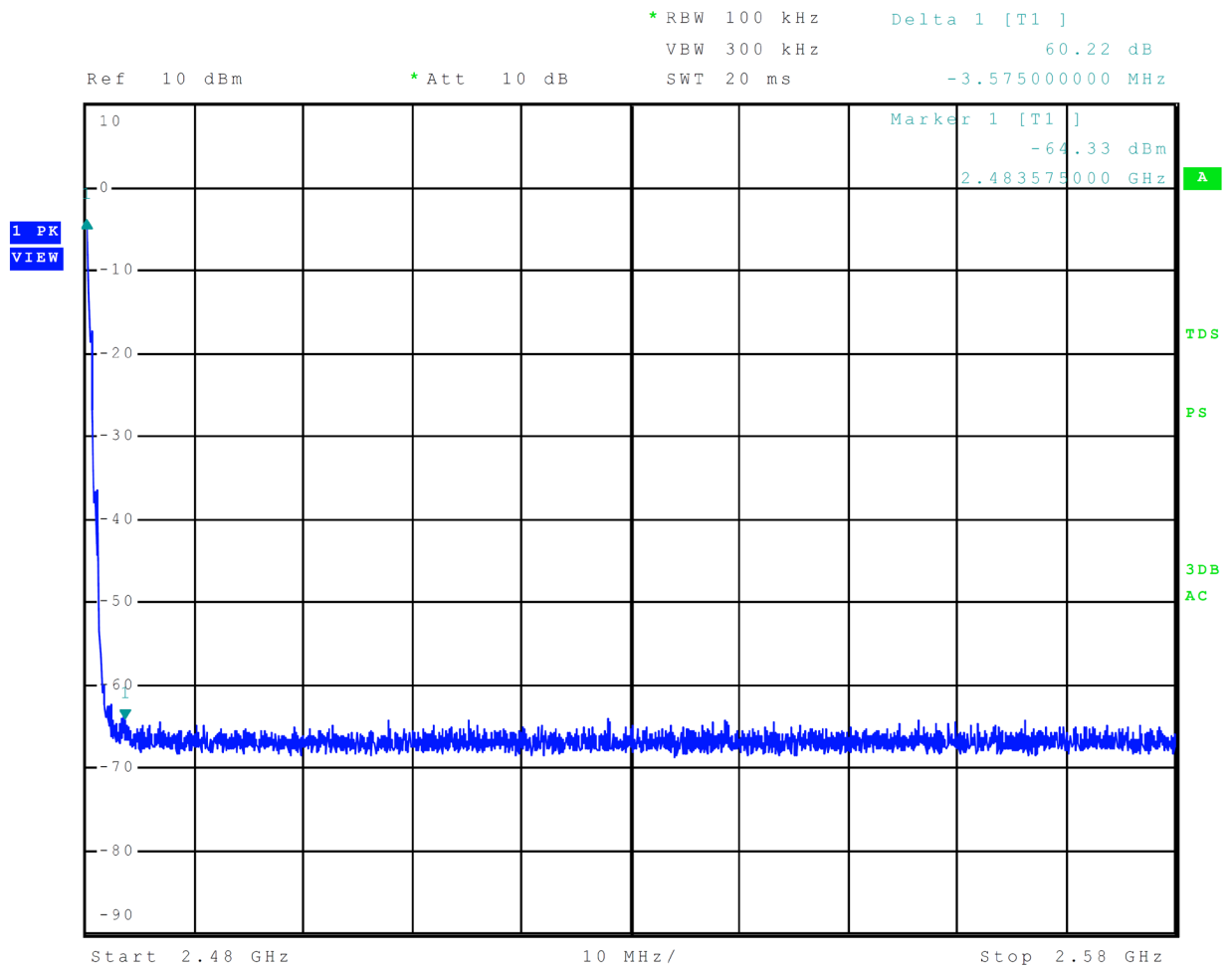
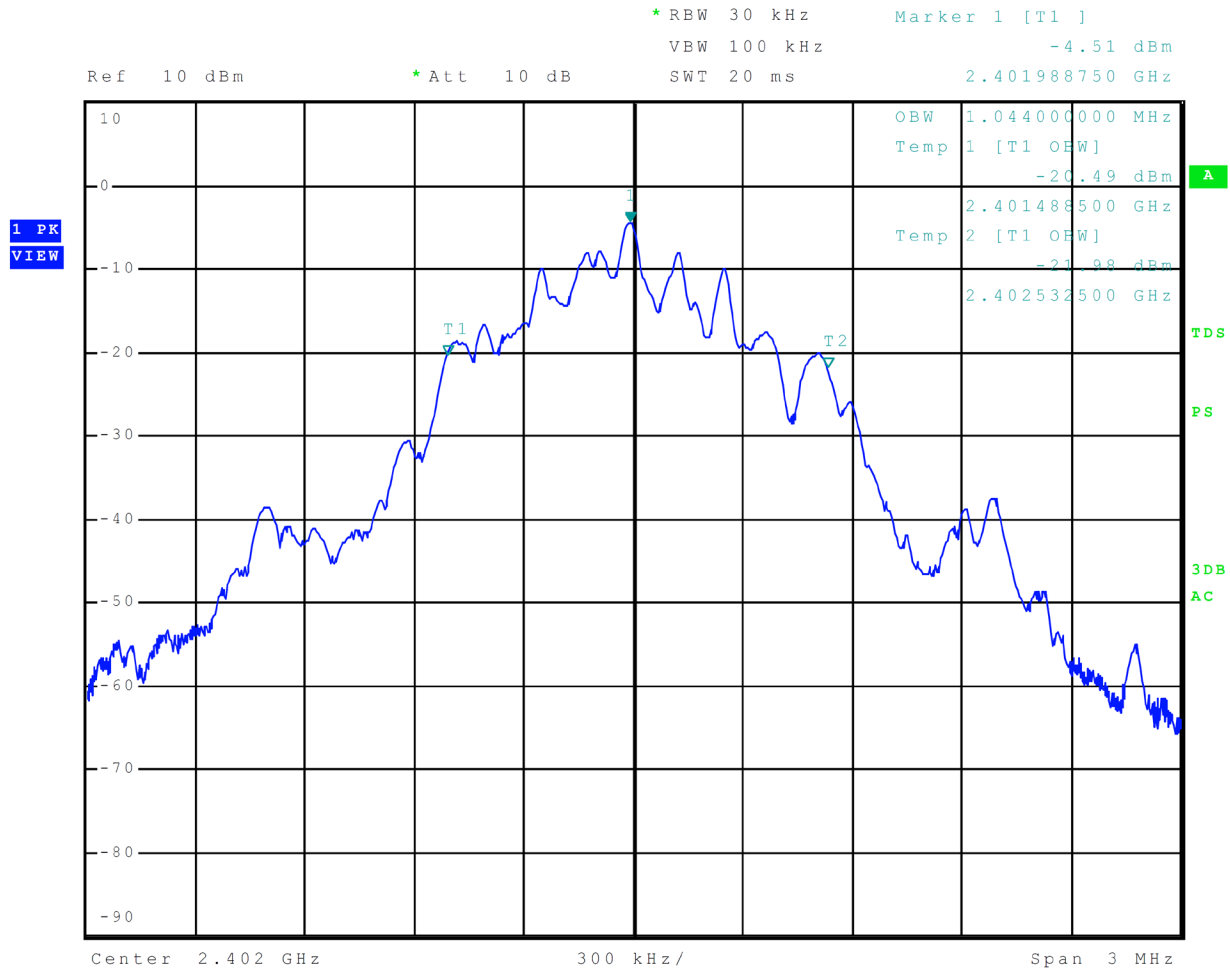

Figure 4 Plot of Transmitter 99% Occupied Bandwidth Mode 1 ANT (GFSK)



Transmitter Emissions Data

Table 3 Transmitter Radiated Emissions Mode 1 ANT (GFSK)

Frequency in MHz	Horizontal Peak (dBµV/m)	Horizontal Average (dBµV/m)	Vertical Peak (dBµV/m)	Vertical Average (dBµV/m)	Limit @ 3m (dBµV/m)	Horizontal Margin (dB)	Vertical Margin (dB)
2402.0	92.7	87.8	93.2	88.1	94.0	-6.2	-5.9
4804.0	49.3	36.3	49.8	36.3	54.0	-17.7	-17.7
7206.0	53.2	40.2	52.9	40.1	54.0	-13.8	-13.9
9608.0	56.2	43.5	56.2	43.5	54.0	-10.5	-10.5
12010.0	58.8	45.9	58.4	45.9	54.0	-8.1	-8.1
14412.0	60.0	47.4	60.8	47.4	54.0	-6.6	-6.6
16814.0	65.2	52.1	65.1	52.1	54.0	-1.9	-1.9
2457.0	93.1	88.5	91.3	86.3	94.0	-5.5	-7.7
4914.0	49.2	36.3	49.1	36.5	54.0	-17.7	-17.5
7371.0	53.2	40.0	53.3	40.4	54.0	-14.0	-13.6
9828.0	56.8	43.9	56.4	44.1	54.0	-10.1	-9.9
12285.0	60.1	47.3	60.2	47.5	54.0	-6.7	-6.5
14742.0	61.0	48.2	61.4	48.4	54.0	-5.8	-5.6
17199.0	63.3	50.6	63.0	50.6	54.0	-3.4	-3.4
2480.0	92.0	87.1	93.3	88.0	94.0	-6.9	-6.0
4960.0	49.5	36.4	49.5	36.4	54.0	-17.6	-17.6
7440.0	53.4	40.4	52.8	40.4	54.0	-13.6	-13.6
9920.0	56.9	43.7	56.2	43.6	54.0	-10.3	-10.4
12400.0	59.5	47.0	60.1	47.0	54.0	-7.0	-7.0
14880.0	60.8	48.1	61.0	48.1	54.0	-5.9	-5.9
17360.0	63.4	50.8	63.5	50.8	54.0	-3.2	-3.2

Other emissions present had amplitudes at least 20 dB below the limit. Peak and Quasi-Peak amplitude emissions are recorded for frequency range below 1000 MHz. Peak and Average amplitude emissions are recorded for frequency range above 1000 MHz.

Rogers Labs, Inc.
 4405 West 259th Terrace
 Louisburg, KS 66053
 Phone/Fax: (913) 837-3214
 Revision 1

Garmin International, Inc.
 HVIN: A04797, B04797
 Test: 230721A
 Test to: 47CFR 15C, RSS-Gen RSS-210
 File: A04797 DXX TstRpt 230721A

FCC ID: IPH-04797
 IC: 1792A-04797
 SN's: 3449473321, 3449472678
 Date: October 9, 2023
 Page 23 of 30

Summary of Results for Transmitter Radiated Emissions of Intentional Radiator

The EUT demonstrated compliance with the radiated emissions requirements of 47CFR Part 15.249, Industry Canada RSS-210 Issue 10, and RSS-GEN Issue 5 Intentional Radiator regulations. The EUT worst-case test sample configuration demonstrated minimum average margin of -5.5 dB below the average emission limit for the fundamental. The EUT worst-case configuration demonstrated minimum radiated harmonic emission margin of -1.9 dB below the limit. No other radiated emissions were found in the restricted bands less than 20 dB below limits than those recorded in this report. Other emissions were present with amplitudes at least 20 dB below the limits.

Annex

- Annex A Measurement Uncertainty Calculations
- Annex B Test Equipment
- Annex C Rogers Qualifications
- Annex D Laboratory Certificate of Accreditation

Annex A Measurement Uncertainty Calculations

The measurement uncertainty was calculated for all measurements listed in this test report according To CISPR 16–4. The results of measurement uncertainty calculations are recorded below. Component and process variability of production devices similar to those tested may result in additional deviations. The manufacturer has the sole responsibility of continued compliance.

Measurement	Expanded Measurement Uncertainty $U_{(lab)}$
3 Meter Horizontal 0.009-1000 MHz Measurements	4.16
3 Meter Vertical 0.009-1000 MHz Measurements	4.33
3 Meter Measurements 1-18 GHz	5.14
3 Meter Measurements 18-40 GHz	5.16
10 Meter Horizontal Measurements 0.009-1000 MHz	4.15
10 Meter Vertical Measurements 0.009-1000 MHz	4.32
AC Line Conducted	1.75
Antenna Port Conducted power	1.17
Frequency Stability	1.00E-11
Temperature	1.6°C
Humidity	3%

Annex B Test Equipment

<u>Equipment</u>	<u>Manufacturer</u>	<u>Model (SN)</u>	<u>Band</u>	<u>Cal Date(m/d/y)</u>	<u>Due</u>
<input type="checkbox"/> LISN	FCC	FCC-LISN-50-25-10(1PA) (160611)	.15-30MHz	3/28/2023	3/28/2024
<input type="checkbox"/> LISN: Fischer Custom Communications Model:		FCC-LISN-50-16-2-08		3/28/2023	3/28/2024
<input checked="" type="checkbox"/> Cable	Huber & Suhner Inc.	Sucoflex102ea(L10M)(303073)	9kHz-40 GHz	10/11/2022	10/11/2023
<input type="checkbox"/> Cable	Huber & Suhner Inc.	Sucoflex102ea(1.5M)(303069)	9kHz-40 GHz	10/11/2022	10/11/2023
<input checked="" type="checkbox"/> Cable	Huber & Suhner Inc.	Sucoflex102ea(1.5M)(303070)	9kHz-40 GHz	10/11/2022	10/11/2023
<input type="checkbox"/> Cable	Belden	RG-58 (L1-CAT3-11509)	9kHz-30 MHz	10/11/2022	10/11/2023
<input type="checkbox"/> Cable	Belden	RG-58 (L2-CAT3-11509)	9kHz-30 MHz	10/11/2022	10/11/2023
<input checked="" type="checkbox"/> Antenna	Com Power	AL-130 (121055)	.001-30 MHz	10/11/2022	10/11/2023
<input type="checkbox"/> Antenna:	EMCO	6509	.001-30 MHz	10/14/2020	10/11/2023
<input type="checkbox"/> Antenna	ARA	BCD-235-B (169)	20-350MHz	10/11/2022	10/11/2023
<input checked="" type="checkbox"/> Antenna	Sunol	JB-6 (A100709)	30-1000 MHz	10/11/2022	10/11/2023
<input type="checkbox"/> Antenna	ETS-Lindgren	3147 (40582)	200-1000MHz	10/11/2022	10/11/2024
<input checked="" type="checkbox"/> Antenna	ETS-Lindgren	3117 (200389)	1-18 GHz	3/28/2022	3/29/2024
<input type="checkbox"/> Antenna	Com Power	AH-118 (10110)	1-18 GHz	10/11/2022	10/11/2024
<input checked="" type="checkbox"/> Antenna	Com Power	AH-840 (101046)	18-40 GHz	3/27/2023	3/27/2025
<input checked="" type="checkbox"/> Analyzer	Rohde & Schwarz	ESU40 (100108)	20Hz-40GHz	6/26/2023	6/26/2024
<input checked="" type="checkbox"/> Analyzer	Rohde & Schwarz	ESW44 (101534)	20Hz-44GHz	1/25/2023	1/25/2024
<input type="checkbox"/> Analyzer	Rohde & Schwarz	FS-Z60, 90, 140, and 220	40GHz-220GHz	12/22/2017	12/22/2027
<input checked="" type="checkbox"/> Amplifier	Com-Power	PA-010 (171003)	100Hz-30MHz	10/11/2022	10/11/2023
<input checked="" type="checkbox"/> Amplifier	Com-Power	CPPA-102 (01254)	1-1000 MHz	10/11/2022	10/11/2023
<input checked="" type="checkbox"/> Amplifier	Com-Power	PAM-118A (551014)	0.5-18 GHz	10/11/2022	10/11/2023
<input checked="" type="checkbox"/> Amplifier	Com-Power	PAM-840A (461328)	18-40 GHz	10/11/2022	10/11/2023
<input type="checkbox"/> Pwr Sensor	Rohde & Schwarz	NRP33T	0.05-33 GHz	8/31/2022	8/31/2023
<input type="checkbox"/> Power Meter	Agilent	N1911A with N1921A	0.05-40 GHz	3/28/2023	3/28/2025
<input type="checkbox"/> Generator	Rohde & Schwarz	SMB100A6 (100150)	20Hz-6 GHz	3/28/2023	3/28/2024
<input type="checkbox"/> Generator	Rohde & Schwarz	SMBV100A6 (260771)	20Hz-6 GHz	3/28/2023	3/28/2024
<input type="checkbox"/> RF Filter	Micro-Tronics	BRC50722 (009).9G notch	30-18000 MHz	3/28/2023	3/28/2025
<input type="checkbox"/> RF Filter	Micro-Tronics	HPM50114 (017)1.5G HPF	30-18000 MHz	3/28/2023	3/28/2025
<input type="checkbox"/> RF Filter	Micro-Tronics	HPM50117 (063) 3G HPF	30-18000 MHz	3/28/2023	3/28/2025
<input type="checkbox"/> RF Filter	Micro-Tronics	HPM50105 (059) 6G HPF	30-18000 MHz	3/28/2023	3/28/2025
<input checked="" type="checkbox"/> RF Filter	Micro-Tronics	BRM50702 (172) 2G notch	30-18000 MHz	3/28/2023	3/28/2025
<input type="checkbox"/> RF Filter	Micro-Tronics	BRC50703 (G102) 5G notch	30-18000 MHz	3/28/2023	3/28/2025
<input type="checkbox"/> RF Filter	Micro-Tronics	BRC50705 (024) 5G notch	30-18000 MHz	3/28/2023	3/28/2025
<input checked="" type="checkbox"/> Attenuator	Mini-Circuits	VAT-3W2+ (1436)	30-6000 MHz	3/28/2023	3/28/2024
<input type="checkbox"/> Attenuator	Mini-Circuits	VAT-3W2+ (1445)	30-6000 MHz	3/28/2023	3/28/2024
<input type="checkbox"/> Attenuator	Mini-Circuits	VAT-3W2+ (1735)	30-6000 MHz	3/28/2023	3/28/2024
<input type="checkbox"/> Attenuator	Mini-Circuits	VAT-6W2+ (1438)	30-6000 MHz	3/28/2023	3/28/2024
<input type="checkbox"/> Attenuator	Mini-Circuits	VAT-6W2+ (1736)	30-6000 MHz	3/28/2023	3/28/2024
<input checked="" type="checkbox"/> Weather station	Davis	6312 (A81120N075)		10/11/2022	10/11/2023

Rogers Labs, Inc.
 4405 West 259th Terrace
 Louisburg, KS 66053
 Phone/Fax: (913) 837-3214
 Revision 1

Garmin International, Inc.
 HVIN: A04797, B04797
 Test: 230721A
 Test to: 47CFR 15C, RSS-Gen RSS-210
 File: A04797 DXX TstRpt 230721A

FCC ID: IPH-04797
 IC: 1792A-04797
 SN's: 3449473321, 3449472678
 Date: October 9, 2023
 Page 27 of 30

List of Test Equipment

Calibration Date (m/d/y) Due

<input type="checkbox"/>	Frequency Counter: Leader LDC-825 (8060153	3/28/2023	3/28/2025
<input type="checkbox"/>	ISN: Com-Power Model ISN T-8	3/28/2023	3/28/2024
<input type="checkbox"/>	LISN Compliance Design FCC-LISN-2.Mod.cd,(126) .15-30MHz	10/11/2022	10/11/2024
<input type="checkbox"/>	LISN: Com-Power Model LI-220A	3/29/2023	3/29/2025
<input type="checkbox"/>	LISN: Com-Power Model LI-550C	10/11/2022	10/11/2024
<input type="checkbox"/>	Cable Huber & Suhner Inc. Sucoflex102ea(1.5M)(303072) 9kHz-40 GHz	10/11/2022	10/11/2023
<input type="checkbox"/>	Cable Huber & Suhner Inc. Sucoflex102ea(L1M)(281183) 9kHz-40 GHz	10/11/2022	10/11/2023
<input type="checkbox"/>	Cable Huber & Suhner Inc. Sucoflex102ea(L4M)(281184) 9kHz-40 GHz	10/11/2022	10/11/2023
<input type="checkbox"/>	Cable Huber & Suhner Inc. Sucoflex102ea(L10M)(317546)9kHz-40 GHz	10/11/2022	10/11/2023
<input type="checkbox"/>	Cable Time Microwave 4M-750HF290-750 (4M) 9kHz-24 GHz	10/11/2022	10/11/2023
<input type="checkbox"/>	RF Filter Micro-Tronics BRC17663 (001) 9.3-9.5 notch 30-1800 MHz	3/28/2023	3/28/2025
<input type="checkbox"/>	RF Filter Micro-Tronics BRC19565 (001) 9.2-9.6 notch 30-1800 MHz	3/28/2023	3/28/2025
<input type="checkbox"/>	Analyzer HP 8562A (3051A05950) 9kHz-125GHz	3/28/2023	3/28/2024
<input type="checkbox"/>	Wave Form Generator Keysight 33512B (MY57400128)	3/29/2022	3/29/2024
<input type="checkbox"/>	Antenna: Solar 9229-1 & 9230-1	2/18/2023	2/18/2024
<input type="checkbox"/>	CDN: Com-Power Model CDN325E	10/11/2022	10/11/2024
<input type="checkbox"/>	Oscilloscope Scope: Tektronix MDO 4104	2/18/2023	2/18/2024
<input type="checkbox"/>	EMC Transient Generator HVT TR 3000	2/18/2023	2/18/2024
<input type="checkbox"/>	AC Power Source (Ametech, California Instruments)	2/18/2023	2/18/2024
<input type="checkbox"/>	Field Intensity Meter: EFM-018	2/18/2023	2/18/2024
<input type="checkbox"/>	ESD Simulator: MZ-15	2/18/2023	2/18/2024
<input type="checkbox"/>	Injection Clamp Luthi Model EM101	not required	
<input type="checkbox"/>	R.F. Power Amp ACS 230-50W	not required	
<input type="checkbox"/>	R.F. Power Amp EIN Model: A301	not required	
<input type="checkbox"/>	R.F. Power Amp A.R. Model: 10W 1010M7	not required	
<input type="checkbox"/>	R.F. Power Amp A.R. Model: 50U1000	not required	
<input type="checkbox"/>	Temperature Chamber	not required	
<input checked="" type="checkbox"/>	Shielded Room	not required	

Annex C Rogers Qualifications

Scot D. Rogers, Engineer

Rogers Labs, Inc.

Mr. Rogers has approximately 37 years' experience in the field of electronics. Working experience includes six years working in the automated controls industry and 6 years working with the design, development and testing of radio communications and electronic equipment.

Positions Held:

Systems Engineer: A/C Controls Mfg. Co., Inc.

Electrical Engineer: Rogers Consulting Labs, Inc.

Electrical Engineer: Rogers Labs, Inc. Current

Educational Background:

Bachelor of Science Degree in Electrical Engineering from Kansas State University

Bachelor of Science Degree in Business Administration Kansas State University

Several Specialized Training courses and seminars pertaining to Microprocessors and Software programming

Annex D Laboratory Certificate of Accreditation

United States Department of Commerce
National Institute of Standards and Technology



Certificate of Accreditation to ISO/IEC 17025:2017

NVLAP LAB CODE: 200087-0

Rogers Labs, Inc.
Louisburg, KS

*is accredited by the National Voluntary Laboratory Accreditation Program for specific services,
listed on the Scope of Accreditation, for:*

Electromagnetic Compatibility & Telecommunications

*This laboratory is accredited in accordance with the recognized International Standard ISO/IEC 17025:2017.
This accreditation demonstrates technical competence for a defined scope and the operation of a laboratory quality
management system (refer to joint ISO-ILAC-IAF Communique dated January 2009).*

2023-03-16 through 2024-03-31
Effective Dates

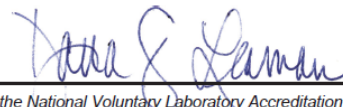

For the National Voluntary Laboratory Accreditation Program

Rogers Labs, Inc.
4405 West 259th Terrace
Louisburg, KS 66053
Phone/Fax: (913) 837-3214
Revision 1

Garmin International, Inc.
HVIN: A04797, B04797
Test: 230721A
Test to: 47CFR 15C, RSS-Gen RSS-210
File: A04797 DXX TstRpt 230721A

FCC ID: IPH-04797
IC: 1792A-04797
SN's: 3449473321, 3449472678
Date: October 9, 2023
Page 30 of 30