

# FCC Test Report

**FCC ID** : IPH-04780  
**Equipment** : IVI Unit  
**Model No.** : TGWW  
**Brand Name** : GARMIN  
**Applicant** : Garmin International, Inc.  
**Address** : 1200 E. 151st Street Olathe, KS 66062 United States  
**Standard** : 47 CFR FCC Part 15.247  
**Received Date** : Dec. 15, 2023  
**Tested Date** : Dec. 15 ~ Dec. 29, 2023

We, International Certification Corporation, would like to declare that the tested sample has been evaluated and in compliance with the requirement of the above standards. The test results contained in this report refer exclusively to the product. It shall not be reproduced except in full without the written approval of our laboratory.

Reviewed by:

Approved by:

  
\_\_\_\_\_  
Along Chen / Assistant Manager

  
\_\_\_\_\_  
Gary Chang / Manager

## Table of Contents

<b>1</b>	<b>GENERAL DESCRIPTION .....</b>	<b>5</b>
1.1	Information.....	5
1.2	Local Support Equipment List .....	8
1.3	Test Setup Chart .....	9
1.4	The Equipment List .....	10
1.5	Test Standards .....	11
1.6	Reference Guidance .....	11
1.7	Deviation from Test Standard and Measurement Procedure.....	11
1.8	Measurement Uncertainty .....	11
<b>2</b>	<b>TEST CONFIGURATION.....</b>	<b>12</b>
2.1	Testing Facility .....	12
2.2	The Worst Test Modes and Channel Details .....	13
<b>3</b>	<b>TRANSMITTER TEST RESULTS .....</b>	<b>14</b>
3.1	Unwanted Emissions into Restricted Frequency Bands .....	14
3.2	Unwanted Emissions into Non-Restricted Frequency Bands .....	17
3.3	Conducted Output Power .....	18
3.4	Number of Hopping Frequency .....	19
3.5	20dB and Occupied Bandwidth.....	20
3.6	Channel Separation.....	21
3.7	Number of Dwell Time.....	22
<b>4</b>	<b>TEST LABORATORY INFORMATION .....</b>	<b>23</b>

**Appendix A. Unwanted Emissions into Restricted Frequency Bands**

**Appendix B. Unwanted Emissions into Non-Restricted Frequency Bands**

**Appendix C. Conducted Output Power**

**Appendix D. Number of Hopping Frequency**

**Appendix E. 20dB and Occupied Bandwidth**

**Appendix F. Channel Separation**

**Appendix G. Number of Dwell Time**

---

## Release Record

Report No.	Version	Description	Issued Date
FR3D1301-1AD	Rev. 01	Initial issue	Jan. 25, 2024

## Summary of Test Results

FCC Rules	Test Items	Measured	Result
15.207	AC Power Line Conducted Emission	Note <sup>1</sup>	N/A
15.247(d) 15.209	Unwanted Emissions	[dBuV/m at 3m]: 2.4835GHz 50.06 (Margin -3.94dB) - AV	Pass
15.247(d)	Band Edge	Meet the requirement of limit	Pass
15.247(b)(1)	Conducted Output Power	Power [dBm]: 4.34	Pass
15.247(a)(1)(iii)	Number of Hopping Channels	Meet the requirement of limit	Pass
15.247(a)(1)	Hopping Channel Separation	Meet the requirement of limit	Pass
15.247(a)(1)(iii)	Dwell Time	Meet the requirement of limit	Pass
15.203	Antenna Requirement	Meet the requirement of limit	Pass

N/A means Not Applicable.  
Note<sup>1</sup>: The EUT consumes DC power from battery, so the test is not required.

### Declaration of Conformity:

The test results with all measurement uncertainty excluded are presented in accordance with the regulation limits or requirements declared by manufacturers.

### Comments and Explanations:

The declared of product specification for EUT presented in the report are provided by the manufacturer, and the manufacturer takes all the responsibilities for the accuracy of product specification.

# 1 General Description

## 1.1 Information

### 1.1.1 Specification of the Equipment under Test (EUT)

RF General Information				
Frequency Range (MHz)	Bluetooth Mode	Ch. Frequency (MHz)	Channel Number	Data Rate
2400-2483.5	BR	2402-2480	0-78 [79]	1 Mbps
2400-2483.5	EDR	2402-2480	0-78 [79]	2 Mbps
2400-2483.5	EDR	2402-2480	0-78 [79]	3 Mbps

Note 1: RF output power specifies that Maximum Peak Conducted Output Power.  
 Note 2: Bluetooth BR uses a GFSK.  
 Note 3: Bluetooth EDR uses a combination of  $\pi/4$ -DQPSK and 8DPSK.

### 1.1.2 Antenna Details

Ant. No.	Brand	Model	Type	Connector	Gain (dBi)
1	HARADA	39213	RHCP	R-SMA	3.6

### 1.1.3 Power Supply Type of Equipment under Test (EUT)

<b>Power Supply Type</b>	12Vdc
--------------------------	-------

### 1.1.4 Accessories

N/A

### 1.1.5 Channel List

Frequency band (MHz)				2400~2483.5			
Channel	Frequency (MHz)	Channel	Frequency (MHz)	Channel	Frequency (MHz)	Channel	Frequency (MHz)
0	2402	20	2422	40	2442	60	2462
1	2403	21	2423	41	2443	61	2463
2	2404	22	2424	42	2444	62	2464
3	2405	23	2425	43	2445	63	2465
4	2406	24	2426	44	2446	64	2466
5	2407	25	2427	45	2447	65	2467
6	2408	26	2428	46	2448	66	2468
7	2409	27	2429	47	2449	67	2469
8	2410	28	2430	48	2450	68	2470
9	2411	29	2431	49	2451	69	2471
10	2412	30	2432	50	2452	70	2472
11	2413	31	2433	51	2453	71	2473
12	2414	32	2434	52	2454	72	2474
13	2415	33	2435	53	2455	73	2475
14	2416	34	2436	54	2456	74	2476
15	2417	35	2437	55	2457	75	2477
16	2418	36	2438	56	2458	76	2478
17	2419	37	2439	57	2459	77	2479
18	2420	38	2440	58	2460	78	2480
19	2421	39	2441	59	2461	---	---

### 1.1.6 Test Tool and Duty Cycle

Test Tool	Bluetooth Simulator, Brand: R&S, Model: CMW270	
Modulation Mode	Duty Cycle Of Test Signal (%)	Duty Factor (dB)
DH5	79.54%	0.99
2DH5	80.46%	0.94
3DH5	79.54%	0.99

### 1.1.7 Power Index of Test Tool

Modulation Mode	Test Frequency (MHz)		
	2402	2441	2480
GFSK/1Mbps	Default	Default	Default
$\pi/4$ -DQPSK /2Mbps	Default	Default	Default
8DPSK/3Mbps	Default	Default	Default

## 1.2 Local Support Equipment List

Support Equipment List					
No.	Equipment	Brand	Model	FCC ID	Remarks
1	Card reader	TCSTAR	TYC-MF007	---	---
2	12V DC Battery	Hotai Motor Co, Ltd.	S55B24LS	---	---
3	Cell phone	SAMSUNG	A8	---	---
4	Speaker	GARMIN	TG SPK	---	Provided by applicant.
5	Fixture Board	GARMIN	TG_FB	---	Provided by applicant.
6	Laptop	DELL	Latitude E5470	DoC	---

Note: The fixture board and laptop are disconnected from EUT and removed from test table when EUT is set to transmit continuously.



### 1.3 Test Setup Chart

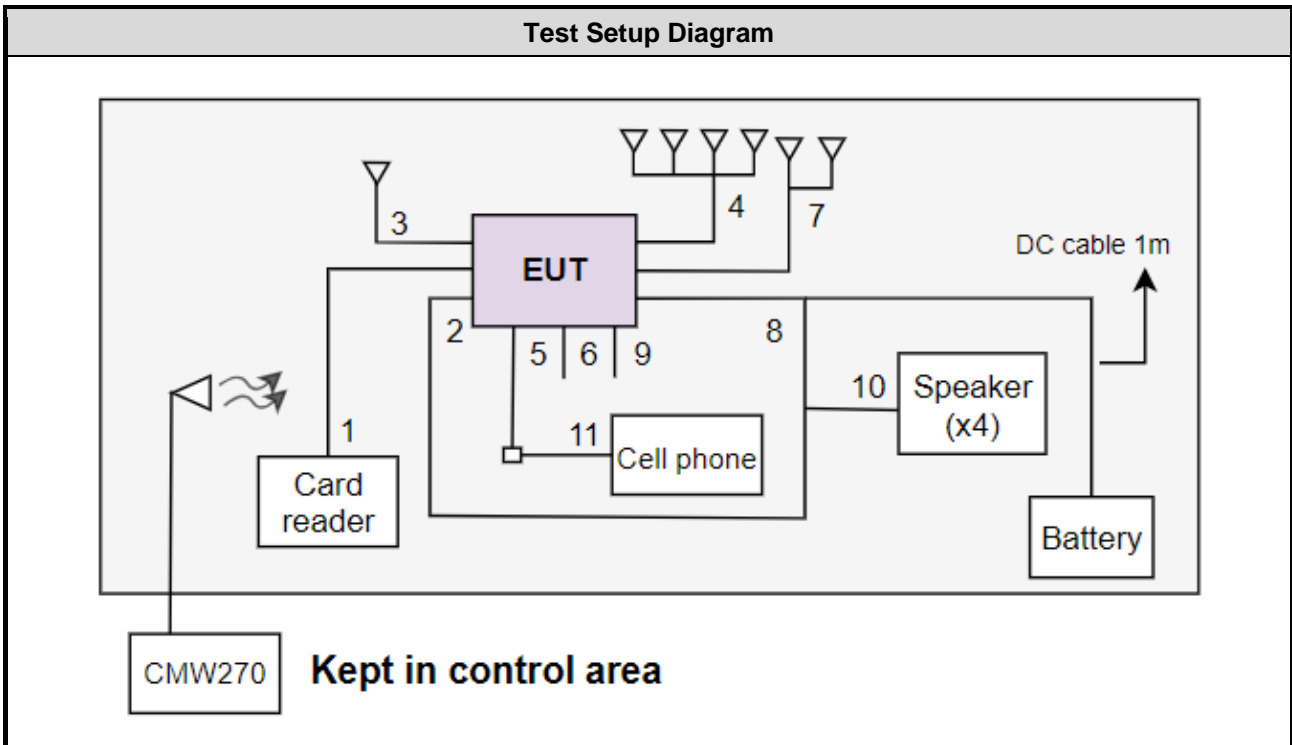

No.	Signal cable / Length (m)
1	USB, 1m shielded. (Brand: GARMIN / Model: TG_USB2)
2	IVI cable, 0.81m shielded. (Brand: GARMIN / Model: TG_IVI)
3	Antenna cable, 0.34m shielded. (Brand: GARMIN / Model: TG_BT2)
4	Antenna cable, 2.76m shielded. (Brand: GARMIN / Model: TG_1to4)
5	USB, 0.36m shielded. (Brand: GARMIN / Model: TG_USB1)
6	LVDS cable, 0.56m shielded. (Brand: GARMIN / Model: TG_LVDS)
7	Antenna cable, 2.85m shielded. (Brand: GARMIN / Model: TG_1to2)
8	EAU cable, 0.81m shielded. (Brand: GARMIN / Model: TG_EAU)
9	SXM cable, 0.3m shielded. (Brand: GARMIN / Model: TG_SXM)
10	Audio cable, 0.42m shielded. (Brand: GARMIN / Model: TG_SPK)
11	USB, 0.55m shielded. (Brand: GARMIN / Model: 320-01643-0A)

## 1.4 The Equipment List

Test Item	Radiated Emission				
Test Site	966 chamber1 / (03CH01-WS)				
Tested Date	Dec. 15 ~ Dec. 25, 2023				
Instrument	Brand	Model No.	Serial No.	Calibration Date	Calibration Until
Receiver	R&S	ESR3	101657	Mar. 03, 2023	Mar. 02, 2024
Spectrum Analyzer	R&S	FSV40	101498	Nov. 23, 2023	Nov. 22, 2024
Loop Antenna	R&S	HFH2-Z2	100330	Oct. 31, 2023	Oct. 30, 2024
Bilog Antenna	SCHWARZBECK	VULB9168	VULB9168-522	Jul. 31, 2023	Jul. 30, 2024
Horn Antenna 1G-18G	SCHWARZBECK	BBHA 9120 D	BBHA 9120 D 1096	Nov. 27, 2023	Nov. 26, 2024
Horn Antenna 18G-40G	SCHWARZBECK	BBHA 9170	BBHA 9170517	Oct. 30, 2023	Oct. 29, 2024
Preamplifier	EMC	EMC02325	980225	Jun. 28, 2023	Jun. 27, 2024
Preamplifier	EMC	EMC118A45SE	980898	Jul. 14, 2023	Jul. 13, 2024
Preamplifier	EMC	EMC184045SE	980903	Jul. 17, 2023	Jul. 16, 2024
Loop Antenna Cable	KOAX KABEL	101354-BW	101354-BW	Oct. 03, 2023	Oct. 02, 2024
LF cable 3M	Woken	CFD400NL-LW	CFD400NL-001	Oct. 03, 2023	Oct. 02, 2024
LF cable 11M	EMC	EMCCFD400-NW-N W-11000	200801	Oct. 03, 2023	Oct. 02, 2024
LF cable 1M	EMC	EMCCFD400-NM-N M-1000	160502	Oct. 03, 2023	Oct. 02, 2024
RF Cable	EMC	EMC104-35M-35M- 8000	210920	Oct. 03, 2023	Oct. 02, 2024
RF Cable	EMC	EMC104-35M-35M- 3000	210922	Oct. 03, 2023	Oct. 02, 2024
Attenuator	Pasternack	PE7005-10	10-1	Oct. 05, 2023	Oct. 04, 2024
HIGHPASS FILTER 3.1-18G	WHK	WHK3.1/18G-10SS	39	Oct. 05, 2023	Oct. 04, 2024
Measurement Software	Sporton	SENSE-15247_FS	V5.10.8	NA	NA
Measurement Software	Sporton	SENSE-EMI	V5.10.8	NA	NA
Wireless connectivity tester	R&S	CMW270	100856	Nov. 14, 2023	Nov. 13, 2024

Note: Calibration Interval of instruments listed above is one year.

<b>Test Item</b>	RF Conducted				
<b>Test Site</b>	(TH01-WS)				
<b>Tested Date</b>	Dec. 29, 2023				
<b>Instrument</b>	<b>Brand</b>	<b>Model No.</b>	<b>Serial No.</b>	<b>Calibration Date</b>	<b>Calibration Until</b>
Spectrum Analyzer	R&S	FSV40	101910	Apr. 14, 2023	Apr. 13, 2024
Power Meter	Anritsu	ML2495A	1241002	Nov. 21, 2023	Nov. 20, 2024
Power Sensor	Anritsu	MA2411B	1207366	Nov. 21, 2023	Nov. 20, 2024
Attenuator	Pasternack	PE7005-10	10-2	Oct. 05, 2023	Oct. 04, 2024
Measurement Software	Sporton	SENSE-15247_FS	V5.10.8	NA	NA
Wireless connectivity tester	R&S	CMW270	100856	Nov. 14, 2023	Nov. 13, 2024
Note: Calibration Interval of instruments listed above is one year.					

## 1.5 Test Standards

47 CFR FCC Part 15.247  
ANSI C63.10-2013

## 1.6 Reference Guidance

FCC KDB 558074 D01 15.247 Meas Guidance v05r02

## 1.7 Deviation from Test Standard and Measurement Procedure

None

## 1.8 Measurement Uncertainty

The measurement uncertainties given below are based on a 95% confidence level (based on a coverage factor (k=2)).

Measurement Uncertainty	
Parameters	Uncertainty
Bandwidth	±34.130 Hz
Conducted power	±0.808 dB
Power density	±0.583 dB
Conducted emission	±2.715 dB
AC conducted emission	±2.92 dB
Radiated emission ≤ 1GHz	±3.41 dB
Radiated emission > 1GHz	±4.59 dB
Time	±0.1%

---

## 2 Test Configuration

### 2.1 Testing Facility

<b>Test Laboratory</b>	International Certification Corporation
<b>Test Site</b>	03CH01-WS, TH01-WS
<b>Address of Test Site</b>	No.3-1, Lane 6, Wen San 3rd St., Kwei Shan Dist., Tao Yuan City 33381, Taiwan (R.O.C.)

- FCC Designation No.: TW2732
- FCC site registration No.: 181692
- ISED#: 10807A
- CAB identifier: TW2732

## 2.2 The Worst Test Modes and Channel Details

Test item	Modulation Mode	Test Frequency (MHz)	Data Rate (Mbps)
Radiated Emissions ≤ 1GHz	8DPSK	2441	3Mbps
Radiated Emissions > 1GHz	GFSK 8DPSK	2402, 2441, 2480 2402, 2441, 2480	1Mbps 3Mbps
Conducted Output Power	GFSK π/4 DQPSK 8DPSK	2402, 2441, 2480 2402, 2441, 2480 2402, 2441, 2480	1Mbps 2Mbps 3Mbps
Number of Hopping Channels	GFSK π/4 DQPSK 8DPSK	2402~2480 2402~2480 2402~2480	1Mbps 2Mbps 3Mbps
Hopping Channel Separation 20dB and Occupied bandwidth	GFSK π/4 DQPSK 8DPSK	2402, 2441, 2480 2402, 2441, 2480 2402, 2441, 2480	1Mbps 2Mbps 3Mbps
Dwell Time	GFSK π/4 DQPSK 8DPSK	2402 2402 2402	1Mbps 2Mbps 3Mbps
<b>NOTE:</b>			
1. The EUT was pretested with 3 orientations placed on the table for the radiated emission measurement – X, Y, and Z-plane. The <b>Z-plane</b> results were found as the worst case and were shown in this report.			

### 3 Transmitter Test Results

#### 3.1 Unwanted Emissions into Restricted Frequency Bands

##### 3.1.1 Limit of Unwanted Emissions into Restricted Frequency Bands

Restricted Band Emissions Limit			
Frequency Range (MHz)	Field Strength (uV/m)	Field Strength (dBuV/m)	Measure Distance (m)
0.009~0.490	2400/F(kHz)	48.5 - 13.8	300
0.490~1.705	24000/F(kHz)	33.8 - 23	30
1.705~30.0	30	29	30
30~88	100	40	3
88~216	150	43.5	3
216~960	200	46	3
Above 960	500	54	3

**Note 1:**  
Qusai-Peak value is measured for frequency below 1GHz except for 9–90 kHz, 110–490 kHz frequency band. Peak and average value are measured for frequency above 1GHz. The limit on average radio frequency emission is as above table. The limit on peak radio frequency emissions is 20 dB above the maximum permitted average emission limit

**Note 2:**  
Measurements may be performed at a distance other than what is specified provided. When performing measurements at a distance other than that specified, the results shall be extrapolated to the specified distance using an extrapolation factor as below, Frequency at or above 30 MHz: 20 dB/decade Frequency below 30 MHz: 40 dB/decade.

### 3.1.2 Test Procedures

1. Measurement is made at a semi-anechoic chamber that incorporates a turntable allowing a EUT rotation of 360°. A continuously-rotating, remotely-controlled turntable is installed at the test site to support the EUT and facilitate determination of the direction of maximum radiation for each EUT emission frequency. The EUT is placed at test table. For emissions testing at or below 1 GHz, the table height is 80 cm above the reference ground plane. For emission measurements above 1 GHz, the table height is 1.5 m
2. Measurement is made with the antenna positioned in both the horizontal and vertical planes of polarization. The measurement antenna is varied in height (1m ~ 4m) above the reference ground plane to obtain the maximum signal strength. Distance between EUT and antenna is 3 m.
3. This investigation is performed with the EUT rotated 360°, the antenna height scanned between 1 m and 4 m, and the antenna rotated to repeat the measurements for both the horizontal and vertical antenna polarizations.

Note:

1. 120kHz measurement bandwidth of test receiver and Quasi-peak detector is for radiated emission below 1GHz.
2. Radiated emission above 1GHz / Peak value  
RBW=1MHz, VBW=3MHz and Peak detector  
Radiated emission above 1GHz / Average value for harmonics  
The average value is: Average = Peak value + 20log(Duty cycle) Where the duty factor is calculated from following formula for DH5 packet type which has worst duty factor:
3.
$$20\log(\text{Duty cycle}) = 20\log \frac{1\text{s} / 1600 * 5}{100\text{ ms}} = -30.1\text{dB}$$
4. Radiated emission above 1GHz / Average value for other emissions  
RBW=1MHz, VBW=1/T and Peak detector

### 3.1.3 Test Setup

#### Radiated Emissions below 1 GHz

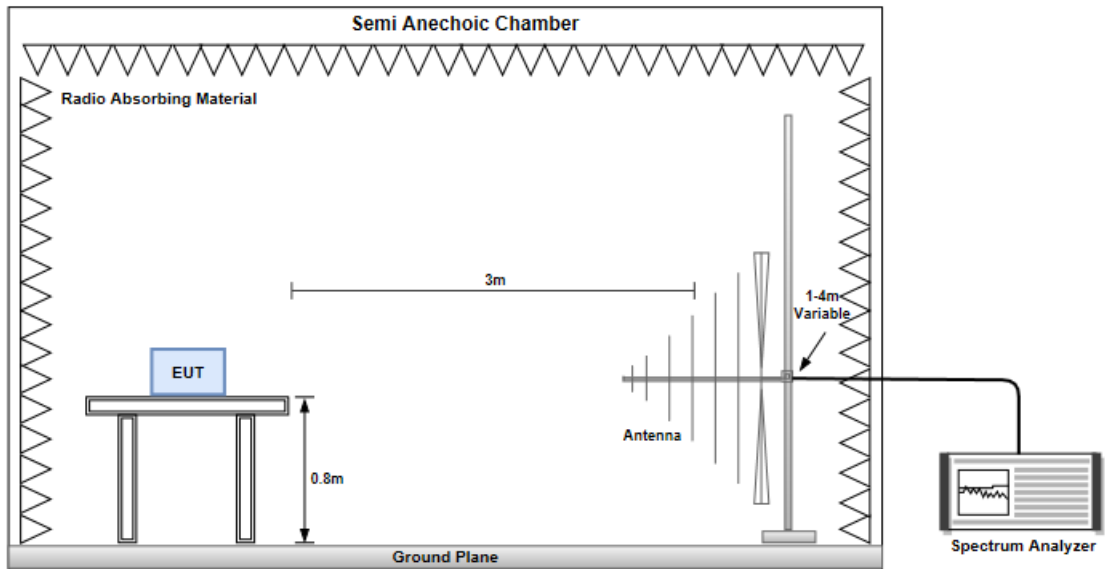

#### Radiated Emissions above 1 GHz

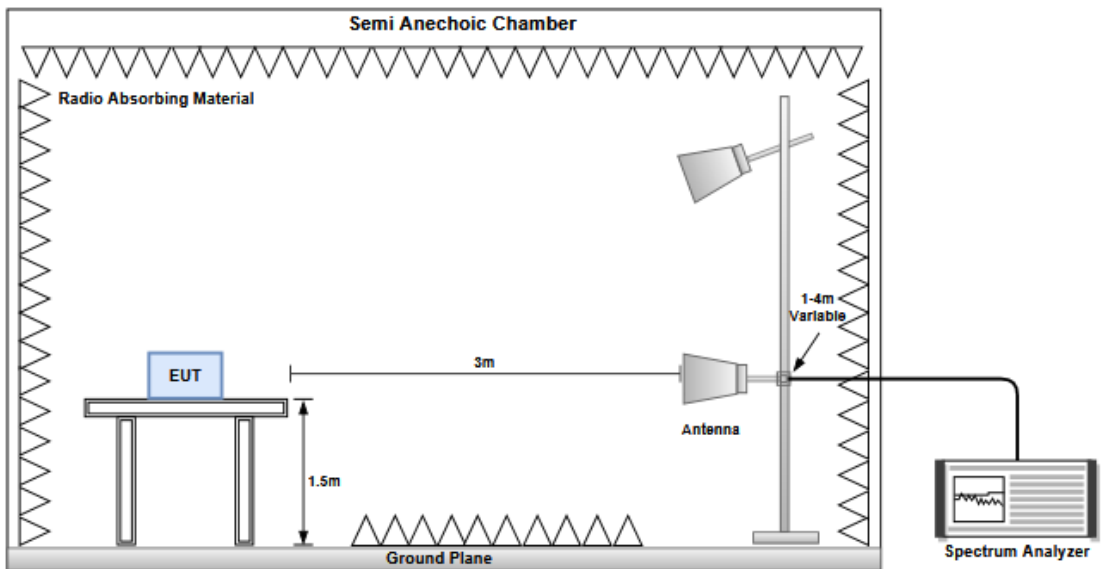

### 3.1.4 Test Results

Refer to Appendix A.



## 3.2 Unwanted Emissions into Non-Restricted Frequency Bands

### 3.2.1 Limit of Unwanted Emissions into Non-Restricted Frequency Bands

Peak power in any 100 kHz bandwidth outside of the authorized frequency band shall be attenuated by at least 20 dB relative to the maximum in-band peak PSD level in 100 kHz.

### 3.2.2 Test Procedures

#### Reference level measurement

1. Set RBW=100kHz, VBW = 300kHz , Detector = Peak, Sweep time = Auto
2. Trace = max hold , Allow Trace to fully stabilize
3. Use the peak marker function to determine the maximum PSD level

#### Emission level measurement

1. Set RBW=100kHz, VBW = 300kHz , Detector = Peak, Sweep time = Auto
2. Trace = max hold , Allow Trace to fully stabilize
3. Scan Frequency range is up to 25GHz
4. Use the peak marker function to determine the maximum amplitude level

### 3.2.3 Test Setup

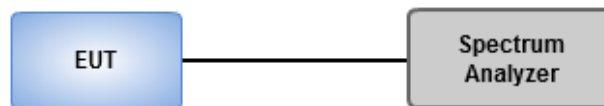

### 3.2.4 Test Results

<b>Ambient Condition</b>	22°C / 63%	<b>Tested By</b>	Roger Lu
--------------------------	------------	------------------	----------

Refer to Appendix B.

### 3.3 Conducted Output Power

#### 3.3.1 Limit of Conducted Output Power

- 1 Watt  
For frequency hopping systems operating in the 2400–2483.5 MHz band employing at least 75 non overlapping hopping channels, and all frequency hopping systems in the 5725–5850 MHz band.
- 0.125 Watt  
For all other frequency hopping systems in the 2400–2483.5 MHz band.
- 0.125 Watt  
For Frequency hopping systems operating in the 2400–2483.5 MHz band have hopping channel carrier frequencies that are separated by two-thirds of the 20 dB bandwidth of the hopping channel.

#### 3.3.2 Test Procedures

1. A wideband power meter is used for power measurement. Bandwidth of power sensor and meter is 50MHz
2. If duty cycle of test signal is not 100 %, trigger and gating function of power meter will be enabled to capture transmission burst for measuring output power

#### 3.3.3 Test Setup

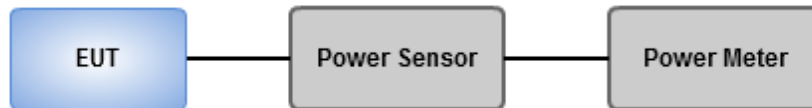

#### 3.3.4 Test Results

<b>Ambient Condition</b>	22°C / 63%	<b>Tested By</b>	Roger Lu
--------------------------	------------	------------------	----------

Refer to Appendix C.

### 3.4 Number of Hopping Frequency

#### 3.4.1 Limit of Number of Hopping Frequency

Frequency hopping systems in the 2400–2483.5 MHz band shall use at least 15 channels.

#### 3.4.2 Test Procedures

1. Set RBW = 100kHz, VBW = 300kHz, Sweep time = Auto, Detector = Peak Trace max hold.
2. Allow trace to stabilize.

#### 3.4.3 Test Setup

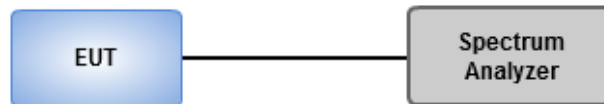

#### 3.4.4 Test Results

<b>Ambient Condition</b>	22°C / 63%	<b>Tested By</b>	Roger Lu
--------------------------	------------	------------------	----------

Refer to Appendix D.

## 3.5 20dB and Occupied Bandwidth

### 3.5.1 Test Procedures

#### 20dB Bandwidth

1. Set RBW=20kHz, VBW=100kHz, Sweep time = Auto, Detector=Peak , Trace max hold
2. Allow trace to stabilize
3. Measure the maximum width of the emission that is constrained by the frequencies associated with the two outermost amplitude points (upper and lower) that are attenuated by 20 dB relative to the maximum level measured in the fundamental emission.

#### Occupied Bandwidth

1. Set RBW=20kHz, VBW=100kHz, Sweep time = Auto, Detector=Sample , Trace max hold
2. Allow trace to stabilize
3. Use Occupied bandwidth function of spectrum analyzer to measuring 99% occupied bandwidth

### 3.5.2 Test Setup

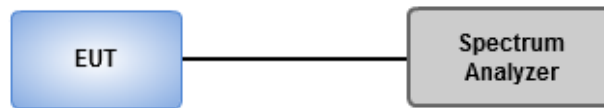

### 3.5.3 Test Results

<b>Ambient Condition</b>	22°C / 63%	<b>Tested By</b>	Roger Lu
--------------------------	------------	------------------	----------

Refer to Appendix E.

## 3.6 Channel Separation

### 3.6.1 Limit of Channel Separation

- Frequency hopping systems shall have hopping channel carrier frequencies separated by a minimum of 25 kHz or the 20 dB bandwidth of the hopping channel, whichever is greater.
- Frequency hopping systems operating in the 2400–2483.5 MHz band may have hopping channel carrier frequencies that are separated by 25 kHz or two-thirds of the 20 dB bandwidth of the hopping channel, whichever is greater.

### 3.6.2 Test Procedures

1. Set RBW=30kHz, VBW=100kHz, Sweep time = Auto, Detector=Peak Trace max hold
2. Allow trace to stabilize
3. Use the marker-delta function to determine the separation between the peaks of the adjacent channels. The EUT shall show compliance with the appropriate regulatory limit

### 3.6.3 Test Setup

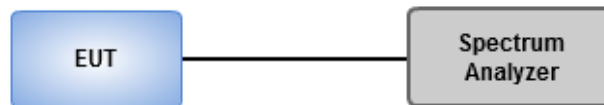

### 3.6.4 Test Results

<b>Ambient Condition</b>	22°C / 63%	<b>Tested By</b>	Roger Lu
--------------------------	------------	------------------	----------

Refer to Appendix F.

### 3.7 Number of Dwell Time

#### 3.7.1 Limit of Dwell time

The average time of occupancy on any channel shall not be greater than 0.4 seconds within a period of 0.4 seconds multiplied by the number of hopping channels employed.

#### 3.7.2 Test Procedures

1. Set RBW=300 kHz, VBW=1 MHz, Sweep time=8 ms, Detector=Peak, Span=0 Hz, Trace max hold.
2. Enable gating and trigger function of spectrum analyzer to measure burst on time.
3. Set RBW=300 kHz, VBW=1 MHz, Sweep time=5 s / 2 s, Detector=Peak, Span=0 Hz, Trace max hold.
4. Enable gating and trigger function of spectrum analyzer to measure burst on number of transmission.
5. Set RBW=300 kHz, VBW=1 MHz, Sweep time=31.6 s / 8 s, Detector=Peak, Span=0 Hz, Trace max hold.
6. Enable gating and trigger function of spectrum analyzer to measure burst on number of transmission of entire time cycle.

#### 3.7.3 Test Setup

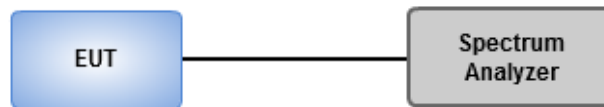

#### 3.7.4 Test Results

<b>Ambient Condition</b>	22°C / 63%	<b>Tested By</b>	Roger Lu
--------------------------	------------	------------------	----------

Refer to Appendix G.

## 4 Test laboratory information

Established in 2012, ICC provides foremost EMC & RF Testing and advisory consultation services by our skilled engineers and technicians. Our services employ a wide variety of advanced edge test equipment and one of the widest certification extents in the business.

International Certification Corporation (EMC and Wireless Communication Laboratory), it is our definitive objective is to institute long term, trust-based associations with our clients. The expectation we set up with our clients is based on outstanding service, practical expertise and devotion to a certified value structure. Our passion is to grant our clients with best EMC / RF services by oriented knowledgeable and accommodating staff.

Our Test sites are located at Linkou District and Kwei Shan District. Location map can be found on our website <http://www.icertifi.com.tw>.

### **Linkou**

Tel: 886-2-2601-1640

No.30-2, Ding Fwu Tsuen, Lin Kou  
District, New Taipei City, Taiwan  
(R.O.C.)

### **Kwei Shan**

Tel: 886-3-271-8666

No.3-1, Lane 6, Wen San 3rd  
St., Kwei Shan Dist., Tao Yuan  
City 33381, Taiwan (R.O.C.)  
No.2-1, Lane 6, Wen San 3rd  
St., Kwei Shan Dist., Tao Yuan  
City 33381, Taiwan (R.O.C.)

### **Kwei Shan Site II**

Tel: 886-3-271-8640

No.14-1, Lane 19, Wen San 3rd  
St., Kwei Shan Dist., Tao Yuan  
City 33381, Taiwan (R.O.C.)

If you have any suggestion, please feel free to contact us as below information.

Tel: 886-3-271-8666

Fax: 886-3-318-0345

Email: ICC\_Service@icertifi.com.tw

==END==



**Summary**

<b>Mode</b>	<b>Result</b>	<b>Type</b>	<b>Freq (Hz)</b>	<b>Level (dBuV/m)</b>	<b>Limit (dBuV/m)</b>	<b>Margin (dB)</b>	<b>Condition</b>
Mode 1	Pass	PK	41.95M	33.25	40.00	-6.75	Vertical





Mode 1

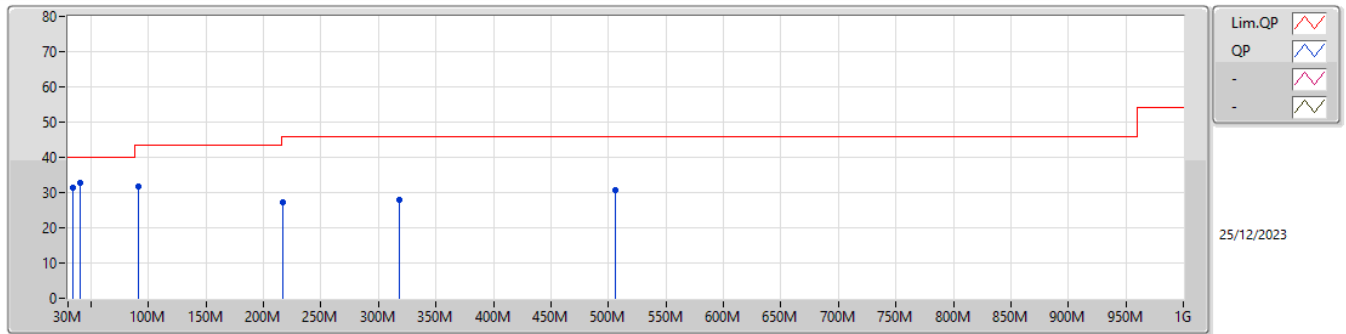

Type	Freq (Hz)	Level (dBuV/m)	Limit (dBuV/m)	Margin (dB)	Factor (dB)	Dist (m)	Condition	Azimuth (°)	Height (m)	Comment	Raw (dBuV)	AF (dB)	CL (dB)	PA (dB)
PK	34.38M	31.55	40.00	-8.45	-9.52	3	Vertical	-	-	-	41.07	17.94	0.53	27.99
PK	40.56M	32.84	40.00	-7.16	-8.79	3	Vertical	-	-	-	41.63	18.66	0.58	28.03
PK	91.18M	31.68	43.50	-11.82	-14.41	3	Vertical	-	-	-	46.09	13.02	0.90	28.33
PK	216.33M	27.16	46.00	-18.84	-11.93	3	Vertical	-	-	-	39.09	15.13	1.38	28.44
PK	318.42M	28.08	46.00	-17.92	-7.44	3	Vertical	-	-	-	35.52	19.27	1.69	28.40
PK	506.07M	30.61	46.00	-15.39	-2.83	3	Vertical	-	-	-	33.44	23.22	2.19	28.24



Mode 1

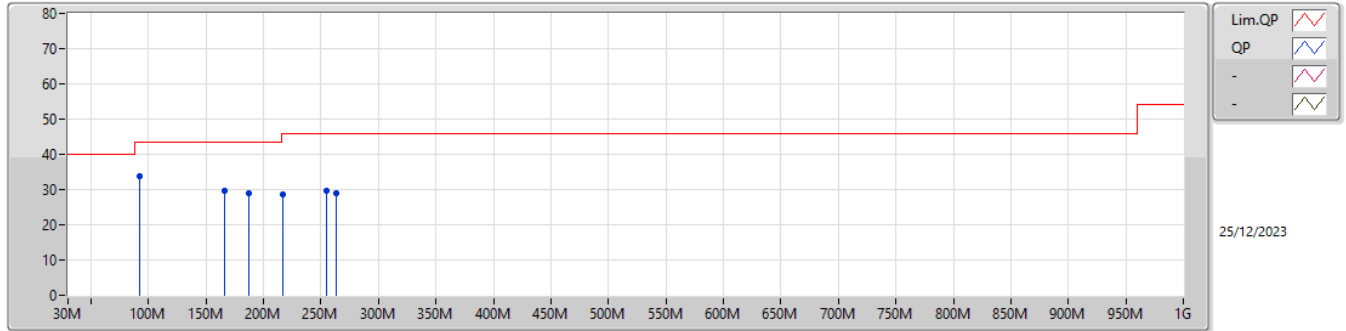

Type	Freq (Hz)	Level (dBuV/m)	Limit (dBuV/m)	Margin (dB)	Factor (dB)	Dist (m)	Condition	Azimuth (°)	Height (m)	Comment	Raw (dBuV)	AF (dB)	CL (dB)	PA (dB)
PK	91.82M	33.94	43.50	-9.56	-14.35	3	Horizontal	-	-	-	48.29	13.08	0.90	28.33
PK	165.91M	29.73	43.50	-13.77	-9.01	3	Horizontal	-	-	-	38.74	18.20	1.21	28.42
PK	187.73M	28.96	43.50	-14.54	-11.01	3	Horizontal	-	-	-	39.97	16.13	1.29	28.43
PK	216.88M	28.46	46.00	-17.54	-11.92	3	Horizontal	-	-	-	40.38	15.14	1.38	28.44
PK	254.62M	29.67	46.00	-16.33	-9.84	3	Horizontal	-	-	-	39.51	17.09	1.50	28.43
PK	263.77M	29.13	46.00	-16.87	-9.35	3	Horizontal	-	-	-	38.48	17.55	1.53	28.43



**Summary**

Mode	Result	Type	Freq (Hz)	Level (dBuV/m)	Limit (dBuV/m)	Margin (dB)	Dist (m)	Condition	Azimuth (°)	Height (m)	Comments
2.4-2.4835GHz	-	-	-	-	-	-	-	-	-	-	-
BT-BR(1Mbps)	Pass	AV	2.39G	39.22	54.00	-14.78	3	Horizontal	11	1.00	-
BT-EDR(3Mbps)	Pass	AV	2.4835G	50.06	54.00	-3.94	3	Horizontal	23	1.07	-



2.4-2.4835GHz\_BT-BR(1Mbps)

2402MHz\_TX

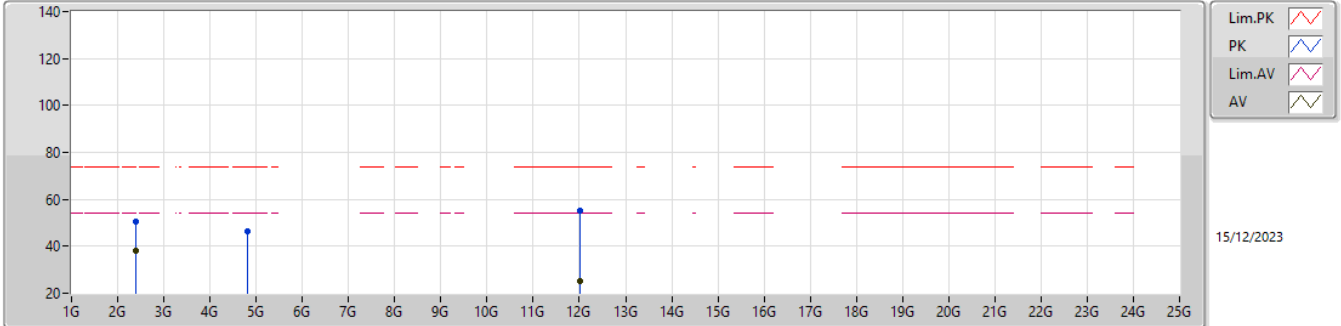

Type	Freq (Hz)	Level (dBuV/m)	Limit (dBuV/m)	Margin (dB)	Raw (dBuV)	Dist (m)	Condition	Azimuth (°)	Height (m)	Comment	AF (dB)	CL (dB)	PA (dB)
PK	2.39G	50.68	74.00	-23.32	55.06	3	Vertical	19	2.59	-	27.60	4.95	36.93
AV	2.39G	38.13	54.00	-15.87	42.51	3	Vertical	19	2.59	-	27.60	4.95	36.93
PK	4.804G	46.20	74.00	-27.80	46.58	3	Vertical	194	1.00	-	31.29	6.85	38.52
AV	4.804G	16.10	54.00	-37.90	-	3	Vertical	194	1.00	-	-	-	-
PK	12.01G	55.40	74.00	-18.60	49.13	3	Vertical	112	1.00	-	39.20	10.02	42.95
AV	12.01G	25.30	54.00	-28.70	-	3	Vertical	112	1.00	-	-	-	-



2.4-2.4835GHz\_BT-BR(1Mbps)

2402MHz\_TX

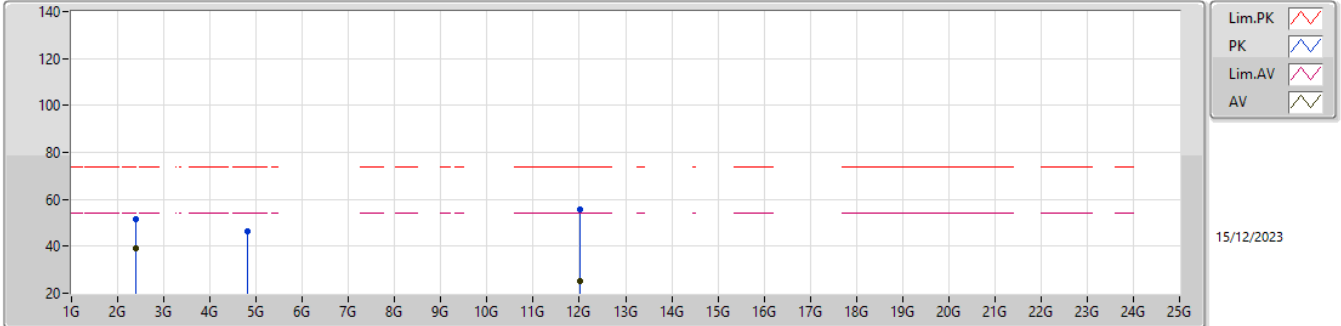

Type	Freq (Hz)	Level (dBuV/m)	Limit (dBuV/m)	Margin (dB)	Raw (dBuV)	Dist (m)	Condition	Azimuth (°)	Height (m)	Comment	AF (dB)	CL (dB)	PA (dB)
PK	2.39G	51.35	74.00	-22.65	55.73	3	Horizontal	11	1.00	-	27.60	4.95	36.93
AV	2.39G	39.22	54.00	-14.78	43.60	3	Horizontal	11	1.00	-	27.60	4.95	36.93
PK	4.804G	46.17	74.00	-27.83	46.55	3	Horizontal	67	1.42	-	31.29	6.85	38.52
AV	4.804G	16.07	54.00	-37.93	-	3	Horizontal	67	1.42	-	-	-	-
PK	12.01G	55.46	74.00	-18.54	49.19	3	Horizontal	251	1.00	-	39.20	10.02	42.95
AV	12.01G	25.36	54.00	-28.64	-	3	Horizontal	251	1.00	-	-	-	-



2.4-2.4835GHz\_BT-BR(1Mbps)

2441MHz\_TX

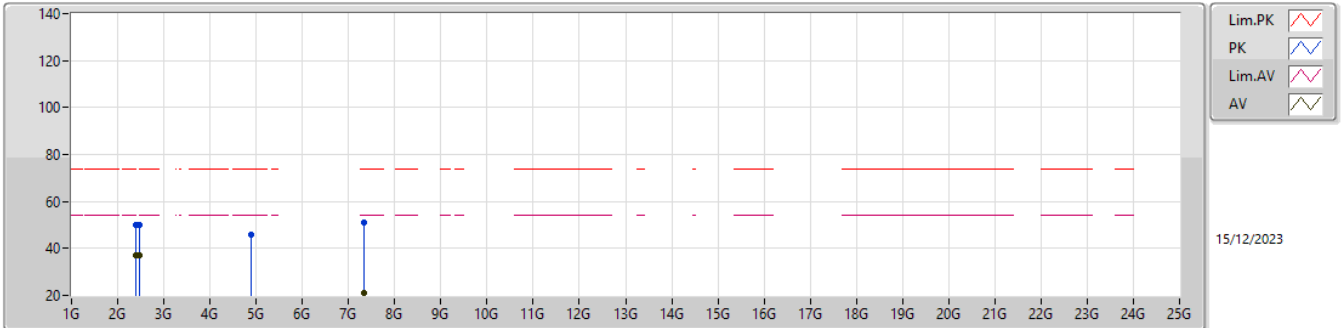

Type	Freq (Hz)	Level (dBuV/m)	Limit (dBuV/m)	Margin (dB)	Raw (dBuV)	Dist (m)	Condition	Azimuth (°)	Height (m)	Comment	AF (dB)	CL (dB)	PA (dB)
PK	2.39G	49.90	74.00	-24.10	54.28	3	Vertical	17	2.52	-	27.60	4.95	36.93
AV	2.39G	36.87	54.00	-17.13	41.25	3	Vertical	17	2.52	-	27.60	4.95	36.93
PK	2.4835G	49.82	74.00	-24.18	54.57	3	Vertical	17	2.52	-	27.20	5.06	37.01
AV	2.4835G	37.11	54.00	-16.89	41.86	3	Vertical	17	2.52	-	27.20	5.06	37.01
PK	4.882G	46.11	74.00	-27.89	46.62	3	Vertical	197	1.00	-	31.14	6.92	38.57
AV	4.882G	16.01	54.00	-37.99	-	3	Vertical	197	1.00	-	-	-	-
PK	7.323G	50.90	74.00	-23.10	45.78	3	Vertical	117	1.00	-	36.15	8.43	39.46
AV	7.323G	20.80	54.00	-33.20	-	3	Vertical	117	1.00	-	-	-	-



2.4-2.4835GHz\_BT-BR(1Mbps)

2441MHz\_TX

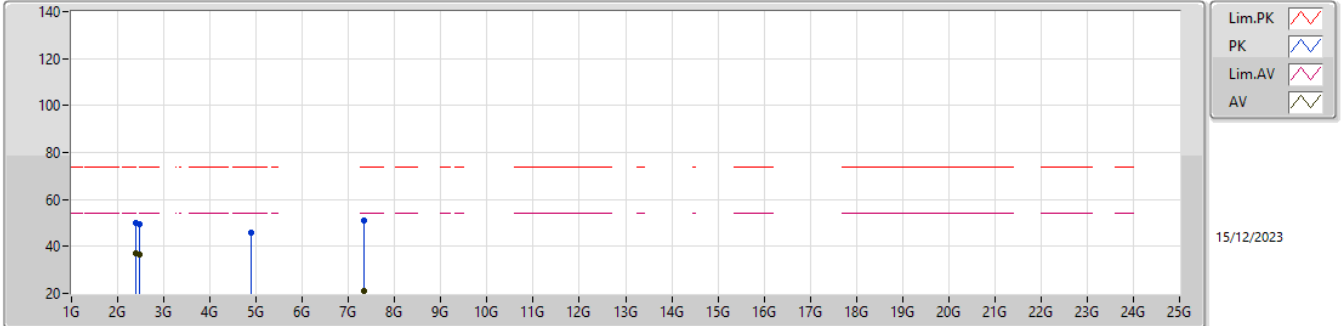

Type	Freq (Hz)	Level (dBuV/m)	Limit (dBuV/m)	Margin (dB)	Raw (dBuV)	Dist (m)	Condition	Azimuth (°)	Height (m)	Comment	AF (dB)	CL (dB)	PA (dB)
PK	2.39G	49.77	74.00	-24.23	54.15	3	Horizontal	354	1.28	-	27.60	4.95	36.93
AV	2.39G	36.87	54.00	-17.13	41.25	3	Horizontal	354	1.28	-	27.60	4.95	36.93
PK	2.4835G	49.71	74.00	-24.29	54.46	3	Horizontal	354	1.28	-	27.20	5.06	37.01
AV	2.4835G	36.81	54.00	-17.19	41.56	3	Horizontal	354	1.28	-	27.20	5.06	37.01
PK	4.882G	46.06	74.00	-27.94	46.57	3	Horizontal	67	1.36	-	31.14	6.92	38.57
AV	4.882G	15.96	54.00	-38.04	-	3	Horizontal	67	1.36	-	-	-	-
PK	7.323G	51.14	74.00	-22.86	46.02	3	Horizontal	152	1.00	-	36.15	8.43	39.46
AV	7.323G	21.04	54.00	-32.96	-	3	Horizontal	152	1.00	-	-	-	-



2.4-2.4835GHz\_BT-BR(1Mbps)

2480MHz\_TX

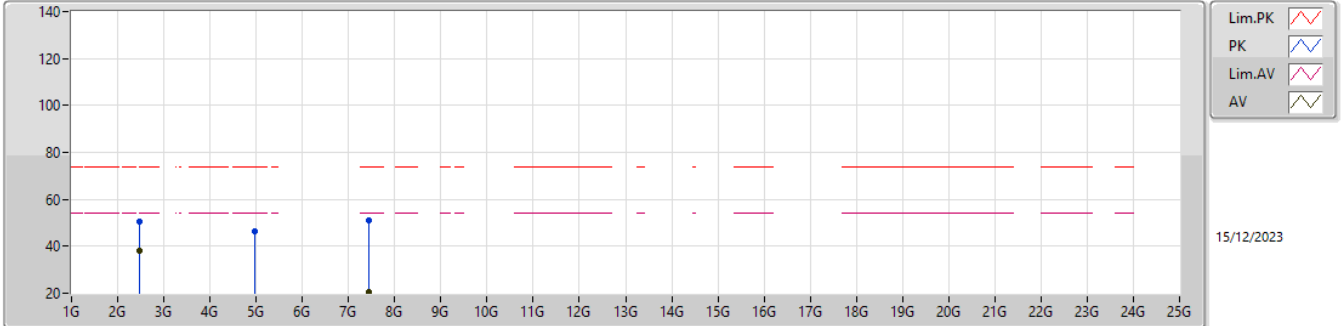

Type	Freq (Hz)	Level (dBuV/m)	Limit (dBuV/m)	Margin (dB)	Raw (dBuV)	Dist (m)	Condition	Azimuth (°)	Height (m)	Comment	AF (dB)	CL (dB)	PA (dB)
PK	2.4835G	50.37	74.00	-23.63	55.12	3	Vertical	18	2.45	-	27.20	5.06	37.01
AV	2.4835G	37.96	54.00	-16.04	42.71	3	Vertical	18	2.45	-	27.20	5.06	37.01
PK	4.96G	46.40	74.00	-27.60	46.67	3	Vertical	199	1.00	-	31.36	6.99	38.62
AV	4.96G	16.30	54.00	-37.70	-	3	Vertical	199	1.00	-	-	-	-
PK	7.44G	50.84	74.00	-23.16	45.61	3	Vertical	251	1.00	-	36.34	8.50	39.61
AV	7.44G	20.74	54.00	-33.26	-	3	Vertical	251	1.00	-	-	-	-





2.4-2.4835GHz\_BT-BR(1Mbps)

2480MHz\_TX

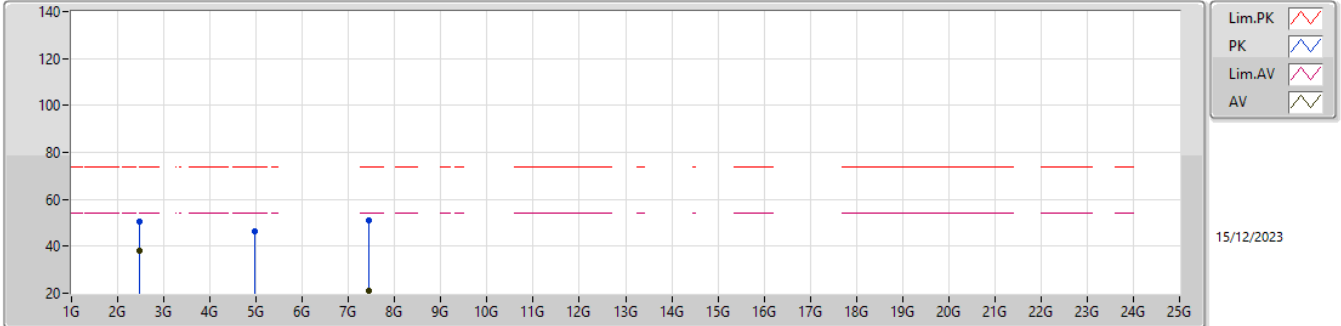

Type	Freq (Hz)	Level (dBuV/m)	Limit (dBuV/m)	Margin (dB)	Raw (dBuV)	Dist (m)	Condition	Azimuth (°)	Height (m)	Comment	AF (dB)	CL (dB)	PA (dB)
PK	2.4835G	50.33	74.00	-23.67	55.08	3	Horizontal	355	1.24	-	27.20	5.06	37.01
AV	2.4835G	37.93	54.00	-16.07	42.68	3	Horizontal	355	1.24	-	27.20	5.06	37.01
PK	4.96G	46.31	74.00	-27.69	46.58	3	Horizontal	68	1.38	-	31.36	6.99	38.62
AV	4.96G	16.21	54.00	-37.79	-	3	Horizontal	68	1.38	-	-	-	-
PK	7.44G	51.05	74.00	-22.95	45.82	3	Horizontal	147	1.00	-	36.34	8.50	39.61
AV	7.44G	20.95	54.00	-33.05	-	3	Horizontal	147	1.00	-	-	-	-



2.4-2.4835GHz\_BT-EDR(3Mbps)

2402MHz\_TX

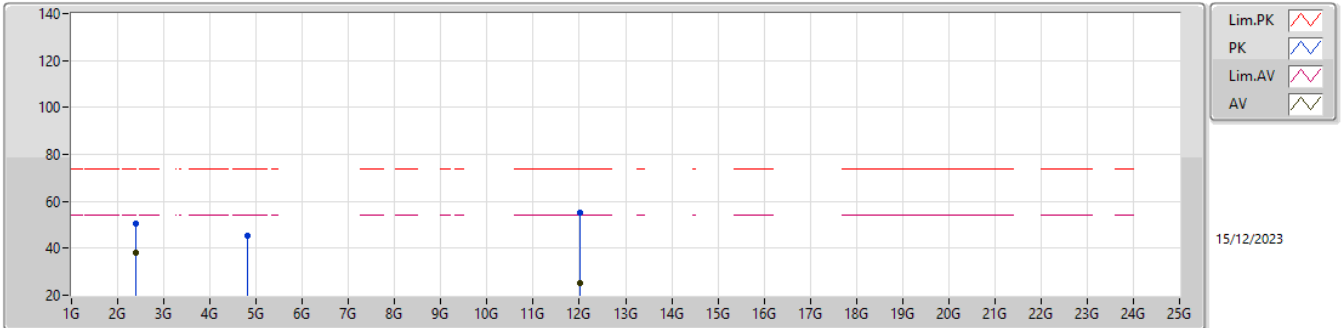

Type	Freq (Hz)	Level (dBuV/m)	Limit (dBuV/m)	Margin (dB)	Raw (dBuV)	Dist (m)	Condition	Azimuth (°)	Height (m)	Comment	AF (dB)	CL (dB)	PA (dB)
PK	2.39G	50.50	74.00	-23.50	54.88	3	Vertical	20	2.59	-	27.60	4.95	36.93
AV	2.39G	38.12	54.00	-15.88	42.50	3	Vertical	20	2.59	-	27.60	4.95	36.93
PK	4.804G	45.51	74.00	-28.49	45.89	3	Vertical	204	1.00	-	31.29	6.85	38.52
AV	4.804G	15.41	54.00	-38.59	-	3	Vertical	204	1.00	-	-	-	-
PK	12.01G	55.36	74.00	-18.64	49.09	3	Vertical	159	1.00	-	39.20	10.02	42.95
AV	12.01G	25.26	54.00	-28.74	-	3	Vertical	159	1.00	-	-	-	-



2.4-2.4835GHz\_BT-EDR(3Mbps)

2402MHz\_TX

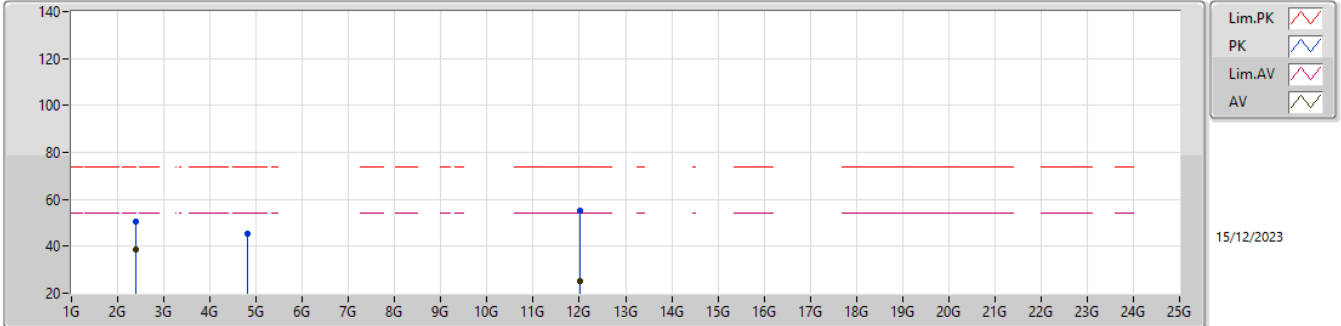

Type	Freq (Hz)	Level (dBuV/m)	Limit (dBuV/m)	Margin (dB)	Raw (dBuV)	Dist (m)	Condition	Azimuth (°)	Height (m)	Comment	AF (dB)	CL (dB)	PA (dB)
PK	2.39G	50.51	74.00	-23.49	54.89	3	Horizontal	14	1.00	-	27.60	4.95	36.93
AV	2.39G	38.46	54.00	-15.54	42.84	3	Horizontal	14	1.00	-	27.60	4.95	36.93
PK	4.804G	45.52	74.00	-28.48	45.90	3	Horizontal	115	1.00	-	31.29	6.85	38.52
AV	4.804G	15.42	54.00	-38.58	-	3	Horizontal	115	1.00	-	-	-	-
PK	12.01G	55.43	74.00	-18.57	49.16	3	Horizontal	251	1.00	-	39.20	10.02	42.95
AV	12.01G	25.33	54.00	-28.67	-	3	Horizontal	251	1.00	-	-	-	-



2.4-2.4835GHz\_BT-EDR(3Mbps)

2441MHz\_TX

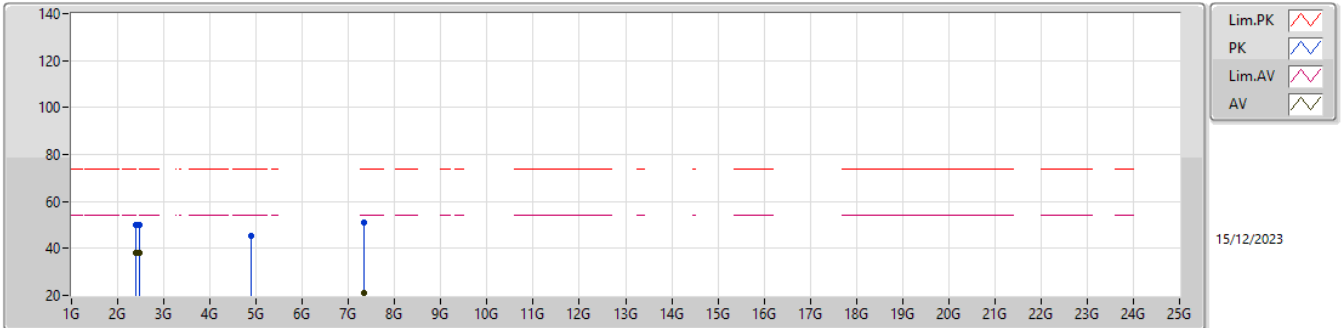

Type	Freq (Hz)	Level (dBuV/m)	Limit (dBuV/m)	Margin (dB)	Raw (dBuV)	Dist (m)	Condition	Azimuth (°)	Height (m)	Comment	AF (dB)	CL (dB)	PA (dB)
PK	2.39G	50.02	74.00	-23.98	54.40	3	Vertical	16	2.50	-	27.60	4.95	36.93
AV	2.39G	37.92	54.00	-16.08	42.30	3	Vertical	16	2.50	-	27.60	4.95	36.93
PK	2.4835G	49.97	74.00	-24.03	54.72	3	Vertical	16	2.50	-	27.20	5.06	37.01
AV	2.4835G	37.93	54.00	-16.07	42.68	3	Vertical	16	2.50	-	27.20	5.06	37.01
PK	4.882G	45.34	74.00	-28.66	45.85	3	Vertical	168	1.00	-	31.14	6.92	38.57
AV	4.882G	15.24	54.00	-38.76	-	3	Vertical	168	1.00	-	-	-	-
PK	7.323G	51.12	74.00	-22.88	46.00	3	Vertical	231	1.00	-	36.15	8.43	39.46
AV	7.323G	21.02	54.00	-32.98	-	3	Vertical	231	1.00	-	-	-	-



2.4-2.4835GHz\_BT-EDR(3Mbps)

2441MHz\_TX

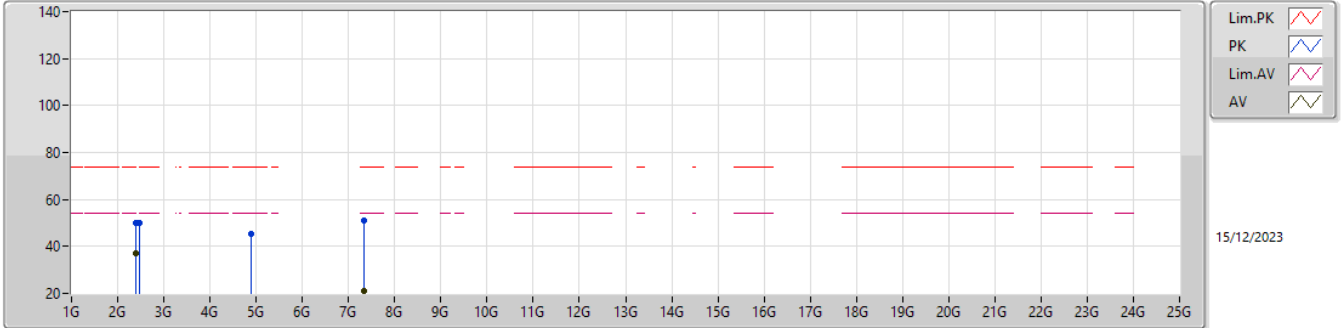

Type	Freq (Hz)	Level (dBuV/m)	Limit (dBuV/m)	Margin (dB)	Raw (dBuV)	Dist (m)	Condition	Azimuth (°)	Height (m)	Comment	AF (dB)	CL (dB)	PA (dB)
PK	2.39G	49.97	74.00	-24.03	54.35	3	Horizontal	23	1.07	-	27.60	4.95	36.93
AV	2.39G	37.09	54.00	-16.91	41.47	3	Horizontal	23	1.07	-	27.60	4.95	36.93
PK	2.4835G	50.11	74.00	-23.89	54.86	3	Horizontal	23	1.07	-	27.20	5.06	37.01
AV	2.4835G	50.06	54.00	-3.94	54.81	3	Horizontal	23	1.07	-	27.20	5.06	37.01
PK	4.882G	45.39	74.00	-28.61	45.90	3	Horizontal	166	1.00	-	31.14	6.92	38.57
AV	4.882G	15.29	54.00	-38.71	-	3	Horizontal	166	1.00	-	-	-	-
PK	7.323G	51.09	74.00	-22.91	45.97	3	Horizontal	251	1.00	-	36.15	8.43	39.46
AV	7.323G	20.99	54.00	-33.01	-	3	Horizontal	251	1.00	-	-	-	-



2.4-2.4835GHz\_BT-EDR(3Mbps)

2480MHz\_TX

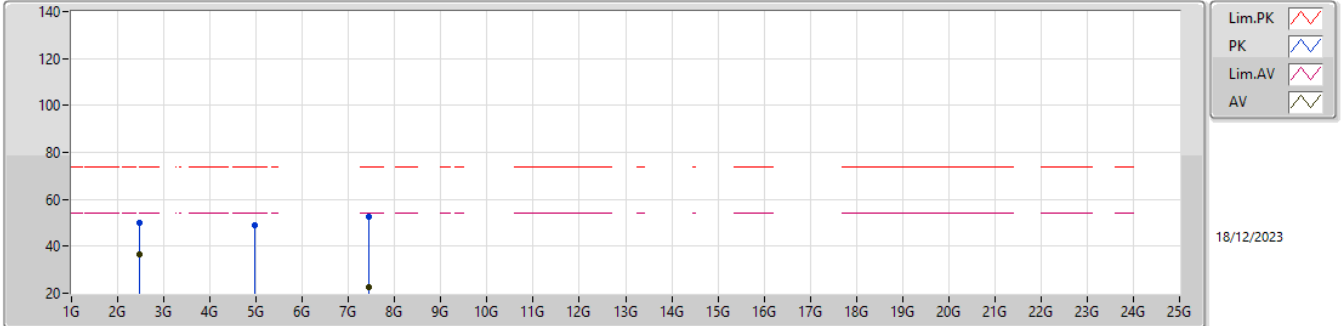

Type	Freq (Hz)	Level (dBuV/m)	Limit (dBuV/m)	Margin (dB)	Raw (dBuV)	Dist (m)	Condition	Azimuth (°)	Height (m)	Comment	AF (dB)	CL (dB)	PA (dB)
PK	2.4835G	49.96	74.00	-24.04	54.71	3	Vertical	14	2.26	-	27.20	5.06	37.01
AV	2.4835G	36.47	54.00	-17.53	41.22	3	Vertical	14	2.26	-	27.20	5.06	37.01
PK	4.96G	48.80	74.00	-25.20	49.07	3	Vertical	138	1.00	-	31.36	6.99	38.62
AV	4.96G	18.70	54.00	-35.30	-	3	Vertical	138	1.00	-	-	-	-
PK	7.44G	52.61	74.00	-21.39	47.38	3	Vertical	146	1.00	-	36.34	8.50	39.61
AV	7.44G	22.51	54.00	-31.49	-	3	Vertical	146	1.00	-	-	-	-



2.4-2.4835GHz\_BT-EDR(3Mbps)

2480MHz\_TX

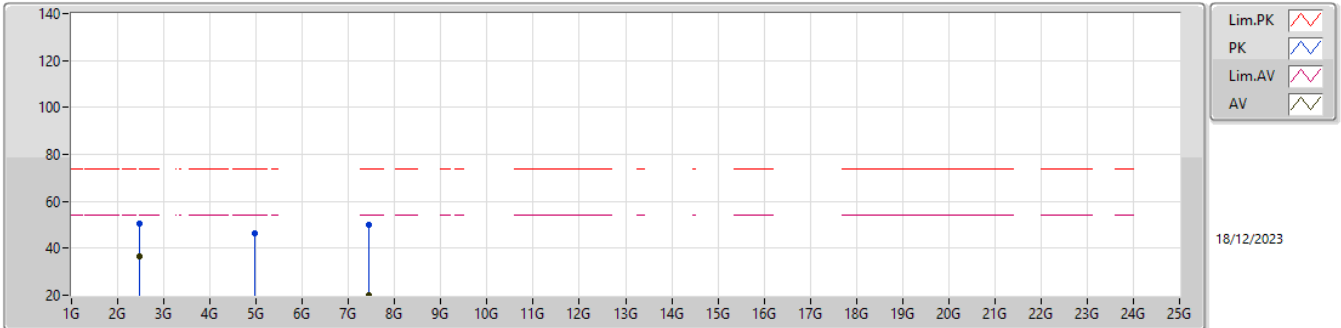

Type	Freq (Hz)	Level (dBuV/m)	Limit (dBuV/m)	Margin (dB)	Raw (dBuV)	Dist (m)	Condition	Azimuth (°)	Height (m)	Comment	AF (dB)	CL (dB)	PA (dB)
PK	2.4835G	50.46	74.00	-23.54	55.21	3	Horizontal	333	1.19	-	27.20	5.06	37.01
AV	2.4835G	36.77	54.00	-17.23	41.52	3	Horizontal	333	1.19	-	27.20	5.06	37.01
PK	4.96G	46.61	74.00	-27.39	46.88	3	Horizontal	25	1.00	-	31.36	6.99	38.62
AV	4.96G	16.51	54.00	-37.49	-	3	Horizontal	25	1.00	-	-	-	-
PK	7.44G	49.92	74.00	-24.08	44.69	3	Horizontal	164	1.00	-	36.34	8.50	39.61
AV	7.44G	19.82	54.00	-34.18	-	3	Horizontal	164	1.00	-	-	-	-

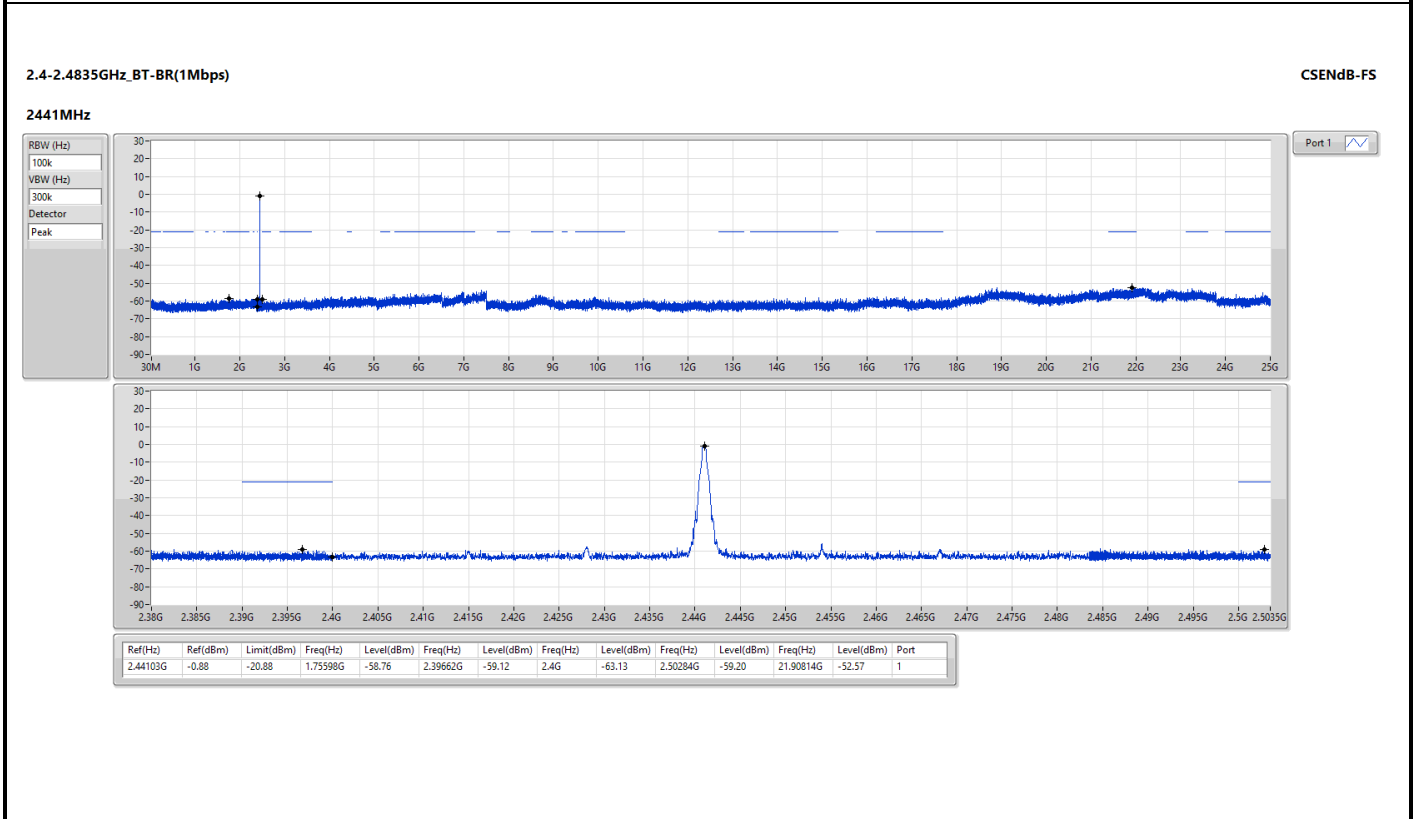
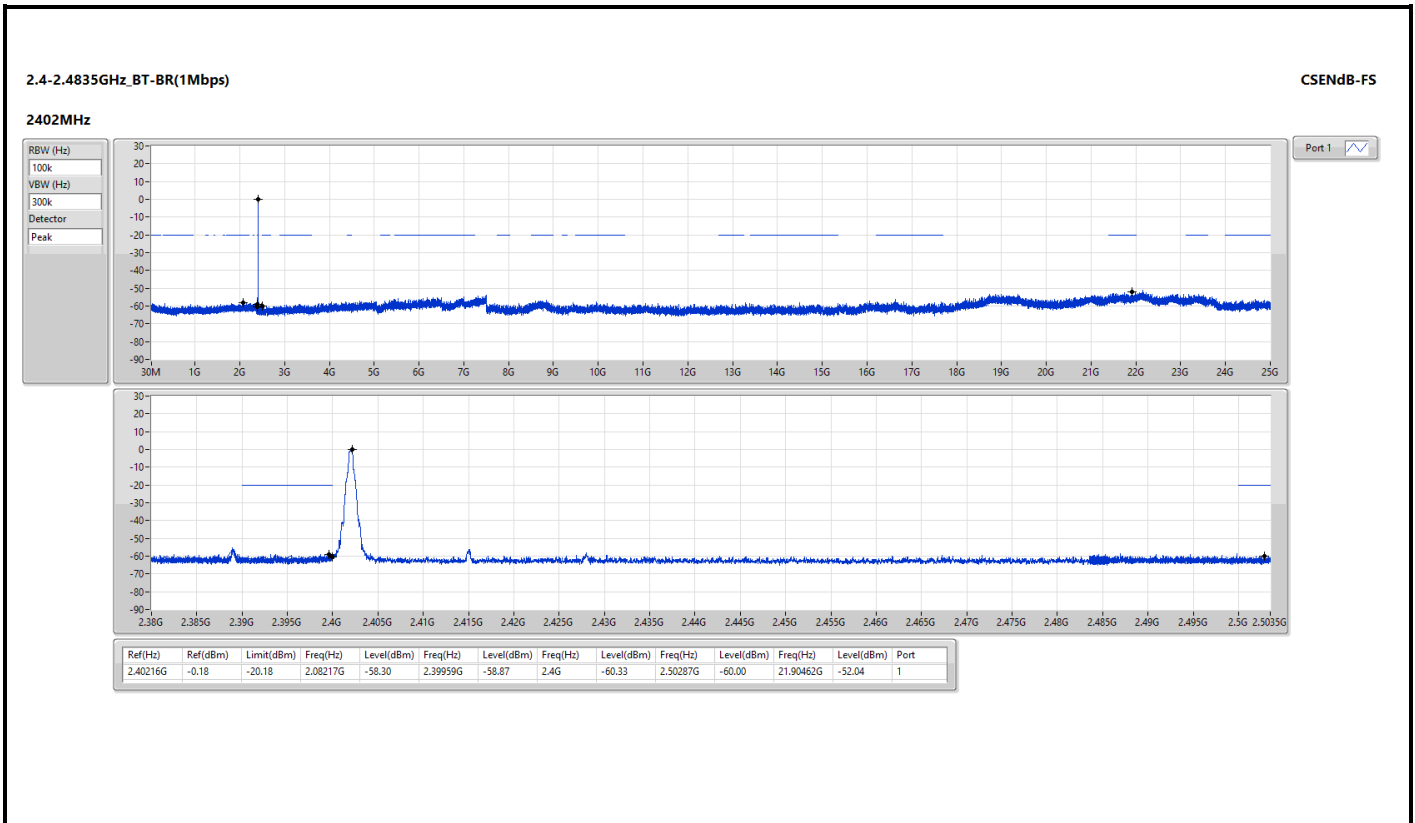



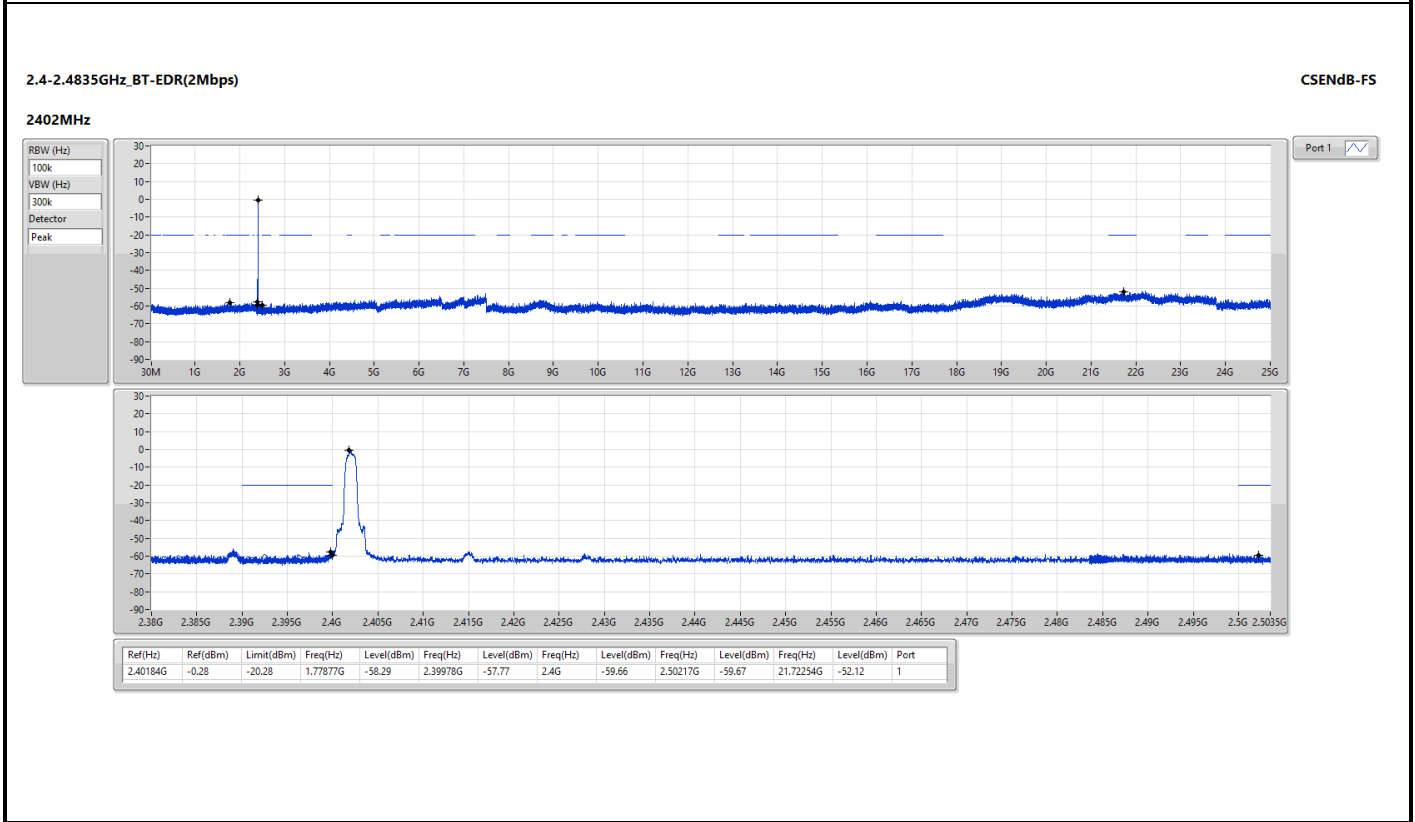
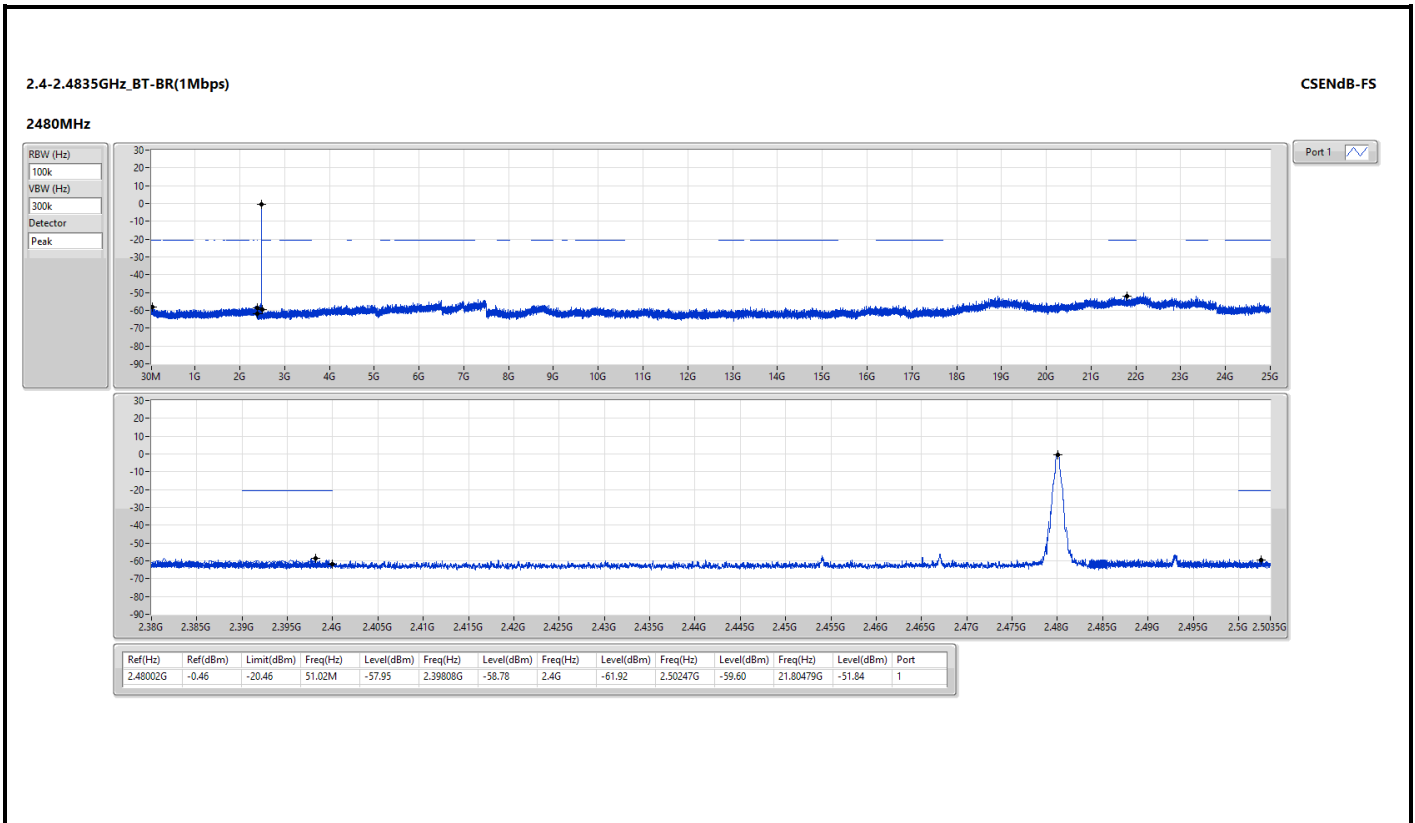

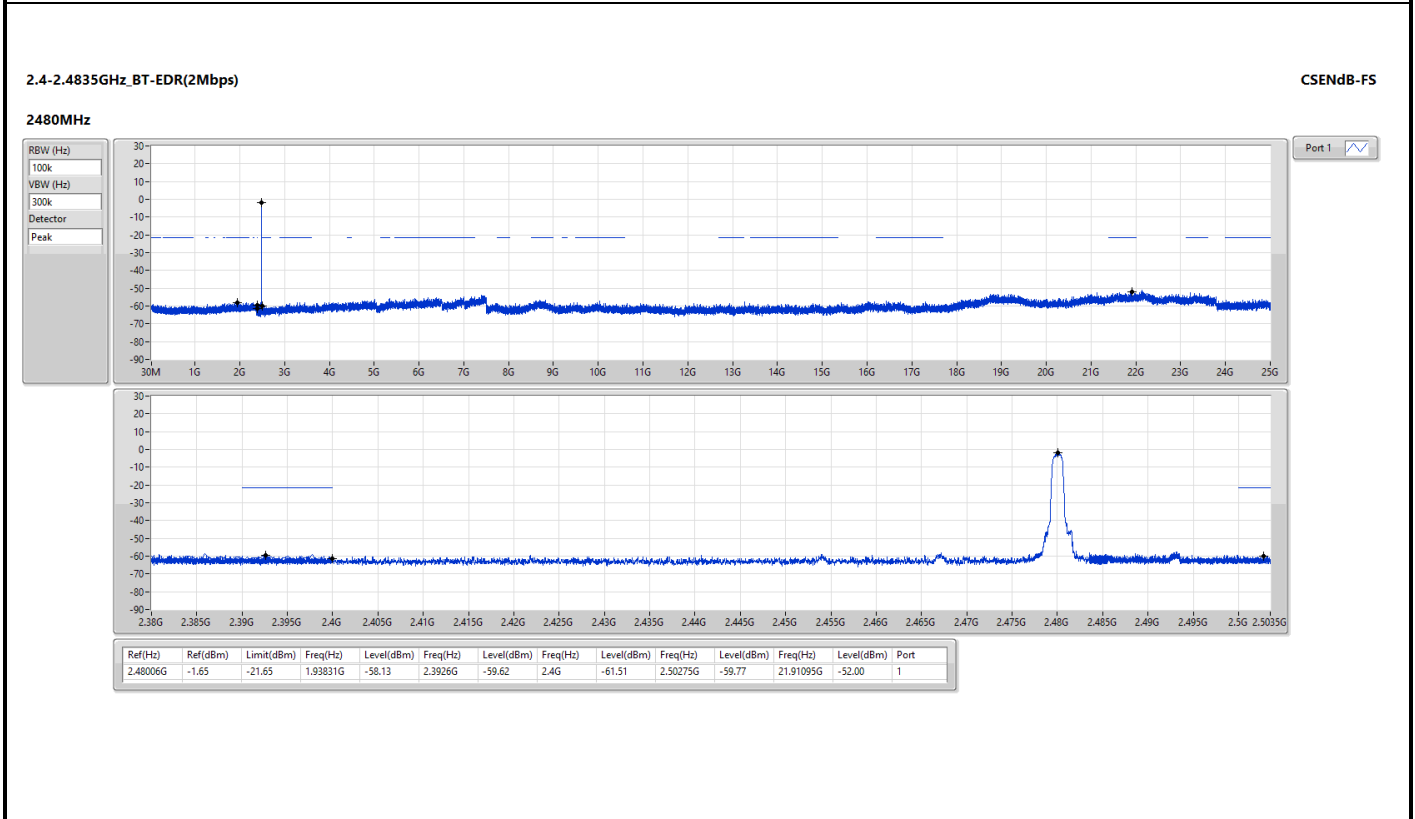
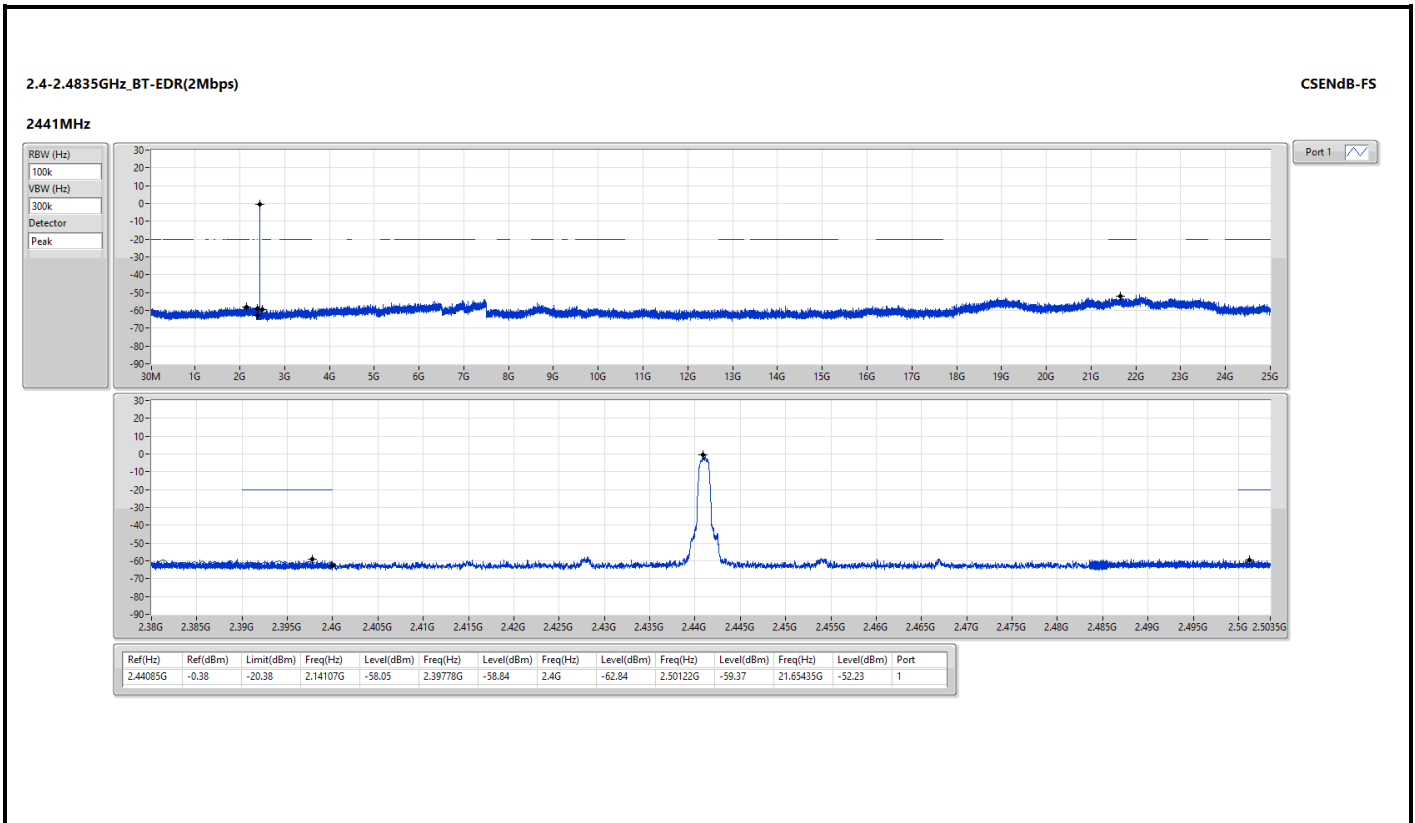

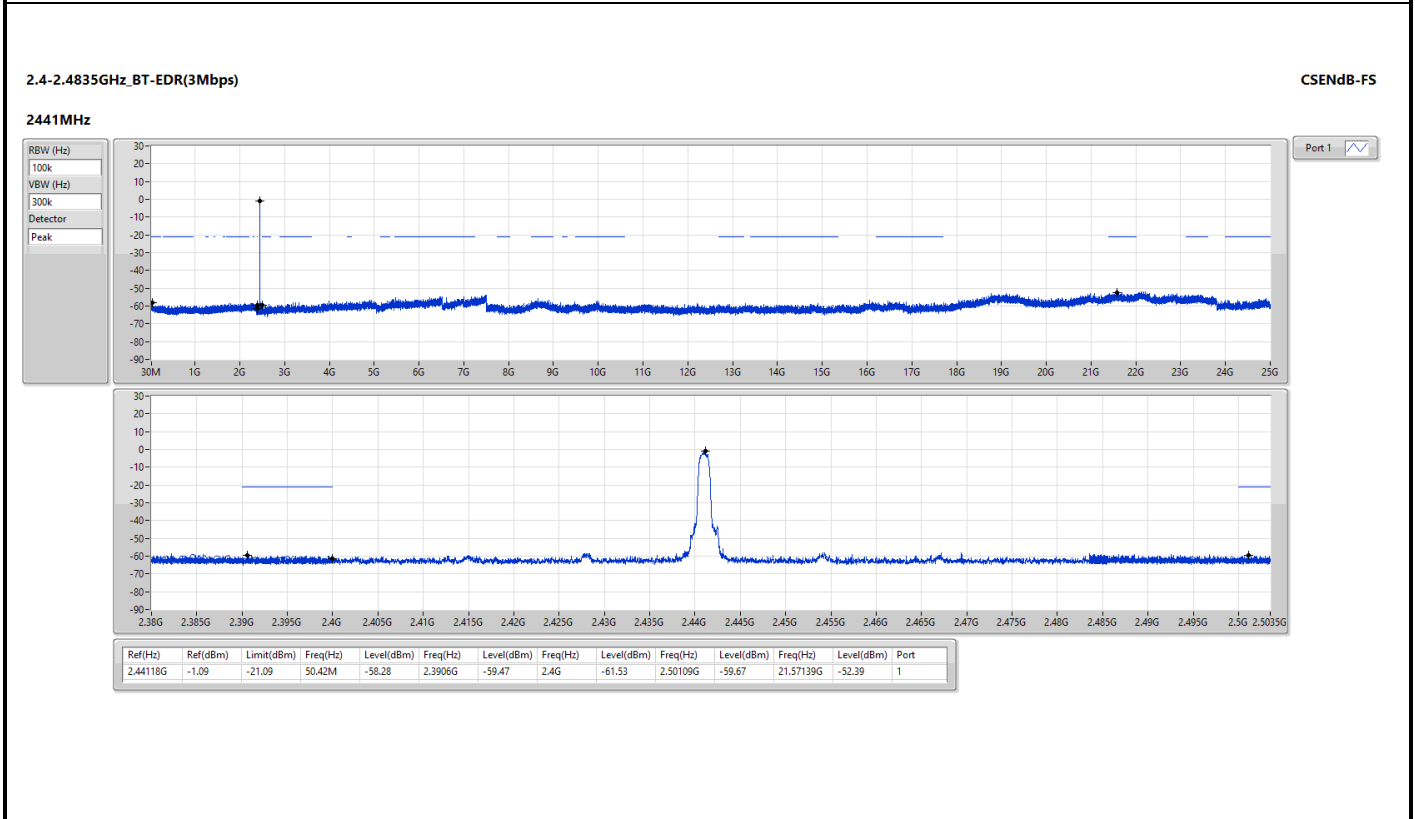
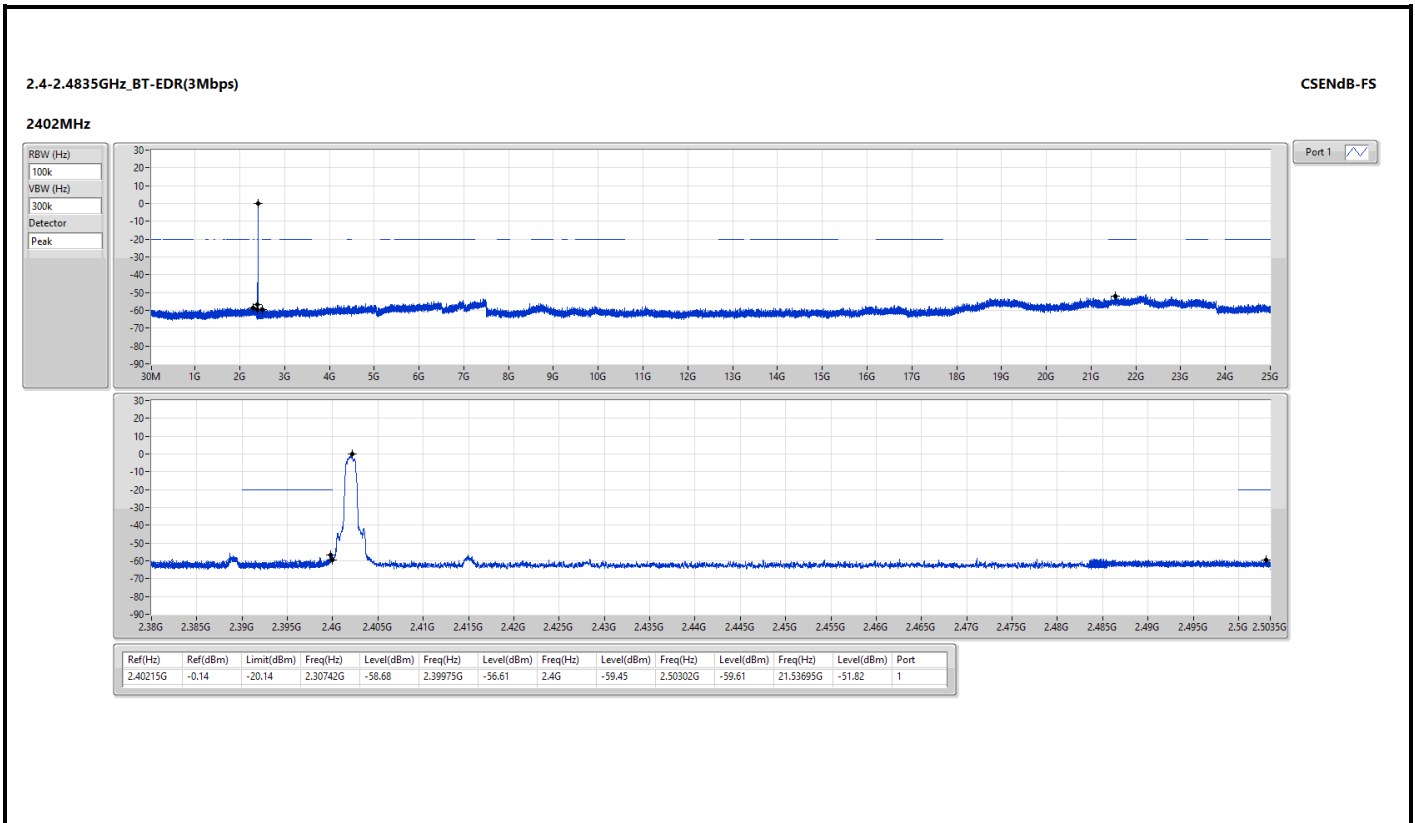

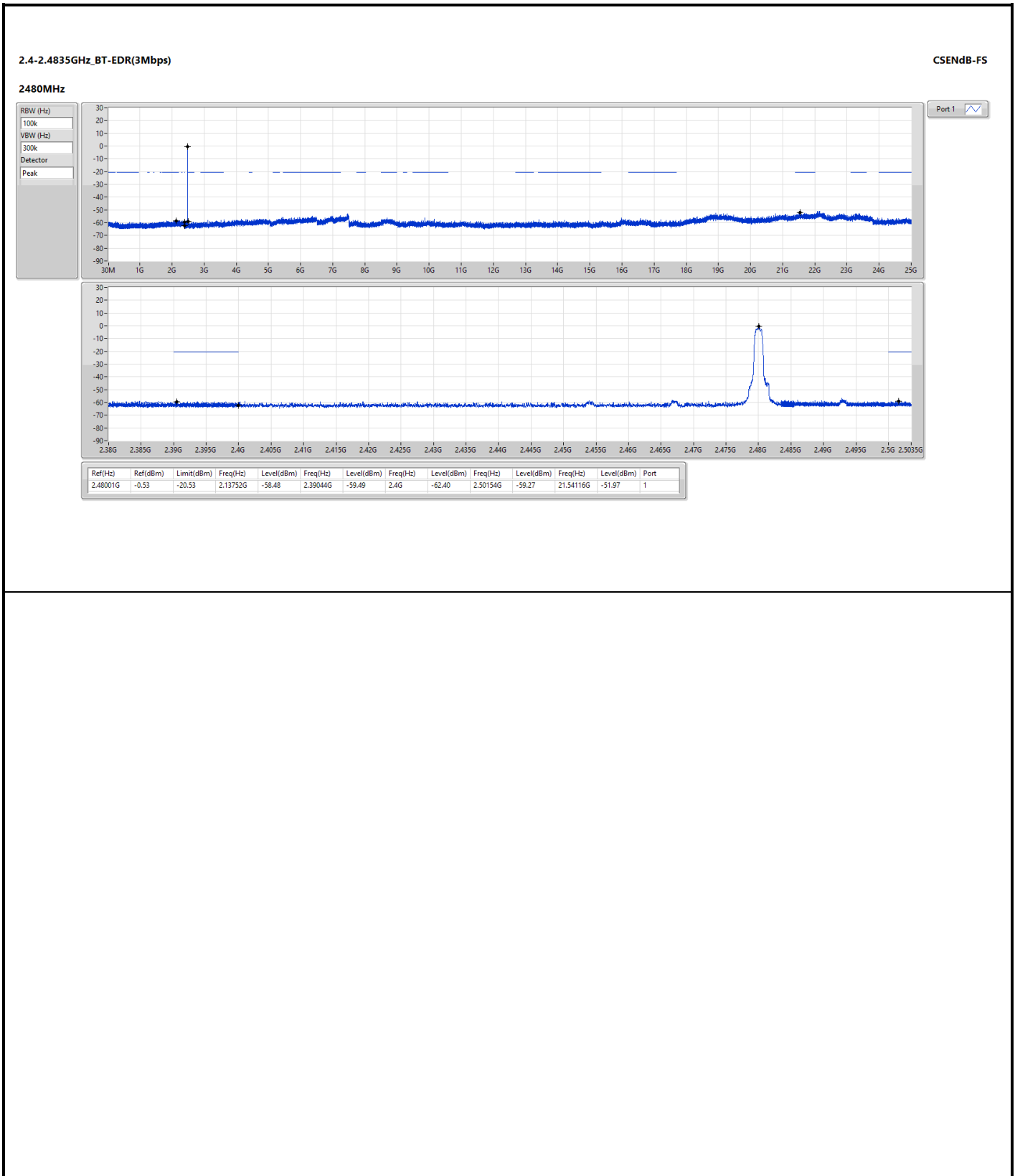

**2.4-2.4835GHz\_BT-BR(1Mbps)**

**2402MHz**

**Hopping Ch Bandedge (Non-restricted Band)**

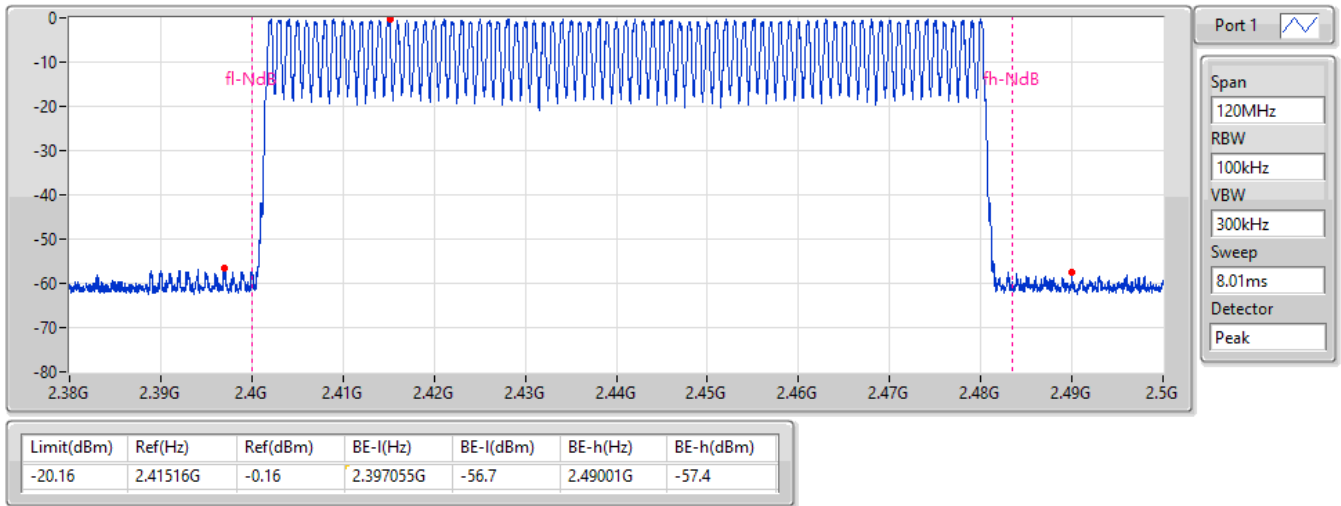

**2.4-2.4835GHz\_BT-EDR(2Mbps)**

**2402MHz**

**Hopping Ch Bandedge (Non-restricted Band)**

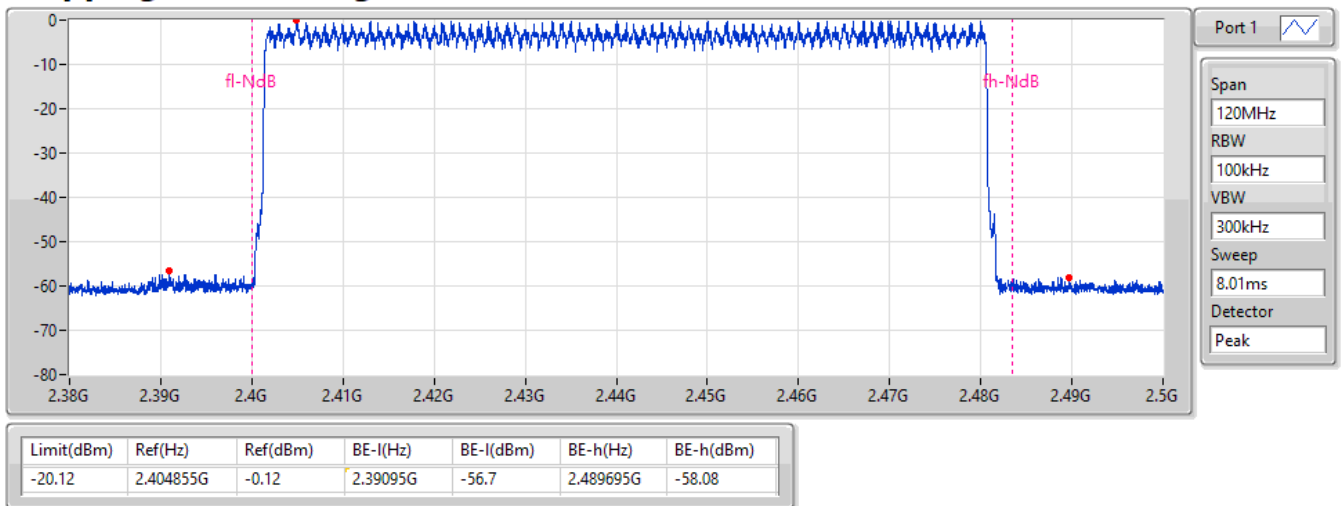

### 2.4-2.4835GHz\_BT-EDR(3Mbps)

2402MHz

### Hopping Ch Bandedge (Non-restricted Band)

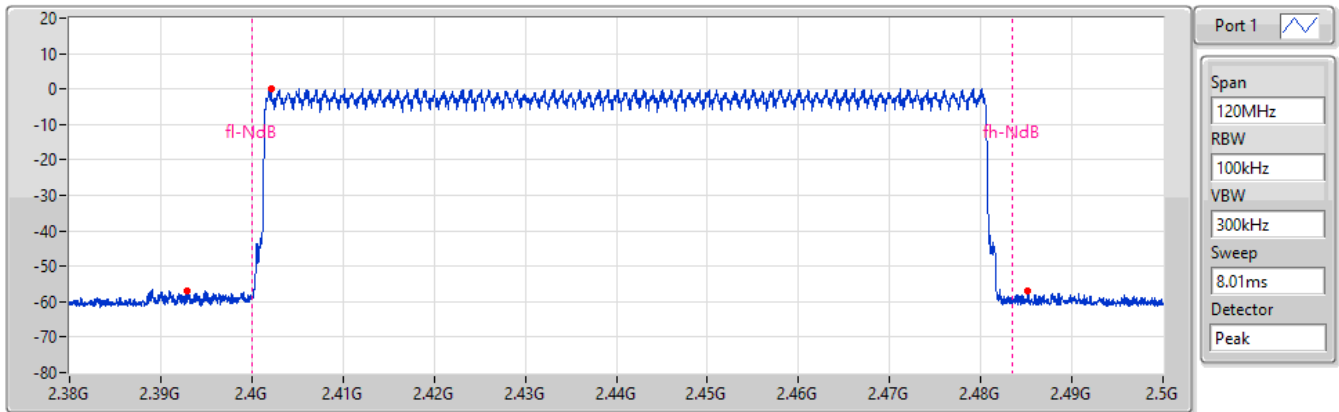

Limit(dBm)	Ref(Hz)	Ref(dBm)	BE-l(Hz)	BE-l(dBm)	BE-h(Hz)	BE-h(dBm)
-19.98	2.402155G	0.02	2.39293G	-56.76	2.485165G	-57.13



Summary

Mode	Total Power (dBm)	Power (W)
2.4-2.4835GHz	-	-
BT-BR(1Mbps)	0.96	0.00125
BT-EDR(2Mbps)	3.64	0.00231
BT-EDR(3Mbps)	4.34	0.00272

Result

Mode	Result	Antenna Gain (dBi)	Total Power (dBm)	Power Limit (dBm)	EIRP (dBm)	EIRP Limit (dBm)
BT-BR(1Mbps)	-	-	-	-	-	-
2402MHz	Pass	3.60	0.60	21.00	4.20	27.00
2441MHz	Pass	3.60	0.96	21.00	4.56	27.00
2480MHz	Pass	3.60	0.72	21.00	4.32	27.00
BT-EDR(2Mbps)	-	-	-	-	-	-
2402MHz	Pass	3.60	3.36	21.00	6.96	27.00
2441MHz	Pass	3.60	3.64	21.00	7.24	27.00
2480MHz	Pass	3.60	3.37	21.00	6.97	27.00
BT-EDR(3Mbps)	-	-	-	-	-	-
2402MHz	Pass	3.60	3.96	21.00	7.56	27.00
2441MHz	Pass	3.60	4.34	21.00	7.94	27.00
2480MHz	Pass	3.60	4.14	21.00	7.74	27.00

DG = Directional Gain; Port X = Port X output power



## Conducted Output Power(Average)

## Appendix C.2

### Summary

Mode	Total Power (dBm)	Power (W)
2.4-2.4835GHz	-	-
BT-BR(1Mbps)	0.65	0.00116
BT-EDR(2Mbps)	0.88	0.00122
BT-EDR(3Mbps)	0.97	0.00125

### Result

Mode	Result	Antenna Gain (dBi)	Total Power (dBm)	Power Limit (dBm)	EIRP (dBm)	EIRP Limit (dBm)
BT-BR(1Mbps)	-	-	-	-	-	-
2402MHz	Pass	3.60	0.30	-	3.90	-
2441MHz	Pass	3.60	0.65	-	4.25	-
2480MHz	Pass	3.60	0.40	-	4.00	-
BT-EDR(2Mbps)	-	-	-	-	-	-
2402MHz	Pass	3.60	0.63	-	4.23	-
2441MHz	Pass	3.60	0.88	-	4.48	-
2480MHz	Pass	3.60	0.63	-	4.23	-
BT-EDR(3Mbps)	-	-	-	-	-	-
2402MHz	Pass	3.60	0.65	-	4.25	-
2441MHz	Pass	3.60	0.97	-	4.57	-
2480MHz	Pass	3.60	0.72	-	4.32	-

Note: Average power is for reference only





**Summary**

Mode	Max-Hop No
2.4-2.4835GHz	-
BT-BR(1Mbps)	79
BT-EDR(2Mbps)	79
BT-EDR(3Mbps)	79

**Result**

Mode	Result	Hopping No	Limit
BT-BR(1Mbps)	-	-	-
2402MHz	Pass	79	15
BT-EDR(2Mbps)	-	-	-
2402MHz	Pass	79	15
BT-EDR(3Mbps)	-	-	-
2402MHz	Pass	79	15

**2.4-2.4835GHz\_BT-BR(1Mbps)**

**Hopping-FS**

**2402MHz**

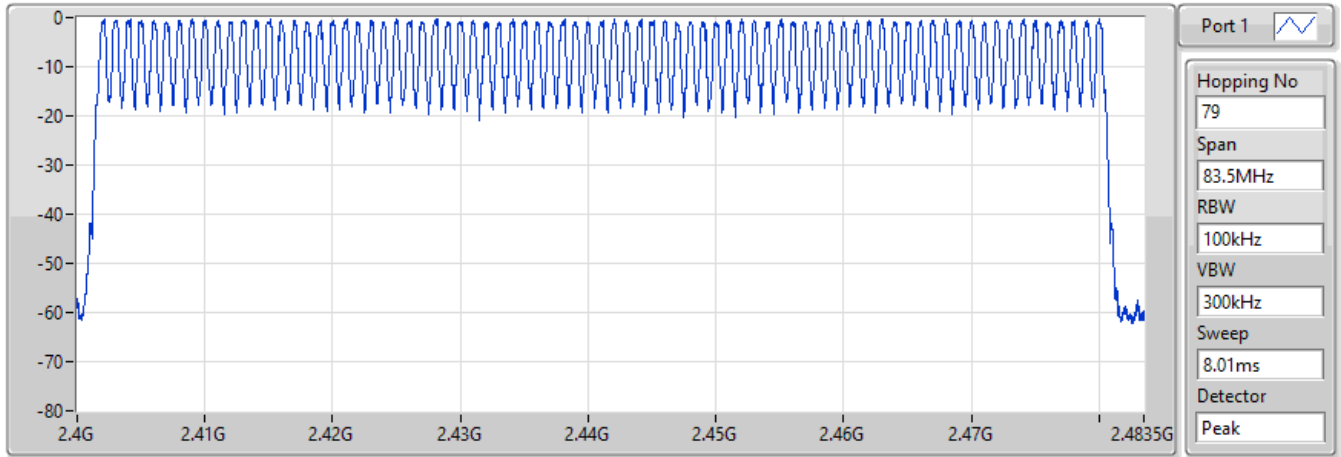

Hopping No	Limit
79	15

**2.4-2.4835GHz\_BT-EDR(2Mbps)**

**Hopping-FS**

**2402MHz**

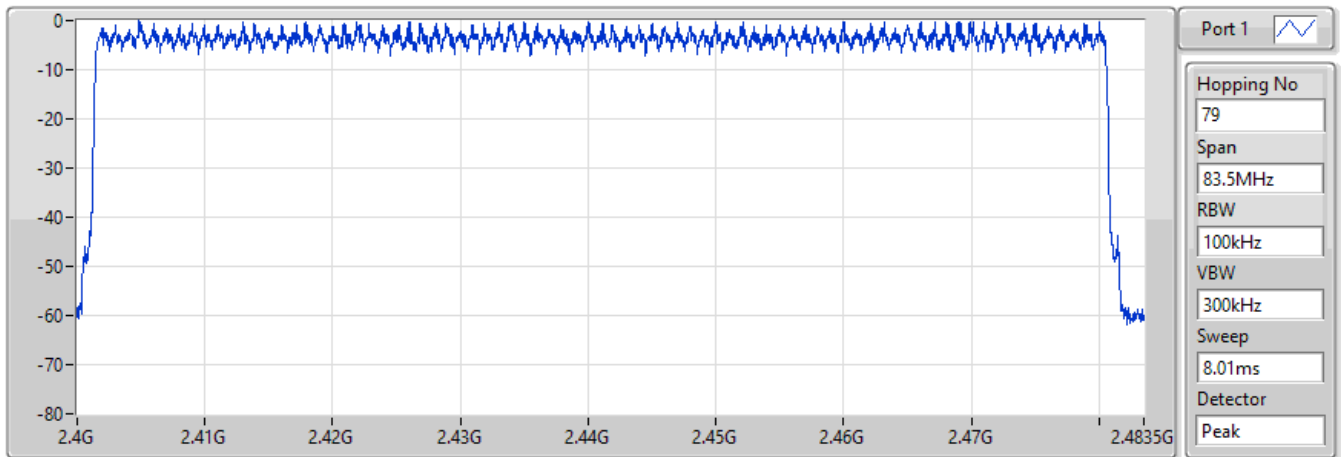

Hopping No	Limit
79	15



### 2.4-2.4835GHz\_BT-EDR(3Mbps)

### Hopping-FS

2402MHz

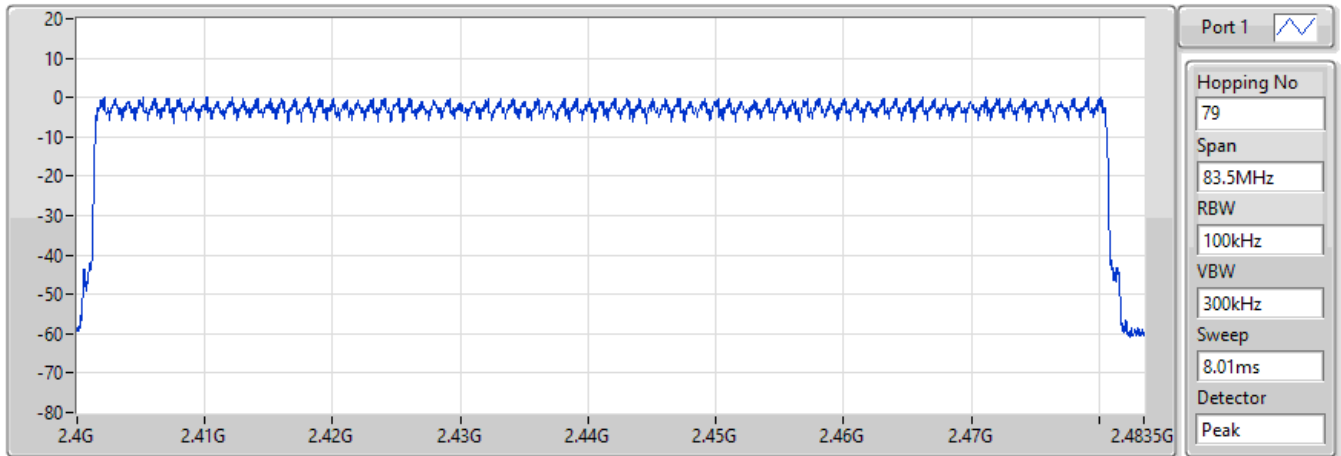

Hopping No	Limit
79	15



Summary

Mode	Max-N dB (Hz)	Max-OBW (Hz)	ITU-Code	Min-N dB (Hz)	Min-OBW (Hz)
2.4-2.4835GHz	-	-	-	-	-
BT-BR(1Mbps)	992.75k	844.615k	845KF1D	968k	841.698k
BT-EDR(2Mbps)	1.32M	1.168M	1M17G1D	1.284M	1.166M
BT-EDR(3Mbps)	1.304M	1.17M	1M17G1D	1.301M	1.168M

Max-N dB = Maximum 20dB down bandwidth; Max-OBW = Maximum 99% occupied bandwidth;  
Min-N dB = Minimum 20dB down bandwidth; Min-OBW = Minimum 99% occupied bandwidth

Result

Mode	Result	Limit (Hz)	Port 1-N dB (Hz)	Port 1-OBW (Hz)
BT-BR(1Mbps)	-	-	-	-
2402MHz	Pass	Inf	968k	841.698k
2441MHz	Pass	Inf	992.75k	843.199k
2480MHz	Pass	Inf	992.75k	844.615k
BT-EDR(2Mbps)	-	-	-	-
2402MHz	Pass	Inf	1.32M	1.168M
2441MHz	Pass	Inf	1.317M	1.167M
2480MHz	Pass	Inf	1.284M	1.166M
BT-EDR(3Mbps)	-	-	-	-
2402MHz	Pass	Inf	1.304M	1.169M
2441MHz	Pass	Inf	1.301M	1.168M
2480MHz	Pass	Inf	1.304M	1.17M

Port X-N dB = Port X 20dB down bandwidth;  
Port X-OBW = Port X 99% occupied bandwidth



2.4-2.4835GHz\_BT-BR(1Mbps)

EBW-FS

2402MHz

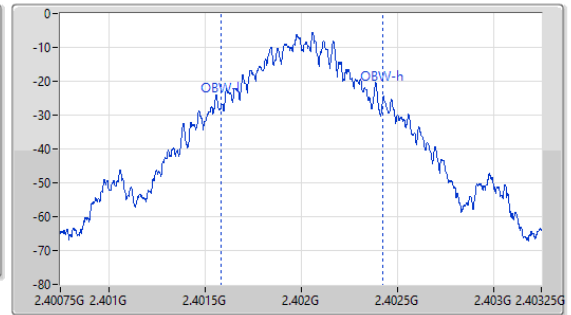
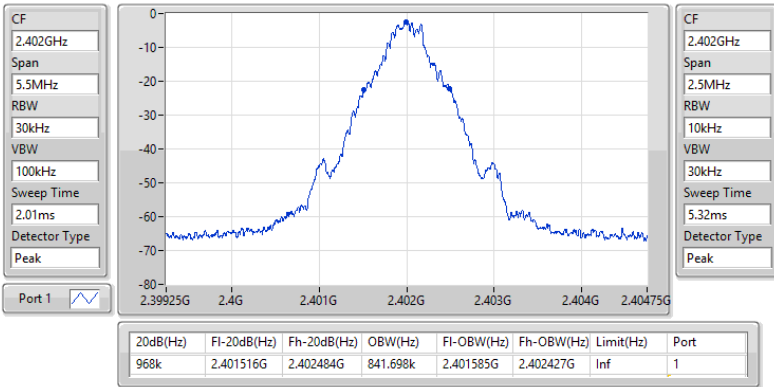

2.4-2.4835GHz\_BT-BR(1Mbps)

EBW-FS

2441MHz

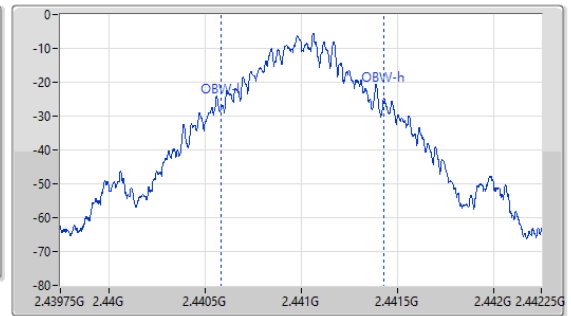
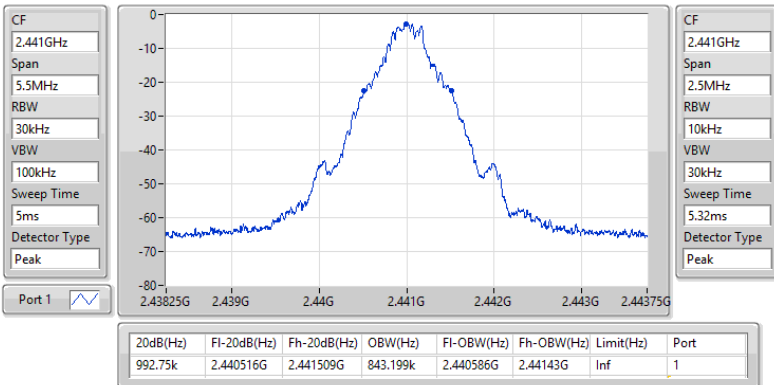



2.4-2.4835GHz\_BT-BR(1Mbps)

EBW-FS

2480MHz

CF  
2.48GHz  
Span  
5.5MHz  
RBW  
30kHz  
VBW  
100kHz  
Sweep Time  
2.01ms  
Detector Type  
Peak

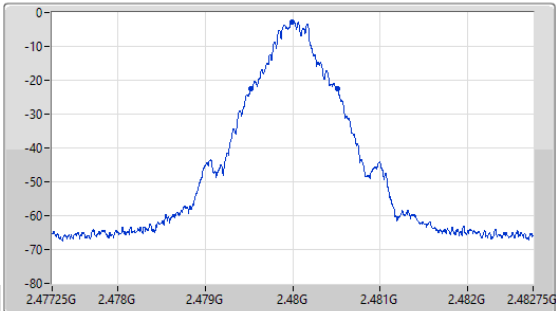

CF  
2.48GHz  
Span  
2.5MHz  
RBW  
10kHz  
VBW  
30kHz  
Sweep Time  
5.32ms  
Detector Type  
Peak

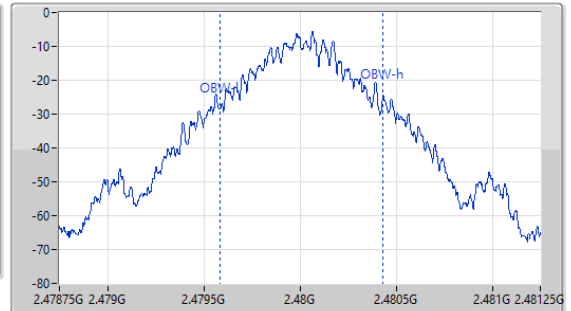

20dB(Hz)	Fl-20dB(Hz)	Fh-20dB(Hz)	OBW(Hz)	Fl-OBW(Hz)	Fh-OBW(Hz)	Limit(Hz)	Port
992.75k	2.479519G	2.480512G	844.615k	2.479587G	2.480432G	Inf	1

2.4-2.4835GHz\_BT-EDR(2Mbps)

EBW-FS

2402MHz

CF  
2.402GHz  
Span  
5.5MHz  
RBW  
30kHz  
VBW  
100kHz  
Sweep Time  
2.01ms  
Detector Type  
Peak

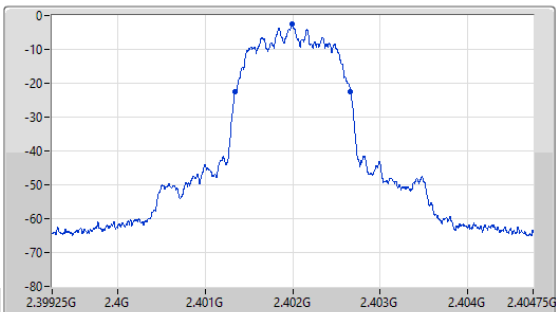

CF  
2.402GHz  
Span  
2.5MHz  
RBW  
20kHz  
VBW  
100kHz  
Sweep Time  
2.66ms  
Detector Type  
Peak

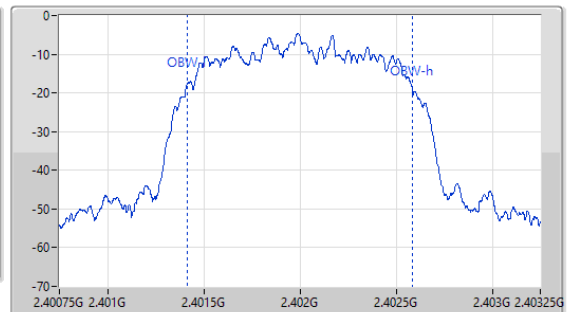

20dB(Hz)	Fl-20dB(Hz)	Fh-20dB(Hz)	OBW(Hz)	Fl-OBW(Hz)	Fh-OBW(Hz)	Limit(Hz)	Port
1.32M	2.401343G	2.402663G	1.168M	2.401418G	2.402586G	Inf	1



2.4-2.4835GHz\_BT-EDR(2Mbps)

EBW-FS

2441MHz

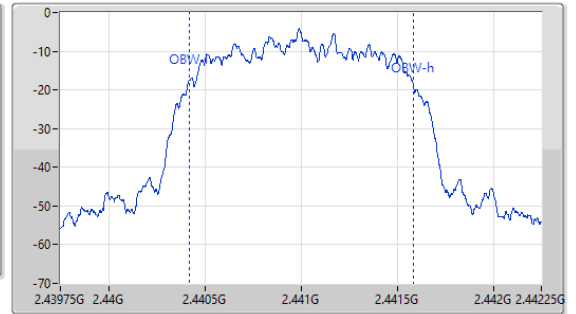

2.4-2.4835GHz\_BT-EDR(2Mbps)

EBW-FS

2480MHz

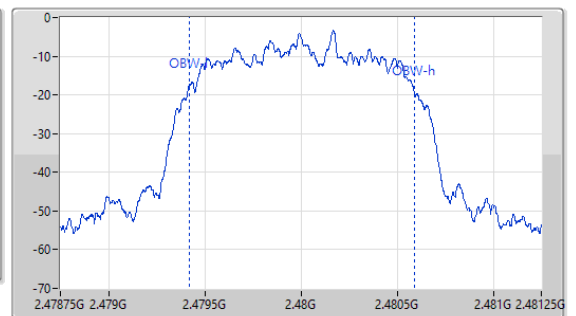
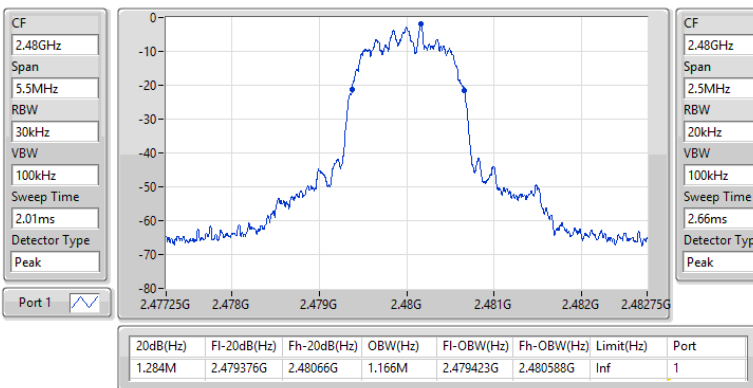



2.4-2.4835GHz\_BT-EDR(3Mbps)

EBW-FS

2402MHz

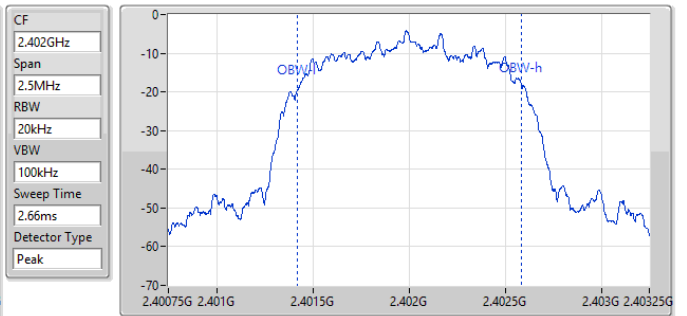
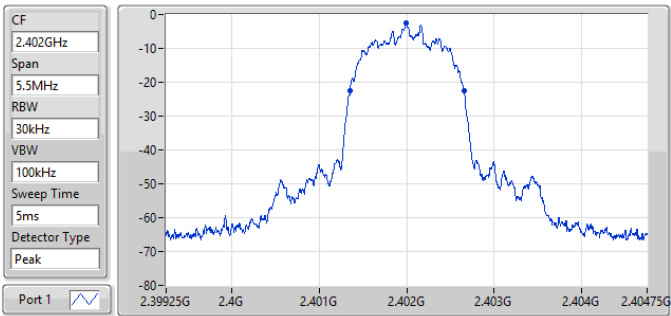

20dB(Hz)	Fl-20dB(Hz)	Fh-20dB(Hz)	OBW(Hz)	Fl-OBW(Hz)	Fh-OBW(Hz)	Limit(Hz)	Port
1.304M	2.401354G	2.402657G	1.169M	2.401419G	2.402588G	Inf	1

2.4-2.4835GHz\_BT-EDR(3Mbps)

EBW-FS

2441MHz

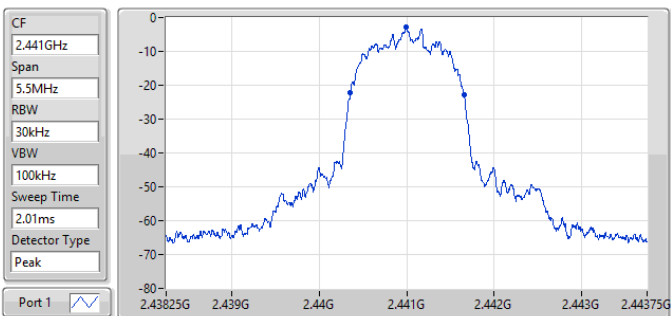

20dB(Hz)	Fl-20dB(Hz)	Fh-20dB(Hz)	OBW(Hz)	Fl-OBW(Hz)	Fh-OBW(Hz)	Limit(Hz)	Port
1.301M	2.440357G	2.441657G	1.168M	2.440421G	2.441589G	Inf	1





2.4-2.4835GHz\_BT-EDR(3Mbps)

EBW-FS

2480MHz

CF  
2.48GHz  
Span  
5.5MHz  
RBW  
30kHz  
VBW  
100kHz  
Sweep Time  
2.01ms  
Detector Type  
Peak

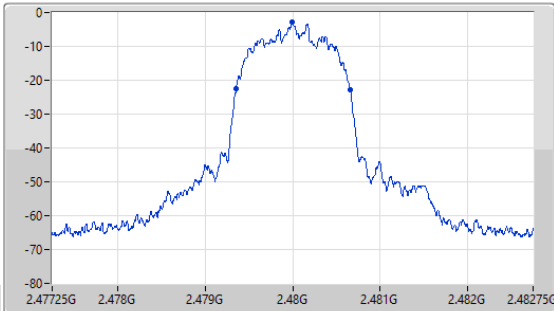

CF  
2.48GHz  
Span  
2.5MHz  
RBW  
20kHz  
VBW  
100kHz  
Sweep Time  
2.66ms  
Detector Type  
Peak

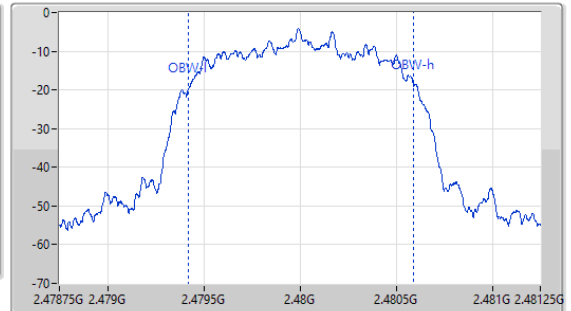

20dB(Hz)	F1-20dB(Hz)	Fh-20dB(Hz)	OBW(Hz)	F1-OBW(Hz)	Fh-OBW(Hz)	Limit(Hz)	Port
1.304M	2.479357G	2.48066G	1.17M	2.479422G	2.480591G	Inf	1



Summary

Mode	Max-Space (Hz)	Min-Space (Hz)
2.4-2.4835GHz	-	-
BT-BR(1Mbps)	1.002M	1.0005M
BT-EDR(2Mbps)	1.002M	1.0005M
BT-EDR(3Mbps)	1.0035M	1.0005M

Result

Mode	Result	Fl (Hz)	Fh (Hz)	Ch.Space (Hz)	Limit (Hz)
BT-BR(1Mbps)	-	-	-	-	-
2402MHz	Pass	2.401992G	2.402992G	1.0005M	644.688k
2441MHz	Pass	2.440996G	2.441997G	1.0005M	661.1715k
2480MHz	Pass	2.478996G	2.479998G	1.002M	661.1715k
BT-EDR(2Mbps)	-	-	-	-	-
2402MHz	Pass	2.401993G	2.402994G	1.0005M	879.12k
2441MHz	Pass	2.440993G	2.441995G	1.002M	877.122k
2480MHz	Pass	2.478995G	2.479995G	1.0005M	855.144k
BT-EDR(3Mbps)	-	-	-	-	-
2402MHz	Pass	2.401992G	2.402994G	1.002M	868.464k
2441MHz	Pass	2.440995G	2.441995G	1.0005M	866.466k
2480MHz	Pass	2.478995G	2.479998G	1.0035M	868.464k

2.4-2.4835GHz\_BT-BR(1Mbps)

Channel Separation-FS

2.402G/2.403GHz

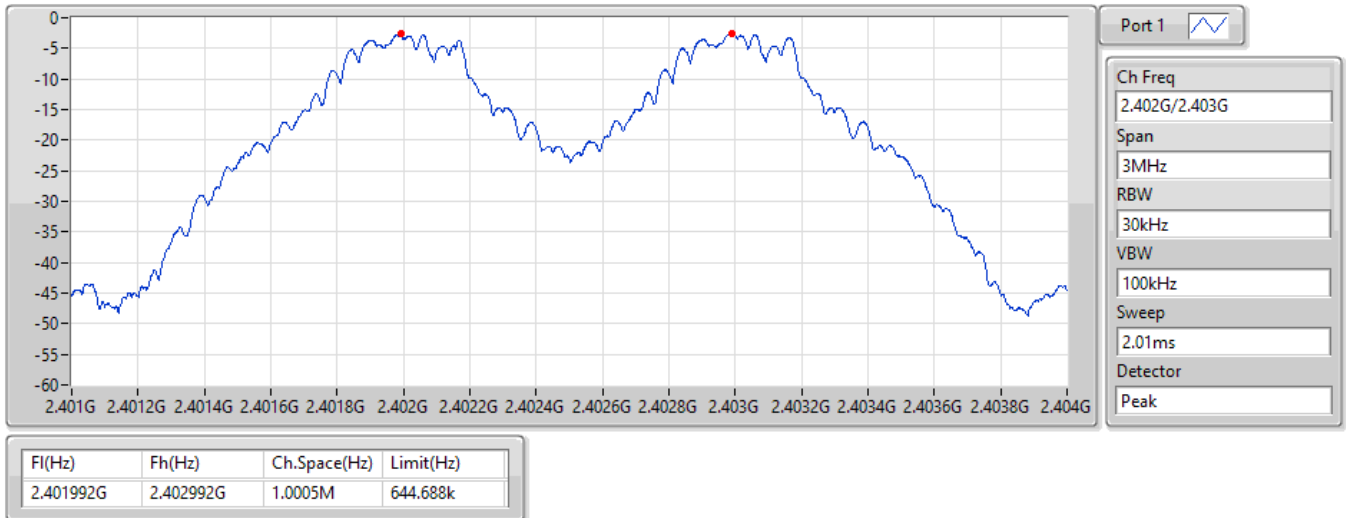

2.4-2.4835GHz\_BT-BR(1Mbps)

Channel Separation-FS

2.441G/2.442GHz

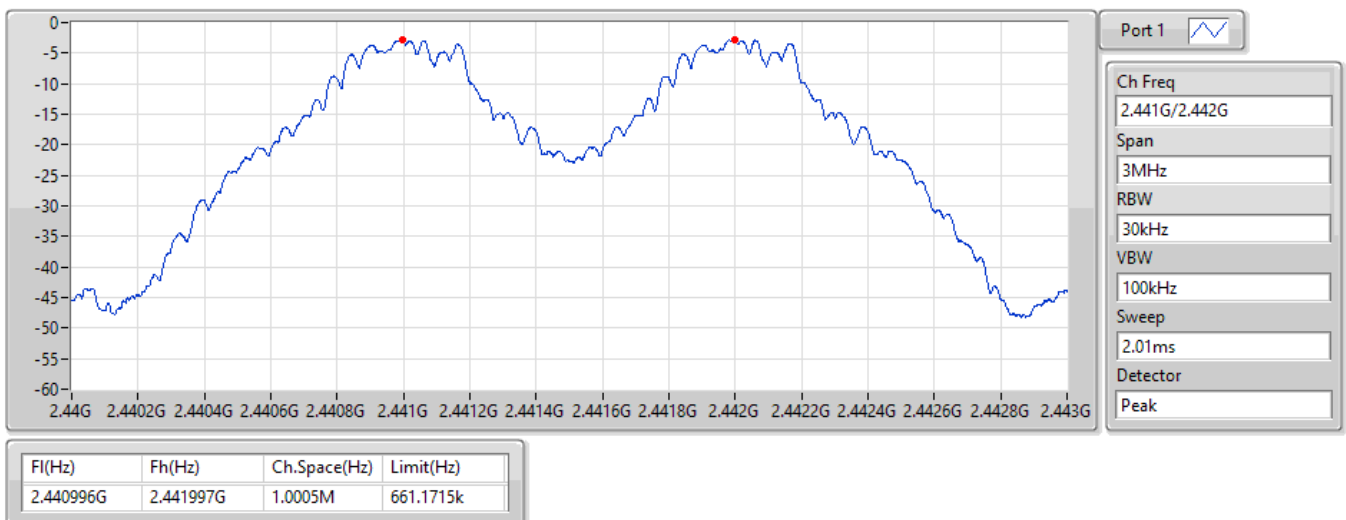

**2.4-2.4835GHz\_BT-BR(1Mbps)**

**Channel Separation-FS**

**2.48G/2.479GHz**



F1(Hz)	Fh(Hz)	Ch.Space(Hz)	Limit(Hz)
2.478996G	2.479998G	1.002M	661.1715k

**2.4-2.4835GHz\_BT-EDR(2Mbps)**

**Channel Separation-FS**

**2.402G/2.403GHz**

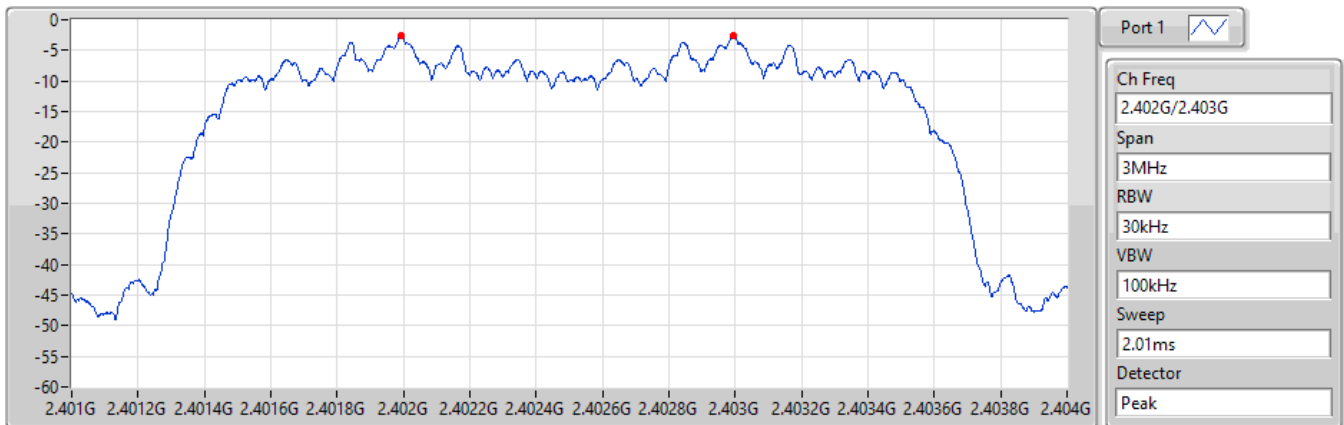

F1(Hz)	Fh(Hz)	Ch.Space(Hz)	Limit(Hz)
2.401993G	2.402994G	1.0005M	879.12k

2.4-2.4835GHz\_BT-EDR(2Mbps)

Channel Separation-FS

2.441G/2.442GHz

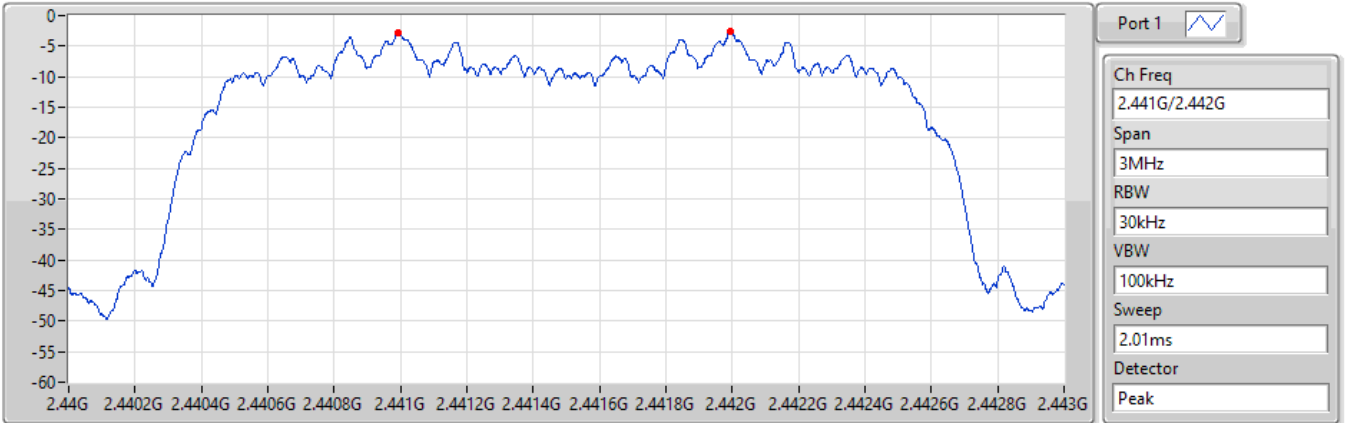

F1(Hz)	Fh(Hz)	Ch.Space(Hz)	Limit(Hz)
2.440993G	2.441995G	1.002M	877.122k

2.4-2.4835GHz\_BT-EDR(2Mbps)

Channel Separation-FS

2.48G/2.479GHz

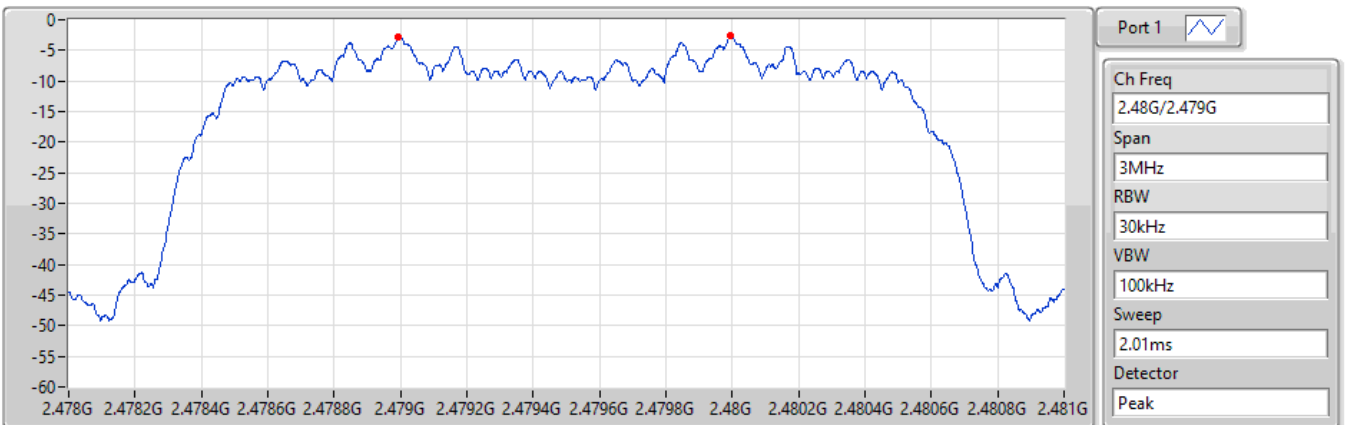

F1(Hz)	Fh(Hz)	Ch.Space(Hz)	Limit(Hz)
2.478995G	2.479995G	1.0005M	855.144k

**2.4-2.4835GHz\_BT-EDR(3Mbps)**

**Channel Separation-FS**

**2.402G/2.403GHz**

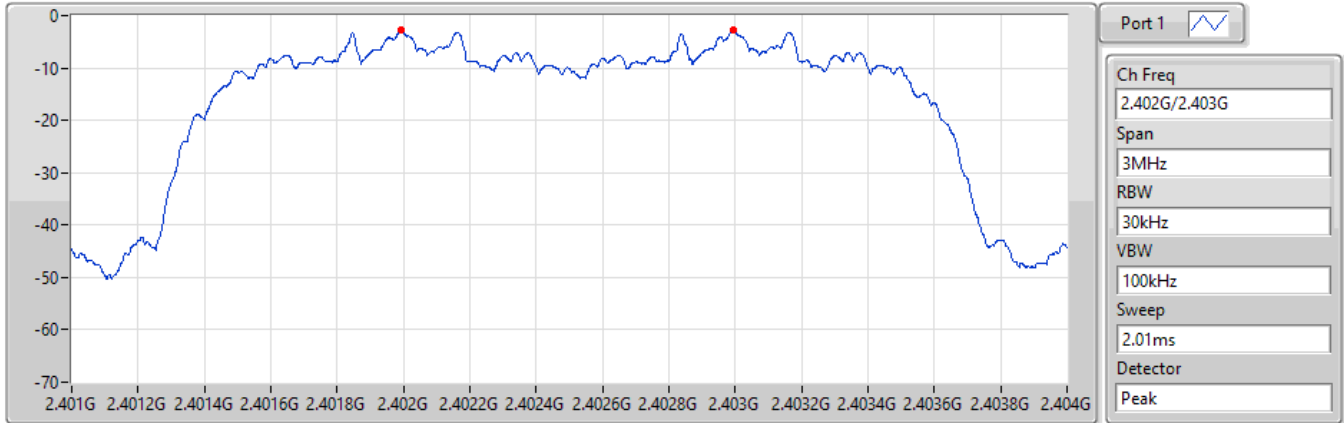

F1(Hz)	Fh(Hz)	Ch.Space(Hz)	Limit(Hz)
2.401992G	2.402994G	1.002M	868.464k

**2.4-2.4835GHz\_BT-EDR(3Mbps)**

**Channel Separation-FS**

**2.441G/2.442GHz**

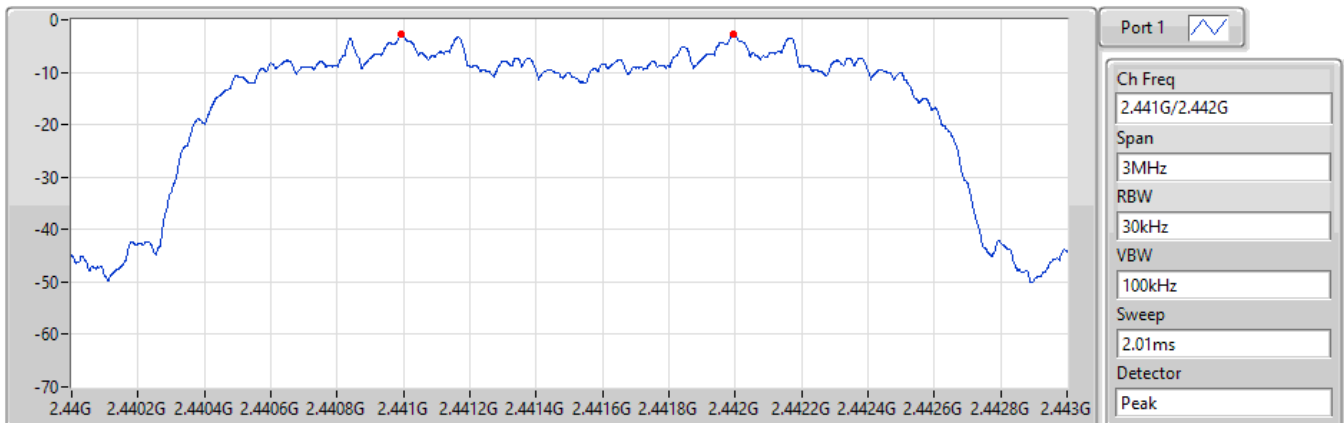

F1(Hz)	Fh(Hz)	Ch.Space(Hz)	Limit(Hz)
2.440995G	2.441995G	1.0005M	866.466k



### 2.4-2.4835GHz\_BT-EDR(3Mbps)

### Channel Separation-FS

2.48G/2.479GHz

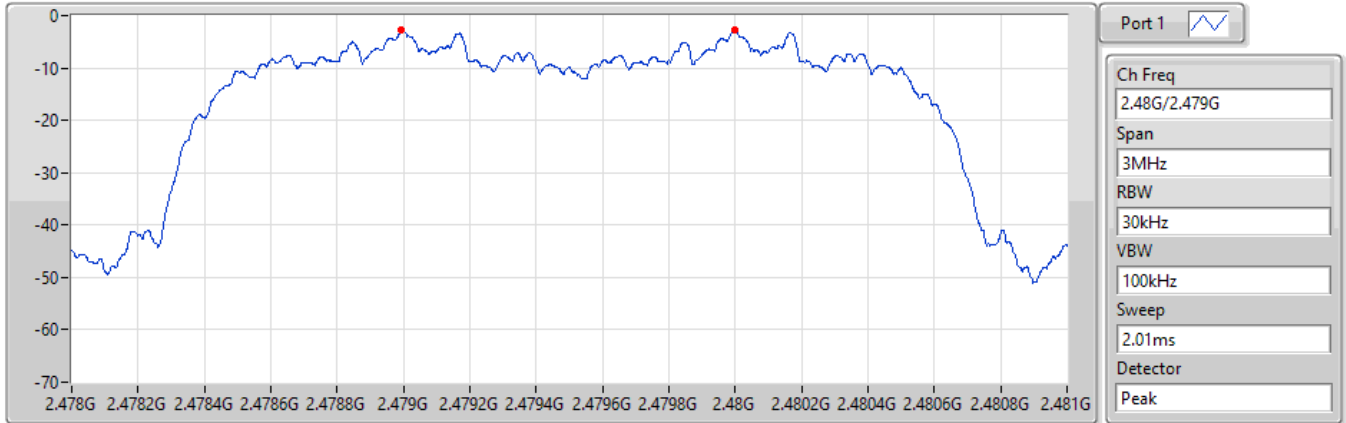

F1(Hz)	Fh(Hz)	Ch.Space(Hz)	Limit(Hz)
2.478995G	2.479998G	1.0035M	868.464k



Summary

Mode	Max-Dwell (s)
2.4-2.4835GHz	-
BT-BR(1Mbps)	347.06122m_DH5
BT-BR-AFH(1Mbps)	289.1m_DH5-AFH
BT-EDR(2Mbps)	310.7702m_DH5
BT-EDR-AFH(2Mbps)	317.304m_DH5-AFH
BT-EDR(3Mbps)	317.43148m_DH5
BT-EDR-AFH(3Mbps)	305.734m_DH5-AFH

Result/ Non AFH mode

Mode	Result	Period (s)	Dwell (s)	Limit (s)	Tx On (ms)	Number of transmission in a 5 s
BT-BR(1Mbps)	-	-	-	-	-	-
2402MHz_DH5	PASS	31.6	0.34706	0.4	2.89025	19
BT-EDR(2Mbps)	-	-	-	-	-	-
2402MHz_DH5	PASS	31.6	0.31077	0.4	2.89250	17
BT-EDR(3Mbps)	-	-	-	-	-	-
2402MHz_DH5	PASS	31.6	0.31743	0.4	2.95450	17

Note 1: Dwell time =Number of transmission in a 5 second x Tx On Time x 6.32

Note 2: DH5 was the worst mode.

Result/ AFH mode

Mode	Result	Period (s)	Dwell (s)	Limit (s)	Tx On (ms)	Number of transmission in a 2 s
BT-BR-AFH(1Mbps)	-	-	-	-	-	-
2402MHz_DH5	PASS	8	0.28910	0.4	2.89100	25
BT-EDR-AFH(2Mbps)	-	-	-	-	-	-
2402MHz_DH5	PASS	8	0.31730	0.4	2.93800	27
BT-EDR-AFH(3Mbps)	-	-	-	-	-	-
2402MHz_DH5	PASS	8	0.30573	0.4	2.93975	26

Note 1: Dwell time =Number of transmission in a 2 second x Tx On Time x 4

Note 2: DH5 was the worst mode.





2.4-2.4835GHz\_BT-BR(1Mbps)

Dwell-FS

2402MHz



2.4-2.4835GHz\_BT-EDR(2Mbps)

Dwell-FS

2402MHz

