

# Test Report 2024-020

**Version B**

**Issued 11 Apr 2024**

**Project GCL-0437**

**Model Identifier A04741**

**Primary Test Standard**

**CFR 47, FCC Part 15.247**

**RSS-247 Issue 3**

## **Garmin Compliance Lab**

**Garmin International**

**1200 E 151<sup>st</sup> Street**

**Olathe Kansas 66062 USA**

### **Client-supplied Information**

FCC ID: IPH-04741

IC ID: 1792A-04741



**See section 6 of this report regarding the presence or absence of accreditation logos or marks on this cover page.**

## 1. Summary

The equipment or product described in section 5 of this report was tested at the Garmin Compliance Lab according to standards listed in section 6. This report focuses on the 2.4 GHz DTS transceivers: WiFi, BLE, and ANT.

The product also includes a 2.4 GHz Bluetooth radio that is being certified under the FHSS rules. To aid the reader, we have moved the reporting of FHSS compliance into a separate report, GCL Test Report 2024-023. However, some of the test records in this report may also provide data for this Bluetooth radio. Please ignore any data for that Bluetooth radio that appear within the test records.

The results are as follows.

Parameter	Description	Key Performance Values	Result	Data starts at page
Radio Modulation	Summary of the kinds of communication this radio can achieve, as stated by the client. [RSS-GEN at Annex A item 10b]	Digitally modulated spread spectrum at rates as high as 72.2 Mbps.	Reported	N/A
Hopping Channels	The radio manages its use of channels appropriately. [15.247(a)(1); RSS-247 at 5.1]	N/A	N/A	N/A
DTS Bandwidth	The nature of the radio signal is broadband, being at least 500 kHz wide. [15.247(a)(2); RSS-247 at 5.2(a)]	The 6 dB bandwidth is 795.4 kHz or greater.	PASS	13
Other Bandwidths	Regulatory agencies also require the reporting of signal bandwidths using alternate processes. [2.202; RSS-GEN at 6.7]	These values are reported but have no actual performance requirements.	Reported	18
Transmit Power	The peak transmit power presented to the antenna is no greater than 1 Watt or 30 dBm. The effective radiated power is limited to 4 Watts or 36 dBm EIRP. [15.247(b); RSS-247 at 5.4(d)]	The maximum transmit power is 14.33 dBm or 26.93 mW.	PASS	25
Antenna Gain	The radio should not focus too much energy in any direction. Unless additional rules are applied, the antenna gain is no greater than 6 dBi. [15.247(b)(4) and (c)]	NT. The client stated that the antenna gain was 2.51 dBi and will document antenna gain separately.	NT	NT
Unwanted Emissions (Conducted Spurious)	The radio should not provide too much radio energy to the antenna at frequencies beyond its intended frequency band. [15.247(d); RSS-247 at 5.5]	Emissions outside the band must be reduced at least 20 dB from in-band levels. The measured reduction was at least 38.74 dB.	PASS	28
Restricted Bands	The radio must not emit in certain designated restricted frequency bands above a set of limit values. [15.247(d) and 15.205; RSS-247 at 3.3]	Emissions in the restricted bands were at least 11.21 dB below the applicable limits.	PASS	35
Power Spectral Density	The radio must not focus too much radio energy in a narrow frequency band.	The limit is 8 dBm in a 3 kHz band. The strongest emission	PASS	49

	[15.247(e); RSS-247 at 5.2(b)]	level was -1.18 dBm in a band of at least 3 kHz.		
Hybrid Systems	A radio that is both frequency hopping and digitally modulated should satisfy a combination of system rules. [15.247(f); RSS-247 at 5.3]	N/A. The radios described in this report are not subjected to the Hybrid System rules.	N/A	N/A
Frequency Hopping Rules	Frequency hopping systems have additional functional requirements. [15.247(g) and (h); RSS-247 at 5.1]	N/A. The radios described in this report are not subjected to the Frequency Hopping rules.	N/A	N/A
Radio Safety	The radio emissions must meet public health & safety guidelines related to human exposure. [15.247(i) and 1.1307; RSS-Gen at 3.4]	NT. Client will report radio energy safety results separately.	NT	NT
Frequency Stability	The radio tuning must be robust over a range of temperature and supply voltage conditions. [RSS-Gen at 6.11]	Radio emissions remained within the allowed radio band under all environmental conditions tested.	PASS	53
Unwanted Emissions (Radiated Spurious)	While transmitting, the radiated emissions must not be too strong. [15.209, RSS-Gen at 8.9]	Emissions other than the fundamental and harmonics must meet the 'Class B' limits. The measured emissions had at least 6 dB of margin.	PASS	59
Unwanted Emissions (Mains Conducted)	While transmitting, the emissions conducted into the power mains must not be too strong. [15.207, RSS-Gen at 8.8]	Emissions other than the fundamental and harmonics must meet the 'Class B' limits. The measured emissions had at least 20.09 dB of margin.	PASS	69

**NT** (Not Tested) means the requirement may or may not be applicable, but the relevant measurement or test was not performed as part of this test project.

**N/A** (Not Applicable) means the lab judged that the test sample is exempt from the requirement.

**Table 1: Summary of results**

Report Organization

For convenience of the reader, this report is organized as follows:

1. Summary
2. Test Background
3. Report History and Approval
4. Test Sample Modifications and Special Conditions
5. Description of Equipment Tested
6. Test Standards Applied
7. Measurement Instrumentation Uncertainty
8. Selected Examples of Calculations
9. Environmental Conditions During Test
10. Immunity Performance Criteria

Annex: Test records are provided for each type of test, following the order and page numbering stated in the summary table. Concluding notes appear on the final page of this report.

Due to confidentiality, certain material (such as test setup photographs) has been removed from this report and placed in GCL Test Report 2024-017. That report is treated as a part of this document by way of this reference.

## 2. Test Background

The testing reported here was performed at the Garmin Compliance Lab, an organization within Garmin International, located at 1200 E 151<sup>st</sup> St, Olathe Kansas, USA. The contact telephone number is +1.913.397.8200.

The testing was performed on behalf of the Garmin design group, a separate organization located at 1200 E 151<sup>st</sup> St, Olathe Kansas, USA. Witnesses from the business group included: None.

Test Sample received: 06 Nov 2023  
Test Start Date: 26 Jan 2024  
Test End Date: 21 Feb 2024

The data in this test report apply only to the specific samples tested.

Upon receipt all test samples were believed to be properly assembled and ready for testing.

## 3. Report History and Approval

This report was written by Aditya Prakash and initially issued on 14 Mar 2024 as Version A. Version B was created by Dave Arnett on 11 Apr 2024 to include an FVIN entry in section 5.2.

### Report Technical Review:

David Arnett  
Technical Lead EMC Engineer



---

### Report Approval:

Shruti Kohli  
Manager Test and Measurement (EMC, Reliability and Calibration)

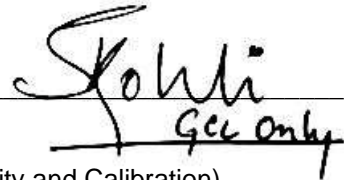

---

## 4. Test Sample Modifications and Special Conditions

The following special conditions or usage attributes were judged during test to be necessary to achieve compliance with one or more of the standards listed in section 6 of this report:  
None

The following modifications to the test sample(s) were made, and are judged necessary to achieve compliance with one or more of the standards listed in section 6 of this report:  
None

## 5. Description of the Equipment Tested

### 5.1 Unique Identification

Product Model A04741  
Serial Numbers Tested 457910369, 457910428

This product tested is a Digital device and low power data transceiver.

The client affirmed that the test samples will be representative of production in all relevant aspects.

### 5.2 Key Parameters

EUT Input Power: 5 Vdc  
I/O Ports: USB / Docking port  
Radio Transceivers: IEEE 802.11 b/g/n, Bluetooth, Bluetooth Low Energy, ANT/ANT+, NFC  
Radio Receivers: Not evaluated in this report  
Primary Functions: Digital device that processes data received from and transmitted to nearby low power transceivers.  
Typical use: Remotely mounted Portable device  
Highest internal frequency: 2.480 GHz  
Firmware Revision: 6.00  
FVIN: V6.00

### 5.3 Operating modes

During test, the EUT was operated in one or more of the following modes.

Mode 1: M1 (Bt Tx). Bluetooth, sometimes called Bluetooth Classic, radio is transmitting consistently on a selected channel sending data using the BR (Basic Rate of 1 Mbps), EDR2 (Extended Data Rate of 2 Mbps) or EDR3 (Extended Data Rate of 3 Mbps) modulation types.

Mode 2: M2 (Bt Ink). Bluetooth Classic radio is paired to a companion device, transmitting and receiving data on various channels in accordance with the protocol, and maintaining the paired relationship.

Mode 3: M3 (Ble Tx). Bluetooth Low Energy radio transmitting consistently on a selected channel at 1 Mbps or 2 Mbps

Mode 4: M4 (Ble Ink). Bluetooth Low Energy radio is paired to a companion device, transmitting and receiving data on various channels in accordance with the protocol, and maintaining the paired relationship.

Mode 5: M5 (ANT Tx). ANT radio transmitting consistently on a selected channel.

Mode 6: M6 (ANT Ink). ANT radio is paired to a companion device, transmitting and receiving data in accordance with the protocol, and maintaining the paired relationship.

Mode 7: M7 (Wifi Tx). The IEEE 802.11 b/g/n radio was transmitting consistently on a selected channel, with a specified modulation type, and data rate

Mode 8: M8 (Wifi Lnk). The IEEE 802.11 b/g/n radio is paired to a companion device, transmitting and receiving data on a selected channel in accordance with the protocol, and maintaining the paired relationship.

Mode 9: M9 (Rx2.4). The radio was set to receive 2.4 GHz signals but not transmit. In this situation, it was specifically looking for Bluetooth Low Energy signals which cover the 2.4 GHz band and represent a worst-case scenario.

Mode 10: M10 (All2.4). All or some of 2.4 G radios are on and transmitting. Combination of M1, M3, M5, and M7.

Mode 11: M13 (All 2.4G Ink). All 2.4 G radios are on and linked. Combination of M2, M4, M6, and M8.

## 5.4 EUT Arrangement

During test, the EUT components and associated support equipment were selected including the following arrangement sets.

Arrangement 1: A1 (Stl). The test sample operates from its battery and no external physical connections. No block diagram is needed for this arrangement.

Arrangement 2: A2 (PM AC). The test sample mounted on a Power bank. The Power bank is being charged by an AC Adaptor.

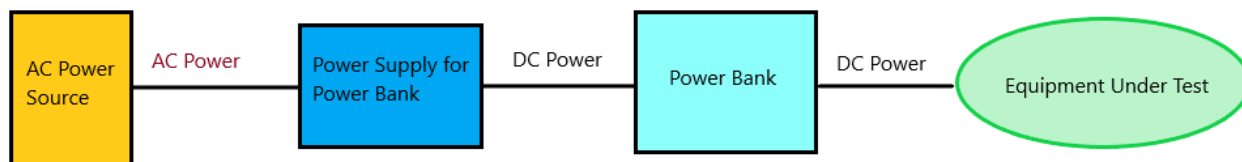

*The interconnect drawing is not to scale.  
It does not indicate placement of devices.*

**Figure 1: Block diagram of equipment arrangement A2**

Arrangement 3: A4 (USB adaptor). The test sample is attached to USB adaptor which is connected to AC mains. The adaptor provides power to the sample over a cable but no user data. See the block diagram in Figure 2.

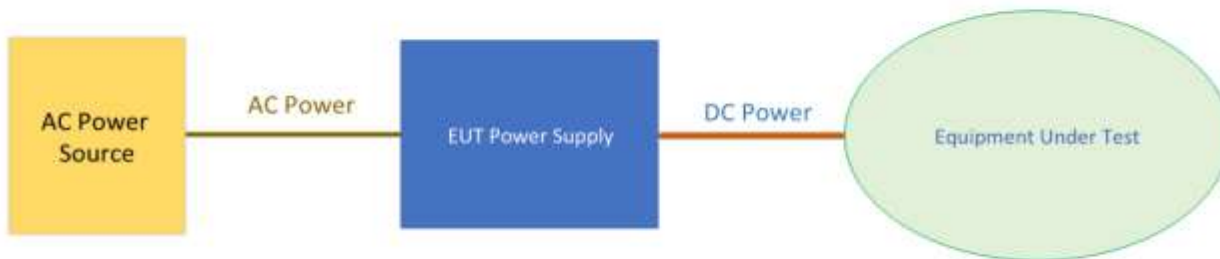

*This interconnect drawing is not to scale.  
It does not indicate the placement of devices.*

**Figure 2: Block diagram of equipment arrangement A4**

Arrangement 4: A5 (USB PC). The test sample is connected to PC through its USB C port. The PC is providing the power to the device as well as data is being transferred between the test sample and the PC.

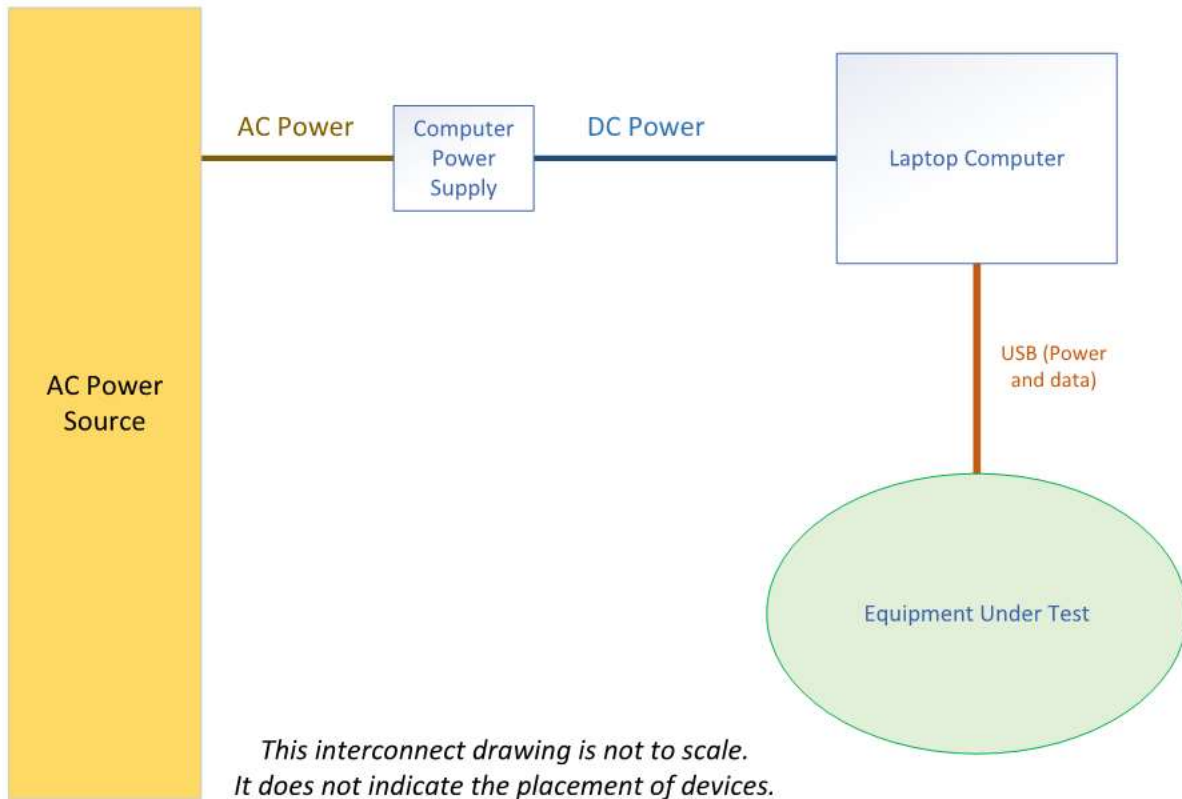

**Figure 3: Block diagram of equipment arrangement A5**

Arrangement 5: A9 (NFC). The test sample is placed near an NFC Card Reader. The NFC Card Reader is connected to a laptop computer. The test sample is powered by a device that does not include data over the cable, just as with A2. For clarity, test sample is NOT powered by, or connected to, the laptop computer that powers the NFC Card Reader.

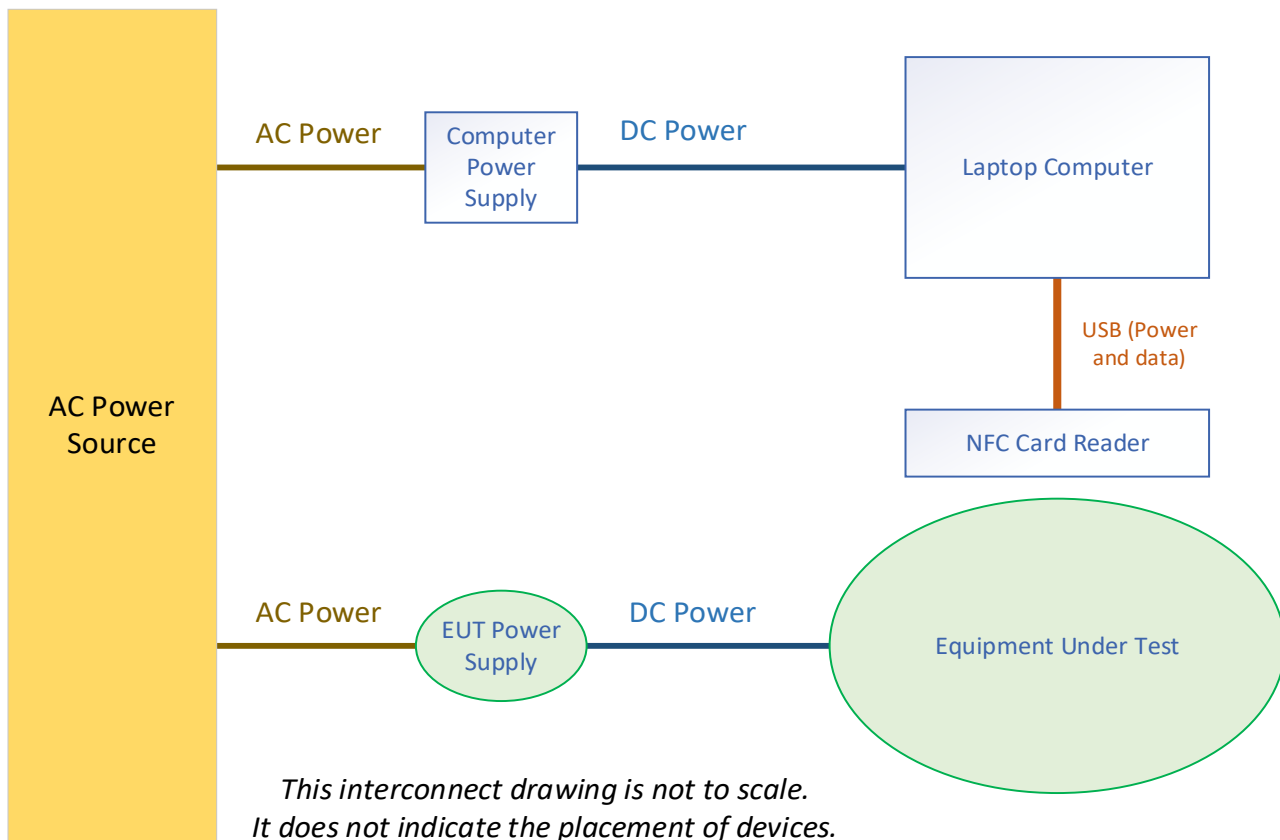

**Figure 4: Block diagram of equipment arrangement A9**

**5.5 Associated Equipment (AE) used**

Description	Manufacturer	Model	Serial Number
NFC reader	ACS	ACR1252	RR554-086776
Laptop Computer	Dell	Latitude 5410	5VSPFB3
AC Power Adaptor	Phihong technology	PSAF10R-050Q	2308300616A2
Power Bank	Garmin	Power Bank Accessory	577026847
Laptop Power Supply	Dell	HA65NM191	None
Phone	Samsung	SM-J700T	R58H8080GJF
Watch	Garmin	Enduro 2-modified watch	3400414926
Wi-Fi Adaptor	Alpha network	AWUS036ACS	21BP036AC8259
Audio Headset	Garmin	DEZL Headset 200	783010366

**Table 2: List of associated equipment that may have been used during test**

**5.6 Cables used**

Description	From	To	Length	EMC Treatment
USB Cable	EUT	AC Adaptor/PC	56 cm	None

**Table 3: List of cables that may have been used during test**



## 6 Test Standards Applied

### 6.1. Accredited Standards

The following test or measurement standards were applied and are within the scope of the lab's accreditation. All results in this report that cite these standards are presented as Accredited results consistent with ISO/IEC 17025.

AS/NZS 4268: 2017  
CFR 47, FCC Part 15.247  
ANSI C63.10: 2013 and ANSI C63.10: 2020  
RSS-GEN Issue 5 Amd 2  
RSS-247 Issue 3

### 6.2. Non-accredited Standards

The following test or measurement standards were applied and are either outside the scope of the lab's accreditation, or were performed in such a way that results are not presented as being fully accredited.

(None)

### 6.3 Variances

The following variances were applied to standards cited in this section.

Where different test standards cover the same test parameter or phenomenon, and the standards have compatible differences, the stricter of the requirements is typically applied. For example, a consolidated limit may be applied to emission tests selecting the strictest of the limits at each frequency. Likewise, if one standard requires a vertical antenna sweep with boresighting and another does not, swept motion with boresighting will typically be used as it is the more stringent requirement.

### 6.4 Laboratory Accreditation

The Garmin Compliance Lab, an organization within Garmin International, is registered with the US Federal Communication Commission as US1311. The lab is recognized by the Canada Department of Innovation, Science, and Economic Development (ISED) under CAB identifier US0233.

The Garmin Compliance Lab, an organization within Garmin International, is accredited by A2LA, Certificate No. 6162.01. The presence of the A2LA logo on the cover of this report indicates this is an accredited ISO/IEC 17025 test report. If the logo is absent, this report is not issued as an accredited report. Other marks and symbols adjacent to the A2LA logo are accreditation co-operations of which A2LA is a member under a mutual recognition agreement, and to which the Garmin Compliance Lab has been sublicensed.

## 7 Measurement Instrumentation Uncertainty

The lab has analyzed the sources of measurement instrumentation uncertainty. The analysis concludes that the actual measurement values cited in this report are accurate within the  $U_{LAB}$  intervals shown below with approximately 95% statistical confidence. Where the report shows a judgment that a test sample passes a test against a published limit based on these measured values, that judgment has a statistical confidence of 97.5% or greater. Measurement Instrumentation Uncertainty is one component of over-all measurement uncertainty, and other uncertainty components are not considered as part of this analysis.

The primary benchmark for measurement instrumentation uncertainty (MIU) in an electromagnetic compatibility (EMC) test lab is the set of  $U_{CISPR}$  values published in CISPR 16-4-2. In all cases where a  $U_{CISPR}$  value is published by CISPR, the analysis shows that  $U_{LAB}$  – this lab’s estimated MIU – is better than the  $U_{CISPR}$  benchmark.

The secondary benchmark for MIU in an EMC lab performing radio transceiver tests is a set of uncertainty limit values published in various ETSI standards. In this report,  $U_{ETSI}$  is the most restrictive of the values found in the ETSI EN standards listed in section 5 of this report. The analysis principles are described in the ETSI TR documents listed there. In most cases  $U_{LAB}$  is better than the  $U_{ETSI}$  benchmark. Where  $U_{LAB}$  exceeds the  $U_{ETSI}$  benchmark cited here, that entry is preceded by an asterisk. When required by the ETSI EN standards, excess uncertainty will be added to the measurand before comparison to a limit. In an individual test report, staff may re-evaluate that excess uncertainty based on the uncertainty of the method used and the uncertainty limits of the actual ETSI EN standard being applied, and the revised uncertainty values will be shown in the test report.

Some measurement uncertainties analyzed and reported here are not addressed in CISPR 16-4-2 or the ETSI standards, as indicated by the entry ‘None.’

Test Type	$U_{LAB}$	$U_{CISPR}$	$U_{ETSI}$
Conducted DC voltage	0.09% + 2 x LSDPV	None	1%
Conducted AC voltage below 500 Hz	1.0% + 3 x LSDPV	None	2%
Conducted Emissions, Mains Voltage	0.10% + 10 mV	None	None
Conducted Emissions, Mains Current	0.10% + 3 mA	None	None
Conducted Emissions, Mains Power	0.15% + 100 mW	None	None
Conducted Emissions, Power Mains, 9 kHz to 150 kHz	1.49 dB	3.8 dB	None
Conducted Emissions, Power Mains, 150 kHz to 30 MHz	1.40 dB	3.4 dB	None
Conducted Emissions, Cat 6 LCL, 150 kHz to 30 MHz	2.80dB	5 dB	None
Conducted Emissions, Cat 5 LCL, 150 kHz to 30 MHz	3.21 dB	5 dB	None
Conducted Emissions, Cat 3 LCL, 150 kHz to 30 MHz	4.24 dB	5 dB	None
Radiated Emissions, below 30 MHz	0.88 dB	None	6 dB
Radiated Emissions, 30 MHz to 1000 MHz	2.77 dB	6.3 dB	6 dB
Radiated Emissions, 1 GHz to 18 GHz	2.60 dB	5.2 & 5.5 dB	6 dB
Radiated Emissions, 18 GHz to 26.5 GHz	2.73 dB	None	6 dB
*Radio Signal Frequency Accuracy	*1.55 x 10 <sup>-7</sup>	None	1.0 x 10 <sup>-7</sup>
Radio Signal Occupied Bandwidth	0.95%	None	5%
Radio Power or Power Spectral Density	0.98 dB	None	1 dB
Temperature	0.38 °C	None	1 °C
Barometric Pressure	0.38 kPA	None	None
Relative Humidity	2.85% RH	None	±5% RH
Signal Timing	The greater of these three... 0.63 usec 0.01% of value 0.5 x LSDPV	None	None

**Note:** LSDPV stands for the Least Significant Digit Place Value reported. In the value 1470 msec, the least significant digit is the 7. It has a 10 msec place value. The LSDPV is thus 10 msec and the maximum error due to roundoff would be 5 msec. If the time value were reported as 1470 msec, the underscore indicates that the 0 is a significant figure and the error due to roundoff would be 0.5 msec. All digits provided to the right of a decimal point radix are significant.

## 8 Selected Example Calculations

Certain regulators require samples of the calculations that lead from the raw measurement to the final result for AC Mains conducted and unintended radiated emissions. The assumption is that the lab performs raw measurements, then adds, subtracts, multiplies, or divides based on transducer factors, amplifier gains, and losses in the signal transmission path. In this lab, our CISPR 16 Receiver does not work that way. The calibration factors and losses and gains are provided to the receiver as detailed data files. These factors are applied in the RF measurement path prior to the detector. But as a step in the lab measurement process, staff frequently verify that these factors are applied correctly. They make a measurement with the factors applied inside the receiver, then they disable the factors and remeasure the result manually adding in the various relevant factors.

The transmission loss is measured including the combined losses and gains of preamplifiers, cables, and any band-selective filters. In many cases above 1 GHz it is a negative value, indicating that the preamplifier gain is greater than these other losses.

Here are examples of these calculations. The data in these examples was not taken as part of this project:

### 8.1 AC Mains conducted emissions at 22 MHz

(Raw measurement) + (AMN factor) + (transmission loss) = Result

$$(7.145 \text{ dBuV}) + (9.812 \text{ dB}) + (0.216 \text{ dB}) = 17.173 \text{ dBuV}$$

### 8.2 Radiated Emissions at 630 MHz

(Raw measurement) + (Antenna factor) + (transmission loss) = Result

$$(2.25 \text{ dBuV}) + (27.80 \text{ dB/m}) + (2.89 \text{ dB}) = 32.94 \text{ dBuV/m}$$

### 8.3 Radiated Emissions at 2.7 GHz

(Raw measurement) + (Antenna factor) + (transmission loss) = Result

$$(43.72 \text{ dBuV}) + (32.22 \text{ dB/m}) + (-36.09 \text{ dB}) = 39.85 \text{ dBuV/m}$$

## 9 Environmental Conditions During Test

Environmental conditions in the test lab were monitored during the test period. Temperature and humidity are controlled by an air handling system. As information to the reader, the conditions were observed at the values or within the ranges noted below. For any tests where environmental conditions are critical to test results and require further constraints or details, the test records in the annex may provide more specific information.

Temperature:	21.3 to 23.3 °C
Relative Humidity:	28.6% to 49.9% (non-condensing)
Barometric Pressure	96.7 to 99.4 kPa

Description	Make	Model #	Serial #	Last Cal/Ver	Next Due
Barometer	Traceable	6453	221702700	3-Aug-2022	1-Aug-2024

Table 4: Environmental monitoring device

## 10 Immunity Performance Criteria

If this report includes immunity tests then results have been categorized as Performance Criteria A, B, C, or D. The standards that the lab applied will define the details for A, B, and C, as well as which criterion is required for each type of test. They will also define the electrical stresses that were applied during each test. In a very general sense the observed criteria noted in this report are as follows:

Criterion A. The stress applied did not alter product operation. This criterion is generally used for 'continuous' stresses that can be present for a long time in the places the product will be used, or that can appear often, even though they may come and go over time.

Criterion B. The stress applied altered product operation, but the product self-recovered so that the user would not have to try to figure out how to restore it to full operation. This criterion is generally used for 'transient' stresses that appear briefly and occasionally, but are usually not present in the places the product will be used.

Criterion C. The stress applied altered product operation, but the user could restore it to full operation, for example by power cycling the product. This criterion is generally used for 'transient' stresses that appear briefly and only rarely in the places the product will be used.

Criterion D. This is not an official criterion in the standards, because it would be a failure of the requirements. This indication in a test record means the product was affected in a way that the user might not be able to correct. The effect could include some degree of hardware damage, or it could include loss of program files or data files necessary for operation.

Repeatability is an issue in all EMC immunity work. When the product operation changes unexpectedly during a test, and the change would fail the requirements of the standard, this is an anomaly. The test operator needs to determine whether the anomaly was a result of the applied electrical stress. The investigation is done by repeating the section of the test where the anomaly occurred three times. If the same or a similar anomaly occurs in any of the three repeat trials, it is confirmed as a response to the stress. If not, the anomaly is judged unreproducible and is not considered when judging the A, B, or C observed performance. Since there is usually no ability to confirm a Criterion D anomaly, these are usually treated as Criterion D upon a single occurrence.

Tests that require Criterion B performance will be judged to Pass if criteria A or B is observed. Similarly, tests that require Criterion C performance will be judged to Pass if criteria A, B, or C is observed.

## ANNEX

The remainder of this report is an Annex containing individual test data records. These records are the basis for the judgments summarized in section 1 of this report. The Annex ends with a set of concluding notes regarding use of the report.

**Test Record**  
**Transmitter Bandwidth Tests**  
**Test IDs TR07-TR09**  
**Project GCL-0437**

Test Date(s) 31 Jan, 1 Feb 2024  
 Test Personnel Jim Solum

Product Model A04741  
 Serial Number tested 457910428

Operating Mode M1 (Bt Tx), M3 (Ble Tx), M5 (ANT Tx), M7 (Wifi Tx)  
 Arrangement A4 (USB adaptor)  
 Input Power 5Vdc

Test Standards: FCC Part 15, ANSI C63.10, RSS-GEN (as noted in Section 6 of the report).

Radio Protocol Bluetooth Low Energy (BLE), ANT and IEEE 802.11b/g/n  
 Radio Band 2400 to 2483.5 MHz

**Pass/Fail Judgment: PASS**

**Test record created by: Jim Solum**  
**Date of this record: 2 Feb 2024**

Original record, Version A.

**Test Equipment Used**

Description	Make	Model #	Serial #	Last Cal/Ver	Next Due
PXE Receiver 44GHz	Keysight	N9048B	MY62220139	30-Jan-2023	6-Mar-2024

**Table TR07.1: List of test equipment used**

**Test Software Used:** Keysight PXE firmware A.33.03

**Test Method**

During this test the transmitter output is fed directly, or through RF attenuators, to the spectrum analyzer. The analyzer has a built-in capability to identify the minimum bandwidth that contains a specified portion of the total power observed, and also identify parameters such as the edge frequencies for that bandwidth and the center frequency error. The spectrum is scanned many times so that the varied effects of modulation are appropriately assessed. Since the focus is on the relative distribution of energy across a range of frequencies, the absolute amplitudes recorded during this test are not relevant and may not include cable losses or attenuation factors.

For BLE operating at 2 Mbps, the lowest operating frequency was 2404 MHz, and the highest operating frequency was 2478 MHz. For all other non-WiFi radios reported here, the lowest operating frequency was 2402 MHz, and the highest operating frequency was 2480 MHz.

**Test Setup**

This block diagram shows the test equipment setup.

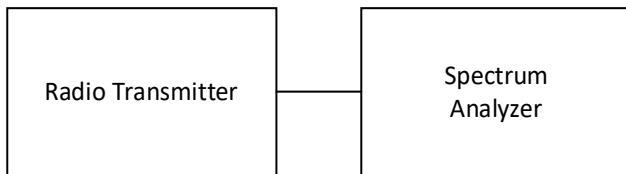

**Figure TR07.1: Test setup**

**Test Data**

The data for each test is summarized below, followed by the spectral data for each case highlighted in yellow. Grey 'NT' entries indicate channels or speeds that were not selected for measurement per the design of the experiment.

The DTS Bandwidth is measured using a spectrum analyzer operating with a defined resolution bandwidth. The analysis finds the smallest continuous range of frequencies containing all emissions within 6 dB of the highest value. The requirement is that the DTS Bandwidth be greater than 500 kHz. As such the lowest measured bandwidth is worst case. All radios reported here are judged to have met this requirement.

	2402 (04)	2440	2480 (78)
BLE 1 Mbps	795.4	811.6	857.7
BLE 2 Mbps	1427.0	1438.0	1752.0
ANT	905.7	820.6	879.5

**Table TR07.2: Summary of bandwidth data in MHz for BLE and ANT modes**

	Ch1	Ch6	Ch11	Ch12	Ch13
B1	NT	9.573	NT	NT	NT
B2	NT	9.304	NT	NT	NT
B5.5	8.778	8.574	8.775	8.774	8.366
B11	NT	9.048	NT	NT	NT
G6	16.500	16.410	16.510	16.490	16.510
G9	NT	16.570	NT	NT	NT
G12	NT	16.540	NT	NT	NT
G18	NT	16.520	NT	NT	NT
G24	NT	16.520	NT	NT	NT
G36	NT	16.510	NT	NT	NT
G48	NT	16.510	NT	NT	NT
G54	NT	16.540	NT	NT	NT
NMCS0	NT	17.610	NT	NT	NT
NMCS1	NT	17.560	NT	NT	NT
NMCS2	17.400	17.360	17.540	17.600	17.470
NMCS3	NT	17.620	NT	NT	NT
NMCS4	NT	17.600	NT	NT	NT
NMCS5	NT	17.610	NT	NT	NT
NMCS6	NT	17.670	NT	NT	NT
NMCS7	NT	17.590	NT	NT	NT

**Table TR07.3: Summary of bandwidth data in MHz for IEEE 802.11 WiFi modes**



Figure TR07.2: Bandwidth data for BLE 1 at low channel (2402 MHz)



Figure TR07.3: Bandwidth data for ANT at mid channel (2440 MHz)



Figure TR07.4: Bandwidth data for 802.11b 5.5 Mbps at channel 13



Figure TR07.5: Bandwidth data for 802.11g 6 Mbps at channel 6





Figure TR07.6: Bandwidth data for 802.11n MCS2 at channel 6

This line is the end of the test record.

**Test Record**  
**Transmitter Bandwidth Tests**  
**Test IDs TR10-TR13**  
**Project GCL0437**

Test Date(s) 31 Jan, 1 Feb 2024  
 Test Personnel Jim Solum

Product Model A04741  
 Serial Number tested 457910428

Operating Mode M1 (Bt Tx), M3 (Ble Tx), M5 (ANT Tx), M7 (Wifi Tx)  
 Arrangement A4 (USB adaptor)  
 Input Power 5 Vdc

Test Standards: FCC Part 2.202, ANSI C63.10, TRC-43, RSS-GEN (as noted in Section 6 of the report).

Radio Protocol Bluetooth Classic (Including EDR2 and EDR3), Bluetooth Low Energy (BLE), ANT, IEEE 802.11 b/g/n (WiFi)

Radio Band 2400 to 2483.5 MHz

**Pass/Fail Judgment: Reported**

**Test record created by: Jim Solum**  
**Date of this record: 2 Feb2024**

Original record, Version A.

**Test Equipment Used**

Description	Make	Model #	Serial #	Last Cal/Ver	Next Due
PXE Receiver 44GHz	Keysight	N9048B	MY62220139	30-Jan-2023	6-Mar-2024

**Table TR10.1: List of test equipment used**

**Test Software Used:** Keysight PXE firmware A.33.03

**Background**

There are regulatory requirements to present two additional types of bandwidth analyses: 99% Occupied Bandwidth and Necessary Bandwidth. There are no limits or functional requirements around these data, beyond a reporting requirement. The contents of this test record are for information, and do not affect compliance of the devices that are the subject of this report.

For BLE operating at 2 Mbps, the lowest operating frequency was 2404 MHz, and the highest operating frequency was 2478 MHz. For all other Bluetooth, BLE, and ANT radios reported here, the lowest operating frequency was 2402 MHz, and the highest operating frequency was 2480 MHz.

## Test Setup

This block diagram shows the test equipment setup.

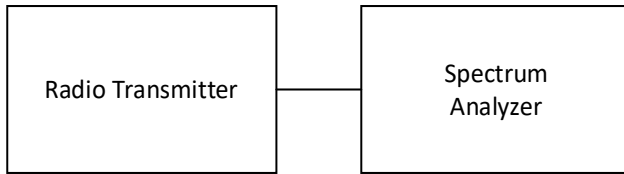

**Figure TR10.1: Test setup**

### Occupied Bandwidth, 99% Test Method

During this test the transmitter output is fed directly, or through RF attenuators, to the spectrum analyzer. The analyzer has a built-in capability to identify the minimum bandwidth that contains a specified percentage of the total power observed. The spectrum is scanned hundreds of times so that the varied effects of modulation are appropriately assessed. Since the focus is on the relative distribution of energy across a range of frequencies, the absolute amplitudes recorded during this test are not relevant and may not include cable losses or attenuation factors.

### Occupied Bandwidth, 99% Test Data

The data for each type of bandwidth is summarized below, followed by the spectral data for the cases highlighted in yellow. Grey 'NT' entries indicate channels or speeds that were not selected for measurement per the design of the experiment. The analysis threshold for this test was the bandwidth containing 99% of the observed power using the ANSI C63.10 method. The standards require testing a frequency near the bottom, middle, and top of the band. The measured bandwidth data have MHz as their units of measure.

	2402 (04)	2440	2480 (78)
Bluetooth BR	0.934	0.939	0.944
Bluetooth EDR2	1.112	1.109	1.109
Bluetooth EDR3	1.138	1.104	1.122
BLE 1 Mbps	1.332	1.320	1.329
BLE 2 Mbps	2.432	2.435	2.495
ANT	1.405	1.319	1.345

**Table TR10.2: Summary of 99% Occupied Bandwidth Data for Bluetooth, ANT and BLE modes**

	Ch1	Ch6	Ch11	Ch12	Ch13
B1	NT	14.957	NT	NT	NT
B2	14.956	15.078	14.881	14.866	14.905
B5.5	NT	14.690	NT	NT	NT
B11	NT	14.801	NT	NT	NT
G6	NT	16.977	NT	NT	NT
G9	NT	16.955	NT	NT	NT
G12	NT	16.836	NT	NT	NT
G18	NT	16.761	NT	NT	NT
G24	NT	16.935	NT	NT	NT
G36	16.832	16.997	16.800	16.809	16.810
G48	NT	16.876	NT	NT	NT
G54	NT	16.956	NT	NT	NT
NMCS0	NT	17.611	NT	NT	NT
NMCS1	NT	17.721	NT	NT	NT
NMCS2	NT	17.729	NT	NT	NT
NMCS3	NT	17.722	NT	NT	NT
NMCS4	NT	17.731	NT	NT	NT
NMCS5	17.577	17.781	17.603	17.585	17.576
NMCS6	NT	17.688	NT	NT	NT
NMCS7	NT	17.616	NT	NT	NT

Table TR10.3: Summary of bandwidth data for WiFi modes

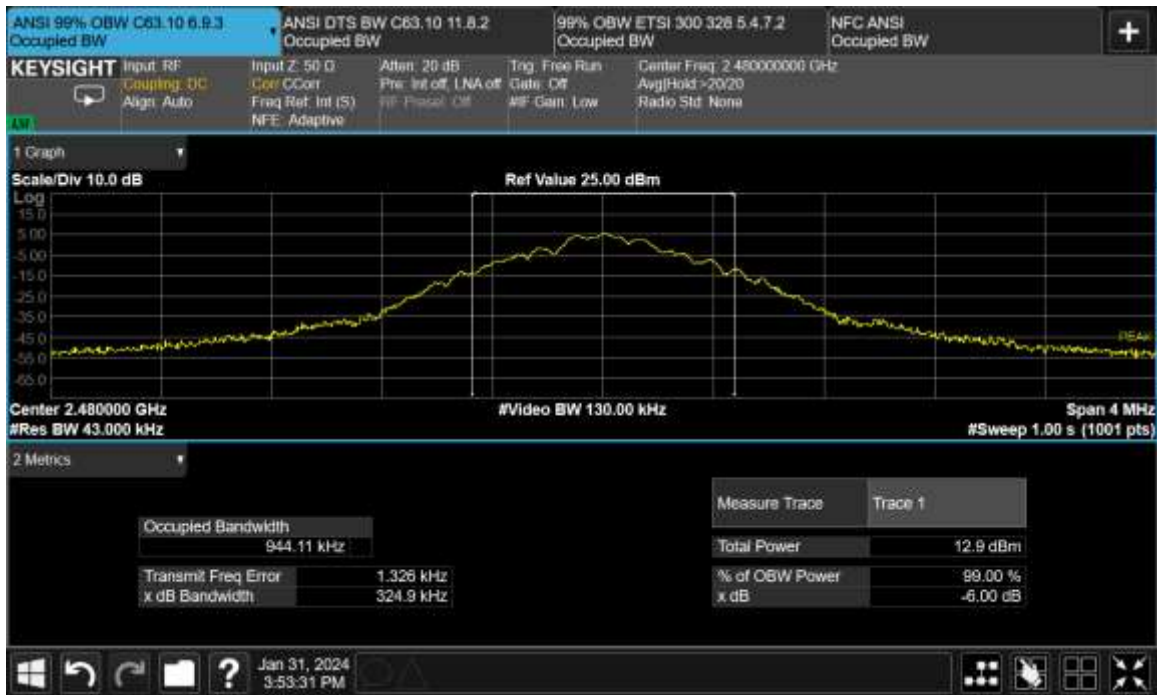

Figure TR10.2: Bandwidth data for Bluetooth BR at 2480 MHz



Figure TR10.3: Bandwidth data for BLE 2 Mbps at 2478 MHz



Figure TR10.4: Bandwidth data for ANT at 2402 MHz



Figure TR10.5: Bandwidth data for B2 Modulation on Channel 6 (2440 MHz)



Figure TR10.6: Bandwidth data for G36 Modulation on Channel 6 (2440 MHz)



Figure TR10.7: Bandwidth data for NMCS5 Modulation on Channel 6 (2440 MHz)

**Necessary Bandwidth Calculations**

The Necessary Bandwidth is a theoretical value based on the specifications for a communication protocol, rather than the hardware implementation and a subsequent lab measurement. The analysis methods in FCC Part 2.202 and TRC-43 are the same for Bluetooth, ANT, and IEEE 802.11b WiFi. However, they differ for IEEE 802.11g and 11n systems because the Canadian TRC-43 standard provides different analysis methods for Orthogonal Frequency Division Multiplexing systems (OFDM). The tables below will show the analysis for most of the radios signals as a combined approach, then separately analyze the results for IEEE 802.11g and n systems. The tables below may include radio protocols that are not part of the product being evaluated.

The radio modulation schemes for Ant, for the various Bluetooth protocols, and for IEEE 802.11 b WiFi are a mix of Phase Shift Key (PSK) and Quadrature Amplitude Modulation (QAM) techniques. The Necessary Bandwidth calculations use the equations from 47CFR Part 2.202(g) table section 6. We have set the variable K=1, which leaves the equation for both PSK and QAM as:

$$B_N = 2R / \text{Log}_2(S)$$

where  $B_N$  is the Necessary Bandwidth, R is the bit rate, and S is the number of signaling states.

Radio Type	R Mbps	K	S	LogBase2 of (S)	BN (MHz)
ANT / ANT+	1	1	2	1	2

Table TR10.101: Necessary Bandwidth for ANT and ANT+ Radio Protocols (FCC and TRC-43)

Radio Type	Sub-type	Method	R Mbps	K	S	LogBase2 of (S)	BN (MHz)
Bluetooth	BR	GFSK	1	1	2	1	2
	EDR2	Pi/4 DPSK	2	1	4	2	2
	EDR3	8DPSK	3	1	8	3	2
BLE	1Mbps	GFSK	1	1	2	1	2
	2Mbps	DQPSK	2	1	4	2	2

Table TR10.102: Necessary Bandwidth for Bluetooth Radio Protocols (FCC and TRC-43)

Radio Type	Sub-type	R Mbps	K	S	LogBase2 of (S)	BN (MHz)
802.11 b	1	1	1	2	1	2
	2	2	1	4	2	2
	5.5	5.5	1	4	2	5.5
	11	11	1	4	2	11

Table TR10.103: Necessary Bandwidth for IEEE 802.11 b Radio Protocol (FCC and TRC-43)

Radio Type	Sub-type	R Mbps	K	S	LogBase2 of (S)	BN (MHz)
802.11 g	6	6	1	2	1	12
	9	9	1	2	1	18
	12	12	1	4	2	12
	18	18	1	4	2	18
	24	24	1	16	4	12
	36	36	1	16	4	18
	48	48	1	64	6	16
	54	54	1	64	6	18
802.11 n	MCS0	7.2	1	2	1	14.4
	MCS1	14.4	1	4	2	14.4
	MCS2	21.7	1	4	2	21.7
	MCS3	28.9	1	16	4	14.5
	MCS4	43.3	1	16	4	21.7
	MCS5	57.8	1	64	6	19.3
	MCS6	65	1	64	6	21.7
	MCS7	72.2	1	64	6	24.1

Table TR10.104: Necessary Bandwidth for IEEE 802.11 g and n 20 MHz Radio Protocols (FCC)

As a note, the bit rate for IEEE 802.11 n WiFi is calculated based on the IEEE standard's short guard interval of 400 nsec. If only the long guard interval of 800 nsec were implemented, the bit rate for MCS7 would decrease to 65 Mbps for a Necessary Bandwidth of 21.7 MHz.

The TRC-43 method for OFDM signals simply multiplies the number of subcarriers, K, and the subcarrier spacing,  $N_s$ . In both cases,  $N_s$  is 312.5 kHz. The count of subcarriers includes nulls. So for example, 802.11 n uses 4 pilot subcarriers, 52 data subcarriers, and one null suppressed subcarrier in the middle for 57 total subcarrier channels.

$$B_N = N_s * K$$

Radio Type	$N_s$ (MHz)	K	BN (MHz)
802.11g	0.3125	53	16.6
802.11n	0.3125	57	17.8

Table TR10.105: Necessary Bandwidth for IEEE 802.11 g and n 20 MHz Radio Protocols (TRC-43)

**This line is the end of the test record.**



**Test Record**  
**Transmitter Power**  
**Test IDs TR01-TR04**  
**Project GCL0437**

Test Date(s) 26 Jan 2024  
 Test Personnel Jim Solum

Product Model A04741  
 Serial Number tested 457910428

Operating Mode M1 (Bt Tx), M3 (Ble Tx), M5 (ANT Tx), M7 (Wifi Tx)  
 Arrangement A4 (USB adaptor)  
 Input Power 5 Vdc

Test Standards: FCC Part 15, ANSI C63.10, RSS-GEN, RSS-247 (as noted in Section 6 of the report).  
 FCC Part 2.1091, FCC Part 2.1093, RSS-102, ANSI C95.3

Antenna Gain 2.51 dBi, as reported by the client  
 Radio Protocol Bluetooth, Bluetooth Low Energy, ANT and IEEE 802.11b/g/n

**Pass/Fail Judgment: PASS**

**Test record created by: Jim Solum**  
**Date of this record: 2 Feb 2024**  
 Original record, Version A.

**Test Equipment Used**

Description	Make	Model #	Serial #	Last Cal/Ver	Next Due
RF Power Sensor	Rohde&Schwarz	NRP8S	109927	7-Jul-2023	1-Jul-2024

Table TR01.1: List of test equipment used

Software used: Rohde & Schwarz Power Viewer V11.3; TimePowerAnalysisSpreadsheetv10.xls

**Test Method**

The basic test standards provide options for the time evaluation test method. The following test methods were applied.

ANSI C63.10: 11.9.1.3

**Transmit Power Data**

Each measurement is made conducted from the antenna port with the transmitter on a specified channel and in a selected transmission protocol. The data record length is 100 msec for the Bluetooth-like protocols and 1 second for WiFi. Where standards cited here apply harmonized test methods and different limits, the more strict limit has applied.

Bluetooth Low Energy at the 2 Mbps data has its lowest and highest channel frequencies set at 2404 MHz and 2478 MHz. The lowest and highest operating channel frequencies for Bluetooth Low Energy at the 1 Mbps and ANT are 2402 MHz and 2480 MHz. Data shown here for WiFi channels 1 through 13 are when the EUT is using locality mode. Channels 12 and Ch13 results are included in the test sequence for a complete view of transmitter operations beyond the typical Channels 1 – 11 range used in North America

The ANSI method finds the highest value (numerical peak) and applies the 30 dBm limit for WiFi and 21dBm for Bluetooth, BLE and ANT from the US and Canadian standards. All values met the limit with better than 10 dB of margin.

The results are shown below. Yellow highlighted cells indicate the highest power value for each radio protocol. Grey 'NT' entries indicate channels or speeds that were not selected for measurement per the design of the experiment.

Frequency	(MHz)	2402	2404	2440	2478	2480
Bluetooth	Basic	6.41	NT	6.70	NT	7.88
Bluetooth	EDR2	6.42	NT	6.74	NT	7.94
Bluetooth	EDR3	6.98	NT	7.37	NT	7.84
BT Low Energy	1 Mbps	-0.53	NT	3.75	NT	0.01
BT Low Energy	2 Mbps	NT	3.40	3.76	0.02	NT
ANT	----	-0.04	NT	3.77	NT	0.04

Table TR01.2: BT, BLE and ANT transmit power summary in dBm

Mode	Speed	1	2	3	4	5	6	7	8	9	10	11	12	13
B	1	13.82	13.85	13.92	13.92	14.01	14.30	14.18	14.26	14.32	14.33	6.54	6.56	6.53
B	2	NT	NT	NT	NT	NT	14.16	NT	NT	NT	NT	NT	NT	NT
B	5.5	NT	NT	NT	NT	NT	14.29	NT	NT	NT	NT	NT	NT	NT
B	11	NT	NT	NT	NT	NT	14.26	NT	NT	NT	NT	NT	NT	NT
G	6	NT	NT	NT	NT	NT	12.30	NT	NT	NT	NT	NT	NT	NT
G	9	9.79	10.24	11.74	11.69	11.71	13.16	11.74	11.76	11.76	11.73	9.11	6.18	4.14
G	12	NT	NT	NT	NT	NT	13.14	NT	NT	NT	NT	NT	NT	NT
G	18	NT	NT	NT	NT	NT	13.14	NT	NT	NT	NT	NT	NT	NT
G	24	NT	NT	NT	NT	NT	13.08	NT	NT	NT	NT	NT	NT	NT
G	36	NT	NT	NT	NT	NT	13.04	NT	NT	NT	NT	NT	NT	NT
G	48	NT	NT	NT	NT	NT	13.05	NT	NT	NT	NT	NT	NT	NT
G	54	NT	NT	NT	NT	NT	13.06	NT	NT	NT	NT	NT	NT	NT
N	MCS0	NT	NT	NT	NT	NT	13.13	NT	NT	NT	NT	NT	NT	NT
N	MCS1	NT	NT	NT	NT	NT	13.26	NT	NT	NT	NT	NT	NT	NT
N	MCS2	NT	NT	NT	NT	NT	13.26	NT	NT	NT	NT	NT	NT	NT
N	MCS3	NT	NT	NT	NT	NT	13.25	NT	NT	NT	NT	NT	NT	NT
N	MCS4	NT	NT	NT	NT	NT	13.26	NT	NT	NT	NT	NT	NT	NT
N	MCS5	NT	NT	NT	NT	NT	13.28	NT	NT	NT	NT	NT	NT	NT
N	MCS6	8.61	11.03	12.80	12.82	12.81	13.30	12.83	12.82	11.90	12.85	9.36	7.90	4.15
N	MCS7	NT	NT	NT	NT	NT	11.90	NT	NT	NT	NT	NT	NT	NT

Table TR01.3: WiFi transmit power summary in dBm

### Additional Transmit Power Data Analysis

The technical requirements for safety to RF exposure also look at transmitter power. Since data from this report may be compared with data from RF exposure reports, this lab has performed a further analysis of the same raw data for power over time used above. This analysis applies standards such as FCC Part 2.1091, FCC Part 2.1093, RSS-102, ANSI C95.3, EN/IEC 62311, or EN 62479.

These data analyses look at average power over time in linear milliwatt units. These data are averaged over a time period no longer than 1 second.

Frequency	(MHz)	2402	2404	2440	2478	2480
Bluetooth	Basic	4.13	NT	4.41	NT	5.57
Bluetooth	EDR2	4.12	NT	4.44	NT	5.64
Bluetooth	EDR3	4.84	NT	5.28	NT	5.92
BT Low Energy	1 Mbps	0.88	NT	2.34	NT	1.00
BT Low Energy	2 Mbps	NT	2.16	2.34	1.00	NT
ANT	----	0.98	NT	2.35	NT	1.00

Table TR01.4: : BT, BLE and ANT additional RF exposure power summary in milliwatts

Mode	Speed	1	2	3	4	5	6	7	8	9	10	11	12	13
B	1	23.87	24.05	24.46	24.44	24.96	26.71	25.94	26.43	26.82	26.93	4.45	4.47	4.45
B	2	NT	NT	NT	NT	NT	25.83	NT	NT	NT	NT	NT	NT	NT
B	5.5	NT	NT	NT	NT	NT	26.61	NT	NT	NT	NT	NT	NT	NT
B	11	NT	NT	NT	NT	NT	26.31	NT	NT	NT	NT	NT	NT	NT
G	6	NT	NT	NT	NT	NT	16.56	NT	NT	NT	NT	NT	NT	NT
G	9	9.30	10.30	14.57	14.45	14.47	20.16	14.59	14.60	14.57	14.52	7.95	4.05	2.54
G	12	NT	NT	NT	NT	NT	20.31	NT	NT	NT	NT	NT	NT	NT
G	18	NT	NT	NT	NT	NT	20.30	NT	NT	NT	NT	NT	NT	NT
G	24	NT	NT	NT	NT	NT	19.78	NT	NT	NT	NT	NT	NT	NT
G	36	NT	NT	NT	NT	NT	19.71	NT	NT	NT	NT	NT	NT	NT
G	48	NT	NT	NT	NT	NT	19.80	NT	NT	NT	NT	NT	NT	NT
G	54	NT	NT	NT	NT	NT	19.75	NT	NT	NT	NT	NT	NT	NT
N	MCS0	NT	NT	NT	NT	NT	19.98	NT	NT	NT	NT	NT	NT	NT
N	MCS1	NT	NT	NT	NT	NT	20.80	NT	NT	NT	NT	NT	NT	NT
N	MCS2	NT	NT	NT	NT	NT	20.84	NT	NT	NT	NT	NT	NT	NT
N	MCS3	NT	NT	NT	NT	NT	20.67	NT	NT	NT	NT	NT	NT	NT
N	MCS4	NT	NT	NT	NT	NT	20.66	NT	NT	NT	NT	NT	NT	NT
N	MCS5	NT	NT	NT	NT	NT	20.76	NT	NT	NT	NT	NT	NT	NT
N	MCS6	7.06	12.31	18.54	18.61	18.63	20.78	18.70	18.61	15.04	18.70	8.38	6.00	2.52
N	MCS7	NT	NT	NT	NT	NT	15.08	NT	NT	NT	NT	NT	NT	NT

Table TR01.5: WiFi additional RF exposure power summary in milliwatts

### Setup Diagram

The following block diagrams show how the EUT and test equipment is arranged for test. The client provided a short length of cable to bring the signals out to a connector. This cable was found to have 0.6 dB of loss in this frequency range. This factor was taken into account during the data analysis.

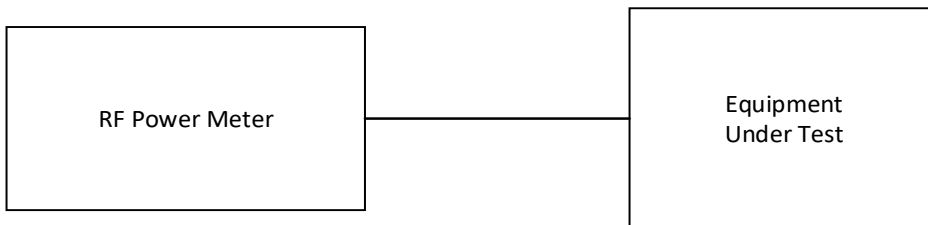

Figure TR01.1: Test equipment setup

**This line is the end of the test record.**

**Test Record**  
**Conducted Spurious Emissions**  
**Test IDs TR28 – TR30**  
**Project GCL-0437**

Test Date(s) 8,9 Feb 2024  
 Test Personnel Majid Farah

Product Model A04741  
 Serial Number tested 457910428

Operating Mode M3 (Ble Tx), M5 (ANT Tx), and M7(Wifi Tx)  
 Arrangement A4 (USB adapter)  
 Input Power 5 Vdc

Test Standards: FCC Part 15, ANSI C63.10, RSS-GEN, RSS-247 (as noted in Section 6 of the report).

**Pass/Fail Judgment: PASS**

**Test record created by: Jim Solum**  
**Date of this test record: 9 Feb 2024**

Original record, Version A.

**Test Equipment**

Description	Make	Model #	Serial #	Last Cal/Ver	Next Due
PXE Receiver 44GHz	Keysight	N9048B	MY62220139	30-Jan-2023	6-Mar-2024

**Table TR28.1: Test equipment used**

**Software used:** Keysight PXE software A.33.03

**Test Method**

The basic test standards provide options for the test method. The following test methods were applied.

ANSI C63.10: 11.11.2 and 11.11.3

**Test Setup**

This block diagram shows the test equipment setup.

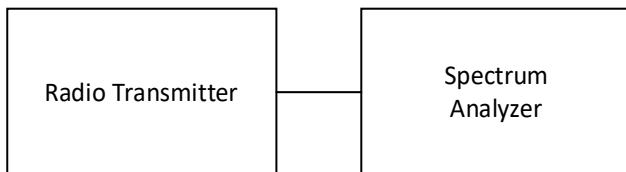

**Figure TR28.1: Test setup**

## Test Data

The conducted spurious emission test measures the strength of intentional and unintentional radio signals conducted from the transmitter to the antenna across a wide range of frequencies. It does not evaluate whether intentional signals meet specific limits. Rather, it ensures that magnitudes unintentional signals are sufficiently reduced relative to the intentional signal to satisfy the requirements of the relevant standards.

This measurement requires that a coaxial feed line from the transmitter is available as a connector exterior to the test sample. This feed line and connector may be a part of the shipping product, or it may be a special modification to the product for testing purposes. The connector is attached via laboratory cables to the measurement instrument. The results have been adjusted to account for the losses in the laboratory cables. Where feasible, the losses of any added feed lines are also included in that adjustment.

Data is collected using the required detector function(s) across the frequency range. The instrument uses a 100 kHz bandwidth detector.

The data table below shows the final measurement data which may be at harmonics of the carrier, or at frequencies that represent one of the highest data points measured.

The peak level of the fundamental is also identified. The harmonics or spurious emissions must be reduced from this fundamental level by 20 dBc. This harmonic limit is calculated and used to determine compliance. A reduction from the carrier that is greater than 20 is a passing result. The minimum margin from the peak level for each mode are highlighted in yellow.

For BLE operating at 2 Mbps, the lowest operating frequency was 2404 MHz, and the highest operating frequency was 2478 MHz. For all other Bluetooth, BLE, and ANT radios reported here, the lowest operating frequency was 2402 MHz, and the highest operating frequency was 2480 MHz.

Data plots are provided for the worst-case data sets. One plot shows the spectrum at the carrier, and another shows the spectrum across the band. On this second plot, a green reference line is at approximately the 20 dBc maximum spurious emission level.

		2402 (04)	2440	2480 (78)
BLE	1 Mb	47.38	53.64	50.07
	2 Mb	50.54	52.71	48.90
ANT		47.37	52.29	48.92

**Table TR28.2: Results summary for BLE and ANT**

Mode	Data rate (Mbps)	Channel No.			
		1	6	11	13
B	1	51.28	53.35	53.34	52.59
G	24	46.35	49.64	45.64	47.37
N	MCS0	43.62	43.91	44.71	38.74

**Table TR28.3: Results summary for IEEE 802.11 (b,g,n)**



Figure TR28.2: Reference level measurement for Bluetooth BLE 1 Mbps at 2402 MHz



Figure TR28.3 Spectral data for Bluetooth BLE 1 Mbps at 2402 MHz



Figure TR28.4: Reference level measurement for ANT at 2402 MHz



Figure TR28.5 Spectral data for ANT at 2402 MHz

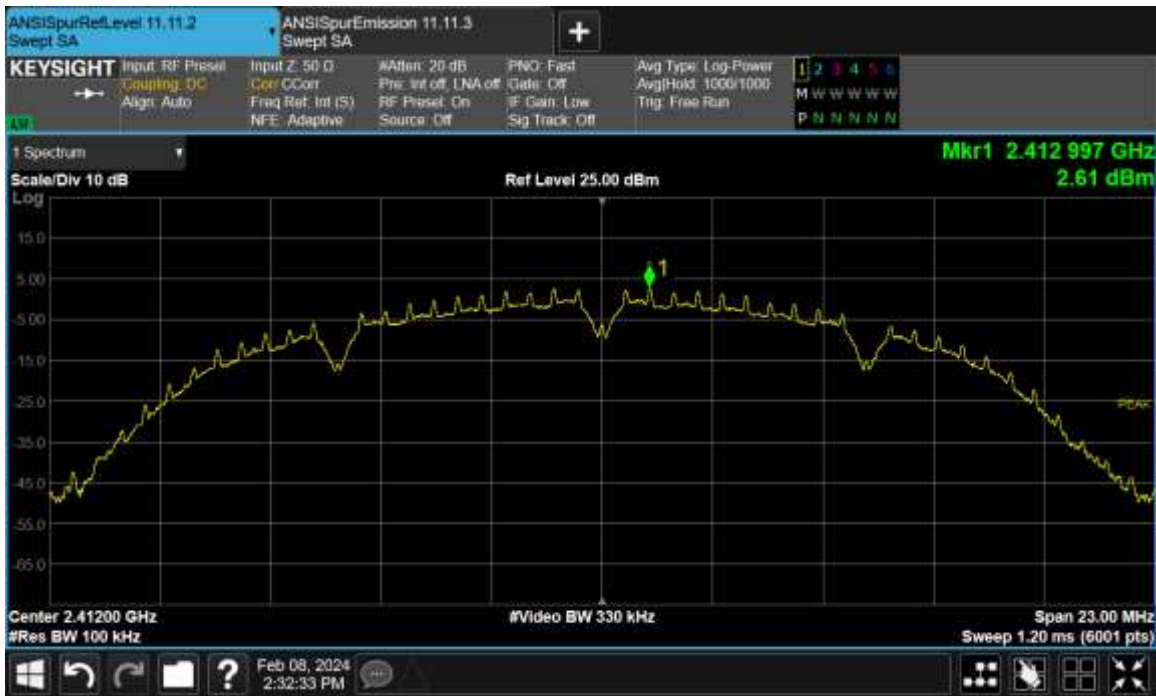

Figure TR28.6: Reference level measurement for IEEE 802.11 B 1 Mbps on Ch.1

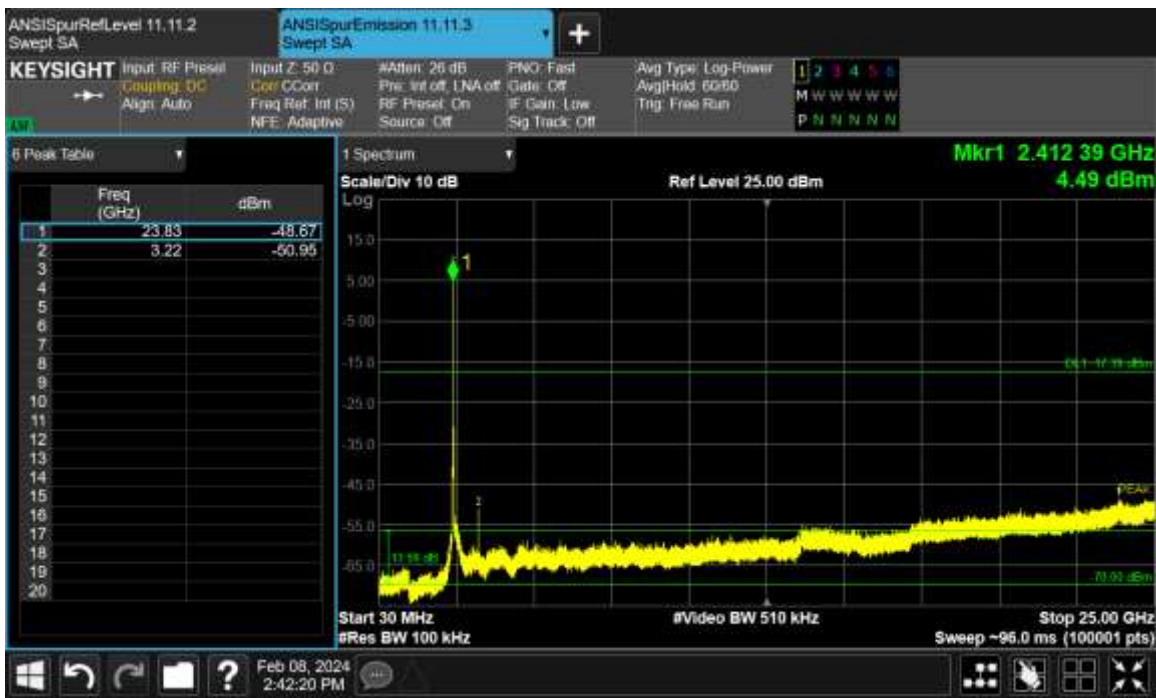

Figure TR28.7: Spectral data for IEEE 802.11 B 1 Mbps on Ch.1



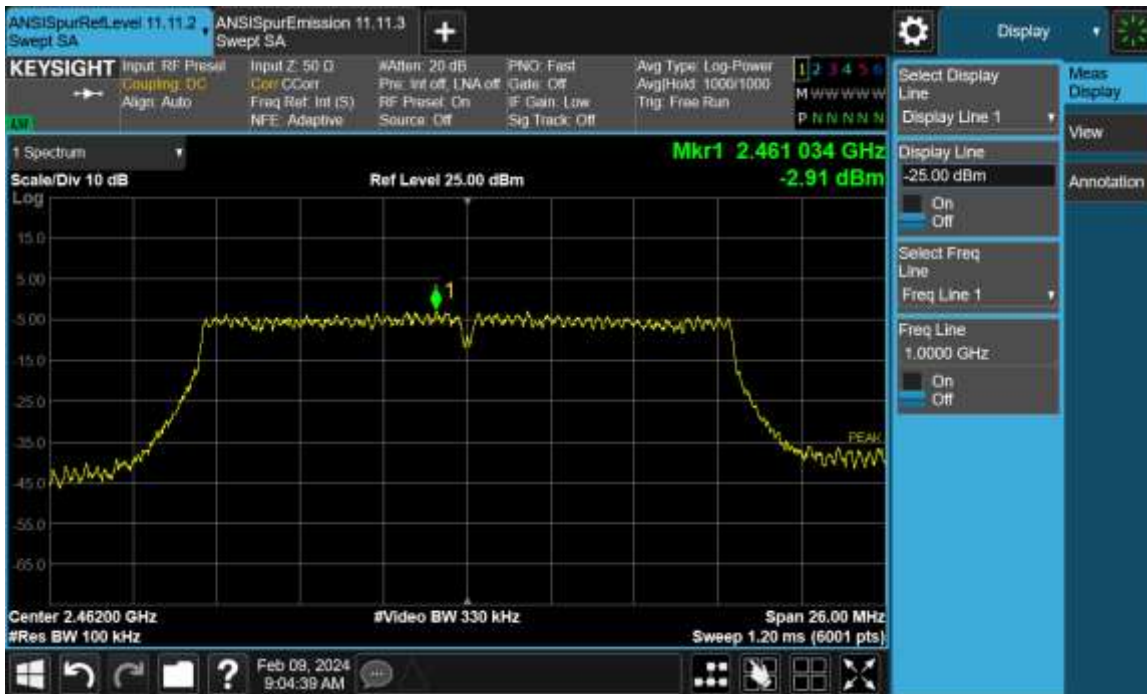

Figure TR28.8: Reference level measurement for IEEE 802.11 G 24 Mbps on Ch.11



Figure TR28.9 Spectral data for IEEE 802.11 G 24 Mbps on Ch.11



Figure TR28.10: Reference level measurement for IEEE 802.11 N MCS0 on Ch.13



Figure TR28.11 Spectral data for IEEE 802.11 N MCS0 on Ch.13

This line is the end of the test record.

**Test Record**  
**Radiated Emission Test RE02**  
**Project GCL0437**

Test Date(s) 15 Feb 2024  
 Test Personnel Aditya Prakash

Product Model A04741  
 Serial Number tested 457910369

Operating Mode M3 (Ble Tx)  
 Arrangement A4 (USB adaptor)  
 Input Power 5 Vdc

Test Standards: FCC Part 15, RSS-Gen (as noted in Section 6 of the report).

Frequency Range: Restricted Bands (2200-2300 MHz, 2310-2390 MHz, 2483.5-2500 MHz)  
**Pass/Fail Judgment: PASS**

**Test record created by: Aditya Prakash**  
**Date of this record: 16-Feb-2024**

Original record, Version A.

Description	Make	Model #	Serial #	Last Cal/Ver	Next Due
PXE Receiver 26 GHz	Keysight	N9048B	MY59290135	27-Sep-23	1-Oct-24
Antenna, Horn, 1-18 GHz	ETS Lindgren	3117	00259208	7-Jun-23	1-Jun-24
FSOATS 3m, above 1 GHz	Frankonia	SAC3	F199004	16-Nov-22	16-Nov-25
Tape measure, 1" x 33'	Lufkin	PHV1410CMEN	10720	16-Jan-23	15-Jan-26
Preamplifier, 500 MHz 18 GHz	Com-Power	PAM-118A	18040133	Calibration	Not Required
Wifi Filter	K&L	8NSL26-2437/E82.2-0/0	1	Calibration	Not Required

**Table RE02.1: Test Equipment Used**

**Software Used**

Keysight PXE receiver software A.32.06  
 RE Signal Maximization Tool v2023Jul14.xlsx  
 FCC Restricted Band 2p4GHz Template v1b 2023Jun20.xlsx

## Test Data

This restricted band investigation began with a benchtop setup wherein the emissions in the restricted bands were observed from a modified test sample with an RF output cable replacing the onboard antenna. The actual emission levels within restricted bands in many of the test sample's available transmission modes are too low to be reliably measured in the radiated environment. By applying the required peak and average detectors and bandwidths to the signals direct from the transmitter, lab staff identified the worst-case operational modes. These were then measured using an unmodified unit in the required radiated environment.

The radiated emission test began with a preliminary scan in each restricted band at multiple turntable angles, antenna heights, and both antenna polarizations. For test standards that require reorienting the test sample, further preliminary scans were taken in those alternate orientations typically described as X, Y, and Z. Subsequent testing was done using on the orientation(s) producing the highest result relative to the test limit. Final field strength measurements were taken in that set of positions.

Restricted band measurements in the lower band were made while the transmitter was tuned to its lowest frequency of 2402 MHz for the 1 Mbps data rate, and 2404 MHz for the 2 Mbps data rate. Measurements in the upper band were made while the transmitter was tuned to its highest frequency of 2480 MHz for the 1 Mbps data rate, and 2478 MHz for the 2 Mbps data rate.

At azimuth angle 0° the 'front' reference mark of the turntable is pointed Southward. At 90° the reference mark points West. At -90° it points East. At -7° the turntable reference mark is pointed directly at the antenna. The designation of the X, Y, and Z orientations of the test sample are sample dependent, so these are reported by use of photographs.

The tables show the selected final measurement data between the FCC restricted bands. It includes a the strongest emissions observed relative to the test limit, along with other data points of interest. Where a data point is highlighted is yellow, this is an aid to indicate the data point(s) with the least margin to the test limit. A positive margin value indicates that the emission was below the test limit. The test limit is the FCC restricted band Class B Limit at 3m.

Frequency	Avg Limit	Pk Limit	Avg Level	Pk Level	Av Margin	Pk Margin	Azimuth	Height	Polarity
(MHz)	(dBuV/m)	(dBuV/m)	(dBuV/m)	(dBuV/m)	(dB)	(dB)	(degree)	(mm)	---
2383.3	54	74	33.99	47.87	20.01	26.13	149	1366	HORZ
2390	54	74	34.30	48.56	19.70	25.44	149	1366	HORZ

**Table RE02.2: FCC restricted bands from 2200 to 2390 MHz (Y orientation) BLE 2 Mbps.**

Frequency	Avg Limit	Pk Limit	Avg Level	Pk Level	Av Margin	Pk Margin	Azimuth	Height	Polarity
(MHz)	(dBuV/m)	(dBuV/m)	(dBuV/m)	(dBuV/m)	(dB)	(dB)	(degree)	(mm)	---
2483.5	54	74	42.38	54.54	11.62	19.46	-175	2164	HORZ
2484.8	54	74	42.79	53.17	11.21	20.83	-175	2164	HORZ

**Table RE02.3: FCC restricted band from 2483.5 to 2500 MHz (Y orientation) BLE 2 Mbps.**

The graphs below show the background spectrum observed during pre-scan, as well as the final data points from the table above.

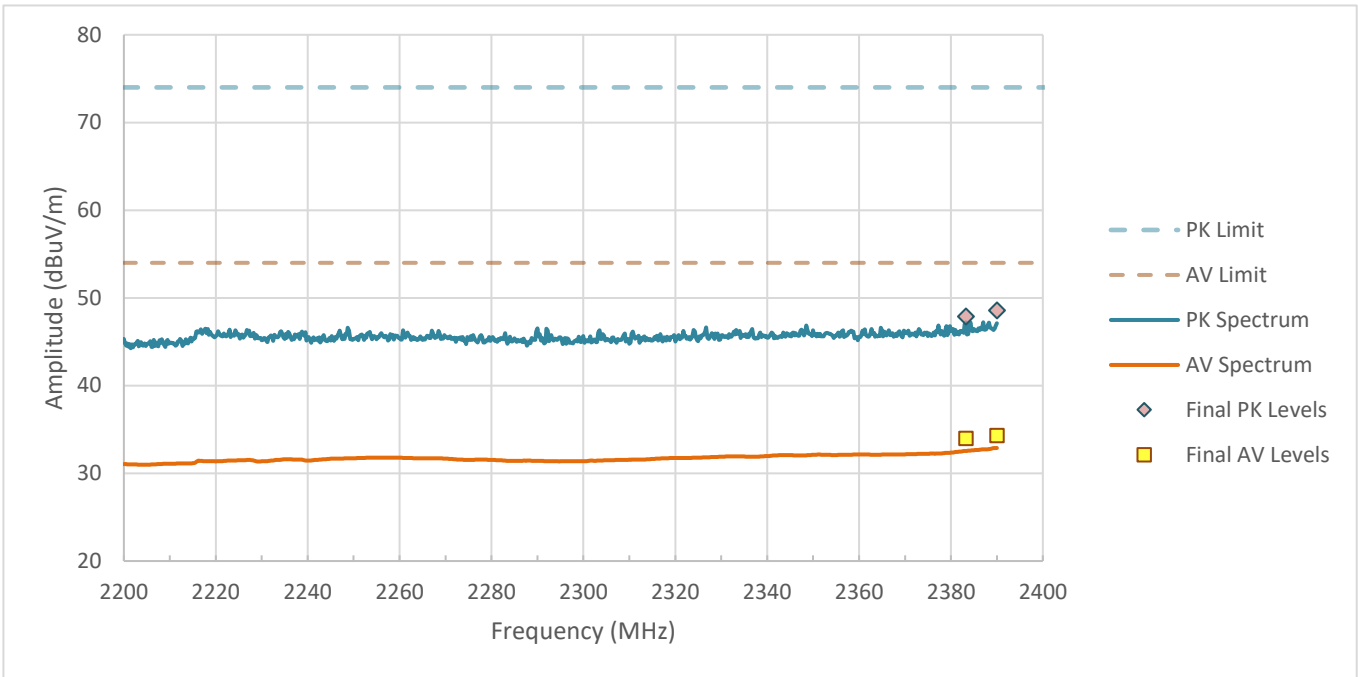

Figure RE02.1: FCC restricted band spectral data from 2200 to 2390 MHz (Y orientation) BLE 2 Mbps.

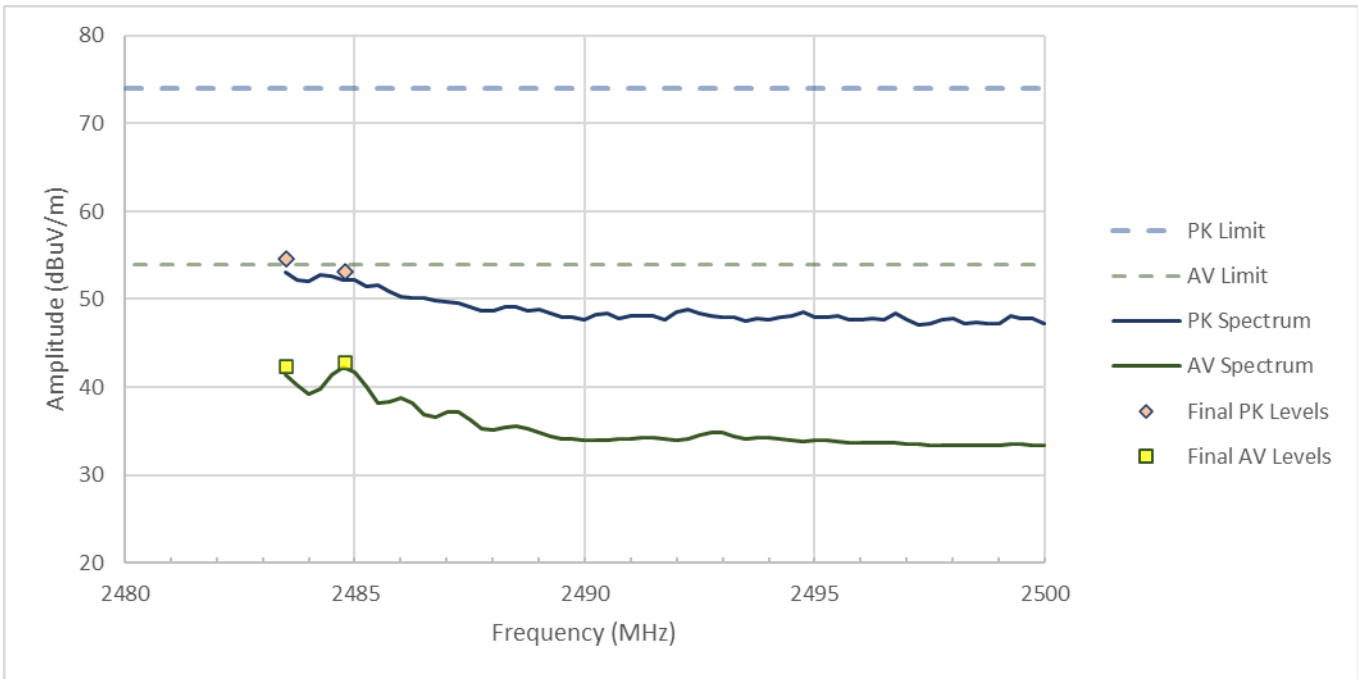
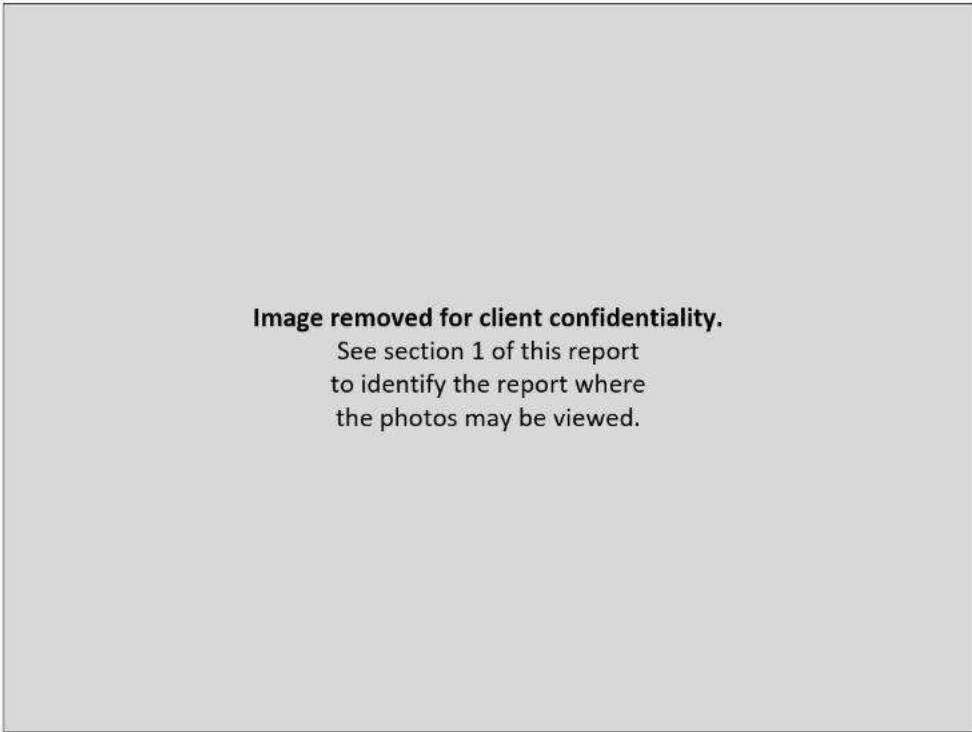

Figure RE02.2: FCC restricted band spectral data from 2483.5 to 2500 MHz (Y orientation) BLE 2 Mbps.

**Setup Photographs**

The following photographs show the EUT configured and arranged in the manner in which it was measured.



**Figure RE02.3: EUT test setup, primary view (Y orientation).**

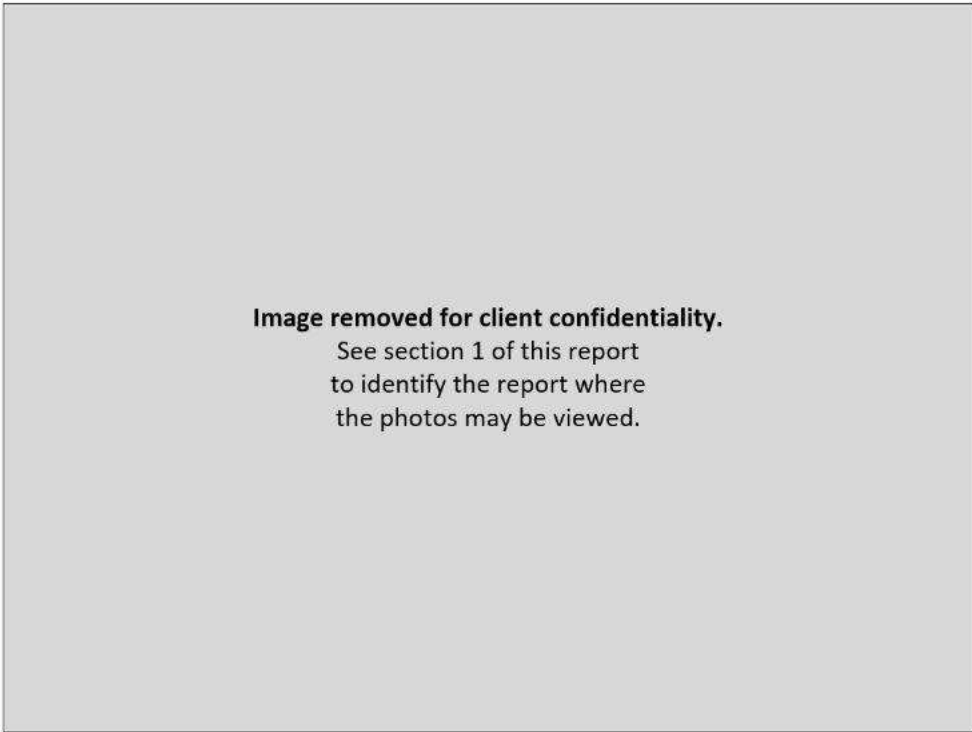

**Figure RE02.4: EUT test setup, reverse view (Y orientation).**  
This line is the end of the test record.

**Test Record**  
**Radiated Emission Test RE03**  
**Project GCL0437**

Test Date(s) 15 Feb 2024  
 Test Personnel Aditya Prakash

Product Model A04741  
 Serial Number tested 457910369

Operating Mode M5 (ANT Tx)  
 Arrangement A4 (USB adaptor)  
 Input Power 5 Vdc

Test Standards: FCC Part 15, RSS-Gen (as noted in Section 6 of the report).

Frequency Range: Restricted Bands (2200-2300 MHz, 2310-2390 MHz, 2483.5-2500 MHz)  
**Pass/Fail Judgment: PASS**

**Test record created by: Aditya Prakash**  
**Date of this record: 16-Feb-2024**

Original record, Version A.

Description	Make	Model #	Serial #	Last Cal/Ver	Next Due
PXE Receiver 26 GHz	Keysight	N9048B	MY59290135	27-Sep-23	1-Oct-24
Antenna, Horn, 1-18 GHz	ETS Lindgren	3117	00259208	7-Jun-23	1-Jun-24
FSOATS 3m, above 1 GHz	Frankonia	SAC3	F199004	16-Nov-22	16-Nov-25
Tape measure, 1" x 33'	Lufkin	PHV1410CMEN	10720	16-Jan-23	15-Jan-26
Preamplifier, 500 MHz 18 GHz	Com-Power	PAM-118A	18040133	Calibration	Not Required
Wifi Filter	K&L	8NSL26-2437/E82.2-0/0	1	Calibration	Not Required

**Table RE03.1: Test Equipment Used**

**Software Used**

Keysight PXE receiver software A.32.06  
 RE Signal Maximization Tool v2023Jul14.xlsx  
 FCC Restricted Band 2p4GHz Template v1b 2023Jun20.xlsx

## Test Data

This restricted band investigation began with a benchtop setup wherein the emissions in the restricted bands were observed from a modified test sample with an RF output cable replacing the onboard antenna. The actual emission levels within restricted bands in many of the test sample's available transmission modes are too low to be reliably measured in the radiated environment. By applying the required peak and average detectors and bandwidths to the signals direct from the transmitter, lab staff identified the worst-case operational modes. These were then measured using an unmodified unit in the required radiated environment.

The radiated emission test began with a preliminary scan in each restricted band at multiple turntable angles, antenna heights, and both antenna polarizations. For test standards that require reorienting the test sample, further preliminary scans were taken in those alternate orientations typically described as X, Y, and Z. Subsequent testing was done using on the orientation(s) producing the highest result relative to the test limit. Final field strength measurements were taken in that set of positions.

Restricted band measurements in the lower band were made while the transmitter was tuned to its lowest frequency of 2402 MHz for the 1 Mbps data rate, and 2404 MHz for the 2 Mbps data rate. Measurements in the upper band were made while the transmitter was tuned to its highest frequency of 2480 MHz for the 1 Mbps data rate, and 2478 MHz for the 2 Mbps data rate.

At azimuth angle 0° the 'front' reference mark of the turntable is pointed Southward. At 90° the reference mark points West. At -90° it points East. At -7° the turntable reference mark is pointed directly at the antenna. The designation of the X, Y, and Z orientations of the test sample are sample dependent, so these are reported by use of photographs.

The tables show the selected final measurement data between the FCC restricted bands. It includes a the strongest emissions observed relative to the test limit, along with other data points of interest. Where a data point is highlighted is yellow, this is an aid to indicate the data point(s) with the least margin to the test limit. A positive margin value indicates that the emission was below the test limit. The test limit is the FCC restricted band Class B Limit at 3m.

Frequency	Avg Limit	Pk Limit	Avg Level	Pk Level	Av Margin	Pk Margin	Azimuth	Height	Polarity
(MHz)	(dBuV/m)	(dBuV/m)	(dBuV/m)	(dBuV/m)	(dB)	(dB)	(degree)	(mm)	---
2389.5	54	74	34.02	48.45	19.98	25.55	149	1366	HORZ
2390	54	74	34.29	47.94	19.71	26.06	149	1366	HORZ

**Table RE03.2: FCC restricted bands from 2200 to 2390 MHz (Y orientation)**

Frequency	Avg Limit	Pk Limit	Avg Level	Pk Level	Av Margin	Pk Margin	Azimuth	Height	Polarity
(MHz)	(dBuV/m)	(dBuV/m)	(dBuV/m)	(dBuV/m)	(dB)	(dB)	(degree)	(mm)	---
2483.5	54	74	37.23	51.74	16.77	22.26	-175	2164	HORZ
2484	54	74	37.19	50.84	16.81	23.16	-175	2164	HORZ

**Table RE03.3: FCC restricted band from 2483.5 to 2500 MHz (Y orientation)**

The graphs below show the background spectrum observed during pre-scan, as well as the final data points from the table above.



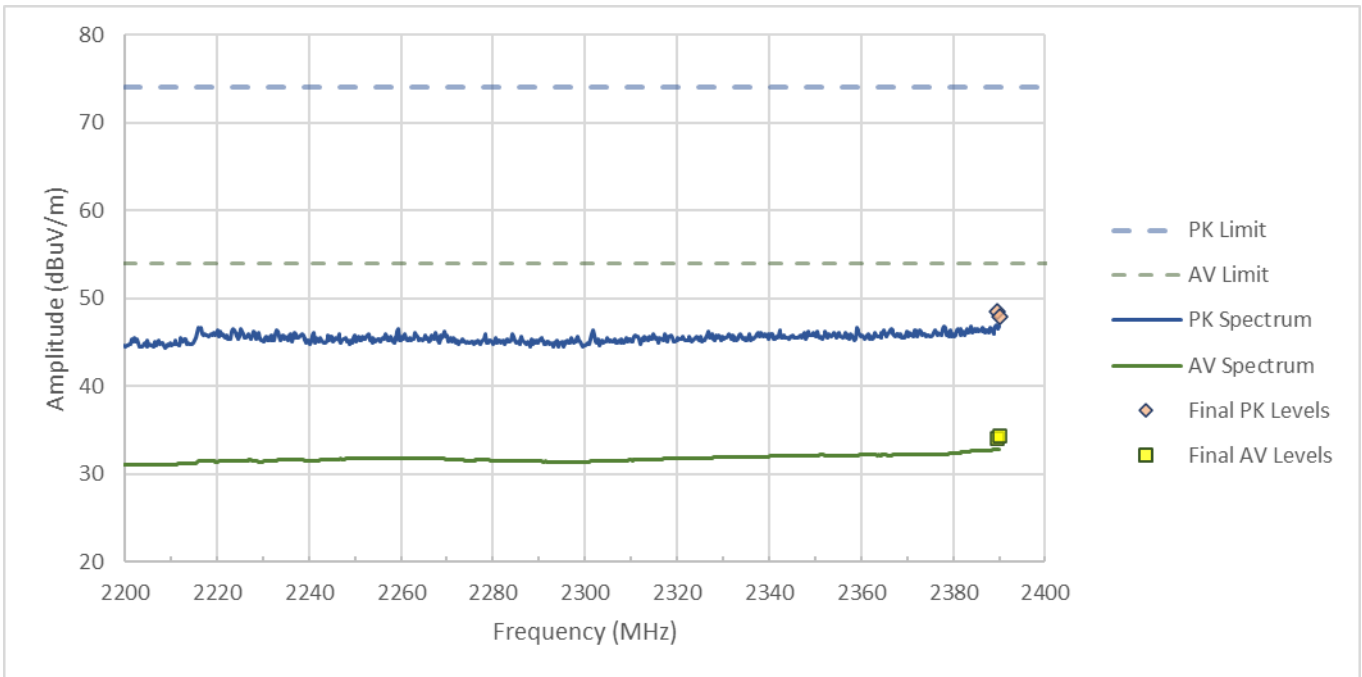

Figure RE03.1: FCC restricted band spectral data from 2200 to 2390 MHz (Y orientation)

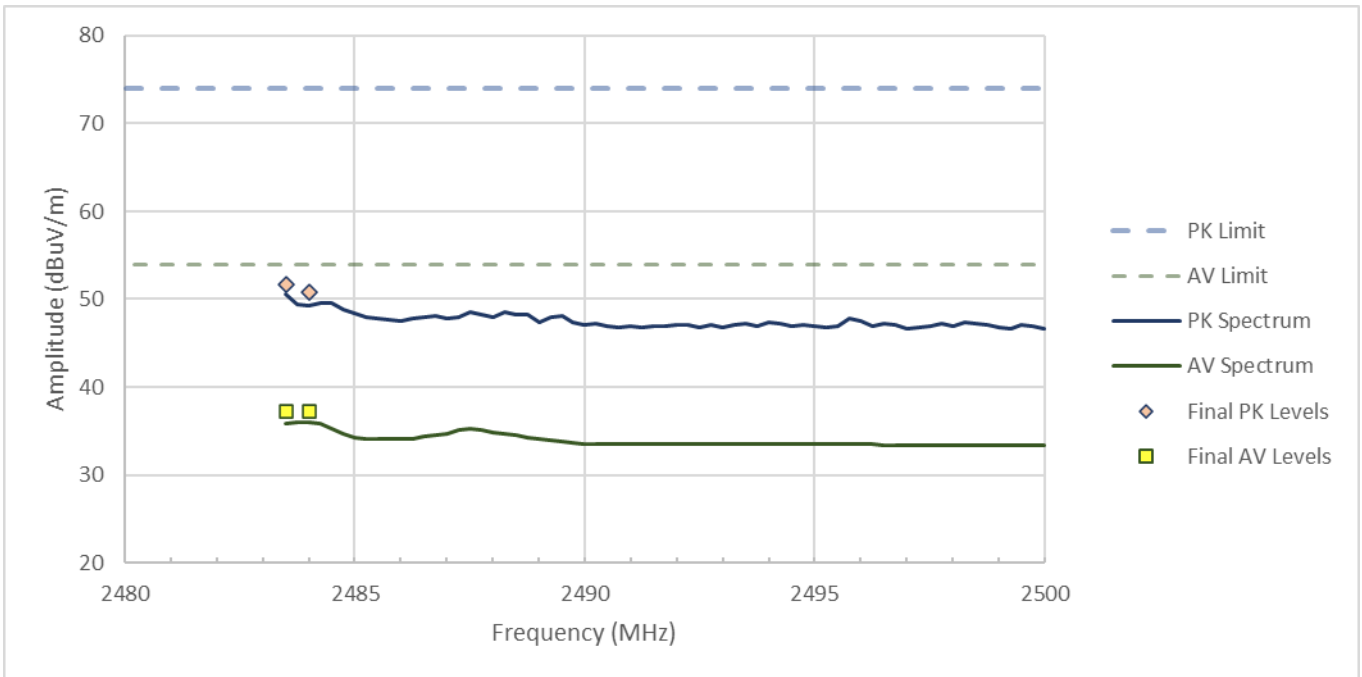
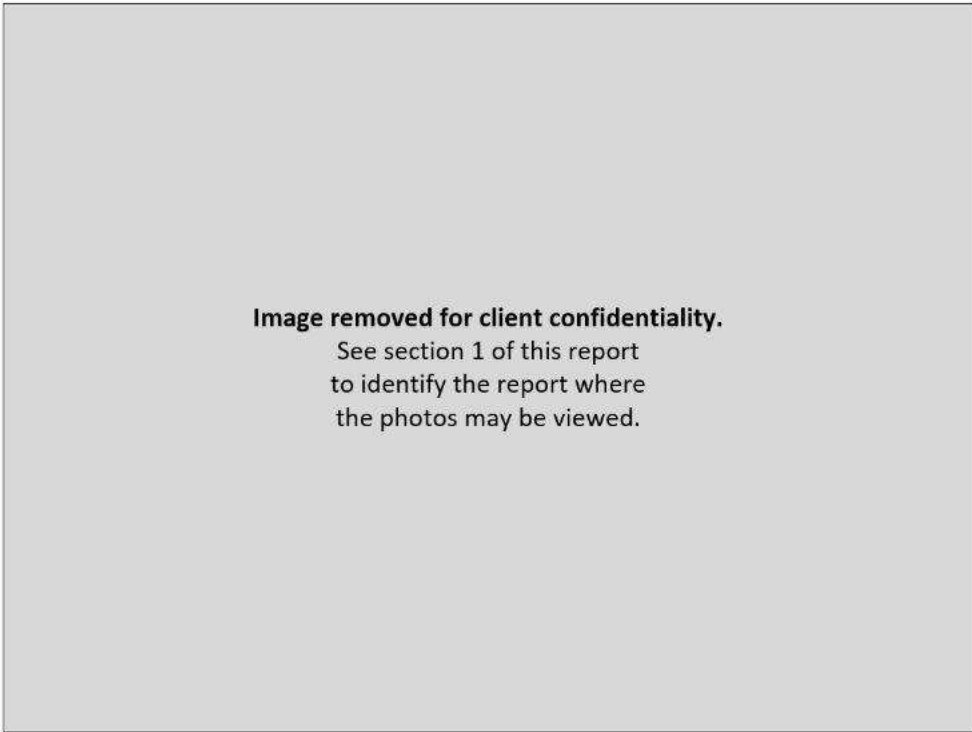

Figure RE03.2: FCC restricted band spectral data from 2483.5 to 2500 MHz (Y orientation)

**Setup Photographs**

The following photographs show the EUT configured and arranged in the manner in which it was measured.



**Figure RE03.3: EUT test setup, primary view (Y orientation)**

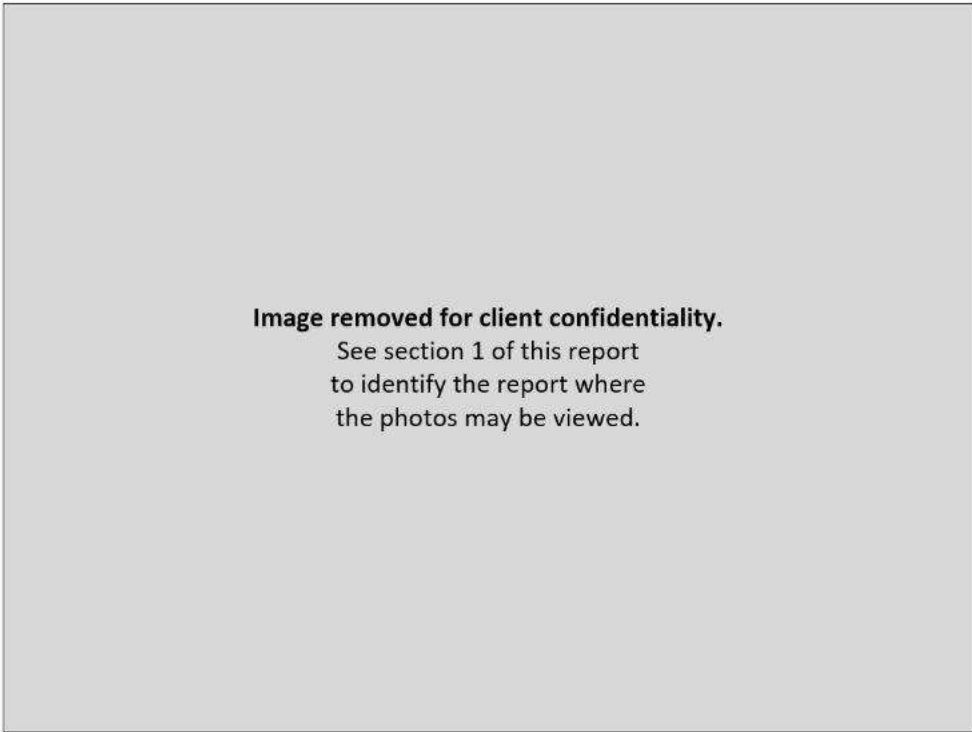

**Figure RE03.4: EUT test setup, reverse view (Y orientation).**  
This line is the end of the test record.

**Test Record**  
**Radiated Emission Test RE04**  
**Project GCL0437**

Test Date(s) 15 Feb 2024  
 Test Personnel David Kerr

Product Model A04741  
 Serial Number tested 457910369

Operating Mode M7 (Wifi Tx)  
 Arrangement A4 (USB adaptor)  
 Input Power 5 Vdc

Test Standards: FCC Part 15, RSS-Gen (as noted in Section 6 of the report).

Frequency Range: Restricted Bands (2200-2300 MHz, 2310-2390 MHz, 2483.5-2500 MHz)  
**Pass/Fail Judgment: PASS**

**Test record created by: Aditya Prakash**  
**Date of this record: 19-Feb-2024**

Original record, Version A.

Description	Make	Model #	Serial #	Last Cal/Ver	Next Due
PXE Receiver 26 GHz	Keysight	N9048B	MY59290135	27-Sep-23	1-Oct-24
Antenna, Horn, 1-18 GHz	ETS Lindgren	3117	00259208	7-Jun-23	1-Jun-24
FSOATS 3m, above 1 GHz	Frankonia	SAC3	F199004	16-Nov-22	16-Nov-25
Tape measure, 1" x 33'	Lufkin	PHV1410CMEN	10720	16-Jan-23	15-Jan-26
Preamplifier, 500 MHz 18 GHz	Com-Power	PAM-118A	18040133	Calibration	Not Required
Wifi Filter	K&L	8NSL26-2437/E82.2-0/0	1	Calibration	Not Required

**Table RE04.1: Test Equipment Used**

**Software Used**

Keysight PXE receiver software A.32.06  
 RE Signal Maximization Tool v2023Jul14.xlsx  
 FCC Restricted Band 2p4GHz Template v1b 2023Jun20.xlsx

## Test Data

This restricted band investigation began with a benchtop setup wherein the emissions in the restricted bands were observed from a modified test sample with an RF output cable replacing the onboard antenna. The actual emission levels within restricted bands in many of the test sample's available transmission modes are too low to be reliably measured in the radiated environment. By applying the required peak and average detectors and bandwidths to the signals direct from the transmitter, lab staff identified the worst-case operational modes. These were then measured using an unmodified unit in the required radiated environment.

The radiated emission test began with a preliminary scan in each restricted band at multiple turntable angles, antenna heights, and both antenna polarizations. For test standards that require reorienting the test sample, further preliminary scans were taken in those alternate orientations typically described as X, Y, and Z. Subsequent testing was done using on the orientation(s) producing the highest result relative to the test limit. Final field strength measurements were taken in that set of positions. Y orientation was producing the highest emission results.

Restricted band measurements in the lower band were made while the transmitter was tuned to channel 1, and restricted band measurements in the higher band were made while the transmitter was tuned to channel 11, 12, and 13.

At azimuth angle 0° the 'front' reference mark of the turntable is pointed Southward. At 90° the reference mark points West. At -90° it points East. At -7° the turntable reference mark is pointed directly at the antenna. The designation of the X, Y, and Z orientations of the test sample are sample dependent, so these are reported by use of photographs.

The tables show the selected final measurement data between the FCC restricted bands. It includes a the strongest emissions observed relative to the test limit, along with other data points of interest. Where a data point is highlighted is yellow, this is an aid to indicate the data point(s) with the least margin to the test limit. A positive margin value indicates that the emission was below the test limit. The test limit is the FCC restricted band Class B Limit at 3m.

Channel & Modulation	Frequency (MHz)	Avg Limit (dBuV/m)	Pk Limit (dBuV/m)	Avg Level (dBuV/m)	Pk Level (dBuV/m)	Av Margin (dB)	Pk Margin (dB)	Azimuth (degree)	Height (mm)	Polarity
B Mode Peak	2377.30	54	74	33.82	47.33	20.18	26.67	149	1366	HORZ
B Mode Average	2390.00	54	74	34.41	47.97	19.59	26.03	149	1366	HORZ
G Mode Peak	2232.00	54	74	33.02	47.56	20.98	26.44	149	1366	HORZ
G Mode Average	2390.00	54	74	34.20	47.86	19.80	26.14	149	1366	HORZ
N Mode Peak	2389.50	54	74	34.23	47.80	19.77	26.20	149	1366	HORZ
N Mode Average	2390.00	54	74	34.29	48.37	19.71	25.63	149	1366	HORZ

**Table RE04.2: FCC restricted bands from 2200 to 2390 MHz (EUT transmitting on channel 1)**

Channel & Modulation	Frequency (MHz)	Avg Limit (dBuV/m)	Pk Limit (dBuV/m)	Avg Level (dBuV/m)	Pk Level (dBuV/m)	Av Margin (dB)	Pk Margin (dB)	Azimuth (degree)	Height (mm)	Polarity
B Mode Peak	2484.50	54	74	34.99	48.46	19.01	25.54	-175	2164	HORZ
B Mode Average	2483.50	54	74	35.15	49.32	18.85	24.68	-175	2164	HORZ
G Mode Peak	2484.50	54	74	35.00	48.85	19.00	25.15	-175	2164	HORZ
G Mode Average	2483.50	54	74	35.16	48.56	18.84	25.44	-175	2164	HORZ
N Mode Peak	2488.75	54	74	34.59	47.94	19.41	26.06	-175	2164	HORZ
N Mode Average	2483.50	54	74	35.15	49.01	18.85	24.99	-175	2164	HORZ

**Table RE04.3: FCC restricted band from 2483.5 to 2500 MHz (EUT transmitting on channel 11)**

Channel & Modulation	Frequency (MHz)	Avg Limit (dBuV/m)	Pk Limit (dBuV/m)	Avg Level (dBuV/m)	Pk Level (dBuV/m)	Av Margin (dB)	Pk Margin (dB)	Azimuth (degree)	Height (mm)	Polarity
B Mode Peak	2484.30	54	74	35.04	48.74	18.96	25.26	-175	2164	HORZ
B Mode Average	2483.50	54	74	35.16	48.84	18.84	25.16	-175	2164	HORZ
G Mode Peak	2484.50	54	74	35.00	48.87	19.01	25.13	-175	2164	HORZ
G Mode Average	2483.50	54	74	35.15	48.81	18.85	25.19	-175	2164	HORZ
N Mode Peak	2497.50	54	74	34.48	48.90	19.52	25.10	-175	2164	HORZ
N Mode Average	2483.50	54	74	35.14	48.36	18.86	25.64	-175	2164	HORZ

Table RE04.4: FCC restricted band from 2483.5 to 2500 MHz (EUT transmitting on channel 12)

Channel & Modulation	Frequency (MHz)	Avg Limit (dBuV/m)	Pk Limit (dBuV/m)	Avg Level (dBuV/m)	Pk Level (dBuV/m)	Av Margin (dB)	Pk Margin (dB)	Azimuth (degree)	Height (mm)	Polarity
B Mode Peak	2483.50	54	74	35.13	48.76	18.87	25.24	-175	2164	HORZ
B Mode Average	2483.50	54	74	35.12	48.49	18.88	25.51	-175	2164	HORZ
G Mode Peak	2483.50	54	74	35.11	48.37	18.89	25.63	-175	2164	HORZ
G Mode Average	2483.50	54	74	35.12	48.72	18.88	25.28	-175	2164	HORZ
N Mode Peak	2496.30	54	74	34.47	47.98	19.53	26.02	-175	2164	HORZ
N Mode Average	2483.50	54	74	35.10	48.75	18.90	25.25	-175	2164	HORZ

Table RE04.5: FCC restricted band from 2483.5 to 2500 MHz (EUT transmitting on channel 13)

The graphs below show the background spectrum observed during pre-scan, as well as the final data points from the table above.

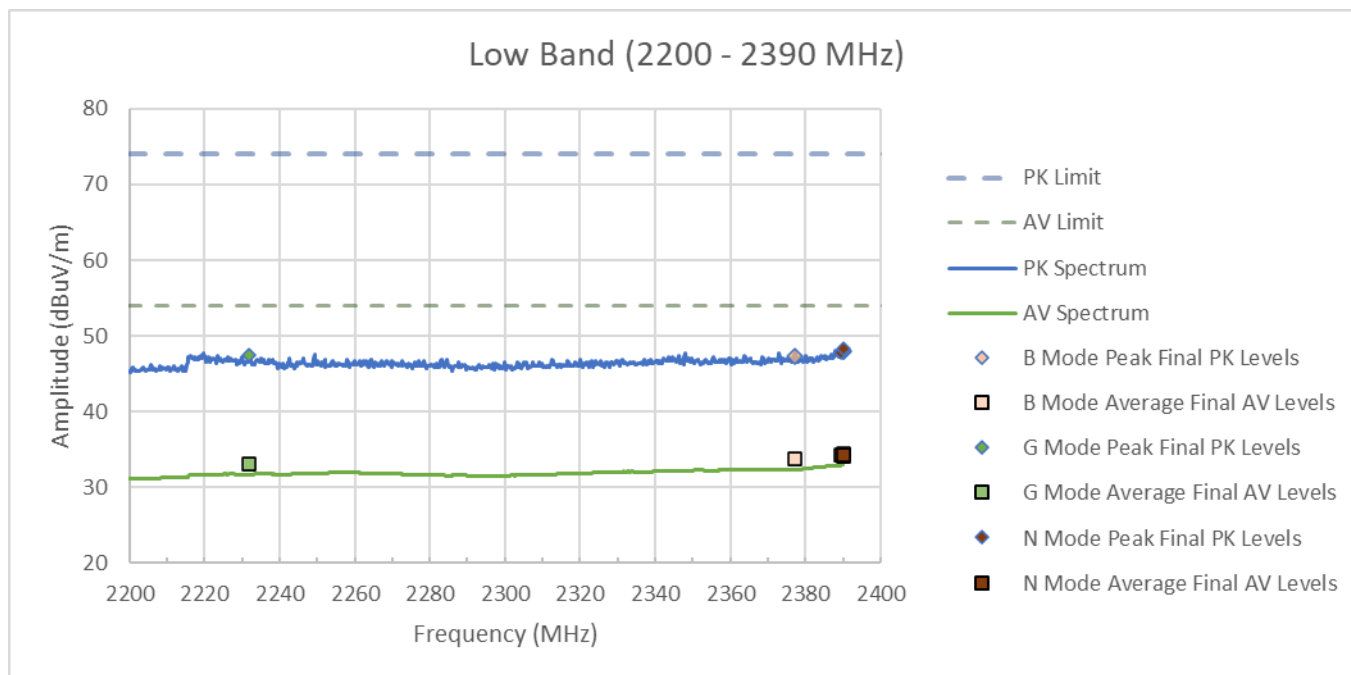

Figure RE04.1: FCC restricted band spectral data from 2200 to 2390 MHz (EUT transmitting on channel 1)

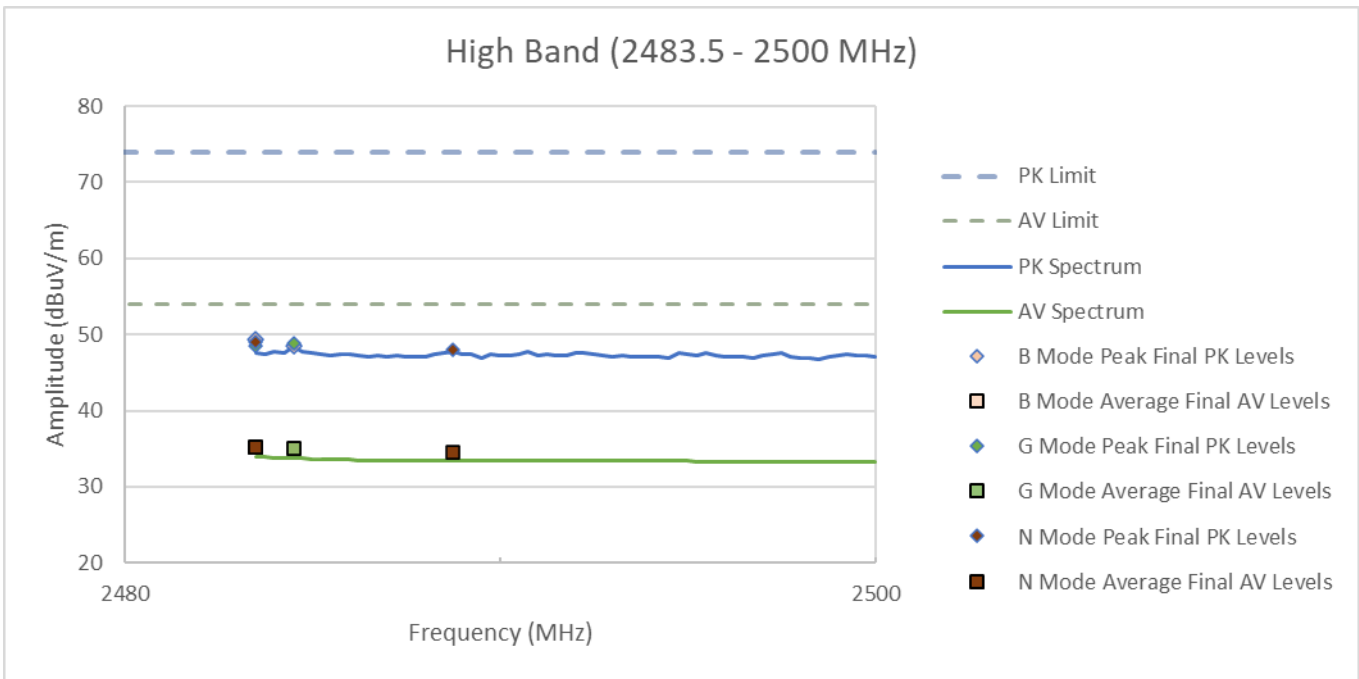

Figure RE04.2: FCC restricted band spectral data from 2483.5 to 2500 MHz (EUT transmitting on channel 11)

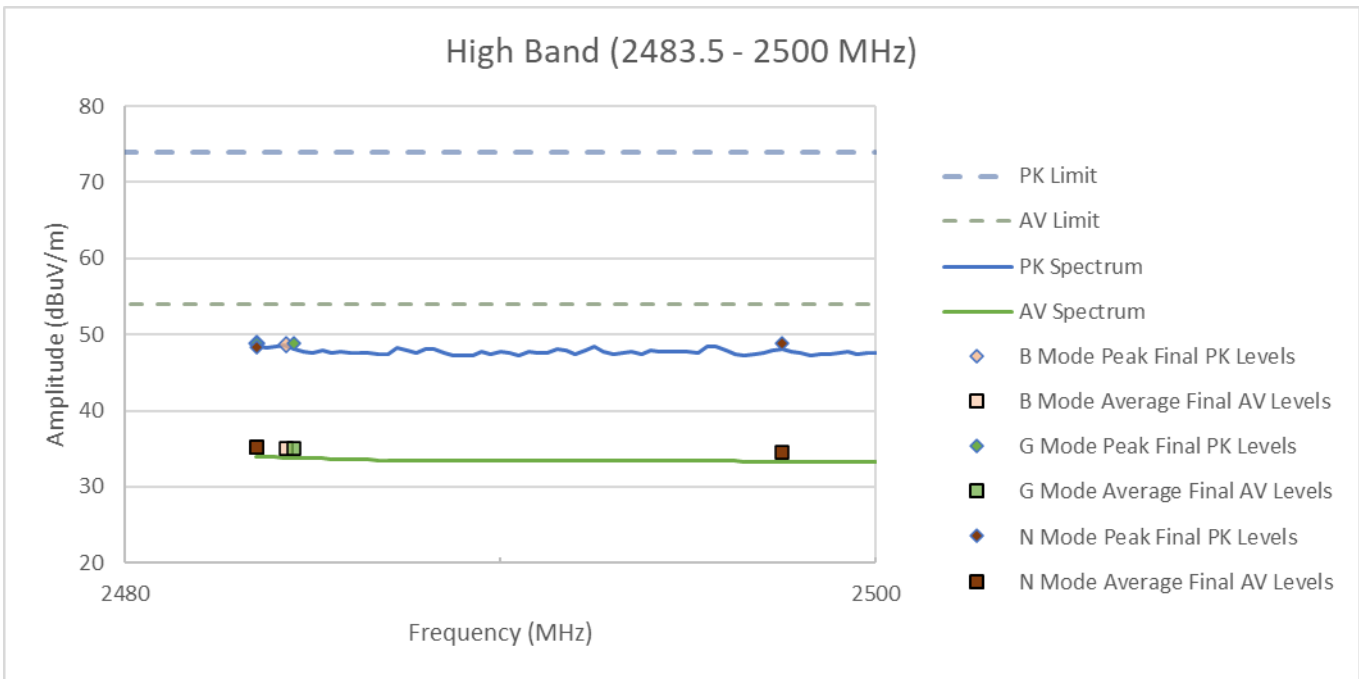

Figure RE04.3: FCC restricted band spectral data from 2483.5 to 2500 MHz (EUT transmitting on channel 12)

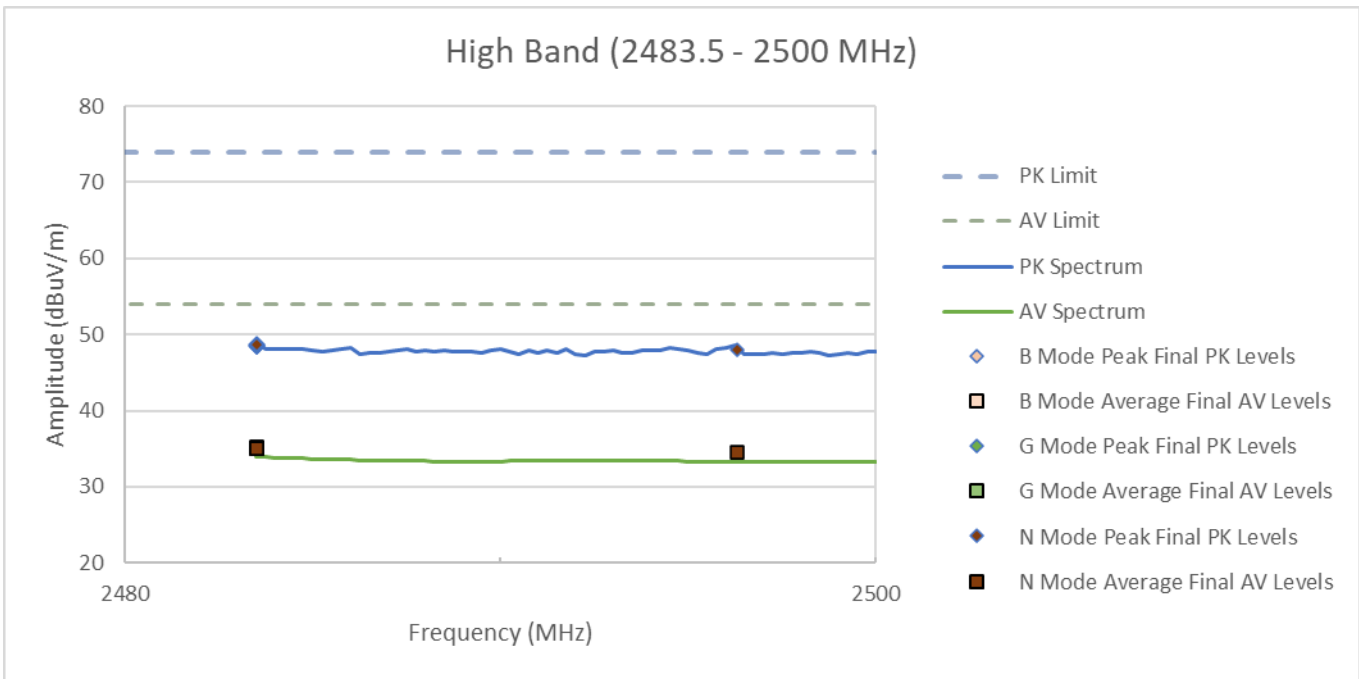

Figure RE04.4: FCC restricted band spectral data from 2483.5 to 2500 MHz (EUT transmitting on channel 13)

Setup Photographs

The following photographs show the EUT configured and arranged in the manner in which it was measured.

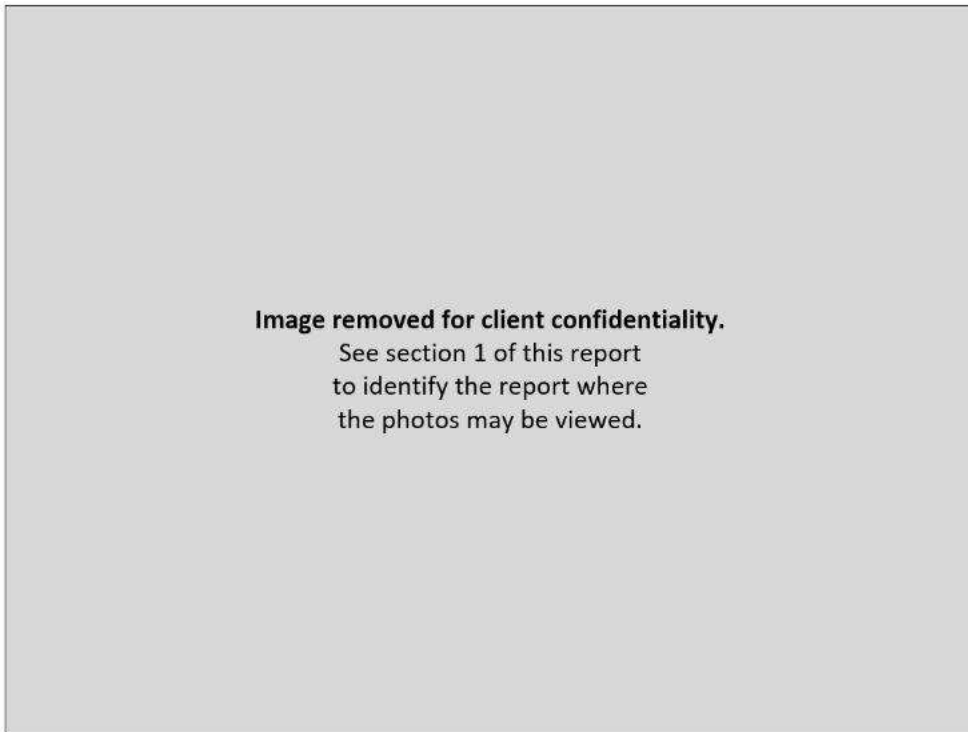

Figure RE04.5: EUT test setup, primary view

**Image removed for client confidentiality.**  
See section 1 of this report  
to identify the report where  
the photos may be viewed.

**Figure RE04.6: EUT test setup, reverse view**  
**This line is the end of the test record.**



**Test Record**  
**Transmitter Power Spectral Density**  
**Test IDs TR20 – TR22**  
**Project GCL-0437**

Test Date(s) 6,7 Feb 2024  
 Test Personnel Majid Farah

Product Model A04741  
 Serial Number tested 457910428

Operating Mode M3 (Ble Tx), M5 (ANT Tx), M7 (Wifi Tx)  
 Arrangement A4 (USB adaptor)  
 Input Power 5Vdc

Test Standards: FCC Part 15, ANSI C63.10, AS/NZS 4268, RSS-GEN, RSS-210, (as noted in Section 6 of the report).

Antenna Gain 2.51 dBi, as reported by the client  
 Radio Protocol Bluetooth Low Energy (BLE), ANT, and IEEE 802.11 b/g/n (WiFi)

**Pass/Fail Judgment: PASS**

**Test record created by: Jim Solum**  
**Date of this record: 9 Feb 2024**  
 Original record, Version A.

**Test Equipment Used**

Description	Make	Model #	Serial #	Last Cal/Ver	Next Due
PXE Receiver 44GHz	Keysight	N9048B	MY62220139	30-Jan-2023	6-Mar-2024

**Table TR20.1: Test equipment used**

**Software Used:** Keysight PXE software A.33.03

**Test Method**

The basic test standards provide options for the test method. The following test methods were applied.  
 ANSI C63.10: PKPSD (11.10.2)

**Test Setup**

This block diagram shows the test equipment setup.

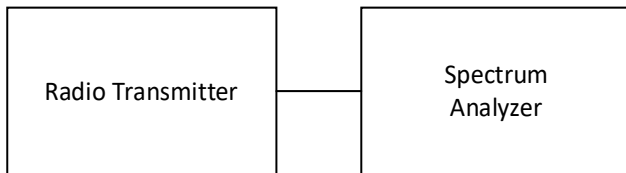

**Figure TR20.1: Test setup**

## Test Data

Each measurement is made conducted from the antenna port with the transmitter on a specified channel and in a selected transmission protocol. The results include the effects of any measurement cable losses. Results reported are in units of dBm/Bandwidth and do not include the effect of antenna gain. The standard limit is 8 dBm / 3 kHz, and meeting the limit with higher resolution bandwidths is permitted. All data met the limit using a 3 kHz resolution bandwidth.

For BLE operating at 2 Mbps, the lowest operating frequency was 2404 MHz, and the highest operating frequency was 2478 MHz. For all other Bluetooth, BLE, and ANT radios reported here, the lowest operating frequency was 2402 MHz, and the highest operating frequency was 2480 MHz.

The highest PSD levels for each mode are highlighted in yellow, and graphical results are provided for those cases.

	2402 (04)	2440	2480 (78)
BLE 1 Mbps	-18.18	-13.70	-17.26
BLE 2 Mbps	-13.71	-13.44	-18.17
ANT	-17.66	-12.27	-17.19

Table TR20.2: Summary of results of BLE, and ANT in dBm

	Ch1	Ch6	Ch11	Ch13
B1	-10.11	-1.18	-6.25	-5.59
G24	-14.00	-11.65	-14.32	-19.04
NMCS1	-16.59	-11.28	-15.42	-19.54

Table TR20.3: Summary of results of IEEE 802.11 b/g/n (WiFi) in dBm

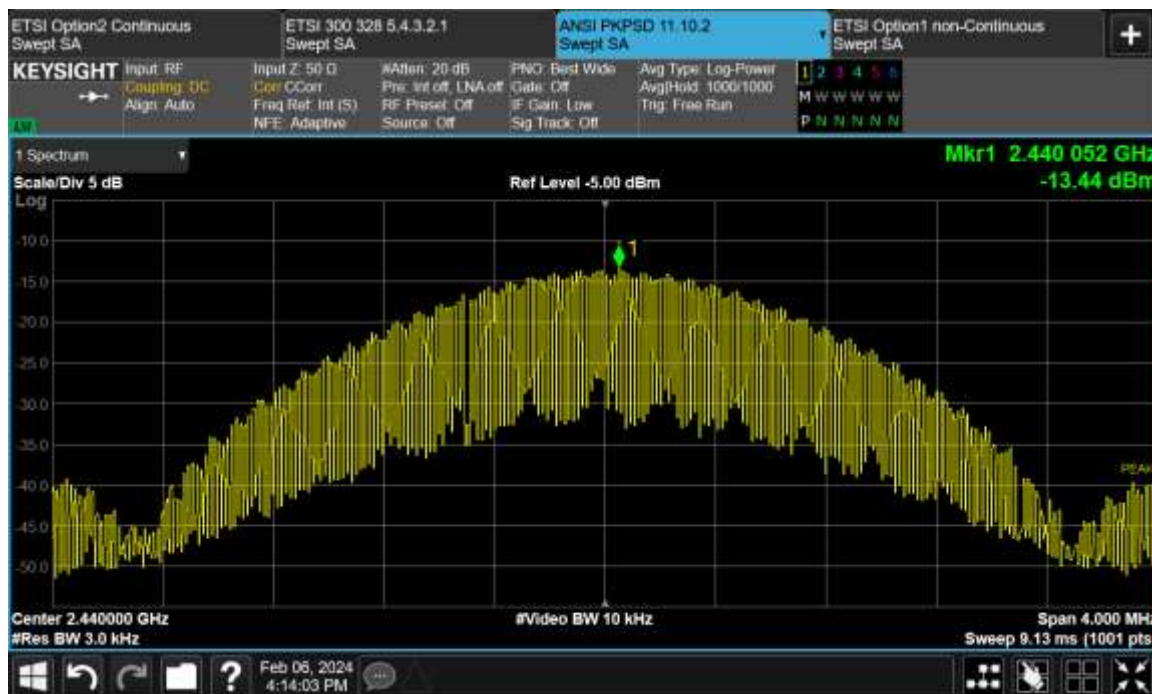

Figure TR20.2: Test data for BLE 2 Mbps, 2440 MHz



Figure TR20.3: Test data for ANT, 2440 MHz



Figure TR20.4: Test data for WiFi mode B1 Mbps, Ch6

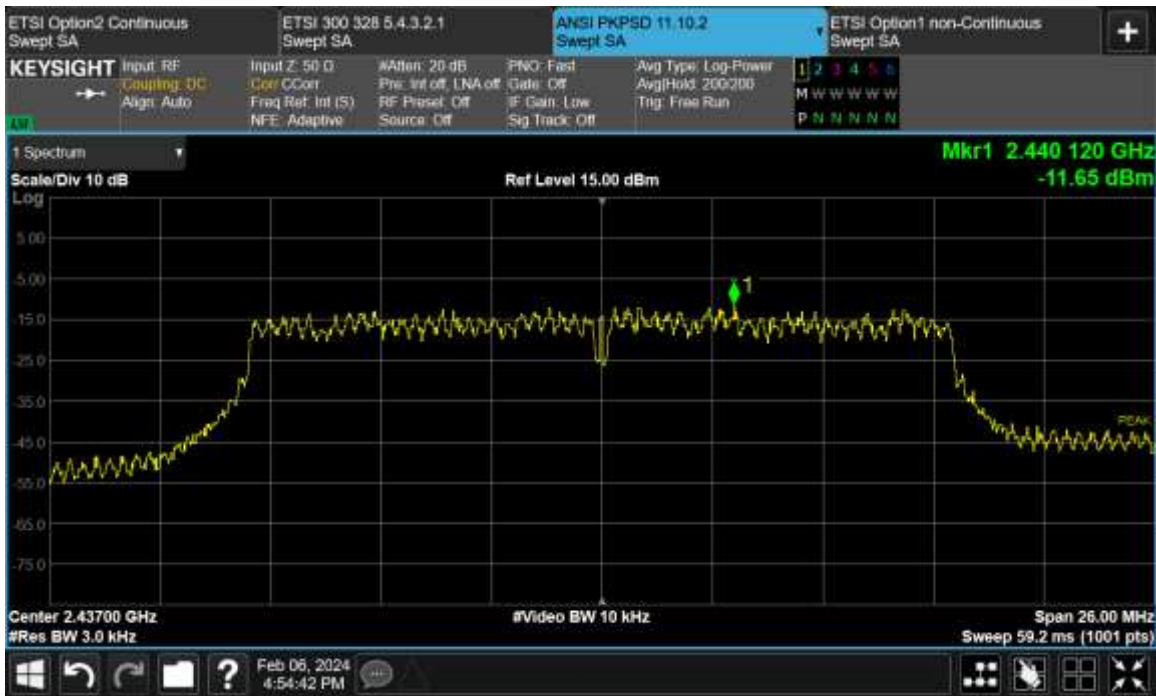

Figure TR20.5: Test data for WiFi mode G24 Mbps, Ch6

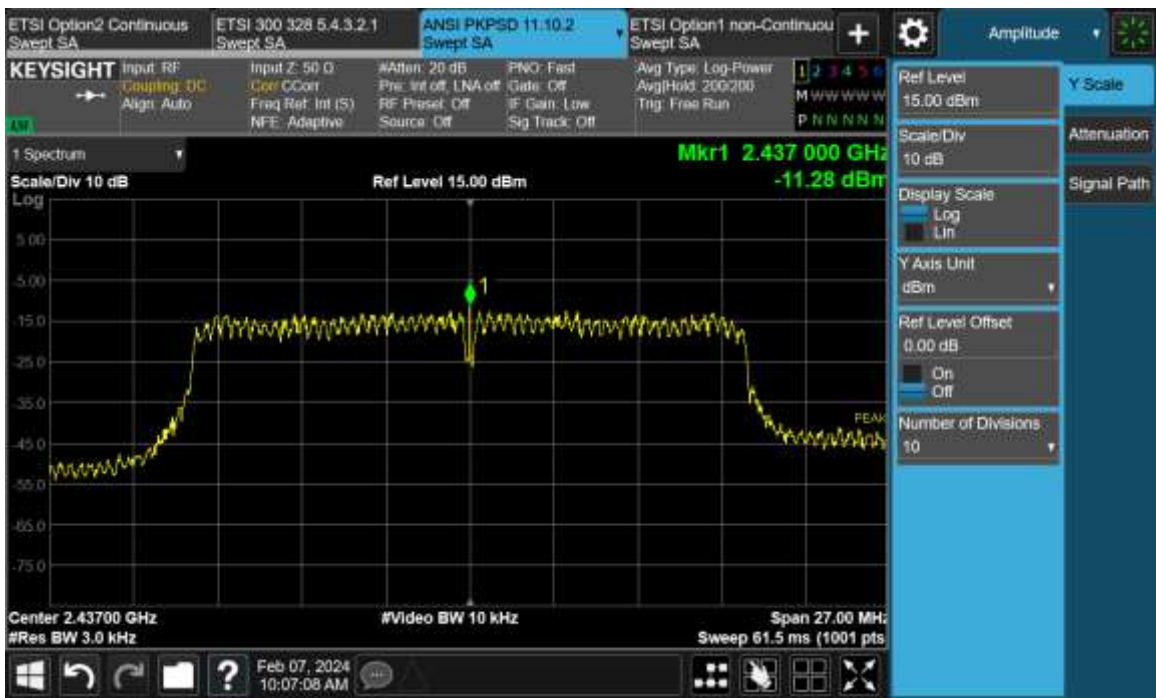

Figure TR20.6: Test data for WiFi mode N MCS1, Ch6

This line is the end of the test record.

**Test Record**  
**Transmitter Stability in Extreme Conditions**  
**Test ID TR43**  
**Project GCL-0437**

Test Date(s) 19,20 Feb 2024  
 Test Personnel Majid Farah

Product Model A04741  
 Serial Number tested 457910428

Operating Mode M5 (ANT Tx)  
 Arrangement A4 (USB adapter)  
 Nominal Input Power 5 Vdc

Test Standards: FCC part 15, RSS-GEN, ANSI C63.10 (as noted in Section 6 of the report)

Radio Protocol ANT

**Pass/Fail Judgment: PASS**

**Test record created by: Jim Solum**  
**Date this record: 20 Feb 2024**  
 Original record, Version A.

**Test Equipment**

Description	Make	Model #	Serial #	Last Cal/Ver	Next Due
PXE Receiver 44GHz	Keysight	N9048B	MY62220139	30-Jan-2023	6-Mar-2024
Programmable DC power source	Keithley	2260B-30-72 720 W	1411917	21-Apr-2023	15-Apr-2024
Thermometer	Thermco	ACCD370P	220608121	26-Aug-2022	1-Sep-2024
Thermal Chamber	Tenney	T2RC	32774-02	Calibration	Not Required

**Table TR43.1: Equipment used**

Software Used: PXE Software Revision A.33.03, FrequencyStabilityAnalysisTemplateV1.xlsx

**Test Method**

The standards cited require observation of the stability for transmission frequency and/or power at certain environmental extremes. The reference is performance on nominal input voltage and a temperature of 20 °C. Where the standards cited here impose different limits or conditions, the most stringent limits and conditions have been applied.

The acceptance criterion is that the 6 dBc Occupied Bandwidth of the modulated signal should remain within the 2400-2483.5 MHz radio band. The modes utilized include those that showed emissions closest to the band edge during prior bandwidth testing. Specifically, the ANT transmitter was tested to indicate the stability of frequency-determining circuits that provide Bluetooth, BLE, and ANT signals.

**Test Data**

The test sample(s) were subjected to extreme conditions and performed as shown below. Yellow highlights indicate the highest level for a protocol, for which an image of the spectrum is also provided. In the spectral plots, the data sets have been combined to present the low and high channel results side by side. Orange diamond markers indicate the spectral peak, which the black square markers are at the 2400 MHz or 2483.5 MHz band edge.

Tx Mode	Temp	Volts	Low Ch.	High Ch.
	°C	Vdc	dBc	dBc
ANT	50	5	24.3	44.1
ANT	40	5	25.9	43.0
ANT	30	5	24.3	41.3
ANT	20	5	24.0	41.4
ANT	10	5	24.1	43.9
ANT	0	5	25.5	42.8
ANT	-10	5	25.7	43
ANT	-20	5	24	43.6

Table TR43.2 Difference between peak and band edge levels for ANT transmissions during temperature variations

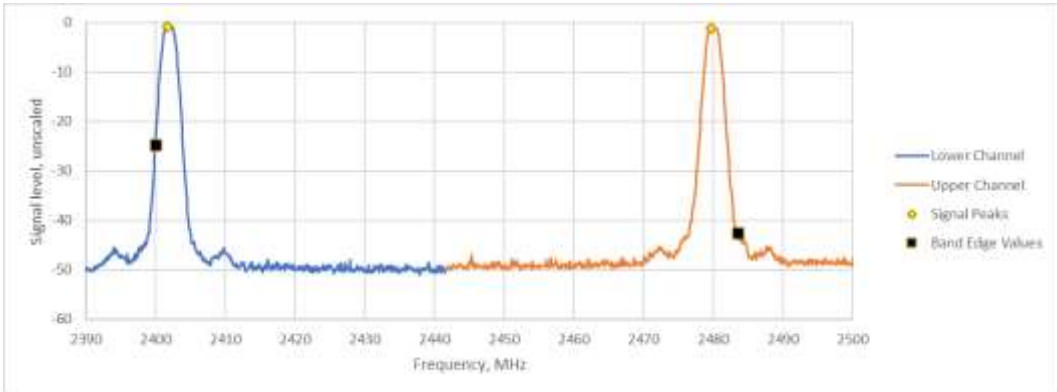

Figure TR43.1: Spectral data for ANT at 20 °C which represent low and high channel.

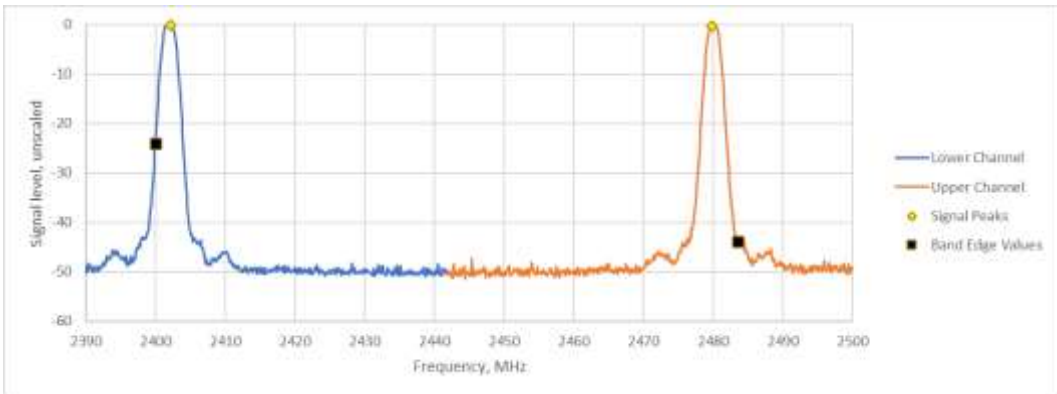

Figure TR43.2: Spectral data for ANT at -20 °C which represent low and high channel.

Tx Mode	Temp	Volts	Low Ch.	High Ch.
	°C	Vdc	dBc	dBc
ANT	20	4.25	23.2	42.7
ANT	20	5	24.0	41.4
ANT	20	5.75	24.8	43

Table TR43.3 Difference between peak and band edge levels for ANT transmissions at 20 °C during voltage variations

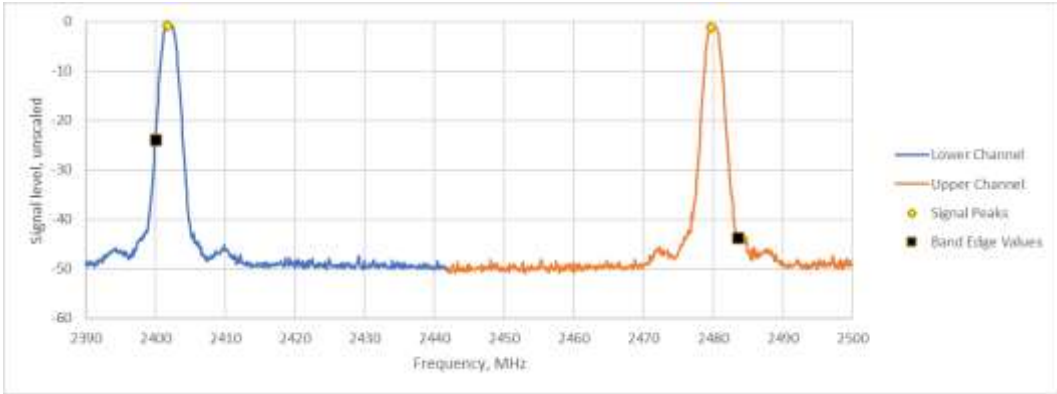

Figure TR43.3: Spectral data for ANT at 20 °C and 4.25 Vdc which represent low and high channel.

**Setup Block Diagram**

The following block diagrams show the EUT configured and arranged in the manner which it was measured.

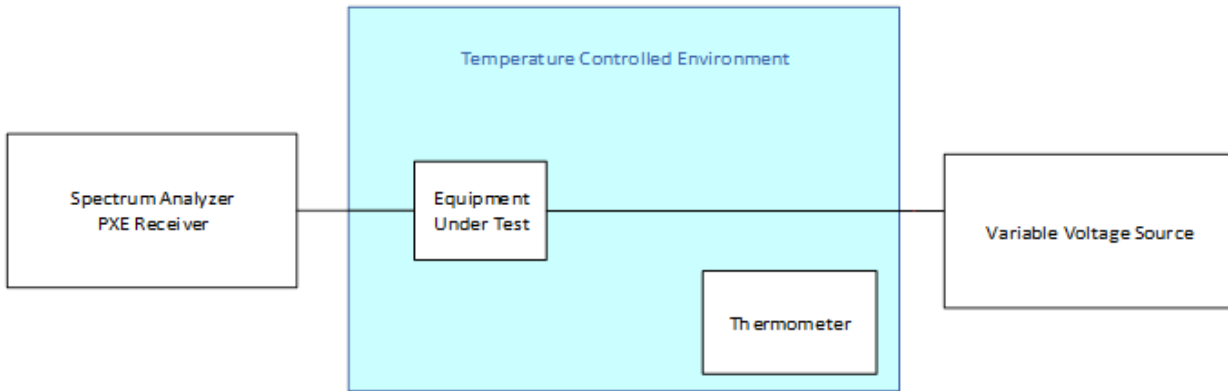

Figure TR43.4: Schematic drawing of the test equipment setup

This line is the end of the test record.

**Test Record**  
**Transmitter Stability in Extreme Conditions**  
**Test ID TR44**  
**Project GCL-0437**

Test Date(s) 19,20 Feb 2024  
 Test Personnel Majid Farah

Product Model A04741  
 Serial Number tested 457910428

Operating Mode M7 (Wifi Tx)  
 Arrangement A4 (USB adaptor)  
 Nominal Input Power 5 Vdc

Test Standards: FCC part 15, RSS-GEN, ANSI C63.10 (as noted in Section 6 of the report)

Radio Protocol WiFi (IEEE 802.11 b/g/n)

**Pass/Fail Judgment: PASS**

**Test record created by: Jim Solum**  
**Date this record: 20 Feb 2024**

Original record, Version A.

**Test Equipment**

Description	Make	Model #	Serial #	Last Cal/Ver	Next Due
PXE Receiver 44GHz	Keysight	N9048B	MY62220139	30-Jan-2023	6-Mar-2024
Programmable DC power source	Keithley	2260B-30-72 720 W	1411917	21-Apr-2023	15-Apr-2024
Thermometer	Thermco	ACCD370P	220608121	26-Aug-2022	1-Sep-2024
Thermal Chamber	Tenney	T2RC	32774-02	Calibration	Not Required

**Table TR44.1: Equipment used**

Software Used: PXE Software Revision A.33.03, FrequencyStabilityAnalysisSystemTemplateV1.xlsx

**Test Method**

The standards cited require observation of the stability for transmission frequency and/or power at certain environmental extremes. The reference is performance on nominal input voltage and a temperature of 20 °C. Where the standards cited here impose different limits or conditions, the most stringent limits and conditions have been applied.

The acceptance criterion is that the 6 dBc Occupied Bandwidth of the modulated signal should remain within the 2400-2483.5 MHz radio band.

The modes utilized include those that showed emissions closest to the band edge during prior bandwidth testing.

**Test Data**

The test sample(s) were subjected to extreme conditions and performed as shown below. Yellow highlights indicate the highest level for a protocol, for which an image of the spectrum is also provided. In the spectral plots, the data sets have been combined to present the low and high channel results side by side. Orange diamond markers indicate the spectral peak, which the black square markers are at the 2400 MHz or 2483.5 MHz band edge.



Tx Mode	Temp	Volts	Ch. 1	Ch. 11	Ch. 13
WiFi	°C	Vdc	dBc	dBc	dBc
N MCS5	50	5	36	40.5	38.6
N MCS5	40	5	37	37.9	40.1
N MCS5	30	5	37.1	38.7	39.3
N MCS5	20	5	36.2	37.2	39.5
N MCS5	10	5	35.2	37.3	39.6
N MCS5	0	5	35.9	35.9	37.6
N MCS5	-10	5	33.3	37.9	38.0
N MCS5	-20	5	34.4	34.9	38.4

Table TR44.2 Difference between peak and band edge levels for IEEE 802.11 n MCS5 transmissions during temperature variations.

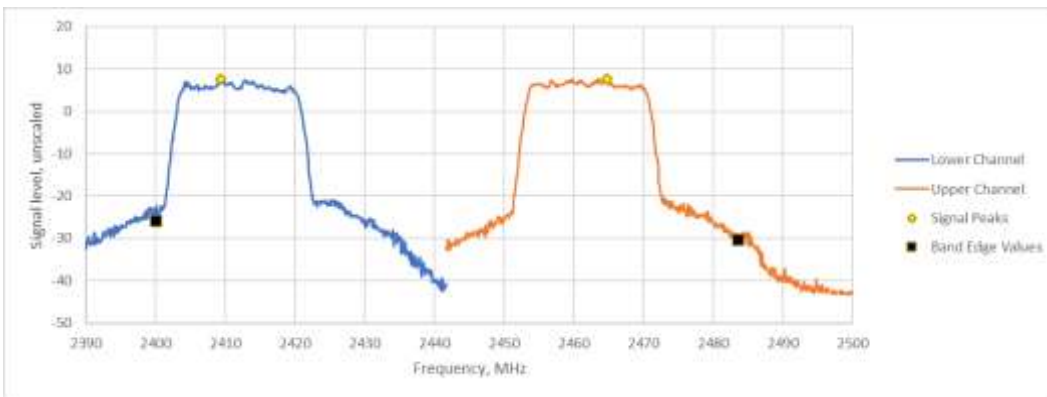

Figure TR44.1: Spectral data for IEEE 802.11 n MCS5 at -10 °C which represents Ch1 and Ch11.

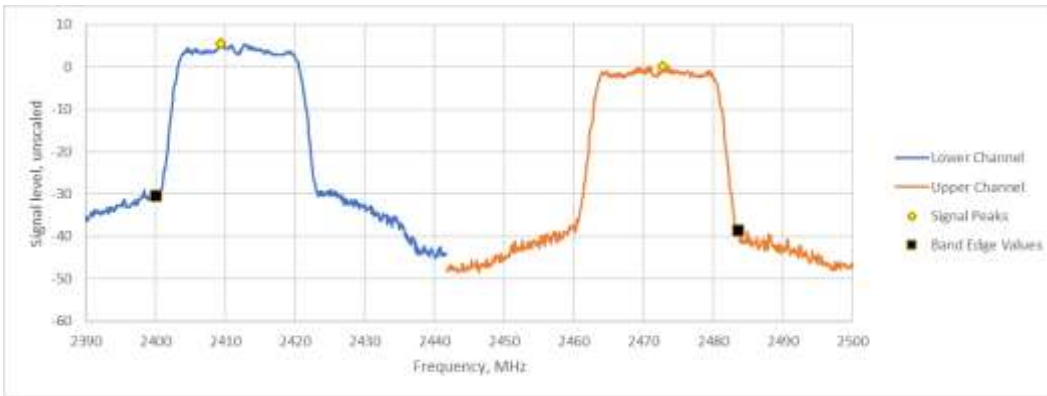

Figure TR44.2: Spectral data for IEEE 802.11 n MCS5 at -10 °C which represents Ch1 and Ch13.

Tx Mode	Temp	Volts	Ch. 1	Ch. 11	Ch. 13
WiFi	°C	Vdc	dBc	dBc	dBc
N MCS5	20	4.25	34	37.4	39.0
N MCS5	20	5	36.2	37.2	39.5
N MCS5	20	5.75	35.9	36.7	40.1

Table TR44.3 Difference between peak and band edge levels for IEEE 802.11 n MCS5 transmissions at 20 °C during voltage variations.

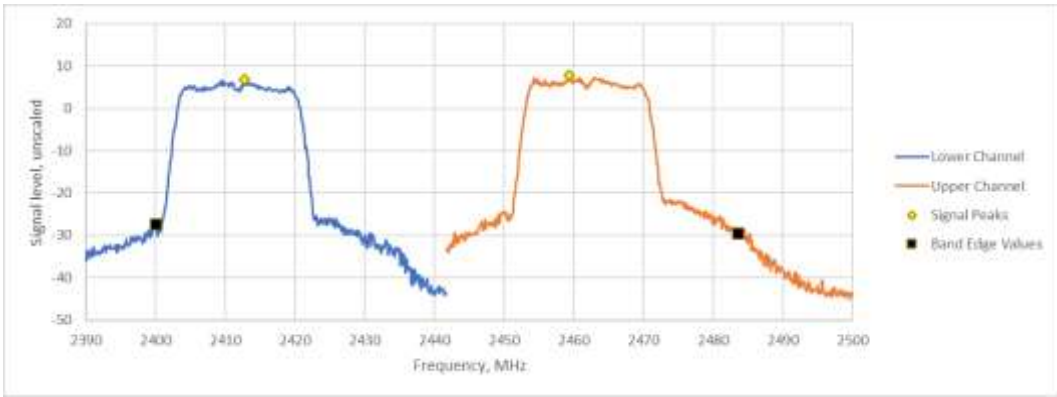

Figure TR44.3: Spectral data for IEEE 802.11 n MCS5 at 20 °C and 4.25 Vdc which represents Ch1 and Ch11.

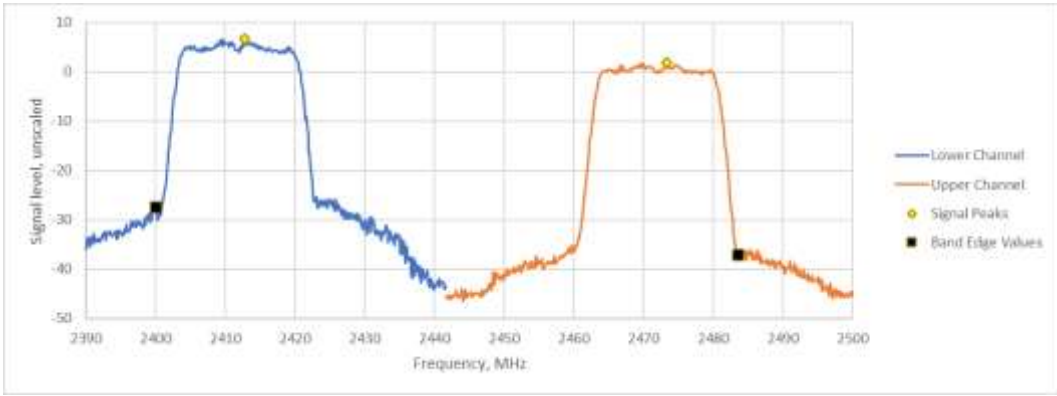

Figure TR44.4: Spectral data for IEEE 802.11 n MCS5 at 20 °C and 4.25 Vdc which represents Ch1 and Ch13.

**Setup Block Diagram**

The following block diagrams show the EUT configured and arranged in the manner which it was measured.

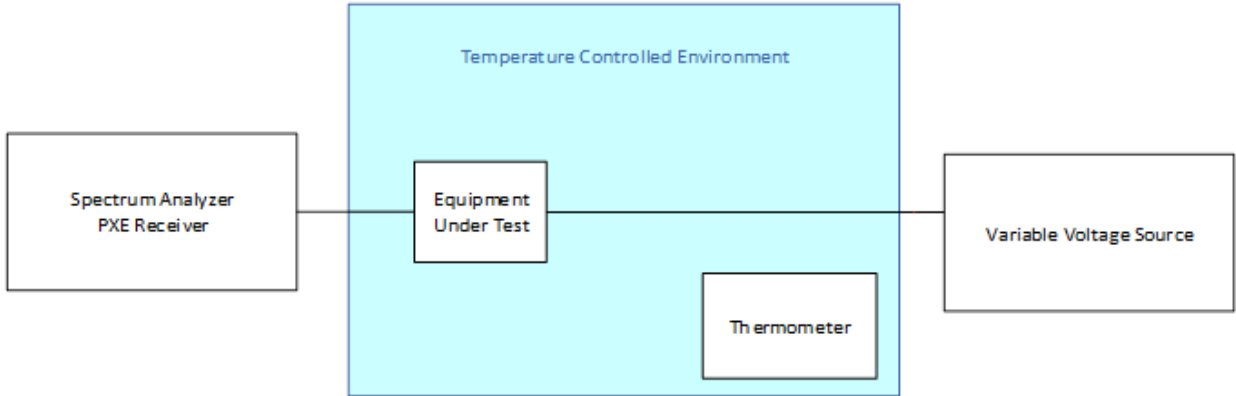

Figure TR44.5: Schematic drawing of the test equipment setup

This line is the end of the test record.

**Test Record**  
**Radiated Emission Test RE05**  
**Project GCL0437**

Test Date(s) 09 Feb 2024  
 Test Personnel David Kerr

Product Model A04741  
 Serial Number tested 457910369

Operating Mode M7 (Wifi Tx)  
 Arrangement A4 (USB adaptor)  
 Input Power USB 5 Vdc

Test Standards: FCC Part 15, ANSI C63.10 (as noted in Section 6 of the report).

Frequency Range: 30 MHz to 1000 MHz  
**Pass/Fail Judgment: PASS**

**Test record created by: David A Kerr**  
**Date of this record: 09 Feb 2024**  
 Original record, Version A.

**Test Equipment**

Description	Make	Model #	Serial #	Last Cal/Ver	Next Due
PXE Receiver 26 GHz	Keysight	N9048B	MY59290135	27-Sep-2023	1-Oct-2024
Antenna, Biconilog, 30M-6 GHz	ETS Lindgren	3142E	233204	2-Nov-2023	1-Nov-2025
SAC 3m, below 1 GHz	Frankonia	SAC3	F199004	7-Nov-2022	7-Nov-2025
Tape measure, 1" x 33'	Lufkin	PHV1410CMEN	10720	16-Jan-2023	15-Jan-2026

**Table RE05.1: Test Equipment Used**

**Software Used**

N9048B Keysight PXE firmware version A.32.06  
 EPX/RE automation software ver. 2023.01.001

## Test Data

The radiated emission test process began with a preliminary scan at multiple turntable angles, antenna heights, and both antenna polarizations. For test standards that require reorienting the test sample, further preliminary scans were taken in those alternate orientations typically described as X, Y, and Z. Subsequent testing was done using the orientation(s) producing the highest result relative to the test limit. Where the test standard requires cable manipulation, this was done at one of more likely worst case frequencies selected by the test personnel while observing the receiver display. At each of the frequencies selected for final measurements, the turntable angle, antenna height, and antenna polarization were explored to find the worst-case settings. Final field strength measurements were taken in that set of positions. Full maximization was not performed at frequencies that are noise floor measurements included per the test standard requirements.

At azimuth angle 180° the 'front' reference mark of the turntable is pointed Southward. At 270° the reference mark points West. At 90° it points East. At 173° the turntable reference mark is pointed directly at the antenna. The designation of the X, Y, and Z orientations of the test sample are sample dependent, so these are reported by use of photographs.

The table shows the selected final measurement data between 30 MHz and 1 GHz. It includes at least the six strongest emissions observed relative to the test limit, along with other data points of interest. Where a data point is highlighted is yellow, this is an aid to indicate the data point(s) with the least margin to the test limit. A positive margin value indicates that the emission was below the test limit. The test limit is the FCC Class B Limit at 3m. Any unintentional radio emission limits are not applied to intentional radio signals.

Frequency	Pol.	Reading	Factor	Level	Limit	Margin	Height	Angle
MHz		dB(μV)	dB(1/m)	dB(μV/m)	dB(μV/m)	dB	cm	deg
		QP		QP	QP	QP		
181.740	H	6.8	18.4	25.2	43.5	18.3	168.2	186.0
271.170	H	14.9	22.1	37.0	46.0	9.0	100.0	47.0
320.400	H	13.5	22.6	36.1	46.0	9.9	100.0	359.0
779.100	H	3.2	34.1	37.3	46.0	8.7	269.6	44.0
955.230	H	3.5	36.5	40.0	46.0	6.0	306.5	111.0
44.970	V	1.6	15.3	16.9	40.0	23.1	100.0	317.0

**Table RE05.2: Emission summary**

The graph below shows the background spectrum observed during pre-scan, as well as the final data points from the table above.

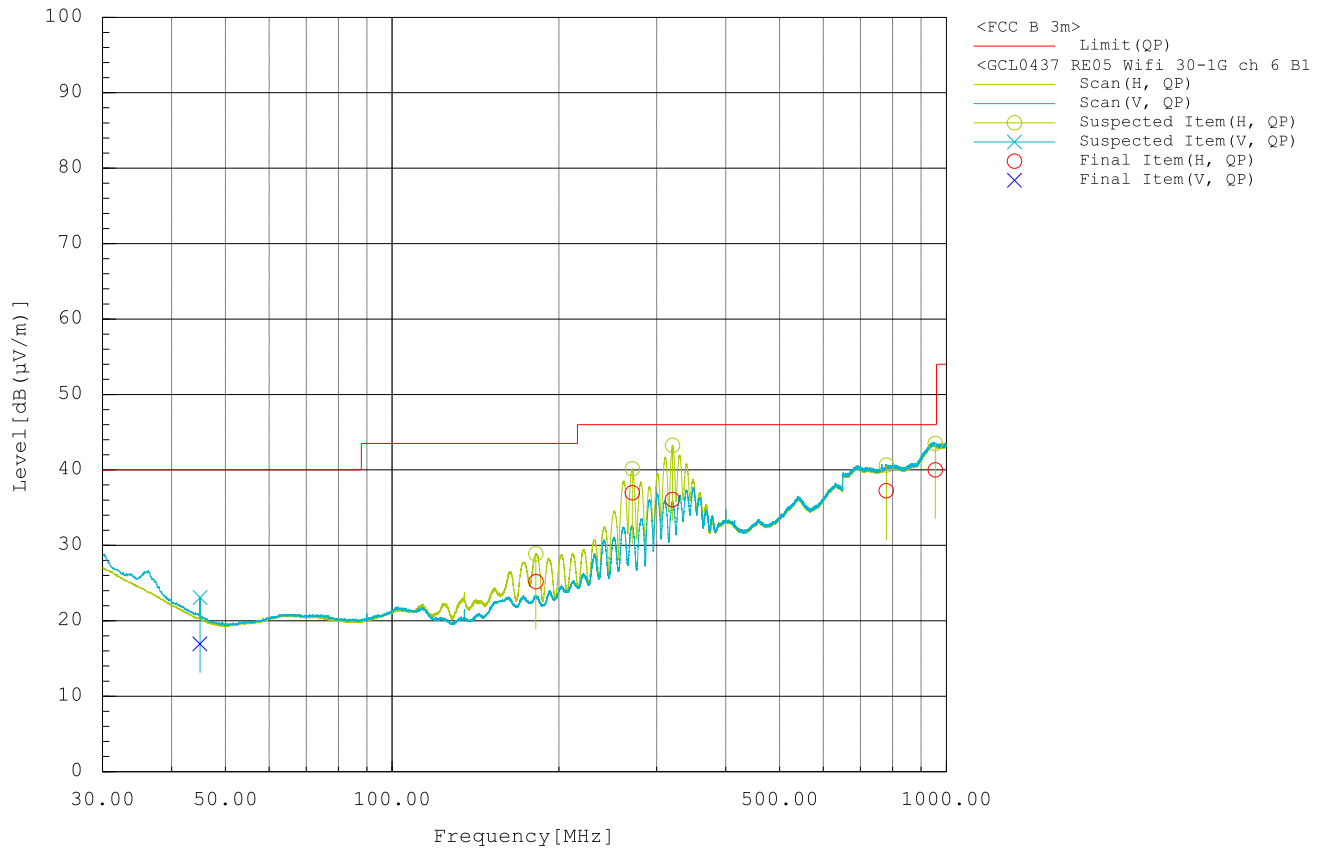

**Figure RE05.1: Spectral data**

**Setup Photographs**

The following photographs show the EUT configured and arranged in the manner in which it was measured.

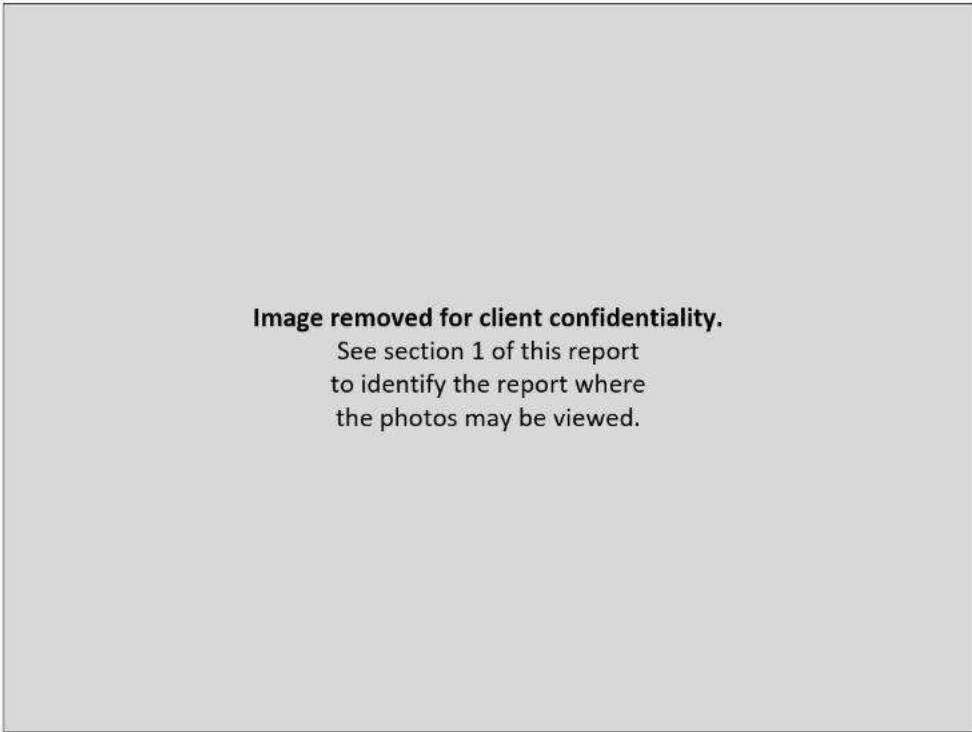

**Figure RE05.2: EUT test setup, front view**

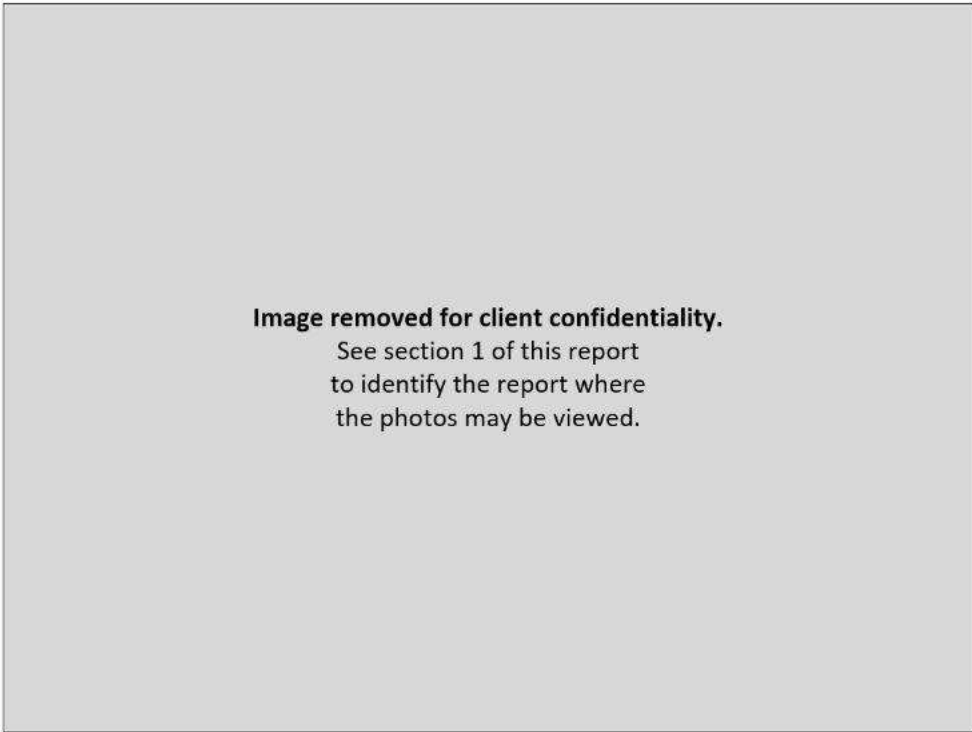

**Figure RE05.3: EUT test setup, reverse view**

**This line is the end of the test record.**

**Test Record**  
**Radiated Emission Test RE11**  
**Project GCL0437**

Test Date(s) 16 Feb 2024  
 Test Personnel David Kerr

Product Model A04741  
 Serial Number tested 457910369

Operating Mode M7 (Wifi Tx)  
 Arrangement A4 (USB adaptor)  
 Input Power USB 5 Vdc

Test Standards: FCC Part 15, ANSI C63.10 (as noted in Section 6 of the report).

Frequency Range: 1000 MHz to 2200 MHz  
**Pass/Fail Judgment: PASS**

**Test record created by: David A Kerr**  
**Date of this record: 16 Feb 2024**  
 Original record, Version A.

**Test Equipment**

Description	Make	Model #	Serial #	Last Cal/Ver	Next Due
PXE Receiver 26 GHz	Keysight	N9048B	MY59290135	27-Sep-2023	1-Oct-2024
Antenna, Horn, 1-18 GHz	ETS Lindgren	3117	227596	14-Sep-2023	14-Sep-2025
FSOATS 3m, above 1 GHz	Frankonia	SAC3	F199004	16-Nov-2022	16-Nov-2025
Tape measure, 1" x 33'	Lufkin	PHV1410CMEN	10720	16-Jan-2023	15-Jan-2026
Preamplifier, 500 MHz 18 GHz	Com-Power	PAM-118A	18040133	Calibration	Not Required
Wifi Filter	K&L	8NSL26-2437/E82.2-0/0	1	Calibration	Not Required

**Table RE11.1: Test Equipment Used**

**Software Used** N9048B  
 Keysight PXE firmware version A.32.06  
 EPX/RE automation software ver. 2023.01.001

**Test Data**

The radiated emission test process began with a preliminary scan at multiple turntable angles, antenna heights, and both antenna polarizations. For test standards that require reorienting the test sample, further preliminary scans were taken in those alternate orientations typically described as X, Y, and Z. Subsequent testing was done using on the orientation(s) producing the highest result relative to the test limit. Where the test standard requires cable manipulation, this was done at one of more likely worst case frequencies selected by the test personnel while observing the receiver display. At each of the frequencies selected for final measurements, the turntable angle, antenna height, and antenna polarization were explored to find the worst-case settings. Final field strength measurements were taken in that set of positions. Full maximization was not performed at frequencies that are noise floor measurements included per the test standard requirements.

At azimuth angle 180° the ‘front’ reference mark of the turntable is pointed Southward. At 270° the reference mark points West. At 90° it points East. At 173° the turntable reference mark is pointed directly at the antenna. The designation of the X, Y, and Z orientations of the test sample are sample dependent, so these are reported by use of photographs.

The table shows the selected final measurement data between 1 GHz and 2.2 GHz. It includes at least the six strongest emissions observed relative to the test limit, along with other data points of interest. Where a data point is highlighted is yellow, this is an aid to indicate the data point(s) with the least margin to the test limit. A positive margin value indicates that the emission was below the test limit. The test limit is the FCC Class B Limit at 3m. Any unintentional radio emission limits are not applied to intentional radio signals.

No emissions were observed within 20 dB of the limit. A representative noise floor measurement is provided.

Frequency MHz	Pol.	Reading		Factor	Level		Limit		Margin		Height cm	Angle deg	
		dB(μV)			dB(1/m)	dB(μV/m)		dB(μV/m)		dB			
		CAV	PK			CAV	PK	AV	PK	CAV			PK
2138.000	H	32.7	46.3	-1.2	31.5	45.1	54.0	74.0	22.5	28.9	323.8	347.0	

**Table RE11.2: Emission summary (Ch1 B1)**

Frequency MHz	Pol.	Reading		Factor	Level		Limit		Margin		Height cm	Angle deg	
		dB(μV)			dB(1/m)	dB(μV/m)		dB(μV/m)		dB			
		CAV	PK			CAV	PK	AV	PK	CAV			PK
2147.250	V	32.7	46.0	-1.2	31.5	44.8	54.0	74.0	22.5	29.2	328.9	30.0	

**Table RE11.3: Emission summary (Ch6 B1)**

Frequency MHz	Pol.	Reading		Factor	Level		Limit		Margin		Height cm	Angle deg	
		dB(μV)			dB(1/m)	dB(μV/m)		dB(μV/m)		dB			
		CAV	PK			CAV	PK	AV	PK	CAV			PK
2138.000	H	32.7	46.3	-1.2	31.5	45.1	54.0	74.0	22.5	28.9	323.8	347.0	

**Table RE11.4: Emission summary (Ch 11 B1)**

The graph below shows the background spectrum observed during pre-scan, as well as the final data points from the table above.



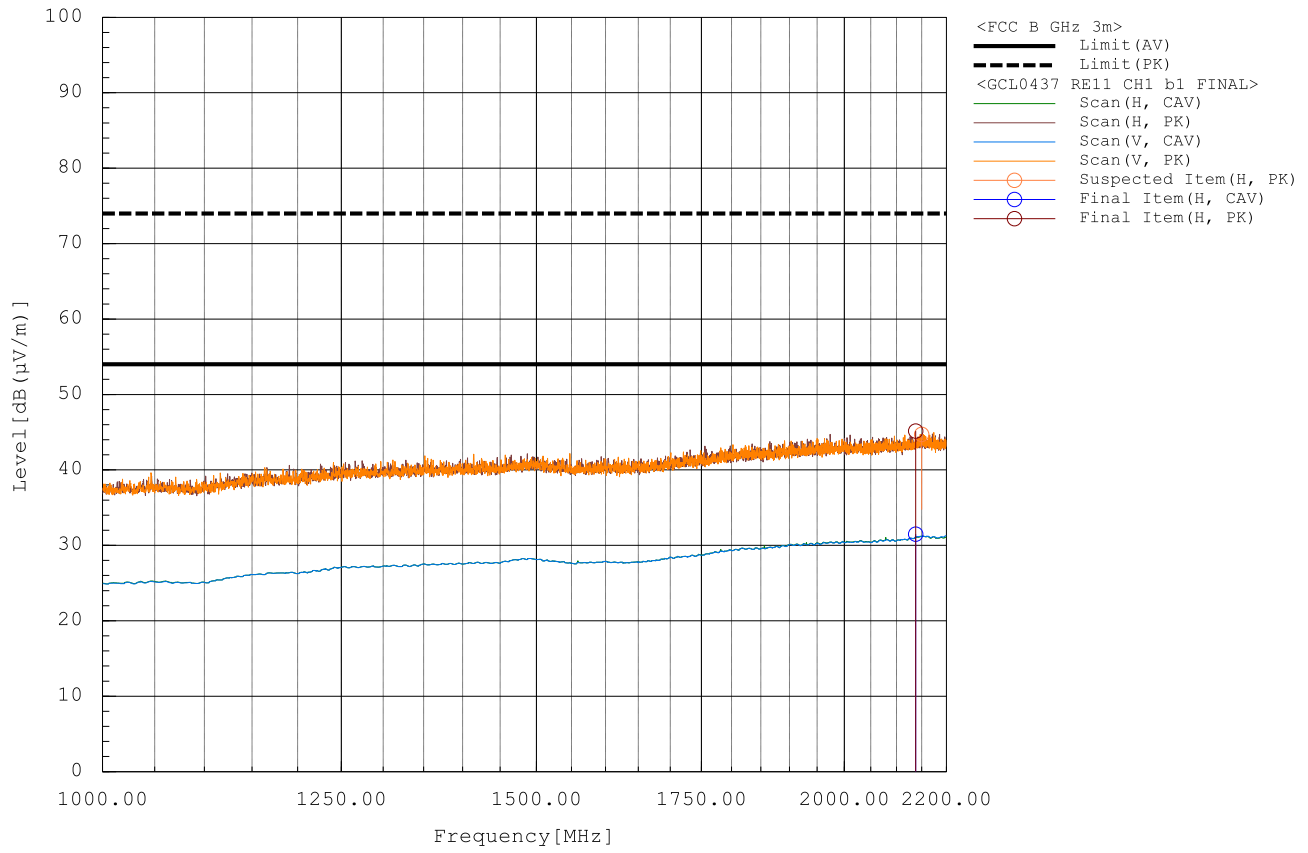
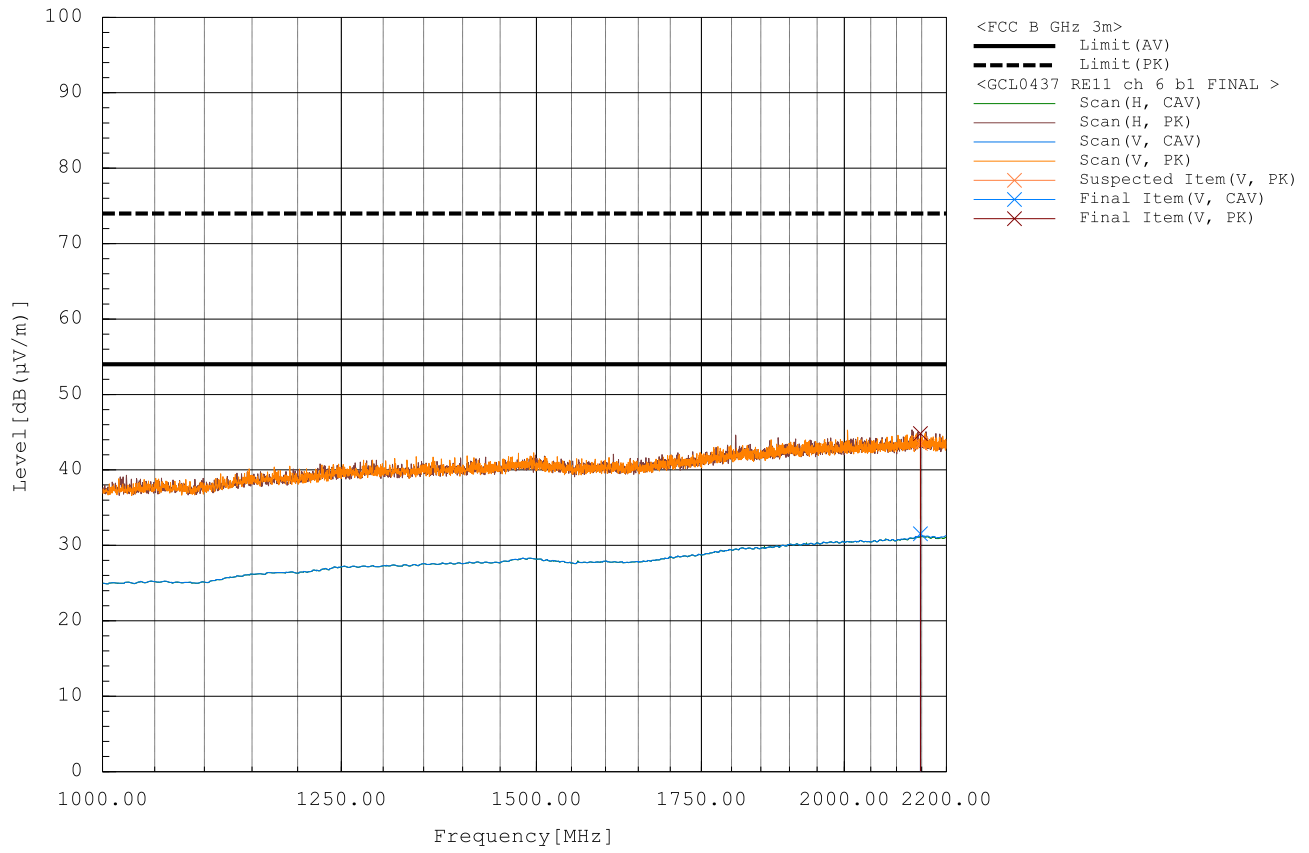
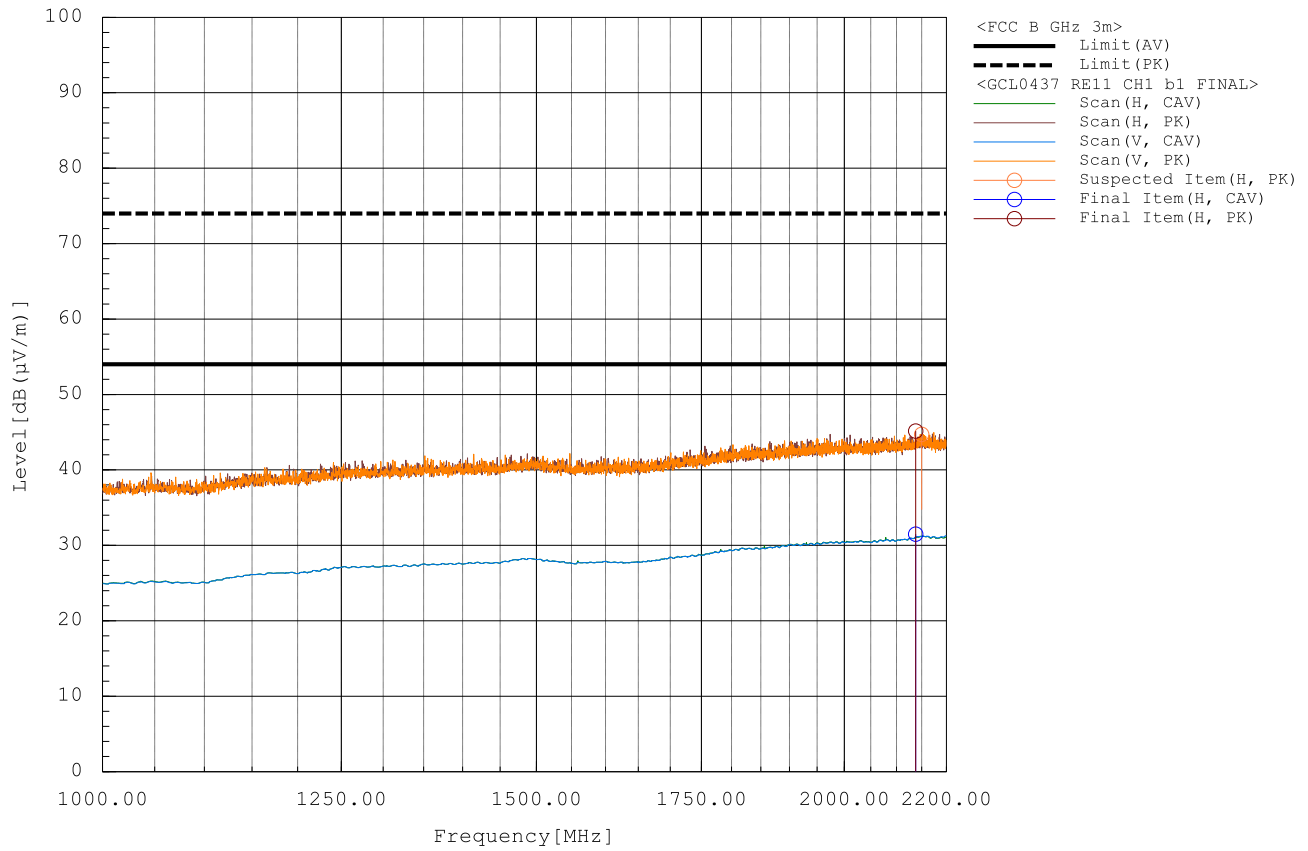

Figure RE11.1: Spectral data (Ch 1 B1)



**Figure RE11.2: Spectral data (Ch6 B1)**



**Figure RE11.3: Spectral data (Ch11 B1)**

**Setup Photographs**

The following photographs show the EUT configured and arranged in the manner in which it was measured.

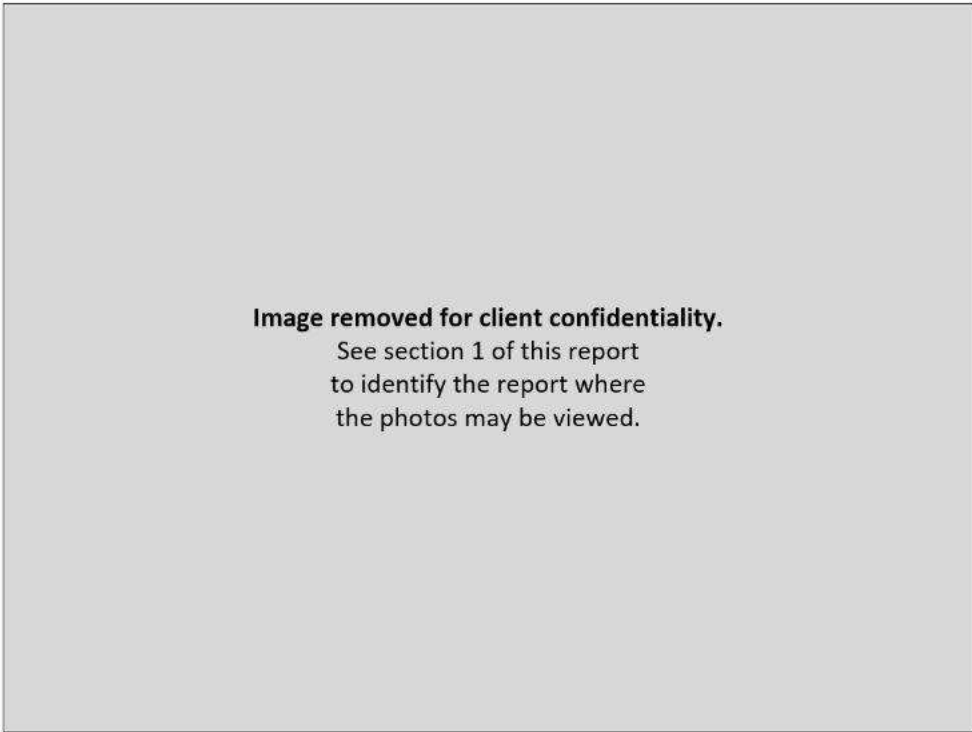

**Figure RE11.4: EUT test setup, front view**

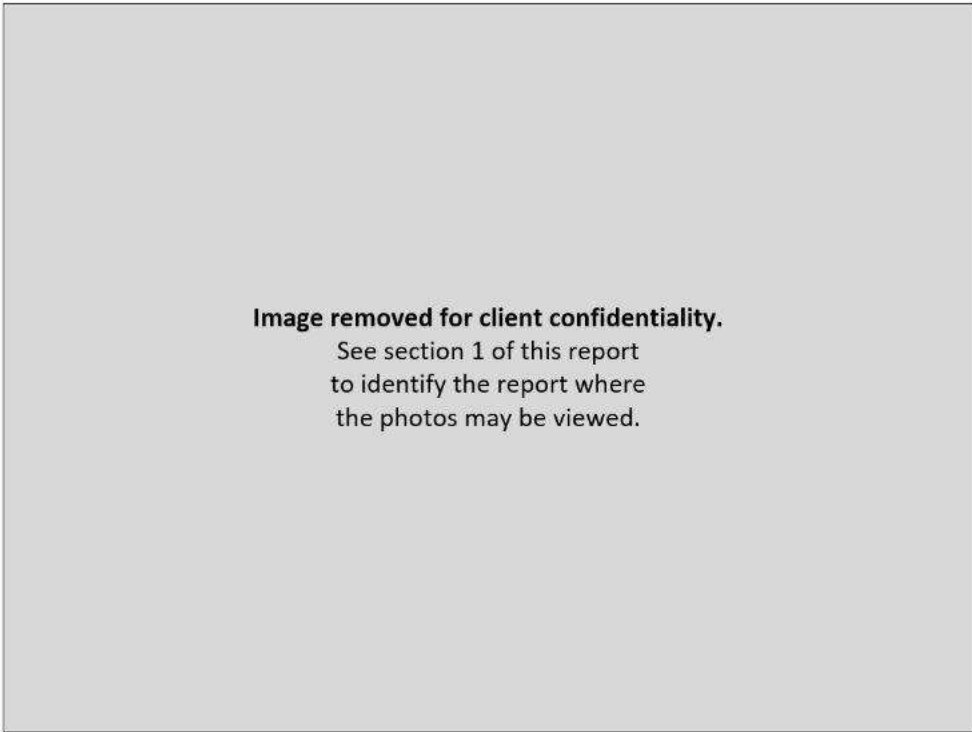

**Figure RE11.5: EUT test setup, reverse view**

**This line is the end of the test record.**

## Test Record

### Conducted Emissions Mains Test CE01

#### Project GCL0437

Test Date(s) 20 Feb 2024  
Test Personnel David Kerr

Product Model A04741  
Serial Number tested 457910369

Operating Mode M7 (Wifi Tx)  
Arrangement A4 (USB adaptor)  
Input Power 120 Vac 60 Hz

Test Standards: FCC Part 15 (as noted in Section 6 of the report).

Frequency Range: 150 kHz to 30 MHz  
**Pass/Fail Judgment: PASS**

**Test record created by: David A Kerr**  
**Date of this record: 20 Feb 2024**  
Original record, Version A.

Description	Make	Model #	Serial #	Last Cal/Ver	Next Due
PXE Receiver 26 GHz	Keysight	N9048B	MY59290135	27-Sep-2023	1-Oct-2024
Tape measure, 1" x 33'	Lufkin	PHV1410CMEN	10721	30-Aug-2023	1-Sep-2026
LISN multiline; 20A 50uH	Com-Power	LIN-120C	20160005	10-Feb-2023	11-Mar-2024

**Table CE01.1: Test Equipment Used**

#### Software Used

Keysight PXE firmware version A.32.06  
CE Mains 150k to 30M Data Analysis V2 2021Jun10.xlsx

#### Test Data

The conducted emission test process began with a set of preliminary scans on both power conductors using both Quasi-Peak and Average detectors across the frequency range. Where the test standard requires cable manipulation, one or more likely worst case frequencies selected by the test personnel. Cables were manipulated to find the maximal signal strength while observing the receiver levels at those selected frequencies. At each of the frequencies selected for final measurements, Quasi-peak and Average detector readings were taken on each conductor.

The table shows the selected final measurement data. It includes at least the six strongest emissions observed relative to the limit lines, along with other data points of interest. The yellow highlight indicate the data points with the least margin to the quasi-peak detector limit and the average detector limit. A positive margin value indicates that the emission was below the test limit. The test limit is the Composite FCC Class B Limit.

Frequency (kHz)	QP Limit (dBuV)	AV Limit (dBuV)	L1 QP (dBuV)	L2 QP (dBuV)	L1 AV (dBuV)	L2 AV (dBuV)	QP Margin (dB)	AV Margin (dB)
150	66.00	56.00	32.29	28.88	23.25	23.11	33.71	32.75
157	65.63	55.63	28.00	29.89	22.22	22.75	35.75	32.89
238	62.17	52.17	26.29	26.51	21.14	21.26	35.67	30.92
353	58.90	48.90	27.44	27.66	23.06	23.06	31.24	25.84
425	57.36	47.36	27.76	28.77	23.25	24.80	28.59	22.56
447	56.93	46.93	26.65	27.52	21.51	22.95	29.41	23.98
713	56.00	46.00	29.20	29.09	25.86	25.91	26.80	20.09
753	56.00	46.00	26.46	26.52	21.40	21.54	29.48	24.46
1424	56.00	46.00	26.63	26.73	22.07	22.06	29.27	23.93
1426	56.00	46.00	26.70	26.80	21.90	22.14	29.20	23.86
2897	56.00	46.00	26.33	26.73	21.33	21.89	29.27	24.11
5714	60.00	50.00	27.04	27.13	22.30	22.56	32.87	27.44

**Table CE01.2: Emission summary**

The graph below shows preliminary scan data as continuous curves. Superimposed are the final measurement data points reported in the table above.

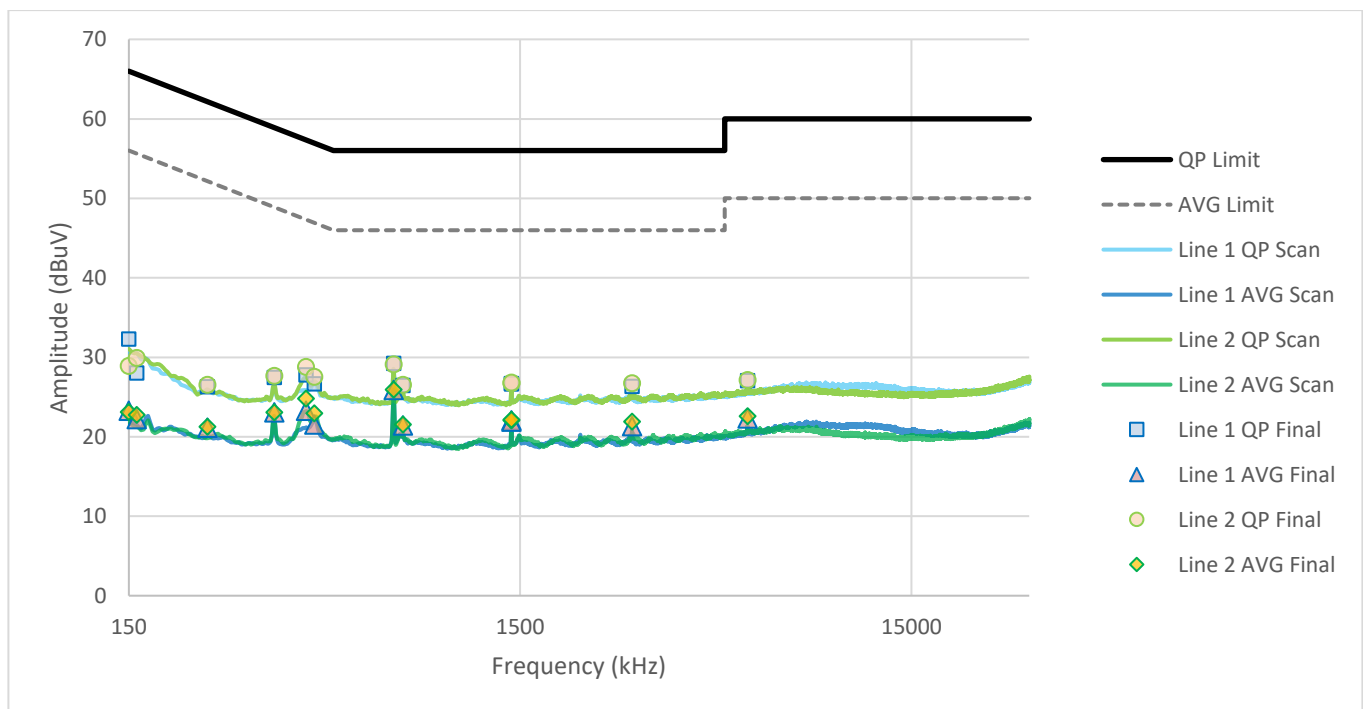

**Figure CE01.1: Spectral data**

### Setup Photographs

The following photographs show the EUT configured and arranged in the manner in which it was measured.

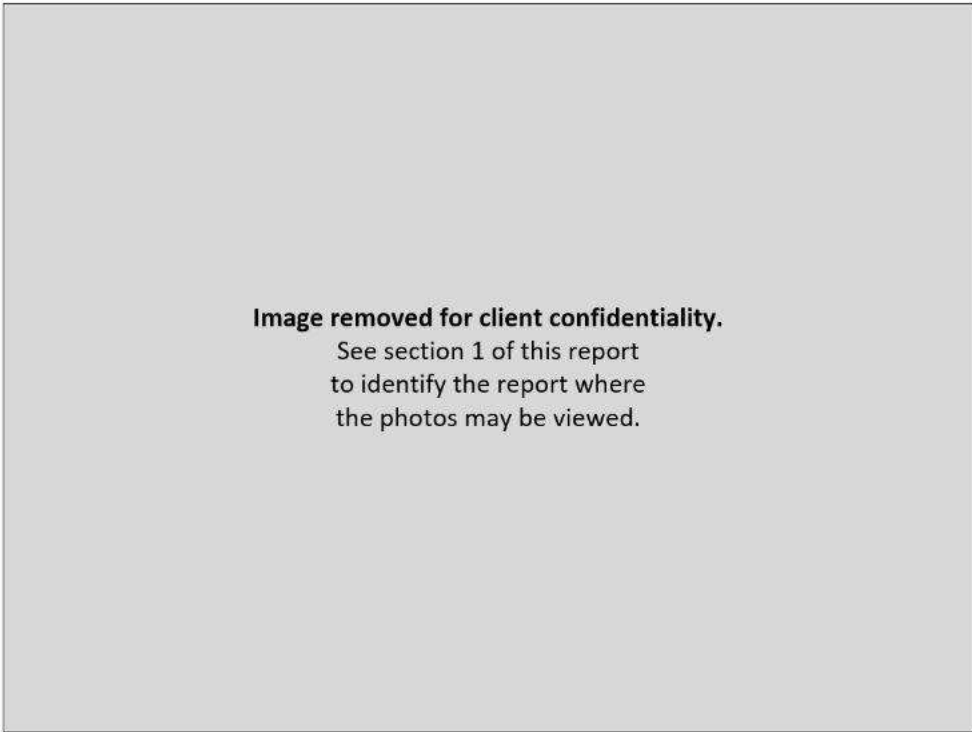

**Figure CE01.2: Test setup, right side view**

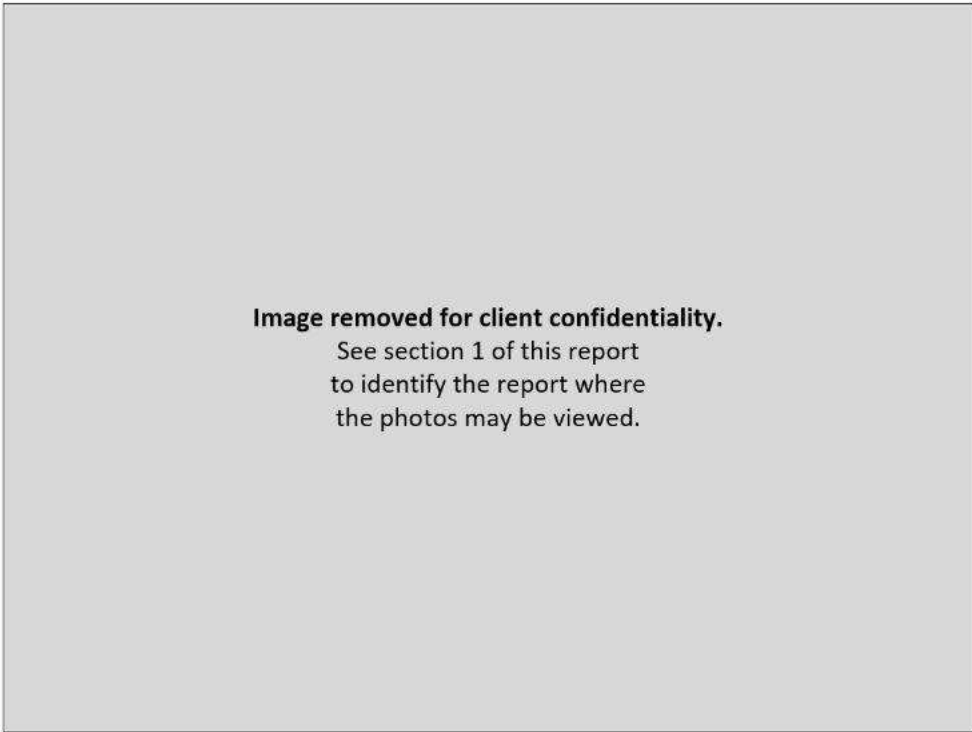

**Figure CE01.3: Test setup, left side view**

**This line is the end of the test record.**

## Concluding Notes

This report stands as an integrated record of the tests performed and must be copied or distributed in its complete form. The reproduction of selected pages or sections separate from the complete report would require specific approval from the manager of the Garmin Compliance Lab.

**This is the final page of the report.**