

Test Report 2023-068

Version A
Issued 3 Nov 2023

Project GCL-0458
Model Identifier: A04714
Primary Test Standard(s)
CFR 47, FCC Part 15.249
RSS-247 Issue 2

Garmin Compliance Lab
Garmin International
1200 E 151st Street
Olathe Kansas 66062 USA

Client-supplied Information

FCC ID: IPH-04714
IC ID: 1792A-04714



See section 6 of this report regarding the presence or absence of accreditation logos or marks on this cover page.

1. Summary

The equipment or product described in section 5 of this report was tested at the Garmin Compliance Lab according to standards listed in section 6. This report focuses on the 2.4 GHz ANT transceiver(s). Test records within this report may include data for the BLE transmitter, but BLE is addressed in separate report. The results are as follows.

Parameter	Description	Key Performance Values	Result	Data starts at page
Restricted Bands	The radio must not emit in certain designated restricted frequency bands above a set of limit values. [15.205; RSS-210 at 7.1]	Emissions in the restricted bands were at least 8.92 dB below the applicable limits.	PASS	11
Carrier and Harmonic Emissions	The field strength from the radio carrier and its harmonics must meet specific limits at a 3 m test distance. [15.249(a); RSS-210 at B.10]	The limit is 50 mV/m (94 dBuV/m) in the carrier band, and 0.5 mV/m (54 dBuV/m) at all other frequencies. This sample demonstrated 8.2 dB of margin or greater.	PASS	16
Frequency Stability	The radio tuning must be robust over a range of temperature and supply voltage conditions. [RSS-Gen at 6.11]	Radio emissions remained within the allowed radio band under all environmental conditions tested.	PASS	35
Other Bandwidths	Regulatory agencies also require the reporting of signal bandwidths using alternate processes. [2.202; RSS-GEN at 6.7]	These values are reported but have no actual performance requirements.	Reported	38

NT (Not Tested) means the requirement may or may not be applicable, but the relevant measurement or test was not performed as part of this test project.

N/A (Not Applicable) means the lab judged that the test sample is exempt from the requirement.

Table 1: Summary of results

Report Organization

For convenience of the reader, this report is organized as follows:

1. Summary
2. Test Background
3. Report History and Approval
4. Test Sample Modifications and Special Conditions
5. Description of Equipment Tested
6. Test Standards Applied
7. Measurement Instrumentation Uncertainty
8. Selected Examples of Calculations
9. Environmental Conditions During Test
10. Immunity Performance Criteria

Annex: Test records are provided for each type of test, following the order and page numbering stated in the summary table. Concluding notes appear on the final page of this report.

Due to confidentiality, certain material (such as test setup photographs) has been removed from this report and placed in GCL Test Report 2023-067. That report is treated as a part of this document by way of this reference.

2. Test Background

The testing reported here was performed at the Garmin Compliance Lab, an organization within Garmin International, located at 1200 E 151st St, Olathe Kansas, USA. The contact telephone number is +1.913.397.8200.

The testing was performed on behalf of the Garmin design group, a separate organization located at 1200 E 151st St, Olathe Kansas, USA. Witnesses from the business group included: None.

Test Sample received: 01 Sep 2023
Test Start Date: 18 Sep 2023
Test End Date: 19 Oct 2023

The data in this test report apply only to the specific samples tested.

Upon receipt all test samples were believed to be properly assembled and ready for testing.

3. Report History and Approval

This report was written by Majid Farah and initially issued on 3 Nov 2023 as Version A.

Report Technical Review:

David Arnett
Technical Lead EMC Engineer



Report Approval:

Shruti Kohli
Manager Test and Measurement (EMC, Reliability and Calibration)



4. Test Sample Modifications and Special Conditions

The following special conditions or usage attributes were judged during test to be necessary to achieve compliance with one or more of the standards listed in section 6 of this report:

None

The following modifications to the test sample(s) were made, and are judged necessary to achieve compliance with one or more of the standards listed in section 6 of this report:

None

5. Description of the Equipment Tested

5.1 Unique Identification

Product Model A04714
Serial Numbers Tested 3453413731, 3453413644

This product tested is a mobile device for collecting and sharing data with the user and nearby electronic devices.

The client affirmed that the test samples will be representative of production in all relevant aspects.

5.2 Key Parameters

EUT Input Power: 5 Vdc
I/O Ports: USB
Radio Transceivers: Bluetooth Low Energy, ANT, NFC
Radio Receivers: GPS L1, Galileo E1, BeiDou, GLONASS
Primary Functions: Data collection and communication
Typical use: Portable in multiple orientations
Highest internal frequency: 2.484 GHz
Firmware Revision 3.05

5.3 Operating modes

During test, the EUT was operated in one or more of the following modes. Some modes may not applicable for this product or in this report.

Mode 1: M1 (Bt Tx). Bluetooth, sometimes called Bluetooth Classic, radio is transmitting consistently on a selected channel sending data using the BR (Basic Rate of 1 Mbps), EDR2 (Extended Data Rate of 2 Mbps) or EDR3 (Extended Data Rate of 3 Mbps) modulation types.

Mode 2: M2 (Bt Ink). Bluetooth Classic radio is paired to a companion device, transmitting and receiving data on various channels in accordance with the protocol, and maintaining the paired relationship.

Mode 3: M3 (Ble Tx). Bluetooth Low Energy radio transmitting consistently on a selected channel at 1 Mbps or 2 Mbps

Mode 4: M4 (Ble Ink). Bluetooth Low Energy radio is paired to a companion device, transmitting and receiving data on various channels in accordance with the protocol, and maintaining the paired relationship.

Mode 5: M5 (ANT Tx). ANT radio transmitting consistently on a selected channel.

Mode 6: M6 (ANT Ink). ANT radio is paired to a companion device, transmitting and receiving data in accordance with the protocol, and maintaining the paired relationship.

Mode 7: M7 (WiFi Tx). The IEEE 802.11 b/g/n radio was transmitting consistently on a selected channel, with a specified modulation type, and data rate.

Mode 8: M8 (WiFi Link). The IEEE 802.11 b/g/n radio is paired to a companion device, transmitting and receiving data on a selected channel in accordance with the protocol, and maintaining the paired relationship.

Mode 9: M9 (Rx 2.4). The radio was set to receive 2.4 GHz signals but not transmit. In this situation, it was specifically looking for Bluetooth Low Energy signals which cover the 2.4 GHz band and represent a worst-case scenario.

Mode 10: M10 (All2.4). This means the radio was tested in modes M1, M3, M5, and M7 if applicable.

Mode 11: M11 (GNSS). The Global Navigation Satellite System receiver is monitoring the GNSS bands, attempting to detect a constellation and determine location. Unless otherwise noted, the EUT was provided simulated GNSS signals representing one of more constellation types. In addition, the EUT may have been reporting signal levels and satellite data to an attached computer to monitor link health.

Mode 12: M12 (NFC Ink). The NFC 13.56 MHz transceiver is in Card Emulation mode, and is actively linked to a companion NFC Reader.

5.4 EUT Arrangement

During test, the EUT components and associated support equipment were selected including the following arrangement sets.

Arrangement 1: A1 (Solo). The test sample operates from its battery and no external physical connections. No block diagram is needed for this arrangement.

Arrangement 2: A2 (Upwr). The test sample is attached to a Mains-powered device connected that provides dc power to the sample over a cable but no user data. See the block diagram in Figure 1.

Arrangement 3: A3 (Udata). The test sample is attached to a Mains-powered device connected that provides dc power to the sample and user data over a cable. See the block diagram in Figure 1.

Arrangement 4: A4 (Udc). The test sample is attached to a Mains-powered device connected that provides dc power to the sample and may or may not provide user data. This arrangement is specified in the test plan to provide staff flexibility when the presence or absence of data on the cable is not pertinent. See the block diagram in Figure 1.

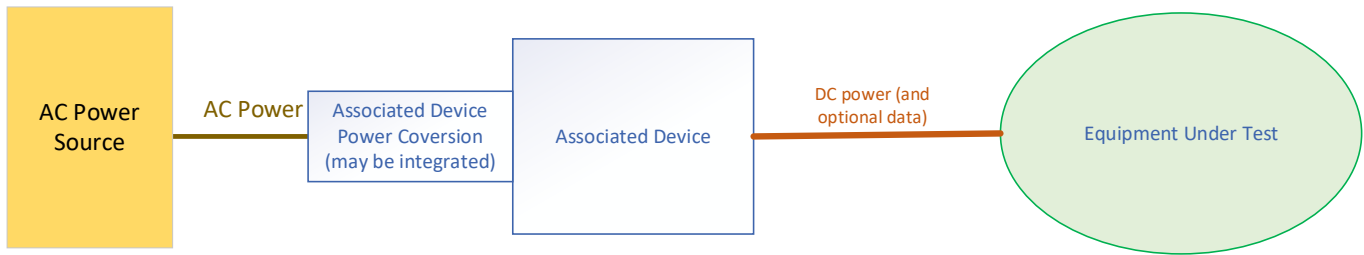

*This interconnect drawing is not to scale.
It does not indicate the placement of devices.*

Figure 1: Block diagram of equipment for arrangements A2, A3, A4

Arrangement 5: A5 (NFCp) The test sample is placed near an NFC Card Reader. The NFC Card Reader is connected to a laptop computer. The test sample is powered by a device that does not include data over the cable, just as with A2. For clarity, test sample is NOT powered by, or connected to, the laptop computer that powers the NFC Card Reader.

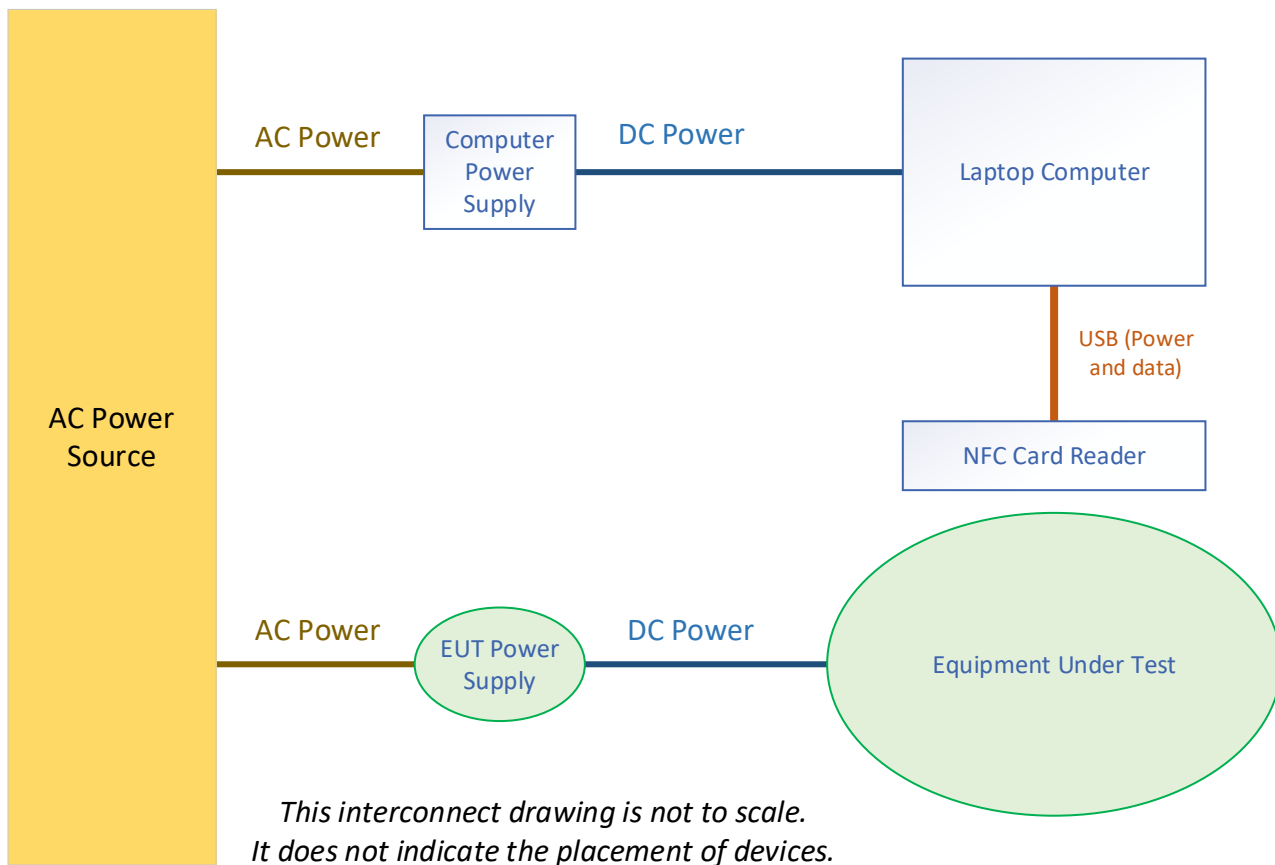

Figure 2: Block diagram of equipment arrangement A5

Arrangement 6: A6 (NFCu) The test sample is placed near an NFC Card Reader. The NFC Card Reader is connected to a laptop computer. The test sample is powered by its own batteries rather than an external power source. The test sample is NOT powered by, or connected to, the laptop computer that powers the NFC Card Reader.

5.5 Associated Equipment (AE) used

Description	Manufacturer	Model	Serial Number
AC/DC Power Converter	Phihong	PSAF10R-050Q	None
Laptop Computer	Dell	Latitude 5410	5VSPFB3
Laptop Power Supply	Dell	HA65NM191	None

Table 2: List of associated equipment that may have been used during test

5.6 Cables used

Description	From	To	Length	EMC Treatment
USB	Power and/or Data source	EUT	54 cm	None

Table 3: List of cables that may have been used during test

6 Test Standards Applied

6.1. Accredited Standards

The following test or measurement standards were applied and are within the scope of the lab's accreditation. All results in this report that cite these standards are presented as Accredited results consistent with ISO/IEC 17025.

- AS/NZS 4268: 2017
- CFR 47, FCC Part 15.249
- ANSI C63.10: 2013 and ANSI C63.10: 2020
- RSS-GEN Issue 5 Amd 2
- RSS-247 Issue 2

6.2. Non-accredited Standards

The following test or measurement standards were applied and are either outside the scope of the lab's accreditation, or were performed in such a way that results are not presented as being fully accredited.

- TRC-43 Issue 3

6.3 Variances

The following variances were applied to standards cited in this section.

Where different test standards cover the same test parameter or phenomenon, and the standards have compatible differences, the stricter of the requirements is typically applied. For example, a consolidated limit may be applied to emission tests selecting the strictest of the limits at each frequency. Likewise, if one standard requires a vertical antenna sweep with boresighting and another does not, swept motion with boresighting will typically be used as it is the more stringent requirement.

During tests of radiated harmonic emissions, the data are adjusted downward 17.4 dB before comparison to the Average Detector limit. This adjustment is intended to compensate for the maximum possible transmitter duty cycle. The adjustment value is calculated using $20 \log(1/D)$ where D is the duty cycle. ANSI C63.10 would seem to prefer any adjustment be based on $10 \log(1/D)$. The details around this choice are discussed more fully in Test Record RE08 which appears at about page 23. No adjustment is made when comparing data to a Peak Detector limit, consistent with ANSI C63.10.

6.4 Laboratory Accreditation

The Garmin Compliance Lab, an organization within Garmin International, is registered with the US Federal Communication Commission as US1311. The lab is recognized by the Canada Department of Innovation, Science, and Economic Development (ISED) under CAB identifier US0233.

The Garmin Compliance Lab, an organization within Garmin International, is accredited by A2LA, Certificate No. 6162.01. The presence of the A2LA logo on the cover of this report indicates this is an accredited ISO/IEC 17025 test report. If the logo is absent, this report is not issued as an accredited report. Other marks and symbols adjacent to the A2LA logo are accreditation co-operations of which A2LA is a member under a mutual recognition agreement, and to which the Garmin Compliance Lab has been sublicensed.

7 Measurement Instrumentation Uncertainty

The lab has analyzed the sources of measurement instrumentation uncertainty. The analysis concludes that the actual measurement values cited in this report are accurate within the U_{LAB} intervals shown below with approximately 95% statistical confidence. Where the report shows a judgment that a test sample passes a test against a published limit based on these measured values, that judgment has a statistical confidence of 97.5% or greater. Measurement Instrumentation Uncertainty is one component of over-all measurement uncertainty, and other uncertainty components are not considered as part of this analysis.

The primary benchmark for measurement instrumentation uncertainty (MIU) in an electromagnetic compatibility (EMC) test lab is the set of U_{CISPR} values published in CISPR 16-4-2. In all cases where a U_{CISPR} value is published by CISPR, the analysis shows that U_{LAB} – this lab’s estimated MIU – is better than the U_{CISPR} benchmark.

The secondary benchmark for MIU in an EMC lab performing radio transceiver tests is a set of uncertainty limit values published in various ETSI standards. In this report, U_{ETSI} is the most restrictive of the values found in the ETSI EN standards listed in section 5 of this report. The analysis principles are described in the ETSI TR documents listed there. In most cases U_{LAB} is better than the U_{ETSI} benchmark. Where U_{LAB} exceeds the U_{ETSI} benchmark cited here, that entry is preceded by an asterisk. When required by the ETSI EN standards, excess uncertainty will be added to the measurand before comparison to a limit. In an individual test report, staff may re-evaluate that excess uncertainty based on the uncertainty of the method used and the uncertainty limits of the actual ETSI EN standard being applied, and the revised uncertainty values will be shown in the test report.

Some measurement uncertainties analyzed and reported here are not addressed in CISPR 16-4-2 or the ETSI standards, as indicated by the entry ‘None.’

Test Type	U_{LAB}	U_{CISPR}	U_{ETSI}
Conducted DC voltage	0.09% + 2 x LSDPV	None	1%
Conducted AC voltage below 500 Hz	1.0% + 3 x LSDPV	None	2%
Conducted Emissions, Mains Voltage	0.10% + 10 mV	None	None
Conducted Emissions, Mains Current	0.10% + 3 mA	None	None
Conducted Emissions, Mains Power	0.15% + 100 mW	None	None
Conducted Emissions, Power Mains, 9 kHz to 150 kHz	1.49 dB	3.8 dB	None
Conducted Emissions, Power Mains, 150 kHz to 30 MHz	1.40 dB	3.4 dB	None
Conducted Emissions, Cat 6 LCL, 150 kHz to 30 MHz	2.80dB	5 dB	None
Conducted Emissions, Cat 5 LCL, 150 kHz to 30 MHz	3.21 dB	5 dB	None
Conducted Emissions, Cat 3 LCL, 150 kHz to 30 MHz	4.24 dB	5 dB	None
Radiated Emissions, below 30 MHz	0.88 dB	None	6 dB
Radiated Emissions, 30 MHz to 1000 MHz	2.77 dB	6.3 dB	6 dB
Radiated Emissions, 1 GHz to 18 GHz	2.60 dB	5.2 & 5.5 dB	6 dB
Radiated Emissions, 18 GHz to 26.5 GHz	2.73 dB	None	6 dB
*Radio Signal Frequency Accuracy	$*1.55 \times 10^{-7}$	None	1.0×10^{-7}
Radio Signal Occupied Bandwidth	0.95%	None	5%
Radio Power or Power Spectral Density	0.98 dB	None	1 dB
Temperature	0.38 °C	None	1 °C
Barometric Pressure	0.38 kPa	None	None
Relative Humidity	2.85% RH	None	±5% RH
Signal Timing	The greater of these three... 0.63 usec 0.01% of value 0.5 x LSDPV	None	None

Note: LSDPV stands for the Least Significant Digit Place Value reported. In the value 1470 msec, the least significant digit is the 7. It has a 10 msec place value. The LSDPV is thus 10 msec and the maximum error due to roundoff would be 5 msec. If the time value were reported as 1470 msec, the underscore indicates that the 0 is a significant figure and the error due to roundoff would be 0.5 msec. All digits provided to the right of a decimal point radix are significant.

8 Selected Example Calculations

Certain regulators require samples of the calculations that lead from the raw measurement to the final result for AC Mains conducted and unintended radiated emissions. The assumption is that the lab performs raw measurements, then adds, subtracts, multiplies, or divides based on transducer factors, amplifier gains, and losses in the signal transmission path. In this lab, our CISPR 16 Receiver does not work that way. The calibration factors and losses and gains are provided to the receiver as detailed data files. These factors are applied in the RF measurement path prior to the detector. But as a step in the lab measurement process, staff frequently verify that these factors are applied correctly. They make a measurement with the factors applied inside the receiver, then they disable the factors and remeasure the result manually adding in the various relevant factors.

The transmission loss is measured including the combined losses and gains of preamplifiers, cables, and any band-selective filters. In many cases above 1 GHz it is a negative value, indicating that the preamplifier gain is greater than these other losses.

Here are examples of these calculations. The data in these examples was not taken as part of this project:

8.1 AC Mains conducted emissions at 22 MHz

(Raw measurement) + (AMN factor) + (transmission loss) = Result

$$(7.145 \text{ dBuV}) + (9.812 \text{ dB}) + (0.216 \text{ dB}) = 17.173 \text{ dBuV}$$

8.2 Radiated Emissions at 630 MHz

(Raw measurement) + (Antenna factor) + (transmission loss) = Result

$$(2.25 \text{ dBuV}) + (27.80 \text{ dB/m}) + (2.89 \text{ dB}) = 32.94 \text{ dBuV/m}$$

8.3 Radiated Emissions at 2.7 GHz

(Raw measurement) + (Antenna factor) + (transmission loss) = Result

$$(43.72 \text{ dBuV}) + (32.22 \text{ dB/m}) + (-36.09 \text{ dB}) = 39.85 \text{ dBuV/m}$$

9 Environmental Conditions During Test

Environmental conditions in the test lab were monitored during the test period. Temperature and humidity are controlled by an air handling system. As information to the reader, the conditions were observed at the values or within the ranges noted below. For any tests where environmental conditions are critical to test results and require further constraints or details, the test records in the annex may provide more specific information.

Temperature:	20.5 to 23.6 °C
Relative Humidity:	34.3% to 55.7% (non-condensing)
Barometric Pressure	96.3 to 99.2 kPa

Description	Make	Model #	Serial #	Last Cal/Ver	Next Due
Barometer	Traceable	6453	221702700	3-Aug-2022	1-Aug-2024

Table 4: Environmental monitoring device

10 Immunity Performance Criteria

If this report includes immunity tests then results have been categorized as Performance Criteria A, B, C, or D. The standards that the lab applied will define the details for A, B, and C, as well as which criterion is required for each type of test. They will also define the electrical stresses that were applied during each test. In a very general sense the observed criteria noted in this report are as follows:

Criterion A. The stress applied did not alter product operation. This criterion is generally used for ‘continuous’ stresses that can be present for a long time in the places the product will be used, or that can appear often, even though they may come and go over time.

Criterion B. The stress applied altered product operation, but the product self-recovered so that the user would not have to try to figure out how to restore it to full operation. This criterion is generally used for 'transient' stresses that appear briefly and occasionally, but are usually not present in the places the product will be used.

Criterion C. The stress applied altered product operation, but the user could restore it to full operation, for example by power cycling the product. This criterion is generally used for 'transient' stresses that appear briefly and only rarely in the places the product will be used.

Criterion D. This is not an official criterion in the standards, because it would be a failure of the requirements. This indication in a test record means the product was affected in a way that the user might not be able to correct. The effect could include some degree of hardware damage, or it could include loss of program files or data files necessary for operation.

Repeatability is an issue in all EMC immunity work. When the product operation changes unexpectedly during a test, and the change would fail the requirements of the standard, this is an anomaly. The test operator needs to determine whether the anomaly was a result of the applied electrical stress. The investigation is done by repeating the section of the test where the anomaly occurred three times. If the same or a similar anomaly occurs in any of the three repeat trials, it is confirmed as a response to the stress. If not, the anomaly is judged unreproducible and is not considered when judging the A, B, or C observed performance. Since there is usually no ability to confirm a Criterion D anomaly, these are usually treated as Criterion D upon a single occurrence.

Tests that require Criterion B performance will be judged to Pass if criteria A or B is observed. Similarly, tests that require Criterion C performance will be judged to Pass if criteria A, B, or C is observed.

ANNEX

The remainder of this report is an Annex containing individual test data records. These records are the basis for the judgments summarized in section 1 of this report. The Annex ends with a set of concluding notes regarding use of the report.

Test Record
Radiated Emission Tests RE01, RE02
Project GCL0458

Test Date(s) 18 Sep 2023
 Test Personnel Jim Solum

Product Model A04714
 Serial Number tested 3453413644

Operating Mode M3 (Ble Tx), M5 (ANT Tx)
 Arrangement A2 (Upwr)
 Input Power 5 Vdc

Test Standards: FCC Part 15, ANSI C63.10, (as noted in Section 6 of the report).

Frequency Range: FCC Restricted Bands (2200-2390MHz, 2483.5-2500MHz)
Pass/Fail Judgment: PASS

Test record created by: Jim Solum
Date of this record: 25 Sep 2023

Original record, Version A.

Test Equipment Used

Description	Make	Model #	Serial #	Last Cal/Ver	Next Due
PXE Receiver 44GHz	Keysight	N9048B	MY62220139	30-Jan-2023	1-Feb-2024
Antenna, Horn, 1-18 GHz	ETS Lindgren	3117	00259208	7-Jun-2023	1-Jun-2024
FSOATS 3m, above 1 GHz	Frankonia	SAC3	F199004	16-Nov-2022	16-Nov-2025
Preamplifier, 500 MHz 18 GHz	Com-Power	PAM-118A	18040133	Calibration	Not Required
Wifi Filter	K&L	8NSL26-2437/E82.2-0/0	1	Calibration	Not Required
Tape measure, 1" x 33'	Lufkin	PHV1410CMEN	10721	30-Aug-2023	1-Sep-2026

Table RE01.1: Test Equipment Used

Software Used

Keysight PXE N9048B Firmware version A.33.03
 RE Signal Maximization Tool v2023Jul14.xlsx
 FCC Restricted Band 2p4GHz Template v1b 2023Jun20.xlsx

Test Data

The radiated emission test process began with a preliminary scan at multiple turntable angles, antenna heights, and both antenna polarizations. For test standards that require reorienting the test sample, further preliminary scans were taken in those alternate orientations typically described as X, Y, and Z. Subsequent testing was done using on the orientation(s) producing the highest result relative to the test limit. Where the test standard requires cable manipulation, this was done at one of more likely worst-case frequencies selected by the test personnel while observing the receiver display. The turntable angle, antenna height, and antenna polarization were explored to find the worst-case settings for each of the restricted band ranges. Final field strength measurements were taken in that set of positions. Full maximization was not performed at frequencies that are noise floor measurements included per the test standard requirements.

Restricted band measurements in the lower band were made while the transmitter was tuned to its lowest frequency of 2402 MHz. Measurements in the upper band were made while the transmitter was tuned to its highest frequency of 2480 MHz.

At azimuth angle 0° the 'front' reference mark of the turntable is pointed Southward. At 90° the reference mark points West. At -90° it points East. At -7° the turntable reference mark is pointed directly at the antenna. The designation of the X, Y, and Z orientations of the test sample are sample dependent, so these are reported by use of photographs.

The tables show the selected final measurement data between the FCC restricted bands. It includes the strongest emissions observed relative to the test limit, along with other data points of interest. Where a data point is highlighted is yellow, this is an aid to indicate the data point(s) with the least margin to the test limit. A positive margin value indicates that the emission was below the test limit. The test limit is the FCC restricted band Class B Limit at 3m.

Frequency	Avg Limit	Pk Limit	Avg Level	Pk Level	Av Margin	Pk Margin	Azimuth	Height	Polarity
(MHz)	(dBuV/m)	(dBuV/m)	(dBuV/m)	(dBuV/m)	(dB)	(dB)	(degree)	(mm)	---
2390	54	74	33.628	57.467	20.372	16.533	-5	1062	HORZ
2386	54	74	34.757	55.264	19.243	18.736	-5	1062	HORZ

Table RE01.2: Emission summary FCC restricted band from 2200 to 2390 MHz (BLE1)

Frequency	Avg Limit	Pk Limit	Avg Level	Pk Level	Av Margin	Pk Margin	Azimuth	Height	Polarity
(MHz)	(dBuV/m)	(dBuV/m)	(dBuV/m)	(dBuV/m)	(dB)	(dB)	(degree)	(mm)	---
2483.5	54	74	35.367	65.045	18.633	8.955	13	1120	HORZ
2483.5	54	74	35.364	65.079	18.636	8.921	13	1120	HORZ

Table RE01.3: Emission summary FCC restricted band from 2483.5 to 2500 MHz (BLE1)

Frequency	Avg Limit	Pk Limit	Avg Level	Pk Level	Av Margin	Pk Margin	Azimuth	Height	Polarity
(MHz)	(dBuV/m)	(dBuV/m)	(dBuV/m)	(dBuV/m)	(dB)	(dB)	(degree)	(mm)	---
2390	54	74	33.849	57.61	20.151	16.39	-5	1062	HORZ
2386	54	74	37.941	55.427	16.059	18.573	-5	1062	HORZ

Table RE01.4: Emission summary FCC restricted band from 2200 to 2390 MHz (ANT)

Frequency	Avg Limit	Pk Limit	Avg Level	Pk Level	Av Margin	Pk Margin	Azimuth	Height	Polarity
(MHz)	(dBuV/m)	(dBuV/m)	(dBuV/m)	(dBuV/m)	(dB)	(dB)	(degree)	(mm)	---
2483.5	54	74	36.421	64.89	17.579	9.11	13	1120	HORZ
2488	54	74	37.039	58.326	16.961	15.674	13	1120	HORZ

Table RE01.5: Emission summary FCC restricted band from 2483.5 to 2500 MHz (ANT)

The graphs below show the background spectrum observed during pre-scan, as well as the final data points from the table above.

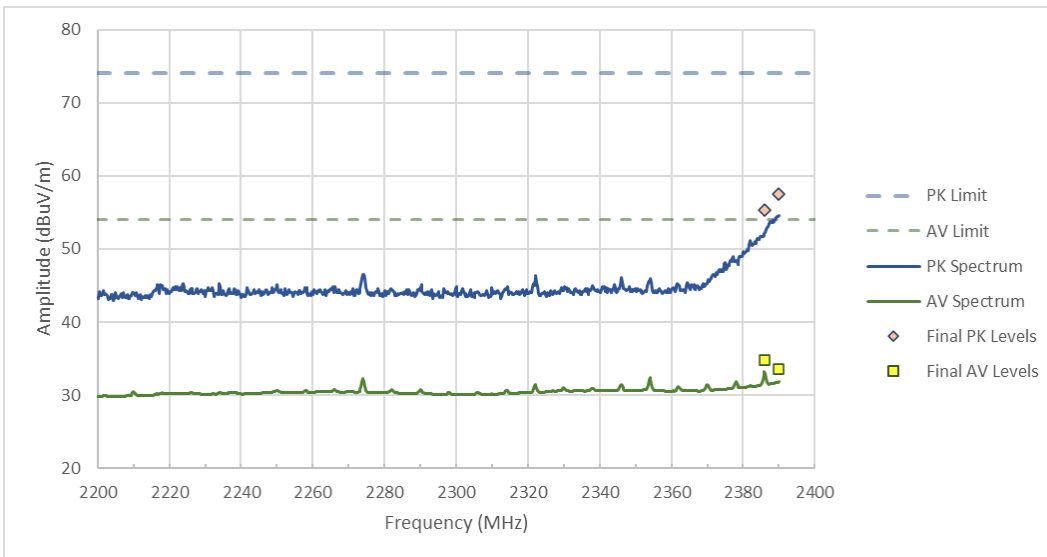

Figure RE01.1: Spectral data FCC restricted band from 2200 to 2390 MHz (BLE1)

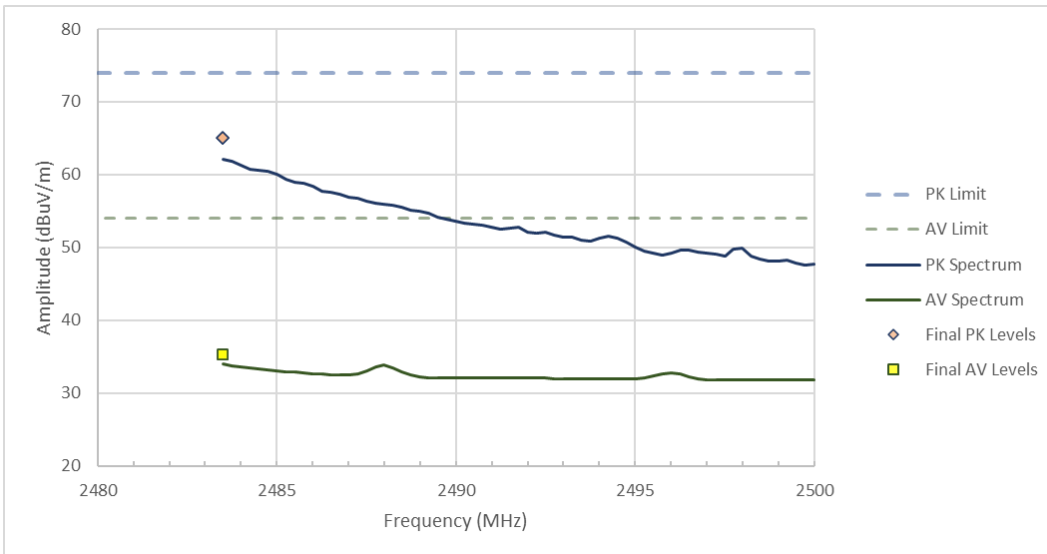

Figure RE01.2: Spectral data FCC restricted band from 2483.5 to 2500 MHz (BLE1)

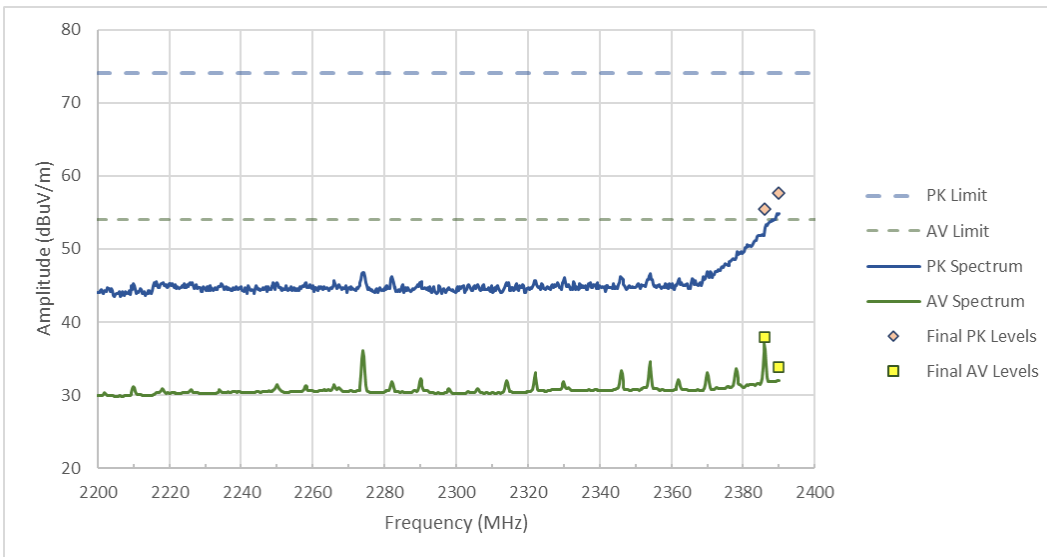

Figure RE01.3: Spectral data FCC restricted band from 2200 to 2390 MHz (ANT)

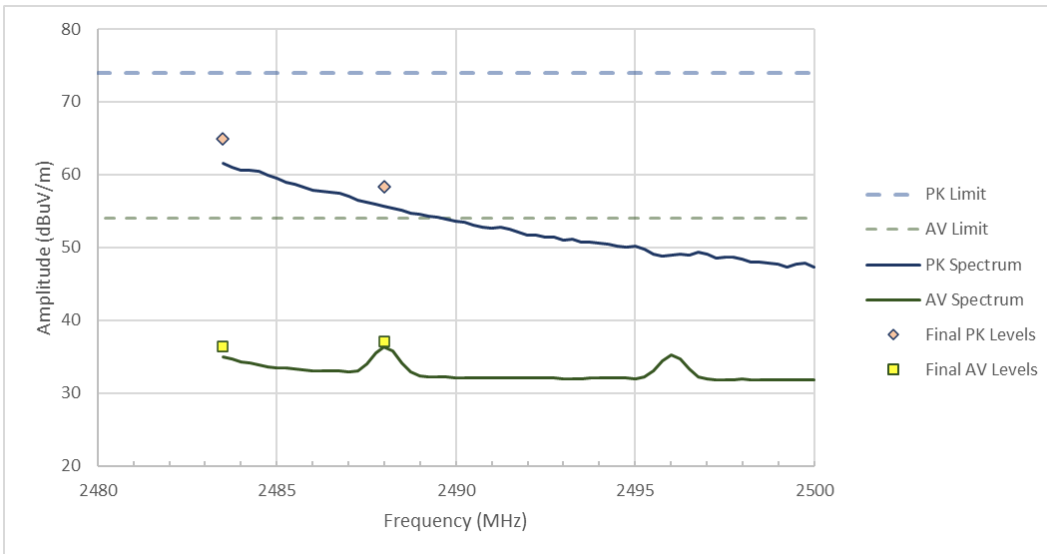

Figure RE01.4: Spectral data FCC restricted band from 2483.5 to 2500 MHz (ANT)

Setup Photographs

The following photographs show the EUT configured and arranged in the manner in which it was measured.

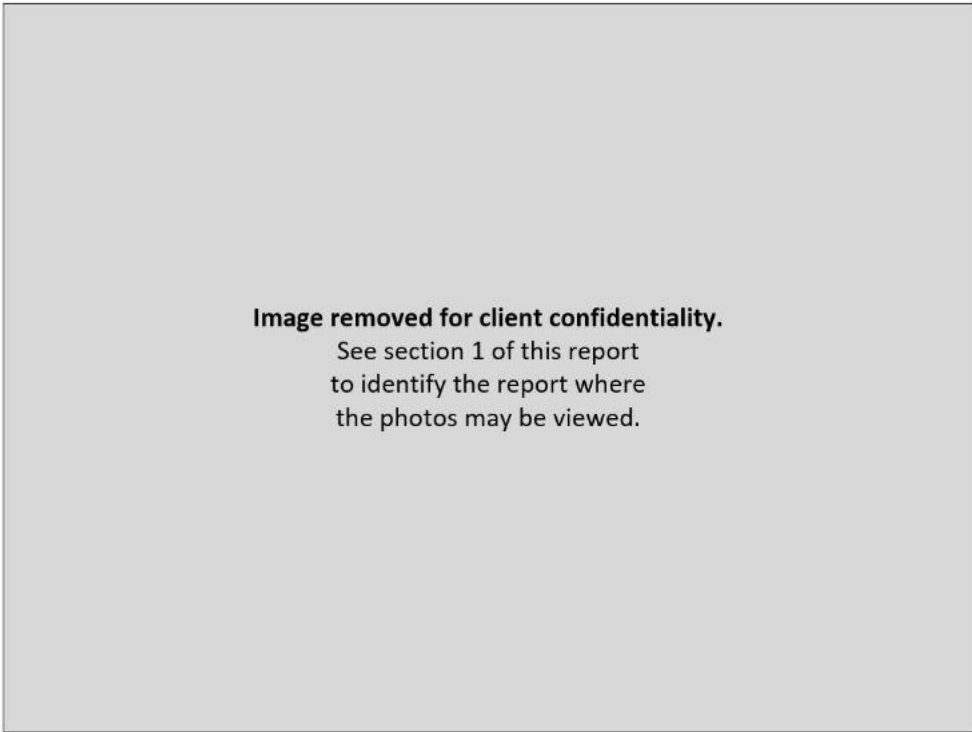

Figure RE01.5: EUT test setup, front view (X orientation)



Figure RE01.6: EUT test setup, reverse view (X orientation)

This line is the end of the test record.

Test Record
Radiated Emission Test RE07
Project GCL0458

Test Date(s) 14 Oct 2023
 Test Personnel David Kerr, assisted by Aditya Prakash

Product Model A04714
 Serial Number tested 3453413644

Operating Mode M5 (Ant Tx)
 Arrangement A2 (Upwr)
 Input Power 5 VDC (USB)

Test Standards: FCC Part 15, ANSI C63.10 (as noted in Section 6 of the report).

Frequency Range: 30 MHz to 1000 MHz
Pass/Fail Judgment: PASS

Test record created by: David A Kerr
Date of this record: 16 Oct 2023

Original record, Version A.

Test Equipment

Description	Make	Model #	Serial #	Last Cal/Ver	Next Due
PXE Receiver 26 GHz	Keysight	N9048B	MY59290135	27-Sep-2023	1-Oct-2024
Antenna, Biconilog, 30M-6 GHz	ETS Lindgren	3142E	00233201	19-Jul-2022	15-Jul-2024
SAC 3m, below 1 GHz	Frankonia	SAC3	F199004	7-Nov-2022	7-Nov-2025
Tape measure, 1" x 33'	Lufkin	PHV1410CMEN	10720	16-Jan-2023	15-Jan-2026

Table RE07.1: Test Equipment Used

Software Used:
 N9048B Keysight PXE firmware version A.32.06
 EPX/RE automation software ver. 2023.01.001

Test Data

The radiated emission test process began with a preliminary scan at multiple turntable angles, antenna heights, and both antenna polarizations. For test standards that require reorienting the test sample, further preliminary scans were taken in those alternate orientations typically described as X, Y, and Z. Subsequent testing was done using on the orientation(s) producing the highest result relative to the test limit. Where the test standard requires cable manipulation, this was done at one of more likely worst case frequencies selected by the test personnel while observing the receiver display. At each of the frequencies selected for final measurements, the turntable angle, antenna height, and antenna polarization were explored to find the worst-case settings. Final field strength measurements were taken in that set of positions. Full maximization was not performed at frequencies that are noise floor measurements included per the test standard requirements.

At azimuth angle 180° the 'front' reference mark of the turntable is pointed Southward. At 270° the reference mark points West. At 90° it points East. At 173° the turntable reference mark is pointed directly at the antenna. The designation of the X, Y, and Z orientations of the test sample are sample dependent, so these are reported by use of photographs.

The table shows the selected final measurement data between 30 MHz and 1 GHz. It includes at least the six strongest emissions observed relative to the test limit, along with other data points of interest. Where a data point is highlighted in yellow, this is an aid to indicate the data point(s) with the least margin to the test limit. A positive margin value indicates that the emission was below the test limit. The test limit is the FCC Class B Limit at 3m.

Frequency	Pol.	Reading	Factor	Level	Limit	Margin	Height	Angle
MHz		dB(µV)	dB(1/m)	dB(µV/m)	dB(µV/m)	dB	cm	deg
		QP		QP	QP	QP		
44.940	V	3.4	15.3	18.7	54.0	35.3	400.0	122.0
135.030	V	1.8	16.2	18.0	54.0	36.0	234.5	30.0
411.060	V	0.7	27.5	28.2	54.0	25.8	296.7	97.0
802.020	V	0.7	34.7	35.4	54.0	18.6	124.3	23.0
948.810	H	0.7	36.7	37.4	54.0	16.6	127.6	214.0
685.920	H	0.5	33.4	33.9	54.0	20.1	108.3	191.0

Table RE07.2: Emission summary (2402MHz)

Frequency	Pol.	Reading	Factor	Level	Limit	Margin	Height	Angle
MHz		dB(µV)	dB(1/m)	dB(µV/m)	dB(µV/m)	dB	cm	deg
		QP		QP	QP	QP		
44.970	V	3.6	15.3	18.9	54.0	35.1	358.1	76.0
134.970	V	1.4	16.2	17.6	54.0	36.4	358.8	359.0
408.900	V	0.6	27.6	28.2	54.0	25.8	335.0	255.0
692.220	V	0.2	33.5	33.7	54.0	20.3	232.4	119.0
944.700	H	0.3	36.8	37.1	54.0	16.9	162.4	159.0
797.250	H	0.3	34.6	34.9	54.0	19.1	281.0	254.0

Table RE07.3: Emission summary (2440MHz)

Frequency	Pol.	Reading	Factor	Level	Limit	Margin	Height	Angle
MHz		dB(µV)	dB(1/m)	dB(µV/m)	dB(µV/m)	dB	cm	deg
		QP		QP	QP	QP		
44.940	V	3.1	15.3	18.4	54.0	35.6	110.6	18.0
265.980	V	0.8	22.5	23.3	54.0	30.7	222.8	320.0
134.940	H	1.0	16.2	17.2	54.0	36.8	156.8	315.0
404.700	H	0.2	27.5	27.7	54.0	26.3	127.5	92.0
206.640	H	1.8	19.3	21.1	54.0	32.9	150.8	19.0
939.990	H	0.8	36.8	37.6	54.0	16.4	294.6	0.0

Table RE07.4: Emission summary (2480MHz)

The graph below shows the background spectrum observed during pre-scan, as well as the final data points from the table above.

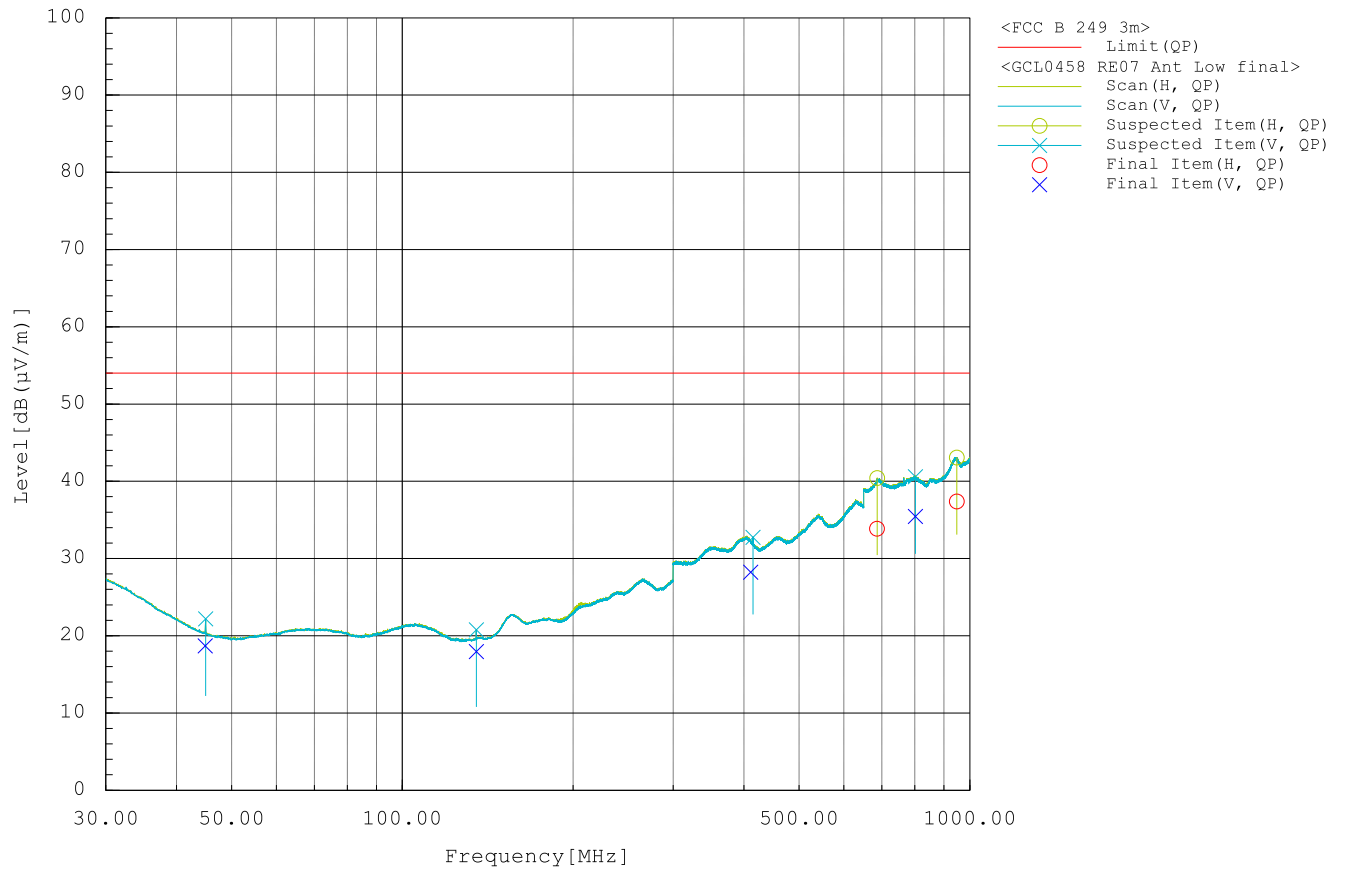

Figure RE07.1: Spectral data (2402MHz)

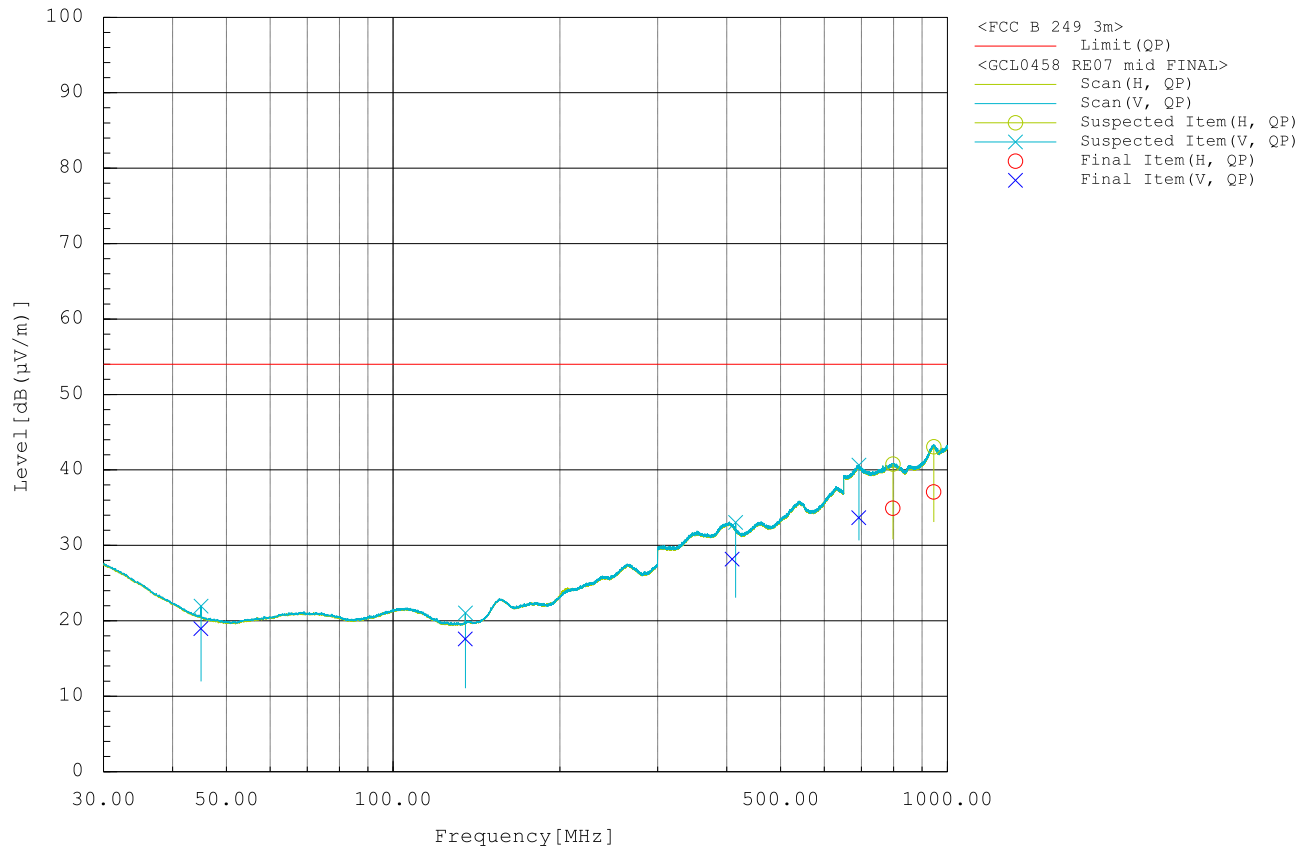

Figure RE07.2: Spectral data (2440MHz)

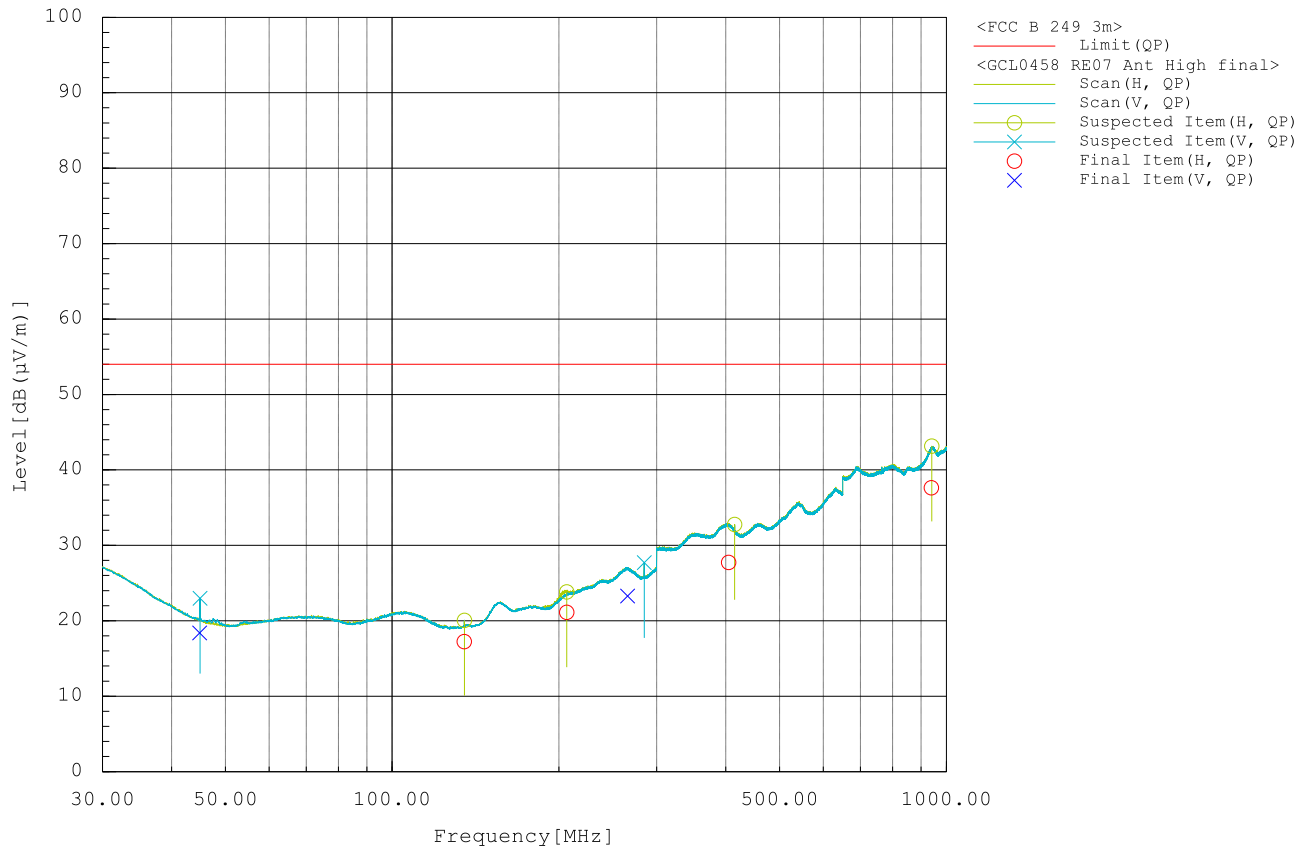

Figure RE07.3: Spectral data (2480MHz)

Setup Photographs

The following photographs show the EUT configured and arranged in the manner in which it was measured.

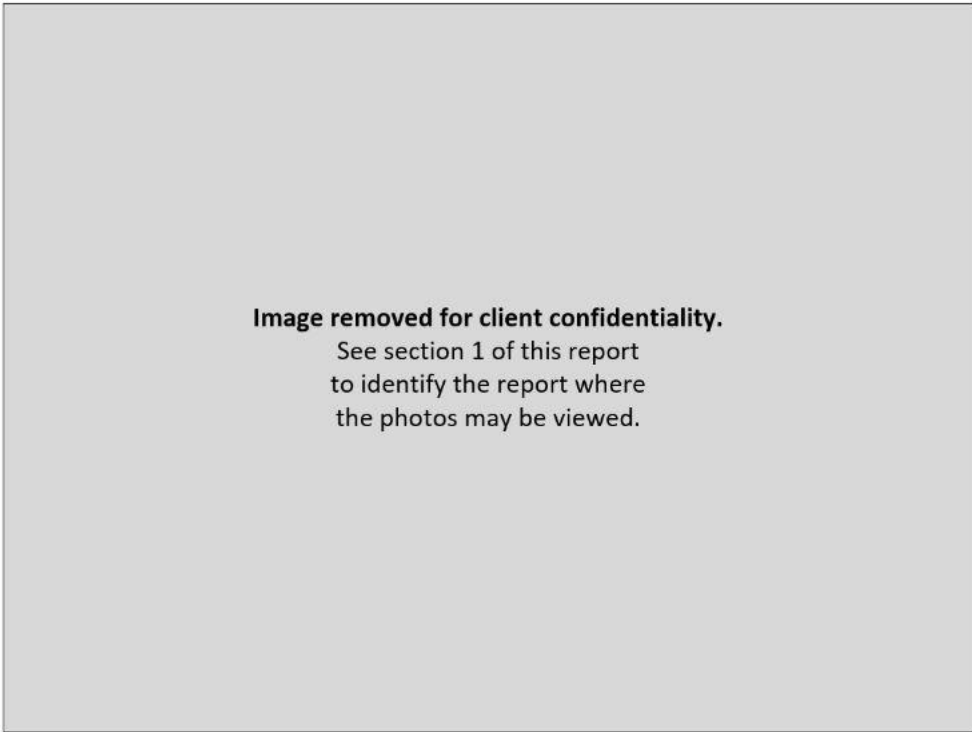

Figure RE07.4: EUT test setup, front view (X orientation)

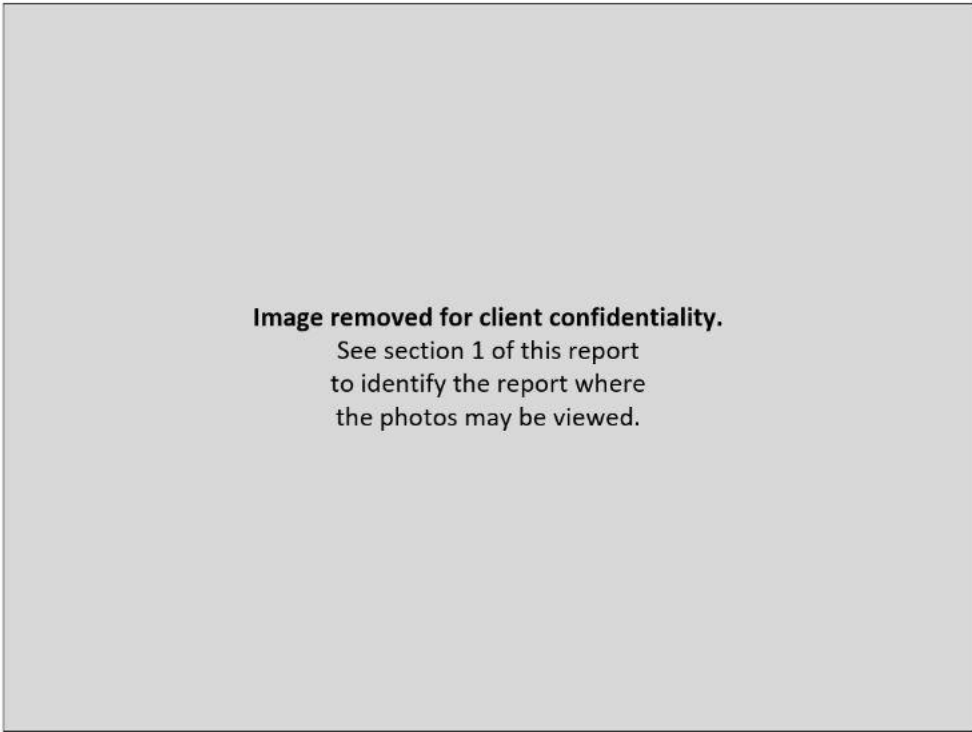

Figure RE07.5: EUT test setup, reverse view (X orientation)

This line is the end of the test record.

Test Record
Radiated Emission Test RE08
Project GCL0458

Test Date(s) 11 Oct 2023
 Test Personnel Dave Kerr, Jim Solum

Product Model A04714
 Serial Number tested 3453413644

Operating Mode M5 (Ant Tx)
 Arrangement A2 (Upwr)
 Input Power 5 Vdc (USB)

Test Standards: FCC Part 15, ANSI C63.10 (as noted in Section 6 of the report).

Frequency Range: 1 GHz to 18 GHz
Pass/Fail Judgment: PASS

Test record created by: Dave Kerr
Date of this record: 11 Oct 2023

Original record, Version A.

Test Equipment

Description	Make	Model #	Serial #	Last Cal/Ver	Next Due
PXE Receiver 44GHz	Keysight	N9048B	MY62220139	30-Jan-2023	1-Feb-2024
Antenna, Horn, 1-18 GHz	ETS Lindgren	3117	00259208	7-Jun-2023	1-Jun-2024
FSOATS 3m, above 1 GHz	Frankonia	SAC3	F199004	16-Nov-2022	16-Nov-2025
Tape measure, 1" x 33'	Lufkin	PHV1410CMEN	10720	16-Jan-2023	15-Jan-2026
Preamplifier, 500 MHz 18 GHz	Com-Power	PAM-118A	18040133	Calibration	Not Required
3 GHz High Pass filter	Anatech Electronics	OK0R2	01	Calibration	Not Required

Table RE08.1: Test Equipment Used

Software Used: N9048B Keysight PXE firmware version A.33.03
 EPX/RE automation software ver. 2023.01.001

Test Data

The radiated emission test process began with a preliminary scan at multiple turntable angles, antenna heights, and both antenna polarizations. For test standards that require reorienting the test sample, further preliminary scans were taken in those alternate orientations typically described as X, Y, and Z. Subsequent testing was done using on the orientation(s) producing the highest result relative to the test limit. Where the test standard requires cable manipulation, this was done at one of more likely worst case frequencies selected by the test personnel while observing the receiver display. At each of the frequencies selected for final measurements, the turntable angle, antenna height, and antenna polarization were explored to find the worst-case settings. Final field strength measurements were taken in that set of positions. Full maximization was not performed at frequencies that are noise floor measurements included per the test standard requirements.

At azimuth angle 180° the 'front' reference mark of the turntable is pointed Southward. At 270° the reference mark points West. At 90° it points East. At 173° the turntable reference mark is pointed directly at the antenna. The designation of the X, Y, and Z orientations of the test sample are sample dependent, so these are reported by use of photographs.

The tables show the selected final measurement data between 1 GHz and 18 GHz. It includes the strongest emissions observed relative to the test limit, along with other data points of interest. Where a data point is highlighted in yellow, this is an aid to indicate the data point(s) with the least margin to the test limit. A positive margin value indicates that the emission was below the test limit. The test limit is the FCC Class B Limit at 3m.

The test sample was transmitting with a 96% duty cycle during this test. The client states that the maximum duty cycle for the ANT protocol is 13%. The CISPR Average detector has a square law response for signal pulses with these ANT timing parameters. In the data tables below, the Average detector values for the carrier frequencies have been adjusted downward by 17.4 dB, which is $20 * \log(13\% / 96\%)$. The Peak detector values are not reduced for duty cycle, nor were the other emissions adjusted for duty cycle.

Frequency MHz	Pol.	Reading		Factor	Level		Limit		Margin		Height cm	Angle deg	
		dB(μ V)			dB(1/m)	dB(μ V/m)		dB(μ V/m)		dB			
		CAV	PK			CAV	PK	AV	PK	CAV			PK
2402.000	H	80.4	98.7	-1.7	78.7	97.0	94.0	114.0	15.3	17.0	215.3	153.0	
4804.000	H	47.6	56.2	4.0	51.6	60.2	54.0	74.0	19.8	13.8	243.3	120.0	
5293.000	H	34.4	52.1	5.0	39.4	57.1	54.0	74.0	14.6	16.9	258.6	78.0	
2402.000	V	79.5	97.8	-1.7	77.8	96.1	94.0	114.0	16.2	17.9	326.0	46.0	
5952.250	V	35.0	52.4	6.6	41.6	59.0	54.0	74.0	12.4	15.0	100.0	349.0	

Table RE08.2: Emission summary (Ant low 1-6GHz 2402MHz)

Frequency MHz	Pol.	Reading		Factor	Level		Limit		Margin		Height cm	Angle deg	
		dB(μ V)			dB(1/m)	dB(μ V/m)		dB(μ V/m)		dB			
		CAV	PK			CAV	PK	AV	PK	CAV			PK
4880.000	H	42.0	54.2	4.0	46.0	58.2	54.0	74.0	25.4	15.8	321.8	147.0	
5853.250	H	34.9	51.3	6.1	41.0	57.4	54.0	74.0	13.0	16.6	161.5	117.0	
5977.750	H	34.9	51.5	6.7	41.6	58.2	54.0	74.0	12.4	15.8	104.6	311.0	
2440.000	V	97.9	98.8	-1.4	96.5	97.4	94.0	114.0	14.9	16.6	317.4	53.0	

Table RE08.3: Emission summary (Ant Mid 1-6GHz 2440MHz)

Frequency MHz	Pol.	Reading		Factor	Level		Limit		Margin		Height cm	Angle deg	
		dB(μ V)			dB(1/m)	dB(μ V/m)		dB(μ V/m)		dB			
		CAV	PK			CAV	PK	AV	PK	CAV			PK
4018.750	H	35.3	51.8	1.9	37.2	53.7	54.0	74.0	16.8	20.3	214.5	286.0	
4960.000	H	46.7	56.2	4.2	50.9	60.4	54.0	74.0	20.5	13.6	100.0	159.0	
5540.500	H	34.5	50.7	5.5	40.0	56.2	54.0	74.0	14.0	17.8	108.6	141.0	
2480.000	V	96.4	97.3	-1.3	95.1	96.0	94.0	114.0	16.3	18.0	310.1	51.0	
2484.500	H	36.4	61.9	-1.3	35.1	60.6	54.0	74.0	18.9	13.4	400.0	166.0	

Table RE08.4: Emission summary (Ant High 1-6GHz 2480)

Frequency MHz	Pol.	Reading		Factor	Level		Limit		Margin		Height cm	Angle deg	
		dB(μ V)			dB(1/m)	dB(μ V/m)		dB(μ V/m)		dB			
		CAV	PK			CAV	PK	AV	PK	CAV			PK
7205.560	H	29.1	39.5	11.6	40.7	51.1	54.0	74.0	13.3	22.9	211.8	187.0	
8562.260	H	19.3	34.0	14.7	34.0	48.7	54.0	74.0	20.0	25.3	205.1	119.0	
14219.900	H	17.4	32.7	20.8	38.2	53.5	54.0	74.0	15.8	20.5	384.9	12.0	

Table RE08.5: Emission summary (Ant low 6-18GHz 2402MHz)

Frequency	Pol.	Reading		Factor	Level		Limit		Margin		Height	Angle
MHz		dB(μV)		dB(1/m)	dB(μV/m)		dB(μV/m)		dB		cm	deg
		CAV	PK		CAV	PK	AV	PK	CAV	PK		
8611.850	V	19.3	33.4	14.8	34.1	48.2	54.0	74.0	19.9	25.8	279.9	149.0
7320.550	H	29.5	39.9	12.0	41.5	51.9	54.0	74.0	12.5	22.1	215.8	194.0

Table RE08.6: Emission summary (Ant Mid 6-18GHz 2440MHz)

Frequency	Pol.	Reading		Factor	Level		Limit		Margin		Height	Angle
MHz		dB(μV)		dB(1/m)	dB(μV/m)		dB(μV/m)		dB		cm	deg
		CAV	PK		CAV	PK	AV	PK	CAV	PK		
7440.570	H	25.4	37.3	12.2	37.6	49.5	54.0	74.0	16.4	24.5	276.3	196.0
7196.860	H	21.3	35.4	11.6	32.9	47.0	54.0	74.0	21.1	27.0	149.8	120.0
17111.940	H	17.2	31.4	25.7	42.9	57.1	54.0	74.0	11.1	16.9	369.1	91.0
17612.030	H	16.3	31.3	25.6	41.9	56.9	54.0	74.0	12.1	17.1	321.7	309.0

Table RE08.7: Emission summary (Ant High 6-18GHz 2480)

The graphs below shows the background spectrum observed during pre-scan, as well as the final data points from the table above.

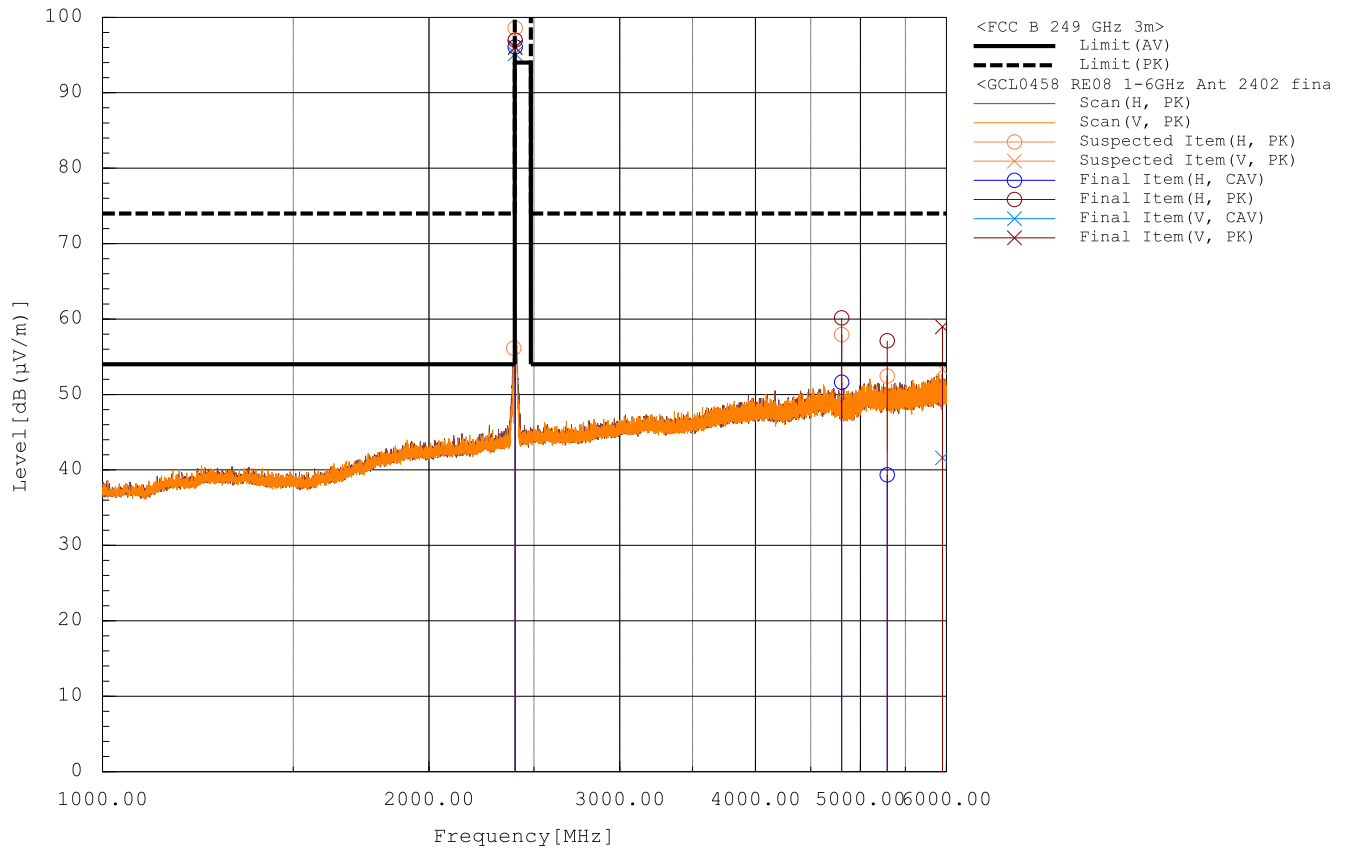

Figure RE08.1: Spectral data (Ant low1-6GHz 2402MHz)

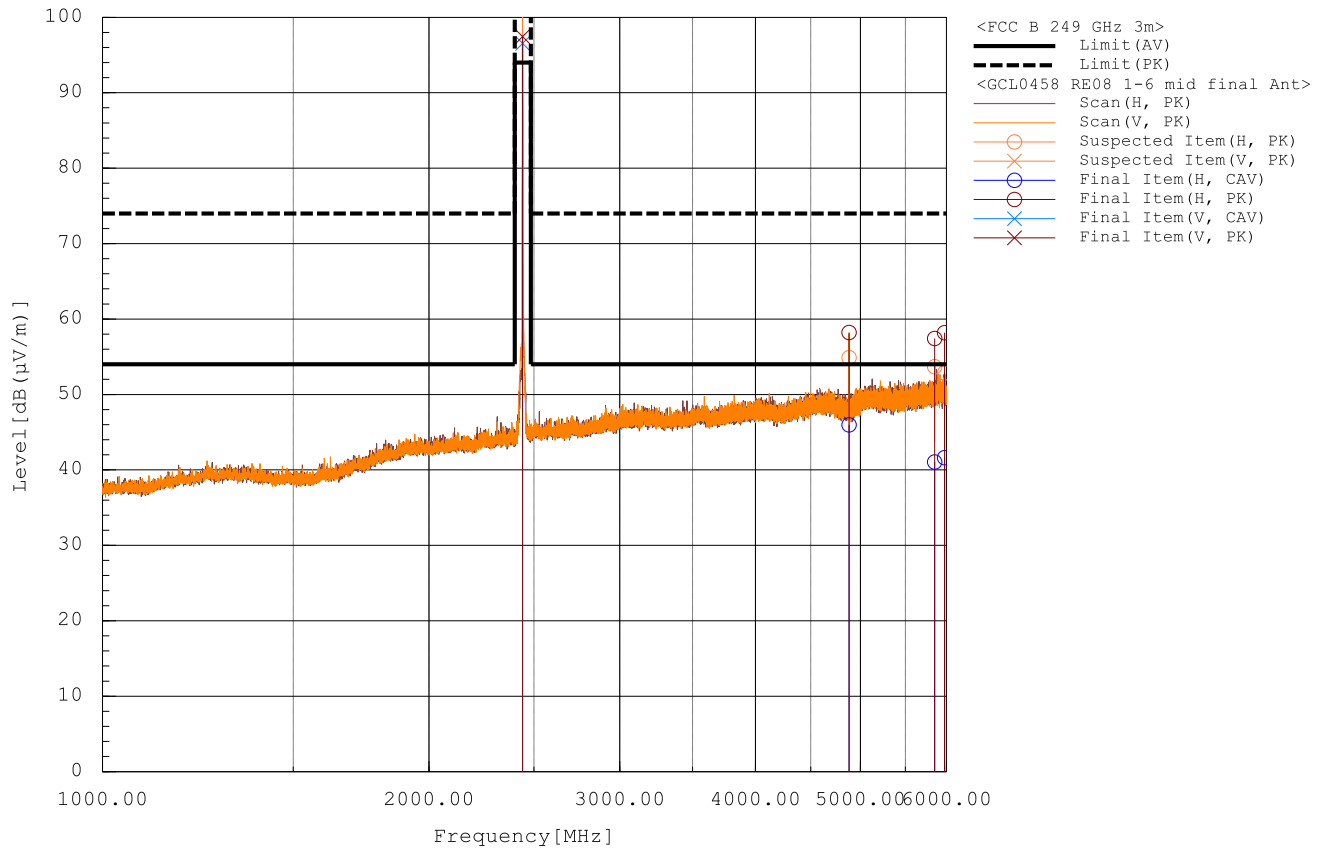

Figure RE08.2: Spectral data (Ant 1-6GHz Mid 2440MHz)

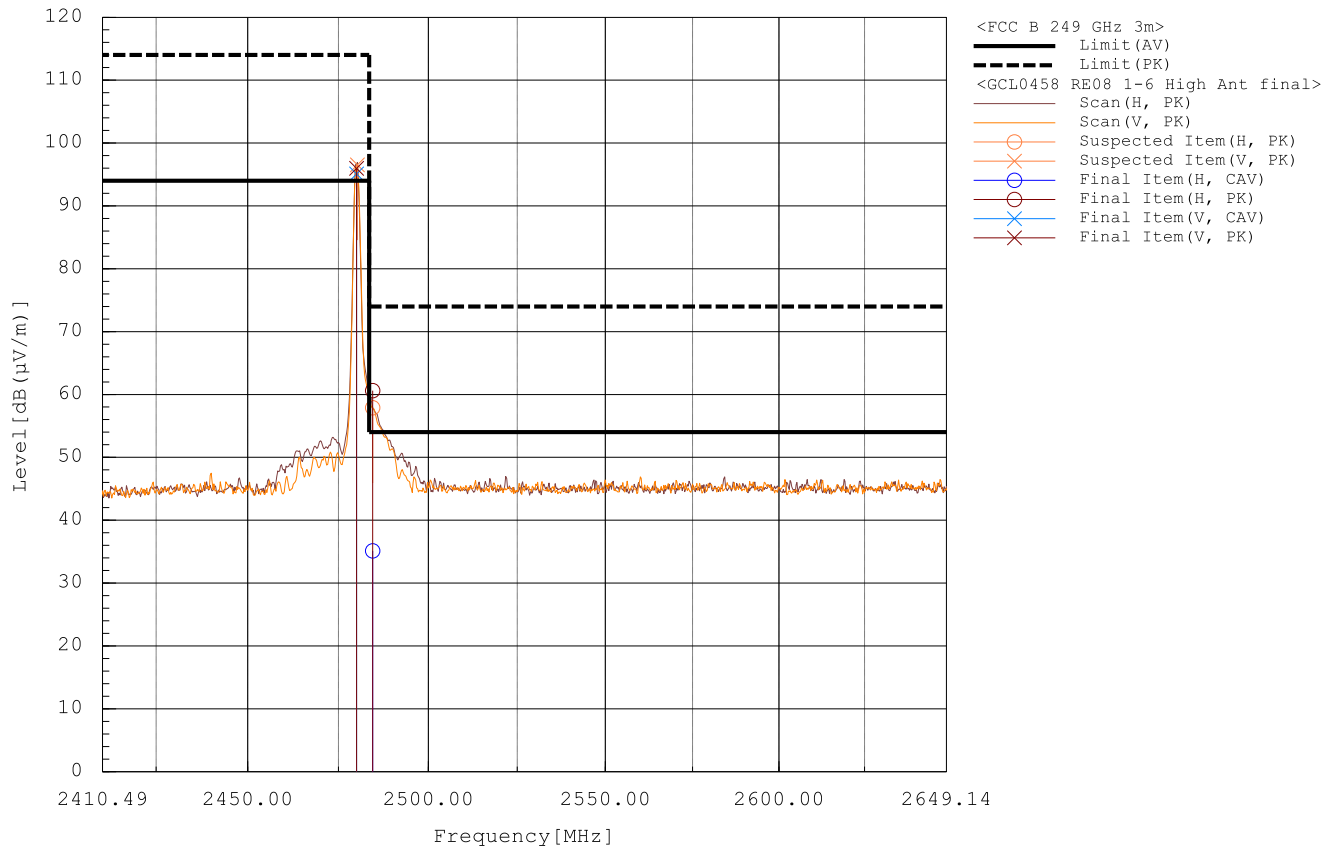

Figure RE08.3: Spectral data (Ant 1-6GHz High 2480)

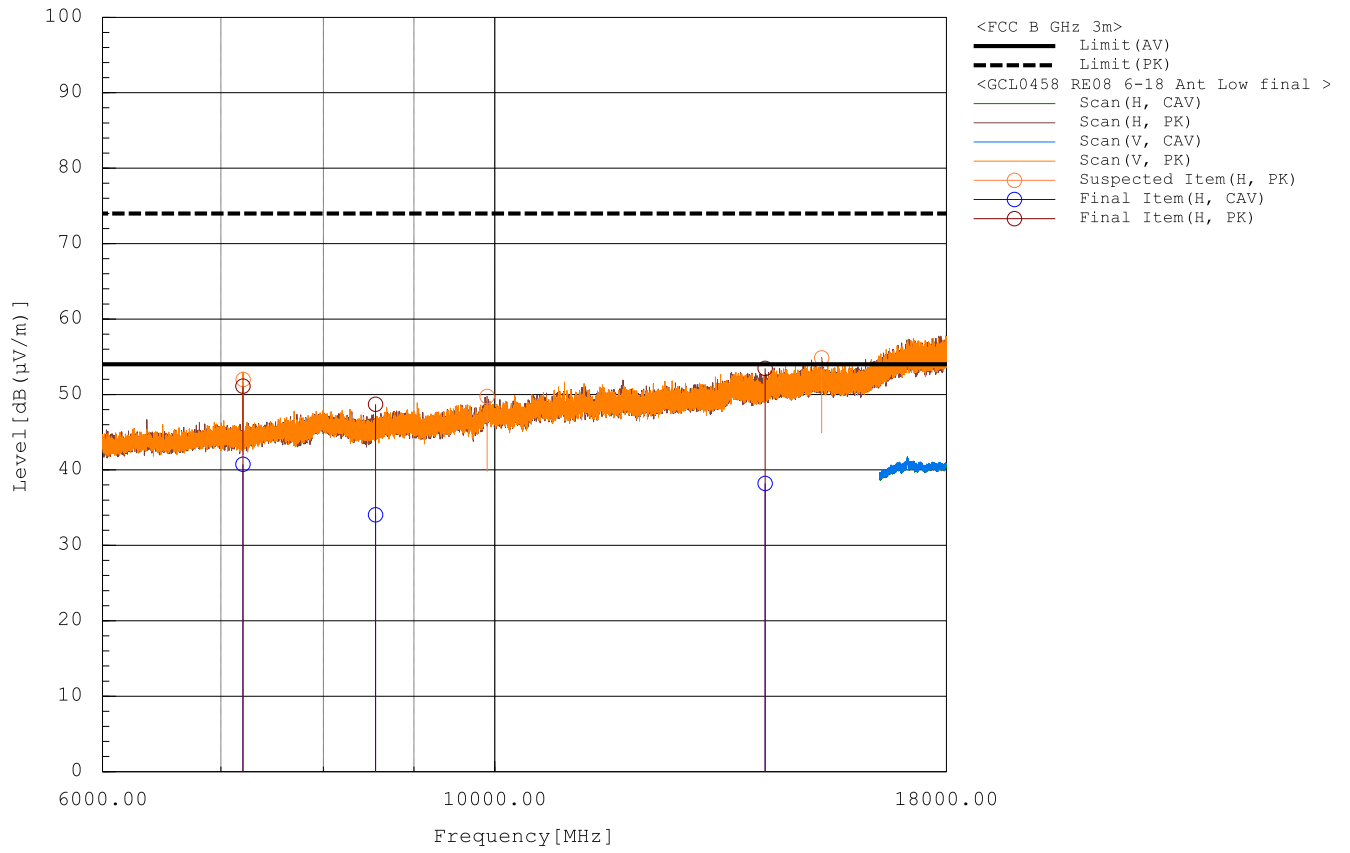

Figure RE08.4: Spectral data (Ant low 6-18GHz 2402MHz)

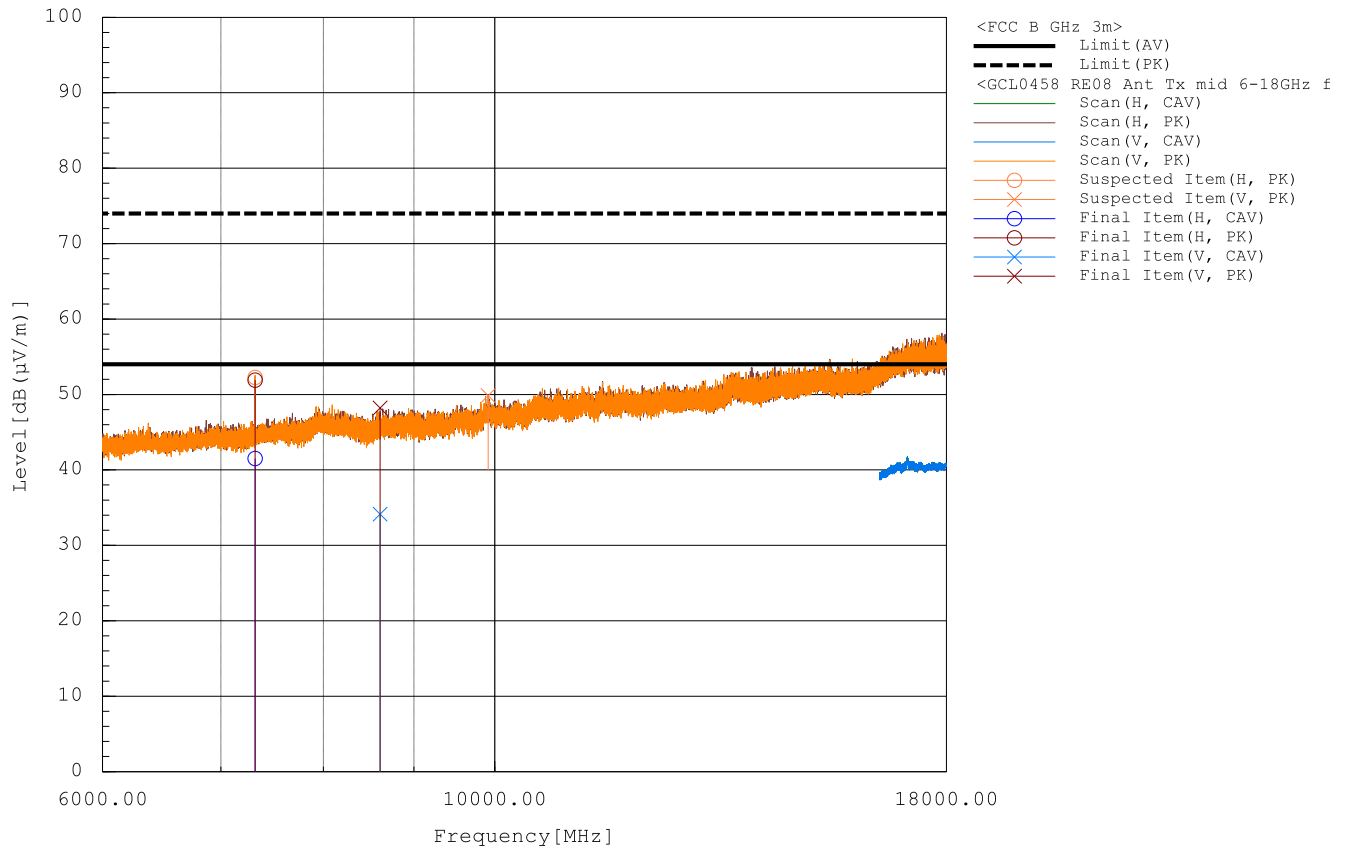

Figure RE08.5: Spectral data (Ant 6-18GHz Mid 2440MHz)

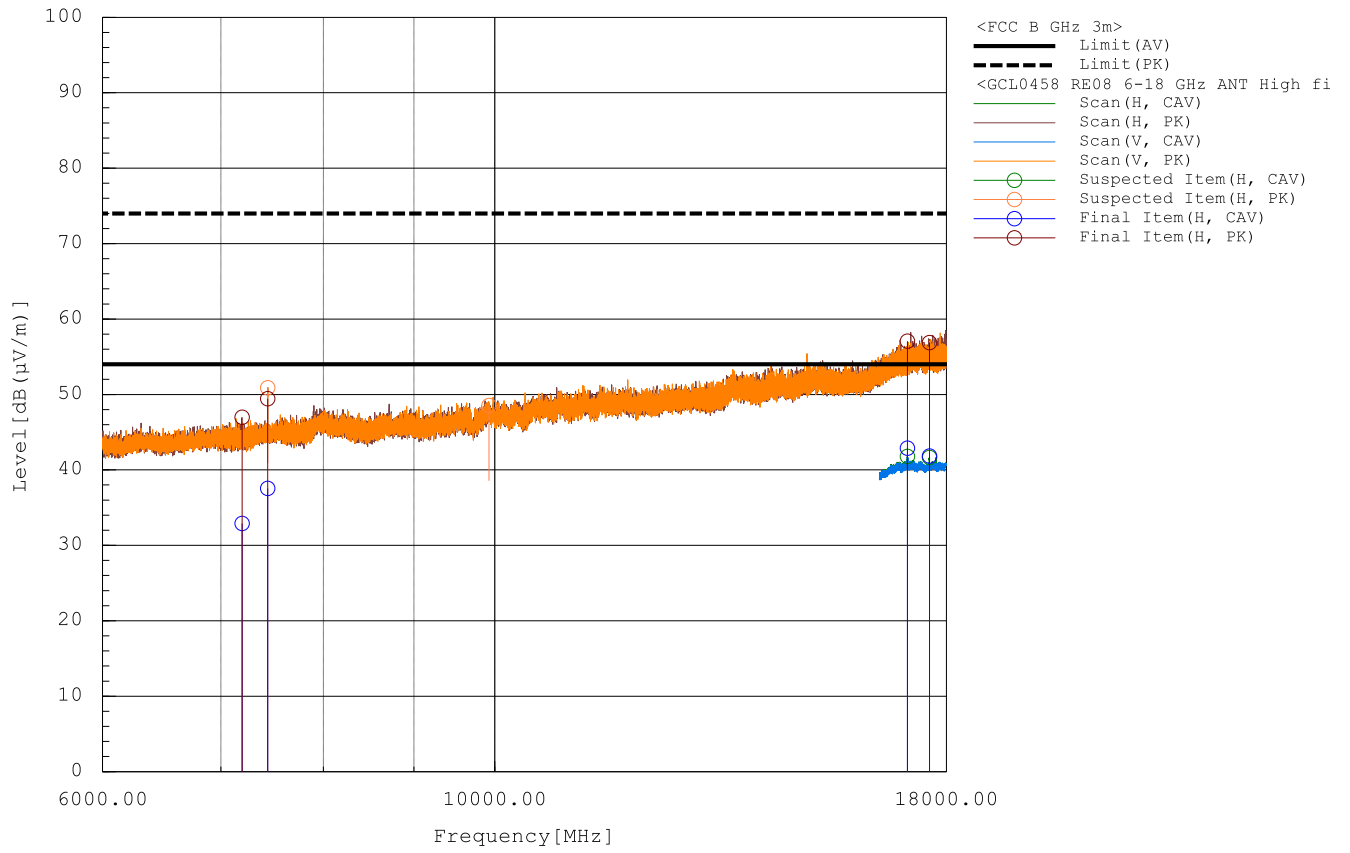

Figure RE08.6: Spectral data (Ant 6-18GHz High 2480)

Setup Photographs

The following photographs show the EUT configured and arranged in the manner in which it was measured.



Figure RE08.4: EUT test setup, front view



Figure RE08.5: EUT test setup, reverse view

This line is the end of the test record.

Test Record
Radiated Emission Test RE09
Project GCL0458

Test Date(s) 06 Oct 2023
 Test Personnel Jim Solum

Product Model A04714
 Serial Number tested 3453413644

Operating Mode M5 (ANT Tx)
 Arrangement A2 (Upwr)
 Input Power 5 Vdc

Test Standards: FCC Part 15, ANSI C63.10, RSS-210 (as noted in Section 6 of the report).

Frequency Range: 18 GHz to 26.5 GHz
Pass/Fail Judgment: PASS

Test record created by: Jim Solum
Date of this record: 11 Oct 2023

Original record, Version A.

Test Equipment

Description	Make	Model #	Serial #	Last Cal/Ver	Next Due
PXE Receiver 26 GHz	Keysight	N9048B	MY59290135	27-Sep-2023	1-Oct-2024
Antenna, Horn, 10-40 GHz	ETS Lindgren	3116C	00259186	23-Mar-2023	1-Apr-2024
Preamplifier, 18 Ghz to 40 Ghz	Com-Power	PAM-840A	461364	Calibration	Not Required
FSOATS 3m, above 1 GHz	Frankonia	SAC3	F199004	16-Nov-2022	16-Nov-2025
Tape measure, 1" x 33'	Lufkin	PHV1410CMEN	10721	30-Aug-2023	1-Sep-2026

Table RE09.1: Test Equipment Used

Software Used: Keysight PXE software A.32.06
 RE Signal Maximization Tool v2023Jul14.xlsx
 RE 18G to 26G 1 meter Data AnalysisV1 2022Oct12.xlsx

Test Data

The radiated emission test process began with a preliminary scan at multiple turntable angles, antenna heights, and both antenna polarizations. For test standards that require reorienting the test sample, further preliminary scans were taken in those alternate orientations typically described as X, Y, and Z. Subsequent testing was done using on the orientation(s) producing the highest result relative to the test limit. Where the test standard requires cable manipulation, this was done at one of more likely worst case frequencies selected by the test personnel while observing the receiver display. At each of the frequencies selected for final measurements, the turntable angle, antenna height, and antenna polarization were explored to find the worst-case settings. Final field strength measurements were taken in that set of positions. Full maximization was not performed at frequencies that are noise floor measurements included per the test standard requirements.

In the 18 GHz to 26.5 GHz frequency range, pre-scan spectral data was taken at 1 meter and extrapolated to a 3 meter distance. Final measurements were made at 3 meters.

At azimuth angle 0° the 'front' reference mark of the turntable is pointed Southward. At 90° the reference mark points West. At -90° it points East. At -7° the turntable reference mark is pointed directly at the antenna. The designation of the X, Y, and Z orientations of the test sample are sample dependent, so these are reported by use of photographs.

The table shows the selected final measurement data between 18 GHz and 26.5 GHz. Where a data point is highlighted is yellow, this is an aid to indicate the data point(s) with the least margin to the test limit. A positive margin value indicates that the emission was below the test limit. The test limit is the FCC Class B Limit at 3m.

Frequency (MHz)	Avg Limit (dBuV/m)	Pk Limit (dBuV/m)	Avg Level (dBuV/m)	Pk Level (dBuV/m)	Av Margin (dB)	Pk Margin (dB)	Azimuth (degree)	Height (mm)	Antenna Polarity	EUT Polarity
24020.000	54.00	74.00	45.80	59.40	8.20	14.60	80	1729	HORZ	X

Table RE09.2: Emission summary

The graph below shows the background spectrum observed during pre-scan, as well as the final data points from the table above.

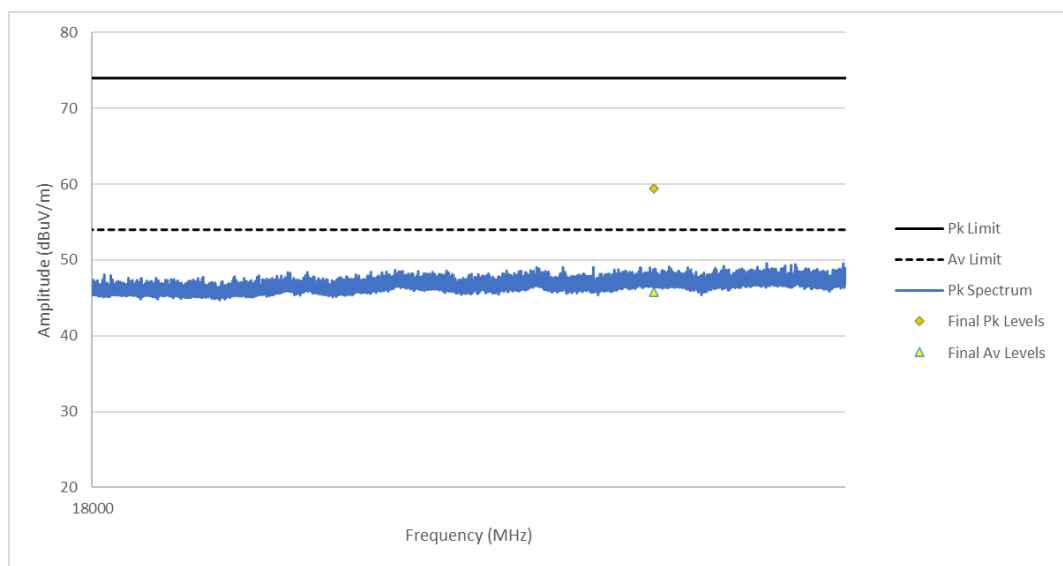

Figure RE09.1: Spectral data

Setup Photographs

The following photographs show the EUT configured and arranged in the manner in which it was measured.

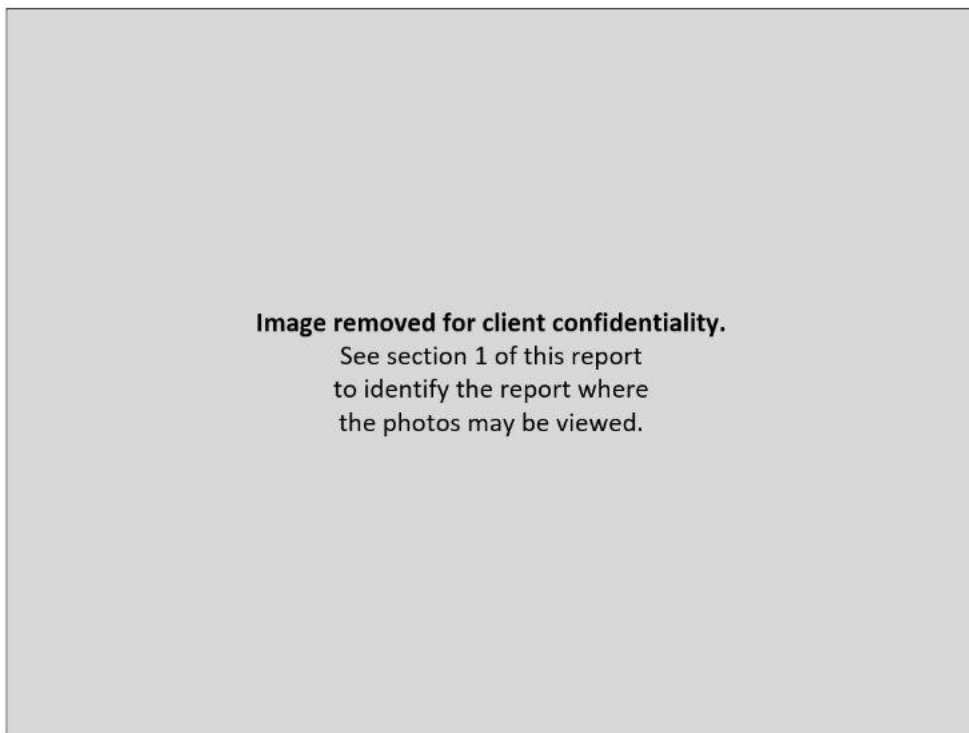

Figure RE09.2: EUT test setup, front view

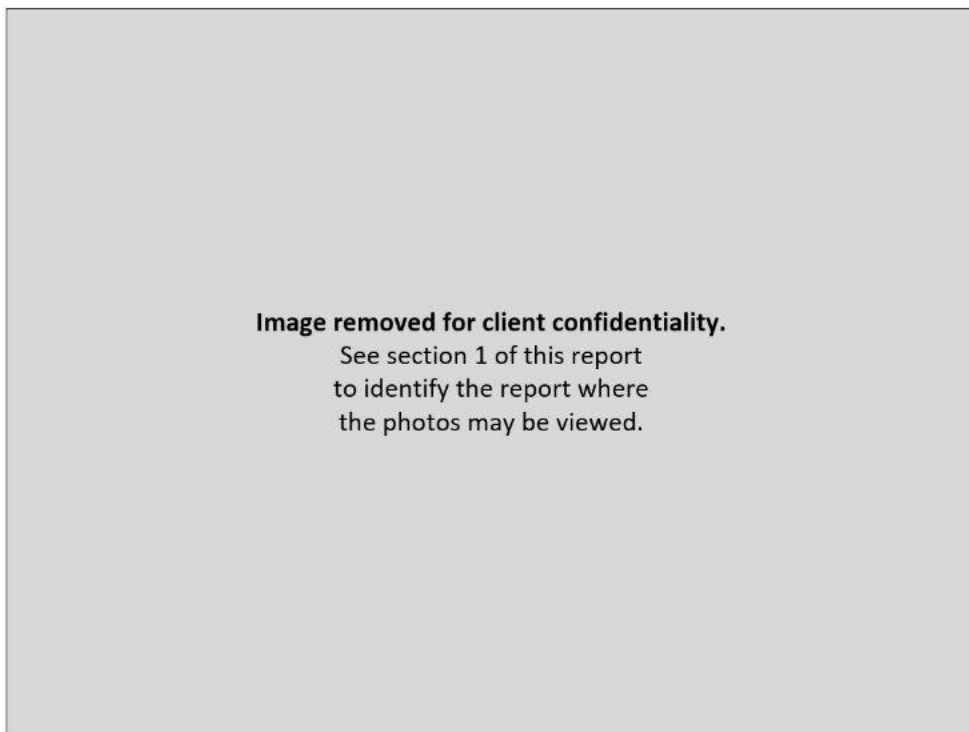

Figure RE09.3: EUT test setup, reverse view

This line is the end of the test record.

Test Record
Transmitter Stability in Extreme Conditions
Test IDs TR15
Project GCL-0458

Test Date(s) 15 Oct 2023
 Test Personnel Majid Farah

Product Model A04714
 Serial Number tested 3453413731

Operating Mode M1 (BtTx)
 Arrangement A3 (Udata)
 Nominal Input Power 5 Vdc

Test Standards: FCC part 15, RSS-GEN, ANSI C63.10 (as noted in Section 6 of the report)

Radio Protocol BLE (Bluetooth Low Energy), ANT

Pass/Fail Judgment: PASS

Test record created by: Majid Farah
Date this record: 18 Oct 2023
 Original record, Version A.

Test Equipment

Description	Make	Model #	Serial #	Last Cal/Ver	Next Due
PXE Receiver 44GHz	Keysight	N9048B	MY62220139	30-Jan-2023	1-Feb-2024
Thermometer	Thermco	ACCD370P	220608121	26-Aug-2022	1-Sep-2024
Barometer	Traceable	6453	221702700	3-Aug-2022	1-Aug-2024
DMM Multimeter	FLUKE	79 III	71740743	5-Apr-2023	1-Apr-2024
Programmable DC power source	Keithley	2260B-30-72 720 W	1411917	21-Apr-2023	15-Apr-2024
Thermal Chamber	Tenney	T2RC	32774-02	Calibration	Not Required

Table TR15.1: Equipment used

Software Used: PXE Software Revision A.33.03, FrequencyStabilityAnalysisTemplateV1.xlsx

Test Method

The standards cited require observation of the stability for transmission frequency and/or power at certain environmental extremes. The reference is performance on nominal input voltage and a temperature of 20 °C. Where the standards cited here impose different limits or conditions, the most stringent limits and conditions have been applied.

The acceptance criterion is that the 6 dBc Occupied Bandwidth of the modulated signal should remain within the 2400-2483.5 MHz radio band.

The modes utilized include those that showed emissions closest to the band edge during prior bandwidth testing.

Test Data

The test sample(s) were subjected to extreme conditions and performed as shown below. Yellow highlights indicate the highest level for a protocol, for which an image of the spectrum is also provided. In the spectral plots, the data sets have been combined to present the low and high channel results side by side. Orange diamond markers indicate the spectral peak, which the black square markers are at the 2400 MHz or 2483.5 MHz band edge.

Tx Mode	Temp	Volts	Low Ch.	High Ch.
Bluetooth	°C	Vdc	dBc	dBc
BLE 1 Mbps	50	5	31.2	36.4
BLE 1 Mbps	40	5	32.3	34.6
BLE 1 Mbps	30	5	32.0	34.1
BLE 1 Mbps	20	5	32.7	32.8
BLE 1 Mbps	10	5	33.2	32.1
BLE 1 Mbps	0	5	32.6	31.2
BLE 1 Mbps	-10	5	33.1	30.5
BLE 1 Mbps	-20	5	32.4	30.0

Table TR15.2 Difference between peak and band edge levels for BLE 1 Mbps transmissions during temperature variations

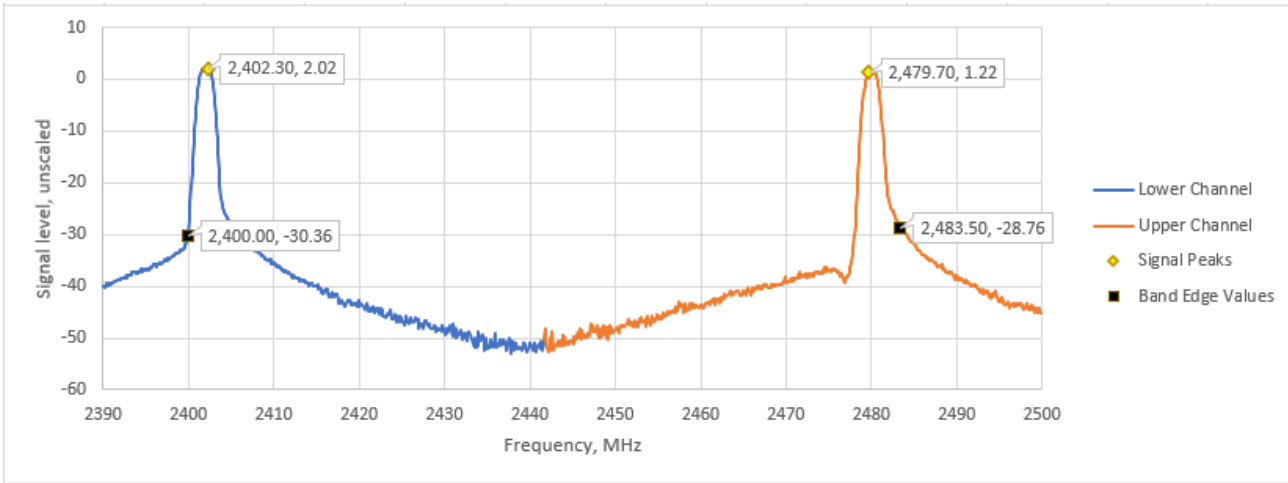

Figure TR15.1: Spectral data for BLE 1 Mbps at -20 °C which represent low and high channel

Tx Mode	Temp	Volts	Low Ch.	High Ch.
Bluetooth	°C	Vdc	dBc	dBc
BLE 1 Mbps	20	4.25	32.7	32.9
BLE 1 Mbps	20	5	32.7	32.8
BLE 1 Mbps	20	5.75	32.9	32.8

Table TR15.3 Difference between peak and band edge levels for BLE 1 Mbps transmissions at 20 °C during voltage variations

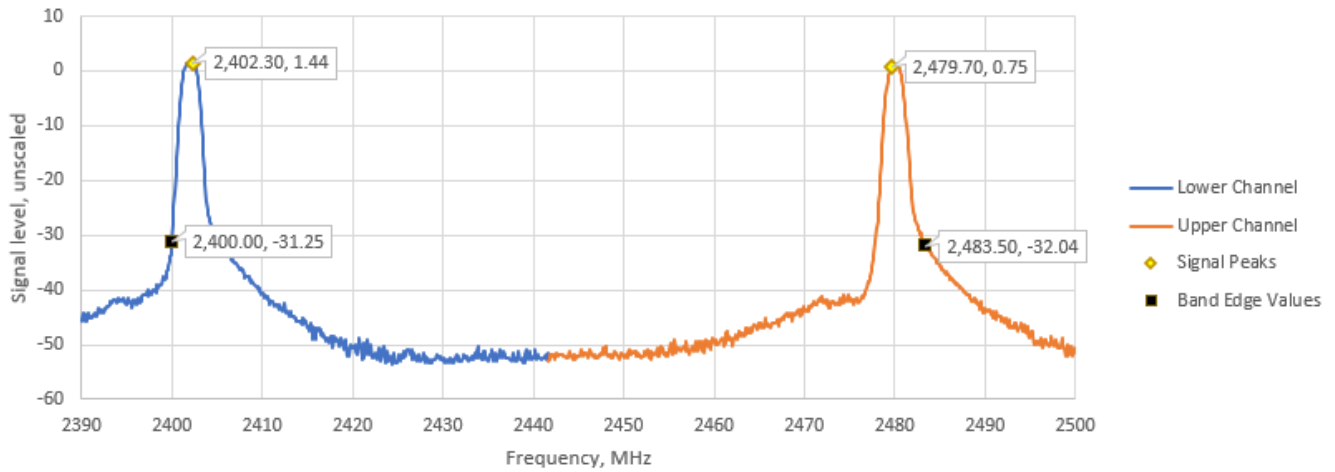

Figure TR15.2: Spectral data for BLE 1 Mbps at 20 °C which represent low and high channel

Setup Block Diagram

The following block diagrams show the EUT configured and arranged in the manner which it was measured.

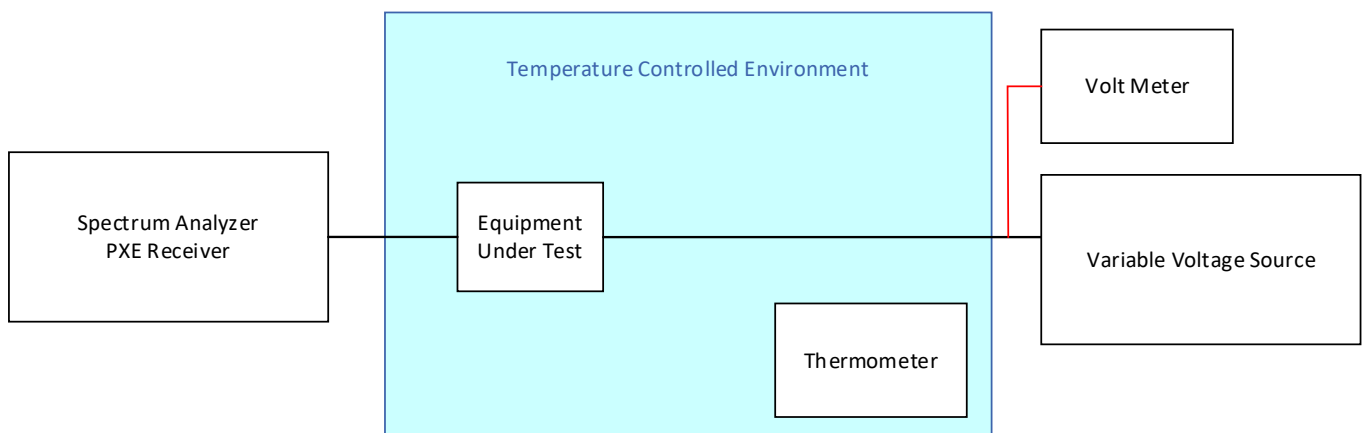

Figure TR15.3: Schematic drawing of the test equipment setup

This line is the end of the test record.

Test Record
Transmitter Bandwidth Tests
Test IDs TR03
Project GCL0458

Test Date(s) 28 Sep 2023
 Test Personnel Majid Farah

Product Model A04714
 Serial Number tested 3453413731

Operating Mode M10 (All2.4)
 Arrangement A3 (Udata)
 Input Power 5 Vdc

Test Standards: FCC Part 2.202, ANSI C63.10, TRC-43, RSS-GEN (as noted in Section 6 of the report).

Radio Protocol Bluetooth Low Energy (BLE), ANT
 Radio Band 2400 to 2483.5 MHz

Pass/Fail Judgment: Reported

Test record created by: Majid Farah
Date of this record: 03 Oct 2023
 Original record, Version A.

Test Equipment Used

Description	Make	Model #	Serial #	Last Cal/Ver	Next Due
PXE Receiver 44GHz	Keysight	N9048B	MY62220146	3-Jun-2023	3-Jun-2024

Table TR03.1: List of test equipment used

Test Software Used: Keysight PXE firmware A.35.06

Background

There are regulatory requirements to present two additional types of bandwidth analyses: 99% Occupied Bandwidth and Necessary Bandwidth. There are no limits or functional requirements around these data, beyond a reporting requirement. The contents of this test record are for information, and do not affect compliance of the devices that are the subject of this report.

For BLE operating at 2 Mbps, the lowest operating frequency was 2404 MHz, and the highest operating frequency was 2478 MHz. For all other Bluetooth, BLE, and ANT radios reported here, the lowest operating frequency was 2402 MHz, and the highest operating frequency was 2480 MHz.

Test Setup

This block diagram shows the test equipment setup.

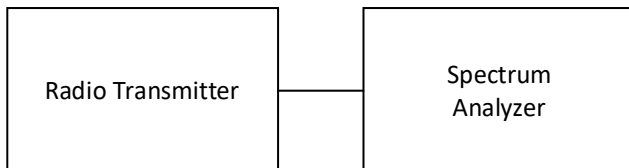

Figure TR03.1: Test setup

Occupied Bandwidth, 99% Test Method

During this test the transmitter output is fed directly, or through RF attenuators, to the spectrum analyzer. The analyzer has a built-in capability to identify the minimum bandwidth that contains a specified percentage of the total power observed. The spectrum is scanned hundreds of times so that the varied effects of modulation are appropriately assessed. Since the focus is on the relative distribution of energy across a range of frequencies, the absolute amplitudes recorded during this test are not relevant and may not include cable losses or attenuation factors.

Occupied Bandwidth, 99% Test Data

The data for each type of bandwidth is summarized below, followed by the spectral data for the cases highlighted in yellow. The analysis threshold for this test was the bandwidth containing 99% of the observed power using the ANSI C63.10 method. The standards require testing a frequency near the bottom, middle, and top of the band. The measured bandwidth data have MHz as their units of measure.

		2402 (04)	2440	2480 (78)
BLE	1 Mbps	1.049	1.049	1.051
BLE	2 Mbps	2.044	2.046	2.049
ANT		0.986	0.986	0.989

Table TR03.2: Summary of 99% bandwidth data in MHz for ANT and BLE modes

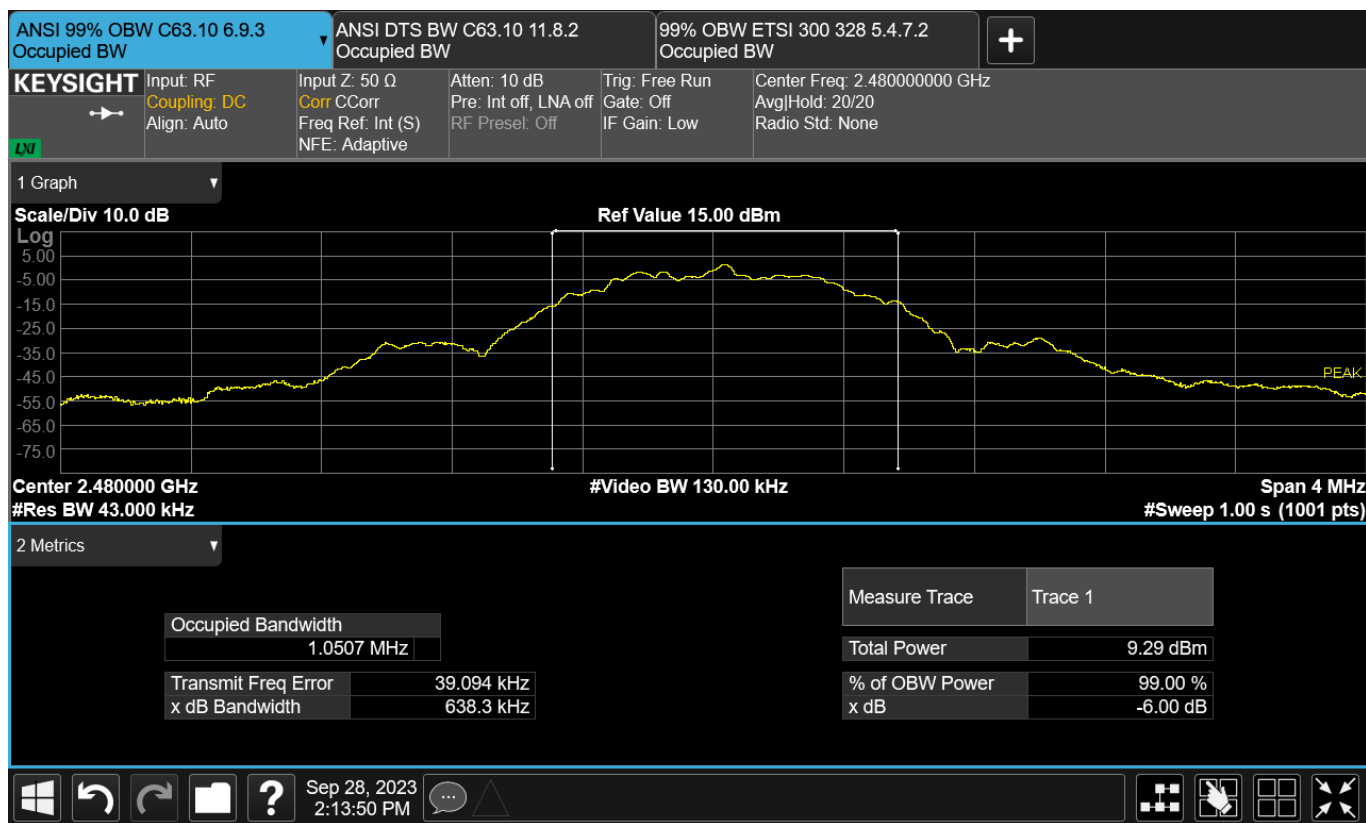

Figure TR03.2: Bandwidth data for BLE 1 Mbps at 2480 MHz

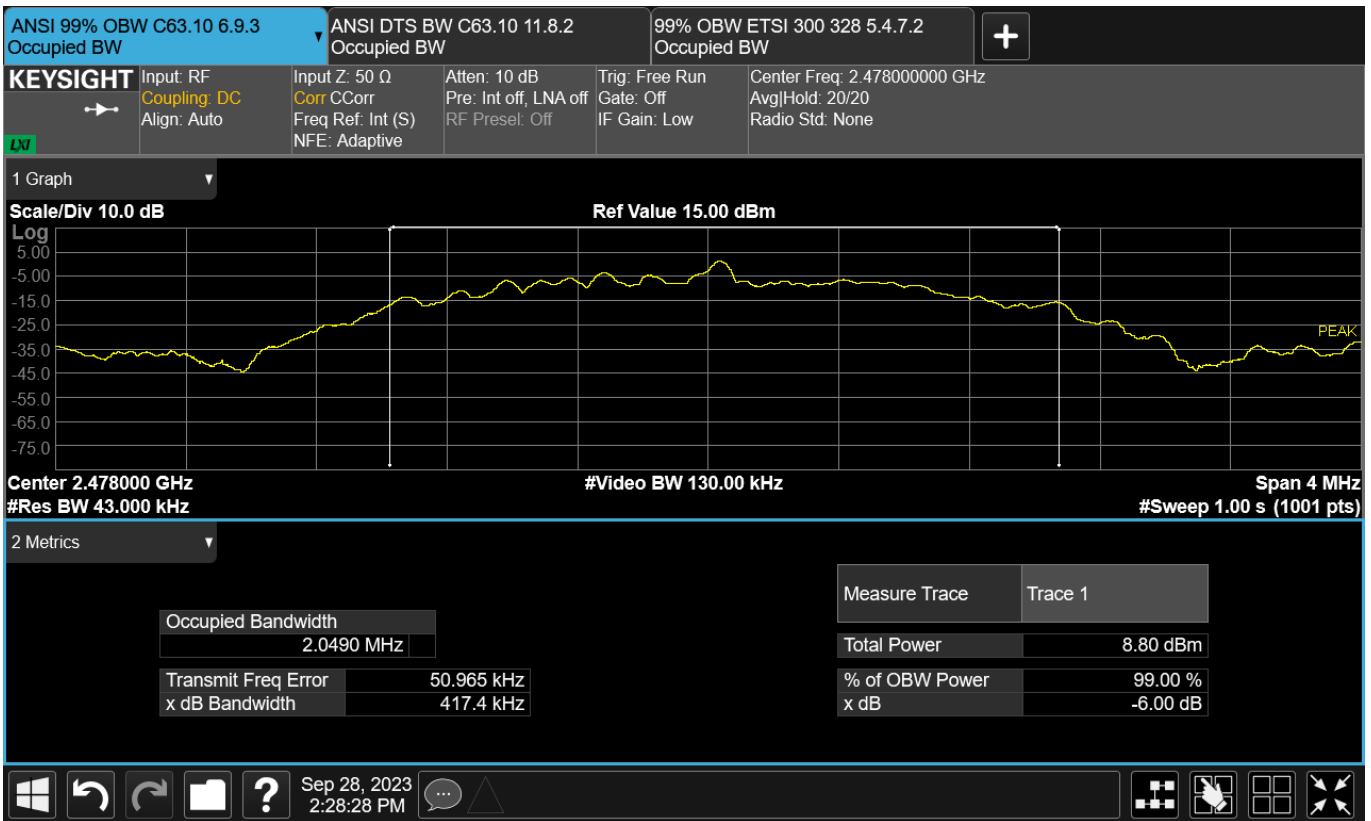

Figure TR03.3: Bandwidth data for BLE 2 Mbps at 2478 MHz

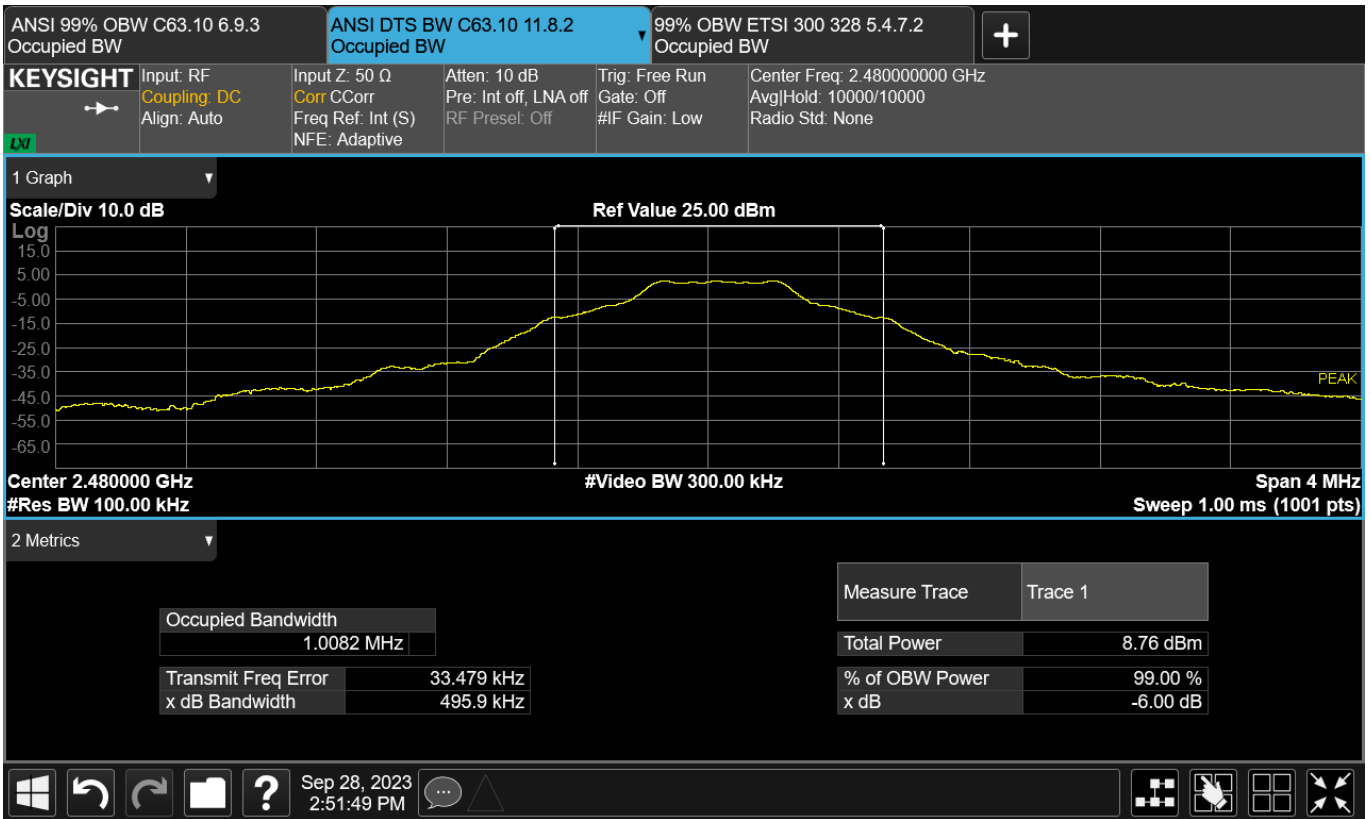

Figure TR03.4: Bandwidth data for ANT at 2480 MHz

Necessary Bandwidth Calculations

The Necessary Bandwidth is a theoretical value based on the specifications for a communication protocol, rather than the hardware implementation and a subsequent lab measurement. The analysis methods in FCC Part 2.202 and TRC-43 are the same for Bluetooth, ANT, and IEEE 802.11b WiFi. However, they differ for IEEE 802.11g and 11n systems because the Canadian TRC-43 standard provides different analysis methods for Orthogonal Frequency Division Multiplexing systems (OFDM). The tables below will show the analysis for most of the radios signals as a combined approach, then separately analyze the results for IEEE 802.11g and n systems. The tables below may include radio protocols that are not part of the product being evaluated.

The radio modulation schemes for Ant, for the various Bluetooth protocols, and for IEEE 802.11 b WiFi are a mix of Phase Shift Key (PSK) and Quadrature Amplitude Modulation (QAM) techniques. The Necessary Bandwidth calculations use the equations from 47CFR Part 2.202(g) table section 6. We have set the variable K=1, which leaves the equation for both PSK and QAM as:

$$B_N = 2R / \text{Log}_2(S)$$

where B_N is the Necessary Bandwidth, R is the bit rate, and S is the number of signaling states.

Radio Type	R Mbps	K	S	LogBase2 of (S)	BN (MHz)
ANT / ANT+	1	1	2	1	2

Table TR03.101: Necessary Bandwidth for ANT and ANT+ Radio Protocols (FCC and TRC-43)

Radio Type	Sub-type	Method	R Mbps	K	S	LogBase2 of (S)	BN (MHz)
Bluetooth	BR	GFSK	1	1	2	1	2
	EDR2	Pi/4 DPSK	2	1	4	2	2
	EDR3	8DPSK	3	1	8	3	2
BLE	1Mbps	GFSK	1	1	2	1	2
	2Mbps	DQPSK	2	1	4	2	2

Table TR03.102: Necessary Bandwidth for Bluetooth Radio Protocols (FCC and TRC-43)

Radio Type	Sub-type	R Mbps	K	S	LogBase2 of (S)	BN (MHz)
802.11 b	1	1	1	2	1	2
	2	2	1	4	2	2
	5.5	5.5	1	4	2	5.5
	11	11	1	4	2	11

Table TR03.103: Necessary Bandwidth for IEEE 802.11 b Radio Protocol (FCC and TRC-43)

Radio Type	Sub-type	R Mbps	K	S	LogBase2 of (S)	BN (MHz)
802.11 g	6	6	1	2	1	12
	9	9	1	2	1	18
	12	12	1	4	2	12
	18	18	1	4	2	18
	24	24	1	16	4	12
	36	36	1	16	4	18
	48	48	1	64	6	16
	54	54	1	64	6	18
	802.11 n	MCS0	7.2	1	2	1
MCS1		14.4	1	4	2	14.4
MCS2		21.7	1	4	2	21.7
MCS3		28.9	1	16	4	14.5
MCS4		43.3	1	16	4	21.7
MCS5		57.8	1	64	6	19.3
MCS6		65	1	64	6	21.7
MCS7		72.2	1	64	6	24.1

Table TR03.104: Necessary Bandwidth for IEEE 802.11 g and n 20 MHz Radio Protocols (FCC)

As a note, the bit rate for IEEE 802.11 n WiFi is calculated based on the IEEE standard's short guard interval of 400 nsec. If only the long guard interval of 800 nsec were implemented, the bit rate for MCS7 would decrease to 65 Mbps for a Necessary Bandwidth of 21.7 MHz.

The TRC-43 method for OFDM signals simply multiplies the number of subcarriers, K, and the subcarrier spacing, N_s. In both cases, N_s is 312.5 kHz. The count of subcarriers includes nulls. So for example, 802.11 n uses 4 pilot subcarriers, 52 data subcarriers, and one null suppressed subcarrier in the middle for 57 total subcarrier channels.

$$B_N = N_s * K$$

Radio Type	N _s (MHz)	K	BN (MHz)
802.11g	0.3125	53	16.6
802.11n	0.3125	57	17.8

Table TR03.105: Necessary Bandwidth for IEEE 802.11 g and n 20 MHz Radio Protocols (TRC-43)

This line is the end of the test record.

Concluding Notes

This report stands as an integrated record of the tests performed and must be copied or distributed in its complete form. The reproduction of selected pages or sections separate from the complete report would require specific approval from the manager of the Garmin Compliance Lab.

This is the final page of the report.