

# Test Report 2023-065

**Version A**

**Issued 3 Nov 2023**

**Project GCL-0458**

**Model Identifier: A04714**

**Primary Test Standard(s)**

**FCC Part 15.225**

**RSS-210 Issue 10 Amd 1**

## **Garmin Compliance Lab**

**Garmin International**

**1200 E 151<sup>st</sup> Street**

**Olathe Kansas 66062 USA**

### **Client-supplied Information**

FCC ID: IPH-04714

IC ID: 1792A-04714



**See section 6 of this report regarding the presence or absence of accreditation logos or marks on this cover page.**

## 1. Summary

The equipment or product described in section 5 of this report was tested at the Garmin Compliance Lab according to standards listed in section 6. This report focuses on the 13.56 MHz Near Field Communication (NFC) Transceiver(s). The results are as follows.

Parameter	Description	Key Performance Values	Result	Data starts at page
Transmitter intentional emissions	Emissions while transmitting must be limited according to a mask that varies across the frequency range 13.110 to 14.010 MHz.[15.225(a) through (c), RSS-210 B.6]	22.6 dB of margin to the intentional emission limit.	PASS	11
Transmitter spurious emissions	Emissions beyond the intended radio band while transmitting must be suppressed a general limit. [FCC 15.225 (d) and RSS 210 B.6]	5.8 dB of margin to the Class B limit.	PASS	14
Conducted Emissions AC Power Port	Radio emissions that this device may generate via its ac power network connections that are not necessary for its operation and that may affect radio communication. [FCC Part 15.205 and RSS-GEN 8.8]	8.01 dB of margin to the appropriate limit.  Tested 150 kHz to 30 MHz applying combined Class B limits.	PASS	18
Frequency stability under extreme Conditions	The ability for the radio to accurately maintain carrier frequency stable with changes in temperature and supply voltage. [FCC 15.225 (e) and RSS 210 B.6]	The Carrier frequency was stable within 0.01% of the target frequency.	PASS with caveat	21
Other Bandwidths	Bandwidth values are presented for 99% Occupied Bandwidth	There are requirements to report these numbers, but they do not have performance limits.	Reported	23

**NT** (Not Tested) means the requirement may or may not be applicable, but the relevant measurement or test was not performed as part of this test project.

**N/A** (Not Applicable) means the lab judged that the test sample is exempt from the requirement.

### Table 1: Summary of results

#### Report Organization

For convenience of the reader, this report is organized as follows:

1. Summary
2. Test Background
3. Report History and Approval
4. Test Sample Modifications and Special Conditions
5. Description of Equipment Tested
6. Test Standards Applied
7. Measurement Instrumentation Uncertainty
8. Selected Examples of Calculations
9. Environmental Conditions During Test
10. Immunity Performance Criteria

Annex: Test records are provided for each type of test, following the order and page numbering stated in the summary table. Concluding notes appear on the final page of this report.

Due to confidentiality, certain material (such as test setup photographs) has been removed from this report and placed in GCL Test Report 2023-067. That report is treated as a part of this document by way of this reference.

## 2. Test Background

The testing reported here was performed at the Garmin Compliance Lab, an organization within Garmin International, located at 1200 E 151<sup>st</sup> St, Olathe Kansas, USA. The contact telephone number is +1.913.397.8200.

The testing was performed on behalf of the Garmin design group, a separate organization located at 1200 E 151<sup>st</sup> St, Olathe Kansas, USA. Witnesses from the business group included: None.

Test Sample received: 01 Sep 2023  
Test Start Date: 18 Sep 2023  
Test End Date: 1 Nov 2023

The data in this test report apply only to the specific samples tested.

Upon receipt all test samples were believed to be properly assembled and ready for testing.

## 3. Report History and Approval

This report was written by Majid Farah and initially issued on 3 Nov 2023 as Version A.

### Report Technical Review:

David Arnett  
Technical Lead EMC Engineer



---

### Report Approval:

Shruti Kohli  
Manager Test and Measurement (EMC, Reliability and Calibration)



---

## 4. Test Sample Modifications and Special Conditions

The following special conditions or usage attributes were judged during test to be necessary to achieve compliance with one or more of the standards listed in section 6 of this report:

None.

The following modifications to the test sample(s) were made, and are judged necessary to achieve compliance with one or more of the standards listed in section 6 of this report:

None.

## 5. Description of the Equipment Tested

### 5.1 Unique Identification

Product Model A04714  
Serial Numbers Tested 3453413644, 3453413671

This product tested is a mobile device for collecting and sharing data with the user and nearby electronic devices.

The client affirmed that the test samples will be representative of production in all relevant aspects.

### 5.2 Key Parameters

EUT Input Power: 5 Vdc  
I/O Ports: USB  
Radio Transceivers: Bluetooth Low Energy, ANT, NFC  
Radio Receivers: GPS L1, Galileo E1, BeiDou, GLONASS  
Primary Functions: Data collection and communication  
Typical use: Portable in multiple orientations  
Highest internal frequency: 2.484 GHz  
Firmware Revision 3.05

### 5.3 Operating modes

During test, the EUT was operated in one or more of the following modes. Some modes may not applicable for this product or in this report.

Mode 1: M1 (Bt Tx). Bluetooth, sometimes called Bluetooth Classic, radio is transmitting consistently on a selected channel sending data using the BR (Basic Rate of 1 Mbps), EDR2 (Extended Data Rate of 2 Mbps) or EDR3 (Extended Data Rate of 3 Mbps) modulation types.

Mode 2: M2 (Bt Ink). Bluetooth Classic radio is paired to a companion device, transmitting and receiving data on various channels in accordance with the protocol, and maintaining the paired relationship.

Mode 3: M3 (Ble Tx). Bluetooth Low Energy radio transmitting consistently on a selected channel at 1 Mbps or 2 Mbps

Mode 4: M4 (Ble Ink). Bluetooth Low Energy radio is paired to a companion device, transmitting and receiving data on various channels in accordance with the protocol, and maintaining the paired relationship.

Mode 5: M5 (ANT Tx). ANT radio transmitting consistently on a selected channel.

Mode 6: M6 (ANT Ink). ANT radio is paired to a companion device, transmitting and receiving data in accordance with the protocol, and maintaining the paired relationship.

Mode 7: M7 (WiFi Tx). The IEEE 802.11 b/g/n radio was transmitting consistently on a selected channel, with a specified modulation type, and data rate.

Mode 8: M8 (WiFi Link). The IEEE 802.11 b/g/n radio is paired to a companion device, transmitting and receiving data on a selected channel in accordance with the protocol, and maintaining the paired relationship.

Mode 9: M9 (Rx 2.4). The radio was set to receive 2.4 GHz signals but not transmit. In this situation, it was specifically looking for Bluetooth Low Energy signals which cover the 2.4 GHz band and represent a worst-case scenario.

Mode 10: M10 (All2.4). This means the radio was tested in modes M1, M3, M5, and M7 if applicable.

Mode 11: M11 (GNSS). The Global Navigation Satellite System receiver is monitoring the GNSS bands, attempting to detect a constellation and determine location. Unless otherwise noted, the EUT was provided simulated GNSS signals representing one of more constellation types. In addition, the EUT may have been reporting signal levels and satellite data to an attached computer to monitor link health.

Mode 12: M12 (NFC Ink). The NFC 13.56 MHz transceiver is in Card Emulation mode, and is actively linked to a companion NFC Reader.

### 5.4 EUT Arrangement

During test, the EUT components and associated support equipment were selected including the following arrangement sets.

Arrangement 1: A1 (Solo). The test sample operates from its battery and no external physical connections. No block diagram is needed for this arrangement.

Arrangement 2: A2 (Upwr). The test sample is attached to a Mains-powered device connected that provides dc power to the sample over a cable but no user data. See the block diagram in Figure 1.

Arrangement 3: A3 (Udata). The test sample is attached to a Mains-powered device connected that provides dc power to the sample and user data over a cable. See the block diagram in Figure 1.

Arrangement 4: A4 (Udc). The test sample is attached to a Mains-powered device connected that provides dc power to the sample and may or may not provide user data. This arrangement is specified in the test plan to provide staff flexibility when the presence or absence of data on the cable is not pertinent. See the block diagram in Figure 1.

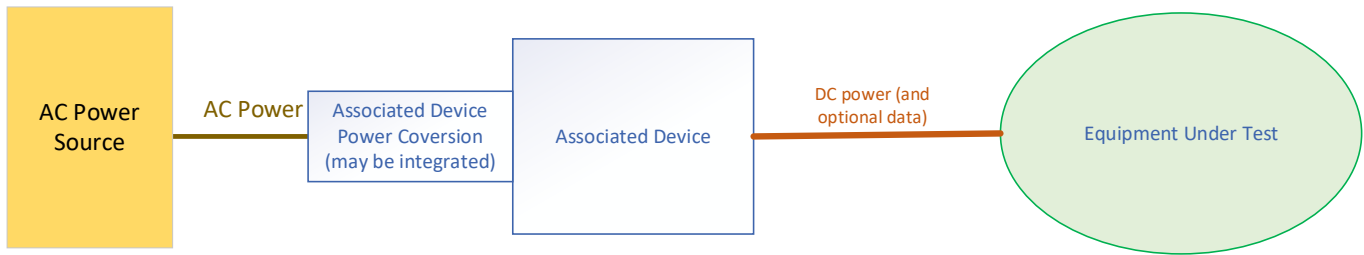

*This interconnect drawing is not to scale.  
It does not indicate the placement of devices.*

**Figure 1: Block diagram of equipment for arrangements A2, A3, A4**

Arrangement 5: A5 (NFCp) The test sample is placed near an NFC Card Reader. The NFC Card Reader is connected to a laptop computer. The test sample is powered by a device that does not include data over the cable, just as with A2. For clarity, test sample is NOT powered by, or connected to, the laptop computer that powers the NFC Card Reader.

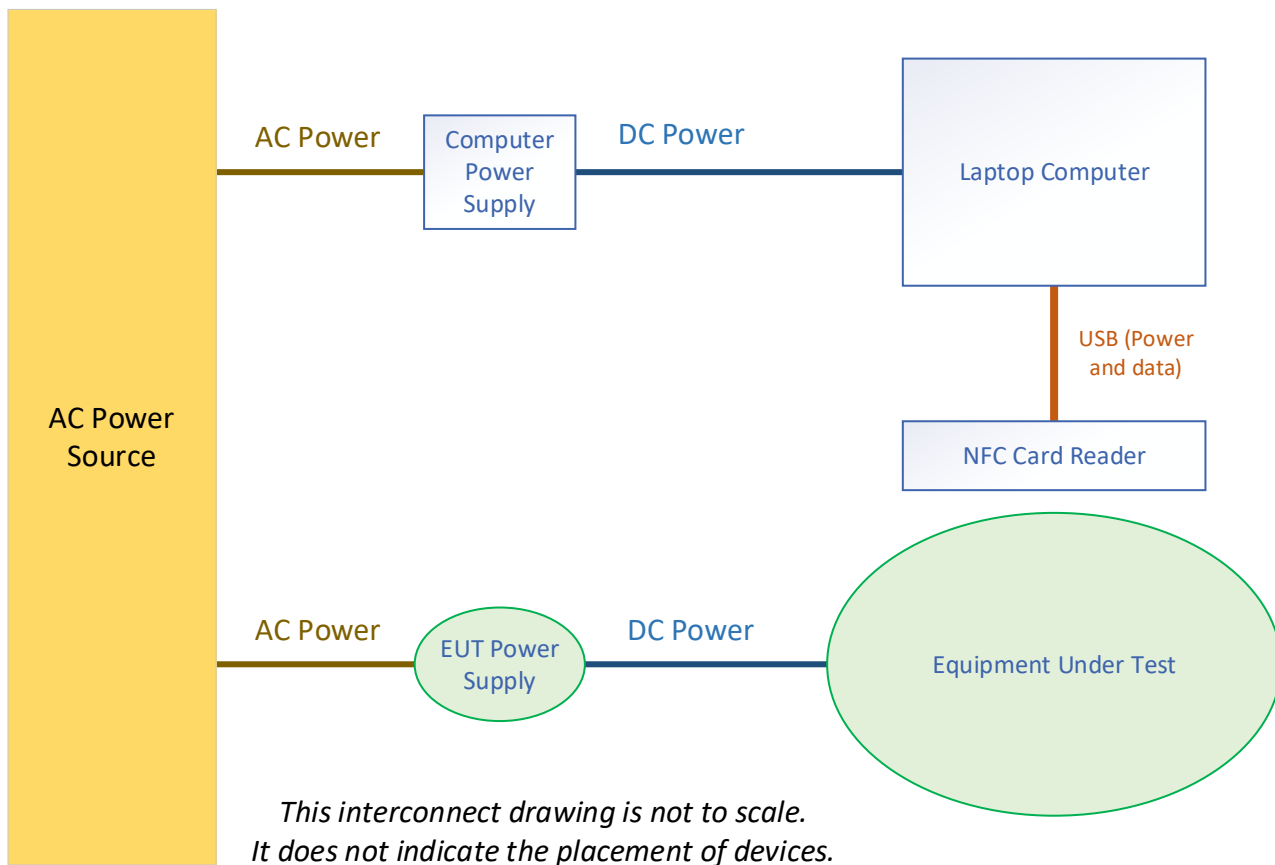

**Figure 2: Block diagram of equipment arrangement A5**

Arrangement 6: A6 (NFCu) The test sample is placed near an NFC Card Reader. The NFC Card Reader is connected to a laptop computer. The test sample is powered by its own batteries rather than an external power source. The test sample is NOT powered by, or connected to, the laptop computer that powers the NFC Card Reader.

### 5.5 Associated Equipment (AE) used

Description	Manufacturer	Model	Serial Number
NFC reader	ACS	ACR1252	RR554-086776
AC/DC Power Converter	Phihong technology	PSAF10R-050Q	None
Laptop Computer	Dell	Latitude 5410	5VSPFB3
Laptop Power Supply	Dell	HA65NM191	None

**Table 2: List of associated equipment that may have been used during test**

### 5.6 Cables used

Description	From	To	Length	EMC Treatment
USB	Power and/or Data source	EUT	54 cm	None

**Table 3: List of cables that may have been used during test**

## 6 Test Standards Applied

### 6.1. Accredited Standards

The following test or measurement standards were applied and are within the scope of the lab's accreditation. All results in this report that cite these standards are presented as Accredited results consistent with ISO/IEC 17025.

- AS/NZS 4268: 2017
- CFR 47, FCC Part 15.225
- ANSI C63.10: 2013 and ANSI C63.10: 2020
- RSS-GEN Issue 5 Amd 2
- RSS-210 Issue 10 Amd 1

### 6.2. Non-accredited Standards

The following test or measurement standards were applied and are either outside the scope of the lab's accreditation, or were performed in such a way that results are not presented as being fully accredited.

None.

### 6.3 Variances

The following variances were applied to standards cited in this section.

Where different test standards cover the same test parameter or phenomenon, and the standards have compatible differences, the stricter of the requirements is typically applied. For example, a consolidated limit may be applied to emission tests selecting the strictest of the limits at each frequency. Likewise, if one standard requires a vertical antenna sweep with boresighting and another does not, swept motion with boresighting will typically be used as it is the more stringent requirement.

### 6.4 Laboratory Accreditation

The Garmin Compliance Lab, an organization within Garmin International, is registered with the US Federal Communication Commission as US1311. The lab is recognized by the Canada Department of Innovation, Science, and Economic Development (ISED) under CAB identifier US0233.

The Garmin Compliance Lab, an organization within Garmin International, is accredited by A2LA, Certificate No. 6162.01. The presence of the A2LA logo on the cover of this report indicates this is an accredited ISO/IEC 17025 test report. If the logo is absent, this report is not issued as an accredited report. Other marks and symbols adjacent to the A2LA logo are accreditation co-operations of which A2LA is a member under a mutual recognition agreement, and to which the Garmin Compliance Lab has been sublicensed.

## 7 Measurement Instrumentation Uncertainty

The lab has analyzed the sources of measurement instrumentation uncertainty. The analysis concludes that the actual measurement values cited in this report are accurate within the  $U_{LAB}$  intervals shown below with approximately 95% statistical confidence. Where the report shows a judgment that a test sample passes a test against a published limit based on these measured values, that judgment has a statistical confidence of 97.5% or greater. Measurement Instrumentation Uncertainty is one component of over-all measurement uncertainty, and other uncertainty components are not considered as part of this analysis.

The primary benchmark for measurement instrumentation uncertainty (MIU) in an electromagnetic compatibility (EMC) test lab is the set of  $U_{CISPR}$  values published in CISPR 16-4-2. In all cases where a  $U_{CISPR}$  value is published by CISPR, the analysis shows that  $U_{LAB}$  – this lab’s estimated MIU – is better than the  $U_{CISPR}$  benchmark.

The secondary benchmark for MIU in an EMC lab performing radio transceiver tests is a set of uncertainty limit values published in various ETSI standards. In this report,  $U_{ETSI}$  is the most restrictive of the values found in the ETSI EN standards listed in section 5 of this report. The analysis principles are described in the ETSI TR documents listed there. In most cases  $U_{LAB}$  is better than the  $U_{ETSI}$  benchmark. Where  $U_{LAB}$  exceeds the  $U_{ETSI}$  benchmark cited here, that entry is preceded by an asterisk. When required by the ETSI EN standards, excess uncertainty will be added to the measurand before comparison to a limit. In an individual test report, staff may re-evaluate that excess uncertainty based on the uncertainty of the method used and the uncertainty limits of the actual ETSI EN standard being applied, and the revised uncertainty values will be shown in the test report.

Some measurement uncertainties analyzed and reported here are not addressed in CISPR 16-4-2 or the ETSI standards, as indicated by the entry ‘None.’

Test Type	$U_{LAB}$	$U_{CISPR}$	$U_{ETSI}$
Conducted DC voltage	0.09% + 2 x LSDPV	None	1%
Conducted AC voltage below 500 Hz	1.0% + 3 x LSDPV	None	2%
Conducted Emissions, Mains Voltage	0.10% + 10 mV	None	None
Conducted Emissions, Mains Current	0.10% + 3 mA	None	None
Conducted Emissions, Mains Power	0.15% + 100 mW	None	None
Conducted Emissions, Power Mains, 9 kHz to 150 kHz	1.49 dB	3.8 dB	None
Conducted Emissions, Power Mains, 150 kHz to 30 MHz	1.40 dB	3.4 dB	None
Conducted Emissions, Cat 6 LCL, 150 kHz to 30 MHz	2.80dB	5 dB	None
Conducted Emissions, Cat 5 LCL, 150 kHz to 30 MHz	3.21 dB	5 dB	None
Conducted Emissions, Cat 3 LCL, 150 kHz to 30 MHz	4.24 dB	5 dB	None
Radiated Emissions, below 30 MHz	0.88 dB	None	6 dB
Radiated Emissions, 30 MHz to 1000 MHz	2.77 dB	6.3 dB	6 dB
Radiated Emissions, 1 GHz to 18 GHz	2.60 dB	5.2 & 5.5 dB	6 dB
Radiated Emissions, 18 GHz to 26.5 GHz	2.73 dB	None	6 dB
*Radio Signal Frequency Accuracy	$*1.55 \times 10^{-7}$	None	$1.0 \times 10^{-7}$
Radio Signal Occupied Bandwidth	0.95%	None	5%
Radio Power or Power Spectral Density	0.98 dB	None	1 dB
Temperature	0.38 °C	None	1 °C
Barometric Pressure	0.38 kPa	None	None
Relative Humidity	2.85% RH	None	±5% RH
Signal Timing	The greater of these three... 0.63 usec 0.01% of value 0.5 x LSDPV	None	None

**Note:** LSDPV stands for the Least Significant Digit Place Value reported. In the value 1470 msec, the least significant digit is the 7. It has a 10 msec place value. The LSDPV is thus 10 msec and the maximum error due to roundoff would be 5 msec. If the time value were reported as 1470 msec, the underscore indicates that the 0 is a significant figure and the error due to roundoff would be 0.5 msec. All digits provided to the right of a decimal point radix are significant.



## 8 Selected Example Calculations

Certain regulators require samples of the calculations that lead from the raw measurement to the final result for AC Mains conducted and unintended radiated emissions. The assumption is that the lab performs raw measurements, then adds, subtracts, multiplies, or divides based on transducer factors, amplifier gains, and losses in the signal transmission path. In this lab, our CISPR 16 Receiver does not work that way. The calibration factors and losses and gains are provided to the receiver as detailed data files. These factors are applied in the RF measurement path prior to the detector. But as a step in the lab measurement process, staff frequently verify that these factors are applied correctly. They make a measurement with the factors applied inside the receiver, then they disable the factors and remeasure the result manually adding in the various relevant factors.

The transmission loss is measured including the combined losses and gains of preamplifiers, cables, and any band-selective filters. In many cases above 1 GHz it is a negative value, indicating that the preamplifier gain is greater than these other losses.

Here are examples of these calculations. The data in these examples was not taken as part of this project:

### 8.1 AC Mains conducted emissions at 22 MHz

(Raw measurement) + (AMN factor) + (transmission loss) = Result

$$(7.145 \text{ dBuV}) + (9.812 \text{ dB}) + (0.216 \text{ dB}) = 17.173 \text{ dBuV}$$

### 8.2 Radiated Emissions at 630 MHz

(Raw measurement) + (Antenna factor) + (transmission loss) = Result

$$(2.25 \text{ dBuV}) + (27.80 \text{ dB/m}) + (2.89 \text{ dB}) = 32.94 \text{ dBuV/m}$$

### 8.3 Radiated Emissions at 2.7 GHz

(Raw measurement) + (Antenna factor) + (transmission loss) = Result

$$(43.72 \text{ dBuV}) + (32.22 \text{ dB/m}) + (-36.09 \text{ dB}) = 39.85 \text{ dBuV/m}$$

## 9 Environmental Conditions During Test

Environmental conditions in the test lab were monitored during the test period. Temperature and humidity are controlled by an air handling system. As information to the reader, the conditions were observed at the values or within the ranges noted below. For any tests where environmental conditions are critical to test results and require further constraints or details, the test records in the annex may provide more specific information.

Temperature:	20.5 to 23.6 °C
Relative Humidity:	34.3% to 55.7% (non-condensing)
Barometric Pressure	96.3 to 99.2 kPa

Description	Make	Model #	Serial #	Last Cal/Ver	Next Due
Barometer	Traceable	6453	221702700	3-Aug-2022	1-Aug-2024

Table 4: Environmental monitoring device

## 10 Immunity Performance Criteria

If this report includes immunity tests then results have been categorized as Performance Criteria A, B, C, or D. The standards that the lab applied will define the details for A, B, and C, as well as which criterion is required for each type of test. They will also define the electrical stresses that were applied during each test. In a very general sense the observed criteria noted in this report are as follows:

Criterion A. The stress applied did not alter product operation. This criterion is generally used for ‘continuous’ stresses that can be present for a long time in the places the product will be used, or that can appear often, even though they may come and go over time.

Criterion B. The stress applied altered product operation, but the product self-recovered so that the user would not have to try to figure out how to restore it to full operation. This criterion is generally used for 'transient' stresses that appear briefly and occasionally, but are usually not present in the places the product will be used.

Criterion C. The stress applied altered product operation, but the user could restore it to full operation, for example by power cycling the product. This criterion is generally used for 'transient' stresses that appear briefly and only rarely in the places the product will be used.

Criterion D. This is not an official criterion in the standards, because it would be a failure of the requirements. This indication in a test record means the product was affected in a way that the user might not be able to correct. The effect could include some degree of hardware damage, or it could include loss of program files or data files necessary for operation.

Repeatability is an issue in all EMC immunity work. When the product operation changes unexpectedly during a test, and the change would fail the requirements of the standard, this is an anomaly. The test operator needs to determine whether the anomaly was a result of the applied electrical stress. The investigation is done by repeating the section of the test where the anomaly occurred three times. If the same or a similar anomaly occurs in any of the three repeat trials, it is confirmed as a response to the stress. If not, the anomaly is judged unreproducible and is not considered when judging the A, B, or C observed performance. Since there is usually no ability to confirm a Criterion D anomaly, these are usually treated as Criterion D upon a single occurrence.

Tests that require Criterion B performance will be judged to Pass if criteria A or B is observed. Similarly, tests that require Criterion C performance will be judged to Pass if criteria A, B, or C is observed.

## **ANNEX**

The remainder of this report is an Annex containing individual test data records. These records are the basis for the judgments summarized in section 1 of this report. The Annex ends with a set of concluding notes regarding use of the report.

**Test Record**  
**Radiated Emission Test RE12**  
**Project GCL0485**

Test Date(s) 17 Oct 2023  
 Test Personnel Dave Kerr

Product Model A04714  
 Serial Number tested 3453413644

Operating Mode M12 (NFC Ink)  
 Arrangement A6 (NFCu)  
 Input Power 5 Vdc

Test Standards: FCC Part 15, ANSI C63.10, RSS-210, RSS-GEN (as noted in Section 6 of the report).

Frequency Range: 10 MHz to 30 MHz  
**Pass/Fail Judgment: PASS**

**Test record created by:** Jim Solum  
**Date of this record:** 24 Oct 2023

Original record, Version A.

**Test Equipment Used**

Description	Make	Model #	Serial #	Last Cal/Ver	Next Due
PXE Receiver 26 GHz	Keysight	N9048B	MY59290135	27-Sep-2023	1-Oct-2024
Loop antenna, amplified	Schwarzbeck	FMZB 1519B	00174	12-Jun-2023	15-Jun-2024
SAC 3m, below 1 GHz	Frankonia	SAC3	F199004	7-Nov-2022	7-Nov-2025
Tape measure, 1" x 33'	Lufkin	PHV1410CMEN	10720	16-Jan-2023	15-Jan-2026

**Table RE12.1: Test Equipment Used**

**Software Used**

PXE Firmware version A.32.06  
 RE 150k to 30M Signal Maximization Tool V1 2021Mar17.xlsx  
 RE 150k to 30M XYZ\_orientations\_TemplateV6.xlsm  
 RE NFC 150k to 30M Data Analysis Template V21 2023Jun19.xlsx

**Test Data**

The radiated emission test process began with a preliminary scan at multiple turntable angles, and three antenna polarizations typically described as X, Y, and Z. Subsequent testing was done using the antenna polarization(s) producing the highest result relative to the test limit. Where the test standard requires cable manipulation, this was done at one of more likely worst case frequencies selected by the test personnel while observing the receiver display. At each of the frequencies selected for final measurements, the turntable angle, and antenna polarization were explored to find the worst-case settings. Final field strength measurements were taken in that set of positions. Full maximization was not performed at frequencies that are noise floor measurements included per the test standard requirements.

At azimuth angle 0° the 'front' reference mark of the turntable is pointed Southward. At 90° the reference mark points West. At -90° it points East. The designation of the X, Y, and Z antenna polarizations are reported by use of photographs.

The table shows the selected final measurement data between 10MHz and 30 MHz. It includes at least the six strongest emissions observed relative to the test limit, along with other data points of interest. Where a data point is highlighted in yellow, this is an aid to indicate the data point(s) with the least margin to the test limit. The dbuA/m limits and measured dbuA/m values in the chart below are obtained from the dBuV/m limits and measured dBuV/m measured values. The two values differ by 51.52 dB based on the 377 Ohm characteristic impedance of free space. A positive margin value indicates that the emission was below the test limit. The test limits are for FCC Part 15 & RSS-210.

Frequency (MHz)	Limit (dBuV/m)	Limit (dBuA/m)	Measured (dBuV/m)	Measured (dBuA/m)	Margin (dB)	Azimuth (degree)	Height (mm)	Antenna Orientation
12.288	49.5	-2.0	24.1	-27.4	25.4	-3	1000	X
12.711	49.5	-2.0	26.9	-24.6	22.6	-9	1000	X
13.137	60.5	9.0	27.7	-23.8	32.8	8	1000	X
13.348	60.5	9.0	37.5	-14.0	23.0	-1	1000	X
13.560	104.0	52.5	66.0	14.5	38.0	-2	1000	X
13.985	60.5	9.0	27.6	-23.9	32.9	-3	1000	X
14.408	49.5	-2.0	26.5	-25.0	23.0	5	1000	X
14.831	49.5	-2.0	23.5	-28.0	26.0	8	1000	X

Table RE12.2: Emission summary (FCC / Canada)

The graph below shows the background spectrum observed during pre-scan, as well as the final data points from the tables above.

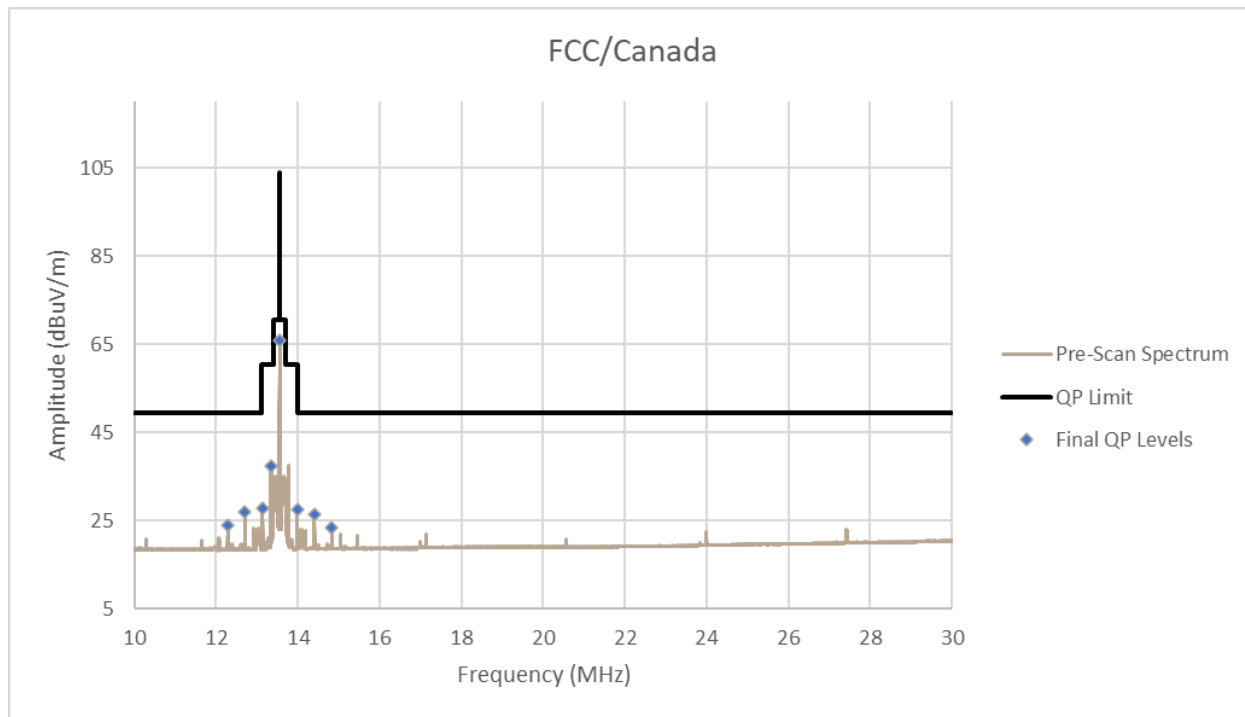

Figure RE12.1: Spectral data (FCC/Canada)

## Setup Photographs

The following photographs show the EUT configured and arranged in the manner in which it was measured.



**Figure RE12.2: EUT test setup, front view (Antenna X Orientation)**



**Figure RE12.3: EUT test setup, reverse view (Antenna X Orientation)**

This line is the end of the test record.

**Test Record**  
**Radiated Emission Test RE13**  
**Project GCL0458**

Test Date(s) 19 Oct 2023  
 Test Personnel David Kerr

Product Model A04714  
 Serial Number tested 3453413644

Operating Mode M12 (NFC Ink)  
 Arrangement A6 (NFCu)  
 Input Power 5 Vdc (USB)

Test Standards: FCC Part 15, ANSI C63.10 (as noted in Section 6 of the report).

Frequency Range: 30 MHz to 150 MHz  
**Pass/Fail Judgment: PASS**

**Test record created by: David A Kerr**  
**Date of this record: 19 Oct 2023**  
 Original record, Version A.

**Test Equipment**

Description	Make	Model #	Serial #	Last Cal/Ver	Next Due
PXE Receiver 26 GHz	Keysight	N9048B	MY59290135	27-Sep-2023	1-Oct-2024
Antenna, Biconilog, 30M-6 GHz	ETS Lindgren	3142E	00233201	19-Jul-2022	15-Jul-2024
SAC 3m, below 1 GHz	Frankonia	SAC3	F199004	7-Nov-2022	7-Nov-2025
Tape measure, 1" x 33'	Lufkin	PHV1410CMEN	10720	16-Jan-2023	15-Jan-2026

**RE13.1: Test Equipment Used**

**Software Used:**  
 N9048B Keysight PXE firmware version A.32.06  
 EPX/RE automation software ver. 2023.01.001

**Test Data**

The radiated emission test process began with a preliminary scan at multiple turntable angles, antenna heights, and both antenna polarizations. For test standards that require reorienting the test sample, further preliminary scans were taken in those alternate orientations typically described as X, Y and Z. Subsequent testing was done using on the orientation(s) producing the highest result relative to the test limit. Where the test standard requires cable manipulation, this was done at one of more likely worst case frequencies selected by the test personnel while observing the receiver display. At each of the frequencies selected for final measurements, the turntable angle, antenna height, and antenna polarization were explored to find the worst-case settings. Final field strength measurements were taken in that set of positions. Full maximization was not performed at frequencies that are noise floor measurements included per the test standard requirements.

At azimuth angle 180° the 'front' reference mark of the turntable is pointed Southward. At 270° the reference mark points West. At 90° it points East. At 173° the turntable reference mark is pointed directly at the antenna. The designation of the X, Y, and Z orientations of the test sample are sample dependent, so these are reported by use of photographs.

The table shows the selected final measurement data between 30 MHz and 150 MHz. It includes at least the six strongest emissions observed relative to the test limit, along with other data points of interest. Where a data point is highlighted in yellow, this is an aid to indicate the data point(s) with the least margin to the test limit. A positive margin value indicates that the emission was below the test limit. The test limit is the FCC Class B Limit at 3m.

Frequency	Pol.	Reading	Factor	Level	Limit	Margin	Height	Angle
MHz		dB(μV)	dB(1/m)	dB(μV/m)	dB(μV/m)	dB	cm	deg
		QP		QP	QP	QP		
149.160	H	17.4	17.4	34.8	43.5	8.7	229.0	47.0
96.000	H	6.5	15.8	22.3	43.5	21.2	312.8	0.0
120.000	H	13.9	15.7	29.6	43.5	13.9	286.4	12.0
51.210	V	20.2	14.0	34.2	40.0	5.8	100.0	153.0
55.290	V	18.7	14.0	32.7	40.0	7.3	100.0	155.0
59.400	V	15.0	14.1	29.1	40.0	10.9	221.4	150.0
37.710	V	13.1	18.5	31.6	40.0	8.4	100.0	114.0
85.710	V	8.5	14.4	22.9	40.0	17.1	112.2	70.0
30.870	V	8.2	22.3	30.5	40.0	9.5	100.0	19.0

**Table RE13.2: Emission summary**

The graph below shows the background spectrum observed during pre-scan, as well as the final data points from the table above.

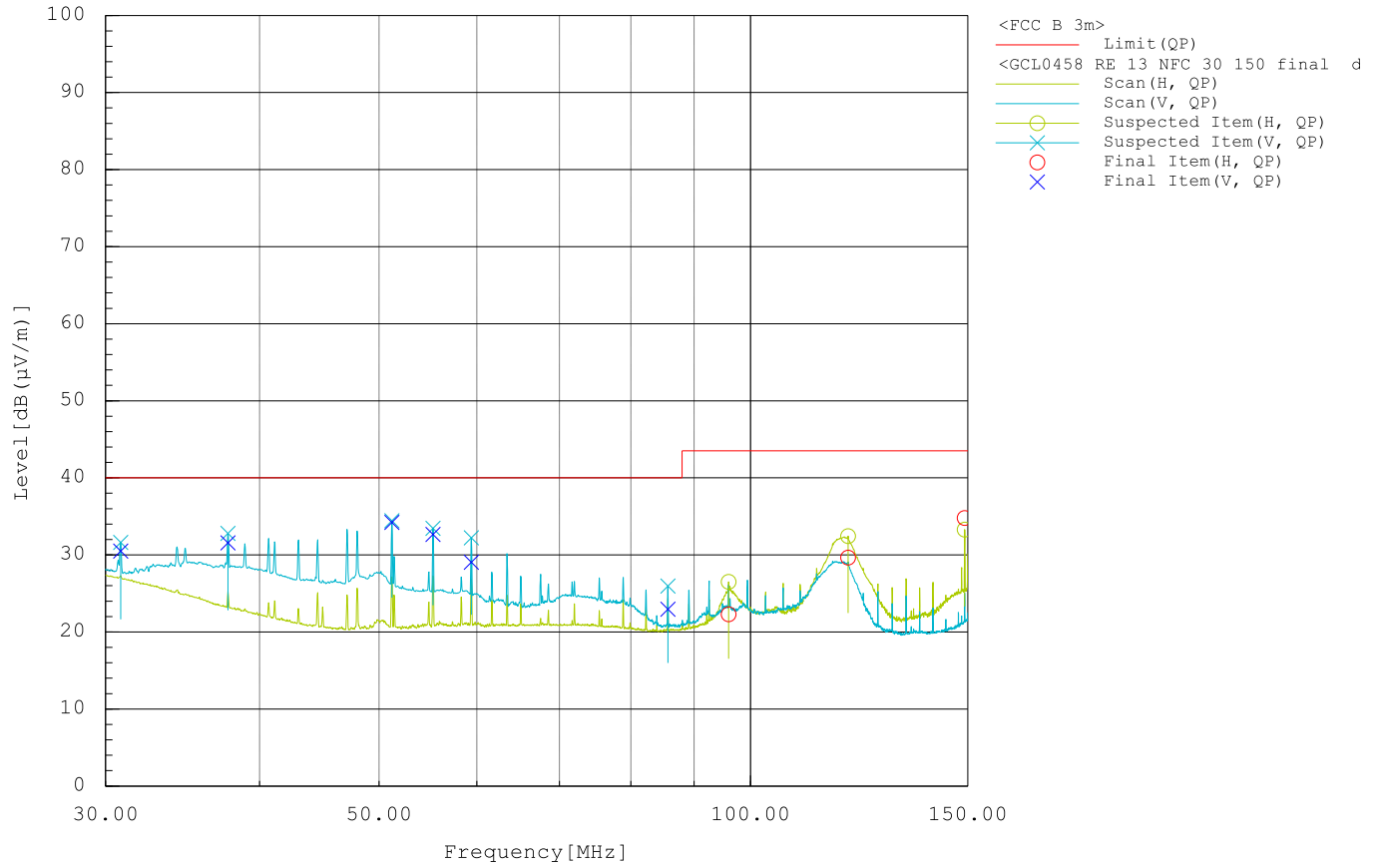
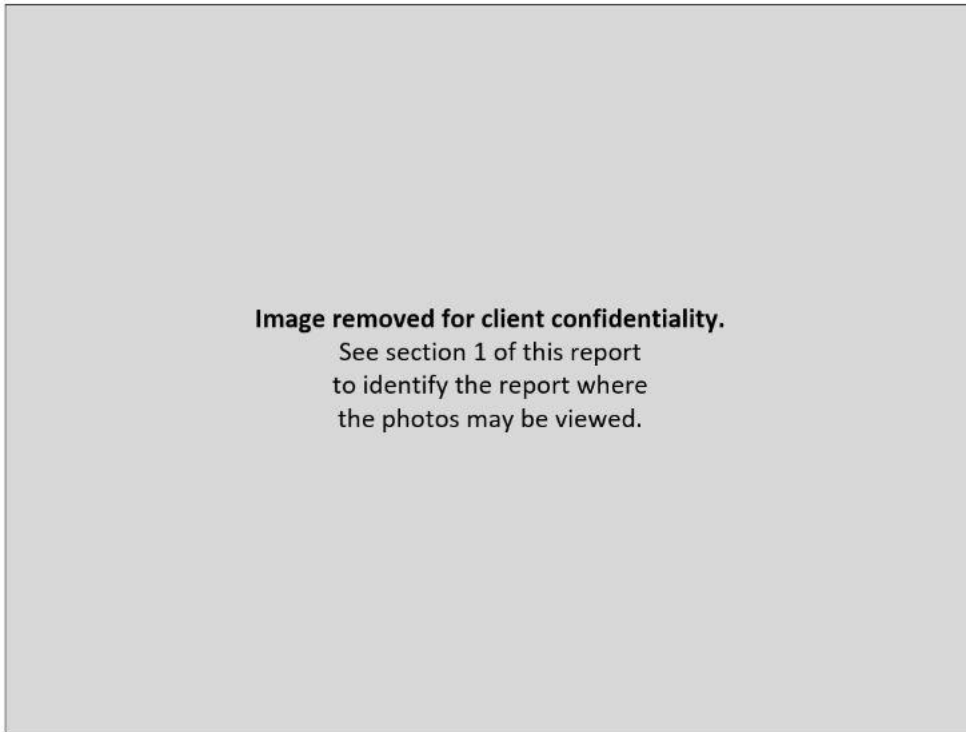

Figure RE13.1: Spectral data



### Setup Photographs

The following photographs show the EUT configured and arranged in the manner in which it was measured.



**Figure RE13.2: EUT test setup, front view (X orientation)**



**Figure RE13.3: EUT test setup, reverse view (X orientation)**

This line is the end of the test record.

**Test Record**  
**Conducted Emissions Mains Test CE02**  
**Project GCL0458**

Test Date(s) 06 Oct 2023  
 Test Personnel David Kerr

Product Model A04714  
 Serial Number tested 3453413644

Operating Mode M12 (NFC Ink)  
 Arrangement A5 (NFCp)  
 Input Power 115 V/ 60 Hz

Test Standards: FCC Part 15 (as noted in Section 6 of the report).

Frequency Range: 150 kHz to 30 MHz  
**Pass/Fail Judgment: PASS**

**Test record created by: Aditya Prakash**  
**Date of this record: 10 Oct 2023**  
 Original record, Version A.

Description	Make	Model #	Serial #	Last Cal/Ver	Next Due
PXE Receiver 44GHz	Keysight	N9048B	MY62220139	30-Jan-23	1-Feb-24
Tape measure, 1" x 33'	Lufkin	PHV1410CMEN	10721	30-Aug-23	1-Sep-26
DMM Multimeter	FLUKE	79 III	71740743	5-Apr-23	1-Apr-24
LISN multiline; 20A 50uH	Com-Power	LIN-120C	20160005	10-Feb-23	15-Feb-24

**Table CE02.1: Test Equipment Used**

**Software Used**

Keysight PXE software A.33.03; CE Mains 150k to 30M Data Analysis V2 2021Jun10.xlsx

**Test Data**

The conducted emission test process began with a set of preliminary scans on both power conductors using both Quasi-Peak and Average detectors across the frequency range. Where the test standard requires cable manipulation, one or more likely worst case frequencies selected by the test personnel. Cables were manipulated to find the maximal signal strength while observing the receiver levels at those selected frequencies. At each of the frequencies selected for final measurements, Quasi-peak and Average detector readings were taken on each conductor.

The table shows the selected final measurement data. It includes at least the six strongest emissions observed relative to the limit lines, along with other data points of interest. The yellow highlight indicate the data points with the least margin to the quasi-peak detector limit and the average detector limit. A positive margin value indicates that the emission was below the test limit. The test limit is the FCC Class B.

Frequency (kHz)	QP Limit (dBuV)	AV Limit (dBuV)	L1 QP (dBuV)	L2 QP (dBuV)	L1 AV (dBuV)	L2 AV (dBuV)	QP Margin (dB)	AV Margin (dB)
661	56	46	30.74	27.29	26.35	21.8	25.26	19.65
695	56	46	34.9	30.77	28.8	23.78	21.1	17.2
726	56	46	29.46	27.13	24.83	21.75	26.54	21.17
3428	56	46	37.96	35.88	35.03	32.9	18.04	10.97
10286	60	50	40.33	39.74	37.07	34.27	19.67	12.93
13560	60	50	44.75	37.27	41.99	33.52	15.25	8.01

**Table CE02.2: Emission summary**

The graph below shows preliminary scan data as continuous curves. Superimposed are the final measurement data points reported in the table above.

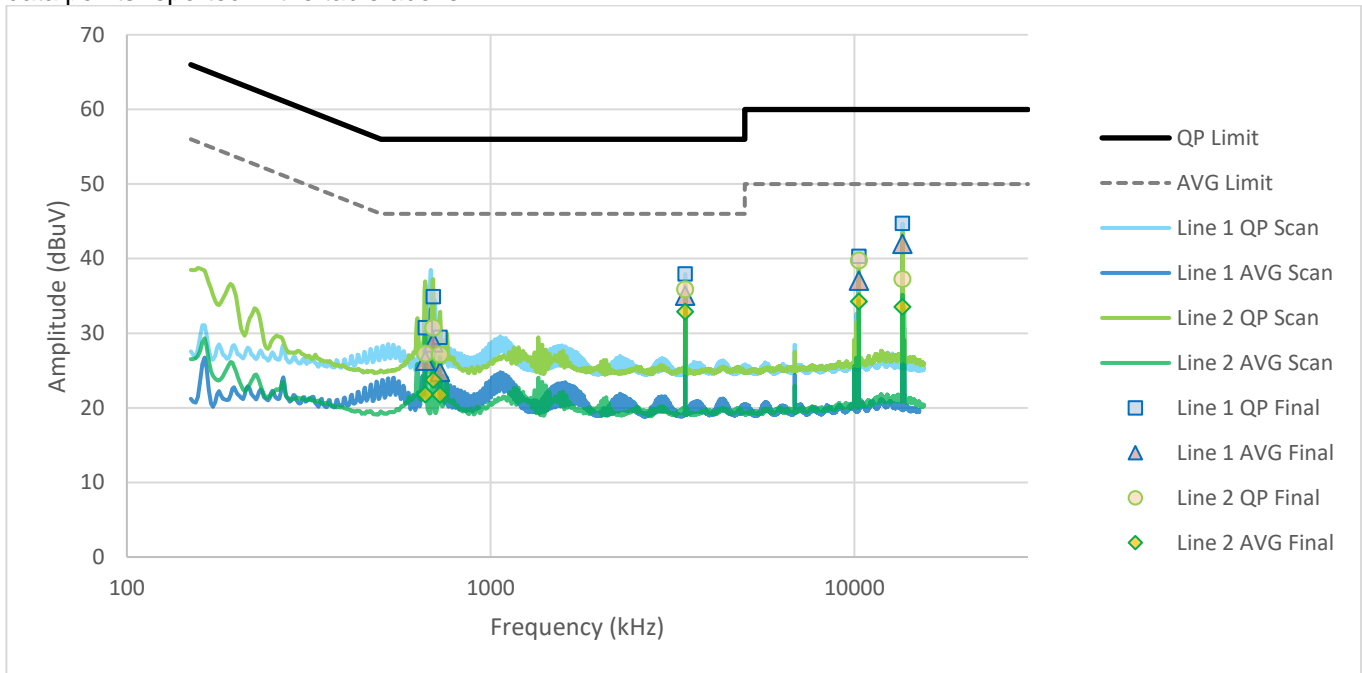

**Figure CE02.1: Spectral data**

### Setup Photographs

The following photographs show the EUT configured and arranged in the manner in which it was measured.

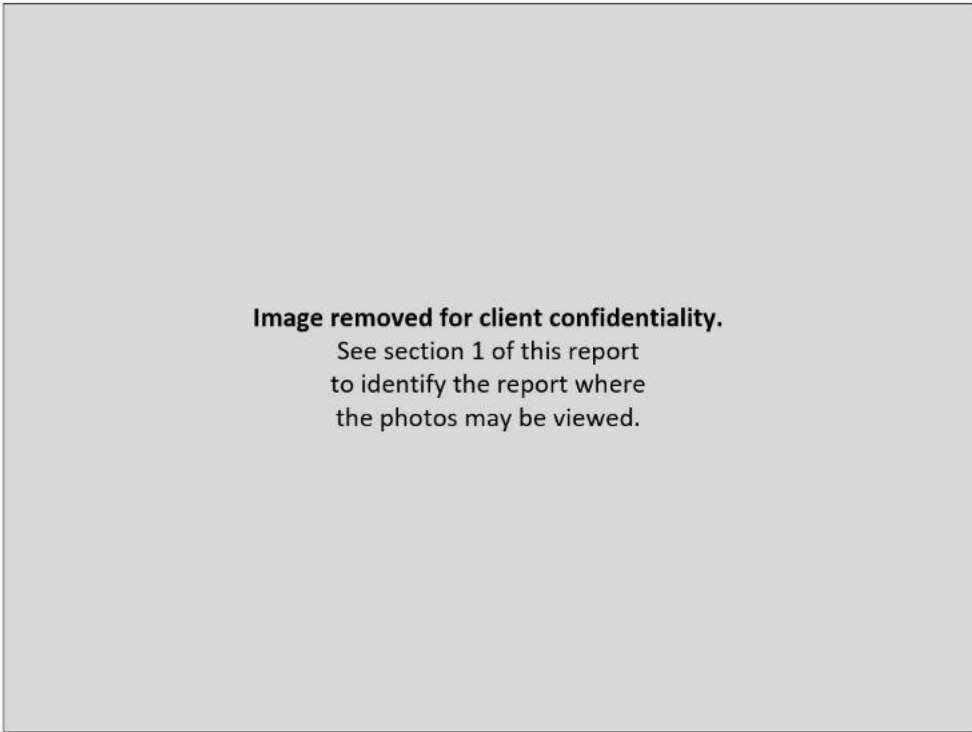

**Figure CE02.2: Test setup, front view**

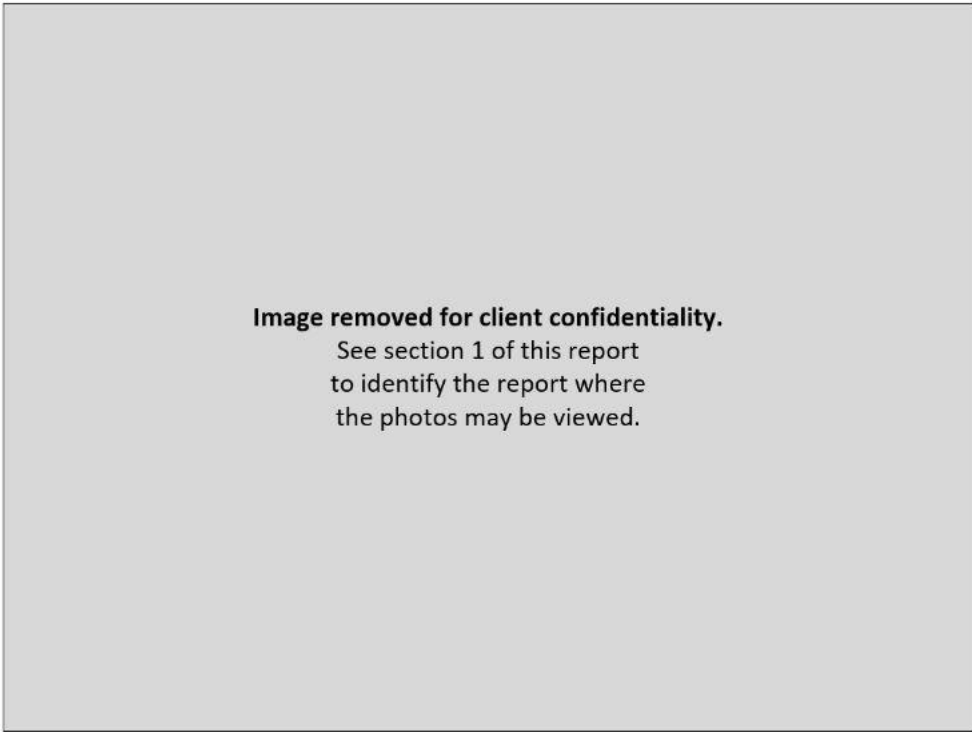

**Figure CE02.3: Test setup, side view**

**This line is the end of the test record.**

**Test Record**  
**Transmitter Stability in Extreme Conditions**  
**Test IDs TR16**  
**Project GCL-0458**

Test Date(s) 15 Oct 2023  
 Test Personnel Majid Farah

Product Model A04714  
 Serial Number tested 3453413671

Operating Mode M12 (NFCInk)  
 Arrangement A3 (Udata)  
 Nominal Input Power 5 Vdc

Test Standards: FCC part 15, RSS-GEN, RSS-210, ANSI C63.10 (as noted in Section 6 of the report)

Radio Protocol NFC

**Pass/Fail Judgment: PASS with caveat**

**Test record created by: Majid Farah**  
**Date this record: 18 Oct 2023**  
 Original record, Version A.

**Test Equipment**

Description	Make	Model #	Serial #	Last Cal/Ver	Next Due
PXE Receiver 44GHz	Keysight	N9048B	MY62220139	30-Jan-2023	1-Feb-2024
Thermometer	Thermco	ACCD370P	220608121	26-Aug-2022	1-Sep-2024
Barometer	Traceable	6453	221702700	3-Aug-2022	1-Aug-2024
DMM Multimeter	FLUKE	79 III	71740743	5-Apr-2023	1-Apr-2024
Programmable DC power source	Keithley	2260B-30-72 720 W	1411917	21-Apr-2023	15-Apr-2024
Thermal Chamber	Tenney	T2RC	31244	Calibration	Not Required
Near Field Probe Set	Com-Power	PS-400	151544	Calibration	Not Required

**Table TR16.1: Equipment used**

Software Used: PXE Software Revision A.33.03, FrequencyStabilityAnalysisSystemplateV1.xlsx

**Test Method**

The standards cited require observation of the stability for transmission frequency and/or power at certain environmental extremes. The reference is performance on nominal input voltage and a temperature of 20 °C. Where the standards cited here impose different limits or conditions, the most stringent limits and conditions have been applied.

The Standard indicated carrier frequency stability shall not exceed 0.01% of operation frequency. The frequency was required to remain between the limits of 13.558644 and 13.561356 MHz. The modes utilized include those that showed emissions closest to the band edge during prior bandwidth testing.

**Caveat**

The NFC transceiver under test only operates when in the close vicinity of an NFC Reader. In this test, the client provided the ACR1252 manufactured by Advanced Card Systems as described in section 5.5 of the test report.

Emissions presented here show the combined signals from the NFC reader and the device under test. Signals for each were not distinguishable during the test. Per the client, the device under test matches its transmitting frequency to correspond to that of the reader device. The data presented here, and the conclusions drawn, apply to the device under test and the NFC Reader when tested together as a system.

**Test Data**

The test sample(s) were subjected to extreme conditions and performed as shown below. During NFC test mode, each measurement was made conducted from a near field probe located at a close distance to the sample and NFC reader. The sample needs to be attached to an NFC reader for continuous transmission.

Yellow highlights indicate the maximum and minimum measured carrier frequency. The maximum frequency measured was 13,559,939 Hz and the minimum was 13,559,783 Hz. The margin to high side of limit is 1414 Hz and margin for low side of the limit is 1156 Hz.

Tx Mode	Temp °C	Volts Vdc	NFC carrier frequency (Hz)			
			Time interval (minutes)			
			0	2	5	10
NFC	50	5	13,559,800	13,559,801	13,559,801	13,559,801
NFC	40	5	13,559,813	13,559,813	13,559,813	13,559,814
NFC	30	5	13,559,847	13,559,843	13,559,842	13,559,841
NFC	20	5	13,559,873	13,559,874	13,559,875	13,559,876
NFC	20	4.25	13,559,876	N/A	N/A	N/A
NFC	20	5.75	13,559,876	N/A	N/A	N/A
NFC	10	5	13,559,912	13,559,911	13,559,911	13,559,911
NFC	0	5	13,559,928	13,559,929	13,559,931	13,559,933
NFC	-10	5	13,559,942	13,559,942	13,559,942	13,559,942
NFC	-20	5	13,559,934	13,559,931	13,559,931	13,559,929

**Table TR16.2: Carrier frequency measurement for NFC transmission during temperature and voltage variations**

**Setup Block Diagram**

The following block diagrams show the EUT configured and arranged in the manner which it was measured.

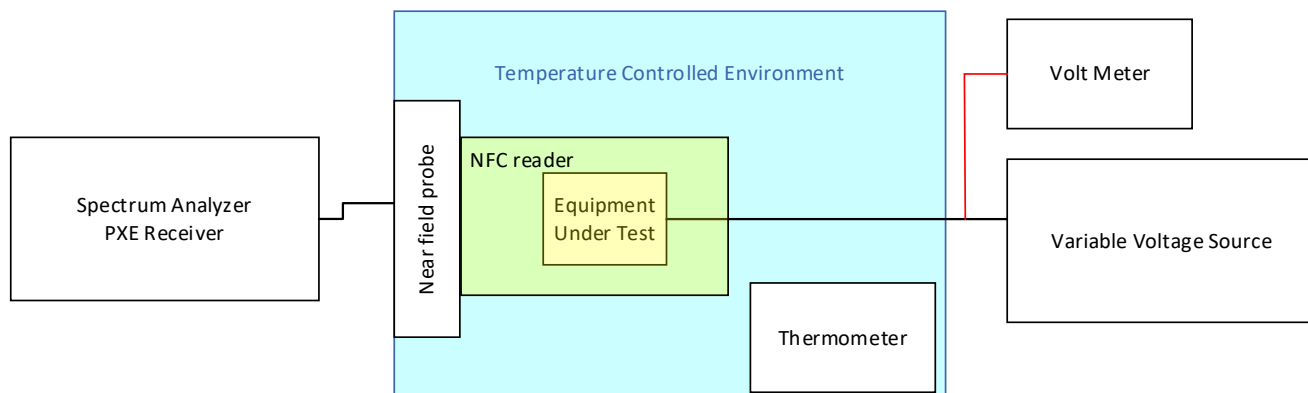

**Figure TR16.1: Schematic drawing of the test equipment setup for NFC**

This line is the end of the test record.

**Test Record**  
**Transmitter Bandwidth Tests**  
**Test IDs TR17**  
**Project GCL-0458**

Test Date(s) 1 Nov 2023  
 Test Personnel Majid Farah

Product Model A04714  
 Serial Number tested 3453413671

Test Standards: ANSI C63.10, RSS-GEN (as noted in Section 6 of the report).

Radio Protocol NFC  
 Radio Band 13.56 MHz

**Pass/Fail Judgment: Reported**

**Test record created by: Majid Farah**  
**Date of this record: 1 Nov 2023**

Original record, Version A.

**Test Equipment Used**

Description	Make	Model #	Serial #	Last Cal/Ver	Next Due
PXE Receiver 44GHz	Keysight	N9048B	MY62220139	30-Jan-2023	1-Feb-2024
Near Field Probe Set	Com-Power	PS-400	151544	Calibration	Not Required

**Table TR17.1: Equipment Used**

**Test Software used:** Keysight PXE System Code rev. A.33.03.

**Background**

There are regulatory requirements to present an additional type of bandwidth analysis: 99% Occupied Bandwidth. There are no limits or functional requirements around these data, beyond a reporting requirement. The contents of this test record are for information, and do not affect compliance of the devices that are the subject of this report.

**Test Setup**

This block diagram shows the test equipment setup.

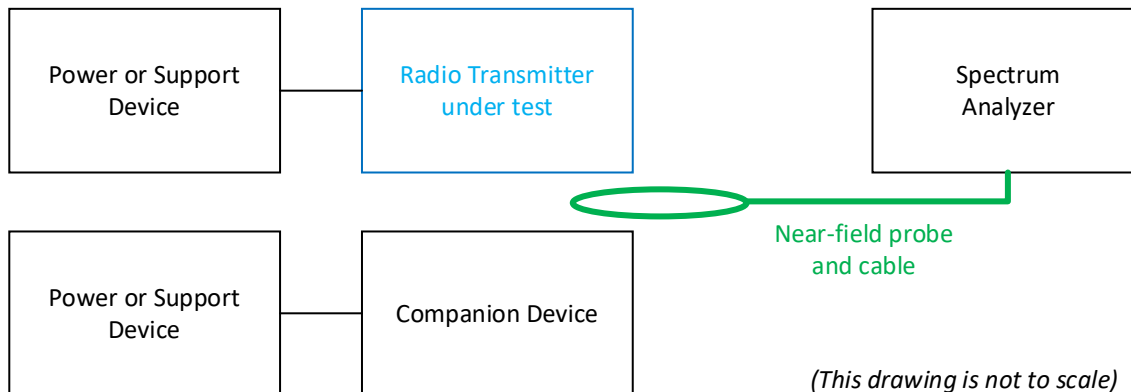

**Figure TR17.1: Test setup**

## Caveat

The NFC transceiver under test only operates when in the close vicinity of an NFC Reader. In this test, the client provided the ACR1252 manufactured by Advanced Card Systems as described in section 5.5 of the test report.

Emissions presented here show the combined signals from the NFC reader and the device under test. Signals for each were not distinguishable during the test. Per the client, the device under test matches its transmitting frequency to correspond to that of the reader device. The data presented here, and the conclusions drawn, apply to the device under test and the NFC Reader when tested together as a system.

## Occupied Bandwidth, 99% Test Method

During this test a small loop probe is placed between transmitter and the companion device because the test sample only transmits in response to a nearby NFC reader. This loop probe is then connected by cables to the spectrum analyzer. The analyzer has a built-in capability to identify the minimum bandwidth that contains a specified percentage of the total power observed. The spectrum is scanned hundreds of times so that the varied effects of modulation are appropriately assessed. Since the focus is on the relative distribution of energy across a range of frequencies, the absolute amplitudes recorded during this test are not relevant and may not include cable losses or attenuation factors.

## Occupied Bandwidth, 99% Test Data

The data for each type of data transmission (A and B) is summarized below, followed by the spectral data for both types. The analysis threshold for this test was the bandwidth containing 99% of the observed power using the ANSI C63.10 method.

	Bandwidth
NFC Mode	MHz
Type A	2.1264
Type B	1.6427

**Table TR17.2: Summary of 99% Occupied Bandwidth Data for 13.56 MHz NFC modes**



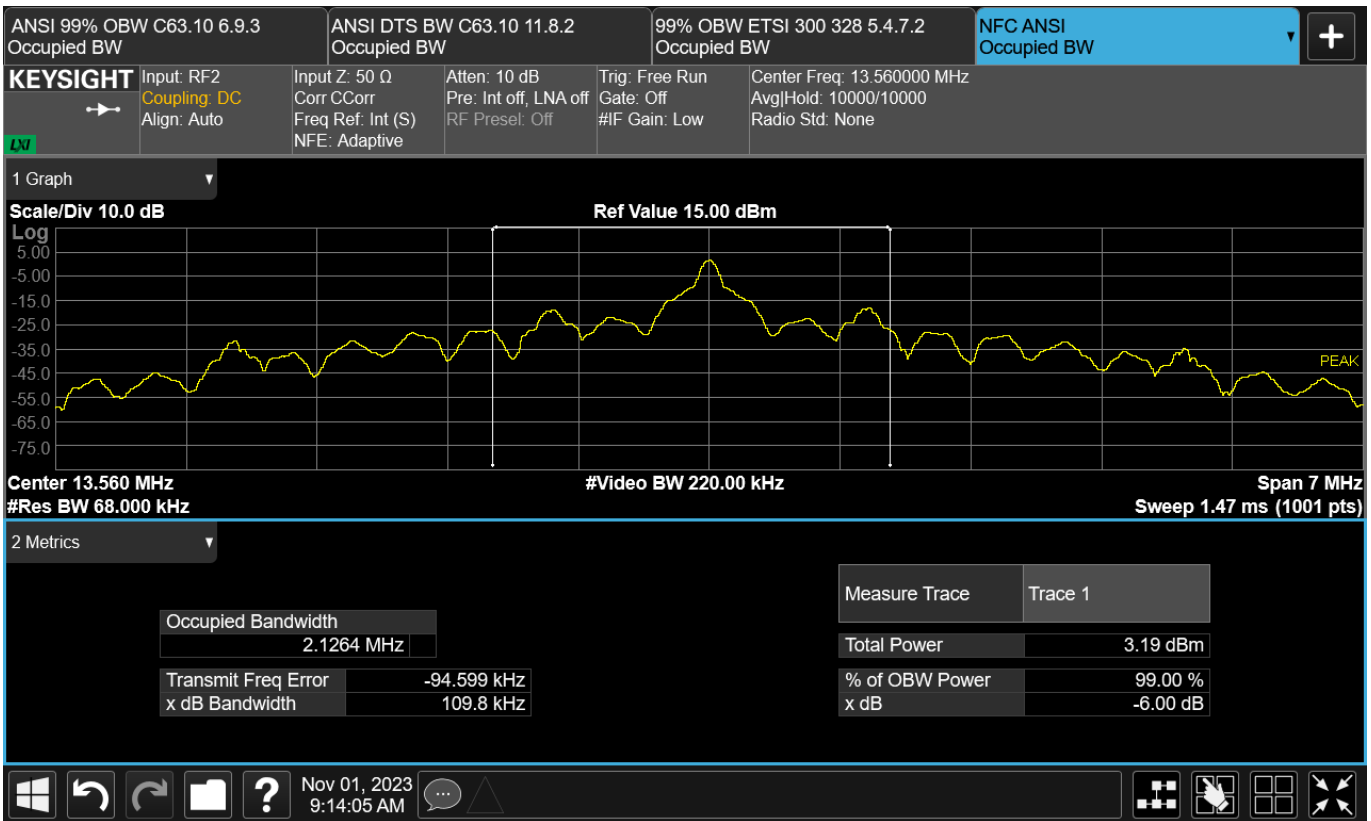

Figure TR17.2: Occupied bandwidth data for Type A transmissions

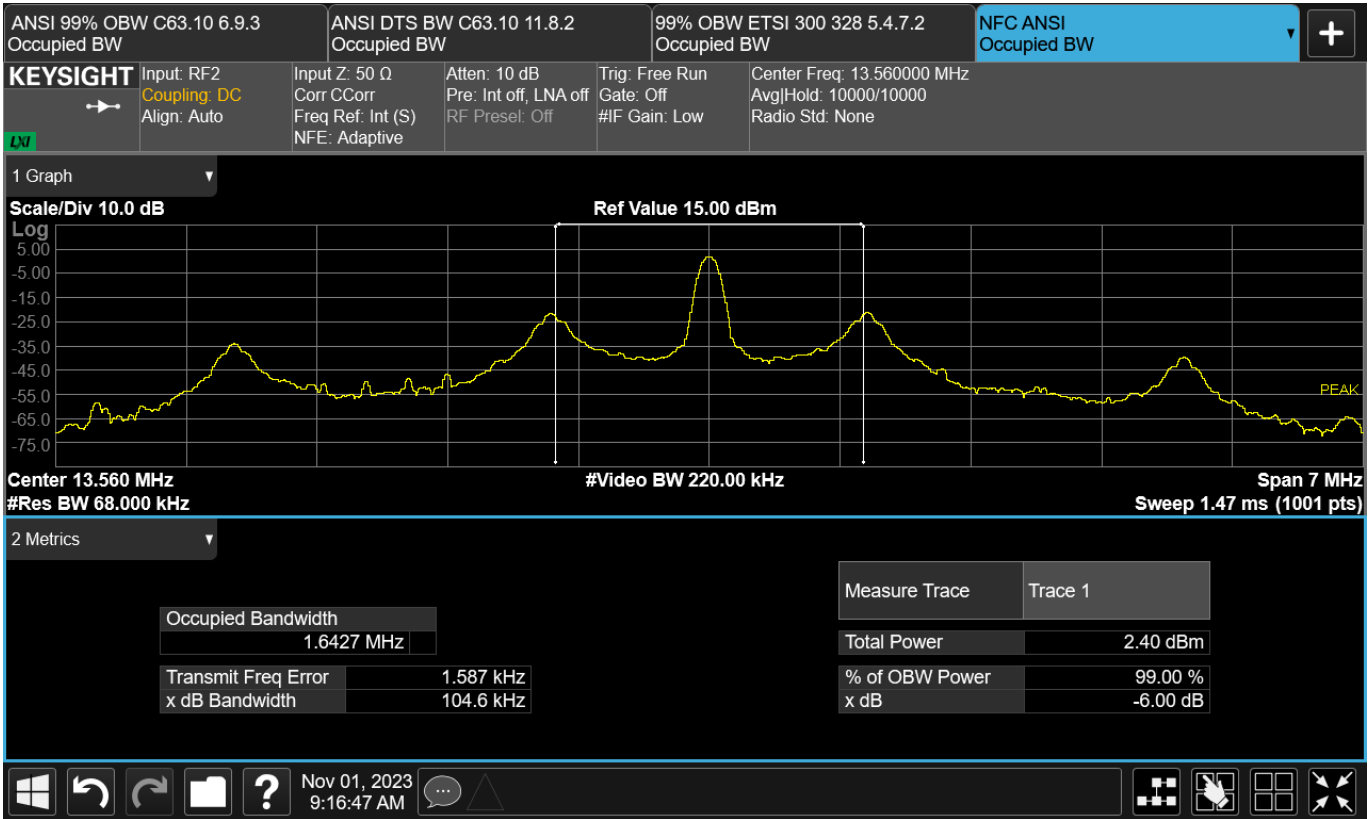

Figure TR17.3: Occupied bandwidth data for Type B transmissions

This line is the end of the test record.

**Concluding Notes**

This report stands as an integrated record of the tests performed and must be copied or distributed in its complete form. The reproduction of selected pages or sections separate from the complete report would require specific approval from the manager of the Garmin Compliance Lab.

**This is the final page of the report.**