

ROGERS LABS, INC.

4405 West 259th Terrace
Louisburg, KS 66053
Phone / Fax (913) 837-3214

Application For Grant of Certification 47CFR Paragraph 15.247 FHSS and Industry Canada RSS-GEN Issue 5 and RSS-247 Issue 2

Model: A04622

2402-2480 MHz (DSSS)
Frequency Hopping Spread Spectrum
License Exempt Intentional Radiator

FCC ID: IPH-04622

IC: 1792A-04622

Garmin International, Inc.

1200 East 151st Street
Olathe, KS 66062

FCC Designation: US5305
ISED Registration: 3041A

Test Report Number: 220304

Test Date: June 14, 2022

Authorized Signatory: *Scot D. Rogers*
Scot D. Rogers

This report shall not be reproduced except in full, without the written approval of the laboratory. This report must not be used by the client to claim product certification, approval, or endorsement by NVLAP, NIST, or any agency of the U.S. Government.

Rogers Labs, Inc.
4405 West 259th Terrace
Louisburg, KS 66053
Phone/Fax: (913) 837-3214
Revision 1

Garmin International, Inc.
Model: A04622
Test: 220304
Test to: 47CFR 15C, RSS-Gen RSS-247
File: A04622 DSS TstRpt 220304

SN's: 3403386859 / 3403386735
FCC ID: IPH-04622
IC: 1792A-04622
Date: June 21, 2022
Page 1 of 50

Table of Contents

TABLE OF CONTENTS	2
REVISIONS	4
EXECUTIVE SUMMARY	5
OPINION / INTERPRETATION OF RESULTS	5
EQUIPMENT TESTED	8
Equipment Operational Modes	9
Equipment Function	10
Equipment Configuration	11
APPLICATION FOR CERTIFICATION	12
APPLICABLE STANDARDS	13
EQUIPMENT TESTING PROCEDURES	13
AC Line Conducted Emission Test Procedure	13
Radiated Emission Test Procedure	13
Antenna Port Conducted Emission Test Procedure	14
Diagram 1 Test arrangement for Conducted emissions	15
Diagram 2 Test arrangement for radiated emissions of tabletop equipment.....	16
Diagram 3 Test arrangement for radiated emissions tested on Open Area Test Site (OATS)	17
Diagram 4 Test arrangement for Antenna Port Conducted emissions	17
TEST SITE LOCATIONS	18
UNITS OF MEASUREMENTS	18
ENVIRONMENTAL CONDITIONS	19
STATEMENT OF MODIFICATIONS AND DEVIATIONS	19
INTENTIONAL RADIATORS	19

Antenna Requirements19

Restricted Bands of Operation.....19

Table 1 Radiated Emissions in Restricted Frequency Bands Data Mode 1 BT BR.....20

Summary of Results for Radiated Emissions in Restricted Bands20

AC Line Conducted EMI Procedure21

Figure 1 AC Line Conducted emissions of EUT line 1 (EUT – AC Adapter)22

Figure 2 AC Line Conducted emissions of EUT line 2 (EUT – AC Adapter)23

Figure 3 AC Line Conducted emissions of EUT line 1 (EUT – Computer).....24

Figure 4 AC Line Conducted emissions of EUT line 2 (EUT – Computer).....25

Table 2 AC Line Conducted Emissions Data L1 (EUT – AC Adapter)26

Table 3 AC Line Conducted Emissions Data L2 (EUT – AC Adapter)26

Table 4 AC Line Conducted Emissions Data L1 (EUT – Computer).....27

Table 5 AC Line Conducted Emissions Data L2 (EUT – Computer).....27

AC Line Conducted Emissions Results28

General Radiated Emissions Procedure.....28

Table 6 General Radiated Emissions Data29

Summary of Results for General Radiated Emissions29

Operation in the Band 2400 – 2483.5 MHz30

Figure 5 Plot of Transmitter Emissions Operation in 2402-2480 MHz Mode 1 BT BR31

Figure 6 Plot of Transmitter Emissions 20-dB Occupied Bandwidth Mode 1 BT BR32

Figure 7 Plot of Transmitter Emissions 99% Occupied Bandwidth Mode 1 BT BR.....33

Figure 8 Plot of Number of Hopping Channels Mode 1 BT BR34

Figure 9 Plot of Number of Hopping Channels Mode 1 BT BR35

Figure 10 Plot of Number of Hopping Channels Mode 1 BT BR36

Figure 11 Plot of Number of Hopping Channels Mode 1 BT BR37

Figure 12 Plot of Channel Separation Mode 1 BT BR38

Figure 13 Plot of Dwell time On Channel Mode 1 BT BR.....39

Figure 14 Plot of Number of Times on Channel over 10 Second Period Mode 1 BT BR.....40

Figure 15 Plot of Transmitter Emissions Low Band Edge Mode 1 BT BR.....41

Figure 16 Plot of Transmitter Emissions High Band Edge Mode 1 BT BR42

Transmitter Emissions Data.....43



NVLAP Lab Code 200087-0

Table 7 Transmitter Radiated Emissions Mode 1 BT BR43

Table 8 Transmitter Antenna Port Conducted Data Mode 1 BT BR44

Summary of Results for Transmitter Radiated Emissions of Intentional Radiator44

ANNEX..... 45

Annex A Measurement Uncertainty Calculations.....46

Annex B Test Equipment.....47

Annex C Rogers Qualifications49

Annex D Laboratory Certificate of Accreditation.....50

Revisions

Revision 1 Isued June 21, 2022

Rogers Labs, Inc.
 4405 West 259th Terrace
 Louisburg, KS 66053
 Phone/Fax: (913) 837-3214
 Revision 1

Garmin International, Inc.
 Model: A04622
 Test: 220304
 Test to: 47CFR 15C, RSS-Gen RSS-247
 File: A04622 DSS TstRpt 220304

SN's: 3403386859 / 3403386735
 FCC ID: IPH-04622
 IC: 1792A-04622
 Date: June 21, 2022
 Page 4 of 50

Executive Summary

License Exempt Digital Transmission System Intentional Radiator operating under Title 47 of the Code of Federal Regulations (47CFR) Paragraph 15.247 and Industry Canada RSS-247 Issue 2 and RSS-GEN Issue 5, Frequency Hopping Spread Spectrum (FHSS) or Direct Sequence Spread Spectrum (DSS) transmitter operations in the 2400-2483.5 MHz frequency band.

Name of Applicant: Garmin International, Inc.
1200 East 151st Street
Olathe, KS 66062

M/N: A04622

FCC ID: IPH-04622 IC: 1792A-04622

Operating Frequency Range: 2402-2480 MHz

Operation Direct Sequence Spread Spectrum (DSS) communication mode 1

Mode	Antenna Port Conducted Power Watts	99% OBW (kHz)	20-dB OBW (kHz)
Mode 1, BT BR (GFSK)	0.010	935.3	2,445.0

This report addresses EUT Operations as Direct Sequence Spread Spectrum transmitter in mode 1. Note, the production device utilizes integral antenna system with 0 dBi Gain.

Opinion / Interpretation of Results

Tests Performed	Margin (dB)	Results
Restricted Bands 47CFR 15.205, RSS-210 4.1	-6.5	Complies
Emissions as per 47CFR 15.207, RSS-GEN 8.8	-6.5	Complies
Radiated Emissions 47CFR 15.209, RSS-GEN 8.9	-2.1	Complies
Harmonic Emissions per 47CFR 15.247, RSS-210 B.10	-2.4	Complies

Tests performed include

47CFR

§15.247 Operation within the bands 902-928 MHz, 2400-2483.5 MHz, and 5725-5850 MHz.

(a) Operation under the provisions of this Section is limited to frequency hopping and digitally modulated intentional radiators that comply with the following provisions:

(1) Frequency hopping systems shall have hopping channel carrier frequencies separated by a minimum of 25 kHz or the 20-dB bandwidth of the hopping channel, whichever is greater. Alternatively, frequency hopping systems operating in the 2400-2483.5 MHz band may have hopping channel carrier frequencies that are separated by 25 kHz or two-thirds of the 20-dB bandwidth of the hopping channel, whichever is greater, provided the systems operate with an output power no greater than 125 mW. The system shall hop to channel frequencies that are selected at the system hopping rate from a pseudo randomly ordered list of hopping frequencies. Each frequency must be used equally on the average by each transmitter. The system receivers shall have input bandwidths that match the hopping channel bandwidths of their corresponding transmitters and shall shift frequencies in synchronization with the transmitted signals.

(iii) Frequency hopping systems in the 2400-2483.5 MHz band shall use at least 15 channels. The average time of occupancy on any channel shall not be greater than 0.4 seconds within a period of 0.4 seconds multiplied by the number of hopping channels employed. Frequency hopping systems may avoid or suppress transmissions on a particular hopping frequency provided that a minimum of 15 channels are used.

(b) The maximum peak conducted output power of the intentional radiator shall not exceed the following:

(1) For frequency hopping systems operating in the 2400-2483.5 MHz band employing at least 75 non-overlapping hopping channels, and all frequency hopping systems in the 5725-5850 MHz band: 1 watt. For all other frequency hopping systems in the 2400-2483.5 MHz band: 0.125 watts.

(c) Operation with directional antenna gains greater than 6 dBi.

(d) In any 100 kHz bandwidth outside the frequency band in which the spread spectrum or digitally modulated intentional radiator is operating, the radio frequency power that is produced by the intentional radiator shall be at least 20 dB below that in the 100 kHz bandwidth within the band that contains the highest level of the desired power, based on either an RF conducted or a radiated measurement, provided the transmitter demonstrates compliance with the peak conducted power limits. If the transmitter complies with the conducted power limits based on the use of RMS averaging over a time interval, as permitted under paragraph (b)(3) of this section, the attenuation required under this paragraph shall be 30 dB instead of 20 dB. Attenuation below the general limits specified in §15.209(a) is not required. In addition, radiated emissions which fall in the restricted bands, as defined in §15.205(a), must also comply with the radiated emission limits specified in §15.209(a) (see §15.205(c)).

RSS-247 Issue 2

5.1 Frequency hopping systems (FHS)

FHSs employ a spread spectrum technology in which the carrier is modulated with coded information in a conventional manner, causing a conventional spreading of the radio frequency (RF) energy around the carrier frequency. The carrier frequency is not fixed, but changes at fixed intervals under the direction of a coded sequence.

FHSs are not required to employ all available hopping frequencies during each transmission. However, the system, consisting of both the transmitter and the receiver, must be designed to comply with all of the requirements in this section in case the transmitter is presented with a continuous data (or information) stream. In addition, a system employing short transmission bursts must comply with the definition of frequency hopping equipment and must distribute its transmissions over the minimum number of hopping channels specified in this section.

Incorporation of intelligence into an FHS that enables it to recognize other users of the band and to avoid occupied frequencies is permitted provided that the FHS does it individually and independently chooses or adapts its hopset. The coordination of FHSs in any other manner for the express purpose of avoiding the simultaneous occupancy of individual hopping frequencies by multiple transmitters is not permitted.

The following applies to FHSs in each of the three bands:

a) The bandwidth of a frequency hopping channel is the 20 dB emission bandwidth, measured with the hopping stopped. The system's radio frequency (RF) bandwidth is equal to the channel bandwidth multiplied by the number of channels in the hopset. The system shall hop to channel frequencies that are selected at the system hopping rate from a pseudo randomly ordered list of hopping frequencies. The system receivers shall have input bandwidths that match the hopping channel bandwidths of their corresponding transmitters and shall shift frequencies in synchronization with the transmitted signals.

b) FHSs shall have hopping channel carrier frequencies separated by a minimum of 25 kHz or the 20 dB bandwidth of the hopping channel, whichever is greater. Alternatively, FHSs operating in the band 2400-2483.5 MHz may have hopping channel carrier frequencies that are separated by 25 kHz or two thirds of the 20 dB bandwidth of the hopping channel, whichever is greater, provided that the systems operate with an output power no greater than 0.125 W.

c) For FHSs in the band 902-928 MHz: if the 20 dB bandwidth of the hopping channel is less than 250 kHz, the system shall use at least 50 hopping channels and the average time of occupancy on any channel shall not be greater than 0.4 seconds within a 20-second period. If the 20 dB bandwidth of the hopping channel is 250 kHz or greater, the system shall use at least 25 hopping channels and the average time of occupancy on any channel shall not be greater than 0.4 seconds within a 10-second period. The maximum 20 dB bandwidth of the hopping channel shall be 500 kHz.

d) FHSs operating in the band 2400-2483.5 MHz shall use at least 15 hopping channels. The average time of occupancy on any channel shall not be greater than 0.4 seconds within a period of 0.4 seconds, multiplied by the number of hopping channels employed. Transmissions on particular hopping frequencies may be avoided or suppressed provided that at least 15 hopping channels are used.

e) FHSs operating in the band 5725-5850 MHz shall use at least 75 hopping channels. The maximum 20 dB bandwidth of the hopping channel shall be 1 MHz. The average time of occupancy on any frequency shall not be greater than 0.4 seconds within a 30-second period.

Equipment Tested

Model: A04622

Garmin International, Inc.
1200 East 151st Street
Olathe, KS 66062

<u>Equipment</u>	<u>Model / PN</u>	<u>Serial Number</u>
EUT	A04622	3403386859
EUT2	A04622	3403386735
USB cable (0.5-meter)	320-00541-0x	N/A
USB cable (1.7-meter)	320-01461-x0	N/A
USB cable (1.7-meter)	320-01462-x0	N/A
AC Adapter	320-00096-xx	N/A
CLA DC/DC Adapter (single)	013-00970-00	N/A
CLA DC/DC Adapter (Dual)	013-00791-00	N/A
USB-C to USB-mini (pass through)	320-01487-00	N/A
GTM-60	320-00683-00	N/A
GTM-70	320-00683-20	N/A
BC-30	320-00922-xx	N/A
BC-20 (Camera)	A3EVNX01	N/A
DC Power Supply	BK 1745	209C13
Laptop Computer	Latitude 7480	EFSPSN2
USB Printer	Dell 0N5819	5D1SL61

Test results in this report relate only to the items tested. Worst-case configuration data recorded in this report.

Software: 3.22, Antennas: 2.4 GHz PIFA (0 dBi), 5 GHz PIFA (0 dBi)

Equipment Operational Modes

Mode	Transmitter Operation
1	BT BR (GFSK)
2	BT 2EDR ($\pi/4$ -DQPSK)
3	BT 3EDR (8DPSK)
4	BT BLE (GMSK)
5	802.11b
6	802.11g
7	802.11n
8	U-NII-1 802.11a
9	U-NII-1 802.11n
10	U-NII-1 802.11n40
11	U-NII-1 802.11ac80
12	U-NII-3 802.11a
13	U-NII-3 802.11n
14	U-NII-3 802.11n40
15	U-NII-3 802.11ac80

Equipment Function

The EUT is a GPS receiver, graphical display, and user interface unit providing GPS reception, graphical display of location, navigation, and other information for the user. The design offers use as a hand-held, transportation mounted or portable configuration for use in navigational applications. The design incorporates transmitter circuitry operating in the 2402-2480, 5150-5250, and 5725-5850 MHz frequency bands. The typical use configuration has the EUT mounted in a transportation vehicle and powered from the direct current vehicle power through an interface cable. The design provides a Micro SD Card slot and USB-C interface port as presented below and wireless communications with compatible equipment. The EUT operates from direct current power provided from external power or internal rechargeable battery. External power may be supplied through the installation vehicles 12-volt power through Cigarette Lighter Adapter (CLA) and cable, AC/DC power adapter, or compliant USB interface as documented this report. The EUT was arranged as described by the manufacturer emulating typical user configurations for testing purposes. The EUT offers no other interface connections than those presented in the configuration options as described by the manufacturer and presented below. For testing purposes, the EUT received power from both internal and external power options and configurations. During testing, the test system was configured to operate in a manufacturer defined mode. The manufacturer provided test software for testing transmitter and equipment function. The software provided ability to operate the transmitter at 100% duty cycle for testing purposes. The testing mode of operation exceeds typical duty cycle operation of production equipment. As requested by the manufacturer the equipment was tested for emissions compliance using the available configurations with the worse-case data presented. Test results in this report relate only to the products described in this report.

Equipment Configuration

- 1) Unit operating off internal battery



- 2) Unit connected to (and powered by) AC adapter (320-00096-xx) through USB cable (GPN: 320-01545-00)



- 3) Unit connected to Computer USB port through cable assembly (GPN: GPN: 320-01545-00)



- 4) Unit connected to CLA (013-00970-00) through cable assembly (GPN: GPN: 320-01461-x0, 320-01462-x0)

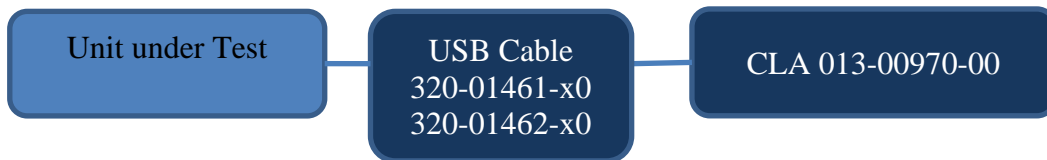

- 5) Unit connected to CLA (013-00791-00) through cable assembly (GPN: GPN: 320-01461-x0, 320-01462-x0)

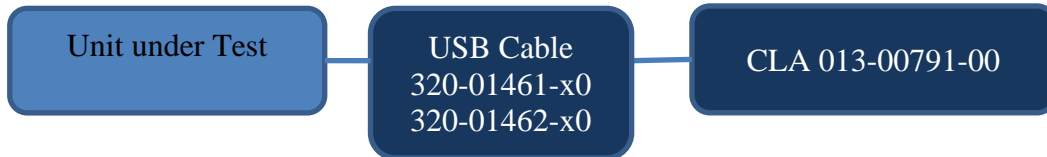

- 6) Unit connected to DC Power through Pass-Thru cable (320-01487-00) and (GTM-70; 320-00683-20, GTM-60; 320-00683-00)



- 7) Unit connected to DC Power through Pass-Thru cable (320-01487-00) and (BC-30)

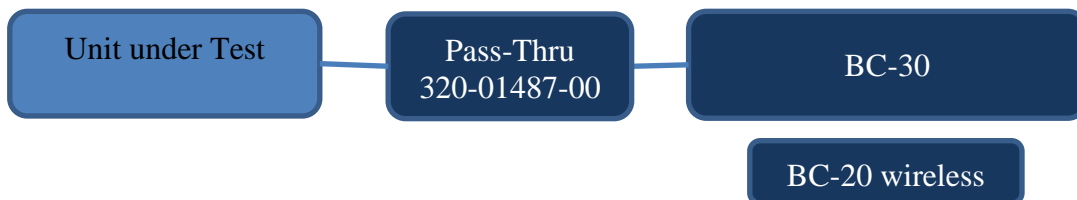

Application for Certification

- (1) Manufacturer: Garmin International, Inc.
1200 East 151st Street
Olathe, KS 66062
- (2) Identification: M/N: A04622
FCC ID: IPH-04622 IC: 1792A-04622
- (3) Instruction Book:
Refer to Exhibit for Instruction Manual.
- (4) Description of Circuit Functions:
Refer to Exhibit of Operational Description.
- (5) Block Diagram with Frequencies:
Refer to Exhibit of Operational Description.
- (6) Report of Measurements:
Report of measurements follows in this Report.
- (7) Photographs: Construction, Component Placement, etc.:
Refer to Exhibit for photographs of equipment.
- (8) List of Peripheral Equipment Necessary for operation. The equipment operates from internal battery power or external direct current power provided from authorized sources. The EUT provides USB-C interface port for power and communications as presented in this filing.
- (9) Transition Provisions of 47CFR 15.37 are not requested.
- (10) Not Applicable. The unit is not a scanning receiver.
- (11) Not Applicable. The EUT does not operate in the 59 – 64 GHz frequency band.
- (12) The equipment is not software defined and this section is not applicable.
- (13) Applications for certification of U-NII devices in the 5.15-5.35 GHz and the 5.47-5.85 GHz bands must include a high-level operational description of the security procedures that control the radio frequency operating parameters and ensure that unauthorized modifications cannot be made. This requirement is not applicable to his DTS device.
- (14) Contain at least one drawing or photograph showing the test set-up for each of the required types of tests applicable to the device for which certification is requested. These drawings or photographs must show enough detail to confirm other information contained in the test report. Any photographs used must be focused originals without glare or dark spots and must clearly show the test configuration used. This information is provided in this report and Test Setup Exhibits provided with the application filing.

Applicable Standards

The following information is submitted in accordance with the eCFR (electronic Title 47 Code of Federal Regulations) (47CFR), dated June 14, 2022: Part 2, Subpart J, Part 15C Paragraph 15.247, RSS-247 Issue 2, and RSS-GEN Issue 5. Test procedures used are the established Methods of Measurement of Radio-Noise Emissions as described in ANSI C63.10-2013. This report documents compliance for the EUT operations as Low Power Transmitter.

Equipment Testing Procedures

AC Line Conducted Emission Test Procedure

Testing for the AC line-conducted emissions were performed as required in 47CFR 15C, RSS-210 Issue 10, RSS-GEN and specified in ANSI C63.10-2013. The test setup, including the EUT, was arranged in the test configurations as presented during testing. The test configuration was placed on a 1 x 1.5-meter bench, 0.8 meters high located in a screen room. The power lines of the system were isolated from the power source using a standard LISN with a 50- μ Hy choke. EMI was coupled to the spectrum analyzer through a 0.1 μ F capacitor internal to the LISN. The LISN was positioned on the floor beneath the wooden bench supporting the EUT. The power lines and cables were draped over the back edge of the table. Refer to diagram one showing typical test arrangement and photographs in the test setup exhibit for EUT placement used during testing.

Radiated Emission Test Procedure

Radiated emissions testing was performed as required in 47CFR 15C, RSS-247 Issue 2, RSS-GEN and specified in ANSI C63.10-2013. The EUT was placed on a rotating 0.9 x 1.2-meter platform, elevated as required above the ground plane at a distance of 3 meters from the FSM antenna. EMI energy was maximized by equipment placement permitting orientation in three orthogonal axes, raising, and lowering the FSM antenna, changing the antenna polarization, and by rotating the turntable. Each emission was maximized before data was taken and recorded. The frequency spectrum from 9 kHz to 25,000 MHz was searched for emissions during preliminary investigation. Refer to diagrams two and three showing typical test setup. Refer to photographs in the test setup exhibits for specific EUT placement during testing.

Antenna Port Conducted Emission Test Procedure

The EUT was assembled as required for operation and placed on a benchtop. This configuration provided the ability to connect test equipment to the provided test antenna port. Antenna Port conducted emissions testing was performed as presented in this document and specified in ANSI C63.10-2013. Testing was completed on a laboratory bench in a shielded room. The active antenna port of the device was connected to appropriate attenuation and the spectrum analyzer. Refer to diagram four showing typical test arrangement and photographs in the test setup exhibits for specific EUT placement during testing.

Diagram 1 Test arrangement for Conducted emissions

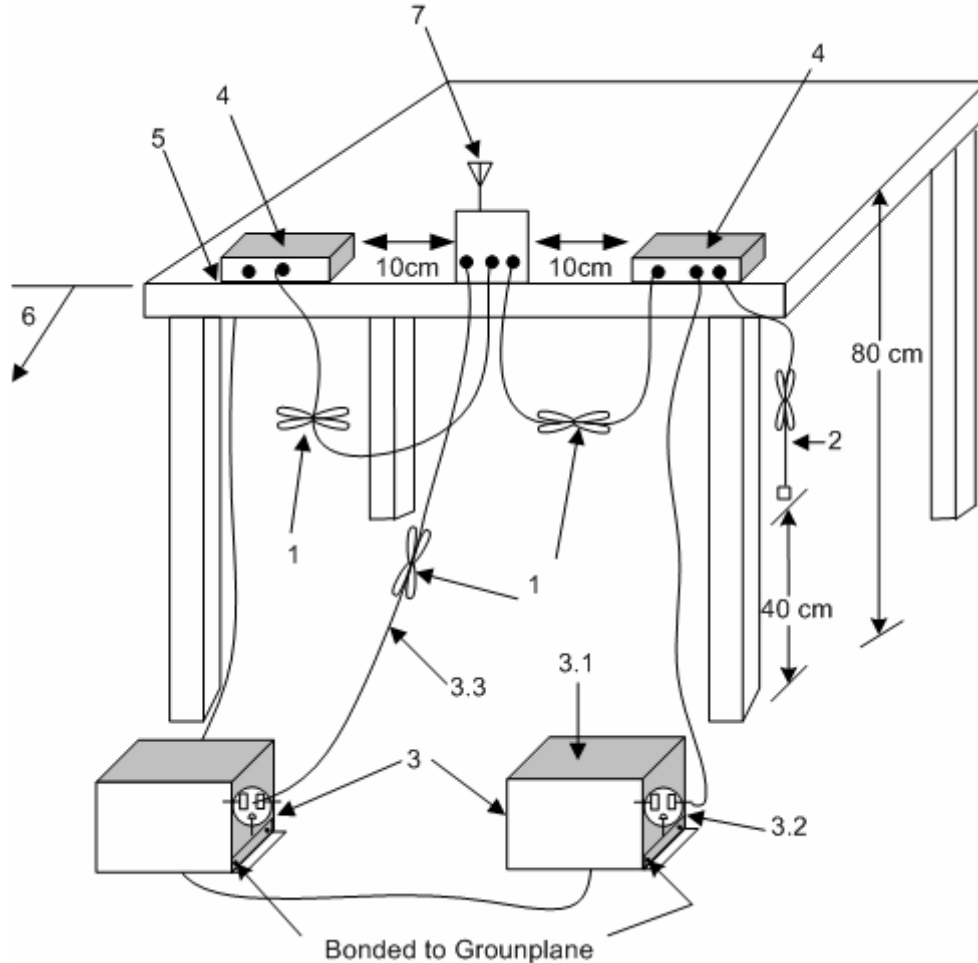

1. Interconnecting cables that hang closer than 40 cm to the ground plane shall be folded back and forth in the center forming a bundle 30 cm to 40 cm long see (see 6.2.3.1).
2. I/O cables that are not connected to an accessory shall be bundled in the center. The end of the cable may be terminated, if required, using the correct terminating impedance. The overall length shall not exceed 1 m (see 6.2.2).
3. EUT connected to one LISN. Unused LISN measuring port connectors shall be terminated in 50 Ω loads. LISN can be placed on top of, or immediately beneath, reference ground plane (see 6.2.2 and 6.2.3).
 - 3.1 All other equipment powered from additional LISN(s).
 - 3.2 Multiple-outlet strip can be used for multiple power cords of non-EUT equipment.
 - 3.3 LISN at least 80 cm from nearest part of EUT chassis.
4. Non-EUT components of EUT system being tested.
5. Rear of EUT, including peripherals, shall all be aligned and flush with rear of tabletop (see 6.2.3.1).
6. Edge of tabletop shall be 40 cm removed from a vertical conducting plane that is bonded to the ground plane (see 6.2.2 for options).
7. Antenna may be integral or detachable. If detachable, the antenna shall be attached for this test.

Diagram 2 Test arrangement for radiated emissions of tabletop equipment

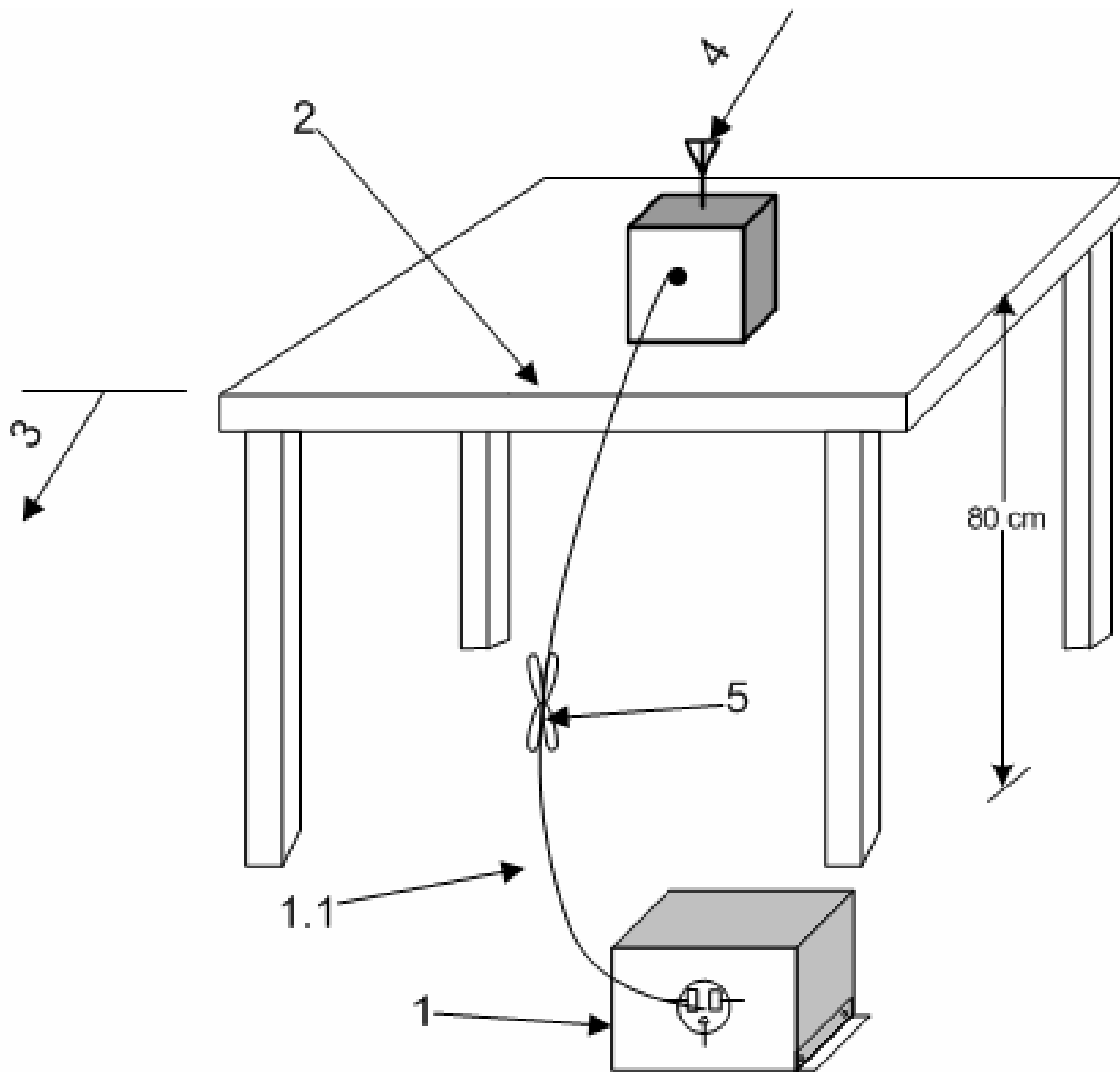

1—A LISN is optional for radiated measurements between 30 MHz and 1000 MHz but not allowed for measurements below 30 MHz and above 1000 MHz (see 6.3.1). If used, then connect EUT to one LISN. Unused LISN measuring port connectors shall be terminated in 50 Ω loads. The LISN may be placed on top of, or immediately beneath, the reference ground plane (see 6.2.2 and 6.2.3.2).

1.1—LISN spaced at least 80 cm from the nearest part of the EUT chassis.

2—Antenna can be integral or detachable, depending on the EUT (see 6.3.1).

3—Interconnecting cables that hang closer than 40 cm to the ground plane shall be folded back and forth in the center forming a bundle 30 cm to 40 cm long (see 6.3.1).

4—For emission measurements at or below 1 GHz, the table height shall be 80 cm. For emission measurements above 1 GHz, the table height shall be 1.5 m for measurements, except as otherwise specified (see 6.3.1 and 6.6.3.1).

Diagram 3 Test arrangement for radiated emissions tested on Open Area Test Site (OATS)

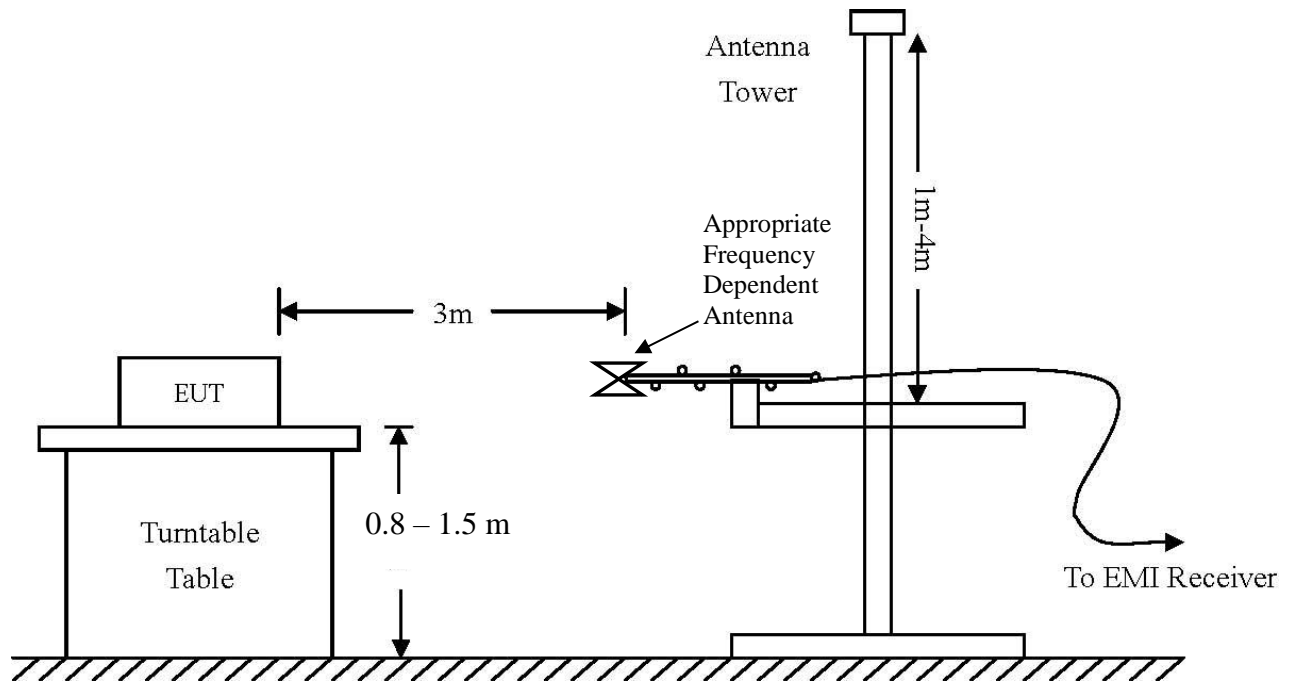
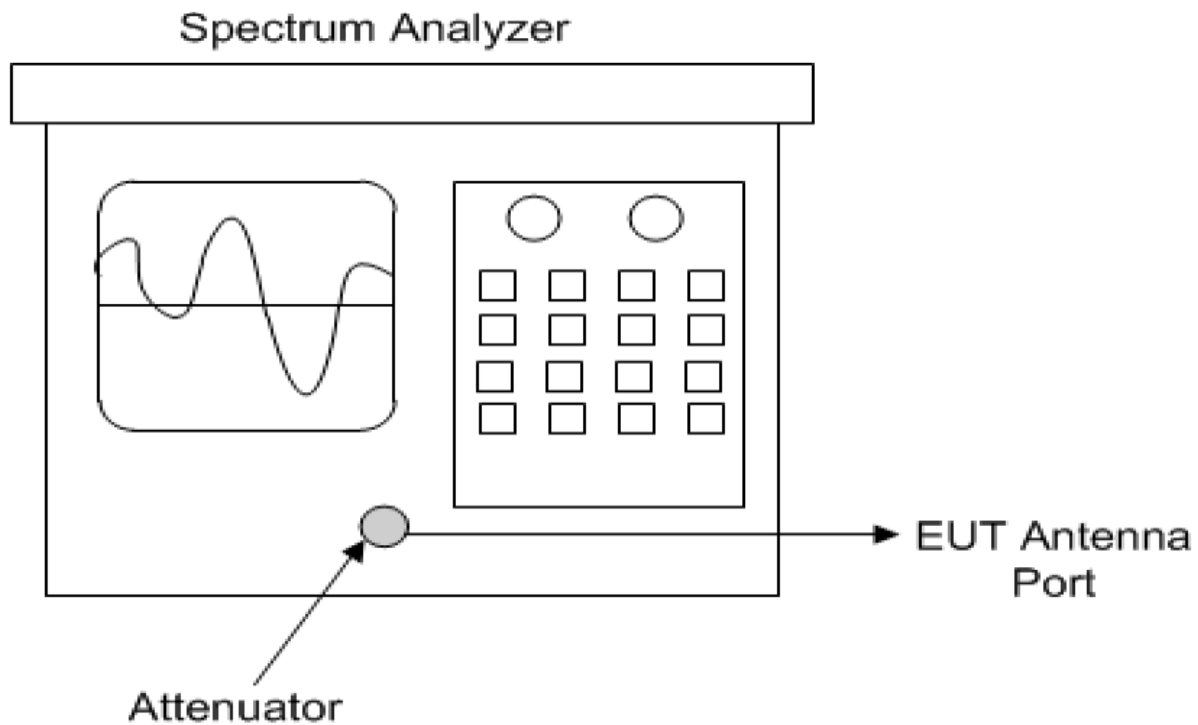

Diagram 4 Test arrangement for Antenna Port Conducted emissions



Test Site Locations

Conducted EMI	AC line conducted emissions testing performed in a shielded screen room located at Rogers Labs, Inc., 4405 West 259 th Terrace, Louisburg, KS
Antenna port	Antenna port conducted emissions testing was performed in a shielded screen room located at Rogers Labs, Inc., 4405 West 259 th Terrace, Louisburg, KS
Radiated EMI	The radiated emissions tests were performed at the 3 meters, Open Area Test Site (OATS) located at Rogers Labs, Inc., 4405 West 259 th Terrace, Louisburg, KS

Registered Site information: FCC Site: US5305, ISED: 3041A, CAB Identifier: US0096

NVLAP Accreditation Lab code 200087-0

Units of Measurements

Conducted EMI	Data presented in dB μ V; dB referenced to one microvolt
Antenna port Conducted	Data is in dBm; dB referenced to one milliwatt
Radiated EMI	Data presented in dB μ V/m; dB referenced to one microvolt per meter

Note: Radiated limit may be expressed for measurement in dB μ V/m when the measurement is taken at a distance of 3 or 10 meters. Data taken for this report was taken at distance of 3 meters. Sample calculation demonstrates corrected field strength reading for Open Area Test Site using the measurement reading and correcting for receive antenna factor, cable losses, and amplifier gains.

Sample Calculation:

RFS = Radiated Field Strength, FSM = Field Strength Measured

A.F. = Receive antenna factor, Losses = attenuators/cable losses, Gain = amplification gains

$RFS (dB\mu V/m @ 3m) = FSM (dB\mu V) + A.F. (dB/m) + Losses (dB) - Gain (dB)$

Environmental Conditions

Ambient Temperature	23.9° C
Relative Humidity	44 %
Atmospheric Pressure	1010.6 mb

Statement of Modifications and Deviations

No modifications to the EUT were required for the equipment to demonstrate compliance with the 47CFR Part 15C, Industry Canada RSS-247 Issue 2, and RSS-GEN Issue 5 emission requirements. There were no deviations to the specifications.

Intentional Radiators

The following information is submitted supporting compliance with the requirements of 47CFR, Subpart C, paragraph 15.247, Industry Canada RSS-247 Issue 2, and RSS-GEN Issue 5.

Antenna Requirements

The EUT incorporates integral Planer Inverted F Antenna (PIFA) system. Production equipment offers no provision for connection to alternate antenna system. The antenna connection point complies with the unique antenna connection requirements. There are no deviations or exceptions to the specification.

Restricted Bands of Operation

Spurious emissions falling in the restricted frequency bands of operation were measured at the OATS. The EUT utilizes frequency, determining circuitry, which generates harmonics falling in the restricted bands. Emissions were investigated at the OATS, using appropriate antennas or pyramidal horns, amplification stages, and a spectrum analyzer. Peak and average amplitudes of frequencies above 1000 MHz were compared to the required limits with worst-case data presented below. Test procedures of ANSI C63.10-2013 were used during testing. No other significant emission was observed which fell into the restricted bands of operation. Computed emission values consider the received radiated field strength, receive antenna correction factor, amplifier gain stage, and test system cable losses.

Rogers Labs, Inc.	Garmin International, Inc.	SN's: 3403386859 / 3403386735
4405 West 259 th Terrace	Model: A04622	FCC ID: IPH-04622
Louisburg, KS 66053	Test: 220304	IC: 1792A-04622
Phone/Fax: (913) 837-3214	Test to: 47CFR 15C, RSS-Gen RSS-247	Date: June 21, 2022
Revision 1	File: A04622 DSS TstRpt 220304	Page 19 of 50

Table 1 Radiated Emissions in Restricted Frequency Bands Data Mode 1 BT BR

Frequency in MHz	Horizontal Peak (dBµV/m)	Horizontal Average (dBµV/m)	Vertical Peak (dBµV/m)	Vertical Average (dBµV/m)	Limit @ 3m (dBµV/m)	Horizontal Margin (dB)	Vertical Margin (dB)
2390.0	63.2	35.1	63.1	31.0	54.0	-18.9	-23.0
2483.5	68.6	36.8	69.4	34.6	54.0	-17.2	-19.4
4804.0	49.6	37.2	49.9	37.1	54.0	-16.8	-16.9
4882.0	50.5	38.9	49.1	36.5	54.0	-15.1	-17.5
4960.0	50.6	39.1	50.1	36.8	54.0	-14.9	-17.2
7206.0	53.3	40.7	53.8	41.6	54.0	-13.3	-12.4
7323.0	56.3	44.4	54.8	43.2	54.0	-9.6	-10.8
7440.0	54.8	43.7	54.8	43.0	54.0	-10.3	-11.0
12010.0	58.6	45.9	59.2	45.9	54.0	-8.1	-8.1
12205.0	60.2	47.5	60.2	47.0	54.0	-6.5	-7.0
12400.0	60.0	46.8	60.4	46.8	54.0	-7.2	-7.2

Other emissions present had amplitudes at least 20 dB below the limit. Peak and Quasi-Peak amplitude emissions are recorded for frequency below 1000 MHz. Peak and Average amplitude emissions are recorded for frequency range above 1000 MHz.

Summary of Results for Radiated Emissions in Restricted Bands

The EUT demonstrated compliance with the radiated emissions requirements of 47CFR Part 15C and RSS-247 Issue 2 Intentional Radiator requirements. The EUT demonstrated a worst-case minimum margin of -6.5 dB below the emissions requirements in restricted frequency bands. Peak, Quasi-peak, and average amplitudes were checked for compliance with the regulations. Worst-case emissions are reported with other emissions found in the restricted frequency bands at least 20 dB below the requirements.

AC Line Conducted EMI Procedure

The EUT was arranged in typical AC power equipment configurations for AC Line Conducted emissions testing. Testing was performed with the EUT placed on a 1 x 1.5-meter wooden bench 80 cm above the conducting ground plane, floor of a screen room. The bench was positioned 40 cm away from the wall of the screen room. The LISN was positioned on the floor of the screen room 80-cm from the rear of the EUT. Testing for the AC line-conducted emissions were the procedures of ANSI C63.10-2013 paragraph 6. The AC power adapter or CPU providing power to the EUT was connected to the LISN for AC line-conducted emissions testing. A second LISN was positioned on the floor of the screen room 80-cm from the rear of the supporting equipment of the EUT. All power cords except those providing power to the EUT were then powered from the second LISN. EMI was coupled to the spectrum analyzer through a 0.1 μ F capacitor, internal to the LISN. Power line conducted emissions testing was carried out individually for each current carrying conductor of the EUT. The excess length of lead between the system and the LISN receptacle was folded back and forth to form a bundle not exceeding 40 cm in length. The screen room, conducting ground plane, analyzer, and LISN were bonded together to the protective earth ground. Preliminary testing was performed to identify the frequencies of each of the emissions, which demonstrated the highest amplitudes. The cables were repositioned to obtain maximum amplitude of measured EMI level. Once the worst-case configuration was identified, plots were made of the EMI from 0.15 MHz to 30 MHz then data was recorded with maximum conducted emissions levels.

Refer to figures one and two for plots of configuration #2, EUT – AC Power Adapter Line conducted emissions.

Refer to figures three and four for plots of configuration #3, EUT – USB Computer interface AC Line conducted emissions.

Figure 1 AC Line Conducted emissions of EUT line 1 (EUT – AC Adapter)

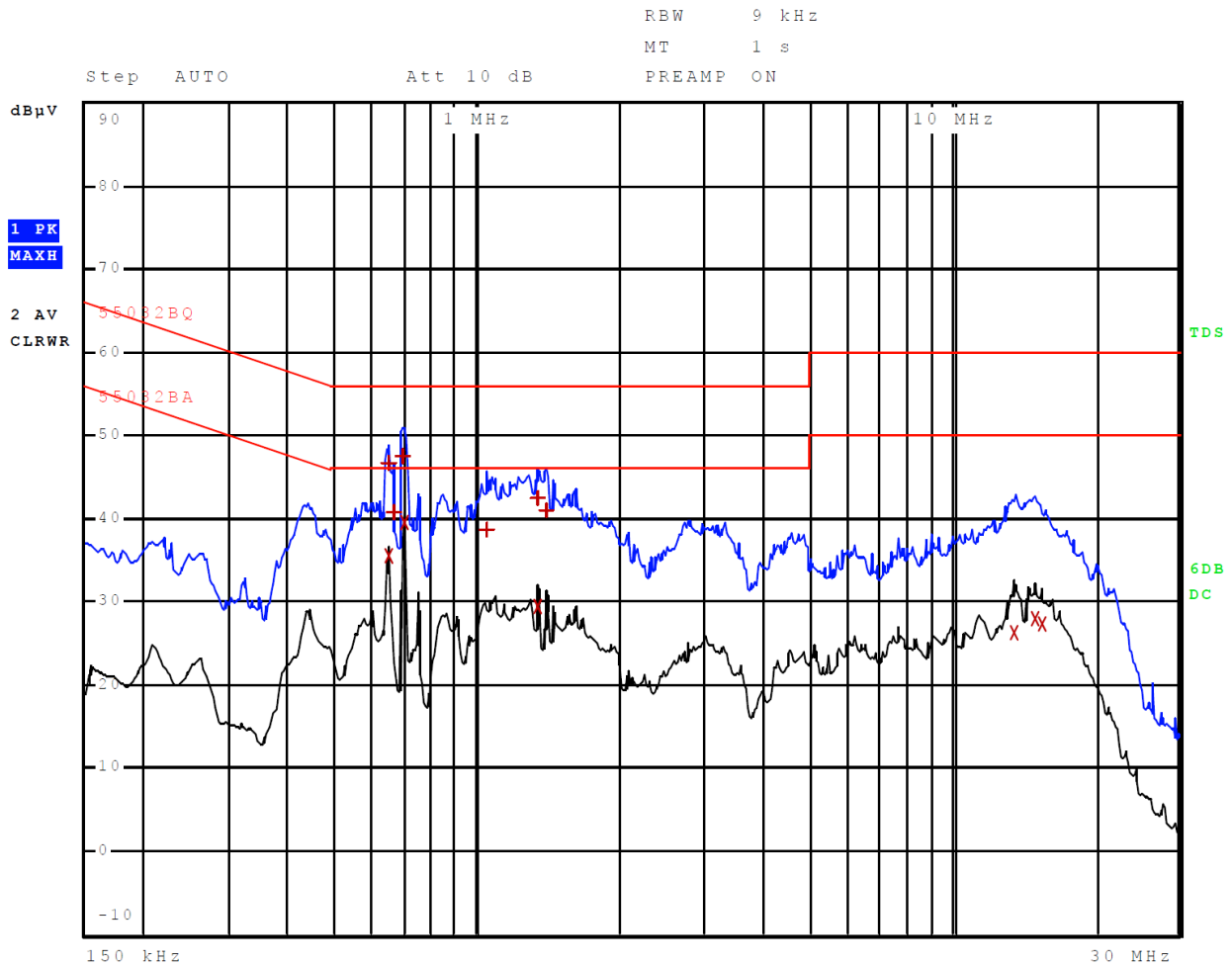

Figure 2 AC Line Conducted emissions of EUT line 2 (EUT – AC Adapter)

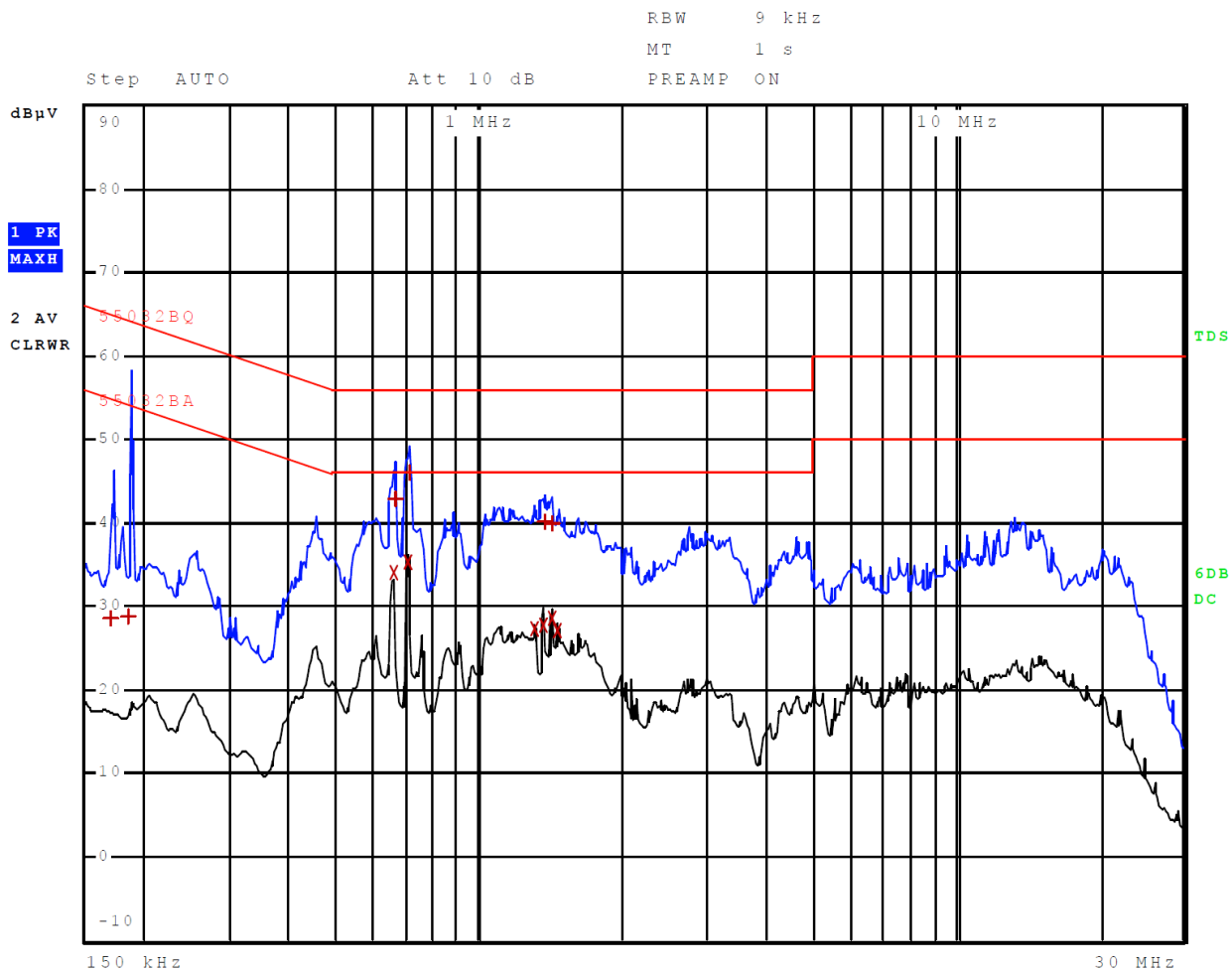

Figure 3 AC Line Conducted emissions of EUT line 1 (EUT – Computer)

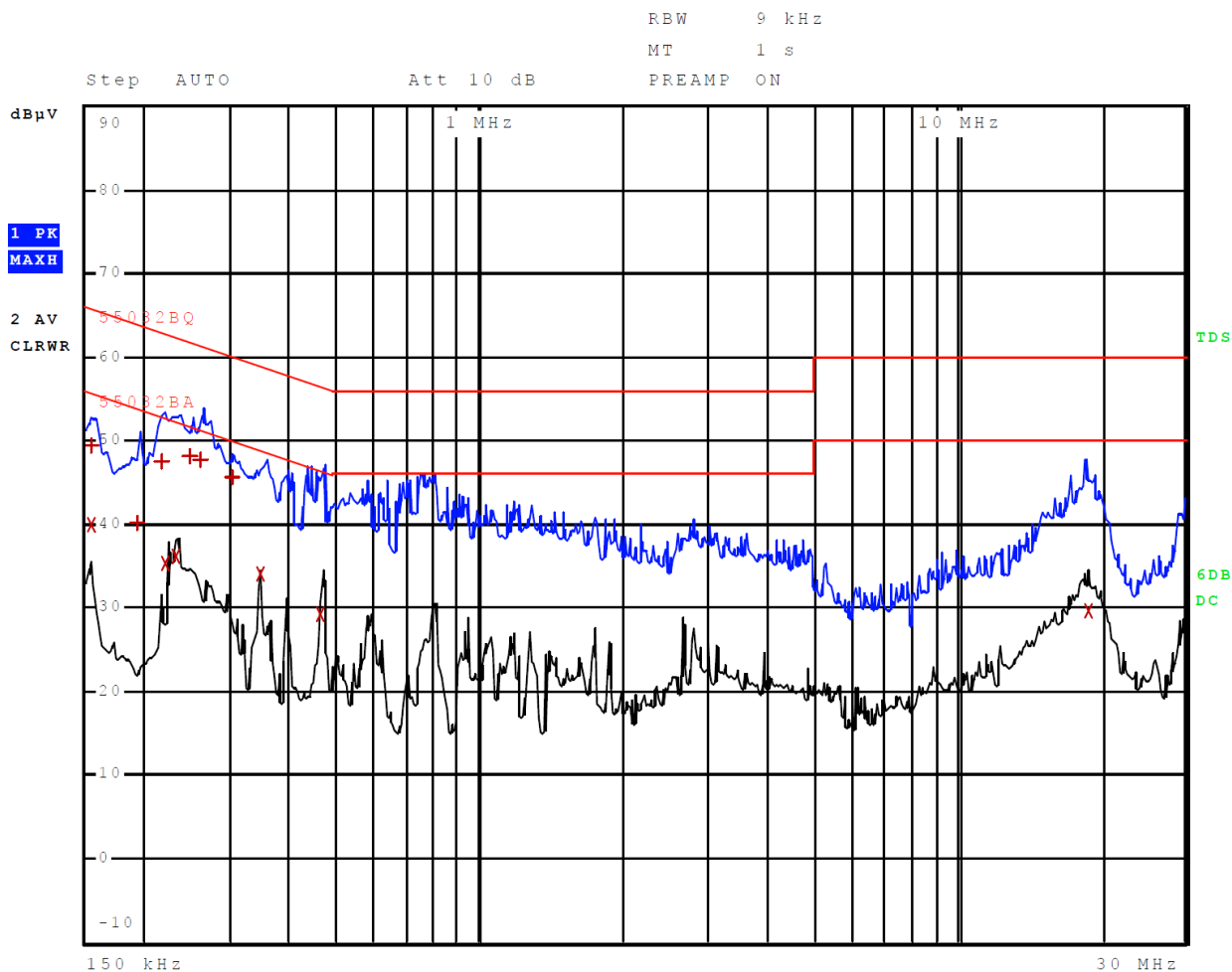

Figure 4 AC Line Conducted emissions of EUT line 2 (EUT – Computer)

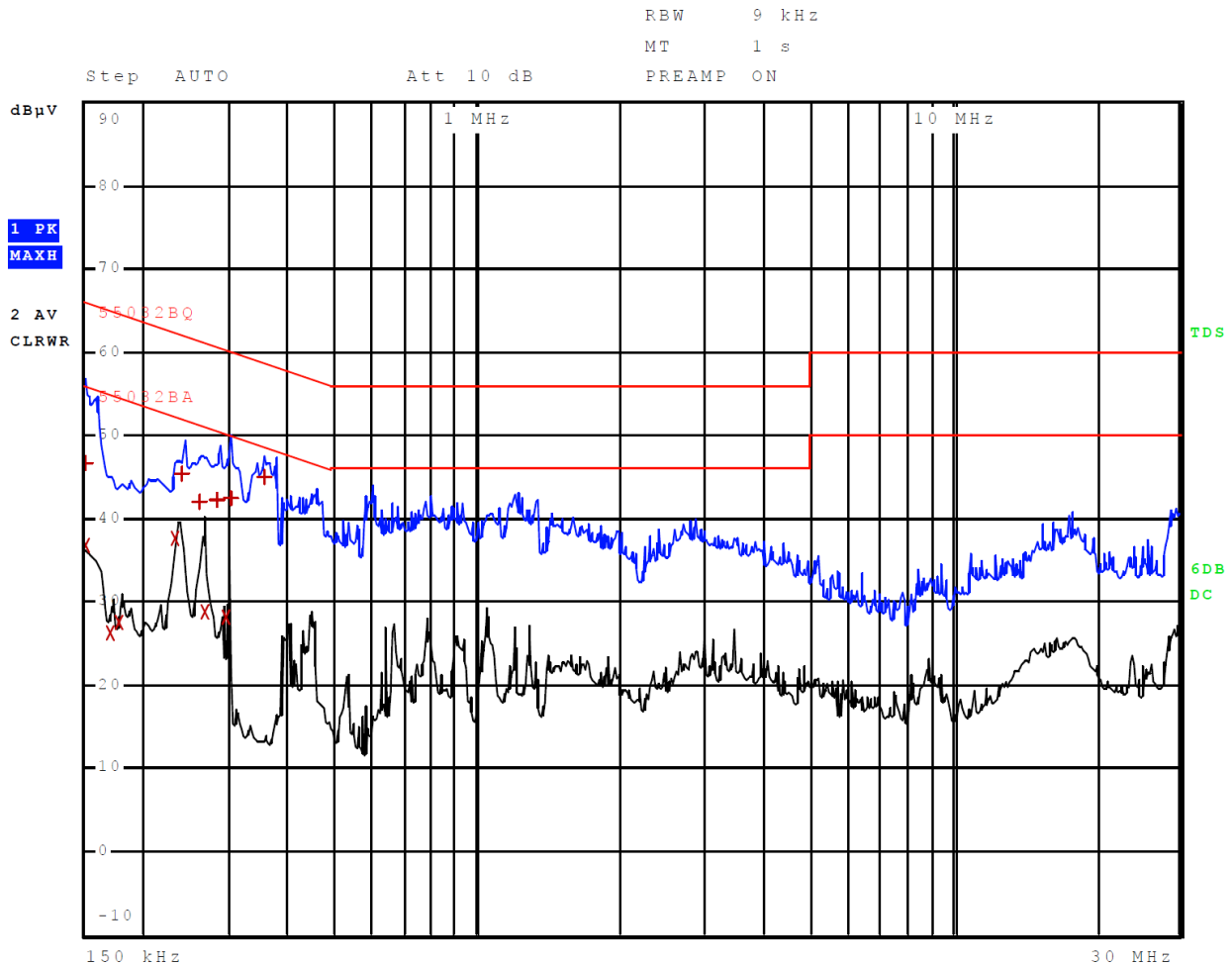

Table 2 AC Line Conducted Emissions Data L1 (EUT – AC Adapter)

Trace	Frequency	Level (dBµV)	Detector	Delta Limit/dB
1	646.000000000 kHz	46.66	Quasi Peak	-9.34
2	646.000000000 kHz	35.48	Average	-10.52
1	662.000000000 kHz	40.69	Quasi Peak	-15.31
1	694.000000000 kHz	47.54	Quasi Peak	-8.46
2	698.000000000 kHz	39.46	Average	-6.54
1	1.046000000 MHz	38.73	Quasi Peak	-17.27
2	1.342000000 MHz	29.33	Average	-16.67
1	1.342000000 MHz	42.51	Quasi Peak	-13.49
1	1.390000000 MHz	40.87	Quasi Peak	-15.13
2	13.535900000 MHz	26.25	Average	-23.75
2	14.915900000 MHz	27.94	Average	-22.06
2	15.439900000 MHz	27.22	Average	-22.78

Other emissions present had amplitudes at least 20 dB below the limit.

Table 3 AC Line Conducted Emissions Data L2 (EUT – AC Adapter)

Trace	Frequency	Level (dBµV)	Detector	Delta Limit/dB
1	170.000000000 kHz	28.54	Quasi Peak	-36.42
1	186.000000000 kHz	28.80	Quasi Peak	-35.42
2	658.000000000 kHz	34.05	Average	-11.95
1	666.000000000 kHz	42.80	Quasi Peak	-13.20
2	706.000000000 kHz	35.20	Average	-10.80
1	710.000000000 kHz	46.09	Quasi Peak	-9.91
2	1.306000000 MHz	27.29	Average	-18.71
2	1.358000000 MHz	27.62	Average	-18.38
1	1.366000000 MHz	40.16	Quasi Peak	-15.84
2	1.418000000 MHz	28.63	Average	-17.37
1	1.418000000 MHz	39.90	Quasi Peak	-16.10
2	1.458000000 MHz	27.13	Average	-18.87

Other emissions present had amplitudes at least 20 dB below the limit.

Table 4 AC Line Conducted Emissions Data L1 (EUT – Computer)

Trace	Frequency	Level (dBµV)	Detector	Delta Limit/dB
1	154.000000000 kHz	49.27	Quasi Peak	-16.51
2	154.000000000 kHz	39.93	Average	-15.86
1	194.000000000 kHz	40.01	Quasi Peak	-23.85
1	218.000000000 kHz	47.45	Quasi Peak	-15.45
2	222.000000000 kHz	35.22	Average	-17.53
2	234.000000000 kHz	36.06	Average	-16.24
1	250.000000000 kHz	48.01	Quasi Peak	-13.74
1	262.000000000 kHz	47.74	Quasi Peak	-13.63
1	302.000000000 kHz	45.50	Quasi Peak	-14.69
2	346.000000000 kHz	34.09	Average	-14.97
2	466.000000000 kHz	29.10	Average	-17.49
2	18.795900000 MHz	29.66	Average	-20.34

Other emissions present had amplitudes at least 20 dB below the limit.

Table 5 AC Line Conducted Emissions Data L2 (EUT – Computer)

Trace	Frequency	Level (dBµV)	Detector	Delta Limit/dB
1	150.000000000 kHz	46.66	Quasi Peak	-19.34
2	150.000000000 kHz	36.77	Average	-19.23
2	170.000000000 kHz	26.29	Average	-28.67
2	178.000000000 kHz	27.46	Average	-27.12
2	234.000000000 kHz	37.68	Average	-14.63
1	242.000000000 kHz	45.38	Quasi Peak	-16.64
1	262.000000000 kHz	41.89	Quasi Peak	-19.48
2	266.000000000 kHz	28.75	Average	-22.49
1	286.000000000 kHz	42.21	Quasi Peak	-18.43
2	298.000000000 kHz	28.10	Average	-22.20
1	302.000000000 kHz	42.37	Quasi Peak	-17.81
1	354.000000000 kHz	44.97	Quasi Peak	-13.90

Other emissions present had amplitudes at least 20 dB below the limit.

AC Line Conducted Emissions Results

The EUT demonstrated compliance with the AC Line Conducted Emissions requirements of 47CFR Part 15C and other applicable emissions requirements. The EUT-AC adapter configuration #2 worst-case configuration demonstrated a minimum margin of -6.5 dB below the requirement. The EUT-CPU configurations #3 worst-case configuration demonstrated a minimum margin of -14.6 dB below the requirement. Other emissions were present with amplitudes at least 20 dB below the limit and worst-case amplitudes recorded.

General Radiated Emissions Procedure

The EUT was arranged in a typical equipment configuration and operated through all available modes during testing. Preliminary testing was performed in a screen room with the EUT positioned 1 meter from the FSM. Radiated emissions measurements were performed to identify the frequencies, which produced the highest emissions. Each radiated emission was then maximized at the OATS location before final radiated measurements were performed. Final data was taken with the EUT located on the OATS at 3 meters distance between the EUT and the receiving antenna. The frequency spectrum from 9 kHz to 25,000 MHz was searched for general radiated emissions. Measured emission levels were maximized by EUT placement on the table, rotating the turntable through 360 degrees, varying the antenna height between 1 and 4 meters above the ground plane and changing antenna position between horizontal and vertical polarization. Antennas used were Loop from 9 kHz to 30 MHz, Broadband Biconical from 30 to 200 MHz, Biconilog from 30 to 1000 MHz, Log Periodic from 200 MHz to 1 GHz and or double Ridge or pyramidal horns and mixers above 1 GHz, notch filters and appropriate amplifiers and external mixers were utilized.

Table 6 General Radiated Emissions Data

Frequency (MHz)	Horizontal Peak (dB μ V/m)	Horizontal Quasi-Peak (dB μ V/m)	Vertical Peak (dB μ V/m)	Vertical Quasi-Peak (dB μ V/m)	Limit @ 3m (dB μ V/m)	Horizontal Margin (dB)	Vertical Margin (dB)
109.9	41.7	33.6	37.7	30.8	40.0	-6.4	-9.2
112.3	46.6	37.9	45.1	36.1	40.0	-2.1	-3.9
116.4	40.2	33.4	46.0	35.6	40.0	-6.6	-4.4
135.2	30.8	19.0	24.8	18.5	40.0	-21.0	-21.5
180.0	33.8	26.8	37.1	26.7	40.0	-13.2	-13.3
183.3	29.2	20.0	28.1	18.4	40.0	-20.0	-21.6
187.7	33.3	22.0	34.2	22.3	40.0	-18.0	-17.7
195.0	31.0	21.7	34.1	23.4	40.0	-18.3	-16.6
349.0	42.7	33.7	36.6	27.0	47.0	-13.3	-20.0
480.0	43.1	40.1	43.0	39.8	47.0	-6.9	-7.2

Other emissions present had amplitudes at least 20 dB below the limit. Peak and Quasi-Peak amplitude emissions are recorded for frequency range below 1000 MHz. Peak and Average amplitude emissions are recorded for frequency range above 1000 MHz.

Summary of Results for General Radiated Emissions

The EUT demonstrated compliance with the radiated emissions requirements of 47CFR Part 15C paragraph 15.209, RSS-247 Issue 2, and RSS-GEN Issue 5 Intentional Radiators. The EUT configuration demonstrated a minimum margin of -2.1 dB below the requirements. Other emissions were present with amplitudes at least 20 dB below the Limits.

Operation in the Band 2400 – 2483.5 MHz

Test procedures of ANSI C63.10-2013 and KDB 558074 D01 15.247 Meas Guidance v05 were used during transmitter testing. The transmitter peak power was measured at the antenna port as described in ANSI C63.10-2013. The 20-dB and 99% emission bandwidths were measured as described in C63.10-2013. The channel separation and the number of hopping channels were measured at the antenna port as described in C63.10-2013. The system utilizes at least 15 channels with average time of occupancy on any channel not exceeding 0.4 seconds within a period of 0.4 seconds multiplied by the number of hopping channels employed. The transmitter radiated spurious and general emissions were measured on an open area test site @ 3 meters. During radiated emissions measurements, the EUT sample #1 was placed on a turntable elevated as required above the ground plane at a distance of 3 meters from the measurement antenna. The amplitude of each emission was then recorded from the measurement results. The test system gains and losses were accounted for in the measurement results presented. The amplitude of each radiated emission was maximized by equipment orientation and placement on the turn table, raising and lowering the FSM (Field Strength Measuring) antenna, changing the FSM antenna polarization, and by rotating the turntable. A Loop antenna was used for measuring emissions from 0.009 to 30 MHz, Biconilog Antenna for 30 to 1000 MHz, Double-Ridge, and/or Pyramidal Horn Antennas from 1 GHz to 25 GHz. Emissions were measured in dB μ V/m @ 3 meters. Antenna port conducted emission data and plots were taken using test sample #2.

Requirement: Average occupancy time Requirement:

Average time of occupancy on any channel shall not be greater than 400 mS (0.4 seconds) within a 30 second period (0.4 times the number of hopping channels of 79).

Time on channel: The design resides on channel 300 times in a 30 second period. Transmitting each time for 12.6 μ S which equates to an average time of occupancy of (288*12.5 μ S) 3.8 mS.

The 3.8 mS average time of occupancy demonstrates compliance with requirement of less than 400 mS in 30 second period. Additional Frequency Hopping detail may be found in the operational description exhibits.

Refer to figures five through sixteen showing plots taken of the 2402-2480 MHz BT BR (GFSK) Frequency Hopping Spread Spectrum operation displaying compliance with the specifications.

Figure 5 Plot of Transmitter Emissions Operation in 2402-2480 MHz Mode 1 BT BR

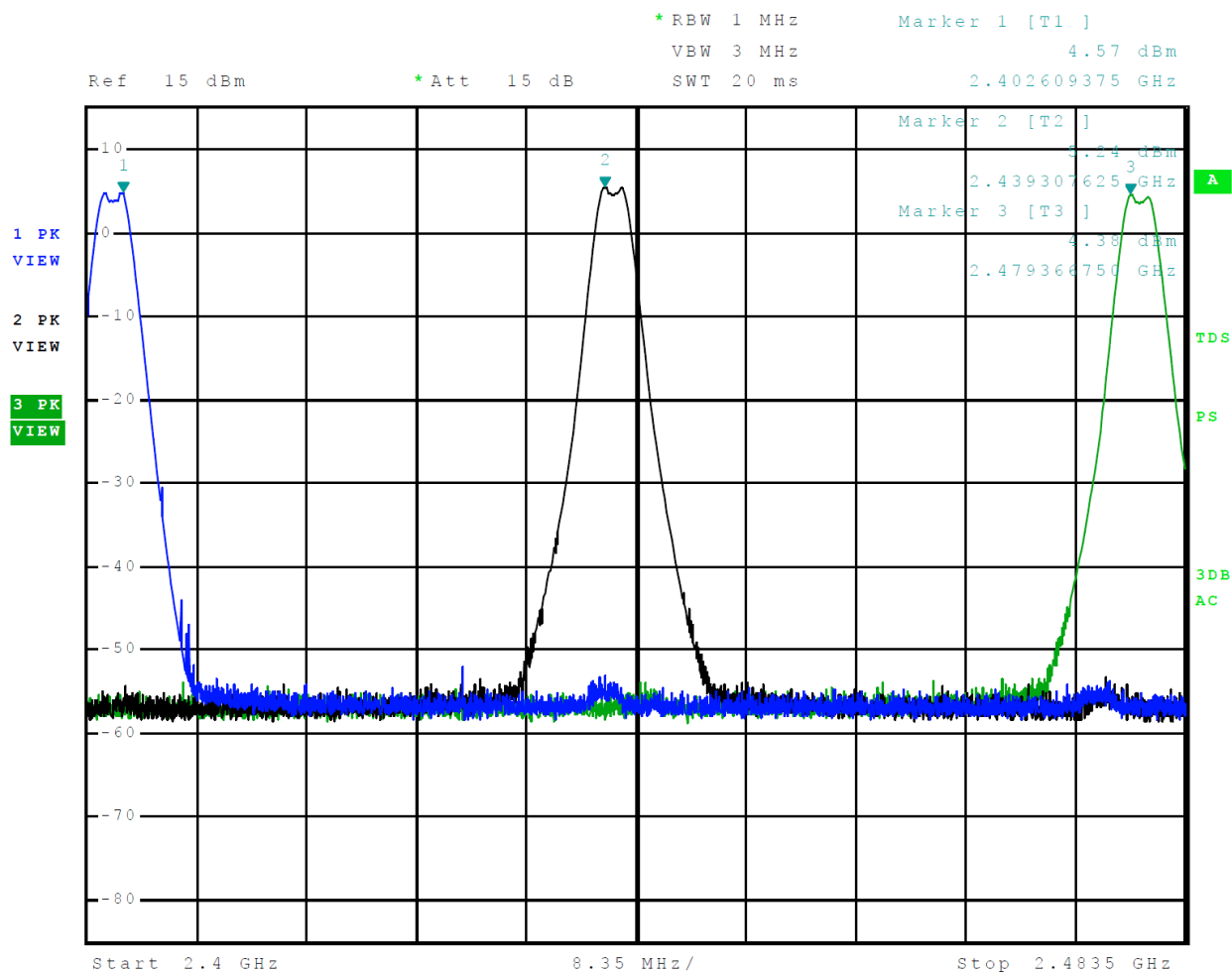

Figure 6 Plot of Transmitter Emissions 20-dB Occupied Bandwidth Mode 1 BT BR

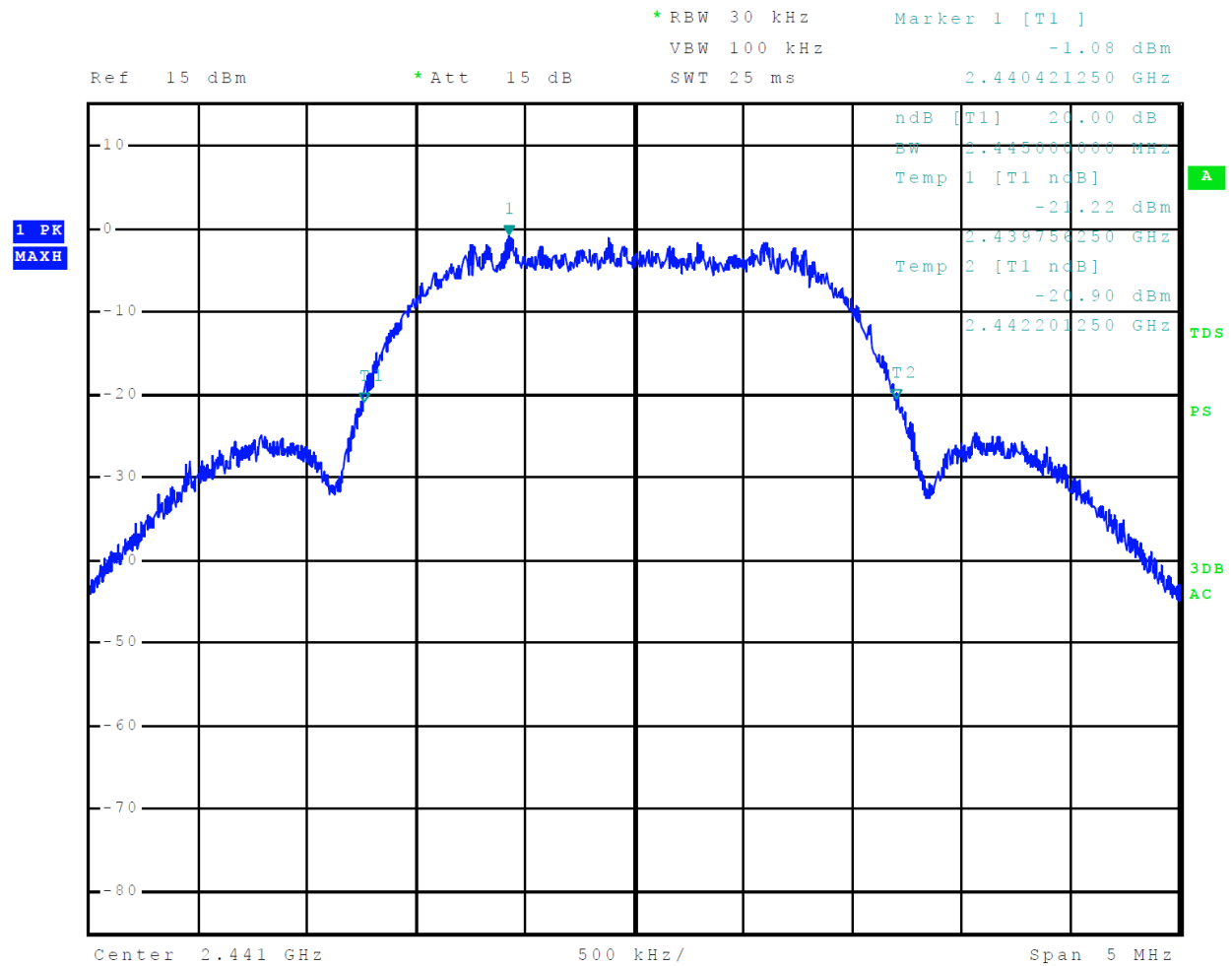

Figure 7 Plot of Transmitter Emissions 99% Occupied Bandwidth Mode 1 BT BR

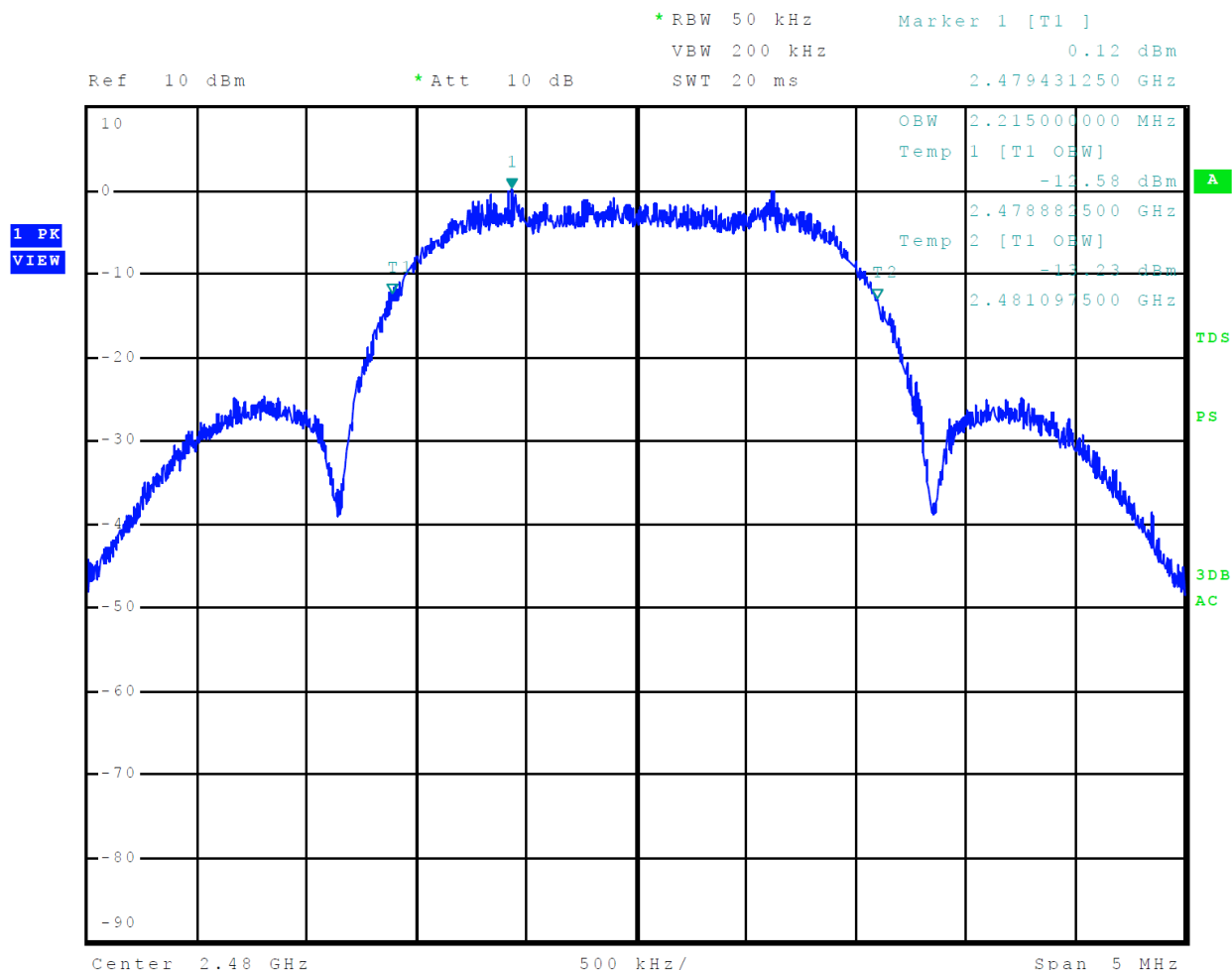

Figure 8 Plot of Number of Hopping Channels Mode 1 BT BR

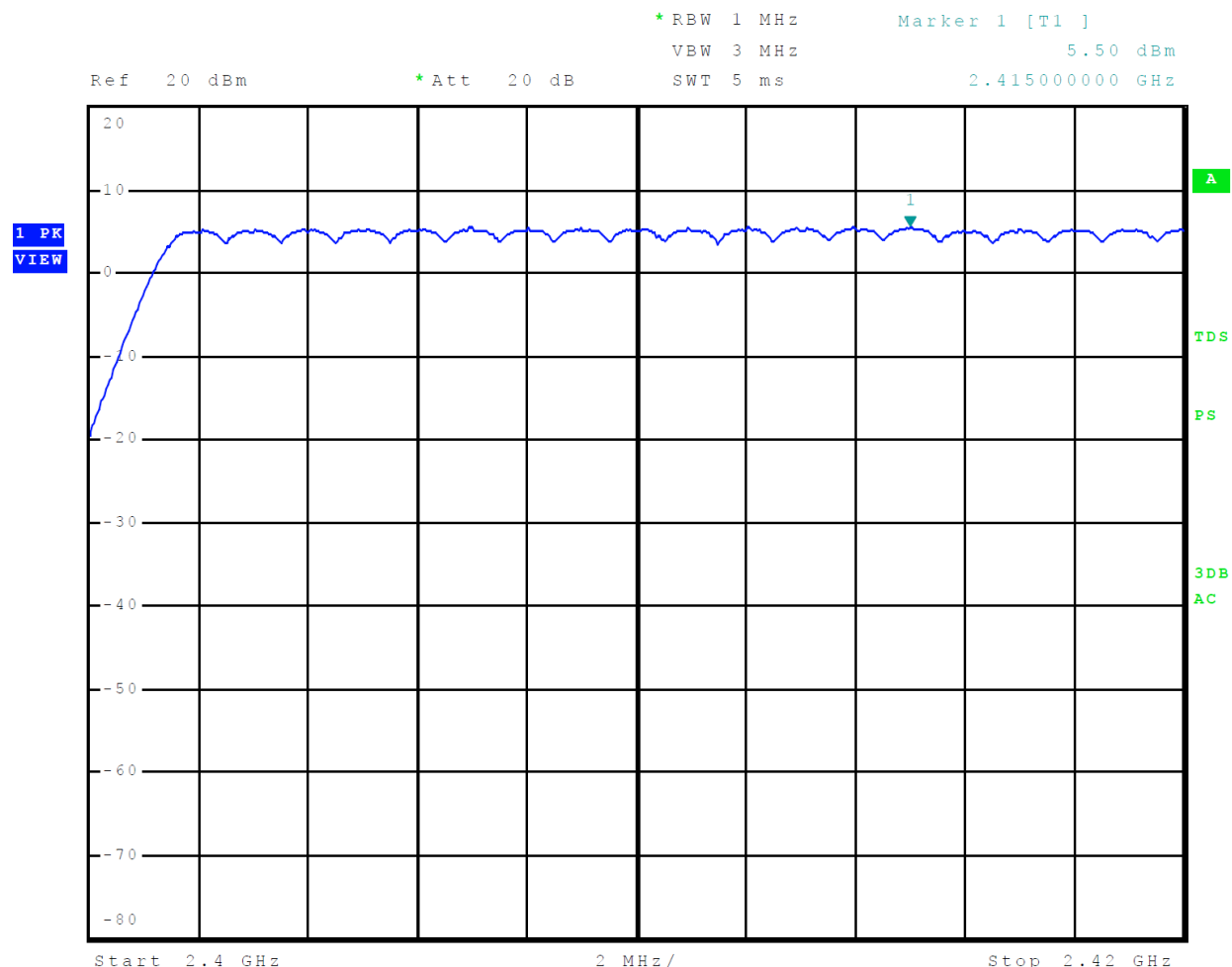

Figure 9 Plot of Number of Hopping Channels Mode 1 BT BR

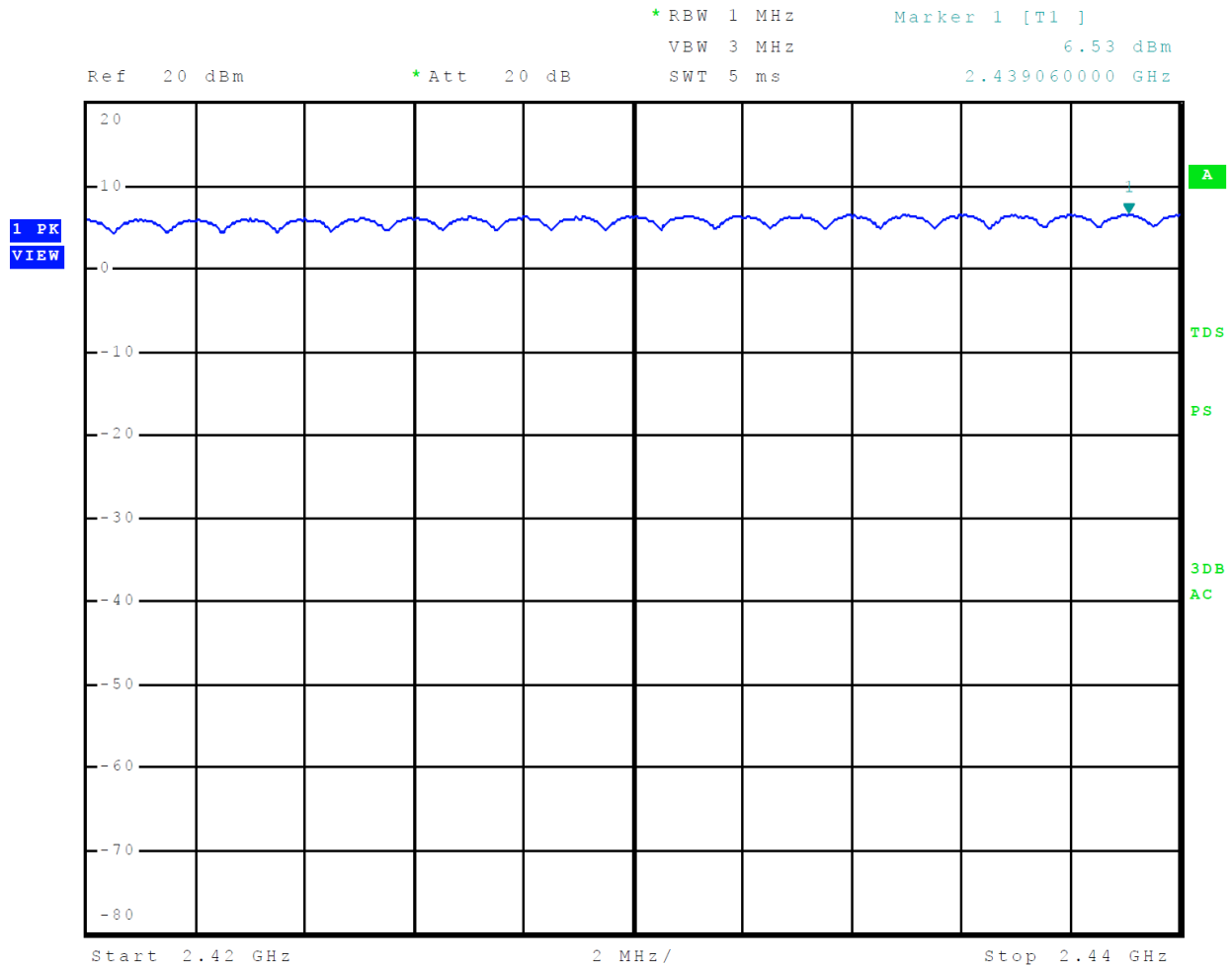

Figure 10 Plot of Number of Hopping Channels Mode 1 BT BR

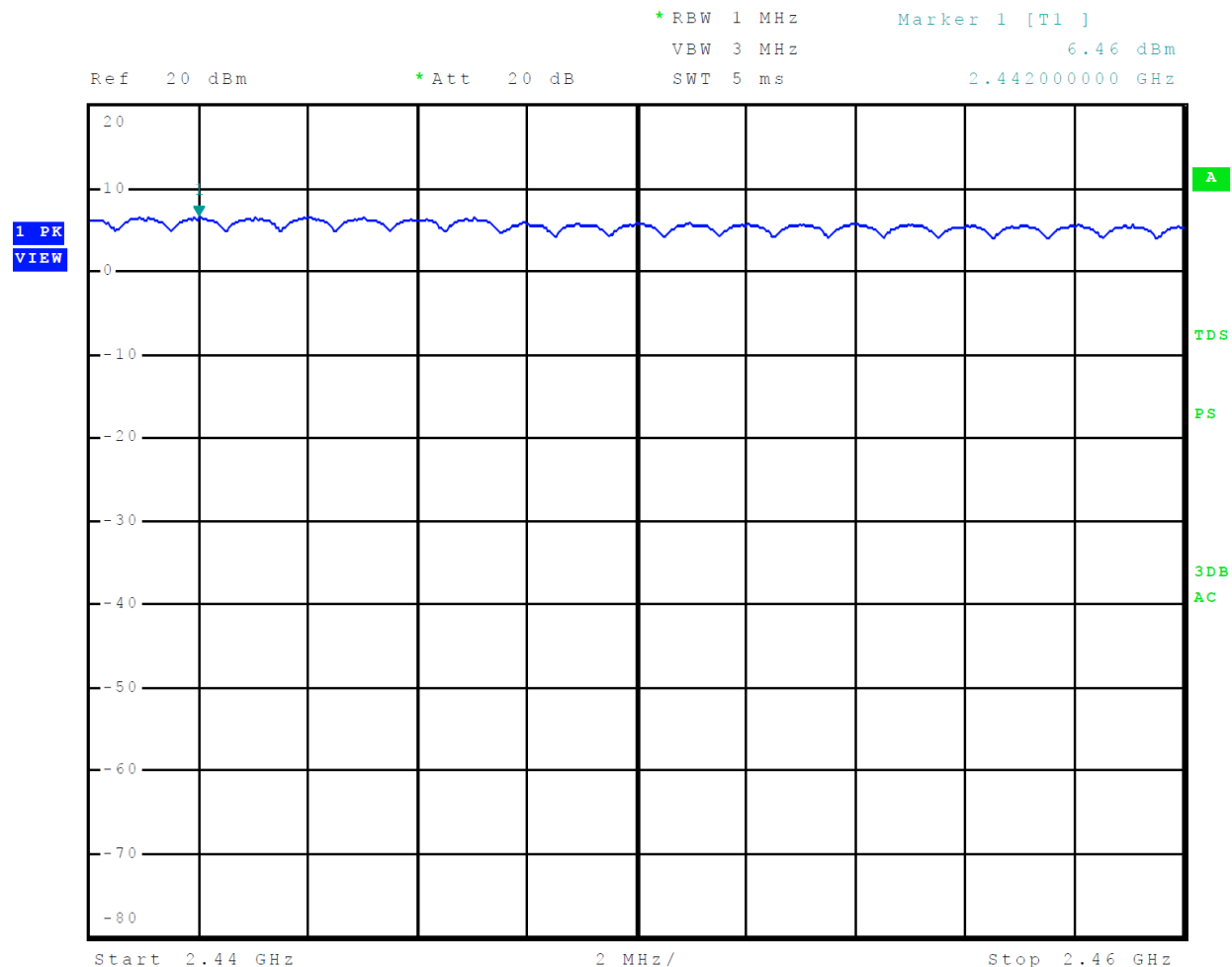

Figure 11 Plot of Number of Hopping Channels Mode 1 BT BR

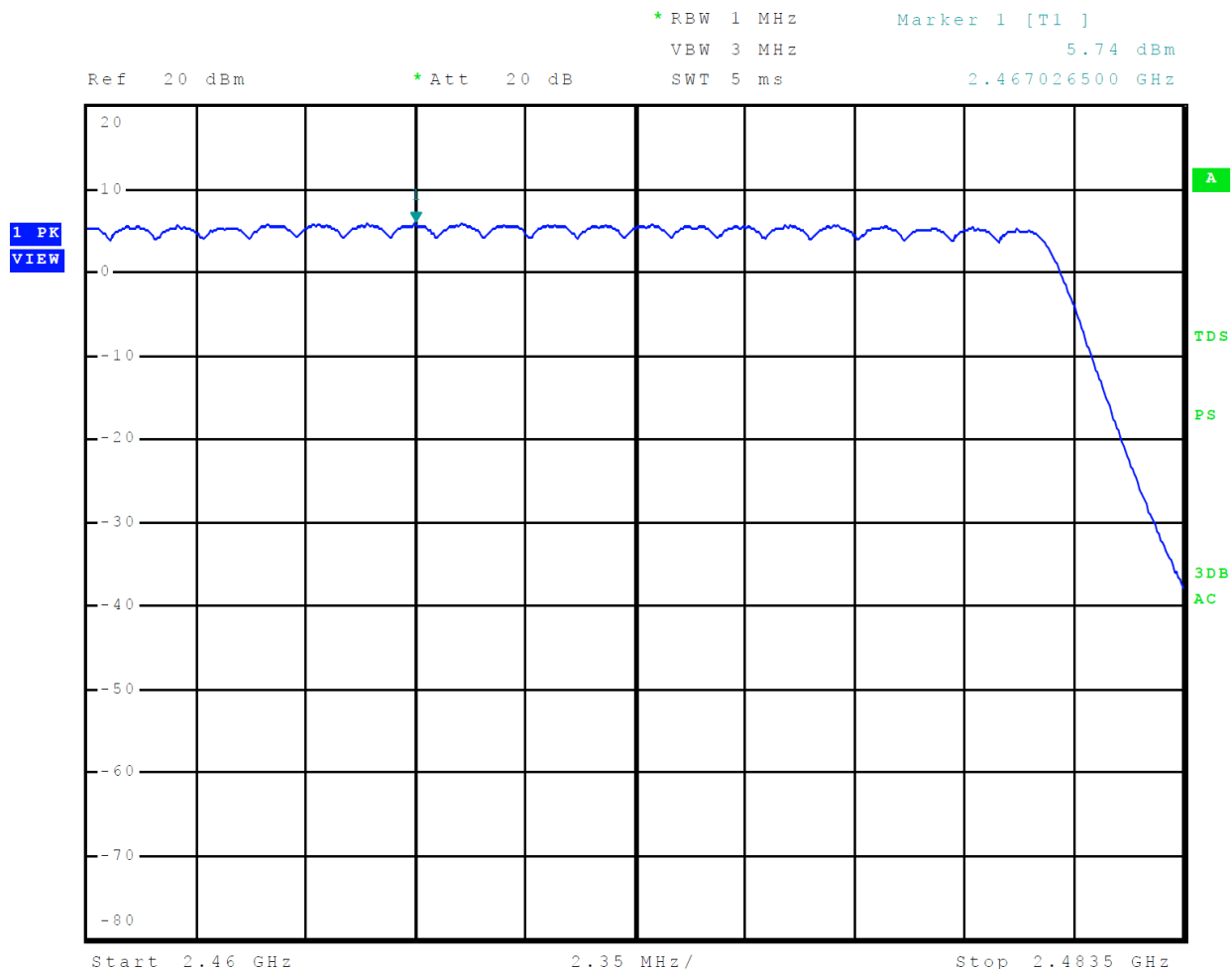

Figure 12 Plot of Channel Separation Mode 1 BT BR

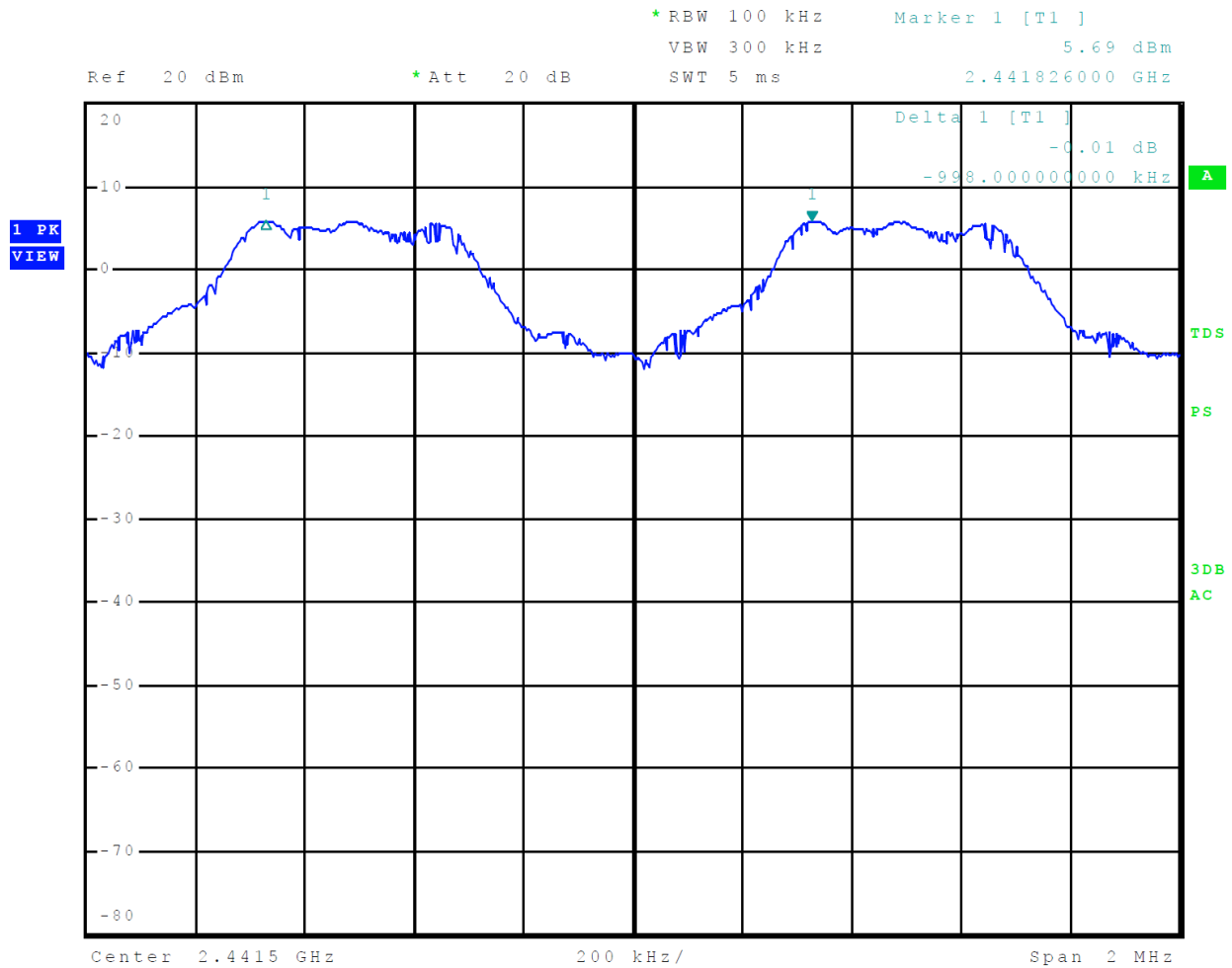

Figure 13 Plot of Dwell time On Channel Mode 1 BT BR

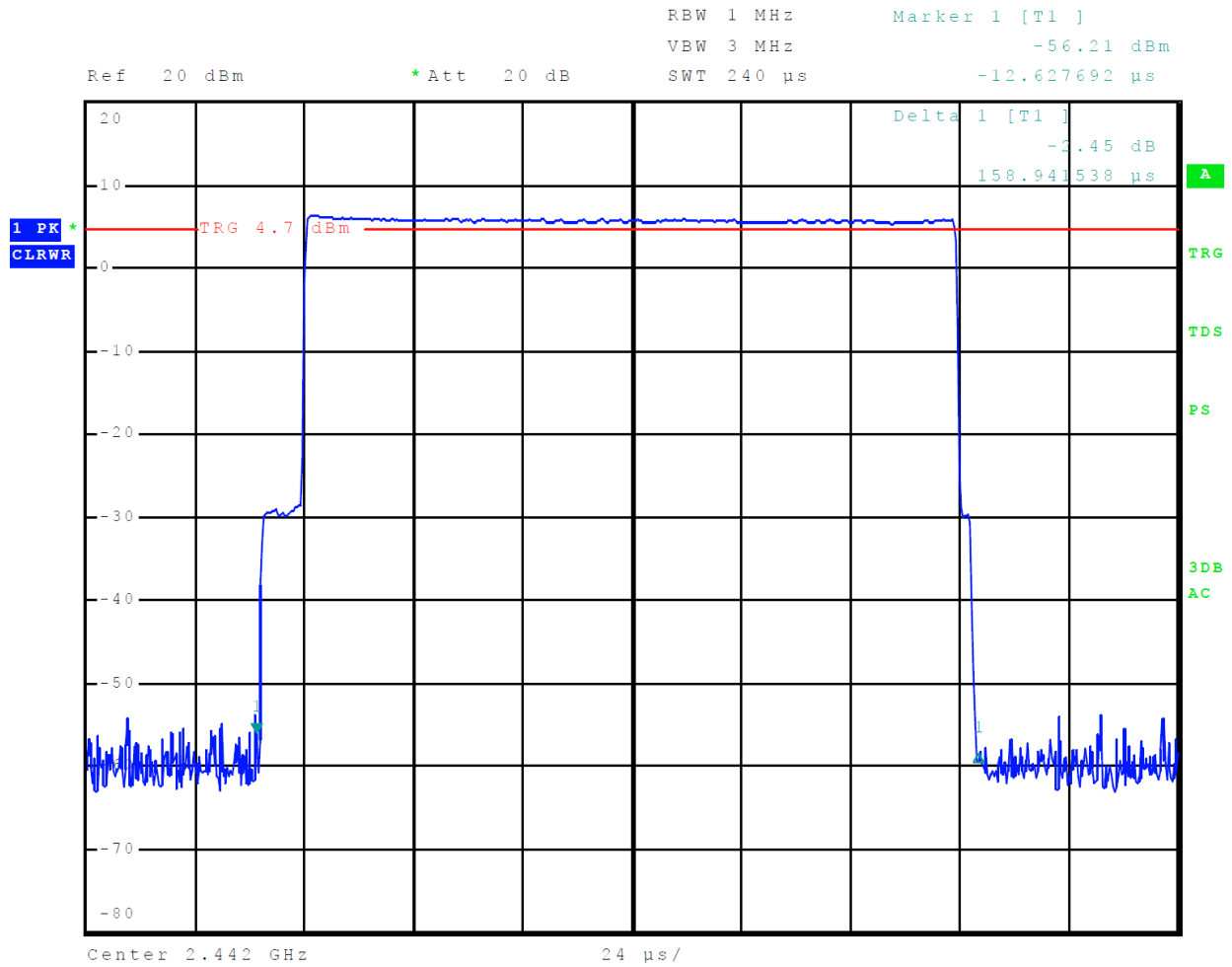



Figure 14 Plot of Number of Times on Channel over 10 Second Period Mode 1 BT BR

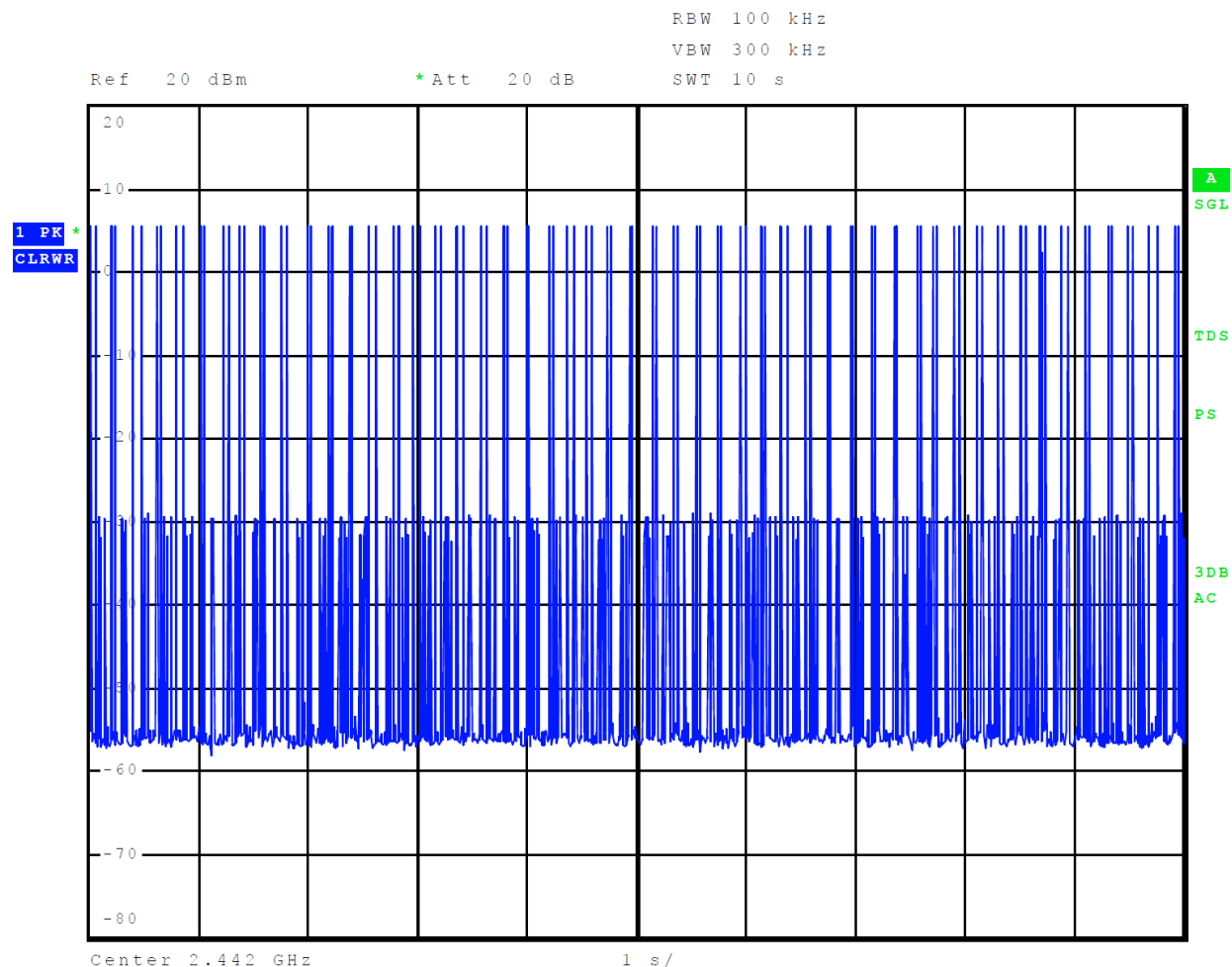

Figure 15 Plot of Transmitter Emissions Low Band Edge Mode 1 BT BR

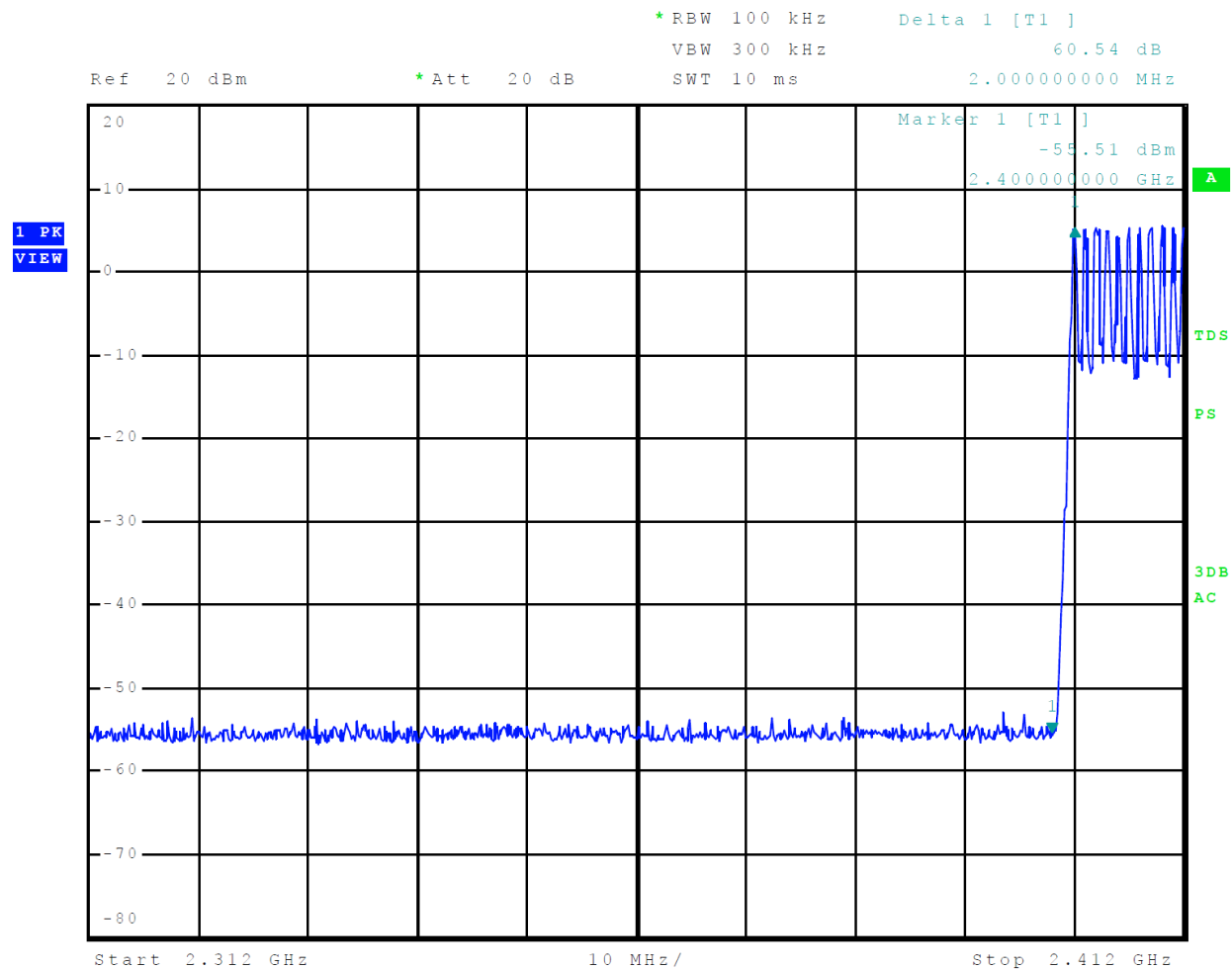
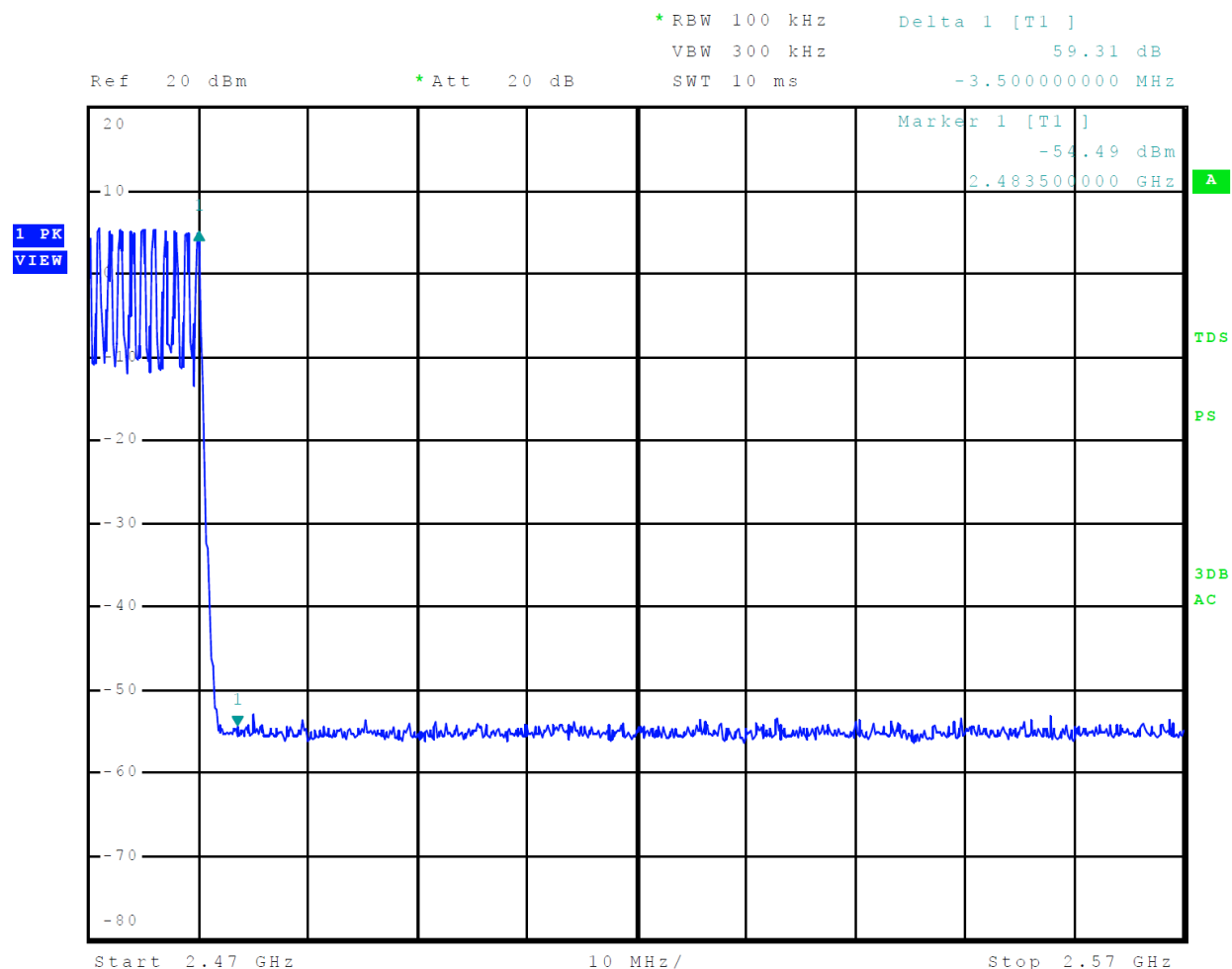

Figure 16 Plot of Transmitter Emissions High Band Edge Mode 1 BT BR



Transmitter Emissions Data

Table 7 Transmitter Radiated Emissions Mode 1 BT BR

Frequency in MHz	Horizontal Peak (dBµV/m)	Horizontal Average (dBµV/m)	Vertical Peak (dBµV/m)	Vertical Average (dBµV/m)	Limit @ 3m (dBµV/m)	Horizontal Margin (dB)	Vertical Margin (dB)
2402.0	--	--	--	--	--	--	--
4804.0	49.6	37.2	49.9	37.1	54.0	-16.8	-16.9
7206.0	53.3	40.7	53.8	41.6	54.0	-13.3	-12.4
9608.0	56.2	43.6	56.1	43.5	54.0	-10.4	-10.5
12010.0	58.6	45.9	59.2	45.9	54.0	-8.1	-8.1
14412.0	60.2	47.6	60.4	47.6	54.0	-6.4	-6.4
16814.0	64.7	51.2	64.3	51.6	54.0	-2.8	-2.4
2441.0	--	--	--	--	--	--	--
4882.0	50.5	38.9	49.1	36.5	54.0	-15.1	-17.5
7323.0	56.3	44.4	54.8	43.2	54.0	-9.6	-10.8
9764.0	57.1	43.8	56.2	43.7	54.0	-10.2	-10.3
12205.0	60.2	47.5	60.2	47.0	54.0	-6.5	-7.0
14646.0	60.4	47.8	60.6	48.1	54.0	-6.2	-5.9
17087.0	64.2	51.2	63.8	51.2	54.0	-2.8	-2.8
2480.0	--	--	--	--	--	--	--
4960.0	50.6	39.1	50.1	36.8	54.0	-14.9	-17.2
7440.0	54.8	43.7	54.8	43.0	54.0	-10.3	-11.0
9920.0	56.9	43.9	56.5	43.7	54.0	-10.1	-10.3
12400.0	60.0	46.8	60.4	46.8	54.0	-7.2	-7.2
14880.0	60.3	47.5	60.8	47.6	54.0	-6.5	-6.4
17360.0	63.5	50.5	63.3	50.6	54.0	-3.5	-3.4

Other emissions present had amplitudes at least 20 dB below the limit. Peak and Quasi-Peak amplitude emissions are recorded for frequency range below 1000 MHz. Peak and Average amplitude emissions are recorded for frequency range above 1000 MHz.

Rogers Labs, Inc.
 4405 West 259th Terrace
 Louisburg, KS 66053
 Phone/Fax: (913) 837-3214
 Revision 1

Garmin International, Inc.
 Model: A04622
 Test: 220304
 Test to: 47CFR 15C, RSS-Gen RSS-247
 File: A04622 DSS TstRpt 220304

SN's: 3403386859 / 3403386735
 FCC ID: IPH-04622
 IC: 1792A-04622
 Date: June 21, 2022
 Page 43 of 50

Table 8 Transmitter Antenna Port Conducted Data Mode 1 BT BR

Frequency MHz	Antenna Port Average Output Power (Watts)	99% Occupied Bandwidth (kHz)	20-dB Occupied Bandwidth (kHz)
Mode 1 BT BR			
2402	0.008	931.5	2,442.5
2441	0.010	933.8	2,445.0
2480	0.008	935.3	2,441.3

Summary of Results for Transmitter Radiated Emissions of Intentional Radiator

The EUT demonstrated compliance with the radiated emissions requirements of 47CFR Paragraph 15.247, Industry Canada RSS-247 Issue 2, and RSS-GEN Issue 5. The antenna port conducted output power measured was 0.010 Watts. The unit utilizes 79 hopping channels with the average time of occupancy less than 0.4 seconds over the required time. The EUT worst-case configuration demonstrated minimum radiated harmonic emission margin of -2.4 dB below the limit. No other radiated emissions were found in the restricted bands less than 20 dB below limits than those recorded in this report. Other emissions were present with amplitudes at least 20 dB below the limits.

Annex

- Annex A Measurement Uncertainty Calculations
- Annex B Test Equipment
- Annex C Rogers Qualifications
- Annex D Laboratory Certificate of Accreditation

Annex A Measurement Uncertainty Calculations

The measurement uncertainty was calculated for all measurements listed in this test report according To CISPR 16–4. Result of measurement uncertainty calculations are recorded below. Component and process variability of production devices similar to those tested may result in additional deviations. The manufacturer has the sole responsibility of continued compliance.

Measurement	Expanded Measurement Uncertainty $U_{(lab)}$
3 Meter Horizontal 0.009-1000 MHz Measurements	4.16
3 Meter Vertical 0.009-1000 MHz Measurements	4.33
3 Meter Measurements 1-18 GHz	5.14
3 Meter Measurements 18-40 GHz	5.16
10 Meter Horizontal Measurements 0.009-1000 MHz	4.15
10 Meter Vertical Measurements 0.009-1000 MHz	4.32
AC Line Conducted	1.75
Antenna Port Conducted power	1.17
Frequency Stability	1.00E-11
Temperature	1.6°C
Humidity	3%

Annex B Test Equipment

<u>Equipment</u>	<u>Manufacturer</u>	<u>Model (SN)</u>	<u>Band</u>	<u>Cal Date(m/d/y) Due</u>	
<input checked="" type="checkbox"/> LISN	FCC	FCC-LISN-50-25-10(1PA) (160611)	.15-30MHz	3/29/2022	3/29/2023
<input checked="" type="checkbox"/> LISN: Fischer Custom Communications Model:		FCC-LISN-50-16-2-08		3/29/2022	3/29/2023
<input checked="" type="checkbox"/> Cable	Huber & Suhner Inc.	Sucoflex102ea(L10M)(303073)	9kHz-40 GHz	10/14/2021	10/14/2022
<input type="checkbox"/> Cable	Huber & Suhner Inc.	Sucoflex102ea(1.5M)(303069)	9kHz-40 GHz	10/14/2021	10/14/2022
<input checked="" type="checkbox"/> Cable	Huber & Suhner Inc.	Sucoflex102ea(1.5M)(303070)	9kHz-40 GHz	10/14/2021	10/14/2022
<input checked="" type="checkbox"/> Cable	Belden	RG-58 (L1-CAT3-11509)	9kHz-30 MHz	10/14/2021	10/14/2022
<input type="checkbox"/> Cable	Belden	RG-58 (L2-CAT3-11509)	9kHz-30 MHz	10/14/2021	10/14/2022
<input checked="" type="checkbox"/> Antenna	Com Power	AL-130 (121055)	.001-30 MHz	10/14/2021	10/14/2022
<input type="checkbox"/> Antenna:	EMCO	6509	.001-30 MHz	10/14/2020	10/14/2022
<input type="checkbox"/> Antenna	ARA	BCD-235-B (169)	20-350MHz	10/14/2021	10/14/2022
<input type="checkbox"/> Antenna:	Schwarzbeck Model	VHBB 9124 (1468)	30-200MHz	10/14/2020	10/14/2022
<input checked="" type="checkbox"/> Antenna	Sunol	JB-6 (A100709)	30-1000 MHz	10/14/2021	10/14/2022
<input type="checkbox"/> Antenna	ETS-Lindgren	3147 (40582)	200-1000MHz	10/14/2020	10/14/2022
<input type="checkbox"/> Antenna:	Schwarzbeck Model:	VULP 9118 (A-534)	200-1000MHz	10/14/2020	10/14/2022
<input checked="" type="checkbox"/> Antenna	ETS-Lindgren	3117 (200389)	1-18 GHz	4/21/2020	4/21/2022
<input type="checkbox"/> Antenna	Com Power	AH-118 (10110)	1-18 GHz	10/14/2020	10/14/2022
<input checked="" type="checkbox"/> Antenna	Com Power	AH-840 (101046)	18-40 GHz	4/6/2021	4/6/2023
<input checked="" type="checkbox"/> Analyzer	Rohde & Schwarz	ESU40 (100108)	20Hz-40GHz	3/9/2022	3/9/2023
<input checked="" type="checkbox"/> Analyzer	Rohde & Schwarz	ESW44 (101534)	20Hz-44GHz	1/18/2022	1/18/2023
<input type="checkbox"/> Analyzer	Rohde & Schwarz	FS-Z60, 90, 140, and 220	40GHz-220GHz	12/22/2017	12/22/2027
<input checked="" type="checkbox"/> Amplifier	Com-Power	PA-010 (171003)	100Hz-30MHz	10/14/2021	10/14/2022
<input checked="" type="checkbox"/> Amplifier	Com-Power	CPPA-102 (01254)	1-1000 MHz	10/14/2021	10/14/2022
<input checked="" type="checkbox"/> Amplifier	Com-Power	PAM-118A (551014)	0.5-18 GHz	10/14/2021	10/14/2022
<input checked="" type="checkbox"/> Amplifier	Com-Power	PAM-840A (461328)	18-40 GHz	10/14/2021	10/14/2022
<input checked="" type="checkbox"/> Power Meter	Agilent	N1911A with N1921A	0.05-40 GHz	3/29/2022	3/29/2023
<input type="checkbox"/> Generator	Rohde & Schwarz	SMB100A6 (100150)	20Hz-6 GHz	3/29/2022	3/29/2023
<input type="checkbox"/> Generator	Rohde & Schwarz	SMBV100A6 (260771)	20Hz-6 GHz	3/29/2022	3/29/2023
<input type="checkbox"/> RF Filter	Micro-Tronics	BRC50722 (009).9G notch	30-18000 MHz	4/6/2021	4/6/2023
<input type="checkbox"/> RF Filter	Micro-Tronics	HPM50114 (017)1.5G HPF	30-18000 MHz	4/6/2021	4/6/2023
<input checked="" type="checkbox"/> RF Filter	Micro-Tronics	HPM50117 (063) 3G HPF	30-18000 MHz	4/6/2021	4/6/2023
<input checked="" type="checkbox"/> RF Filter	Micro-Tronics	HPM50105 (059) 6G HPF	30-18000 MHz	4/6/2021	4/6/2023
<input checked="" type="checkbox"/> RF Filter	Micro-Tronics	BRM50702 (172) 2G notch	30-18000 MHz	4/6/2021	4/6/2023
<input checked="" type="checkbox"/> RF Filter	Micro-Tronics	BRC50703 (G102) 5G notch	30-18000 MHz	4/6/2021	4/6/2023
<input type="checkbox"/> RF Filter	Micro-Tronics	BRC50705 (024) 5G notch	30-18000 MHz	4/6/2021	4/6/2023
<input type="checkbox"/> Attenuator	Fairview	SA6NFN100W-40 (1625)	30-18000 MHz	3/29/2022	3/29/2023
<input checked="" type="checkbox"/> Attenuator	Mini-Circuits	VAT-3W2+ (1436)	30-6000 MHz	3/29/2022	3/29/2023
<input checked="" type="checkbox"/> Attenuator	Mini-Circuits	VAT-3W2+ (1445)	30-6000 MHz	3/29/2022	3/29/2023
<input type="checkbox"/> Attenuator	Mini-Circuits	VAT-3W2+ (1735)	30-6000 MHz	3/29/2022	3/29/2023
<input type="checkbox"/> Attenuator	Mini-Circuits	VAT-6W2+ (1438)	30-6000 MHz	3/29/2022	3/29/2023
<input type="checkbox"/> Attenuator	Mini-Circuits	VAT-6W2+ (1736)	30-6000 MHz	3/29/2022	3/29/2023
<input checked="" type="checkbox"/> Weather station	Davis	6312 (A81120N075)		11/4/2021	11/4/2022

Rogers Labs, Inc.
 4405 West 259th Terrace
 Louisburg, KS 66053
 Phone/Fax: (913) 837-3214
 Revision 1

Garmin International, Inc.
 Model: A04622
 Test: 220304
 Test to: 47CFR 15C, RSS-Gen RSS-247
 File: A04622 DSS TstRpt 220304

SN's: 3403386859 / 3403386735
 FCC ID: IPH-04622
 IC: 1792A-04622
 Date: June 21, 2022
 Page 47 of 50

List of Test Equipment

Calibration Date (m/d/y) Due

<input type="checkbox"/>	Antenna:	Schwarzbeck Model VHBB 9124 (01468)	10/14/2020	10/14/2022
<input type="checkbox"/>	Antenna:	Schwarzbeck Model: VULP 9118 A (VULP 9118 A-856)	10/14/2020	10/14/2022
<input type="checkbox"/>	Frequency Counter:	Leader LDC-825 (8060153)	3/29/2022	4/6/2023
<input type="checkbox"/>	ISN: Com-Power Model	ISN T-8	3/29/2022	3/29/2023
<input type="checkbox"/>	LISN	Compliance Design FCC-LISN-2.Mod.cd,(126) .15-30MHz	10/14/2021	10/14/2022
<input type="checkbox"/>	LISN: Com-Power Model	LI-220A	10/14/2020	10/14/2022
<input type="checkbox"/>	LISN: Com-Power Model	LI-550C	10/14/2020	10/14/2022
<input type="checkbox"/>	Cable	Huber & Suhner Inc. Sucoflex102ea(1.5M)(303072) 9kHz-40 GHz	10/14/2021	10/14/2022
<input type="checkbox"/>	Cable	Huber & Suhner Inc. Sucoflex102ea(L1M)(281183) 9kHz-40 GHz	10/14/2021	10/14/2022
<input type="checkbox"/>	Cable	Huber & Suhner Inc. Sucoflex102ea(L4M)(281184) 9kHz-40 GHz	10/14/2021	10/14/2022
<input type="checkbox"/>	Cable	Huber & Suhner Inc. Sucoflex102ea(L10M)(317546)9kHz-40 GHz	10/14/2021	10/14/2022
<input type="checkbox"/>	Cable	Time Microwave 4M-750HF290-750 (4M) 9kHz-24 GHz	10/14/2021	10/14/2022
<input type="checkbox"/>	RF Filter	Micro-Tronics BRC17663 (001) 9.3-9.5 notch 30-1800 MHz	4/6/2021	4/6/2023
<input type="checkbox"/>	RF Filter	Micro-Tronics BRC19565 (001) 9.2-9.6 notch 30-1800 MHz	10/14/2021	10/14/2023
<input type="checkbox"/>	Analyzer	HP 8562A (3051A05950) 9kHz-125GHz	3/29/2022	3/29/2023
<input type="checkbox"/>	Wave Form Generator	Keysight 33512B (MY57400128)	3/29/2022	3/29/2023
<input type="checkbox"/>	Antenna:	Solar 9229-1 & 9230-1	2/22/2022	2/22/2023
<input type="checkbox"/>	CDN: Com-Power Model	CDN325E	10/14/2021	10/14/2022
<input type="checkbox"/>	Injection Clamp	Luthi Model EM101	10/14/2021	10/14/2022
<input type="checkbox"/>	Oscilloscope Scope:	Tektronix MDO 4104	2/22/2022	2/22/2023
<input type="checkbox"/>	EMC Transient Generator	HVT TR 3000	2/22/2022	2/22/2023
<input type="checkbox"/>	AC Power Source (Ametech, California Instruments)		2/22/2022	2/22/2023
<input type="checkbox"/>	Field Intensity Meter:	EFM-018	2/22/2022	2/22/2023
<input type="checkbox"/>	ESD Simulator:	MZ-15	2/22/2022	2/22/2023
<input type="checkbox"/>	R.F. Power Amp	ACS 230-50W		not required
<input type="checkbox"/>	R.F. Power Amp	EIN Model: A301		not required
<input type="checkbox"/>	R.F. Power Amp	A.R. Model: 10W 1010M7		not required
<input type="checkbox"/>	R.F. Power Amp	A.R. Model: 50U1000		not required
<input type="checkbox"/>	Temperature Chamber			not required
<input checked="" type="checkbox"/>	Shielded Room			not required

Annex C Rogers Qualifications

Scot D. Rogers, Engineer

Rogers Labs, Inc.

Mr. Rogers has approximately 35 years' experience in the field of electronics. Working experience includes six years working in the automated controls industry and 6 years working with the design, development and testing of radio communications and electronic equipment.

Positions Held:

Systems Engineer: A/C Controls Mfg. Co., Inc.

Electrical Engineer: Rogers Consulting Labs, Inc.

Electrical Engineer: Rogers Labs, Inc. Current

Educational Background:

Bachelor of Science Degree in Electrical Engineering from Kansas State University

Bachelor of Science Degree in Business Administration Kansas State University

Several Specialized Training courses and seminars pertaining to Microprocessors and Software programming

Annex D Laboratory Certificate of Accreditation

United States Department of Commerce
National Institute of Standards and Technology



Certificate of Accreditation to ISO/IEC 17025:2017

NVLAP LAB CODE: 200087-0

Rogers Labs, Inc.
Louisburg, KS

*is accredited by the National Voluntary Laboratory Accreditation Program for specific services,
listed on the Scope of Accreditation, for:*

Electromagnetic Compatibility & Telecommunications

*This laboratory is accredited in accordance with the recognized International Standard ISO/IEC 17025:2017.
This accreditation demonstrates technical competence for a defined scope and the operation of a laboratory quality
management system (refer to joint ISO-ILAC-IAF Communiqué dated January 2009).*

2022-03-22 through 2023-03-31
Effective Dates

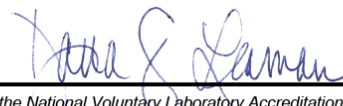

For the National Voluntary Laboratory Accreditation Program

Rogers Labs, Inc.
4405 West 259th Terrace
Louisburg, KS 66053
Phone/Fax: (913) 837-3214
Revision 1

Garmin International, Inc.
Model: A04622
Test: 220304
Test to: 47CFR 15C, RSS-Gen RSS-247
File: A04622 DSS TstRpt 220304

SN's: 3403386859 / 3403386735
FCC ID: IPH-04622
IC: 1792A-04622
Date: June 21, 2022
Page 50 of 50