

ROGERS LABS, INC.

4405 West 259th Terrace
Louisburg, KS 66053
Phone / Fax (913) 837-3214

Unlicensed National Information Infrastructure (U-NII) and License-Exempt Local Area Network (LE-LAN) Devices, 47CFR, Part 15E (15.407) Industry Canada RSS-247 Issue 2 Application For Grant of Certification

Model: A04577

Frequency Range: 5180-5240, and 5745-5825 MHz
License-Exempt U-NII, Local Area Network equipment, U-NII-1, and U-NII-3 operation

FCC ID: IPH-04577

IC: 1792A-04577

Garmin International, Inc.

1200 East 151st Street
Olathe, KS 66062

FCC Designation: US5305
ISED Registration: 3041A

Test Report Number: 221013

Test Date: October 13, 2022

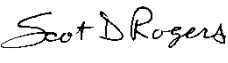
Authorized Signatory: 
Scot D. Rogers

This report shall not be reproduced except in full, without the written approval of the laboratory.
This report must not be used by the client to claim product certification, approval, or
endorsement by NVLAP, NIST, or any agency of the U.S. Government.

Rogers Labs, Inc.
4405 West 259th Terrace
Louisburg, KS 66053
Phone/Fax: (913) 837-3214
Revision r2

Garmin International, Inc.
Model: A04577
Test: 221013
Test to: 47CFR 15E, RSS-Gen RSS-247
File: A04577 NII TstRpt 221013 r2

SN's: 3432729295 / 3432729465
FCC ID: IPH-04577
IC: 1792A-04577
Date: March 9, 2023
Page 1 of 98

TABLE OF CONTENTS..... 2

REVISIONS..... 5

EXECUTIVE SUMMARY 6

OPINION / INTERPRETATION OF RESULTS 7

EQUIPMENT TESTED..... 8

Equipment Operational Modes.....9

Equipment Function10

Equipment Configuration.....11

APPLICANT COMPANY INFORMATION 12

EQUIPMENT INFORMATION..... 12

Product Details13

Antenna and Bandwidth.....13

APPLICATION FOR CERTIFICATION..... 14

APPLICABLE STANDARDS & TEST PROCEDURES 15

TESTING PROCEDURES 15

Radiated Emission Test Procedure.....15

Antenna Port Conducted Emission Test Procedure.....16

 Diagram 1 Test arrangement for Conducted emissions17

 Diagram 2 Test arrangement for radiated emissions of tabletop equipment.....18

 Diagram 3 Test arrangement for radiated emissions tested on Open Area Test Site (OATS).....19

 Diagram 4 Test arrangement for Antenna Port Conducted emissions20

TEST SITE LOCATIONS 20

UNITS OF MEASUREMENTS 21

ENVIRONMENTAL CONDITIONS..... 21

STATEMENT OF MODIFICATIONS AND DEVIATIONS 21

INTENTIONAL RADIATORS..... 22

Antenna Requirements22

Restricted Bands of Operation.....22

Table 1 Harmonic Radiated Emissions in Restricted Bands Data Mode 9, U-NII-1 (802.11a).....23

Table 2 Harmonic Radiated Emissions in Restricted Bands Data Mode 10, U-NII-1 (802.11n)24

Table 3 Harmonic Radiated Emissions in Restricted Bands Data Mode 11, U-NII-1 (802.11n40)25

Table 4 Harmonic Radiated Emissions in Restricted Bands Data Mode 12, U-NII-3 (802.11a).....25

Table 5 Harmonic Radiated Emissions in Restricted Bands Data Mode 13, U-NII-3 (802.11n)26

Table 6 Harmonic Radiated Emissions in Restricted Bands Data Mode 14, U-NII-3 (802.11n40)26

Table 7 Harmonic Radiated Emissions in Restricted Bands Data Mode 15, U-NII-1 (802.11ac80).....27

Table 8 Harmonic Radiated Emissions in Restricted Bands Data Mode 16, U-NII-3 (802.11ac80).....27

Summary of Results for Radiated Emissions in Restricted Bands27

AC Line Conducted EMI Procedure28

Figure 1 AC Line Conducted emissions of EUT Configuration #2 line 1 (EUT – AC Adapter)29

Figure 2 AC Line Conducted emissions of EUT Configuration #2 line 2 (EUT – AC Adapter)30

Figure 3 AC Line Conducted emissions of EUT Configuration #3 line 1 (EUT – CPU).....31

Figure 4 AC Line Conducted emissions of EUT Configuration #3 line 2 (EUT – CPU).....32

Table 9 AC Line Conducted Emissions Configuration #2 Data L1 (EUT – AC Adapter).....33

Table 10 AC Line Conducted Emissions Configuration #2 Data L2 (EUT – AC Adapter)33

Table 11 AC Line Conducted Emissions Configuration #3 Data L1 (EUT – CPU).....34

Table 12 AC Line Conducted Emissions Configuration #3 Data L2 (EUT – CPU).....34

Summary of Results for AC Line Conducted Emissions34

General Radiated Emissions Procedure.....35

Table 13 General Radiated Emissions Data.....35

Summary of Results for General Radiated Emissions36

Operation in the 5150-5250 and 5725-5850 MHz Frequency U-NII-1 and U-NII-3 Bands36

Figure 5 Plot of Transmitter Emissions Across 5150-5250 MHz Mode 9, U-NII-1 (802.11a)40

Figure 6 Plot of Transmitter Emissions Across 5150-5250 MHz Mode 10, U-NII-1 (802.11n)41

Figure 7 Plot of Transmitter Emissions Across 5150-5250 MHz Mode 11, U-NII-1 (802.11n40)42

Figure 8 Plot of Lower Band Edge Across 5150-5250 MHz Mode 9, U-NII-1 (802.11a)43

Figure 9 Plot of Lower Band Edge Across 5150-5250 MHz Mode 10, U-NII-1 (802.11n).....44

Figure 10 Plot of Lower Band Edge Across 5150-5250 MHz Mode 11, U-NII-1 (802.11n40).....45

Figure 11 Plot of Upper Band Edge Across 5150-5250 MHz Mode 9, U-NII-1 (802.11a).....46

Figure 12 Plot of Upper Band Edge Across 5150-5250 MHz Mode 10, U-NII-1 (802.11n)47

Figure 13 Plot of Upper Band Edge Across 5150-5250 MHz Mode 11, U-NII-1 (802.11n40)48

Figure 14 Plot of 26-dB Occupied Bandwidth 5150-5250 MHz Mode 9, U-NII-1 (802.11a).....49

Figure 15 Plot of 26-dB Occupied Bandwidth 5150-5250 MHz Mode 10, U-NII-1 (802.11n)50

Figure 16 Plot of 26-dB Occupied Bandwidth 5150-5250 MHz Mode 11, U-NII-1 (802.11n40)51

Figure 17 Plot of 99% Occupied Bandwidth 5150-5250 MHz Mode 9, U-NII-1 (802.11a)52

Figure 18 Plot of 99% Occupied Bandwidth 5150-5250 MHz Mode 10, U-NII-1 (802.11n)53

Figure 19 Plot of 99% Occupied Bandwidth 5150-5250 MHz Mode 11, U-NII-1 (802.11n40)54

Figure 20 Plot of Transmitter Emissions Across 5725-5850 MHz Mode 12, U-NII-3 (802.11a)55

Figure 21 Plot of Transmitter Emissions Across 5725-5850 MHz Mode 13, U-NII-3 (802.11n)56

Figure 22 Plot of Transmitter Emissions Across 5725-5850 MHz Mode 14, U-NII-3 (802.11n40)57

Figure 23 Plot of Lower Band Edge Across 5725-5850 MHz Mode 12, U-NII-3 (802.11a)58

Figure 24 Plot of Lower Band Edge Across 5725-5850 MHz Mode 13, U-NII-3 (802.11n)59

Figure 25 Plot of Lower Band Edge Across 5725-5850 MHz Mode 14, U-NII-3 (802.11n40)60

Figure 26 Plot of Upper Band Edge Across 5725-5850 MHz Mode 12, U-NII-3 (802.11a).....61

Figure 27 Plot of Upper Band Edge Across 5725-5850 MHz Mode 13, U-NII-3 (802.11n)62

Figure 28 Plot of Upper Band Edge Across 5725-5850 MHz Mode 14, U-NII-3 (802.11n40)63

Figure 29 Plot of 99% Occupied Bandwidth 5725-5850 MHz Mode 12, U-NII-3 (802.11a)64

Figure 30 Plot of 99% Occupied Bandwidth 5725-5850 MHz Mode 13, U-NII-3 (802.11n)65

Figure 31 Plot of 99% Occupied Bandwidth 5725-5850 MHz Mode 14, U-NII-3 (802.11n40)66

Figure 32 Plot of 6-dB Occupied Bandwidth 5725-5850 MHz Mode 12, U-NII-3 (802.11a).....67

Figure 33 Plot of 6-dB Occupied Bandwidth 5725-5850 MHz Mode 13, U-NII-3 (802.11n)68

Figure 34 Plot of 6-dB Occupied Bandwidth 5725-5850 MHz Mode 14, U-NII-3 (802.11n40)69

Figure 35 Plot of 26-dB Occupied Bandwidth 5725-5850 MHz Mode 12, U-NII-3 (802.11a).....70

Figure 36 Plot of 26-dB Occupied Bandwidth 5725-5850 MHz Mode 13, U-NII-3 (802.11n)71

Figure 37 Plot of 26-dB Occupied Bandwidth 5725-5850 MHz Mode 14, U-NII-3 (802.11n40)72

Figure 38 Plot of Transmitter Emissions Across 5150-5250 MHz Mode 15, U-NII-1 (802.11ac80).....73

Figure 39 Plot of Lower Band Edge Across 5150-5250 MHz Mode 9, U-NII-1 (802.11a)74

Figure 40 Plot of Upper Band Edge Across 5150-5250 MHz Mode 9, U-NII-1 (802.11a).....75

Figure 41 Plot of 26-dB Occupied Bandwidth 5150-5250 MHz Mode 9, U-NII-1 (802.11a).....76

Figure 42 Plot of 99% Occupied Bandwidth 5150-5250 MHz Mode 9, U-NII-1 (802.11a)77

Figure 43 Plot of Transmitter Emissions Across 5725-5850 MHz Mode 12, U-NII-3 (802.11a)78

Figure 44 Plot of Lower Band Edge Across 5725-5850 MHz Mode 12, U-NII-3 (802.11a)79



NVLAP Lab Code 200087-0

Figure 45 Plot of Upper Band Edge Across 5725-5850 MHz Mode 12, U-NII-3 (802.11a)..... 80

Figure 46 Plot of 99% Occupied Bandwidth 5725-5850 MHz Mode 12, U-NII-3 (802.11a) 81

Figure 47 Plot of 6-dB Occupied Bandwidth 5725-5850 MHz Mode 12, U-NII-3 (802.11a)..... 82

Transmitter Emissions Data..... 83

Table 14 Transmitter Radiated Emission 5150-5250 MHz Band, Mode 9, U-NII-1 (802.11a) 83

Table 15 Transmitter Radiated Emission 5150-5250 MHz Band, Mode 10, U-NII-1 (802.11n) 84

Table 16 Transmitter Radiated Emission 5150-5250 MHz Band, Mode 11, U-NII-1 (802.11n40) 85

Table 17 Transmitter Radiated Emission 5725-5850 MHz Band, Mode 12, U-NII-3 (802.11a) 86

Table 18 Transmitter Radiated Emission 5725-5850 MHz Band, Mode 13, U-NII-3 (802.11n) 87

Table 19 Transmitter Radiated Emission 5725-5850 MHz Band, Mode 14, U-NII-3 (802.11n40) 88

Table 20 Transmitter Radiated Emission 5150-5250 MHz Band, Mode 15, U-NII-1 (802.11ac80)..... 89

Table 21 Transmitter Radiated Emission 5725-5850 MHz Band, Mode 16, U-NII-3 (802.11ac80)..... 90

Table 22 Transmitter Antenna Port Data Modes 9, 10, 11, & 15, (U-NII-1)..... 91

Table 23 Transmitter Antenna Port Data Modes 12, 13, 14, & 16, (U-NII-3)..... 92

Summary of Results for Transmitter Radiated Emissions of Intentional Radiator 92

ANNEX..... 93

Annex A Measurement Uncertainty Calculations..... 94

Annex B Test Equipment..... 95

Annex C Rogers Qualifications 97

Annex D Laboratory Certificate of Accreditation..... 98

Revisions

Revision 2 Issued March 9, 2023 – updated to add U-NII-1 and U-NII-3 channels 42 and 156 (802.11ac80), pages impacted include: 6, 9, 13, 27 (tables 7 and 8), 73-82 (Figures 38-47), 89, 90 (tables 20 and 21), 91, 92 (tables 22 and 23)

Revision 1 Issued January 5, 2023

Rogers Labs, Inc.
4405 West 259th Terrace
Louisburg, KS 66053
Phone/Fax: (913) 837-3214
Revision r2

Garmin International, Inc.
Model: A04577
Test: 221013
Test to: 47CFR 15E, RSS-Gen RSS-247
File: A04577 NII TstRpt 221013 r2

SN's: 3432729295 / 3432729465
FCC ID: IPH-04577
IC: 1792A-04577
Date: March 9, 2023
Page 5 of 98

Executive Summary

The following information is submitted for consideration in obtaining Equipment Grants of Certification for License Exempt, Unlicensed National Information Infrastructure (U-NII) Intentional Radiator operating under 47 CFR Paragraph 15E (15.407), U-NII-1 and U-NII-3 new rules, 5180-5240, and 5745-5825 MHz bands, and Industry Canada RSS-GEN Issue 5, and RSS-247 Issue 2, LE-LAN transmitter.

Name of Applicant: Garmin International, Inc.
1200 East 151st Street
Olathe, KS 66062

M/N: A04577 HVIN: A04577

FCC ID: IPH-04577 Industry Canada ID: 1792A-04577

Frequency Range: 5180-5240 MHz and 5745-5825 MHz (U-NII-1 and U-NII-3 under new rules 15.407, 802.11a/n/n40, ac80) and limited transmitter operations per regulations for operation in Canada

Mode	Channel width	Average Conducted Power (W)	Average e.r.i.p. Power (W)	99% OBW (kHz)
Mode 9, U-NII-1a	20 MHz mode	0.042	0.133	17,590.0
Mode 10, U-NII-1n	20 MHz mode	0.040	0.125	18,060.0
Mode 11, U-NII-1n40	40 MHz mode	0.042	0.132	37,675.0
Mode 12, U-NII-3a	20 MHz mode	0.022	0.070	17,170.0
Mode 13, U-NII-3n	20 MHz mode	0.021	0.067	17,870.0
Mode 14, U-NII-3n40	40 MHz mode	0.024	0.076	36,850.0
Mode 15, U-NII-1ac80	80 MHz mode	0.014	0.043	75,600.0
Mode 16, U-NII-3ac80	80 MHz mode	0.019	0.059	75,750.0

This report addresses EUT Operations as Digital Transmission System using transmitter modulations in modes 9 through 16. Note, the production device utilizes integral antenna systems with the 2.4 GHz PIFA providing 0 dBi gain, and 5 GHz PIFA providing 5 dBi gain.

Rogers Labs, Inc.
4405 West 259th Terrace
Louisburg, KS 66053
Phone/Fax: (913) 837-3214
Revision r2

Garmin International, Inc.
Model: A04577
Test: 221013
Test to: 47CFR 15E, RSS-Gen RSS-247
File: A04577 NII TstRpt 221013 r2

SN's: 3432729295 / 3432729465
FCC ID: IPH-04577
IC: 1792A-04577
Date: March 9, 2023
Page 6 of 98

Opinion / Interpretation of Results

Tests Performed	Margin (dB)	Results
Restricted Frequency Bands 15.205, RSS-GEN 8.10	-0.4	Complies
AC Line Conducted 15.207, RSS-GEN 7.2.4	-7.9	Complies
Radiated Emissions 15.209, RSS-GEN 7.2.5	-9.5	Complies
Harmonic Emissions per 15.407, RSS-247	-11.8	Complies



NVLAP Lab Code 200087-0

Equipment Tested

Model: A04577

Garmin International, Inc.
1200 East 151st Street
Olathe, KS 66062

<u>Equipment</u>	<u>Model / PN</u>	<u>Serial Number</u>
EUT (Radiated test sample, integral antenna)	A04577	3432729295
EUT2 (Modified with Antenna Port sample)	A04577	3432729465
USB cable (0.5-meter)	320-01545-10	N/A
USB cable (1.5-meter)	320-01563-00	N/A
Bare Power Cable	320-01599-00	N/A
Group ride radio (GRR)	010-01599-00	N/A
CLA	013-00971-00	N/A
AC Adapter	362-00096-00	N/A
DC Power Supply	BK 1745	209C13
Laptop Computer	Latitude 7480	EFSPSN2
USB Printer	Dell 0N5819	5D1SL61

Test results in this report relate only to the items tested. Worst-case configuration data recorded in this report.

Software: 0.58, Antennas: 2.4 GHz PIFA (0 dBi), 5 GHz PIFA (5 dBi)

Rogers Labs, Inc.
4405 West 259th Terrace
Louisburg, KS 66053
Phone/Fax: (913) 837-3214
Revision r2

Garmin International, Inc.
Model: A04577
Test: 221013
Test to: 47CFR 15E, RSS-Gen RSS-247
File: A04577 NII TstRpt 221013 r2

SN's: 3432729295 / 3432729465
FCC ID: IPH-04577
IC: 1792A-04577
Date: March 9, 2023
Page 8 of 98

Equipment Operational Modes

Mode	Transmitter Operation
1	ANT (GFSK)
2	BT BR (GFSK)
3	BT 2EDR ($\pi/4$ -DQPSK)
4	BT 3EDR (8DPSK)
5	BT BLE (GMSK)
6	802.11b (DSSS/CCK)
7	802.11g, (OFDM)
8	802.11n (MCS)
9	U-NII-1 802.11a
10	U-NII-1 802.11n
11	U-NII-1 802.11n40
12	U-NII-3 802.11a
13	U-NII-3 802.11n
14	U-NII-3 802.11n40
15	U-NII-1 802.11a80
16	U-NII-3 802.11a80

Equipment Function

The EUT is a GPS receiver with graphical display and user interface design. The unit provides GPS reception, graphical display of location, navigation, and other information for the user. The design offers use as a hand-held, transportation mounted or portable configuration for use in navigational applications. The design incorporates transmitter circuitry operating in the 2402-2480, 5150-5250, and 5725-5850 MHz frequency bands. The typical use configuration has the EUT mounted in a transportation vehicle and powered from the direct current vehicle power through direct, Cigarette Lights Adapter (CLA), or power mount interface cable. The design provides a Micro SD Card slot and USB-C interface port as presented below and wireless communications with compatible equipment. The EUT operates from direct current power provided from internal rechargeable battery or external power. External power may be supplied through the installation vehicles 12-volt power or compliant USB interface as documented this report. The EUT was arranged as described by the manufacturer emulating typical user configurations for testing purposes. The EUT offers no other interface connections than those presented in the configuration options as described by the manufacturer and presented below. For testing purposes, the EUT received power from both internal and external power options and configurations. During testing, the test system was configured to operate in a manufacturer defined mode. The manufacturer provided test software for testing transmitter and equipment function. The software provided ability to operate the transmitter at near 100% duty cycle for testing purposes. The testing mode of operation exceeds typical duty cycle operation of production equipment. As requested by the manufacturer the equipment was tested for emissions compliance using the available configurations with the worse-case data presented. Test results in this report relate only to the products described in this report.

Equipment Configuration

- 1) EUT operating off internal battery



- 2) EUT connected to (and powered by) AC adapter through USB cable

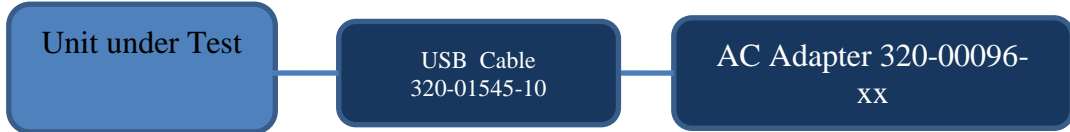

- 3) EUT connected to Computer Through USB cable

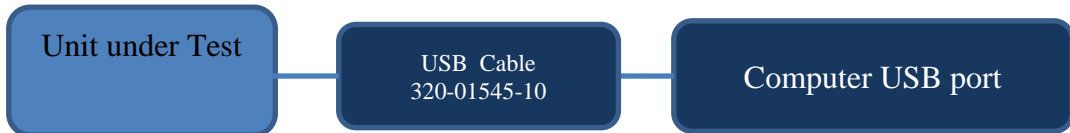

- 4) EUT connected to CLA Through USB cable

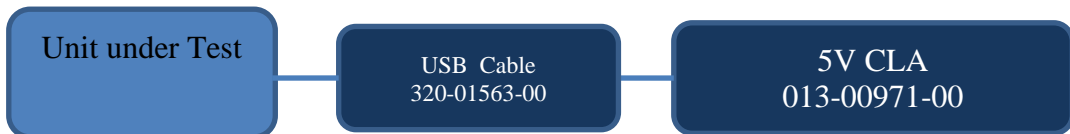

- 5) EUT connected to Bare wire power cable

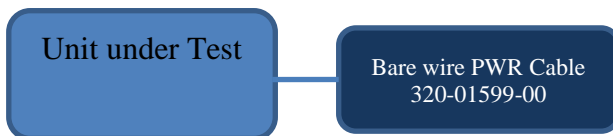

- 6) EUT connected to, and powered through Group Ride Radio

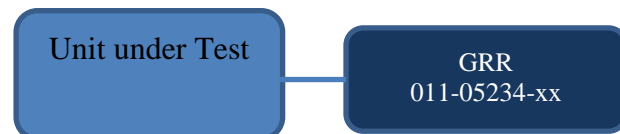

Applicant Company information

Applicants Company	Garmin International, Inc.
Applicants Address	1200 East 151st Street, Olathe, KS 66062
FCC Identifier	IPH-04577
Industry Canada Identifier	1792A-04577
Manufacturer Company	Garmin International, Inc.
Manufacturer Address	1200 East 151st Street, Olathe, KS 66062

Equipment information

Hardware Version Identification Number (HVIN): The HVIN identifies hardware specifications of a product version. The HVIN replaces the ISED Model Number in the legacy E-filing System. An HVIN is required for all products for certification applications.	A04577
Host Marketing Name (HMN) (if applicable): The HMN is the name or model number of a final product, which contains a certified radio module.	
Brand Name	
Model Number	A04577
Test Rule Part(s)	47 CFR 15E, 15.407, RSS-247
Test Frequency Range	5.15-5.25 and 5.725-5.85 GHz
Project Number	221013
Submission Type	FCC: Certification, IC: Certification

Product Details

Items	Description
Product Type	Single chain 5 GHz U-NII-1, and U-NII-3
Radio Type	Transceiver
Power Type	Internal Rechargeable Battery or External Direct Current
Frequency Range	5150-5250 MHz / 5725-5850 MHz
Channel Number	Channels 36, 38, 40, 42, 44, 46, 48, 149, 151, 153, 155, 157, 159, 161, 165
Carrier Frequencies	Please refer to 802.11 Standard for Carrier Frequencies
Antenna	Integrated 5 dBi antenna PIFA
Communication Mode	Device provides 5 GHz, U-NII 1 and U-NII-3 operation
Beamforming Function	Without beamforming
Operating Mode	5150-5250 MHz (U-NII-1) and 5725-5825 MHz (U-NII-3)

Antenna and Bandwidth

Antenna	Number of TX chains		
	20 MHz	40 MHz	80 MHz
IEEE 802.11a	Single Chain	Single Chain	N/A
IEEE 802.11n	Single Chain	Single Chain	N/A
IEEE 802.11ac	N/A	N/A	Single Chain

Application for Certification

- (1) Manufacturer: Garmin International, Inc.
1200 East 151st Street
Olathe, KS 66062
- (2) Identification: HVIN: A04577
FCC ID: IPH-04577 IC: 1792A-04577
- (3) Instruction Book:
Refer to Exhibit for Instruction Manual.
- (4) Description of Circuit Functions:
Refer to Exhibit of Operational Description.
- (5) Block Diagram with Frequencies:
Refer to Exhibit of Operational Description.
- (6) Report of Measurements:
Report of measurements follows in this Report.
- (7) Photographs: Construction, Component Placement, etc.:
Refer to Exhibit for photographs of equipment.
- (8) List of Peripheral Equipment Necessary for operation. The equipment operates from internal battery power or external direct current power provided from authorized sources. The EUT provides USB-C interface port for power and communications as presented in this filing.
- (9) Transition Provisions of 47 CFR 15.37 are not requested.
- (10) Not Applicable. The unit is not a scanning receiver.
- (11) Not Applicable. The EUT does not operate in the 59 – 64 GHz frequency band.
- (12) The equipment is not software defined and this section is not applicable.
- (13) Applications for certification of U-NII devices in the 5.15-5.35 GHz and the 5.47-5.85 GHz bands must include a high-level operational description of the security procedures that control the radio frequency operating parameters and ensure that unauthorized modifications cannot be made. The required information has been provided in Operational Description Exhibit filed with the application.
- (14) Contain at least one drawing or photograph showing the test set-up for each of the required types of tests applicable to the device for which certification is requested. These drawings or photographs must show enough detail to confirm other information contained in the test report. Any photographs used must be focused originals without glare or dark spots and must clearly show the test configuration used. This information is provided in this report and Test Setup Exhibits provided with the application filing.

Applicable Standards & Test Procedures

The following information is submitted in accordance with e-CFR dated October 13, 2022, Part 2, Subpart J, Part 15, Subpart 15E, Industry Canada RSS-GEN Issue 5, and RSS-247 Issue 2.

Test procedures used are the established Methods of Measurement of Radio-Noise Emissions as described in ANSI C63.10-2013, KDB 789033 D02 General UNII Test Procedures New Rules v02r01, KDB 926956 v02, RSS-247 Issue 2, and RSS-GEN Issue 5.

Testing Procedures

Testing for the AC line-conducted emissions was performed as required in 47 CFR 15C, RSS-247 Issue 2 and specified in ANSI C63.10-2013. The test setup, including the EUT, was arranged in the test configurations as presented during testing. The test configuration was placed on a 1 x 1.5-meter bench, 0.8 meters high located in a screen room. The power lines of the system were isolated from the power source using a standard LISN with a 50- μ Hy choke. EMI was coupled to the spectrum analyzer through a 0.1 μ F capacitor internal to the LISN. The LISN was positioned on the floor beneath the wooden bench supporting the EUT. The power lines and cables were draped over the back edge of the table. Refer to diagram one showing typical test arrangement and photographs in the test setup exhibit for EUT placement used during testing.

Radiated Emission Test Procedure

Radiated emissions testing was performed as required in 47 CFR 15C, RSS-247 Issue 2 and specified in ANSI C63.10-2013. The EUT was placed on a rotating 0.9 x 1.2-meter platform, elevated as required above the ground plane at a distance of 3 meters from the FSM antenna. EMI energy was maximized by equipment placement permitting orientation in three orthogonal axes, raising, and lowering the FSM antenna, changing the antenna polarization, and by rotating the turntable. Each emission was maximized before data was taken and recorded. The frequency spectrum from 9 kHz to 40,000 MHz was searched for emissions during preliminary investigation. Refer to diagrams two and three showing typical test setup. Refer to photographs in the test setup exhibit for specific EUT placement during testing.

Antenna Port Conducted Emission Test Procedure

The EUT was assembled as required for operation placed on a benchtop. This configuration provided the ability to connect test equipment to the provided test antenna port. Antenna Port conducted emissions testing was performed presented in the regulations and specified in ANSI C63.10-2013. Testing was completed on a laboratory bench in a shielded room. The active antenna port of the device was connected to appropriate attenuation and the spectrum analyzer. Refer to diagram three showing typical test arrangement and photographs in the test setup exhibits for specific EUT placement during testing.

Diagram 1 Test arrangement for Conducted emissions

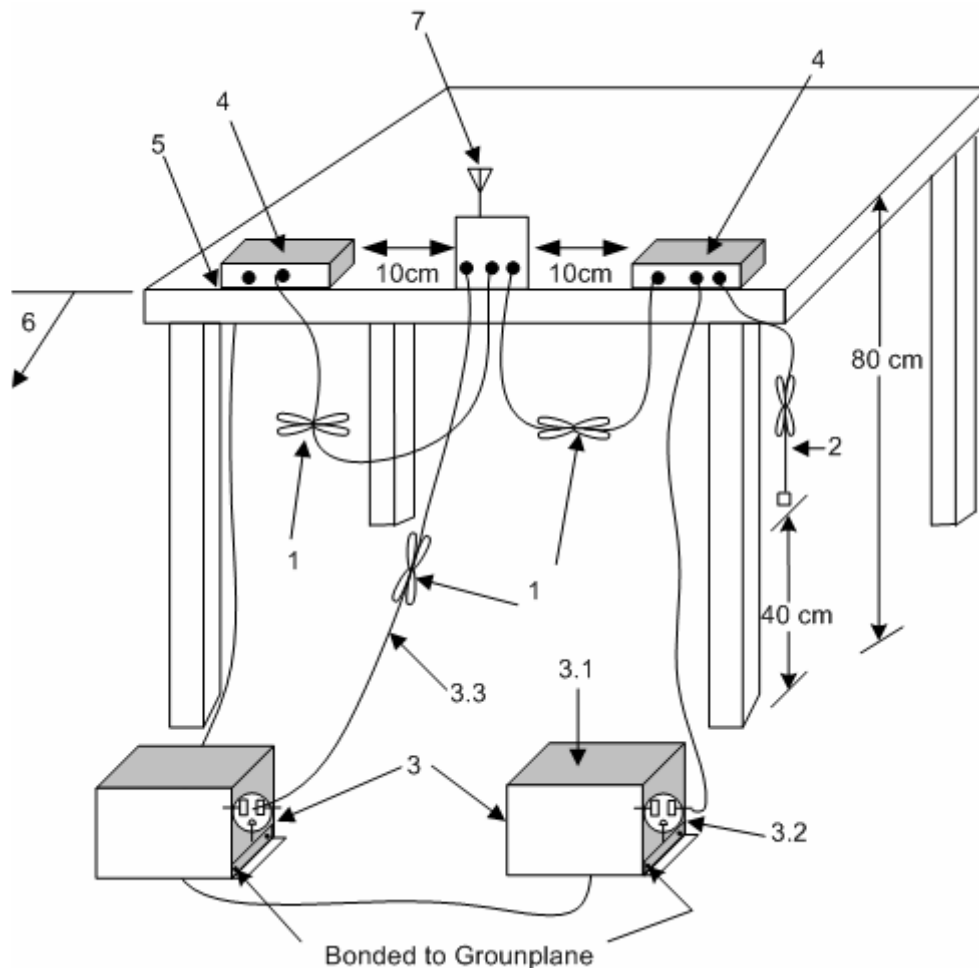

1. Interconnecting cables that hang closer than 40 cm to the ground plane shall be folded back and forth in the center forming a bundle 30 cm to 40 cm long see (see 6.2.3.1).
2. I/O cables that are not connected to an accessory shall be bundled in the center. The end of the cable may be terminated, if required, using the correct terminating impedance. The overall length shall not exceed 1 m (see 6.2.2).
3. EUT connected to one LISN. Unused LISN measuring port connectors shall be terminated in 50 Ω loads. LISN can be placed on top of, or immediately beneath, reference ground plane (see 6.2.2 and 6.2.3).
 - 3.1 All other equipment powered from additional LISN(s).
 - 3.2 Multiple-outlet strip can be used for multiple power cords of non-EUT equipment.
 - 3.3 LISN at least 80 cm from nearest part of EUT chassis.
4. Non-EUT components of EUT system being tested.
5. Rear of EUT, including peripherals, shall all be aligned and flush with rear of tabletop (see 6.2.3.1).
6. Edge of tabletop shall be 40 cm removed from a vertical conducting plane that is bonded to the ground plane (see 6.2.2 for options).
7. Antenna may be integral or detachable. If detachable, the antenna shall be attached for this test.

Diagram 2 Test arrangement for radiated emissions of tabletop equipment

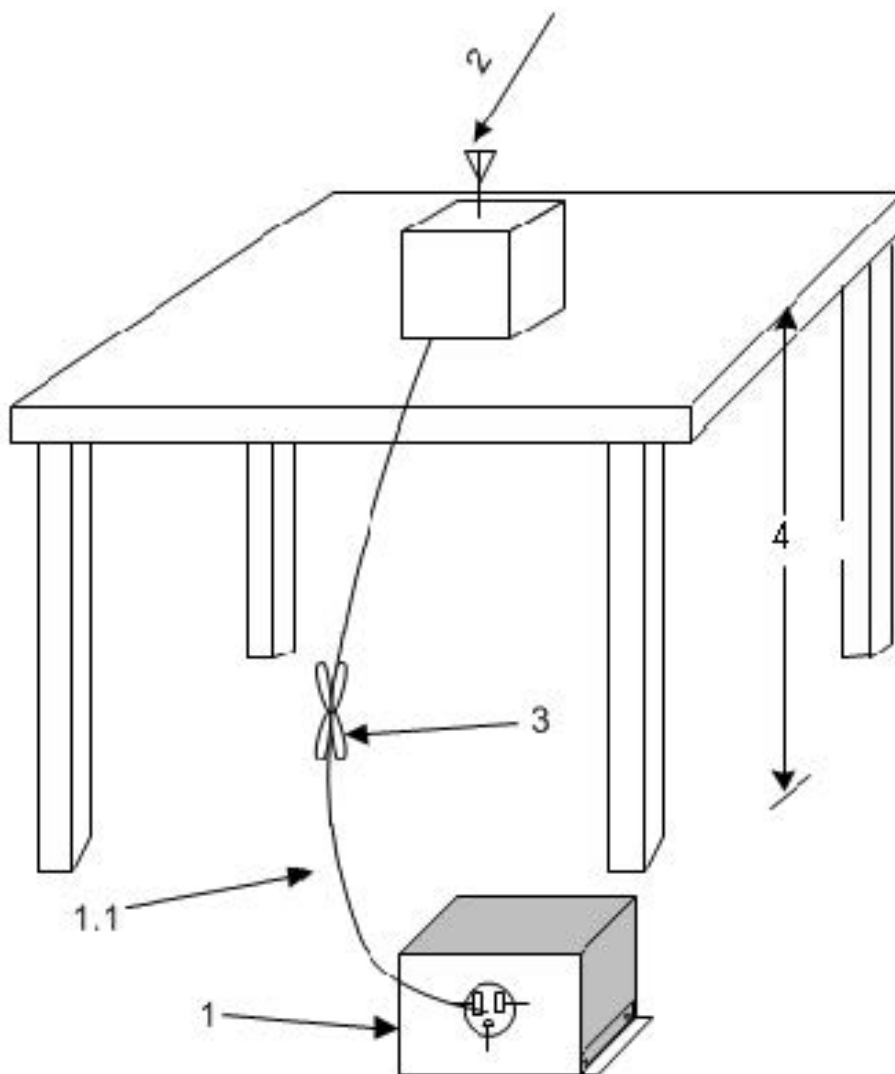

1—A LISN is optional for radiated measurements between 30 MHz and 1000 MHz but not allowed for measurements below 30 MHz and above 1000 MHz (see 6.3.1). If used, then connect EUT to one LISN. Unused LISN measuring port connectors shall be terminated in 50 Ω loads. The LISN may be placed on top of, or immediately beneath, the reference ground plane (see 6.2.2 and 6.2.3.2).

1.1—LISN spaced at least 80 cm from the nearest part of the EUT chassis.

2—Antenna can be integral or detachable, depending on the EUT (see 6.3.1).

3—Interconnecting cables that hang closer than 40 cm to the ground plane shall be folded back and forth in the center forming a bundle 30 cm to 40 cm long (see 6.3.1).

4—For emission measurements at or below 1 GHz, the table height shall be 80 cm. For emission measurements above 1 GHz, the table height shall be 1.5 m for measurements, except as otherwise specified (see 6.3.1 and 6.6.3.1).

Diagram 3 Test arrangement for radiated emissions tested on Open Area Test Site (OATS)

Test arrangement for radiated emissions Below 1 GHz

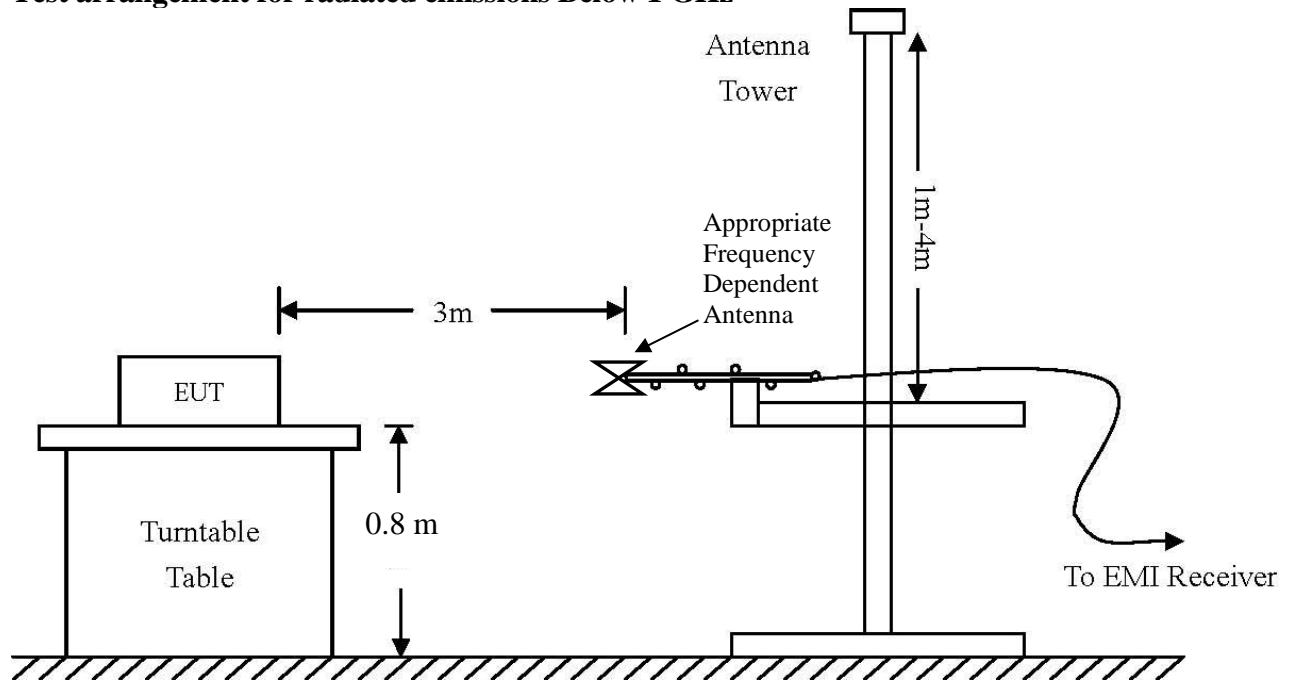

Test arrangement for radiated emissions Above 1 GHz

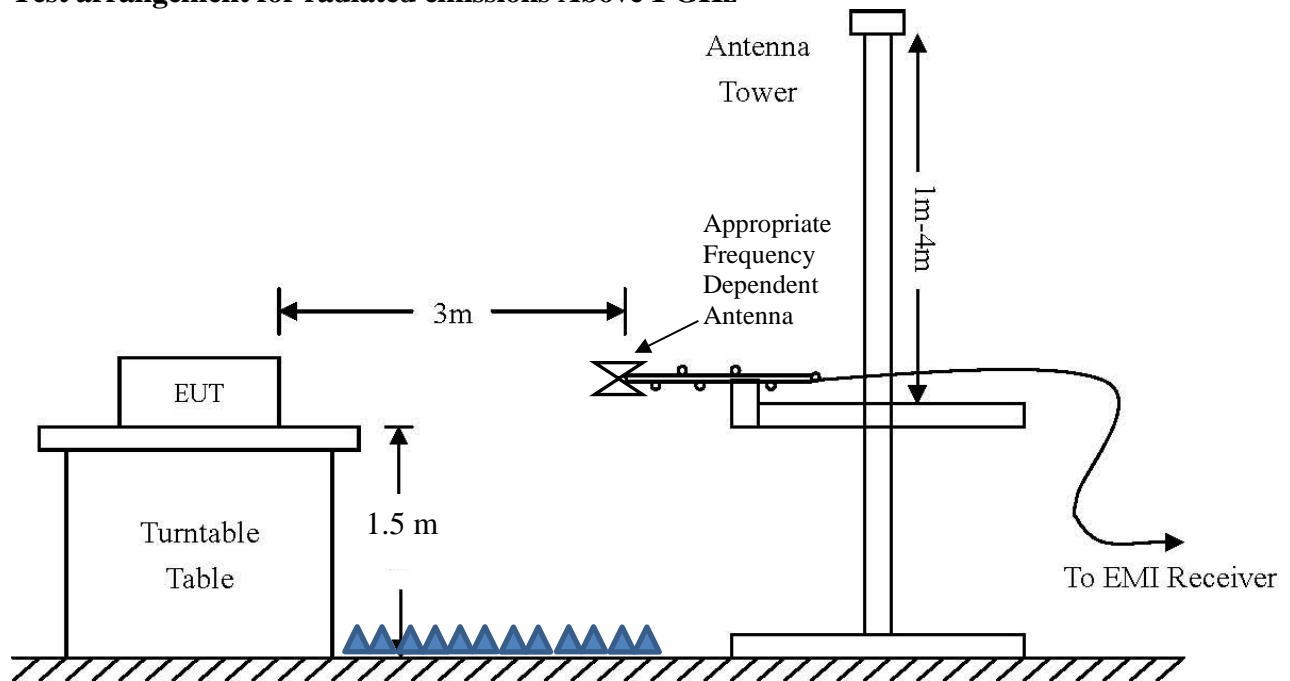
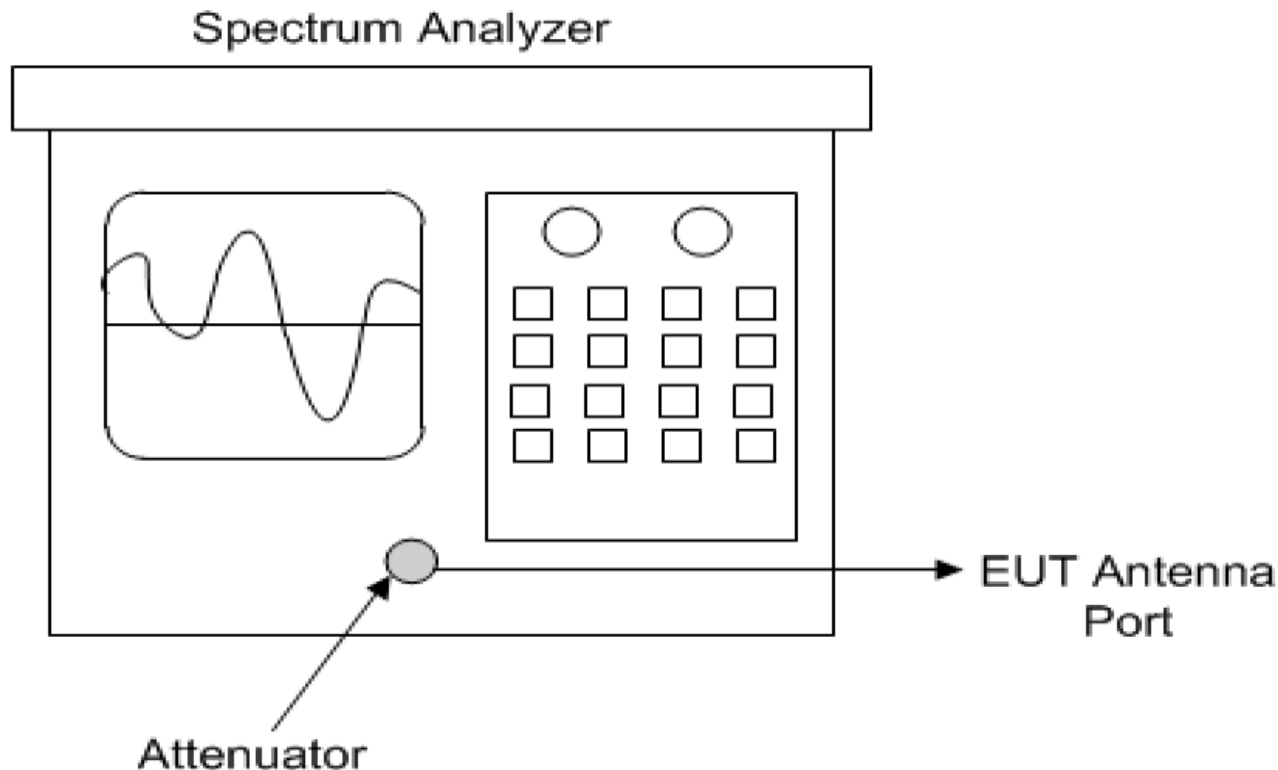

Diagram 4 Test arrangement for Antenna Port Conducted emissions



Test Site Locations

Conducted EMI AC line conducted emissions testing performed in a shielded screen room located at Rogers Labs, Inc., 4405 West 259th Terrace, Louisburg, KS

Antenna port Antenna port conducted emissions testing was performed in a shielded screen room located at Rogers Labs, Inc., 4405 West 259th Terrace, Louisburg, KS

Radiated EMI The radiated emissions tests were performed at the 3 meters, Open Area Test Site (OATS) located at Rogers Labs, Inc., 4405 West 259th Terrace, Louisburg, KS

Registered Site information: FCC Site: US5305, ISED: 3041A, CAB Identifier: US0096

NVLAP Accreditation Lab code 200087-0

Units of Measurements

Conducted EMI Data presented in dB μ V; dB referenced to one microvolt

Antenna port Conducted Data is in dBm; dB referenced to one milliwatt

Radiated EMI Data presented in dB μ V/m; dB referenced to one microvolt per meter

Note: Radiated limit may be expressed for measurement in dB μ V/m when the measurement is taken at a distance of 3 or 10 meters. Data taken for this report was taken at distance of 3 meters.

Sample calculation demonstrates corrected field strength reading for Open Area Test Site using the measurement reading and correcting for receive antenna factor, cable losses, and amplifier gains.

Sample Calculation:

RFS = Radiated Field Strength, FSM = Field Strength Measured

A.F. = Receive antenna factor, Losses = attenuators/cable losses, Gain = amplification gains

$RFS (dB\mu V/m @ 3m) = FSM (dB\mu V) + A.F. (dB/m) + Losses (dB) - Gain (dB)$

Environmental Conditions

Ambient Temperature 21.3° C

Relative Humidity 37.8 %

Atmospheric Pressure 1017.9 mb

Statement of Modifications and Deviations

No modifications to the EUT were required for the unit to demonstrate compliance with the 47 CFR Part 15C, RSS-Gen, and RSS-247 Issue 2, and RSS-GEN Issue 5 emission requirements.

There were no deviations to the specifications.

Intentional Radiators

The following information is submitted in support demonstration of compliance with the requirements of 47 CFR, Subpart C, paragraph 15.247, and Industry Canada RSS-247 and RSS-Gen the following information is submitted.

Antenna Requirements

The EUT incorporates integral antenna system and offers no provision for connection to alternate antenna system. The antenna connection point complies with the unique antenna connection requirements. There are no deviations or exceptions to the specification.

Restricted Bands of Operation

Spurious emissions falling in the restricted frequency bands of operation were measured at the OATS. The EUT utilizes frequency, determining circuitry, which generates harmonics falling in the restricted bands. Emissions were investigated at the OATS, using appropriate antennas or pyramidal horns, amplification stages, and a spectrum analyzer. Peak and average amplitudes of frequencies above 1000 MHz were compared to the required limits with worst-case data presented below. Test procedures of ANSI C63.10-2013 were used during testing. No other significant emission was observed which fell into the restricted bands of operation. Computed emission values consider the received radiated field strength, receive antenna correction factor, amplifier gain stage, and test system cable losses.

Table 1 Harmonic Radiated Emissions in Restricted Bands Data Mode 9, U-NII-1 (802.11a)

Frequency in MHz	Horizontal Peak (dB μ V/m)	Horizontal Average (dB μ V/m)	Vertical Peak (dB μ V/m)	Vertical Average (dB μ V/m)	Limit @ 3m (dB μ V/m)	Horizontal Margin (dB)	Vertical Margin (dB)
U-NII-1 (802.11a) Operation Worst-case							
5150.0	71.7	53.5	68.4	51.6	54.0	-0.5	-2.4
5350.0	51.4	37.9	51.4	37.8	54.0	-16.1	-16.2
15540.0	62.7	49.3	62.1	49.4	54.0	-4.7	-4.6
15600.0	61.9	49.0	62.3	49.0	54.0	-5.0	-5.0
15720.0	62.7	49.9	62.2	49.9	54.0	-4.1	-4.1
20720.0	66.1	53.6	66.4	53.4	54.0	-0.4	-0.6
20800.0	66.6	53.4	66.3	53.2	54.0	-0.6	-0.8
20960.0	66.1	53.3	66.4	53.2	54.0	-0.7	-0.8

Other emissions present had amplitudes at least 20 dB below the limit. Peak and Quasi-Peak amplitude emissions are recorded for frequency below 1000 MHz. Peak and Average amplitude emissions are recorded for frequency range above 1000 MHz.

Table 2 Harmonic Radiated Emissions in Restricted Bands Data Mode 10, U-NII-1 (802.11n)

Frequency in MHz	Horizontal Peak (dBμV/m)	Horizontal Average (dBμV/m)	Vertical Peak (dBμV/m)	Vertical Average (dBμV/m)	Limit @ 3m (dBμV/m)	Horizontal Margin (dB)	Vertical Margin (dB)
U-NII-1 (802.11n) Operation Worst-case							
5150.0	72.8	53.4	71.2	51.4	54.0	-0.6	-2.6
5350.0	51.0	37.9	51.5	37.8	54.0	-16.1	-16.2
15540.0	62.4	49.4	62.4	49.4	54.0	-4.6	-4.6
15600.0	62.2	49.0	62.2	49.0	54.0	-5.0	-5.0
15720.0	63.1	49.9	62.7	49.9	54.0	-4.1	-4.1
20720.0	66.2	52.9	65.9	52.9	54.0	-1.1	-1.1
20800.0	65.9	53.0	65.7	52.9	54.0	-1.0	-1.1
20960.0	65.7	52.7	65.9	52.7	54.0	-1.3	-1.3

Other emissions present had amplitudes at least 20 dB below the limit. Peak and Quasi-Peak amplitude emissions are recorded for frequency below 1000 MHz. Peak and Average amplitude emissions are recorded for frequency range above 1000 MHz.

Table 3 Harmonic Radiated Emissions in Restricted Bands Data Mode 11, U-NII-1 (802.11n40)

Frequency in MHz	Horizontal Peak (dBμV/m)	Horizontal Average (dBμV/m)	Vertical Peak (dBμV/m)	Vertical Average (dBμV/m)	Limit @ 3m (dBμV/m)	Horizontal Margin (dB)	Vertical Margin (dB)
U-NII-1 (802.11n40) Operation Worst-case							
5150.0	69.7	53.6	70.1	51.4	54.0	-0.4	-2.6
5350.0	55.5	39.7	54.5	39.4	54.0	-14.3	-14.6
15570.0	63.6	50.6	63.0	49.9	54.0	-3.4	-4.1
15690.0	62.7	49.5	62.3	49.5	54.0	-4.5	-4.5
20760.0	65.9	53.0	66.0	52.8	54.0	-1.0	-1.2
20920.0	65.3	52.8	65.2	52.7	54.0	-1.2	-1.3

Other emissions present had amplitudes at least 20 dB below the limit. Peak and Quasi-Peak amplitude emissions are recorded for frequency below 1000 MHz. Peak and Average amplitude emissions are recorded for frequency range above 1000 MHz.

Table 4 Harmonic Radiated Emissions in Restricted Bands Data Mode 12, U-NII-3 (802.11a)

Frequency in MHz	Horizontal Peak (dBμV/m)	Horizontal Average (dBμV/m)	Vertical Peak (dBμV/m)	Vertical Average (dBμV/m)	Limit @ 3m (dBμV/m)	Horizontal Margin (dB)	Vertical Margin (dB)
U-NII-3 (802.11a) Operation Worst-case							
11490.0	58.8	45.9	59.2	45.9	54.0	-8.1	-8.1
11570.0	59.2	46.2	59.1	46.3	54.0	-7.8	-7.7
11650.0	59.8	46.1	59.2	46.2	54.0	-7.9	-7.8
22980.0	65.6	53.1	65.6	53.0	54.0	-0.9	-1.0

Other emissions present had amplitudes at least 20 dB below the limit. Peak and Quasi-Peak amplitude emissions are recorded for frequency below 1000 MHz. Peak and Average amplitude emissions are recorded for frequency range above 1000 MHz.

Table 5 Harmonic Radiated Emissions in Restricted Bands Data Mode 13, U-NII-3 (802.11n)

Frequency in MHz	Horizontal Peak (dBμV/m)	Horizontal Average (dBμV/m)	Vertical Peak (dBμV/m)	Vertical Average (dBμV/m)	Limit @ 3m (dBμV/m)	Horizontal Margin (dB)	Vertical Margin (dB)
U-NII-3 (802.11n) Operation Worst-case							
11490.0	58.5	45.8	58.7	45.8	54.0	-8.2	-8.2
11570.0	59.1	45.9	59.2	45.9	54.0	-8.1	-8.1
11650.0	59.2	46.1	59.1	45.8	54.0	-7.9	-8.2
22980.0	66.1	53.0	66.2	53.1	54.0	-1.0	-0.9

Other emissions present had amplitudes at least 20 dB below the limit. Peak and Quasi-Peak amplitude emissions are recorded for frequency below 1000 MHz. Peak and Average amplitude emissions are recorded for frequency range above 1000 MHz.

Table 6 Harmonic Radiated Emissions in Restricted Bands Data Mode 14, U-NII-3 (802.11n40)

Frequency in MHz	Horizontal Peak (dBμV/m)	Horizontal Average (dBμV/m)	Vertical Peak (dBμV/m)	Vertical Average (dBμV/m)	Limit @ 3m (dBμV/m)	Horizontal Margin (dB)	Vertical Margin (dB)
U-NII-3 (802.11n40) Operation Worst-case							
11510.0	11510.0	58.9	45.8	59.1	45.9	54.0	-8.2
11590.0	11590.0	59.6	46.4	59.8	46.5	54.0	-7.6
23020.0	23020.0	66.1	52.8	65.6	52.8	54.0	-1.2

Other emissions present had amplitudes at least 20 dB below the limit. Peak and Quasi-Peak amplitude emissions are recorded for frequency below 1000 MHz. Peak and Average amplitude emissions are recorded for frequency range above 1000 MHz.

Table 7 Harmonic Radiated Emissions in Restricted Bands Data Mode 15, U-NII-1 (802.11ac80)

Frequency in MHz	Horizontal Peak (dBμV/m)	Horizontal Average (dBμV/m)	Vertical Peak (dBμV/m)	Vertical Average (dBμV/m)	Limit @ 3m (dBμV/m)	Horizontal Margin (dB)	Vertical Margin (dB)
U-NII-1 (802.11ac80) Operation Worst-case							
5150.0	63.6	50.2	65.9	51.8	54.0	-3.8	-2.2
5350.0	53.3	40.2	53.5	40.2	54.0	-13.8	-13.8
15630.0	60.2	47.5	60.7	47.7	54.0	-6.5	-6.3
20840.0	66.5	53.3	66.2	53.2	54.0	-0.7	-0.8

Other emissions present had amplitudes at least 20 dB below the limit. Peak and Quasi-Peak amplitude emissions are recorded for frequency below 1000 MHz. Peak and Average amplitude emissions are recorded for frequency range above 1000 MHz.

Table 8 Harmonic Radiated Emissions in Restricted Bands Data Mode 16, U-NII-3 (802.11ac80)

Frequency in MHz	Horizontal Peak (dBμV/m)	Horizontal Average (dBμV/m)	Vertical Peak (dBμV/m)	Vertical Average (dBμV/m)	Limit @ 3m (dBμV/m)	Horizontal Margin (dB)	Vertical Margin (dB)
U-NII-3 (802.11a) Operation Worst-case							
11550.0	59.4	46.4	59.3	46.1	54.0	-7.6	-7.9
23100.0	65.7	53.1	65.8	53.1	54.0	-0.9	-0.9

Other emissions present had amplitudes at least 20 dB below the limit. Peak and Quasi-Peak amplitude emissions are recorded for frequency below 1000 MHz. Peak and Average amplitude emissions are recorded for frequency range above 1000 MHz.

Summary of Results for Radiated Emissions in Restricted Bands

The EUT demonstrated compliance with the emissions requirements of 47 CFR 15.205, RSS-GEN Issue 5, and RSS-247 Issue 2. The EUT provided a worst-case minimum margin of -0.4 dB below the emissions requirements in restricted frequency bands. Peak, Quasi-peak, and average amplitudes were checked for compliance with the regulations. Worst-case emissions are reported with other emissions found in the restricted frequency bands at least 20 dB below the requirements.

AC Line Conducted EMI Procedure

The EUT was arranged in typical equipment configurations as offered by manufacturer and presented above in equipment configuration. AC Line Conducted emission testing was performed with the EUT placed on a 1 x 1.5-meter bench 80 cm above the conducting ground plane, floor of a screen room. The bench was positioned 40 cm away from the wall of the screen room. The LISN was positioned on the floor of the screen room 80-cm from the rear of the EUT. Testing for the AC line-conducted emissions followed the procedures of ANSI C63.10-2013. The EUT was configured as presented in the AC Line conducted configurations as directed by the manufacture and presented above in equipment configuration. The AC adapter for the EUT was connected to the LISN for AC line-conducted emissions testing. A second LISN was positioned on the floor of the screen room 80-cm from the rear of the supporting equipment of the test configuration. All power cords except the EUT were then powered from the second LISN. EMI was coupled to the spectrum analyzer through a 0.1 μ F capacitor, internal to the LISN. Power line conducted emissions testing was carried out individually for each current carrying conductor of the EUT. The excess length of lead between the system and the LISN receptacle was folded back and forth to form a bundle not exceeding 40 cm in length. The screen room, conducting ground plane, analyzer, and LISN were bonded together to the protective earth ground. Preliminary testing was performed to identify the frequencies of each of the emissions, which demonstrated the highest amplitudes. The cables were repositioned to obtain maximum amplitude of measured EMI level. Once the worst-case configuration was identified, plots were made of the EMI from 0.15 MHz to 30 MHz and data recorded.

Refer to figures 1 and 2 for plots of the EUT – AC Adapter interface configuration #2 AC Line conducted emissions.

Refer to figures 3 and 4 for plots of the EUT – CPU interface configuration #3 AC Line conducted emissions.

Figure 1 AC Line Conducted emissions of EUT Configuration #2 line 1 (EUT – AC Adapter)

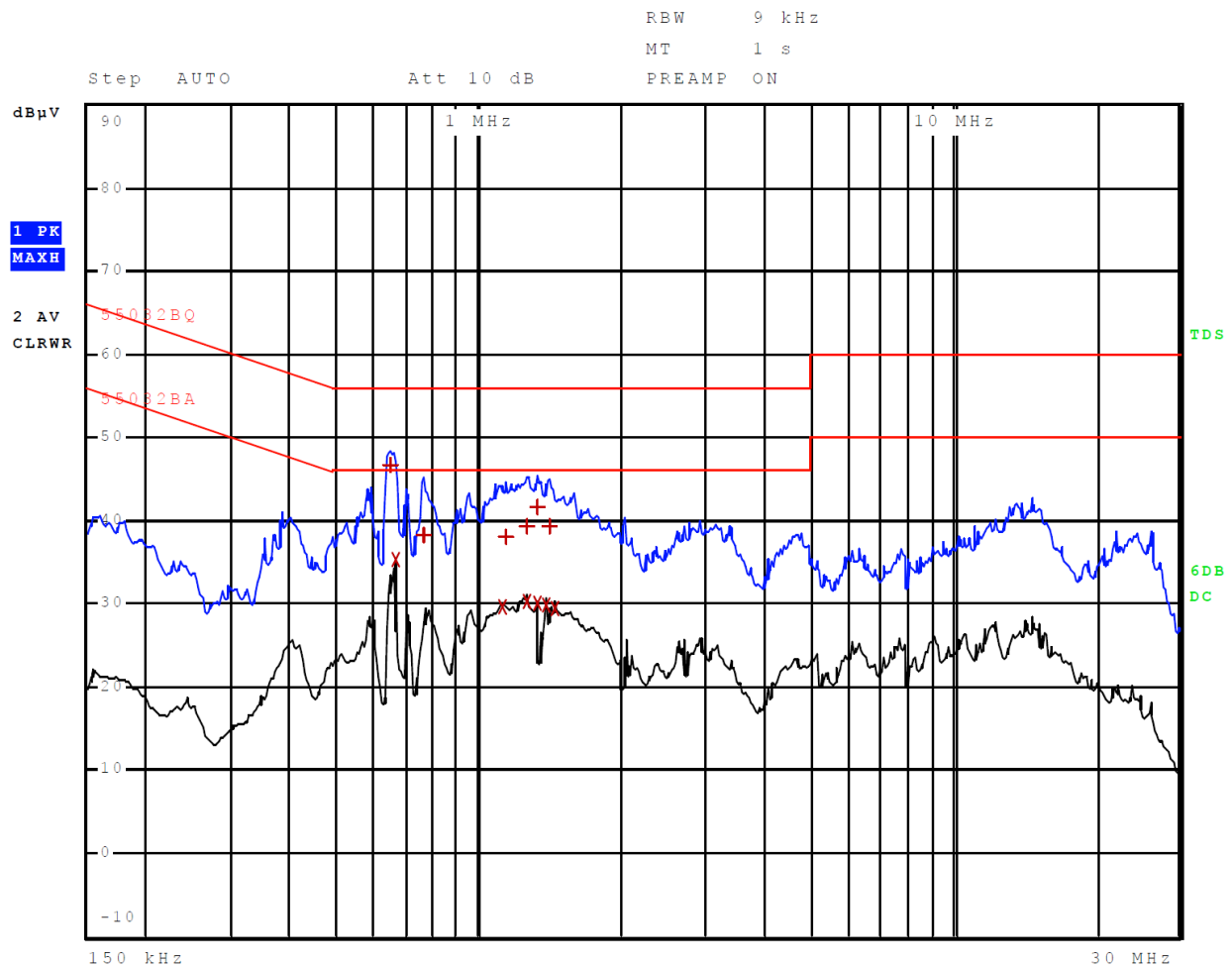

Figure 2 AC Line Conducted emissions of EUT Configuration #2 line 2 (EUT – AC Adapter)

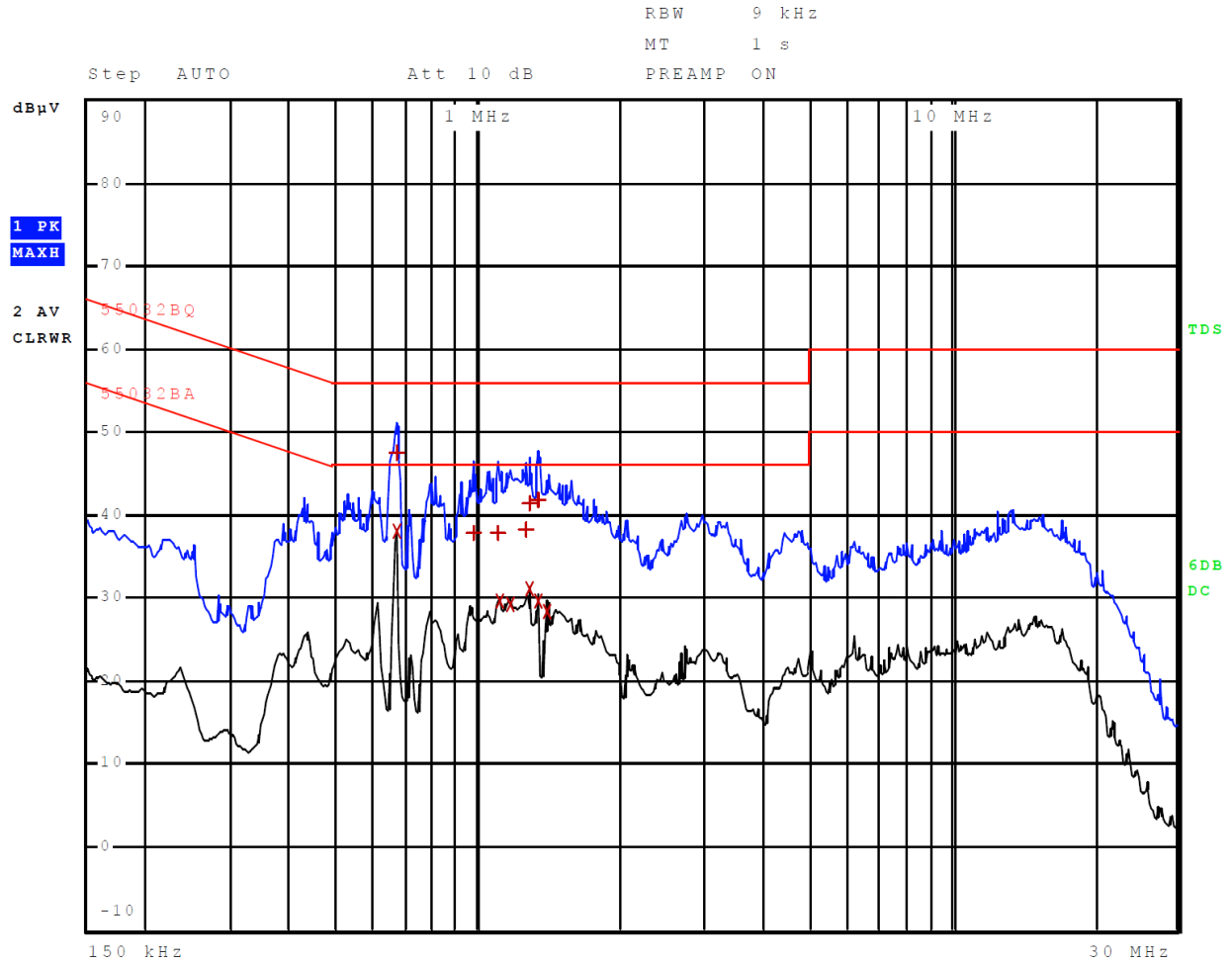

Figure 3 AC Line Conducted emissions of EUT Configuration #3 line 1 (EUT – CPU)

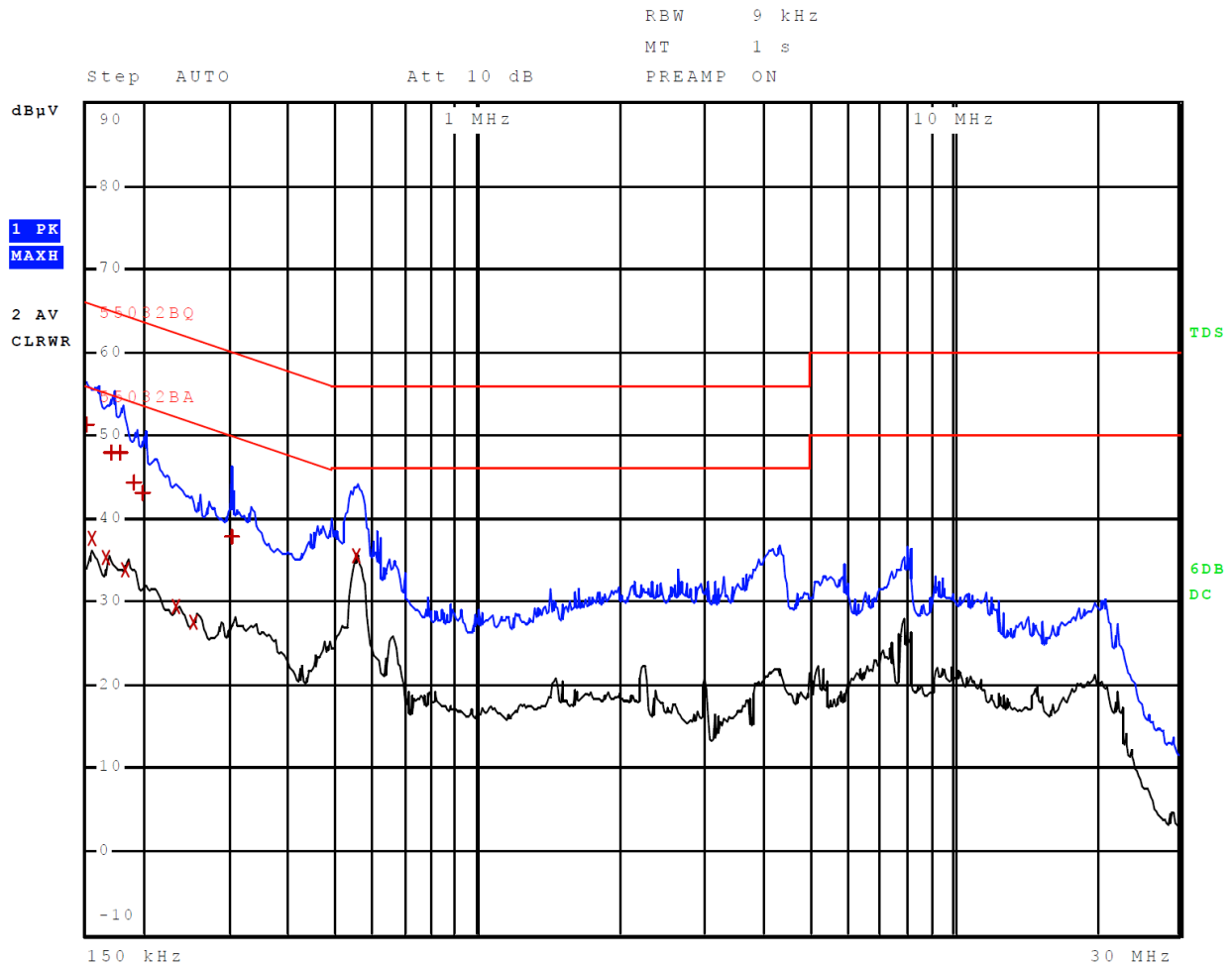

Figure 4 AC Line Conducted emissions of EUT Configuration #3 line 2 (EUT – CPU)

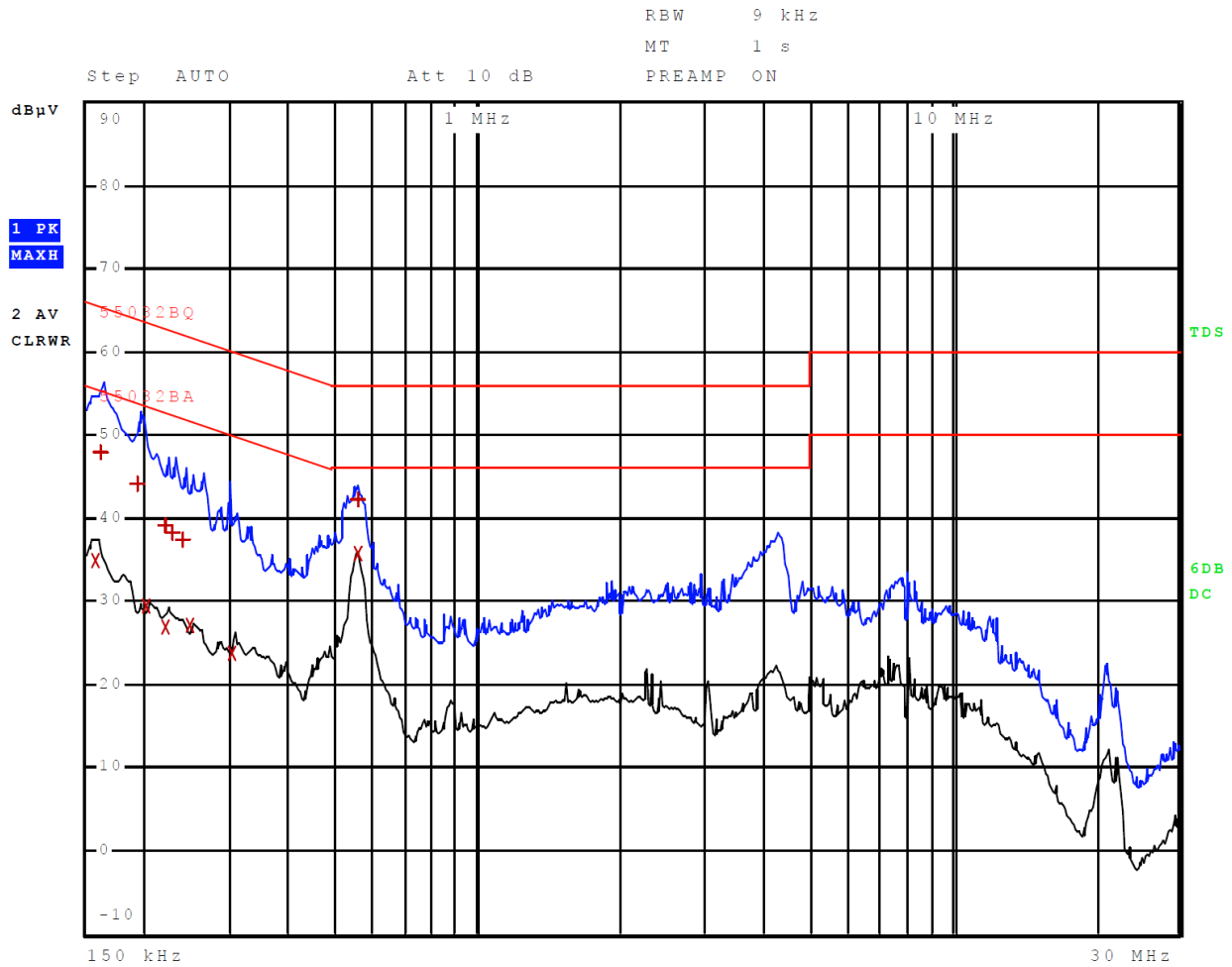

Table 9 AC Line Conducted Emissions Configuration #2 Data L1 (EUT – AC Adapter)

Trace	Frequency	Level (dBµV)	Detector	Delta Limit/dB
1	646.000000000 kHz	46.61	Quasi Peak	-9.39
2	662.000000000 kHz	35.22	Average	-10.78
1	762.000000000 kHz	38.25	Quasi Peak	-17.75
2	1.118000000 MHz	29.65	Average	-16.35
1	1.142000000 MHz	38.09	Quasi Peak	-17.91
2	1.258000000 MHz	30.29	Average	-15.71
1	1.258000000 MHz	39.17	Quasi Peak	-16.83
2	1.322000000 MHz	30.02	Average	-15.98
1	1.326000000 MHz	41.59	Quasi Peak	-14.41
2	1.382000000 MHz	29.87	Average	-16.13
1	1.406000000 MHz	39.18	Quasi Peak	-16.82
2	1.442000000 MHz	29.43	Average	-16.57

Other emissions present had amplitudes at least 20 dB below the limit.

Table 10 AC Line Conducted Emissions Configuration #2 Data L2 (EUT – AC Adapter)

Trace	Frequency	Level (dBµV)	Detector	Delta Limit/dB
2	670.000000000 kHz	38.10	Average	-7.90
1	670.000000000 kHz	47.51	Quasi Peak	-8.49
1	974.000000000 kHz	37.73	Quasi Peak	-18.27
1	1.098000000 MHz	37.81	Quasi Peak	-18.19
2	1.106000000 MHz	29.66	Average	-16.34
2	1.166000000 MHz	29.26	Average	-16.74
1	1.262000000 MHz	38.17	Quasi Peak	-17.83
2	1.282000000 MHz	30.98	Average	-15.02
1	1.286000000 MHz	41.39	Quasi Peak	-14.61
2	1.338000000 MHz	29.59	Average	-16.41
1	1.342000000 MHz	41.88	Quasi Peak	-14.12
2	1.398000000 MHz	28.28	Average	-17.72

Other emissions present had amplitudes at least 20 dB below the limit.

Table 11 AC Line Conducted Emissions Configuration #3 Data L1 (EUT – CPU)

Trace	Frequency	Level (dBµV)	Detector	Delta Limit/dB
1	150.000000000 kHz	51.29	Quasi Peak	-14.71
2	154.000000000 kHz	37.65	Average	-18.13
2	166.000000000 kHz	35.36	Average	-19.80
1	170.000000000 kHz	47.82	Quasi Peak	-17.14
1	178.000000000 kHz	47.82	Quasi Peak	-16.76
2	182.000000000 kHz	33.73	Average	-20.66
1	190.000000000 kHz	44.30	Quasi Peak	-19.74
1	198.000000000 kHz	43.07	Quasi Peak	-20.62
2	234.000000000 kHz	29.41	Average	-22.89
2	254.000000000 kHz	27.54	Average	-24.08
1	302.000000000 kHz	37.75	Quasi Peak	-22.44
2	550.000000000 kHz	35.40	Average	-10.60

Other emissions present had amplitudes at least 20 dB below the limit.

Table 12 AC Line Conducted Emissions Configuration #3 Data L2 (EUT – CPU)

Trace	Frequency	Level (dBµV)	Detector	Delta Limit/dB
2	158.000000000 kHz	34.81	Average	-20.75
1	162.000000000 kHz	47.97	Quasi Peak	-17.39
1	194.000000000 kHz	44.18	Quasi Peak	-19.68
2	202.000000000 kHz	29.43	Average	-24.10
2	222.000000000 kHz	26.95	Average	-25.80
1	222.000000000 kHz	39.08	Quasi Peak	-23.67
1	230.000000000 kHz	38.24	Quasi Peak	-24.21
1	242.000000000 kHz	37.31	Quasi Peak	-24.72
2	250.000000000 kHz	27.14	Average	-24.62
2	306.000000000 kHz	23.74	Average	-26.34
2	554.000000000 kHz	35.63	Average	-10.37
1	554.000000000 kHz	42.22	Quasi Peak	-13.78

Other emissions present had amplitudes at least 20 dB below the limit.

Summary of Results for AC Line Conducted Emissions

The EUT demonstrated compliance with the AC Line Conducted Emissions requirements of 47CFR Part 15C and other applicable emissions requirements. The worst-case configuration, Configuration #2, EUT – AC Adapter, demonstrated a minimum margin of -7.9 dB below the requirement. Other emissions were present with amplitudes at least 20 dB below the limit and worst-case amplitudes recorded.

General Radiated Emissions Procedure

The EUT was arranged in a typical equipment configuration and operated through all available mode during testing. Preliminary testing was performed in a screen room with the EUT positioned 1 meter from the FSM. Radiated emissions measurements were performed to identify the frequencies, which produced the highest emissions. Each radiated emission was then maximized at the OATS location before final radiated measurements were performed. Final data was taken with the EUT located on the OATS at 3 meters distance between the EUT and the receiving antenna. The frequency spectrum from 9 kHz to 60,000 MHz was searched for general radiated emissions. Measured emission levels were maximized by EUT placement on the table, rotating the turntable through 360 degrees, varying the antenna height between 1 and 4 meters above the ground plane and changing antenna position between horizontal and vertical polarization. Antennas used were Loop from 9 kHz to 30 MHz, Broadband Biconical from 30 to 200 MHz, Biconilog from 30 to 1000 MHz, Log Periodic from 200 MHz to 1 GHz and or double Ridge or pyramidal horns and mixers above 1 GHz, notch filters and appropriate amplifiers and external mixers were utilized.

Table 13 General Radiated Emissions Data

Frequency (MHz)	Horizontal Peak (dBμV/m)	Horizontal Quasi-Peak (dBμV/m)	Vertical Peak (dBμV/m)	Vertical Quasi-Peak (dBμV/m)	Limit @ 3m (dBμV/m)	Horizontal Margin (dB)	Vertical Margin (dB)
55.0	28.9	24.0	37.4	30.5	40.0	-16.0	-9.5
110.1	27.5	23.4	28.0	20.2	40.0	-16.6	-19.8
165.3	21.8	15.6	19.5	14.2	40.0	-24.4	-25.8
220.3	20.1	13.7	17.8	15.9	40.0	-26.3	-24.1
330.4	23.2	18.6	21.3	15.1	47.0	-28.4	-31.9
385.4	27.0	23.4	22.3	16.2	47.0	-23.6	-30.8
935.0	30.5	25.2	34.2	30.5	47.0	-21.8	-16.5

Other emissions present had amplitudes at least 20 dB below the limit. Peak and Quasi-Peak amplitude emissions are recorded for frequency range below 1000 MHz. Peak and Average amplitude emissions are recorded for frequency range above 1000 MHz.

Summary of Results for General Radiated Emissions

The EUT demonstrated compliance with the radiated emissions requirements of 47 CFR part 15 and Industry Canada RSS-247 Issue 2 Intentional Radiators. The EUT worst-case transmitter configuration #6, demonstrated a minimum margin of -9.5 dB below the requirements. Other emissions were present with amplitudes at least 20 dB below the Limits.

Operation in the 5150-5250 and 5725-5850 MHz Frequency U-NII-1 and U-NII-3 Bands

Testing followed FCC 789033 D02 General U-NII Test Procedures New Rules v02r01.

The manufacturer provided a second test sample which provided direct connection to the antenna port. A power meter was used to measure fundamental transmitter output power. A spectrum analyzer / receiver was used to produce plots and make other antenna port conducted measurements for compliance testing. Test software was provided to operate the transmitter. This software provided the ability to set test channel, operational mode, and modulation scheme. The antenna port was connected to coaxial cable with 50-ohm attenuator and receiver, spectrum analyzer, or power meter during testing. The design was also tested for radiated emissions using sample #1 representative of production equipment. Radiated emissions testing was performed on the Open Area Test Site (OATS) with the transmitter operating. The test sample was placed on a turntable elevated as required above the ground plane as required at a 3 meters distance from the FSM antenna located on the OATS for testing radiated emissions. The peak and quasi-peak amplitude of the frequencies below 1000 MHz were measured using a spectrum analyzer. The peak and average amplitude of emissions above 1000 MHz were measured using a spectrum analyzer. Emissions data was recorded from the measurement results. Data presented reflects measurement result corrected to account for measurement system gains and losses. Plots were made of transmitter performance for reference and demonstration of compliance. In addition, all Manufacturers of U-NII devices are responsible for ensuring frequency stability such that the emissions are maintained within the band of operation under all conditions of normal operation as specified in the user's manual. The manufacturer has attested the equipment operates within the required frequency spectrum under normal operational conditions. This report documents emissions governed under the U-NII-1 and U-NII-3 bands operating in the 5180-5240 and 5745-5825 MHz frequency bands.

47CFR 15.407 General Technical Requirements

(a) power limitations

(1) For the Band 5.15-5.25 GHz

- (ii) For an indoor access point operating in the band 5.15-5.25 GHz, the maximum conducted output power over the frequency band of operation shall not exceed 1 W provided the maximum antenna gain does not exceed 6 dBi. In addition, the maximum power spectral density shall not exceed 17 dBm in any 1-megadensityhertz band. If transmitting antennas of directional gain greater than 6 dBi are used, both the maximum conducted output power and the maximum power spectral density shall be reduced by the amount in dB that the directional gain of the antenna exceeds 6 dBi.
- (iv) For client devices in the 5.15-5.25 GHz band, the maximum conducted output power over the frequency band of operation shall not exceed 250 mW provided the maximum antenna gain does not exceed 6 dBi. In addition, the maximum power spectral density shall not exceed 11 dBm in any 1-megahertz band. If transmitting antennas of directional gain greater than 6 dBi are used, both the maximum conducted output power and the maximum power spectral density shall be reduced by the amount in dB that the directional gain of the antenna exceeds 6 dBi.

(3) For the band 5.725-5.85 GHz, the maximum conducted output power over the frequency band of operation shall not exceed 1 W. In addition, the maximum power spectral density shall not exceed 30 dBm in any 500-kHz band. If transmitting antennas of directional gain greater than 6 dBi are used, both the maximum conducted output power and the maximum power spectral density shall be reduced by the amount in dB that the directional gain of the antenna exceeds 6 dBi. However, fixed point-to-point U-NII devices operating in this band may employ transmitting antennas with directional gain greater than 6 dBi without any corresponding reduction in transmitter conducted power. Fixed, point-to-point operations exclude the use of point-to-multipoint systems, omnidirectional applications, and multiple collocated transmitters transmitting the same information. The operator of the U-NII device, or if the equipment is professionally installed, the installer, is responsible for ensuring that systems employing high gain directional antennas are used exclusively for fixed, point-to-point operations.

(11) The maximum conducted output power must be measured over any interval of continuous transmission using instrumentation calibrated in terms of an rms-equivalent voltage.

(12) Power spectral density measurement. The maximum power spectral density is measured as either a conducted emission by direct connection of a calibrated test instrument to the equipment under test or a radiated measurement. Measurements in the 5.725-5.85 GHz band are made over a reference bandwidth of 500 kHz or the 26 dB emission bandwidth of the device, whichever is less. Measurements in all other bands are made over a bandwidth of 1 MHz or the 26 dB emission bandwidth of the device, whichever is less. A narrower resolution bandwidth can be used, provided that the measured power is integrated over the full reference bandwidth.

(b) Undesirable emission limits. Except as shown in paragraph (b)(7) of this section, the maximum emissions outside of the frequency bands of operation shall be attenuated in accordance with the following limits:

- (1) For transmitters operating in the 5.15-5.25 GHz band: All emissions outside of the 5.15-5.35 GHz band shall not exceed an e.i.r.p. of -27 dBm/MHz.
- (2) For transmitters operating in the 5.25-5.35 GHz band: All emissions outside of the 5.15-5.35 GHz band shall not exceed an e.i.r.p. of -27 dBm/MHz.
- (3) For transmitters operating in the 5.47-5.725 GHz band: All emissions outside of the 5.47-5.725 GHz band shall not exceed an e.i.r.p. of -27 dBm/MHz.
- (4) For transmitters operating in the 5.725-5.85 GHz band:
 - (i) All emissions shall be limited to a level of -27 dBm/MHz at 75 MHz or more above or below the band edge increasing linearly to 10 dBm/MHz at 25 MHz above or below the band edge, and from 25 MHz above or below the band edge increasing linearly to a level of 15.6 dBm/MHz at 5 MHz above or below the band edge, and from 5 MHz above or below the band edge increasing linearly to a level of 27 dBm/MHz at the band edge.
- (7) The emission measurements shall be performed using a minimum resolution bandwidth of 1 MHz. A lower resolution bandwidth may be employed near the band edge, when necessary, provided the measured energy is integrated to show the total power over 1 MHz.
- (8) Unwanted emissions below 1 GHz must comply with the general field strength limits set forth in §15.209. Further, any U-NII devices using an AC power line are required to comply also with the conducted limits set forth in §15.207.
- (9) The provisions of §15.205 apply to intentional radiators operating under this section.
- (10) When measuring the emission limits, the nominal carrier frequency shall be adjusted as close to the upper and lower frequency band edges as the design of the equipment permits.
- (c) The device shall automatically discontinue transmission in case of either absence of information to transmit or operational failure. These provisions are not intended to preclude the transmission of control or signalling information, or the use of repetitive codes used by certain digital technologies to complete frame or burst intervals. Applicants shall include in their application for equipment authorization a description of how this requirement is met.
- (e) Within the 5.725-5.85 GHz band, the minimum 6 dB bandwidth of U-NII devices shall be at least 500 kHz.
- (f) Radio frequency devices operating under the provisions of this part are subject to the radio frequency radiation exposure requirements specified in §§1.1307(b), 1.1310, 2.1091, and 2.1093 of this chapter, as appropriate. All equipment shall be considered to operate in a “general population/uncontrolled” environment. Applications for equipment authorization of mobile or portable devices operating under this section must contain a statement

confirming compliance with these requirements. Technical information showing the basis for this statement must be submitted to the Commission upon request.

- (g) Manufacturers of U-NII devices are responsible for ensuring frequency stability such that an emission is maintained within the band of operation under all conditions of normal operation as specified in the user’s manual.

RSS-247 Issue 2

6. Technical requirements for license-exempt local area network devices and digital transmission systems operating in the 5 GHz band

This section provides standards for License-Exempt Local Area Network (LE-LAN) devices operating in the bands 5150-5250 MHz, 5250-5350 MHz, 5470-5600 MHz, 5650-5725 MHz, and 5725-5850 MHz and for DTS’s operating in the band 5725-5850 MHz that employ digital modulation technology but are not designed for LE-LAN operation.

Devices with occupied bandwidths which overlap different bands shall comply with all operational requirements for each band.

6.2.1 Frequency band 5150-5250 MHz

LE-LAN devices are restricted to indoor operation only in the band 5150-5250 MHz. However, original equipment manufacturer (OEM) devices, which are installed in vehicles-by-vehicles manufacturers, are permitted.

Figure 5 Plot of Transmitter Emissions Across 5150-5250 MHz Mode 9, U-NII-1 (802.11a)

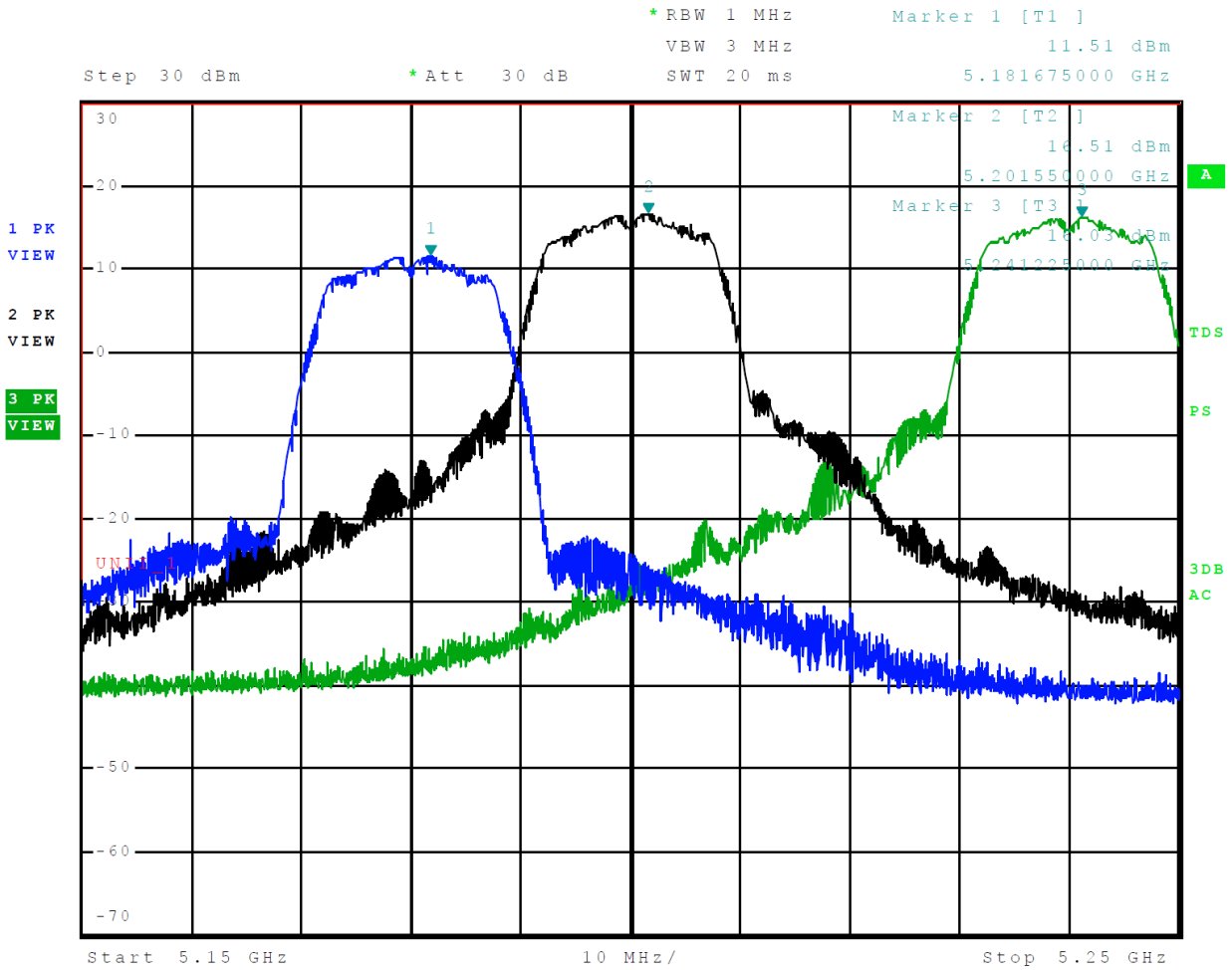

Figure 6 Plot of Transmitter Emissions Across 5150-5250 MHz Mode 10, U-NII-1 (802.11n)

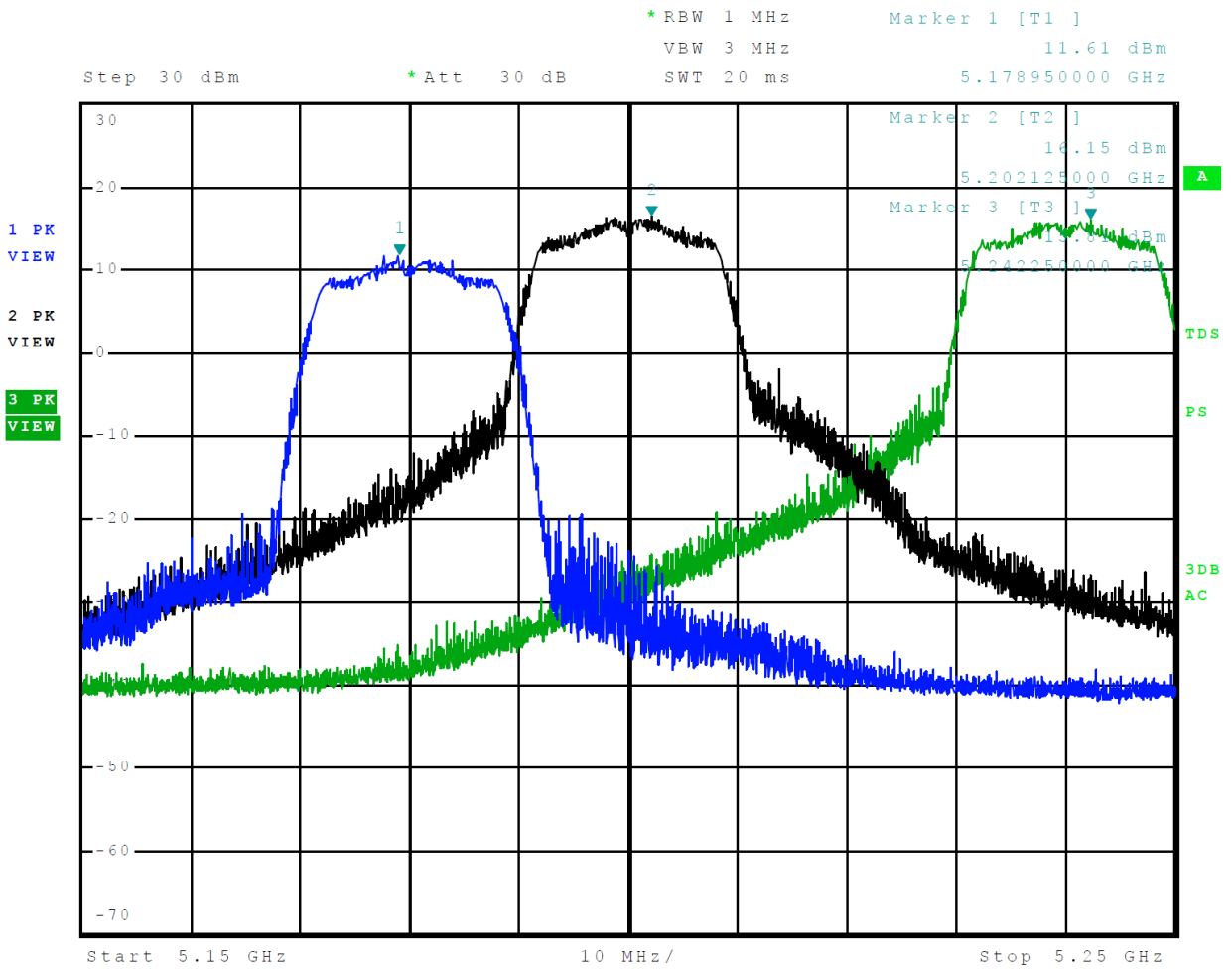

Figure 7 Plot of Transmitter Emissions Across 5150-5250 MHz Mode 11, U-NII-1 (802.11n40)

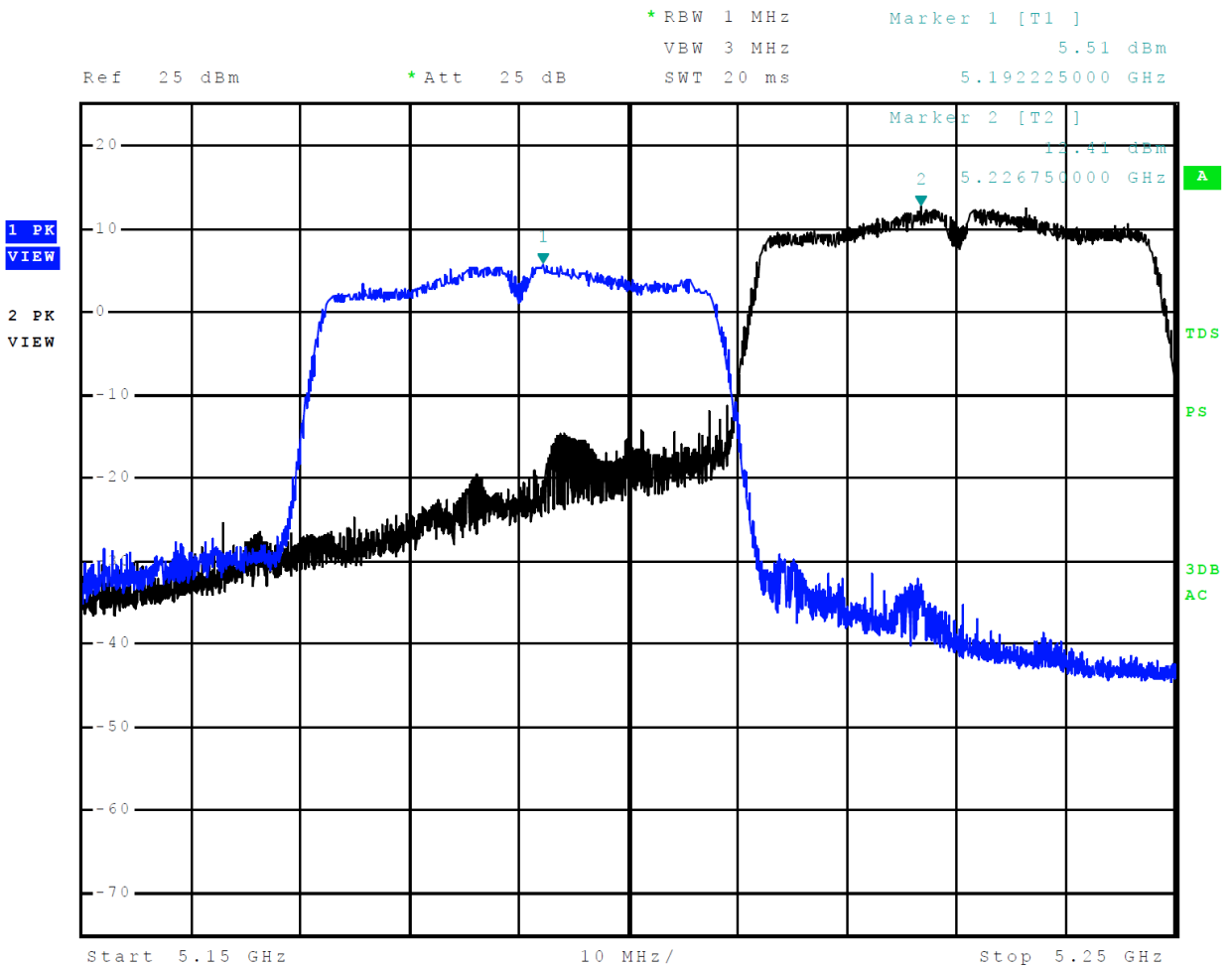

Figure 8 Plot of Lower Band Edge Across 5150-5250 MHz Mode 9, U-NII-1 (802.11a)

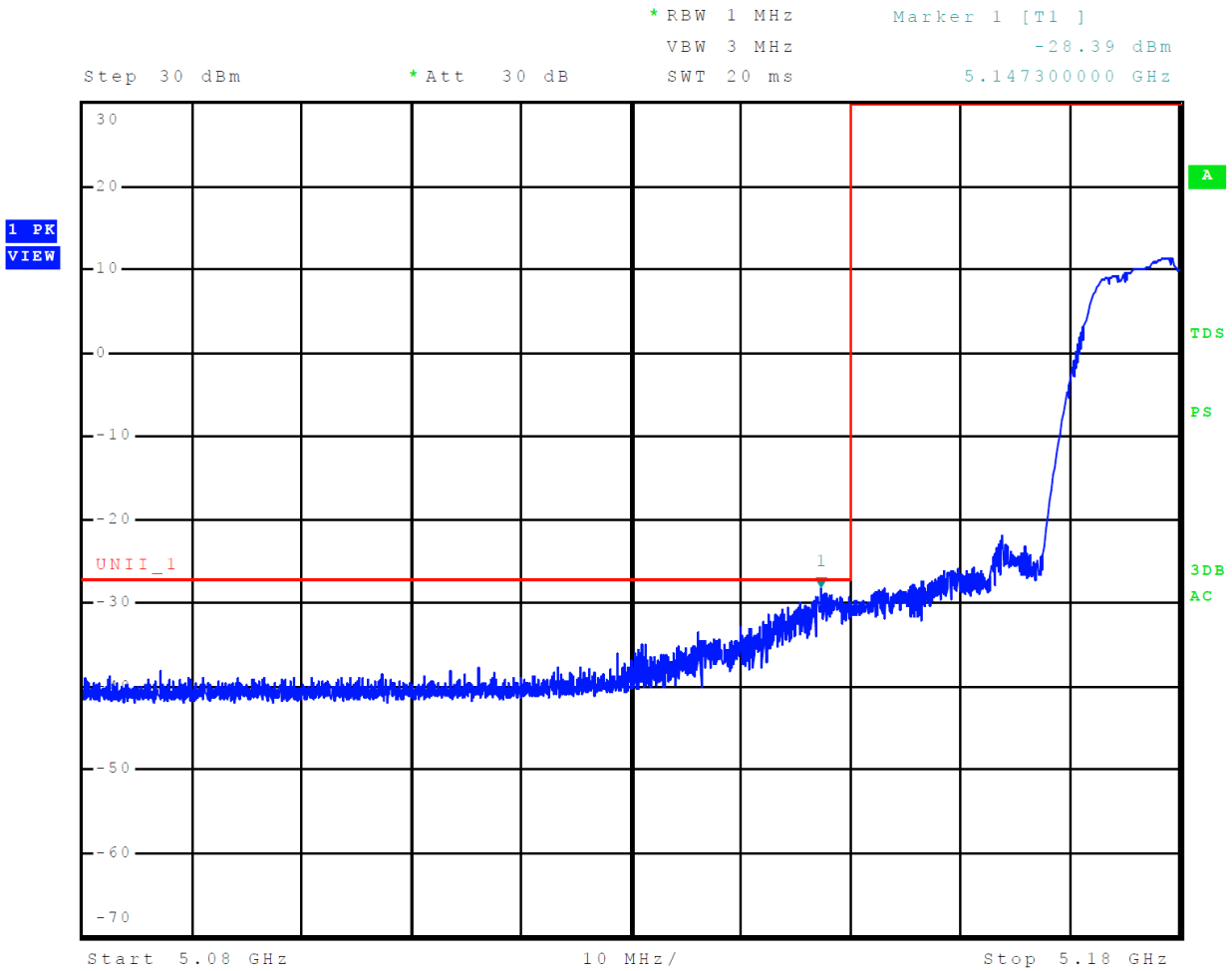

Figure 9 Plot of Lower Band Edge Across 5150-5250 MHz Mode 10, U-NII-1 (802.11n)

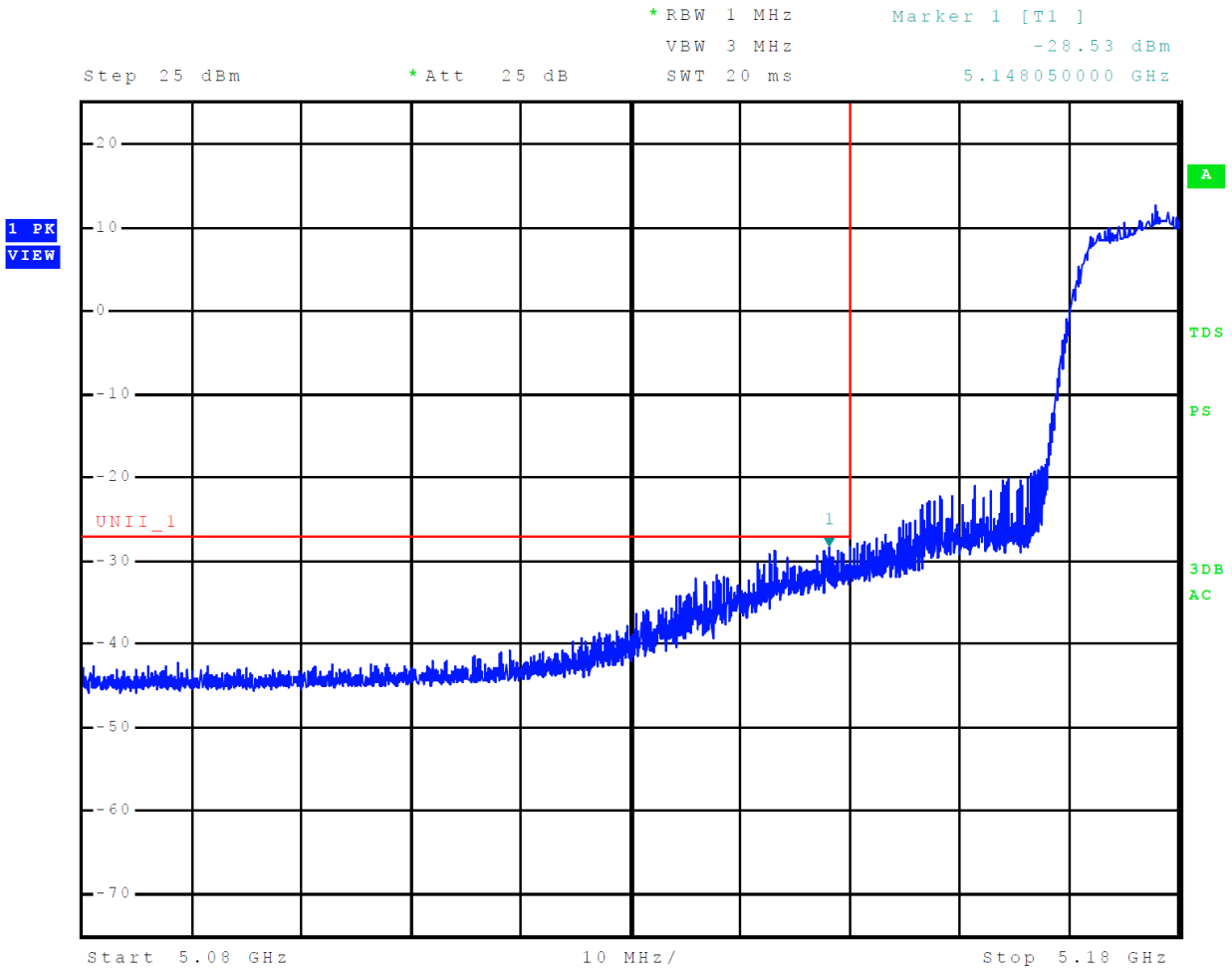

Figure 10 Plot of Lower Band Edge Across 5150-5250 MHz Mode 11, U-NII-1 (802.11n40)

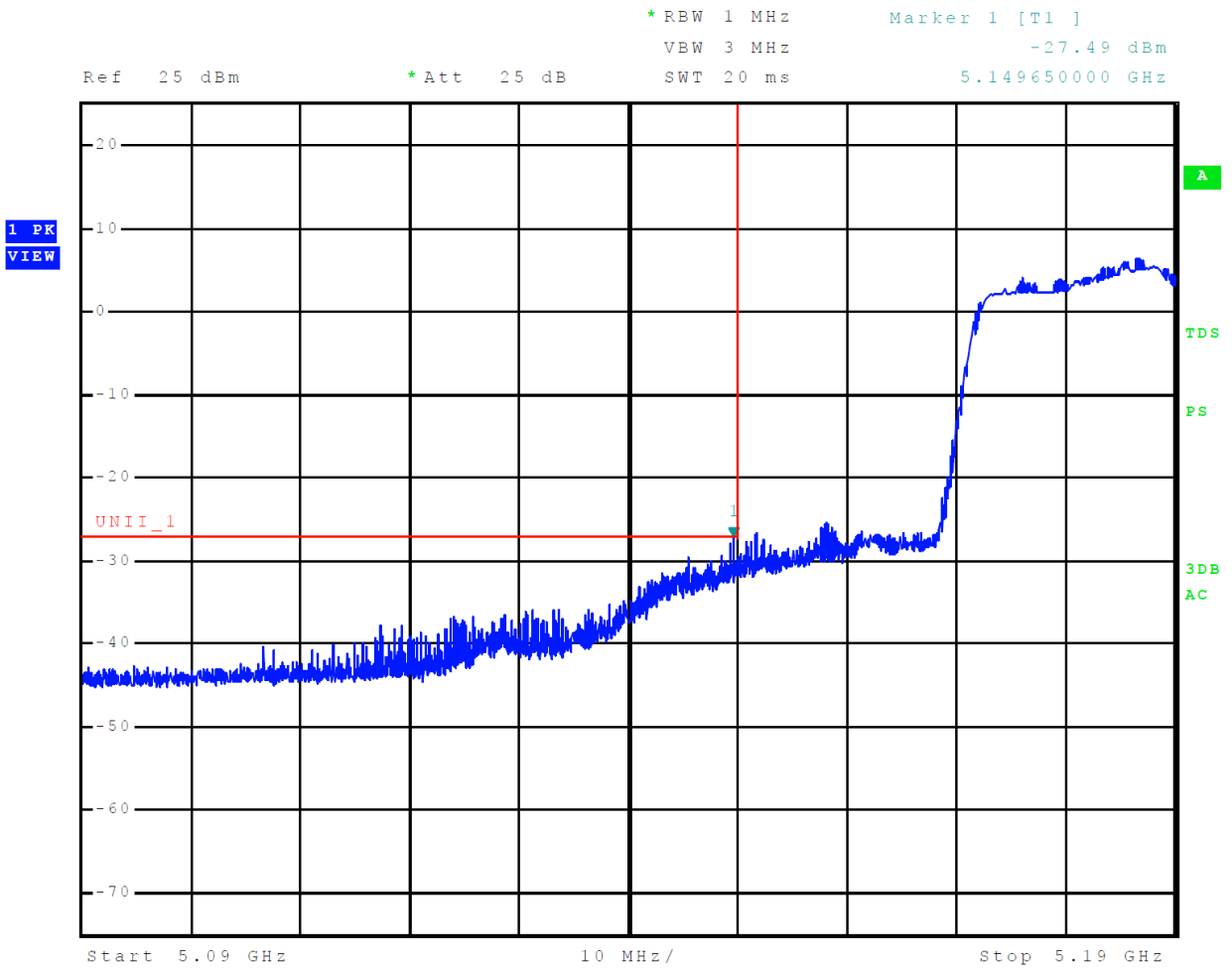

Figure11 Plot of Upper Band Edge Across 5150-5250 MHz Mode 9, U-NII-1 (802.11a)

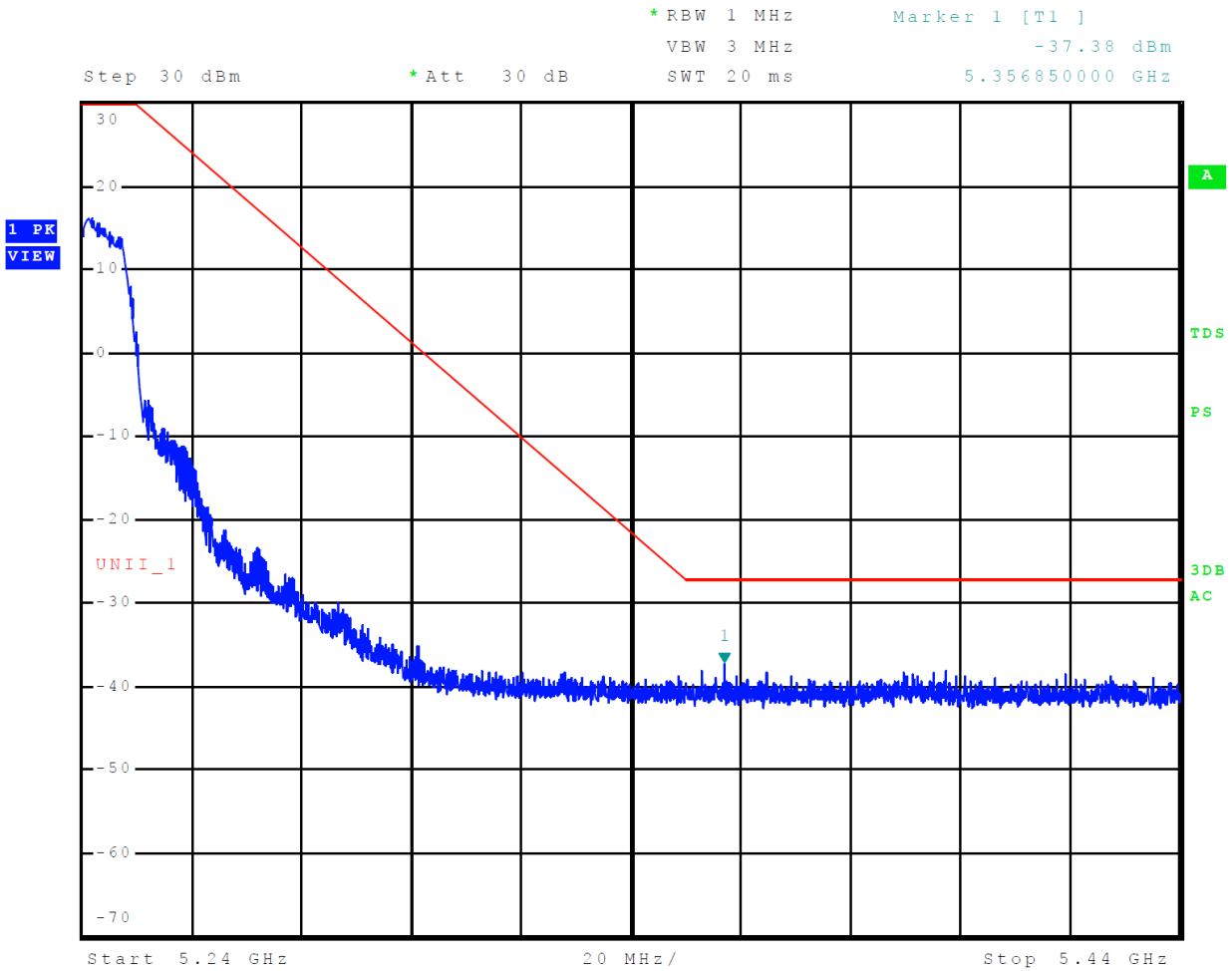

Figure 12 Plot of Upper Band Edge Across 5150-5250 MHz Mode 10, U-NII-1 (802.11n)

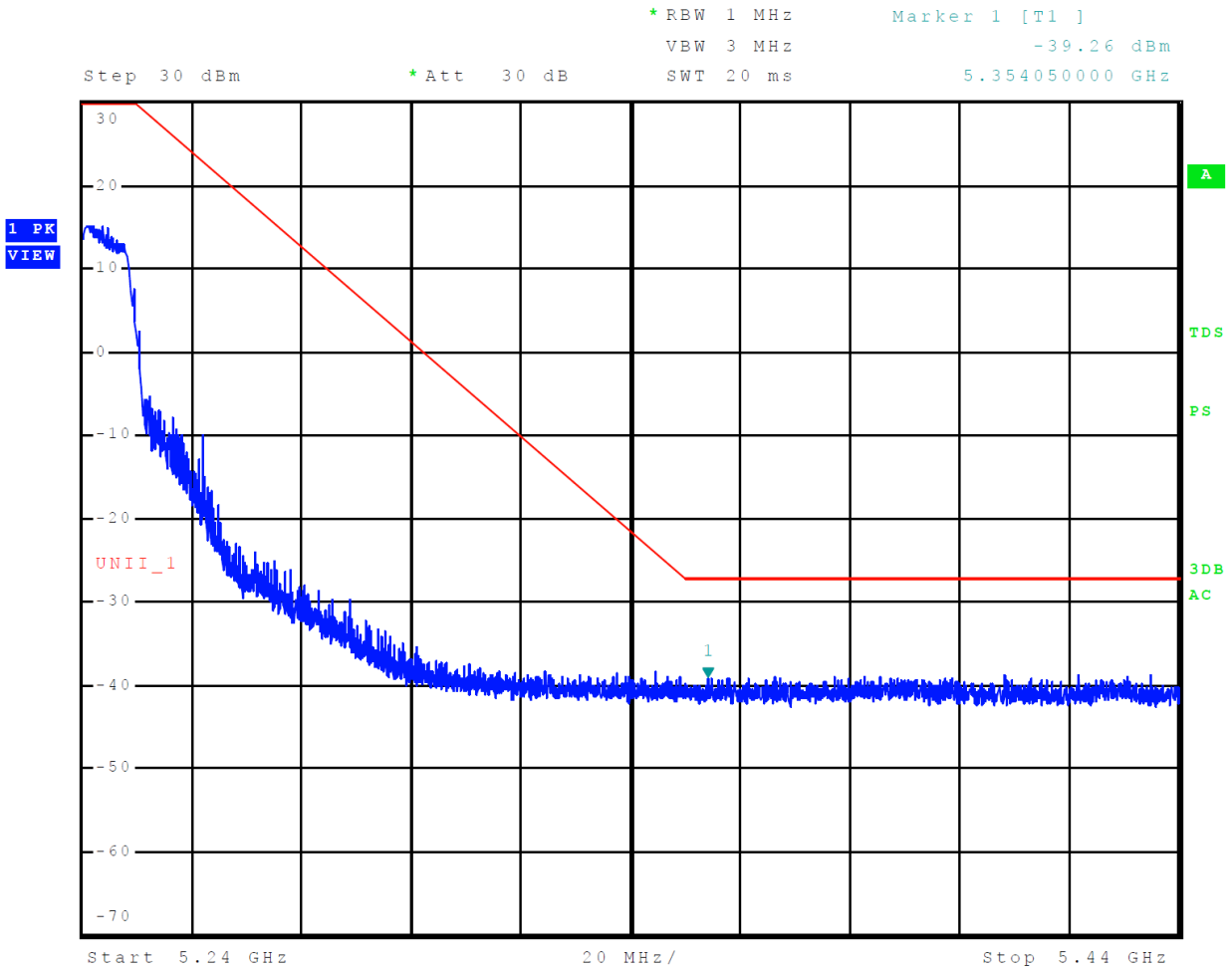

Figure 13 Plot of Upper Band Edge Across 5150-5250 MHz Mode 11, U-NII-1 (802.11n40)

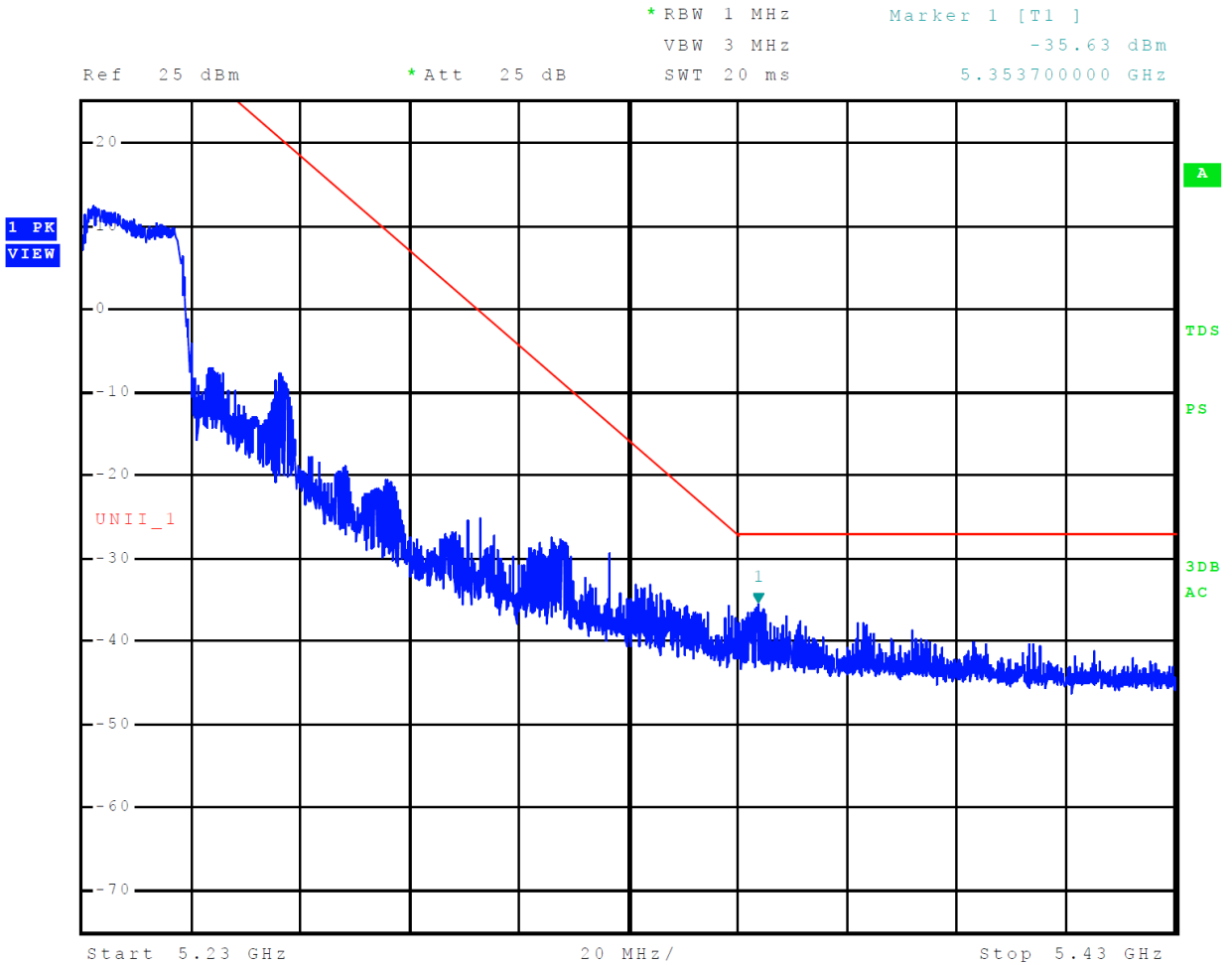

Figure 14 Plot of 26-dB Occupied Bandwidth 5150-5250 MHz Mode 9, U-NII-1 (802.11a)

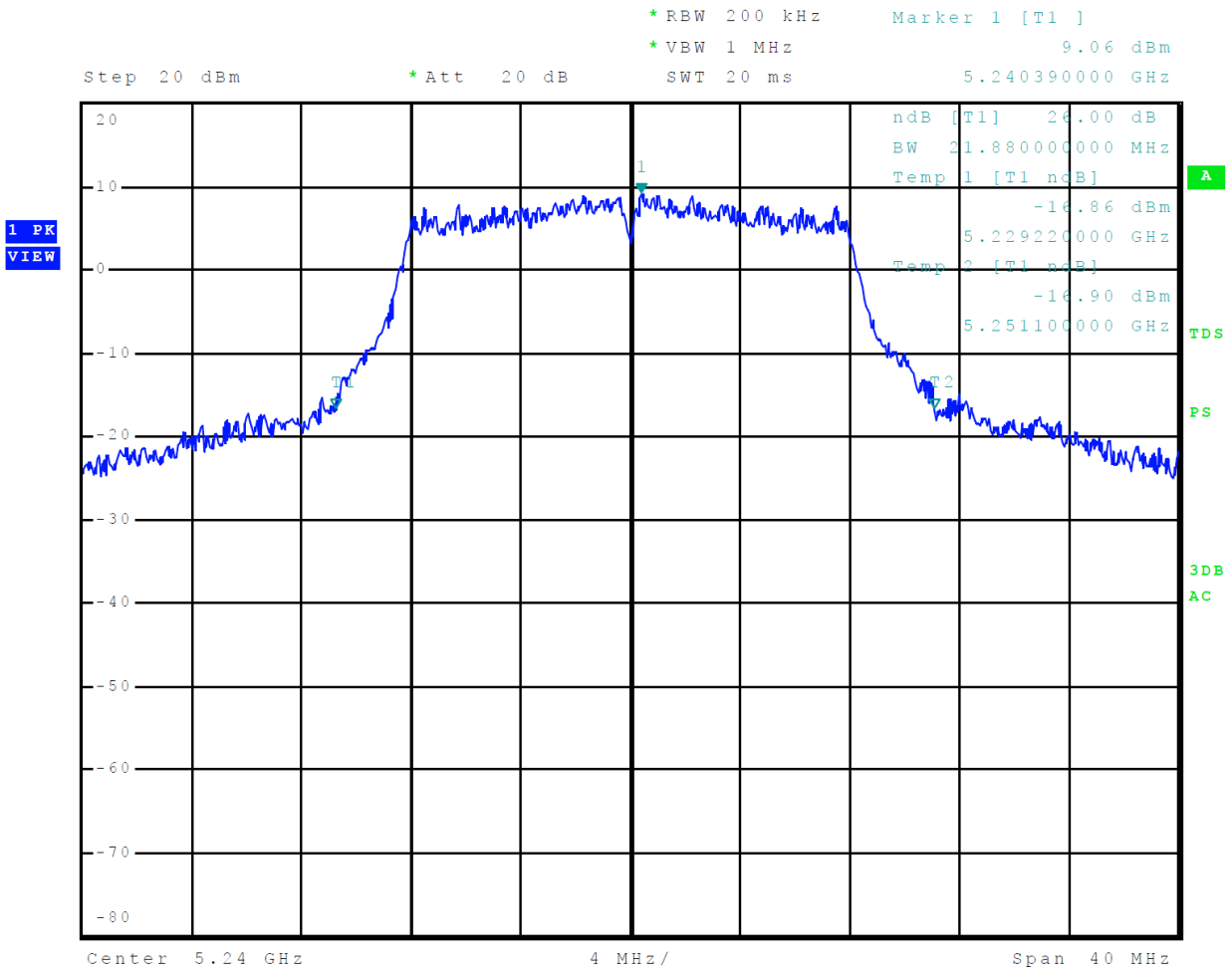

Figure 15 Plot of 26-dB Occupied Bandwidth 5150-5250 MHz Mode 10, U-NII-1 (802.11n)

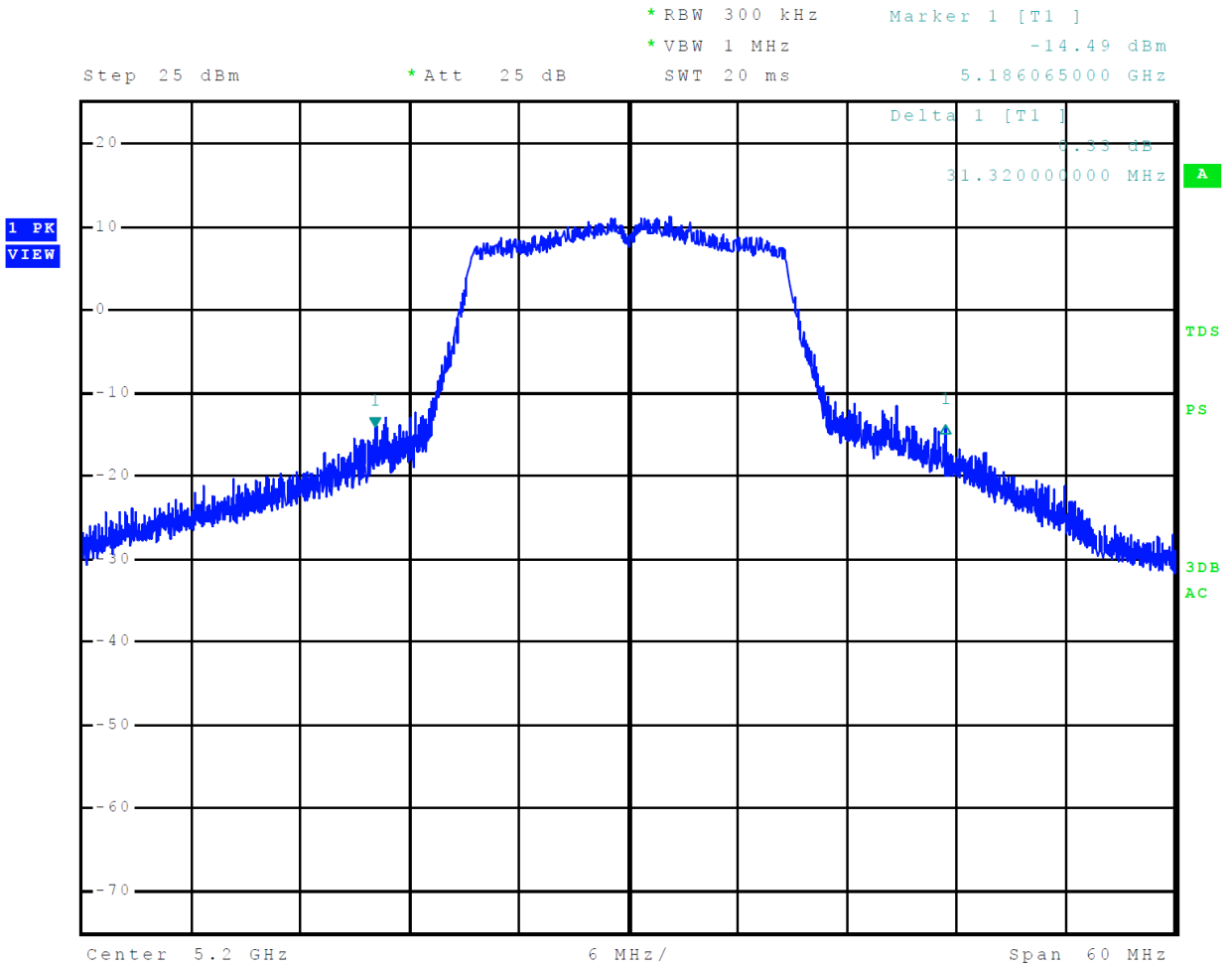

Figure 17 Plot of 99% Occupied Bandwidth 5150-5250 MHz Mode 9, U-NII-1 (802.11a)

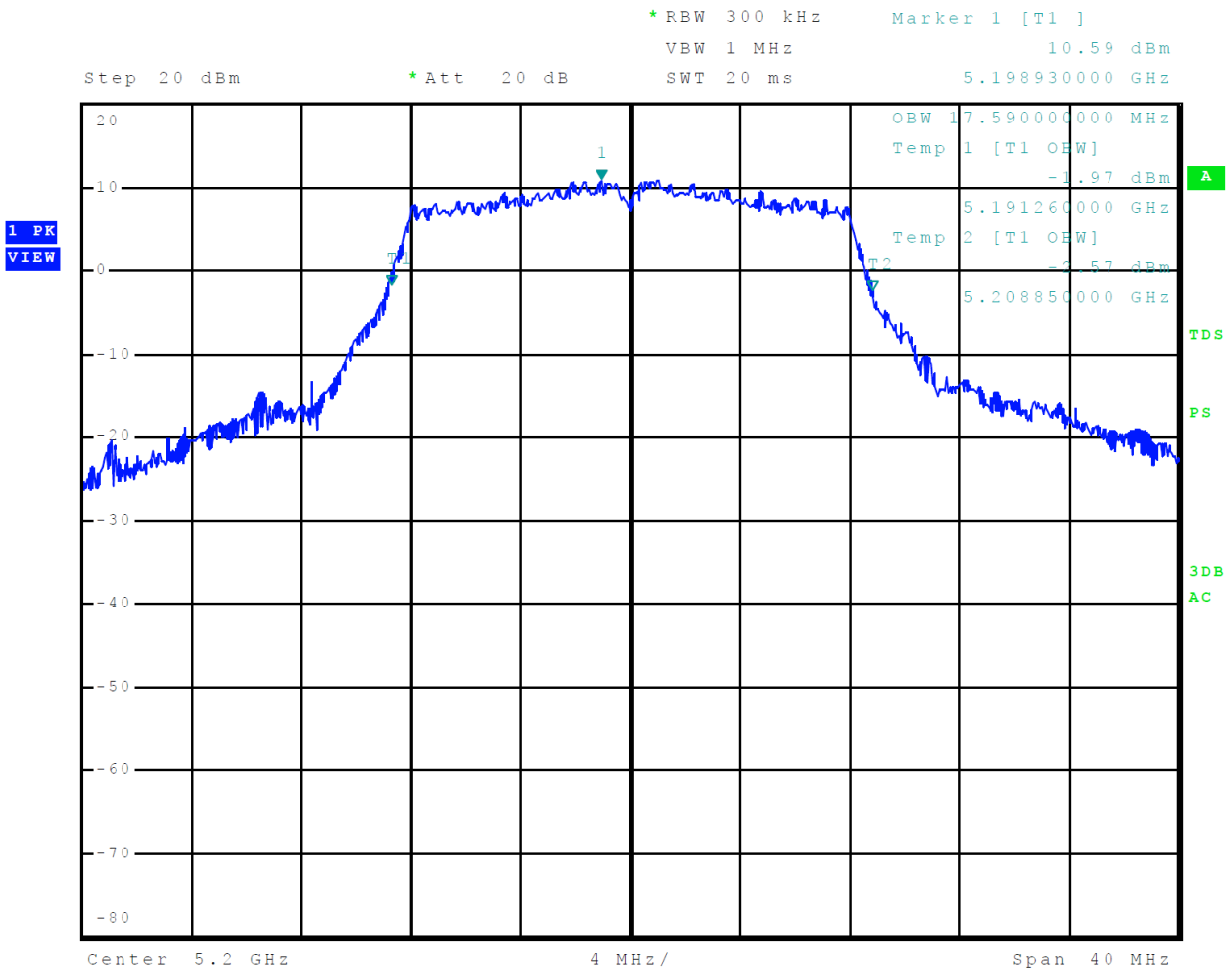

Figure 19 Plot of 99% Occupied Bandwidth 5150-5250 MHz Mode 11, U-NII-1 (802.11n40)

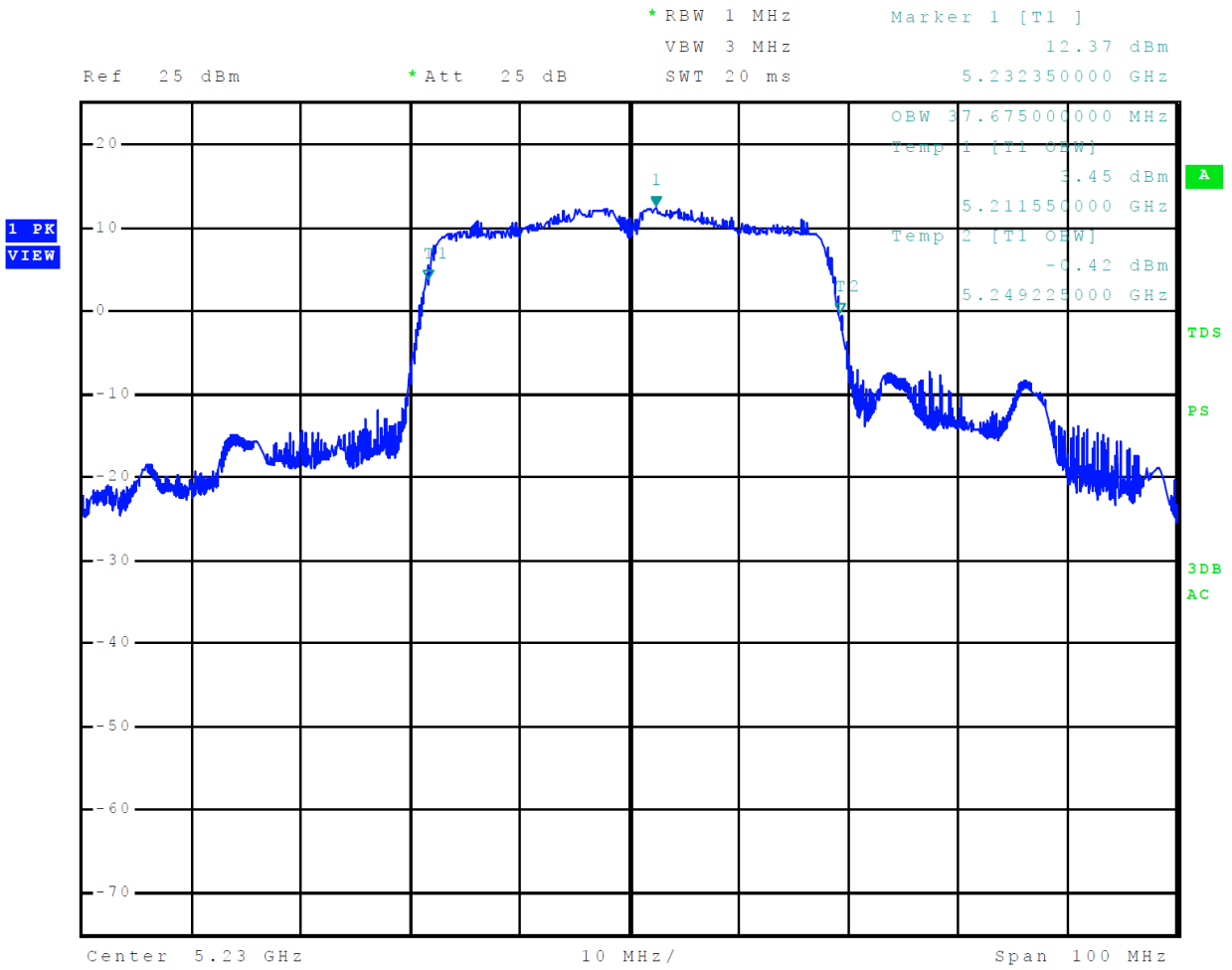

Figure 20 Plot of Transmitter Emissions Across 5725-5850 MHz Mode 12, U-NII-3 (802.11a)

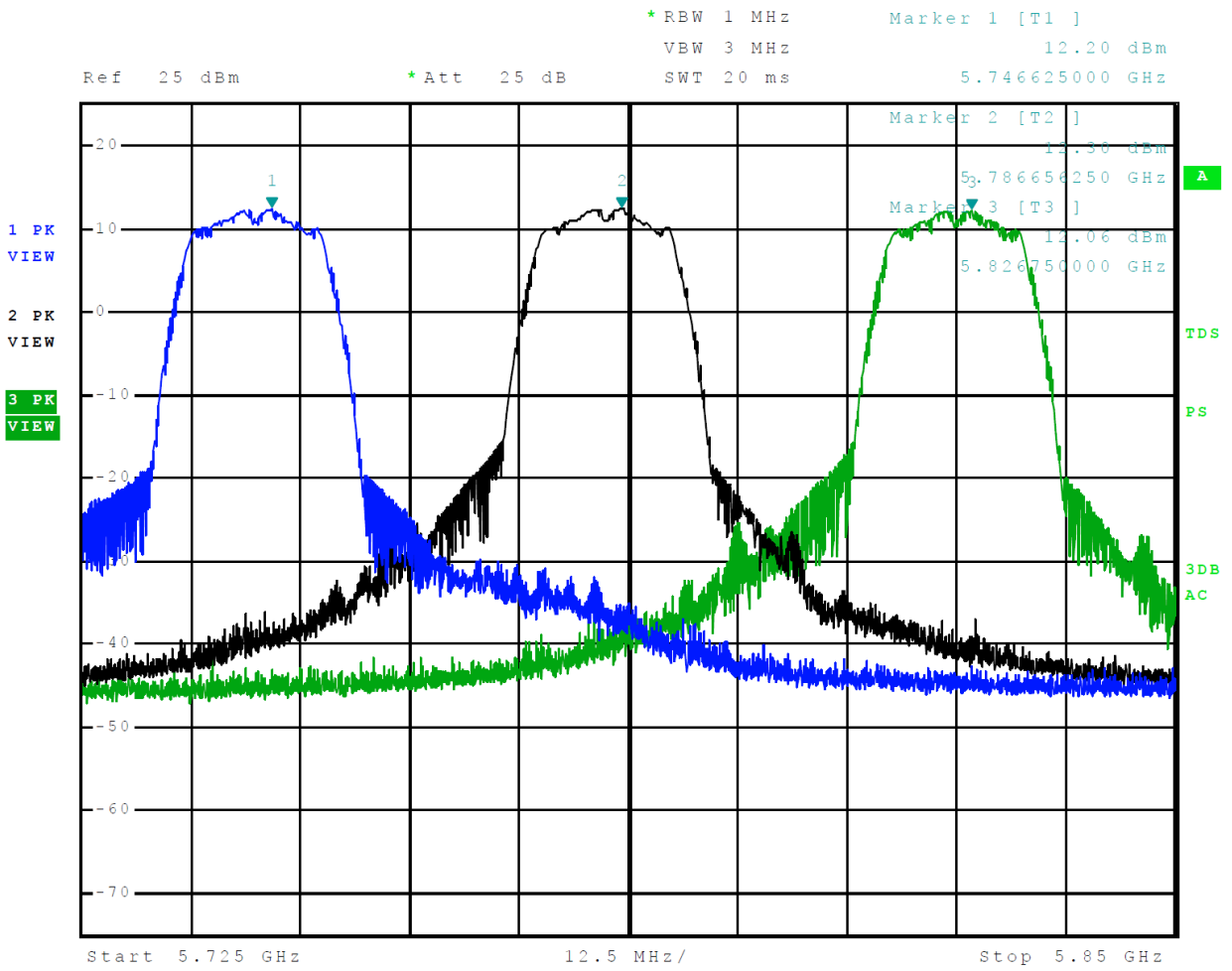

Figure 21 Plot of Transmitter Emissions Across 5725-5850 MHz Mode 13, U-NII-3 (802.11n)

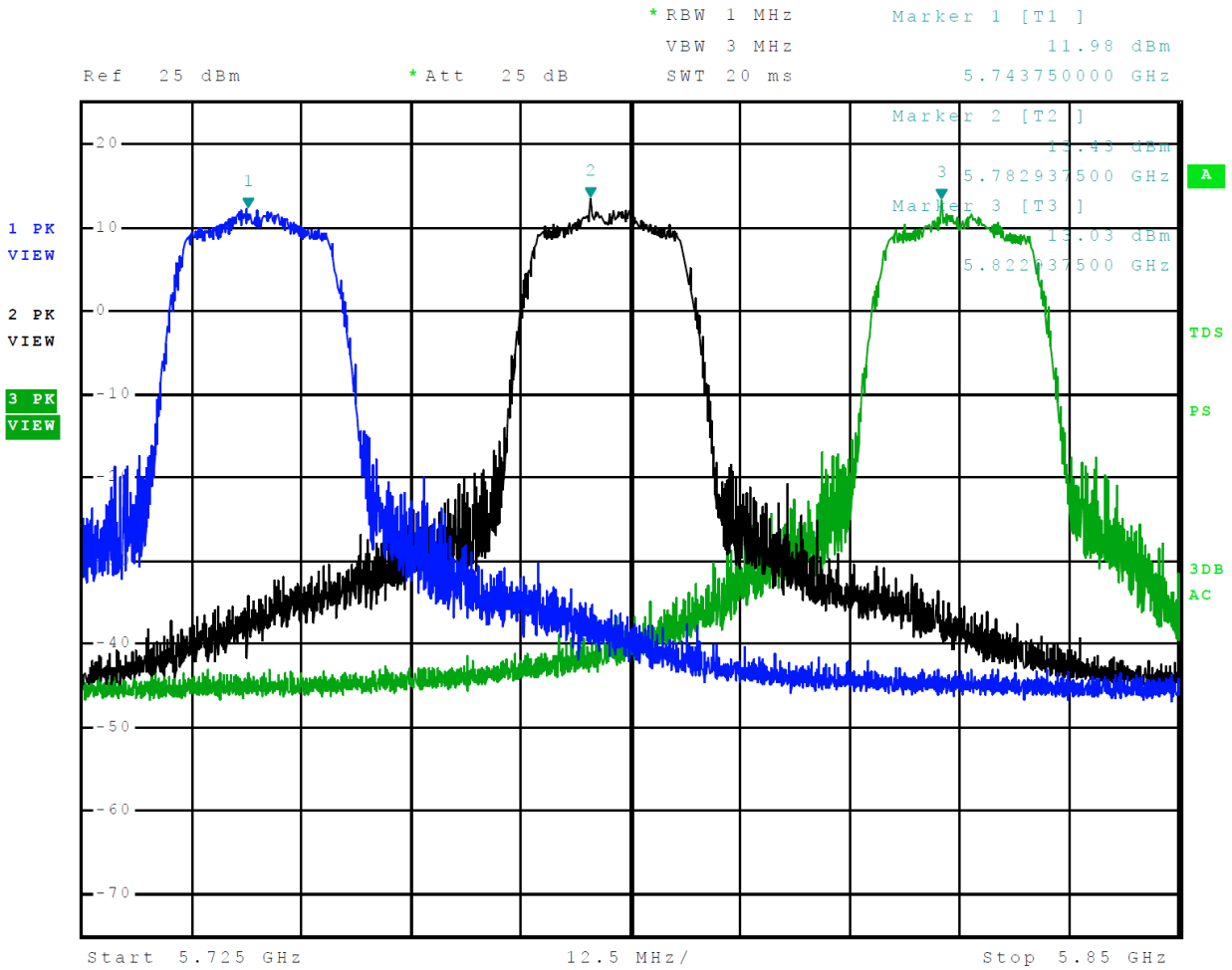

Figure 22 Plot of Transmitter Emissions Across 5725-5850 MHz Mode 14, U-NII-3 (802.11n40)

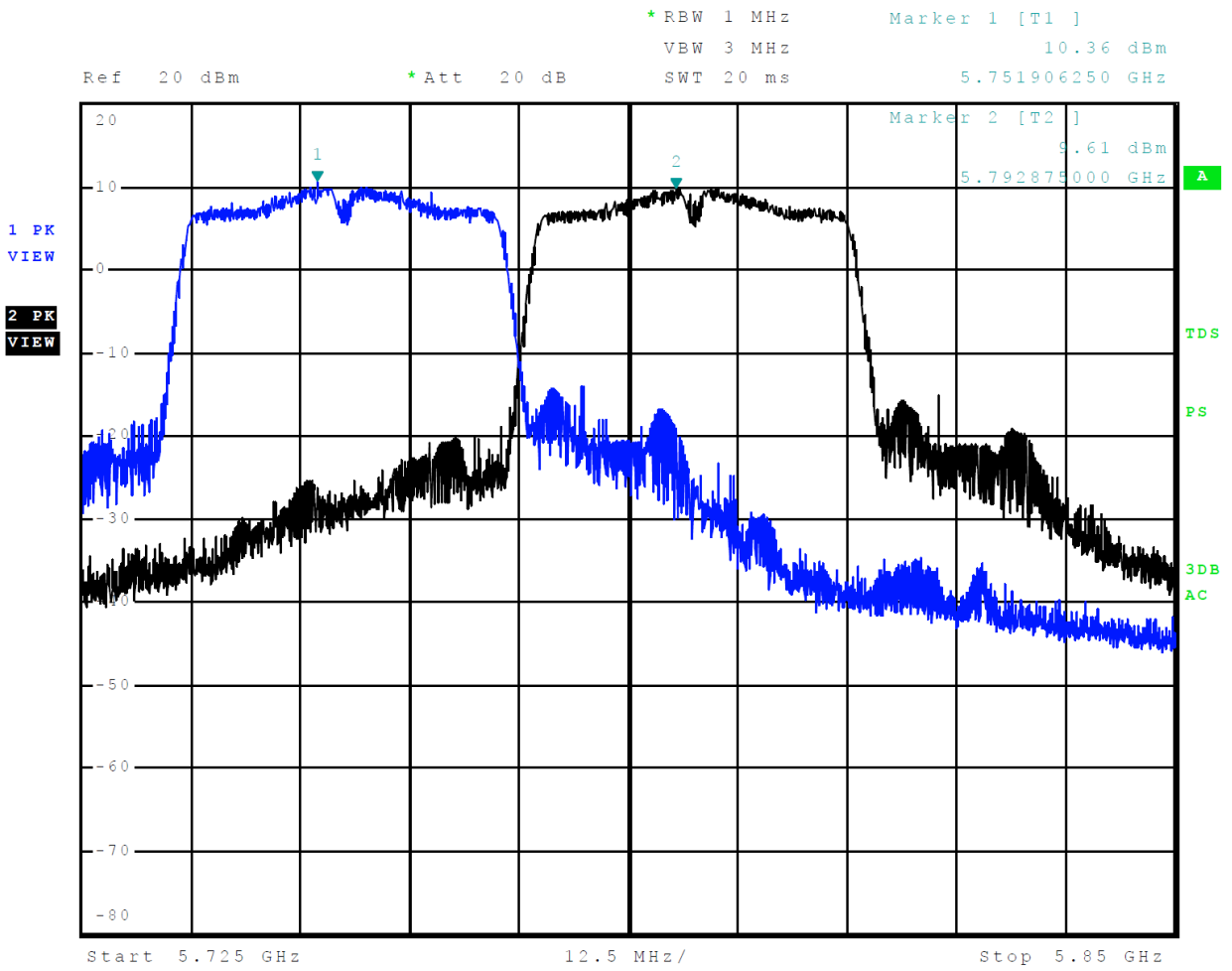

Figure 23 Plot of Lower Band Edge Across 5725-5850 MHz Mode 12, U-NII-3 (802.11a)

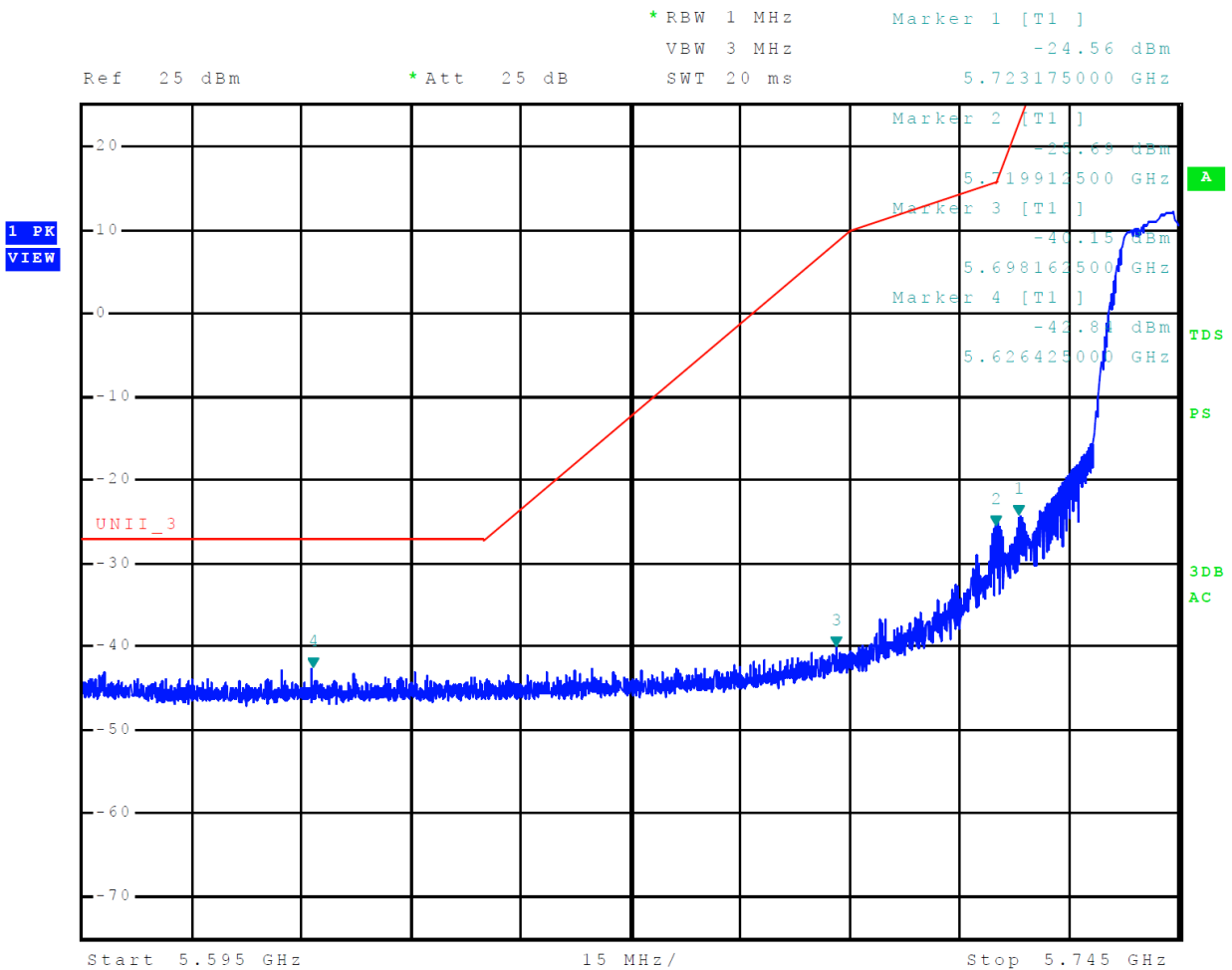

Figure 24 Plot of Lower Band Edge Across 5725-5850 MHz Mode 13, U-NII-3 (802.11n)

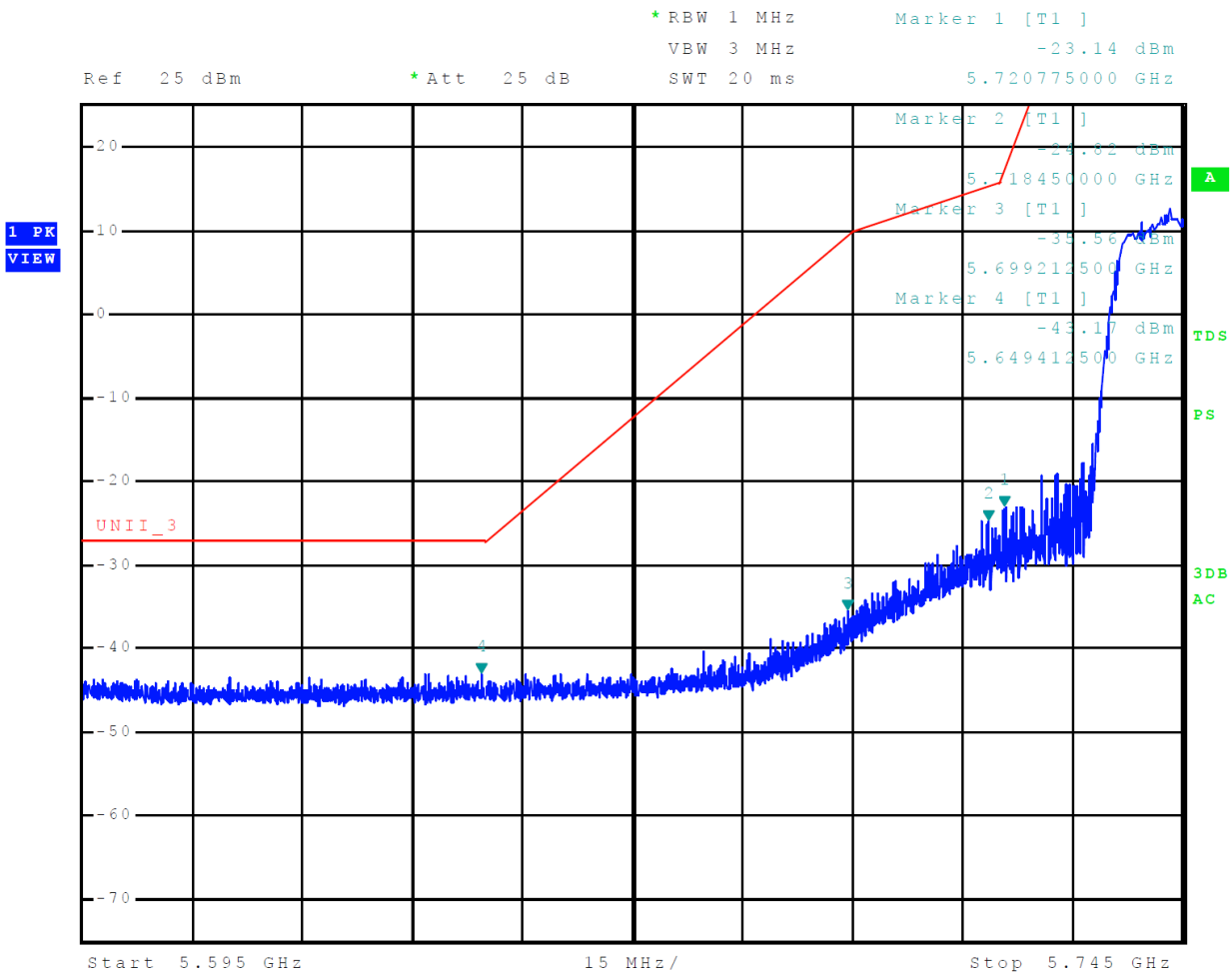

Figure 25 Plot of Lower Band Edge Across 5725-5850 MHz Mode 14, U-NII-3 (802.11n40)

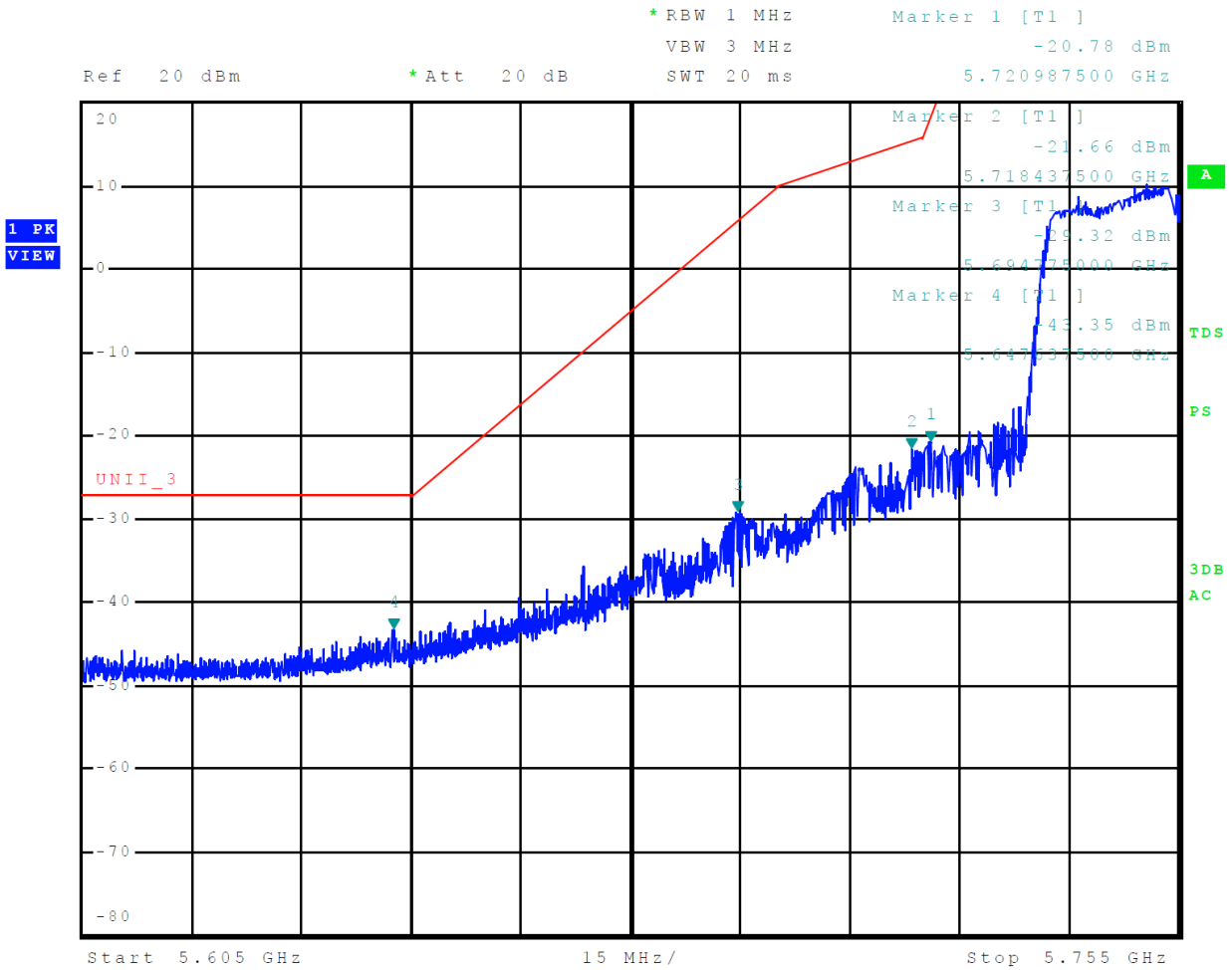

Figure 26 Plot of Upper Band Edge Across 5725-5850 MHz Mode 12, U-NII-3 (802.11a)

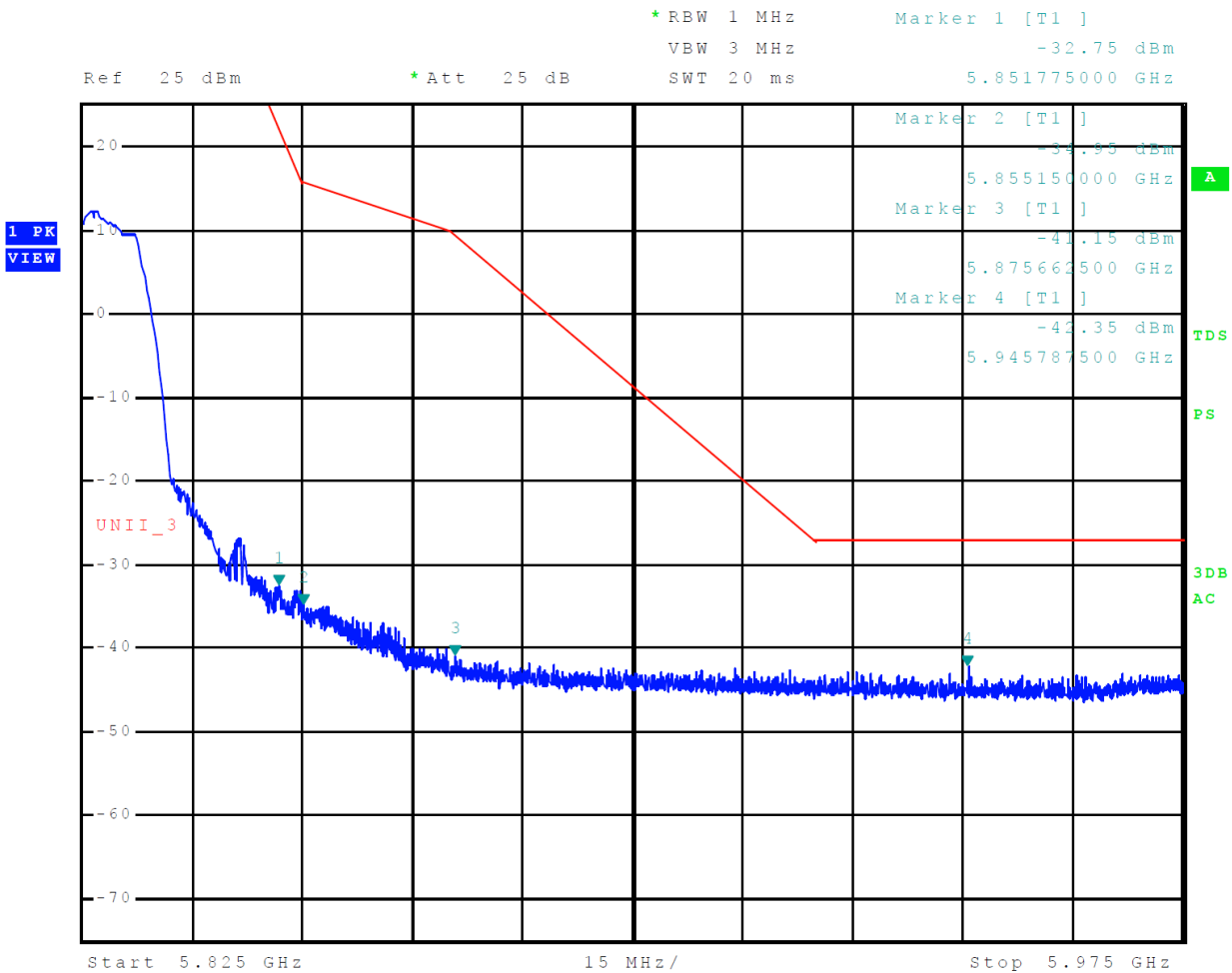

Figure 27 Plot of Upper Band Edge Across 5725-5850 MHz Mode 13, U-NII-3 (802.11n)

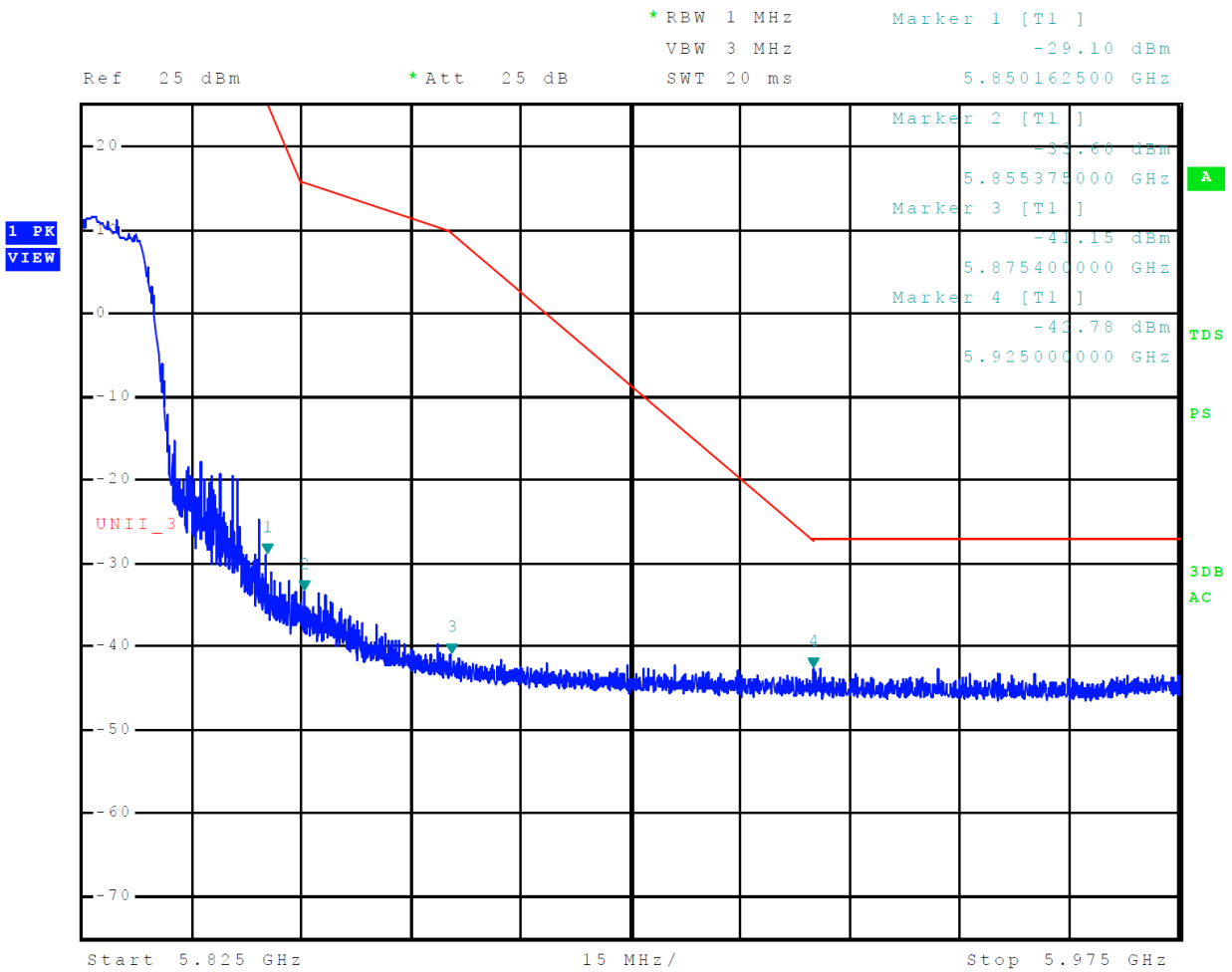

Figure 28 Plot of Upper Band Edge Across 5725-5850 MHz Mode 14, U-NII-3 (802.11n40)

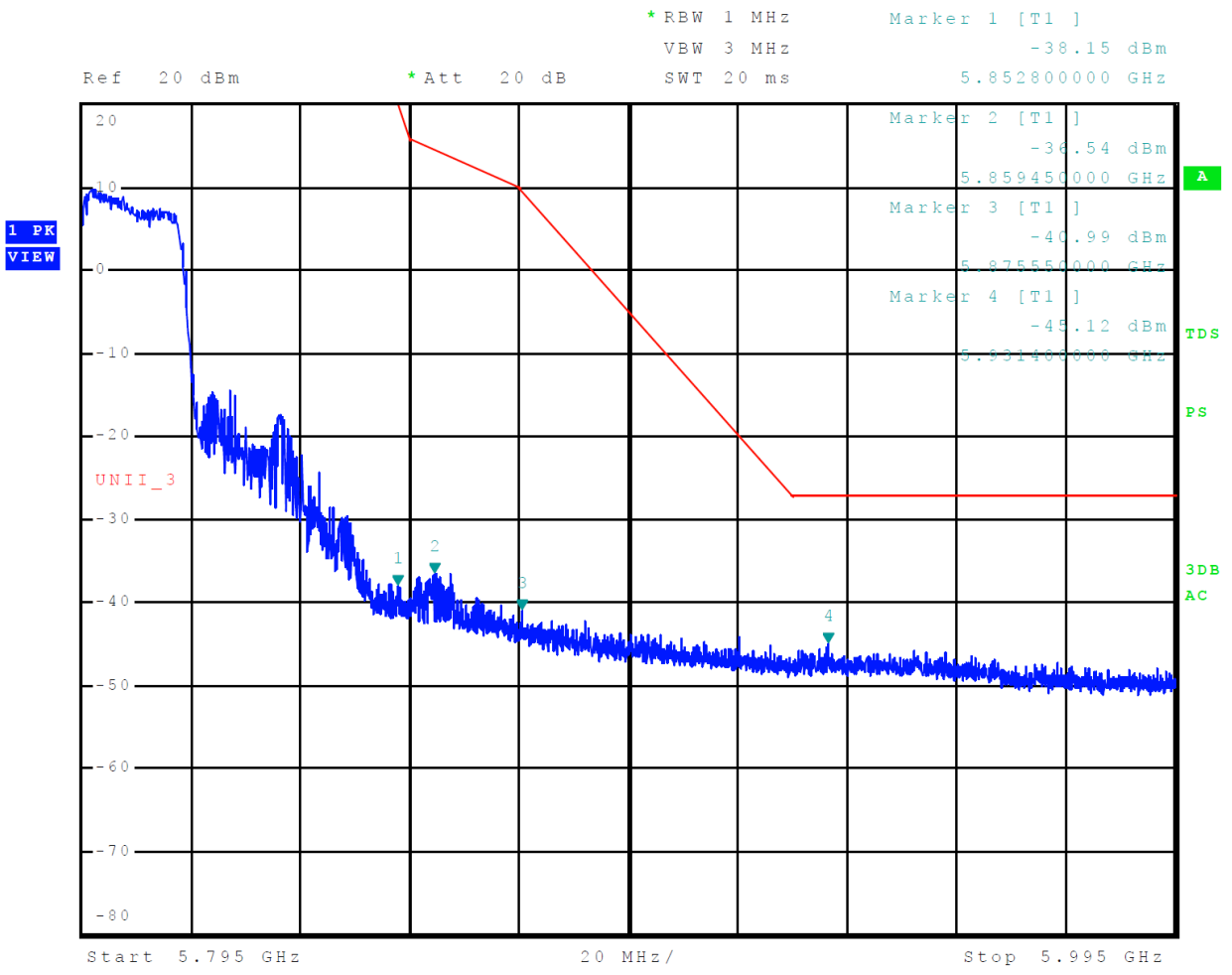

Figure 29 Plot of 99% Occupied Bandwidth 5725-5850 MHz Mode 12, U-NII-3 (802.11a)

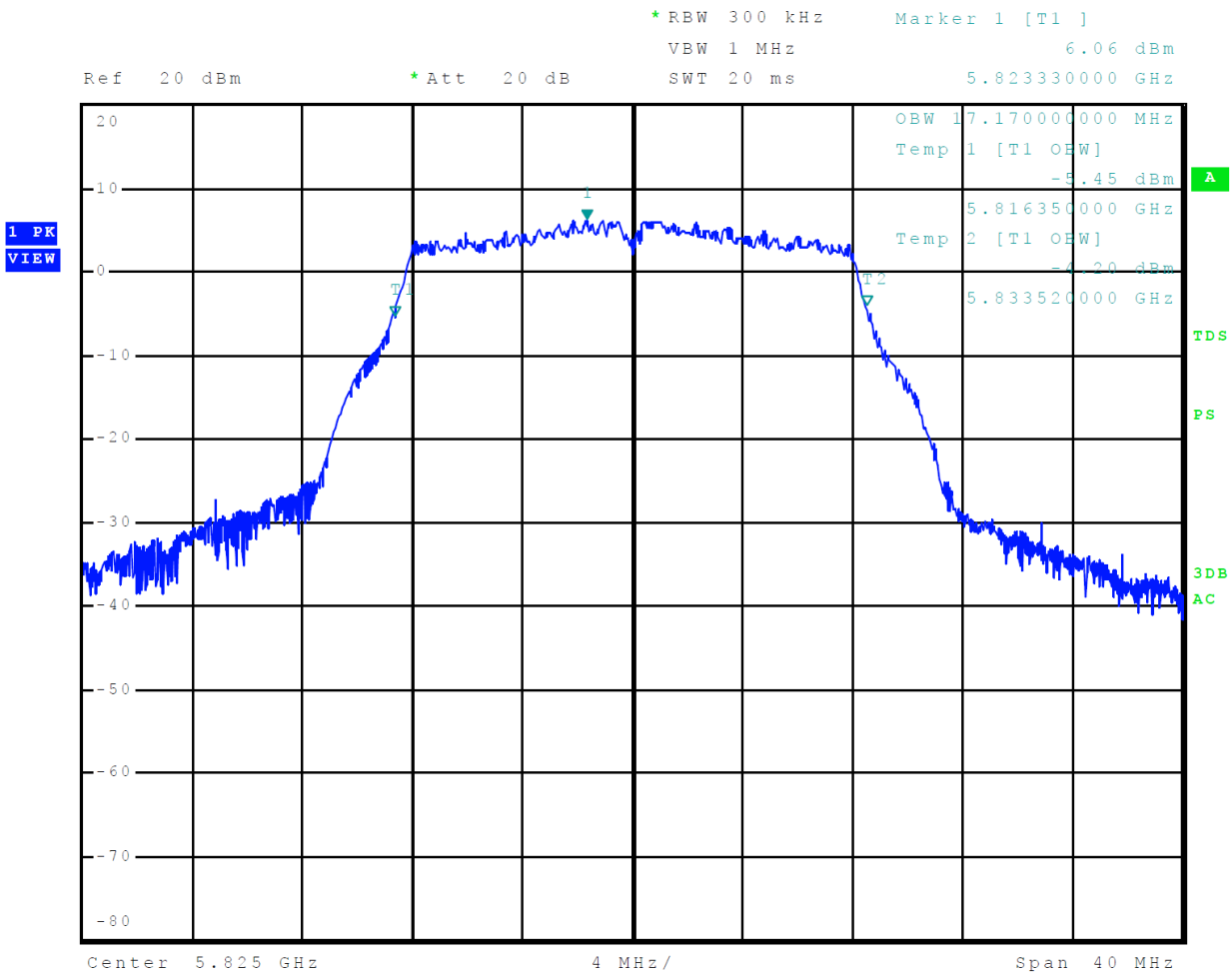
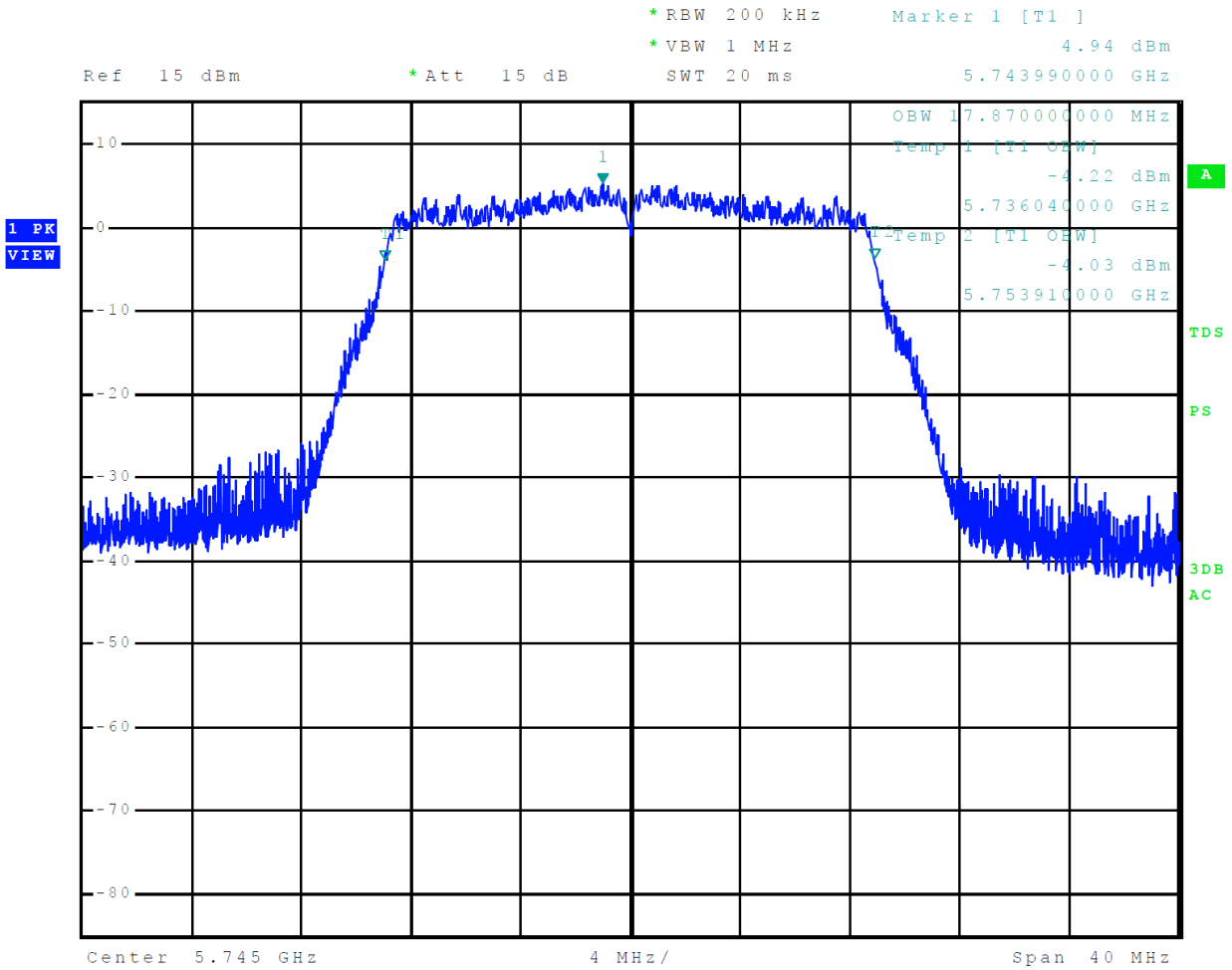

Figure 30 Plot of 99% Occupied Bandwidth 5725-5850 MHz Mode 13, U-NII-3 (802.11n)



Rogers Labs, Inc.
 4405 West 259th Terrace
 Louisburg, KS 66053
 Phone/Fax: (913) 837-3214
 Revision r2

Garmin International, Inc.
 Model: A04577
 Test: 221013
 Test to: 47CFR 15E, RSS-Gen RSS-247
 File: A04577 NII TstRpt 221013 r2

SN's: 3432729295 / 3432729465
 FCC ID: IPH-04577
 IC: 1792A-04577
 Date: March 9, 2023
 Page 65 of 98

Figure 31 Plot of 99% Occupied Bandwidth 5725-5850 MHz Mode 14, U-NII-3 (802.11n40)

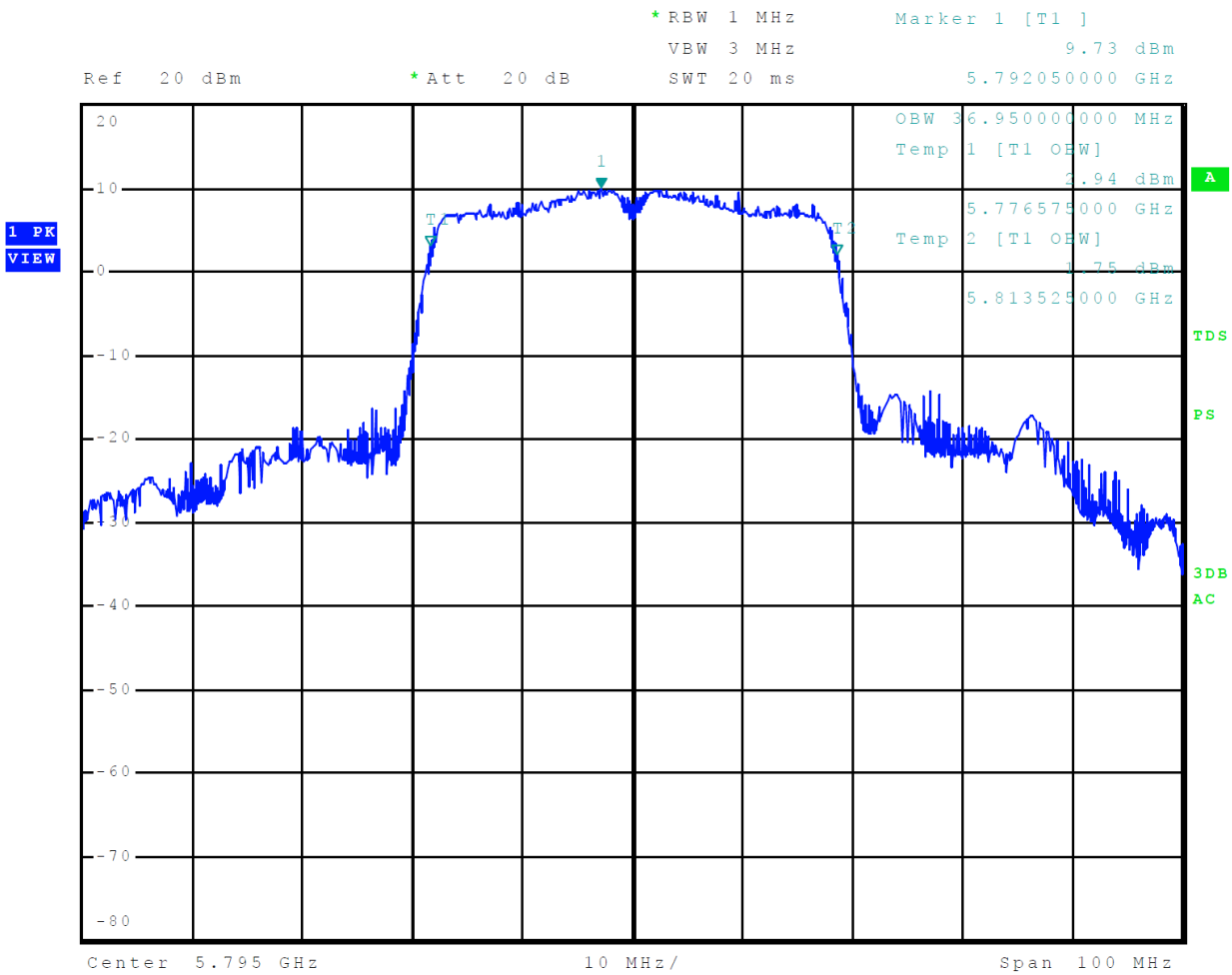

Figure 32 Plot of 6-dB Occupied Bandwidth 5725-5850 MHz Mode 12, U-NII-3 (802.11a)

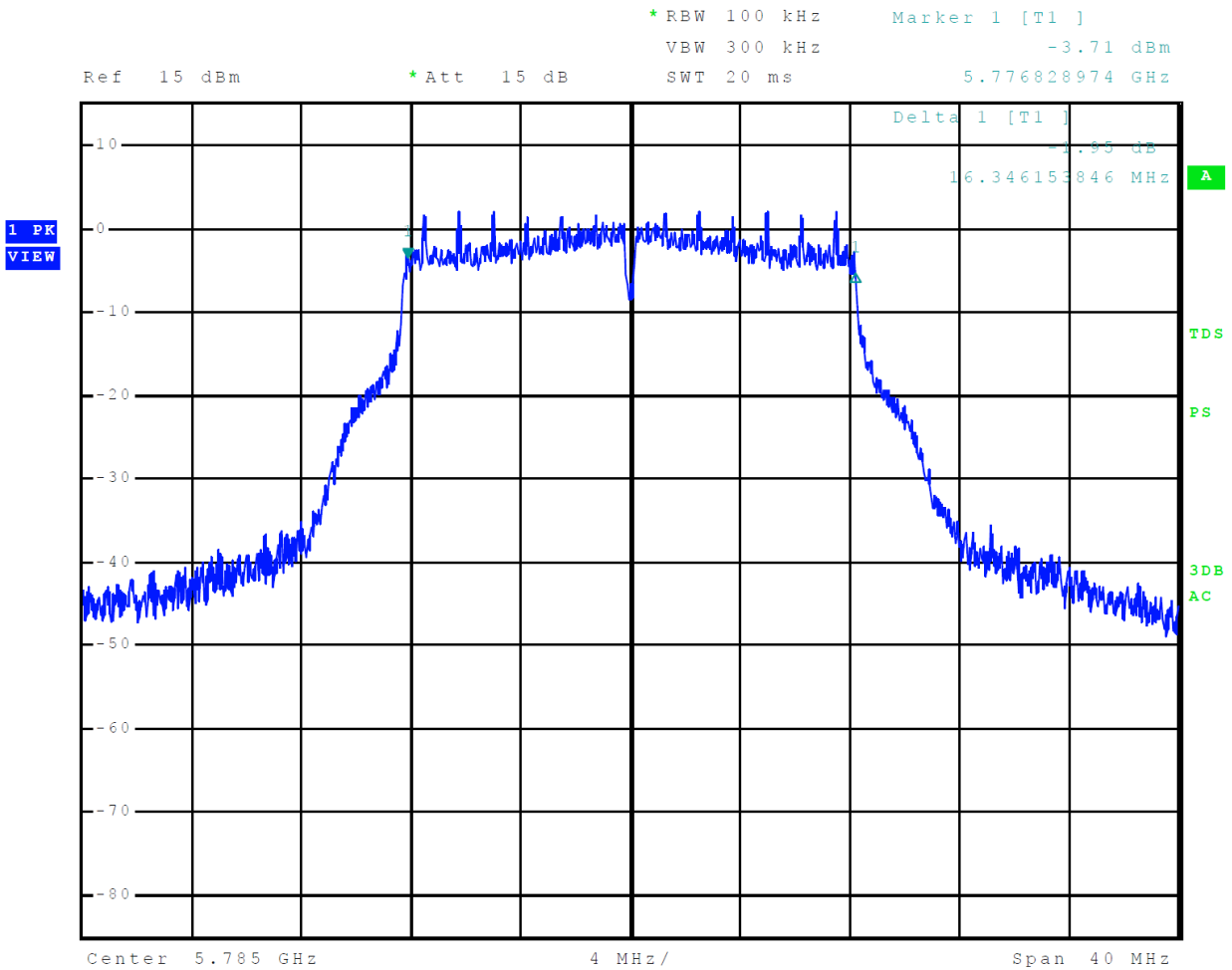

Figure 33 Plot of 6-dB Occupied Bandwidth 5725-5850 MHz Mode 13, U-NII-3 (802.11n)

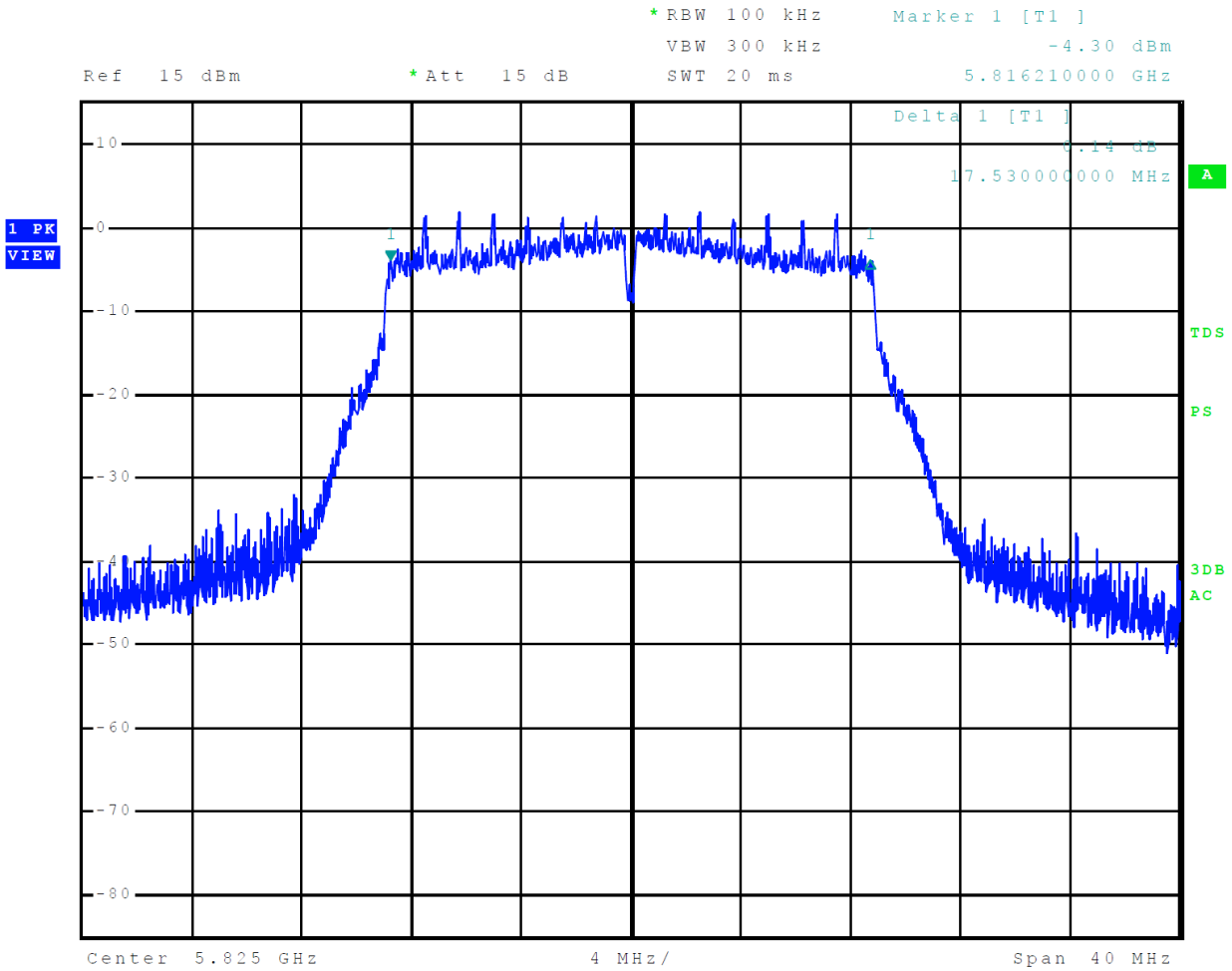

Figure 35 Plot of 26-dB Occupied Bandwidth 5725-5850 MHz Mode 12, U-NII-3 (802.11a)

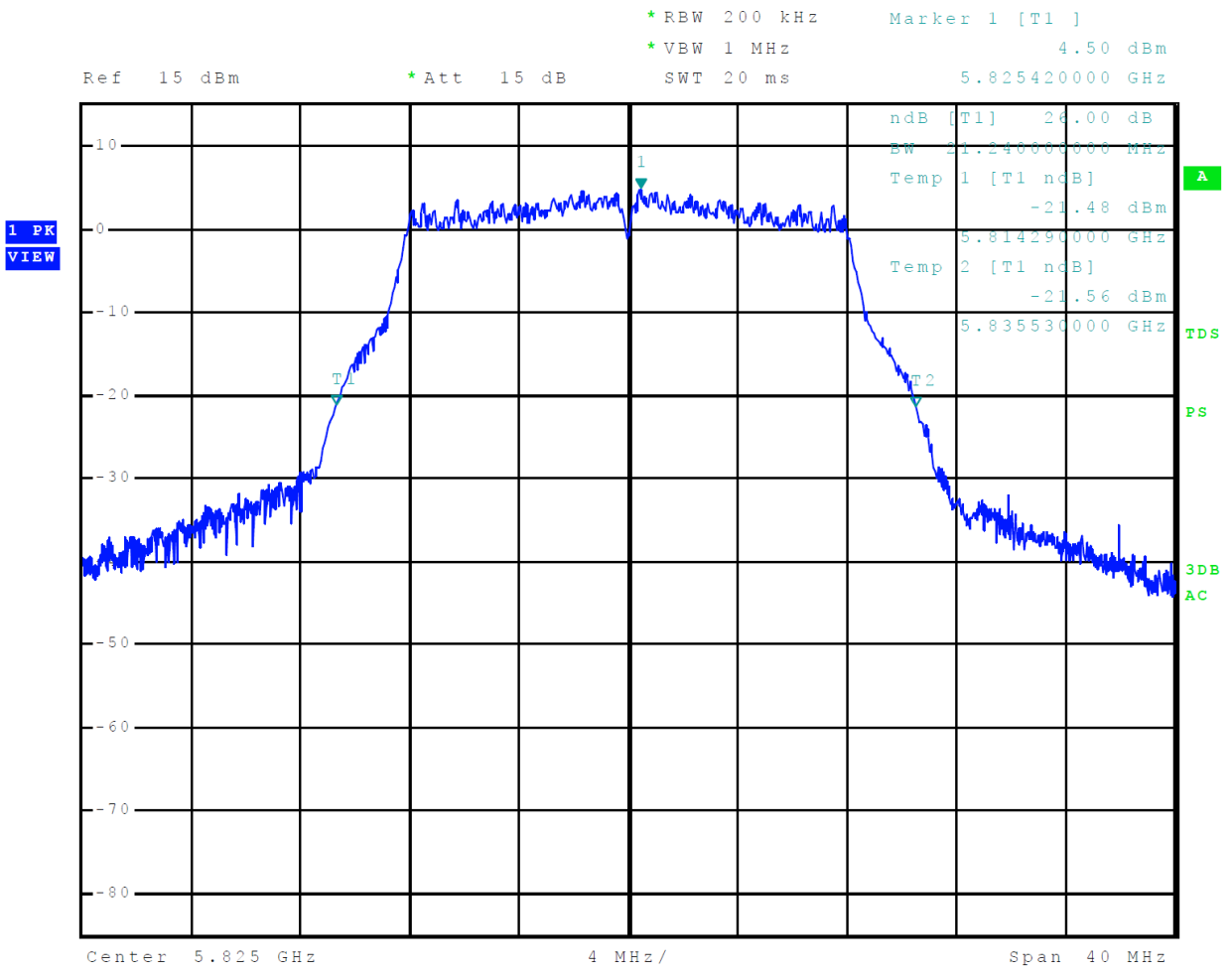

Figure 36 Plot of 26-dB Occupied Bandwidth 5725-5850 MHz Mode 13, U-NII-3 (802.11n)

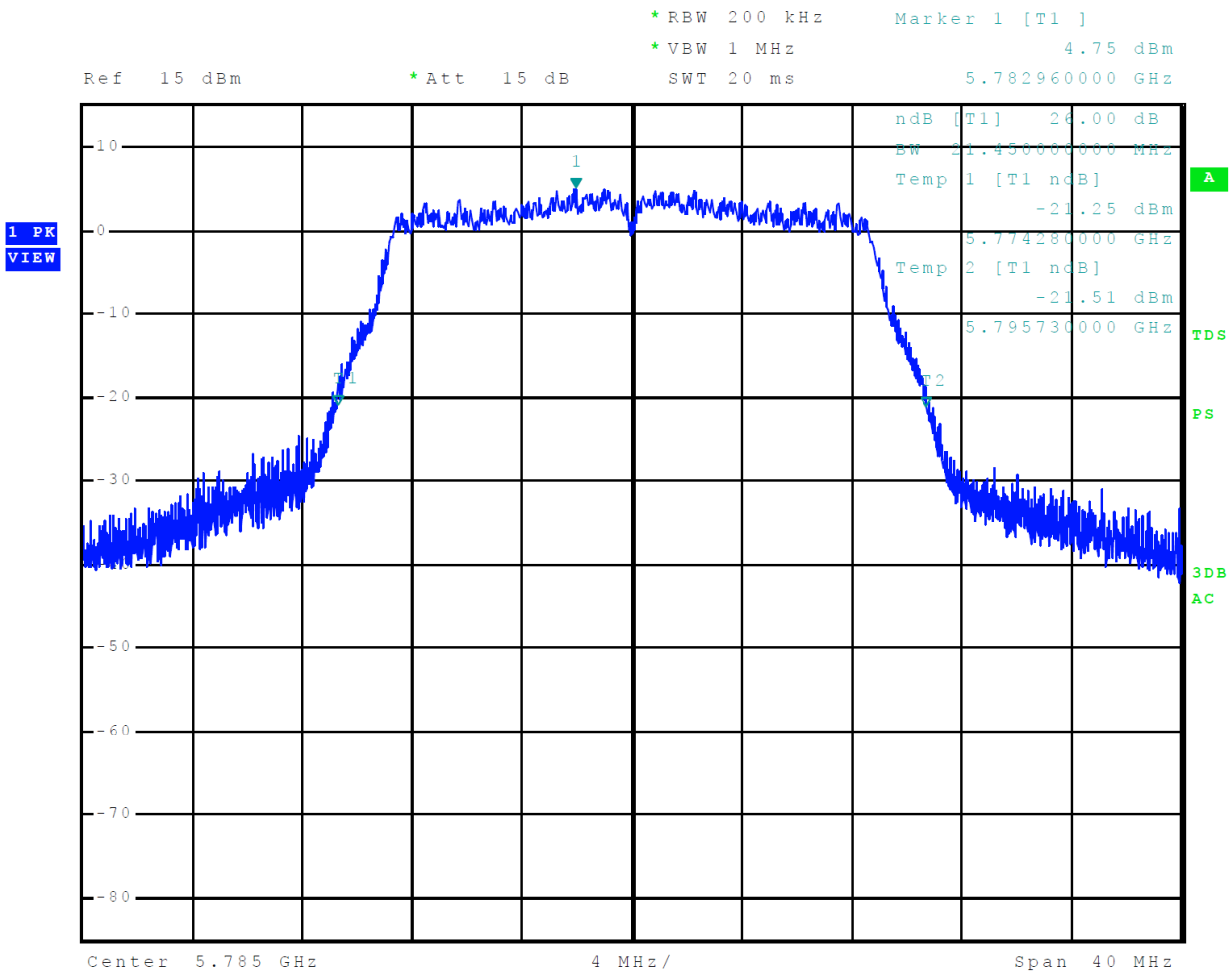

Figure 38 Plot of Transmitter Emissions Across 5150-5250 MHz Mode 15, U-NII-1 (802.11ac80)

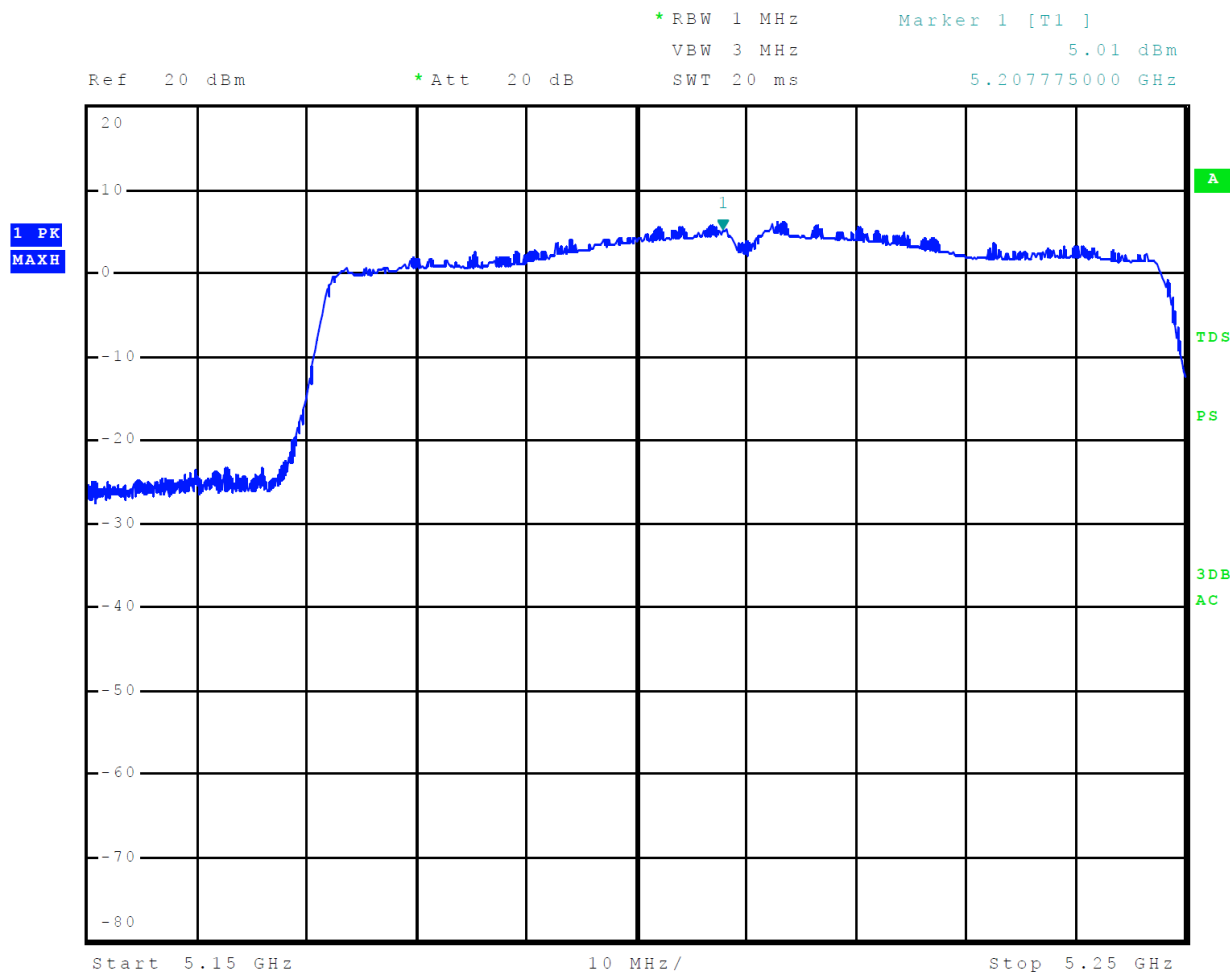

Figure 39 Plot of Lower Band Edge Across 5150-5250 MHz Mode 9, U-NII-1 (802.11a)

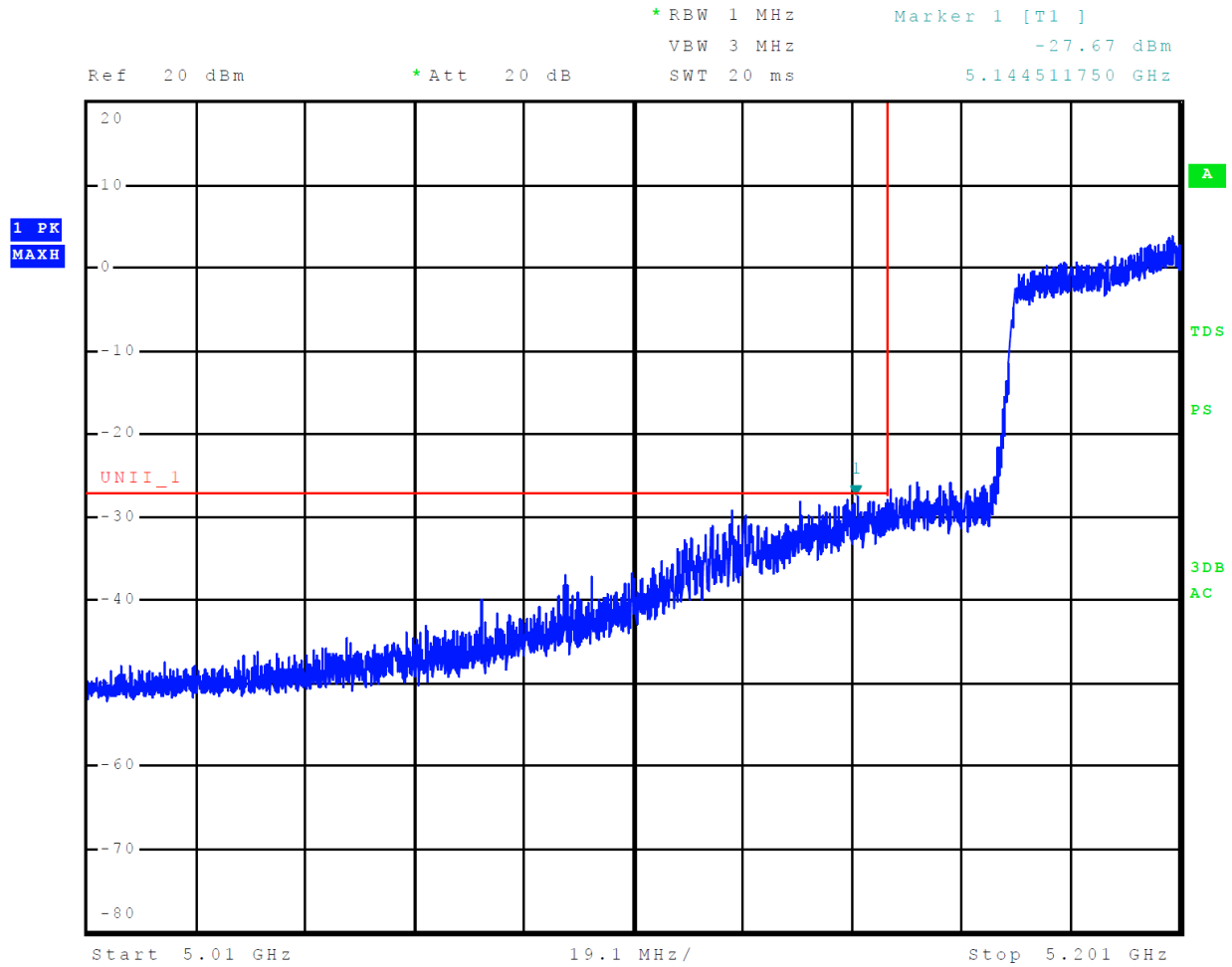

Figure 40 Plot of Upper Band Edge Across 5150-5250 MHz Mode 9, U-NII-1 (802.11a)

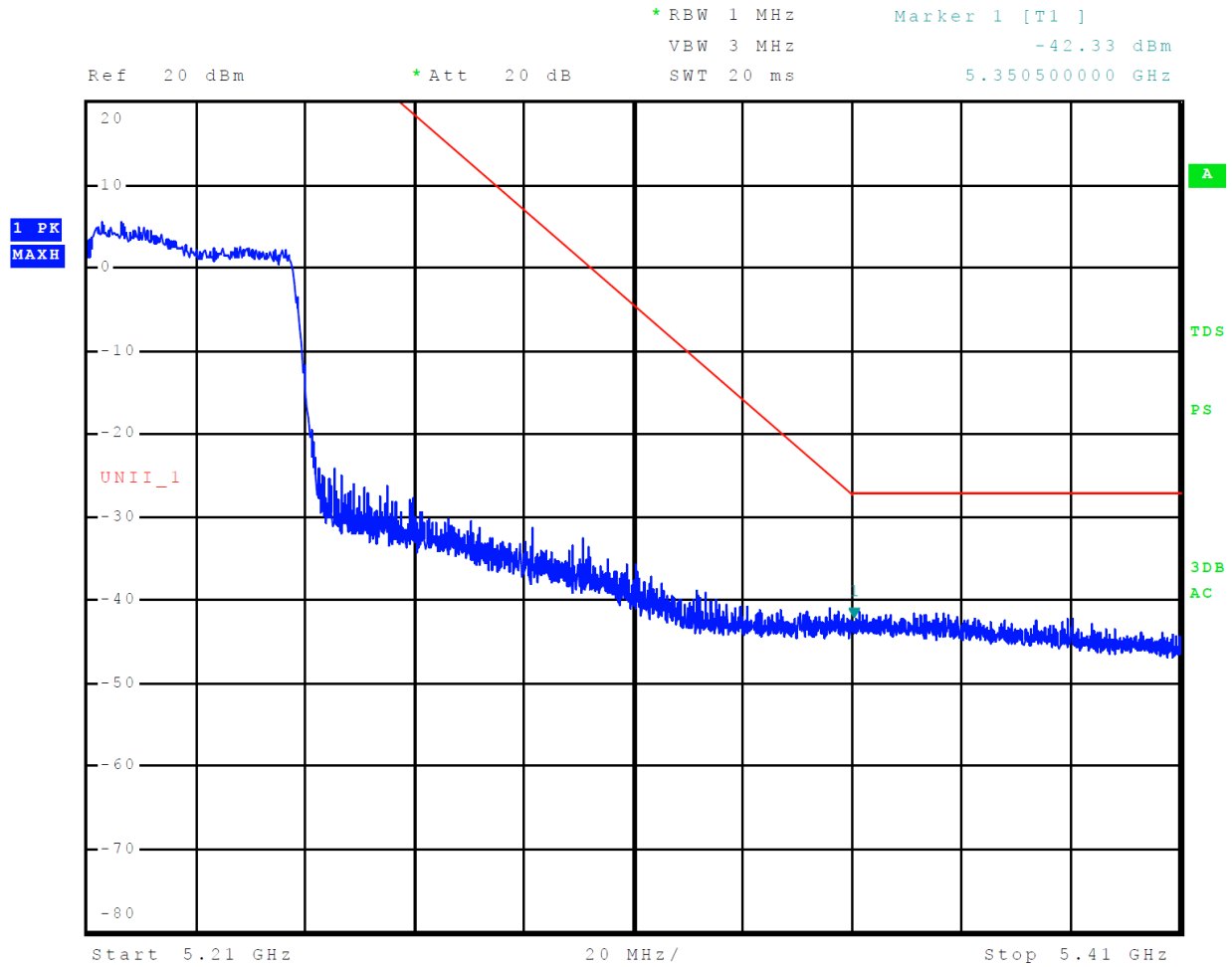

Figure 41 Plot of 26-dB Occupied Bandwidth 5150-5250 MHz Mode 9, U-NII-1 (802.11a)

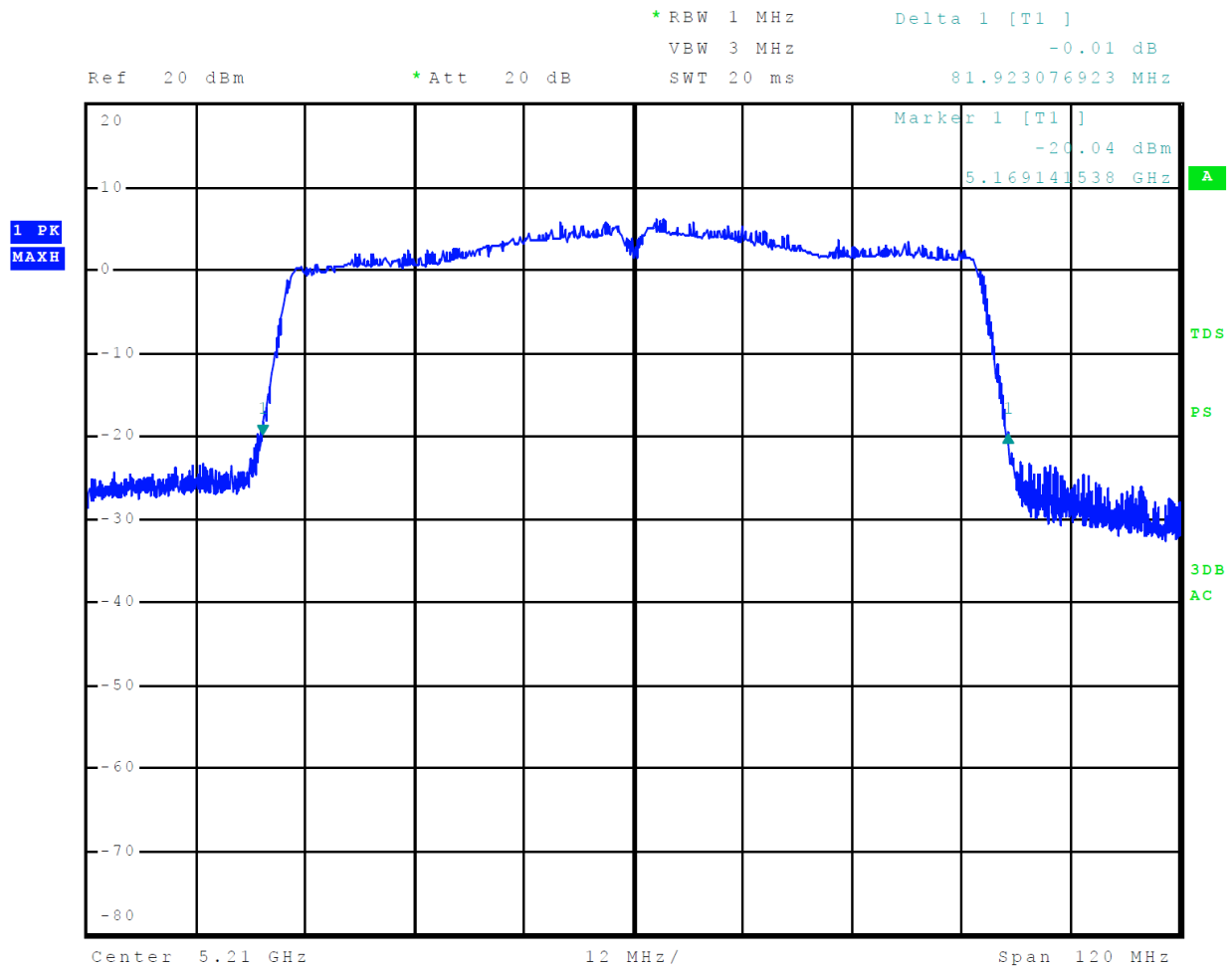

Figure 42 Plot of 99% Occupied Bandwidth 5150-5250 MHz Mode 9, U-NII-1 (802.11a)

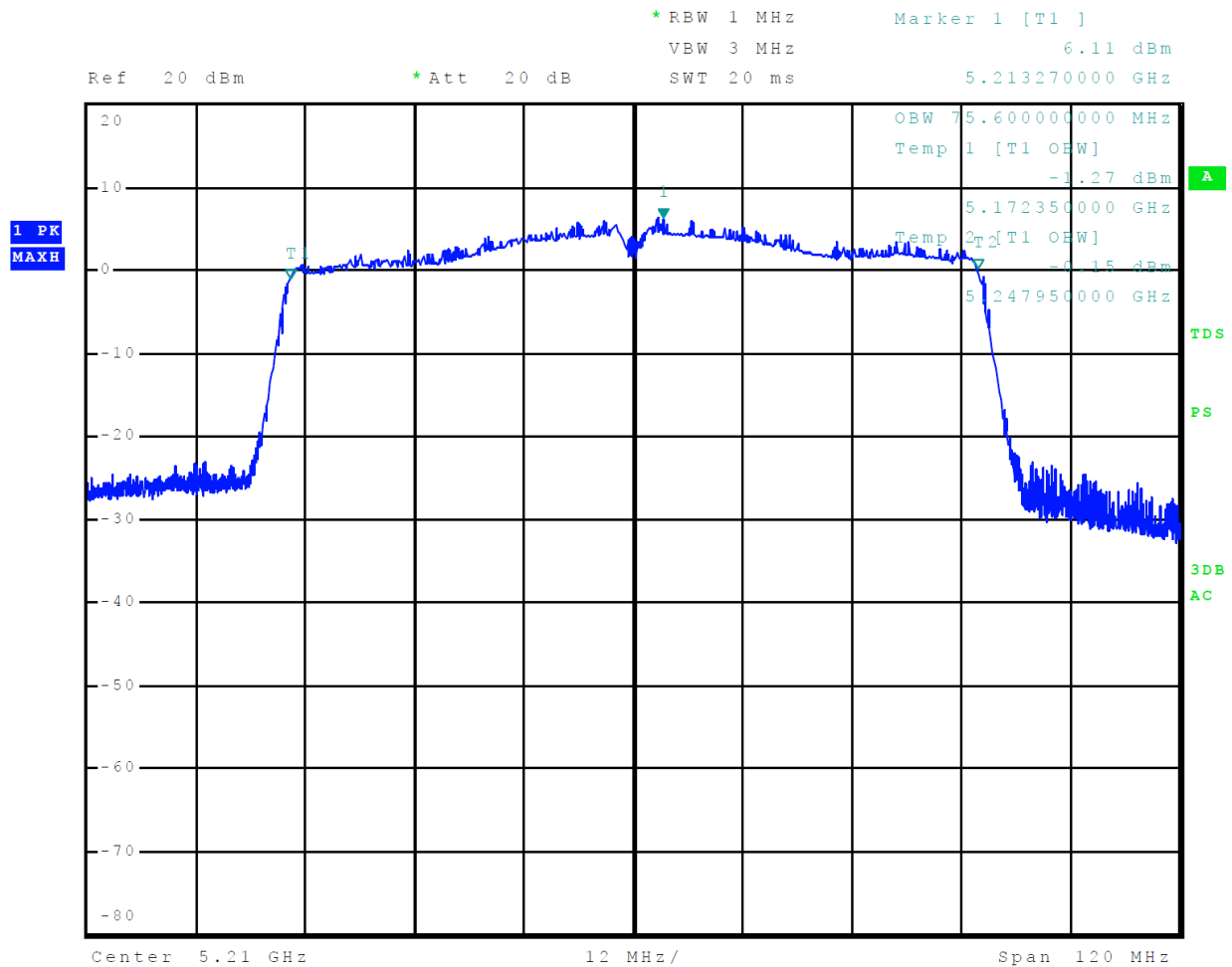

Figure 43 Plot of Transmitter Emissions Across 5725-5850 MHz Mode 12, U-NII-3 (802.11a)

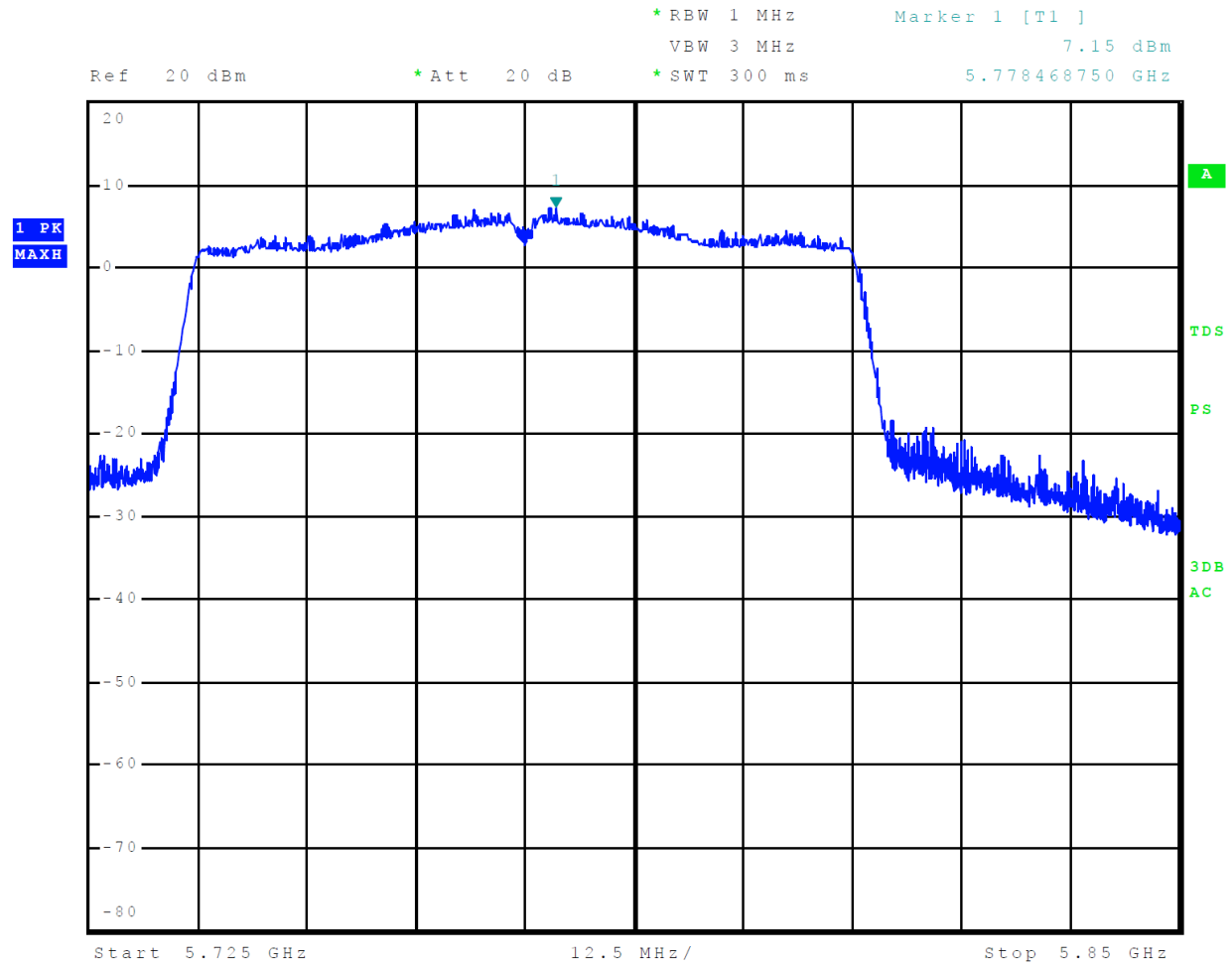
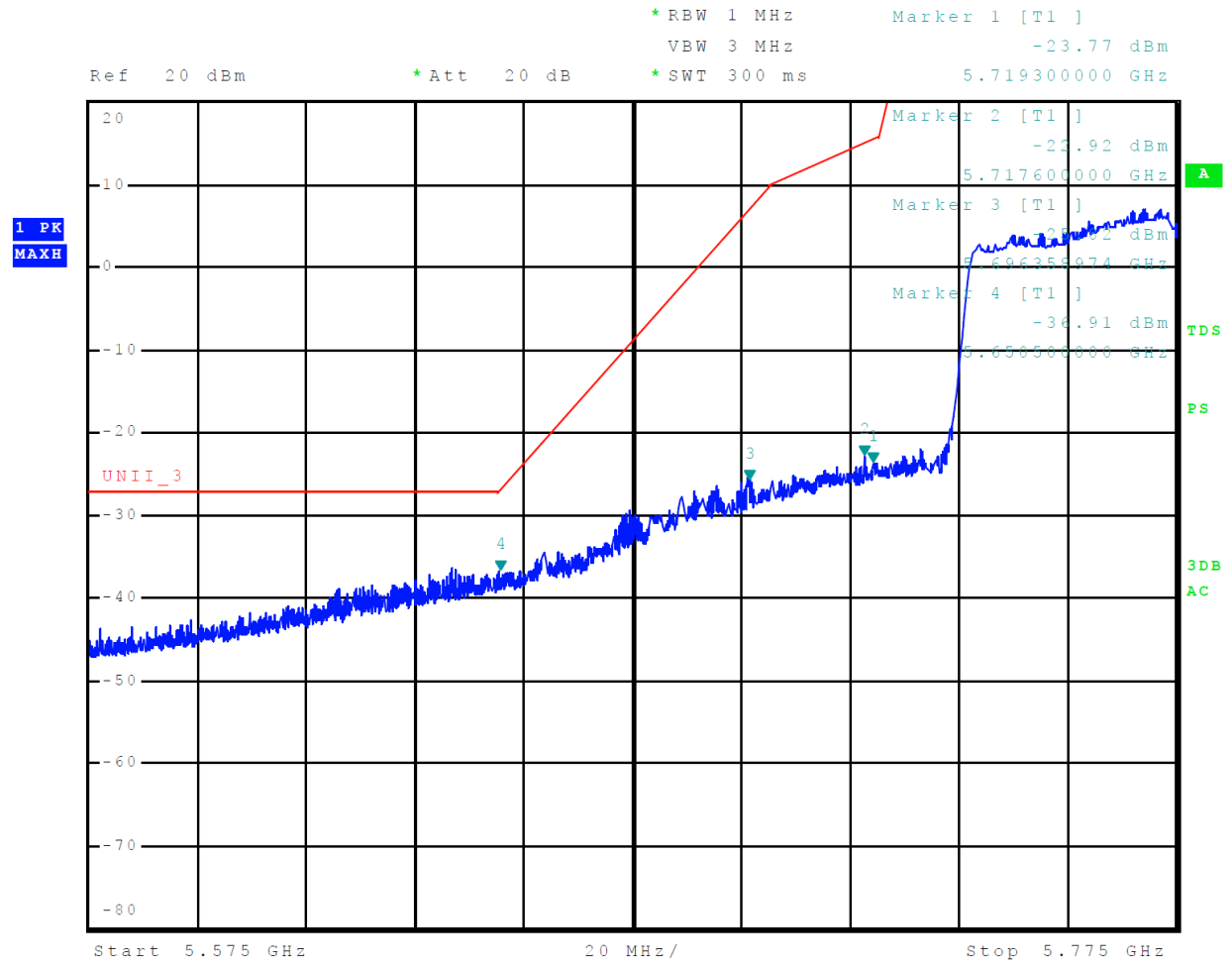

Figure 44 Plot of Lower Band Edge Across 5725-5850 MHz Mode 12, U-NII-3 (802.11a)



Rogers Labs, Inc.
 4405 West 259th Terrace
 Louisburg, KS 66053
 Phone/Fax: (913) 837-3214
 Revision r2

Garmin International, Inc.
 Model: A04577
 Test: 221013
 Test to: 47CFR 15E, RSS-Gen RSS-247
 File: A04577 NII TstRpt 221013 r2

SN's: 3432729295 / 3432729465
 FCC ID: IPH-04577
 IC: 1792A-04577
 Date: March 9, 2023
 Page 79 of 98

Figure 45 Plot of Upper Band Edge Across 5725-5850 MHz Mode 12, U-NII-3 (802.11a)

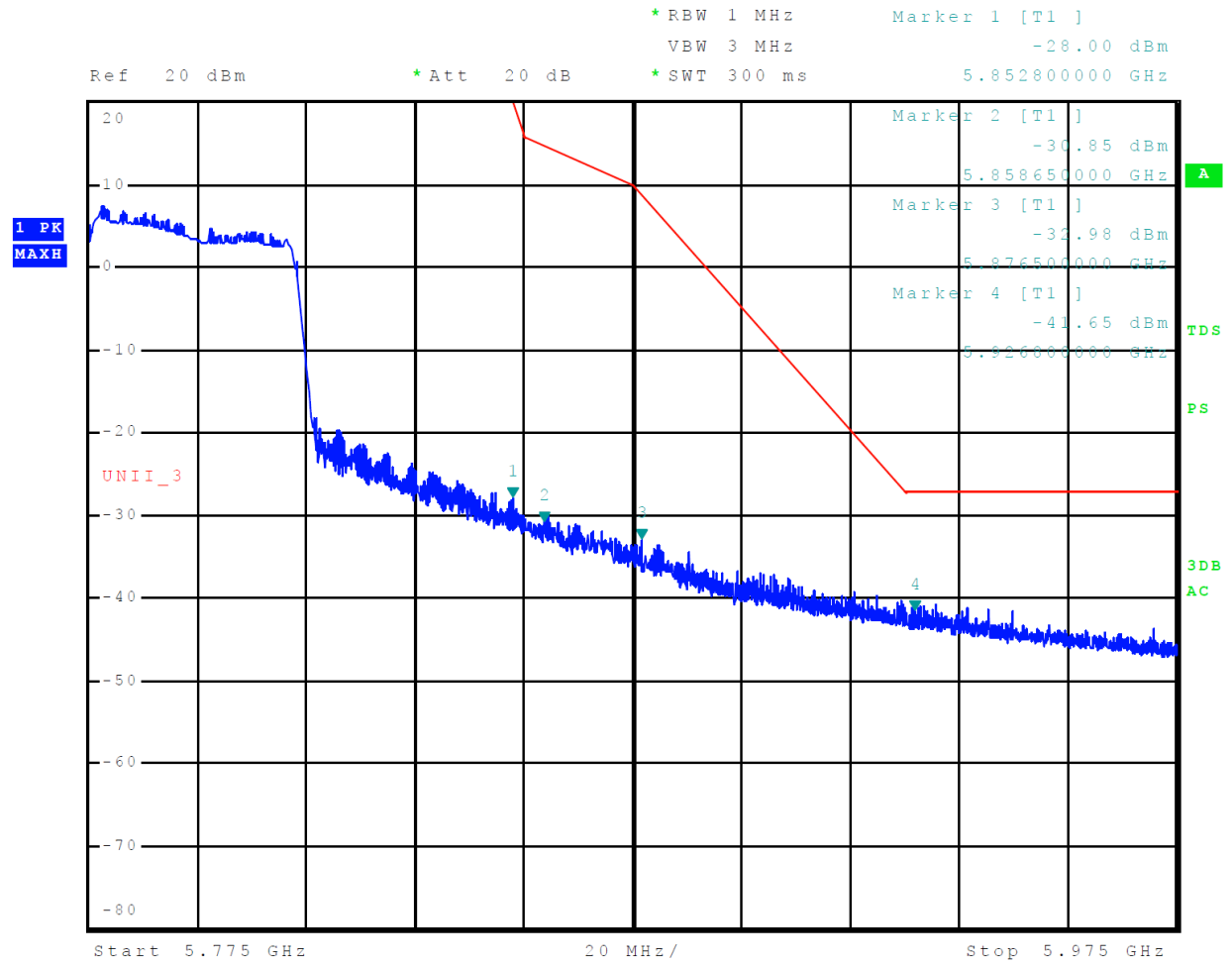

Figure 46 Plot of 99% Occupied Bandwidth 5725-5850 MHz Mode 12, U-NII-3 (802.11a)

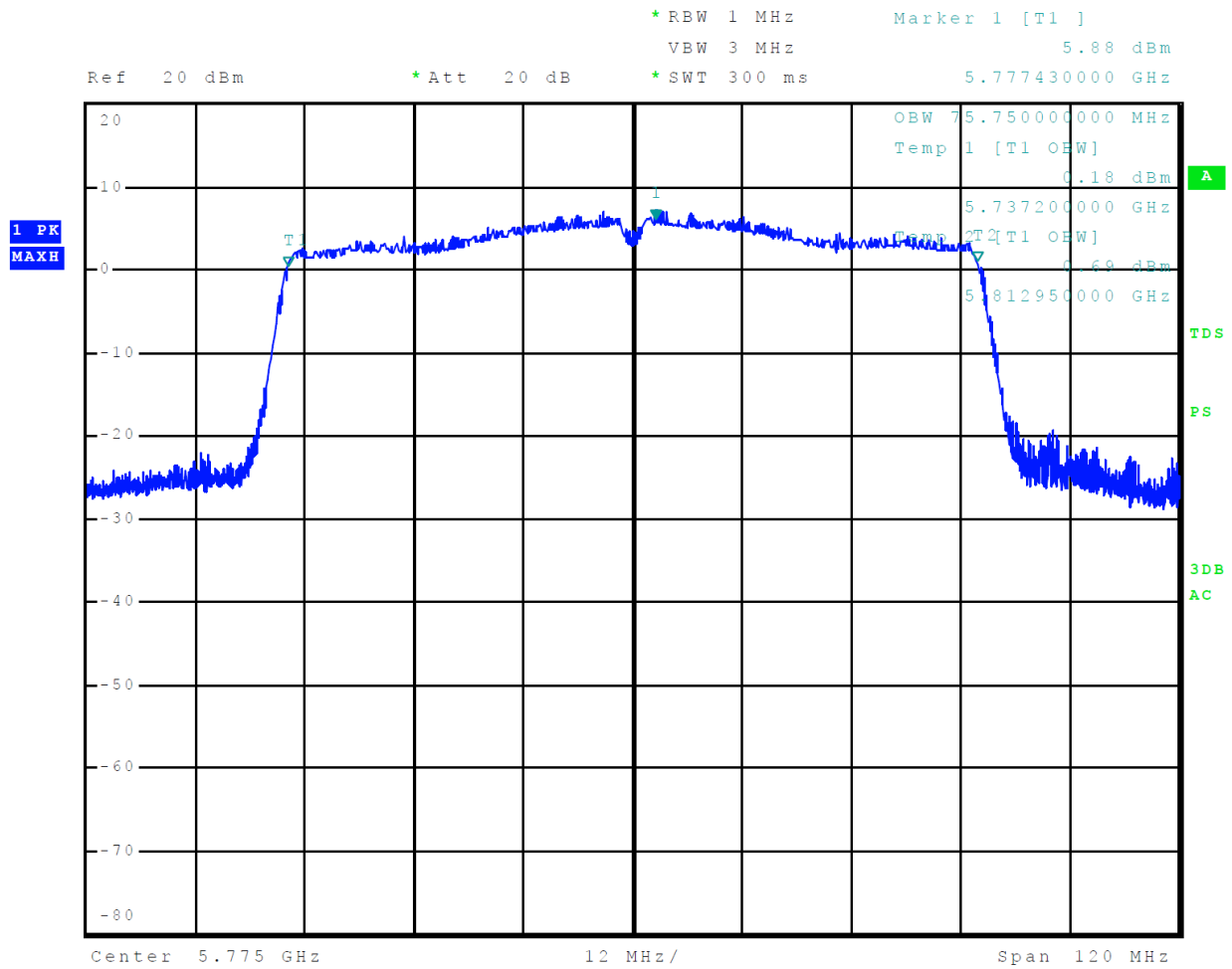
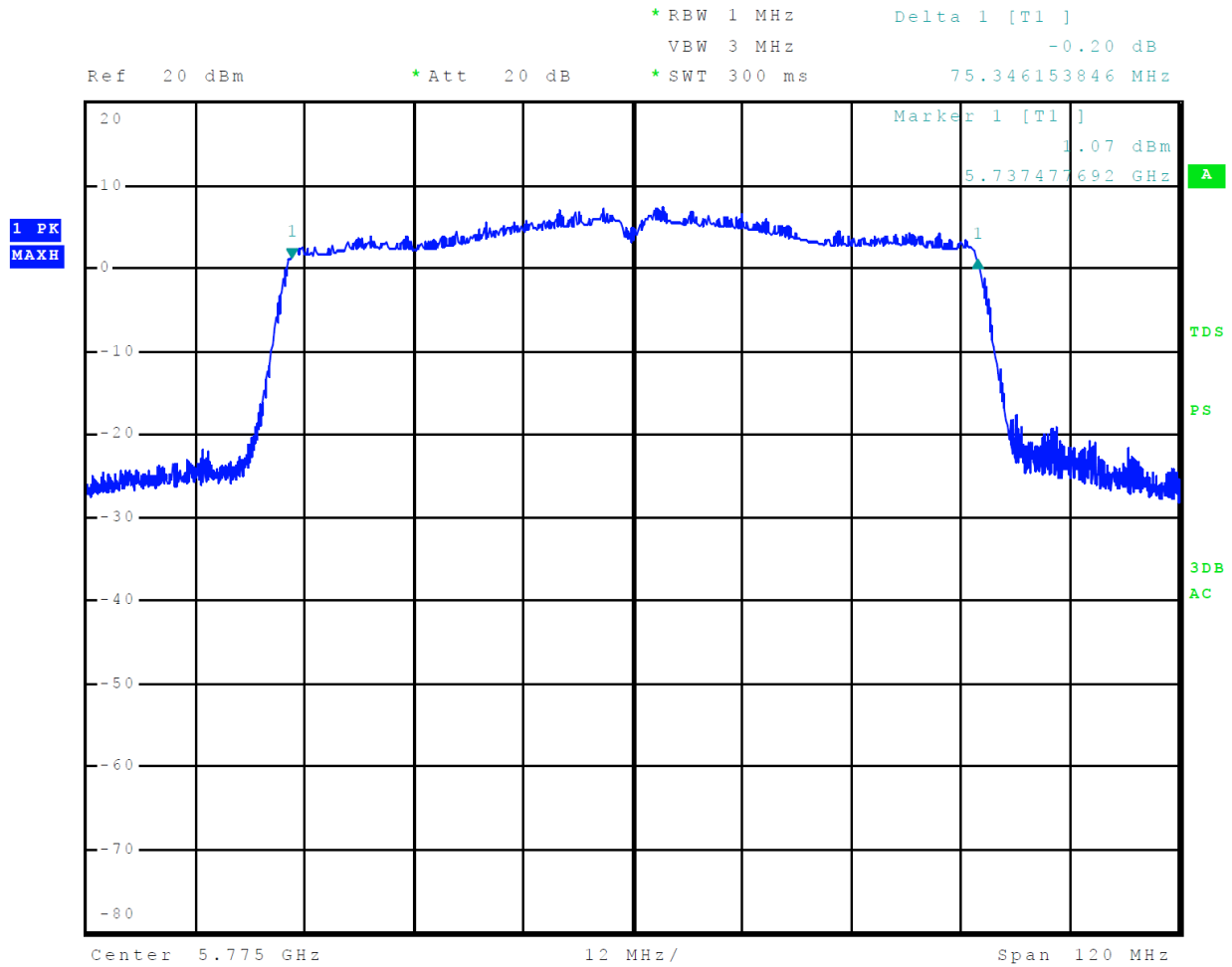

Figure 47 Plot of 6-dB Occupied Bandwidth 5725-5850 MHz Mode 12, U-NII-3 (802.11a)



Transmitter Emissions Data

Table 14 Transmitter Radiated Emission 5150-5250 MHz Band, Mode 9, U-NII-1 (802.11a)

Frequency in MHz	Horizontal Peak (dBµV/m)	Horizontal Average (dBµV/m)	Vertical Peak (dBµV/m)	Vertical Average (dBµV/m)	Limit @ 3m (dBµV/m)	Horizontal Margin (dB)	Vertical Margin (dB)
5180.0	--	--	--	--	--	--	--
10360.0	56.8	44.2	57.4	44.4	68.3	-24.1	-23.9
15540.0	62.7	49.3	62.1	49.4	68.3	-19.0	-18.9
20720.0	66.1	53.6	66.4	53.4	68.3	-14.7	-14.9
25900.0	67.1	54.2	67.5	54.2	68.3	-14.1	-14.1
5200.0	--	--	--	--	--	--	--
10400.0	57.9	44.2	57.5	44.2	68.3	-24.1	-24.1
15600.0	61.9	49.0	62.3	49.0	68.3	-19.3	-19.3
20800.0	66.6	53.4	66.3	53.2	68.3	-14.9	-15.1
26000.0	67.7	54.8	67.6	54.8	68.3	-13.5	-13.5
5240.0	--	--	--	--	--	--	--
10480.0	58.0	44.7	58.0	44.7	68.3	-23.6	-23.6
15720.0	62.7	49.9	62.2	49.9	68.3	-18.4	-18.4
20960.0	66.1	53.3	66.4	53.2	68.3	-15.0	-15.1
26200.0	667.3	53.9	67.1	53.9	68.3	-14.4	-14.4
Band Edges							
5150.0	71.7	53.5	68.4	51.6	54.0	-0.5	-2.4
5350.0	51.4	37.9	51.4	37.8	54.0	-16.1	-16.2

Other emissions present had amplitudes at least 20 dB below the limit. Peak and Quasi-Peak amplitude emissions are recorded for frequency below 1000 MHz. Peak and Average amplitude emissions are recorded for frequency range above 1000 MHz.

Table 15 Transmitter Radiated Emission 5150-5250 MHz Band, Mode 10, U-NII-1 (802.11n)

Frequency in MHz	Horizontal Peak (dBµV/m)	Horizontal Average (dBµV/m)	Vertical Peak (dBµV/m)	Vertical Average (dBµV/m)	Limit @ 3m (dBµV/m)	Horizontal Margin (dB)	Vertical Margin (dB)
5180.0	--	--	--	--	--	--	--
10360.0	57.8	44.4	57.7	44.5	68.3	-23.9	-23.8
15540.0	62.4	49.4	62.4	49.4	68.3	-18.9	-18.9
20720.0	66.2	52.9	65.9	52.9	68.3	-15.4	-15.4
25900.0	66.7	53.7	67.0	53.7	68.3	-14.6	-14.6
5200.0	--	--	--	--	--	--	--
10400.0	57.5	44.2	57.5	44.4	68.3	-24.1	-23.9
15600.0	62.2	49.0	62.2	49.0	68.3	-19.3	-19.3
20800.0	65.9	53.0	65.7	52.9	68.3	-15.3	-15.4
26000.0	68.0	54.7	67.8	54.7	68.3	-13.6	-13.6
5240.0	--	--	--	--	--	--	--
10480.0	57.8	44.7	57.4	44.7	68.3	-23.6	-23.6
15720.0	63.1	49.9	62.7	49.9	68.3	-18.4	-18.4
20960.0	65.7	52.7	65.9	52.7	68.3	-15.6	-15.6
26200.0	66.0	53.0	66.2	53.0	68.3	-15.3	-15.3
Band Edges							
5150.0	72.8	53.4	71.2	51.4	54.0	-0.6	-2.6
5350.0	51.0	37.9	51.5	37.8	54.0	-16.1	-16.2

Other emissions present had amplitudes at least 20 dB below the limit. Peak and Quasi-Peak amplitude emissions are recorded for frequency below 1000 MHz. Peak and Average amplitude emissions are recorded for frequency range above 1000 MHz.

Table 16 Transmitter Radiated Emission 5150-5250 MHz Band, Mode 11, U-NII-1 (802.11n40)

Frequency in MHz	Horizontal Peak (dBµV/m)	Horizontal Average (dBµV/m)	Vertical Peak (dBµV/m)	Vertical Average (dBµV/m)	Limit @ 3m (dBµV/m)	Horizontal Margin (dB)	Vertical Margin (dB)
5190.0	--	--	--	--	--	--	--
10380.0	58.1	44.3	57.4	44.3	68.3	-24.0	-24.0
15570.0	63.6	50.6	63.0	49.9	68.3	-17.7	-18.4
20760.0	65.9	53.0	66.0	52.8	68.3	-15.3	-15.5
25950.0	66.3	53.6	66.7	53.6	68.3	-14.7	-14.7
5230.0	--	--	--	--	--	--	--
10460.0	57.4	44.8	58.1	44.8	68.3	-23.5	-23.5
15690.0	62.7	49.5	62.3	49.5	68.3	-18.8	-18.8
20920.0	65.3	52.8	65.2	52.7	68.3	-15.5	-15.6
26150.0	67.0	54.1	67.0	54.1	68.3	-14.2	-14.2
Band Edges							
5150.0	69.7	53.6	70.1	51.4	54.0	-0.4	-2.6
5350.0	55.5	39.7	54.5	39.4	54.0	-14.3	-14.6

Other emissions present had amplitudes at least 20 dB below the limit. Peak and Quasi-Peak amplitude emissions are recorded for frequency below 1000 MHz. Peak and Average amplitude emissions are recorded for frequency range above 1000 MHz.

Table 17 Transmitter Radiated Emission 5725-5850 MHz Band, Mode 12, U-NII-3 (802.11a)

Frequency in MHz	Horizontal Peak (dBµV/m)	Horizontal Average (dBµV/m)	Vertical Peak (dBµV/m)	Vertical Average (dBµV/m)	Limit @ 3m (dBµV/m)	Horizontal Margin (dB)	Vertical Margin (dB)
5745.0	--	--	--	--	--	--	--
11490.0	58.8	45.9	59.2	45.9	68.3	-22.4	-22.4
17235.0	62.6	49.8	62.8	50.0	68.3	-18.5	-18.3
22980.0	65.6	53.1	65.6	53.0	68.3	-15.2	-15.3
28725.0	69.2	56.4	69.4	56.5	68.3	-11.9	-11.8
5785.0	--	--	--	--	--	--	--
11570.0	59.2	46.2	59.1	46.3	68.3	-22.1	-22.0
17355.0	63.4	50.8	63.6	50.8	68.3	-17.5	-17.5
23140.0	66.0	53.0	65.2	52.9	68.3	-15.3	-15.4
28925.0	69.3	56.2	69.1	56.2	68.3	-12.1	-12.1
5825.0	--	--	--	--	--	--	--
11650.0	59.8	46.1	59.2	46.2	68.3	-22.2	-22.1
17475.0	64.2	51.3	64.2	51.5	68.3	-17.0	-16.8
23300.0	65.9	53.0	66.2	53.0	68.3	-15.3	-15.3
29125.0	69.0	55.7	69.1	55.7	68.3	-12.6	-12.6
Band Edges							
5725.0	73.2	55.6	74.5	59.1	78.2	-22.6	-19.1
5850.0	65.2	49.3	65.7	51.5	78.2	-28.9	-26.7

Other emissions present had amplitudes at least 20 dB below the limit. Peak and Quasi-Peak amplitude emissions are recorded for frequency below 1000 MHz. Peak and Average amplitude emissions are recorded for frequency range above 1000 MHz.

Table 18 Transmitter Radiated Emission 5725-5850 MHz Band, Mode 13, U-NII-3 (802.11n)

Frequency in MHz	Horizontal Peak (dBµV/m)	Horizontal Average (dBµV/m)	Vertical Peak (dBµV/m)	Vertical Average (dBµV/m)	Limit @ 3m (dBµV/m)	Horizontal Margin (dB)	Vertical Margin (dB)
5745.0	--	--	--	--	--	--	--
11490.0	58.5	45.8	58.7	45.8	68.3	-22.5	-22.5
17235.0	63.0	50.1	62.4	50.0	68.3	-18.2	-18.3
22980.0	66.1	53.0	66.2	53.1	68.3	-15.3	-15.2
28725.0	69.4	56.4	69.5	56.5	68.3	-11.9	-11.8
5785.0	--	--	--	--	--	--	--
11570.0	59.1	45.9	59.2	45.9	68.3	-22.4	-22.4
17355.0	63.5	50.9	63.6	50.9	68.3	-17.4	-17.4
23140.0	65.6	53.0	65.6	52.9	68.3	-15.3	-15.4
28925.0	69.3	56.2	69.1	56.2	68.3	-12.1	-12.1
5825.0	--	--	--	--	--	--	--
11650.0	59.2	46.1	59.1	45.8	68.3	-22.2	-22.5
17475.0	64.7	51.8	64.4	51.7	68.3	-16.5	-16.6
23300.0	65.8	53.1	65.5	53.0	68.3	-15.2	-15.3
29125.0	69.2	55.8	69.1	55.8	68.3	-12.5	-12.5
Band Edges							
5725.0	77.1	56.7	80.4	59.8	78.2	-21.5	-18.4
5850.0	69.2	48.4	69.4	50.6	78.2	-29.8	-27.6

Other emissions present had amplitudes at least 20 dB below the limit. Peak and Quasi-Peak amplitude emissions are recorded for frequency below 1000 MHz. Peak and Average amplitude emissions are recorded for frequency range above 1000 MHz.

Table 19 Transmitter Radiated Emission 5725-5850 MHz Band, Mode 14, U-NII-3 (802.11n40)

Frequency in MHz	Horizontal Peak (dBµV/m)	Horizontal Average (dBµV/m)	Vertical Peak (dBµV/m)	Vertical Average (dBµV/m)	Limit @ 3m (dBµV/m)	Horizontal Margin (dB)	Vertical Margin (dB)
5755.0	--	--	--	--	--	--	--
11510.0	58.9	45.8	59.1	45.9	68.3	-22.5	-22.4
17265.0	62.3	49.8	62.4	49.9	68.3	-18.5	-18.4
23020.0	66.1	52.8	65.6	52.8	68.3	-15.5	-15.5
28775.0	69.0	56.0	68.8	56.0	68.3	-12.3	-12.3
5795.0	--	--	--	--	--	--	--
11590.0	59.6	46.4	59.8	46.5	68.3	-21.9	-21.8
17385.0	64.3	50.1	63.6	50.4	68.3	-18.2	-17.9
23180.0	66.7	52.7	66.0	52.7	68.3	-15.6	-15.6
28975.0	69.4	55.8	68.6	55.8	68.3	-12.5	-12.5
Band Edges							
5725.0	77.7	59.9	77.9	59.8	78.2	-18.3	-18.4
5850.0	62.1	46.7	58.3	43.6	78.2	-31.5	-34.6

Other emissions present had amplitudes at least 20 dB below the limit. Peak and Quasi-Peak amplitude emissions are recorded for frequency below 1000 MHz. Peak and Average amplitude emissions are recorded for frequency range above 1000 MHz.

Table 20 Transmitter Radiated Emission 5150-5250 MHz Band, Mode 15, U-NII-1 (802.11ac80)

Frequency in MHz	Horizontal Peak (dBµV/m)	Horizontal Average (dBµV/m)	Vertical Peak (dBµV/m)	Vertical Average (dBµV/m)	Limit @ 3m (dBµV/m)	Horizontal Margin (dB)	Vertical Margin (dB)
5210.0	--	--	--	--	--	--	--
10420.0	57.6	44.8	57.9	44.3	68.3	-23.5	-24.0
15630.0	60.2	47.5	60.7	47.7	68.3	-20.8	-20.6
20840.0	66.5	53.3	66.2	53.2	68.3	-15.0	-15.1
26050.0	66.8	54.4	67.5	54.3	68.3	-13.9	-14.0
Band Edges							
5150.0	63.6	50.2	65.9	51.8	54.0	-3.8	-2.2
5250.0	60.7	42.7	63.3	44.8	54.0	-11.3	-9.2

Other emissions present had amplitudes at least 20 dB below the limit. Peak and Quasi-Peak amplitude emissions are recorded for frequency below 1000 MHz. Peak and Average amplitude emissions are recorded for frequency range above 1000 MHz.

Table 21 Transmitter Radiated Emission 5725-5850 MHz Band, Mode 16, U-NII-3 (802.11ac80)

Frequency in MHz	Horizontal Peak (dBµV/m)	Horizontal Average (dBµV/m)	Vertical Peak (dBµV/m)	Vertical Average (dBµV/m)	Limit @ 3m (dBµV/m)	Horizontal Margin (dB)	Vertical Margin (dB)
5775.0	--	--	--	--	--	--	--
11550.0	59.4	46.4	59.3	46.1	68.3	-21.9	-22.2
17325.0	64.6	51.1	64.7	50.9	68.3	-17.2	-17.4
23100.0	65.7	53.1	65.8	53.1	68.3	-15.2	-15.2
28875.0	68.1	55.4	67.7	55.4	68.3	-12.9	-12.9
Band Edges							
5725.0	62.0	47.4	59.9	44.2	78.2	-30.8	-34.0
5850.0	54.2	39.9	52.8	39.5	78.2	-38.3	-38.7

Other emissions present had amplitudes at least 20 dB below the limit. Peak and Quasi-Peak amplitude emissions are recorded for frequency below 1000 MHz. Peak and Average amplitude emissions are recorded for frequency range above 1000 MHz.

Table 22 Transmitter Antenna Port Data Modes 9, 10, 11, & 15, (U-NII-1)

Frequency MHz	Antenna Port Conducted Output Power (Watts)	99% Occupied Bandwidth (kHz)	Peak Power Spectral Density (dBm/MHz)
20 MHz Mode 9, U-NII-1 (802.11a)			
5180	0.017	17,120.0	11.6
5200	0.041	17,590.0	16.0
5240	0.042	17,530.0	15.6
20 MHz Mode 10, U-NII-1 (802.11n)			
5180	0.017	17,880.0	11.8
5200	0.040	18,050.0	15.9
5240	0.039	18,060.0	15.6
40 MHz Mode 11, U-NII-1 (802.11n40)			
5190	0.009	36,700.0	6.0
5230	0.042	37,675.0	12.5
80 MHz Mode 15, U-NII-1 (802.11ac80)			
5210	0.014	75,600.0	-4.6

Table 23 Transmitter Antenna Port Data Modes 12, 13, 14, & 16, (U-NII-3)

Frequency MHz	Antenna Port Conducted Average Output Power (Watts)	99% Occupied Bandwidth (kHz)	6-dB Occupied Bandwidth (kHz)	26-dB Occupied Bandwidth (kHz)	Peak Power Spectral Density (dBm/500kHz)
20 MHz Mode 12, U-NII-3 (802.11a)					
5745	0.022	17,140.0	16,309.5	21,180.0	8.5
5785	0.019	17,130.0	16,346.2	21,230.0	8.4
5825	0.021	17,170.0	16,315.1	21,240.0	8.1
20 MHz Mode 13, U-NII-3 (802.11n)					
5745	0.021	17,870.0	17,500.0	21,340.0	9.3
5785	0.020	17,860.0	17,522.1	21,450.0	9.1
5825	0.020	17,860.0	17,530.0	21,380.0	9.4
40 MHz Mode 14 (802.11n40) U-NII-3					
5755	0.024	36,850.0	36,250.0	40,050.0	6.7
5795	0.023	36,950.0	35,977.6	40,150.0	6.5
80 MHz Mode 16, U-NII-3 (802.11ac80)					
5775	0.019	75,750.0	75,346.0	81,660.0	3.2

Summary of Results for Transmitter Radiated Emissions of Intentional Radiator

The EUT demonstrated compliance with the radiated emissions requirements of 47 CFR Part 15.407 and Industry Canada RSS-247 Issue 2. The maximum average conducted power delivered to antenna was 0.042-Watts in the U-NII-1 Band and 0.024-Watts in the U-NII-3 Band. The radiated harmonic emissions provided a minimum margin of -11.8 dB below requirements. There were no other significantly measurable emissions in the restricted bands other than those presented in this report. Other emissions were present with amplitudes at least 20 dB below the requirements. There were no other deviations or exceptions to the requirements.

Annex

- Annex A Measurement Uncertainty Calculations
- Annex B Additional Test Equipment
- Annex C Rogers Qualifications
- Annex D Rogers Labs Certificate of Accreditation

Rogers Labs, Inc.
4405 West 259th Terrace
Louisburg, KS 66053
Phone/Fax: (913) 837-3214
Revision r2

Garmin International, Inc.
Model: A04577
Test: 221013
Test to: 47CFR 15E, RSS-Gen RSS-247
File: A04577 NII TstRpt 221013 r2

SN's: 3432729295 / 3432729465
FCC ID: IPH-04577
IC: 1792A-04577
Date: March 9, 2023
Page 93 of 98

Annex A Measurement Uncertainty Calculations

The measurement uncertainty was calculated for all measurements listed in this test report according To CISPR 16-4. Result of measurement uncertainty calculations are recorded below. Component and process variability of production devices similar to those tested may result in additional deviations. The manufacturer has the sole responsibility of continued compliance.

Measurement	Expanded Measurement Uncertainty $U_{(lab)}$
3 Meter Horizontal 0.009-1000 MHz Measurements	4.16
3 Meter Vertical 0.009-1000 MHz Measurements	4.33
3 Meter Measurements 1-18 GHz	5.14
3 Meter Measurements 18-40 GHz	5.16
10 Meter Horizontal Measurements 0.009-1000 MHz	4.15
10 Meter Vertical Measurements 0.009-1000 MHz	4.32
AC Line Conducted	1.75
Antenna Port Conducted power	1.17
Frequency Stability	1.00E-11
Temperature	1.6°C
Humidity	3%

Annex B Test Equipment

<u>Equipment</u>	<u>Manufacturer</u>	<u>Model (SN)</u>	<u>Band</u>	<u>Cal Date(m/d/y)</u>	<u>Due</u>
<input checked="" type="checkbox"/> LISN	FCC	FCC-LISN-50-25-10(1PA) (160611)	.15-30MHz	3/29/2022	3/29/2023
<input checked="" type="checkbox"/> LISN: Fischer Custom Communications Model:		FCC-LISN-50-16-2-08		3/29/2022	3/29/2023
<input checked="" type="checkbox"/> Cable	Huber & Suhner Inc.	Sucoflex102ea(L10M)(303073)	9kHz-40 GHz	10/14/2021	10/14/2022
<input type="checkbox"/> Cable	Huber & Suhner Inc.	Sucoflex102ea(1.5M)(303069)	9kHz-40 GHz	10/14/2021	10/14/2022
<input checked="" type="checkbox"/> Cable	Huber & Suhner Inc.	Sucoflex102ea(1.5M)(303070)	9kHz-40 GHz	10/14/2021	10/14/2022
<input checked="" type="checkbox"/> Cable	Belden	RG-58 (L1-CAT3-11509)	9kHz-30 MHz	10/14/2021	10/14/2022
<input type="checkbox"/> Cable	Belden	RG-58 (L2-CAT3-11509)	9kHz-30 MHz	10/14/2021	10/14/2022
<input checked="" type="checkbox"/> Antenna	Com Power	AL-130 (121055)	.001-30 MHz	10/14/2021	10/14/2022
<input type="checkbox"/> Antenna:	EMCO	6509	.001-30 MHz	10/14/2020	10/14/2022
<input type="checkbox"/> Antenna	ARA	BCD-235-B (169)	20-350MHz	10/14/2021	10/14/2022
<input type="checkbox"/> Antenna:	Schwarzbeck Model	VHBB 9124 (1468)	30-200MHz	10/14/2020	10/14/2022
<input checked="" type="checkbox"/> Antenna	Sunol	JB-6 (A100709)	30-1000 MHz	10/14/2021	10/14/2022
<input type="checkbox"/> Antenna	ETS-Lindgren	3147 (40582)	200-1000MHz	10/14/2020	10/14/2022
<input type="checkbox"/> Antenna:	Schwarzbeck Model:	VULP 9118 (A-534)	200-1000MHz	10/14/2020	10/14/2022
<input checked="" type="checkbox"/> Antenna	ETS-Lindgren	3117 (200389)	1-18 GHz	3/29/2022	3/29/2024
<input type="checkbox"/> Antenna	Com Power	AH-118 (10110)	1-18 GHz	10/14/2020	10/14/2022
<input checked="" type="checkbox"/> Antenna	Com Power	AH-840 (101046)	18-40 GHz	4/6/2021	4/6/2023
<input checked="" type="checkbox"/> Analyzer	Rohde & Schwarz	ESU40 (100108)	20Hz-40GHz	3/9/2022	3/9/2023
<input checked="" type="checkbox"/> Analyzer	Rohde & Schwarz	ESW44 (101534)	20Hz-44GHz	1/18/2022	1/18/2023
<input type="checkbox"/> Analyzer	Rohde & Schwarz	FS-Z60, 90, 140, and 220	40GHz-220GHz	12/22/2017	12/22/2027
<input checked="" type="checkbox"/> Amplifier	Com-Power	PA-010 (171003)	100Hz-30MHz	10/14/2021	10/14/2022
<input checked="" type="checkbox"/> Amplifier	Com-Power	CPPA-102 (01254)	1-1000 MHz	10/14/2021	10/14/2022
<input checked="" type="checkbox"/> Amplifier	Com-Power	PAM-118A (551014)	0.5-18 GHz	10/14/2021	10/14/2022
<input checked="" type="checkbox"/> Amplifier	Com-Power	PAM-840A (461328)	18-40 GHz	10/14/2021	10/14/2022
<input checked="" type="checkbox"/> Pwr Sensor	Rohde & Schwarz	NRP33T	0.05-33 GHz	8/31/2022	8/31/2023
<input checked="" type="checkbox"/> Power Meter	Agilent	N1911A with N1921A	0.05-40 GHz	3/29/2022	3/29/2023
<input type="checkbox"/> Generator	Rohde & Schwarz	SMB100A6 (100150)	20Hz-6 GHz	3/29/2022	3/29/2023
<input type="checkbox"/> Generator	Rohde & Schwarz	SMBV100A6 (260771)	20Hz-6 GHz	3/29/2022	3/29/2023
<input type="checkbox"/> RF Filter	Micro-Tronics	BRC50722 (009).9G notch	30-18000 MHz	4/6/2021	4/6/2023
<input type="checkbox"/> RF Filter	Micro-Tronics	HPM50114 (017)1.5G HPF	30-18000 MHz	4/6/2021	4/6/2023
<input type="checkbox"/> RF Filter	Micro-Tronics	HPM50117 (063) 3G HPF	30-18000 MHz	4/6/2021	4/6/2023
<input type="checkbox"/> RF Filter	Micro-Tronics	HPM50105 (059) 6G HPF	30-18000 MHz	4/6/2021	4/6/2023
<input checked="" type="checkbox"/> RF Filter	Micro-Tronics	BRM50702 (172) 2G notch	30-18000 MHz	4/6/2021	4/6/2023
<input type="checkbox"/> RF Filter	Micro-Tronics	BRC50703 (G102) 5G notch	30-18000 MHz	4/6/2021	4/6/2023
<input type="checkbox"/> RF Filter	Micro-Tronics	BRC50705 (024) 5G notch	30-18000 MHz	4/6/2021	4/6/2023
<input type="checkbox"/> Attenuator	Fairview	SA6NFN100W-40 (1625)	30-18000 MHz	3/29/2022	3/29/2023
<input checked="" type="checkbox"/> Attenuator	Mini-Circuits	VAT-3W2+ (1436)	30-6000 MHz	3/29/2022	3/29/2023
<input type="checkbox"/> Attenuator	Mini-Circuits	VAT-3W2+ (1445)	30-6000 MHz	3/29/2022	3/29/2023
<input type="checkbox"/> Attenuator	Mini-Circuits	VAT-3W2+ (1735)	30-6000 MHz	3/29/2022	3/29/2023
<input type="checkbox"/> Attenuator	Mini-Circuits	VAT-6W2+ (1438)	30-6000 MHz	3/29/2022	3/29/2023
<input type="checkbox"/> Attenuator	Mini-Circuits	VAT-6W2+ (1736)	30-6000 MHz	3/29/2022	3/29/2023
<input checked="" type="checkbox"/> Weather station	Davis	6312 (A81120N075)		11/4/2021	11/4/2022

Rogers Labs, Inc.
 4405 West 259th Terrace
 Louisburg, KS 66053
 Phone/Fax: (913) 837-3214
 Revision r2

Garmin International, Inc.
 Model: A04577
 Test: 221013
 Test to: 47CFR 15E, RSS-Gen RSS-247
 File: A04577 NII TstRpt 221013 r2

SN's: 3432729295 / 3432729465
 FCC ID: IPH-04577
 IC: 1792A-04577
 Date: March 9, 2023
 Page 95 of 98



List of Test Equipment

Calibration Date (m/d/y) Due

<input type="checkbox"/>	Antenna:	Schwarzbeck Model VHBB 9124 (01468)	10/14/2020	10/14/2022
<input type="checkbox"/>	Antenna:	Schwarzbeck Model: VULP 9118 A (VULP 9118 A-856)	10/14/2020	10/14/2022
<input type="checkbox"/>	Frequency Counter:	Leader LDC-825 (8060153)	3/29/2022	3/29/2023
<input type="checkbox"/>	ISN: Com-Power Model	ISN T-8	3/29/2022	3/29/2023
<input type="checkbox"/>	LISN	Compliance Design FCC-LISN-2.Mod.cd,(126) .15-30MHz	10/14/2021	10/14/2022
<input type="checkbox"/>	LISN: Com-Power Model	LI-220A	3/29/2022	3/29/2024
<input type="checkbox"/>	LISN: Com-Power Model	LI-550C	10/14/2020	10/14/2022
<input type="checkbox"/>	Cable	Huber & Suhner Inc. Sucoflex102ea(1.5M)(303072) 9kHz-40 GHz	10/14/2021	10/14/2022
<input type="checkbox"/>	Cable	Huber & Suhner Inc. Sucoflex102ea(L1M)(281183) 9kHz-40 GHz	10/14/2021	10/14/2022
<input type="checkbox"/>	Cable	Huber & Suhner Inc. Sucoflex102ea(L4M)(281184) 9kHz-40 GHz	10/14/2021	10/14/2022
<input type="checkbox"/>	Cable	Huber & Suhner Inc. Sucoflex102ea(L10M)(317546)9kHz-40 GHz	10/14/2021	10/14/2022
<input type="checkbox"/>	Cable	Time Microwave 4M-750HF290-750 (4M) 9kHz-24 GHz	10/14/2021	10/14/2022
<input type="checkbox"/>	RF Filter	Micro-Tronics BRC17663 (001) 9.3-9.5 notch 30-1800 MHz	4/6/2021	4/6/2023
<input type="checkbox"/>	RF Filter	Micro-Tronics BRC19565 (001) 9.2-9.6 notch 30-1800 MHz	10/14/2021	10/14/2023
<input type="checkbox"/>	Analyzer	HP 8562A (3051A05950) 9kHz-125GHz	3/29/2022	3/29/2023
<input type="checkbox"/>	Wave Form Generator	Keysight 33512B (MY57400128)	3/29/2022	3/29/2023
<input type="checkbox"/>	Antenna: Solar	9229-1 & 9230-1	2/22/2022	2/22/2023
<input type="checkbox"/>	CDN: Com-Power Model	CDN325E	10/14/2021	10/14/2022
<input type="checkbox"/>	Injection Clamp	Luthi Model EM101	10/14/2021	10/14/2022
<input type="checkbox"/>	Oscilloscope Scope:	Tektronix MDO 4104	2/22/2022	2/22/2023
<input type="checkbox"/>	EMC Transient Generator	HVT TR 3000	2/22/2022	2/22/2023
<input type="checkbox"/>	AC Power Source (Ametech, California Instruments)		2/22/2022	2/22/2023
<input type="checkbox"/>	Field Intensity Meter:	EFM-018	2/22/2022	2/22/2023
<input type="checkbox"/>	ESD Simulator:	MZ-15	2/22/2022	2/22/2023
<input type="checkbox"/>	R.F. Power Amp	ACS 230-50W		not required
<input type="checkbox"/>	R.F. Power Amp	EIN Model: A301		not required
<input type="checkbox"/>	R.F. Power Amp	A.R. Model: 10W 1010M7		not required
<input type="checkbox"/>	R.F. Power Amp	A.R. Model: 50U1000		not required
<input type="checkbox"/>	Temperature Chamber			not required
<input checked="" type="checkbox"/>	Shielded Room			not required

Rogers Labs, Inc.
 4405 West 259th Terrace
 Louisburg, KS 66053
 Phone/Fax: (913) 837-3214
 Revision r2

Garmin International, Inc.
 Model: A04577
 Test: 221013
 Test to: 47CFR 15E, RSS-Gen RSS-247
 File: A04577 NII TstRpt 221013 r2

SN's: 3432729295 / 3432729465
 FCC ID: IPH-04577
 IC: 1792A-04577
 Date: March 9, 2023
 Page 96 of 98



NVLAP Lab Code 200087-0

Annex C Rogers Qualifications

Scot D. Rogers, Engineer

Rogers Labs, Inc.

Mr. Rogers has approximately 36 years’ experience in the field of electronics. Working experience includes six years working in the automated controls industry and 6 years working with the design, development and testing of radio communications and electronic equipment.

Positions Held:

Systems Engineer: A/C Controls Mfg. Co., Inc.

Electrical Engineer: Rogers Consulting Labs, Inc.

Electrical Engineer: Rogers Labs, Inc. Current

Educational Background:

Bachelor of Science Degree in Electrical Engineering from Kansas State University

Bachelor of Science Degree in Business Administration Kansas State University

Several Specialized Training courses and seminars pertaining to Microprocessors and Software programming

Rogers Labs, Inc.
4405 West 259th Terrace
Louisburg, KS 66053
Phone/Fax: (913) 837-3214
Revision r2

Garmin International, Inc.
Model: A04577
Test: 221013
Test to: 47CFR 15E, RSS-Gen RSS-247
File: A04577 NII TstRpt 221013 r2

SN’s: 3432729295 / 3432729465
FCC ID: IPH-04577
IC: 1792A-04577
Date: March 9, 2023
Page 97 of 98

Annex D Laboratory Certificate of Accreditation

United States Department of Commerce
National Institute of Standards and Technology



Certificate of Accreditation to ISO/IEC 17025:2017

NVLAP LAB CODE: 200087-0

Rogers Labs, Inc.
Louisburg, KS

*is accredited by the National Voluntary Laboratory Accreditation Program for specific services,
listed on the Scope of Accreditation, for:*

Electromagnetic Compatibility & Telecommunications

*This laboratory is accredited in accordance with the recognized International Standard ISO/IEC 17025:2017.
This accreditation demonstrates technical competence for a defined scope and the operation of a laboratory quality
management system (refer to joint ISO-ILAC-IAF Communique dated January 2009).*

2022-03-22 through 2023-03-31
Effective Dates

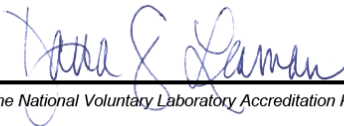

For the National Voluntary Laboratory Accreditation Program

Rogers Labs, Inc.
4405 West 259th Terrace
Louisburg, KS 66053
Phone/Fax: (913) 837-3214
Revision r2

Garmin International, Inc.
Model: A04577
Test: 221013
Test to: 47CFR 15E, RSS-Gen RSS-247
File: A04577 NII TstRpt 221013 r2

SN's: 3432729295 / 3432729465
FCC ID: IPH-04577
IC: 1792A-04577
Date: March 9, 2023
Page 98 of 98