

# ROGERS LABS, INC.

4405 West 259<sup>th</sup> Terrace  
Louisburg, KS 66053  
Phone / Fax (913) 837-3214

## Application For Grant of Certification 47CFR, PART 80E – (Marine Radar), RSS-238 Issue 1, And Industry Canada RSS-GEN Issue 5

Model: A04560

9300-9500 MHz  
Shipborne Radar

FCC ID: IPH-04560

IC: 1792A-04560

## Garmin International, Inc.

1200 East 151st Street  
Olathe, KS 66062

FCC Designation: US5305  
ISED Registration: 3041A

Test Report Number: 221201

Test Date: December 1, 2022

Authorized Signatory: *Scot D. Rogers*  
Scot D. Rogers

This report shall not be reproduced except in full, without the written approval of the laboratory. This report must not be used by the client to claim product certification, approval, or endorsement by NVLAP, NIST, or any agency of the U.S. Government.

Rogers Labs, Inc.  
4405 West 259<sup>th</sup> Terrace  
Louisburg, KS 66053  
Phone/Fax: (913) 837-3214  
Revision 1

Garmin International, Inc.  
Model: A04560  
Test: 221201  
Test to: 47CFR 80E, RSS-238, RSS-Gen  
File: A04560 Garmin TstRpt 221201

SN: 3434382009  
FCC ID: IPH-04560  
IC: 1792A-04560  
Date: January 18, 2023  
Page 1 of 141

**TABLE OF CONTENTS..... 2**

**REVISIONS..... 7**

**EXECUTIVE SUMMARY ..... 8**

**OPINION / INTERPRETATION OF RESULTS ..... 8**

**EQUIPMENT TESTED..... 9**

**Equipment Function .....10**

**Equipment Configuration.....10**

**APPLICATION FOR CERTIFICATION..... 11**

**APPLICABLE STANDARDS..... 13**

**EQUIPMENT TESTING PROCEDURES ..... 13**

**Radiated Emission Test Procedure.....13**

**Antenna Port Conducted Emission Test Procedure.....13**

        Diagram 1 Test arrangement for radiated emissions of tabletop equipment.....14

        Diagram 2 Test arrangement for radiated emissions tested on Open Area Test Site (OATS).....15

        Diagram 3 Test arrangement for Antenna Port Conducted emissions .....16

**TEST SITE LOCATIONS ..... 16**

**UNITS OF MEASUREMENTS ..... 17**

**ENVIRONMENTAL CONDITIONS..... 17**

**STATEMENT OF MODIFICATIONS AND DEVIATIONS ..... 17**

**TEST #1 RF OUTPUT POWER ..... 18**

**Measurements Required.....18**

**Test Arrangement Output Power .....18**

**Table 1 Radio Frequency Output Power.....20**

        Figure 1 Transmitter Output Power .....21

**TEST #2 MODULATION CHARACTERISTICS ..... 22**

**Measurements Required.....22**

**Test Arrangement .....22**

**TEST #3 OCCUPIED BANDWIDTH ..... 23**

**Measurements Required.....23**

**Test Arrangement .....23**

**Table 2 Occupied Bandwidth Results.....24**

        Figure 2 99% Occupied Bandwidth Plot, 1/16 nm .....25

        Figure 3 99% Occupied Bandwidth Plot, 1/8 nm .....26

        Figure 4 99% Occupied Bandwidth Plot, 1/4 nm .....27

        Figure 5 99% Occupied Bandwidth Plot, 1/2 nm .....28

        Figure 6 99% Occupied Bandwidth Plot, 3/4 nm .....29

        Figure 7 99% Occupied Bandwidth Plot, 1 nm .....30

        Figure 8 99% Occupied Bandwidth Plot, 1.5 nm .....31

        Figure 9 99% Occupied Bandwidth Plot, 2 nm .....32

        Figure 10 99% Occupied Bandwidth Plot, 3 nm .....33

        Figure 11 99% Occupied Bandwidth Plot, 4 nm .....34

        Figure 12 99% Occupied Bandwidth Plot, 6 nm .....35

        Figure 13 99% Occupied Bandwidth Plot, 8 nm .....36

        Figure 14 99% Occupied Bandwidth Plot, 12 nm .....37

        Figure 15 99% Occupied Bandwidth Plot, 18 nm .....38

        Figure 16 99% Occupied Bandwidth Plot, 24 nm .....39

        Figure 17 99% Occupied Bandwidth Plot, 36 nm .....40

        Figure 18 99% Occupied Bandwidth Plot, 48 nm .....41

        Figure 19 99% Occupied Bandwidth Plot, 64 nm .....42

        Figure 20 99% Occupied Bandwidth Plot, 72 nm .....43

        Figure 21 99% Occupied Bandwidth Plot, 96 nm .....44

        Figure 22 40-dB Occupied Bandwidth Plot, 1/16 nm.....45

        Figure 23 40-dB Occupied Bandwidth Plot, 1/8 nm.....46

        Figure 24 40-dB Occupied Bandwidth Plot, 1/4 nm.....47

        Figure 25 40-dB Occupied Bandwidth Plot, 1/2 nm.....48

        Figure 26 40-dB Occupied Bandwidth Plot, 3/4 nm.....49

        Figure 27 40-dB Occupied Bandwidth Plot, 1 nm.....50

Figure 28 40-dB Occupied Bandwidth Plot, 1.5 nm.....51

Figure 29 40-dB Occupied Bandwidth Plot, 2 nm.....52

Figure 30 40-dB Occupied Bandwidth Plot, 3 nm.....53

Figure 31 40-dB Occupied Bandwidth Plot, 4 nm.....54

Figure 32 40-dB Occupied Bandwidth Plot, 6 nm.....55

Figure 33 40-dB Occupied Bandwidth Plot, 8 nm.....56

Figure 34 40-dB Occupied Bandwidth Plot, 12 nm.....57

Figure 35 40-dB Occupied Bandwidth Plot, 18 nm.....58

Figure 36 40-dB Occupied Bandwidth Plot, 24 nm.....59

Figure 37 40-dB Occupied Bandwidth Plot, 36 nm.....60

Figure 38 40-dB Occupied Bandwidth Plot, 48 nm.....61

Figure 39 40-dB Occupied Bandwidth Plot, 64 nm.....62

Figure 40 40-dB Occupied Bandwidth Plot, 72 nm.....63

Figure 41 40-dB Occupied Bandwidth Plot, 96 nm.....64

**TEST #4 SPURIOUS EMISSIONS AT ANTENNA TERMINAL ..... 65**

**Measurements Required.....65**

**Test Arrangement .....65**

**Table 3 Spurious Emissions Results .....66**

**Table 4 Spurious Emissions Results .....67**

**Table 5 Spurious Emissions Results .....68**

**TEST #5 EMISSION LIMITATIONS IN-BAND (MASK)..... 69**

**Measurements Required.....69**

**Test Arrangement .....69**

    Figure 42 Emissions Mask, 1/16 nm .....70

    Figure 43 Emissions Mask, 1/8 nm .....71

    Figure 44 Emissions Mask, 1/4 nm .....72

    Figure 45 Emissions Mask, 1/2 nm .....73

    Figure 46 Emissions Mask, 3/4 nm .....74

    Figure 47 Emissions Mask, 1 nm.....75

    Figure 48 Emissions Mask, 1.5 nm.....76

    Figure 49 Emissions Mask, 2 nm.....77

    Figure 50 Emissions Mask, 3 nm.....78

Figure 51 Emissions Mask, 4 nm.....79

Figure 52 Emissions Mask, 6 nm.....80

Figure 53 Emissions Mask, 8 nm.....81

Figure 54 Emissions Mask, 12 nm.....82

Figure 55 Emissions Mask, 18 nm.....83

Figure 56 Emissions Mask, 24 nm.....84

Figure 57 Emissions Mask, 36 nm.....85

Figure 58 Emissions Mask, 48 nm.....86

Figure 59 Emissions Mask, 64 nm.....87

Figure 60 Emissions Mask, 72 nm.....88

Figure 61 Emissions Mask, 96 nm.....89

**TEST #6 EMISSION LIMITATIONS OUT-OF-BAND..... 90**

**Measurements Required.....90**

**Test Arrangement .....90**

Figure 62 Out-of-Band Emissions 1/16 nm.....91

Figure 63 Out-of-Band Emissions 1/16 nm.....92

Figure 64 Out-of-Band Emissions 1/8 nm.....93

Figure 65 Out-of-Band Emissions 1/8 nm.....94

Figure 66 Out-of-Band Emissions 1/4 nm.....95

Figure 67 Out-of-Band Emissions 1/4 nm.....96

Figure 68 Out-of-Band Emissions 1/2 nm.....97

Figure 69 Out-of-Band Emissions 1/2 nm.....98

Figure 70 Out-of-Band Emissions 3/4 nm.....99

Figure 71 Out-of-Band Emissions 3/4 nm.....100

Figure 72 Out-of-Band Emissions 1 nm.....101

Figure 73 Out-of-Band Emissions 1 nm.....102

Figure 74 Out-of-Band Emissions 1.5 nm.....103

Figure 75 Out-of-Band Emissions 1.5 nm.....104

Figure 76 Out-of-Band Emissions 2 nm.....105

Figure 77 Out-of-Band Emissions 2 nm.....106

Figure 78 Out-of-Band Emissions 3 nm.....107

Figure 79 Out-of-Band Emissions 3 nm.....108

Figure 80 Out-of-Band Emissions 4 nm.....109

Figure 81 Out-of-Band Emissions 4 nm.....110

Figure 82 Out-of-Band Emissions 6 nm.....111

Figure 83 Out-of-Band Emissions 6 nm .....	112	
Figure 84 Out-of-Band Emissions 8 nm .....	113	
Figure 85 Out-of-Band Emissions 8 nm .....	114	
Figure 86 Out-of-Band Emissions 12 nm .....	115	
Figure 87 Out-of-Band Emissions 12 nm .....	116	
Figure 88 Out-of-Band Emissions 18 nm .....	117	
Figure 89 Out-of-Band Emissions 18 nm .....	118	
Figure 90 Out-of-Band Emissions 24 nm .....	119	
Figure 91 Out-of-Band Emissions 24 nm .....	120	
Figure 92 Out-of-Band Emissions 36 nm .....	121	
Figure 93 Out-of-Band Emissions 36 nm .....	122	
Figure 94 Out-of-Band Emissions 48 nm .....	123	
Figure 95 Out-of-Band Emissions 48 nm .....	124	
Figure 96 Out-of-Band Emissions 64 nm .....	125	
Figure 97 Out-of-Band Emissions 64 nm .....	126	
Figure 98 Out-of-Band Emissions 72 nm .....	127	
Figure 99 Out-of-Band Emissions 72 nm .....	128	
Figure 100 Out-of-Band Emissions 96 nm .....	129	
Figure 101 Out-of-Band Emissions 96 nm .....	130	
<b>TEST #7 FIELD STRENGTH OF SPURIOUS RADIATED EMISSIONS .....</b>	<b>131</b>	
<b>Measurements Required.....</b>	<b>131</b>	
<b>Test Arrangement .....</b>	<b>131</b>	
<b>Table 6 Field Strength of Spurious Radiated Emissions Results .....</b>	<b>133</b>	
<b>TEST #8 FREQUENCY STABILITY .....</b>	<b>134</b>	
<b>Measurements Required.....</b>	<b>134</b>	
<b>Test Arrangement .....</b>	<b>134</b>	
<b>Table 7 Frequency Stability vs. Temperature Results .....</b>	<b>135</b>	
<b>Table 8 Frequency Stability vs. Input Power Supply Voltage Results .....</b>	<b>135</b>	
<b>ANNEX.....</b>	<b>136</b>	
<b>Annex A Measurement Uncertainty Calculations.....</b>	<b>137</b>	
<b>Annex B Test Equipment.....</b>	<b>138</b>	
Rogers Labs, Inc.	Garmin International, Inc.	SN: 3434382009
4405 West 259 <sup>th</sup> Terrace	Model: A04560	FCC ID: IPH-04560
Louisburg, KS 66053	Test: 221201	IC: 1792A-04560
Phone/Fax: (913) 837-3214	Test to: 47CFR 80E, RSS-238, RSS-Gen	Date: January 18, 2023
Revision 1	File: A04560 Garmin TstRpt 221201	Page 6 of 141



NVLAP Lab Code 200087-0

**Annex C Rogers Qualifications .....140**

**Annex D Laboratory Certificate of Accreditation.....141**

## Revisions

Revision 1 Issued January 18, 2023

Rogers Labs, Inc.  
 4405 West 259<sup>th</sup> Terrace  
 Louisburg, KS 66053  
 Phone/Fax: (913) 837-3214  
 Revision 1

Garmin International, Inc.  
 Model: A04560  
 Test: 221201  
 Test to: 47CFR 80E, RSS-238, RSS-Gen  
 File: A04560 Garmin TstRpt 221201

SN: 3434382009  
 FCC ID: IPH-04560  
 IC: 1792A-04560  
 Date: January 18, 2023  
 Page 7 of 141

## Executive Summary

In accordance with the Federal Communications, Title 47 Code of Federal Regulations (47CFR) dated December 1, 2022, Part 2 Subpart J, and Part 80, Subchapter E, RSS-238 Issue 1, and RSS-GEN Issue 5 the following information is submitted for consideration in obtaining grant of certification.

Name of Applicant: Garmin International, Inc.  
 1200 East 151st Street  
 Olathe, KS 66062

M/N: A04560 HVIN: A04560  
 FCC ID: IPH-04560 IC: 1792A-04560  
 Operating Frequency Range: 9300-9500 MHz

## Opinion / Interpretation of Results

Requirement	Description	Results
2.202	Bandwidth & Emission	Complies
2.1033(C)(8)	Power at Final Amplifier	Complies
2.1046(a)	RF Output Power	Complies
2.1047	Modulation characteristics	Complies
2.1049	Occupied Bandwidth	Complies
2.1051	Spurious emissions at antenna terminals	Complies
2.1053, RSS-238 4.3	Field Strength of spurious radiation	Complies
2.1055, RSS-238 4.1	Frequency Stability	Complies

Requirement	Description	Results
80.205(a), (d)	Bandwidth & Emissions Designator	Complies
80.209(c)	Transmitter Frequency Tolerance	Complies
80.211(f), RSS-238 4.3	Emission Limitations, In-band	Complies
80.211(f), RSS-238 4.3	Emission Limitations, Out-of-band	Complies
80.213(g)	Modulation Requirements	Complies
80.215(a)(3),(n)(3), RSS-238 4.2	Transmitter Power	Complies



## Equipment Tested

Model: A04560

Garmin International, Inc.  
1200 East 151st Street  
Olathe, KS 66062

<u>Equipment</u>	<u>Model / PN</u>	<u>Serial Number</u>
EUT (test sample, Power Load or antenna)	A04560	3434382009
Radar Voltage Converter	011-01315-50	6SA000150
Power cable (0.8-meter)	Custom Cable (No P/N)	N/A
Power cable (2-meter)	Custom Cable (No P/N)	N/A
Power cable (15-meter)	320-00246-40	N/A
I/O cable (2-meter)	320-01038-00	N/A
I/O cable (15-meter)	011-05671-00	N/A
Chart Plotter (GPSMap 8208)	010-01016-01	3855826969
DC Power Supply	BK 1745	209C13
Marine Battery (12Volt)	Duracell	N/A

Test results in this report relate only to the items tested. Worst-case configuration data recorded in this report.

Software: 0.21, Antennas: 4-foot open array (27 dBi), 6-foot open array (29 dBi)

### **Equipment Function**

The EUT is ship borne marine radar designed to provide bearing and distance information of ship and land targets located within the field of view (near the ship). The radar unit must be integrated into a full Marine system installation for operation, including chart plotter for display and control purposes. As the radar sweeps through 360°, reflected signals are interpreted and displayed on the chart plotter as indication of potential above surface hazards. Test results in this report relate only to the products described in this report.

### **Equipment Configuration**

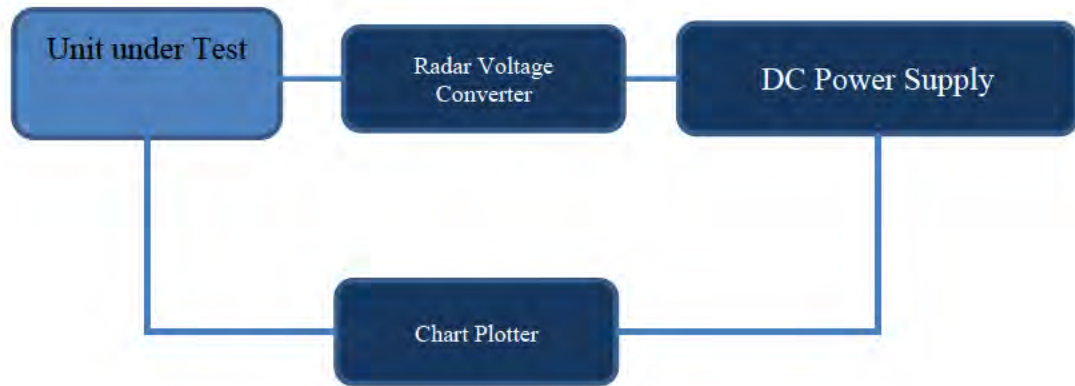

## Application for Certification

1. Manufacturer:                   Garmin International, Inc.  
  1200 East 151st Street  
  Olathe, KS 66062
2. Identification: **HVIN: A04560   FCC ID: IPH-04560   IC: 1792A-04560**
3. A copy of the installation and operating instructions furnished to the end user. Refer to the instruction manual furnished with this application for details.
4. Emission Types: Modulated in width/duration/data – Sequence of unmodulated pulses  
47M6PON
5. Frequency Range: 9300-9500 MHz
6. Range of operating power values or specific operating power levels, and description of any means provided for variation of operating power. 12.0 Watts Mean power, (25kW peak).
7. Maximum power rating as defined in the applicable part(s) of the rules. As stated in 47CFR, 80.215, 20.0 Watts EIRP as listed on license.
8. The dc voltages applied to and dc currents into the several elements of the final radio frequency amplifying device for normal operation over the power range. The maximum operating mode runs at 8,500 volts consuming 8.0 amps.
9. Provide the tune-up procedure over the power range, or at specific operating power levels. Refer to the tune-up procedure furnished with this application for details.
10. A schematic diagram and a description of all circuitry and devices provided for determining and stabilizing frequency, for suppression of spurious radiation, for limiting modulation, and for limiting power. Refer to the schematics and technical exhibits furnished with this application for details.
11. A photograph or drawing of the equipment identification plate, or label showing the information to be placed thereon shall be provided. Refer to the identification label exhibit and information furnished with this application for details.
12. Photographs (8" x 10") of the equipment of sufficient clarity to reveal equipment construction and layout, including meters, if any, and labels for controls and meters and sufficient views of the internal construction to define component placement and chassis assembly. Insofar as these requirements are met by photographs or drawings contained in instruction manuals supplied with the certification request, additional photographs are necessary only to complete the required showing. Refer to the exhibits of this report and or additional information furnished with the application for details.
13. For equipment employing digital modulation techniques, a detailed description of the modulation system to be used, including the response characteristics (frequency, phase, and amplitude) of any filters provided, and a description of the modulating wave train, shall be submitted for the maximum rated conditions under which the equipment will be operated. Information about modulation is contained in Operational description exhibit.
14. The data required by Sections 2.1046 through 2.1057, inclusive, measured in accordance with the procedures set out in Section 2.1041.

Rogers Labs, Inc.	Garmin International, Inc.	SN: 3434382009
4405 West 259 <sup>th</sup> Terrace	Model: A04560	FCC ID: IPH-04560
Louisburg, KS 66053	Test: 221201	IC: 1792A-04560
Phone/Fax: (913) 837-3214	Test to: 47CFR 80E, RSS-238, RSS-Gen	Date: January 18, 2023
Revision 1	File: A04560 Garmin TstRpt 221201	Page 11 of 141

15. The application for certification of an external radio frequency power amplifier under Part 97 of this chapter need not be accompanied by the data required by Paragraph (b)(14) of this section. In lieu thereof, measurements shall be submitted to show compliance with the technical specifications in Subpart C of Part 97 of this chapter and such information as required by Section 2.1060 of this part. This paragraph does not apply to this equipment.
16. An application for certification of an AM broadcast stereophonic exciter generator intended for interfacing with existing certified, or formerly type accepted or notified transmitters must include measurements made on a complete stereophonic transmitter. The instruction book must include complete specifications and circuit requirements for interconnecting with existing transmitters. The instruction book must also provide a full description of the equipment and measurement procedures to monitor modulation and to verify that the combination of stereo exciter generator and transmitter meets the emission limitations of section 73.44. This paragraph does not apply to this equipment.
17. A single application may be filed for a composite system that incorporates devices subject to certification under multiple rule parts; however, the appropriate fee must be included for each device. Separate applications must be filed if different FCC Identifiers will be used for each device.
18. The device is not a software-defined radio and requirements of 2.944 do not apply to this application.
19. Applications for certification of equipment operating under part 27 of this chapter, that a manufacturer is seeking to certify for operation in the:
  - (i) 1755-1780 MHz, 2155-2180 MHz, or both bands shall include a statement indicating compliance with the pairing of 1710-1780 and 2110-2180 MHz specified in §§27.5(h) and 27.75 of this chapter.
  - (ii) 1695-1710 MHz, 1755-1780 MHz, or both bands shall include a statement indicating compliance with §27.77 of this chapter.
  - (iii) 600 MHz band shall include a statement indicating compliance with §27.75 of this chapter.
20. Applications for certification of equipment operating under part 90 of this chapter and capable of operating on the 700 MHz interoperability channels (See §90.531(b)(1) of this chapter) shall include a Compliance Assessment Program Supplier's Declaration of Conformity and Summary Test Report or, alternatively, shall include a document detailing how the applicant determined that its equipment complies with §90.548 of this chapter and that the equipment is interoperable across vendors.
21. Contain at least one drawing or photograph showing the test set-up for each of the required types of tests applicable to the device for which certification is requested. These drawings or photographs must show enough detail to confirm other information contained in the test report. Any photographs used must be focused originals without glare or dark spots and must clearly show the test configuration used.

## Applicable Standards

In accordance with the Federal Communications Commission, Code of Federal Regulations 47CFR, dated December 1, 2022, Part 2, Subpart J, Part 80, Industry Canada RSS-238 Issue 1 and RSS-GEN Issue 5, the following information is submitted. Test procedures used are as required in applicable paragraphs of the standards and performed as specified in ANSI C63.26-2015.

## Equipment Testing Procedures

### *Radiated Emission Test Procedure*

Radiated emissions testing was performed as required in 47 CFR 80E, RSS-238 Issue 1, and specified in ANSI C63.26-2015. The EUT was placed on a rotating 0.9 x 1.2-meter platform, elevated as required above the ground plane at a distance of 3 meters from the FSM antenna. EMI energy was maximized by equipment placement permitting orientation in three orthogonal axes, raising, and lowering the FSM antenna, changing the antenna polarization, and by rotating the turntable. Each emission was maximized before data was taken and recorded. The frequency spectrum from 9 kHz to 40,000 MHz was searched for emissions during preliminary investigation. Refer to diagrams one and two showing typical test setup. Refer to photographs in the test setup exhibits for specific EUT placement during testing.

### *Antenna Port Conducted Emission Test Procedure*

The EUT was assembled as required for operation and testing at the antenna port and placed on a benchtop. This configuration provided the ability to connect test equipment to the provided test antenna port. Antenna Port conducted emissions testing was performed as required in the regulations and specified in ANSI C63.26-2015. Antenna Port Conducted testing was completed on a laboratory bench in a shielded room. The active antenna port of the device was connected to appropriate coupler and attenuation and the spectrum analyzer. Refer to diagram three showing typical test arrangement and photographs in the test setup exhibits for specific EUT placement during testing.

**Diagram 1 Test arrangement for radiated emissions of tabletop equipment**

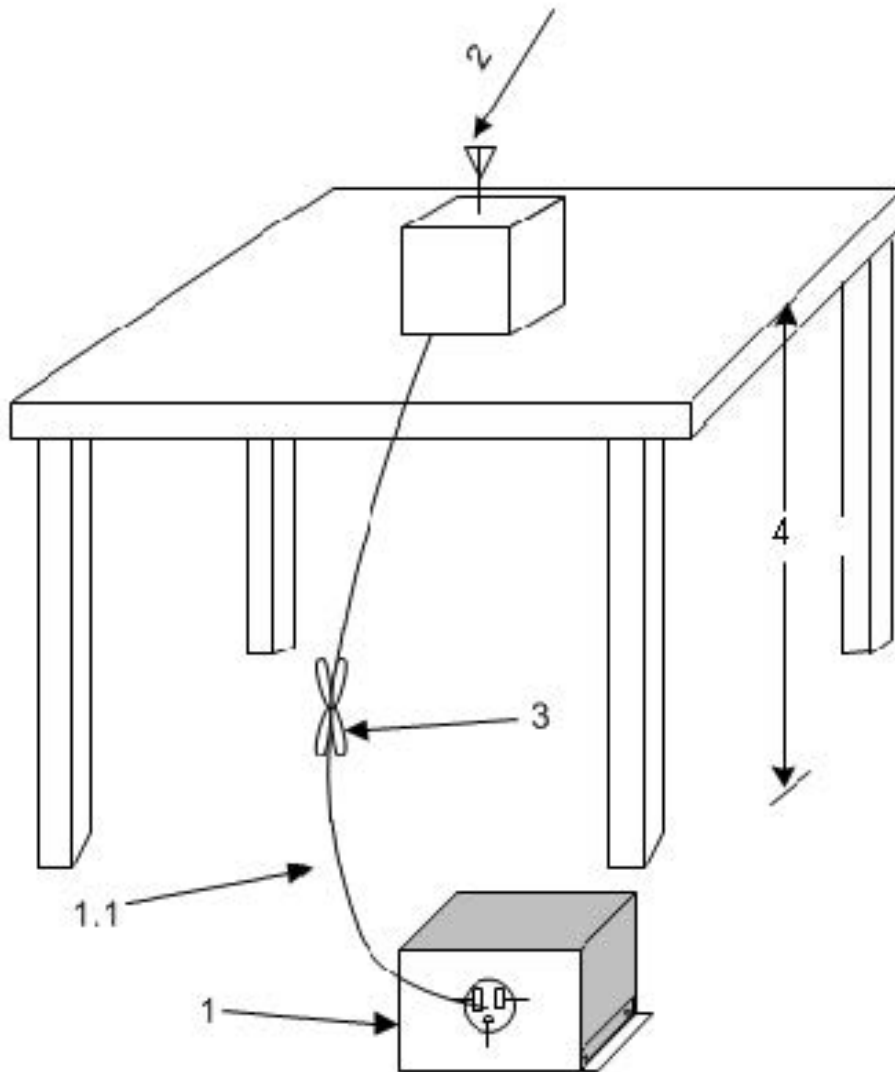

1—A LISN is optional for radiated measurements between 30 MHz and 1000 MHz but not allowed for measurements below 30 MHz and above 1000 MHz (see 6.3.1). If used, then connect EUT to one LISN. Unused LISN measuring port connectors shall be terminated in 50  $\Omega$  loads. The LISN may be placed on top of, or immediately beneath, the reference ground plane (see 6.2.2 and 6.2.3.2).

1.1—LISN spaced at least 80 cm from the nearest part of the EUT chassis.

2—Antenna can be integral or detachable, depending on the EUT (see 6.3.1).

3—Interconnecting cables that hang closer than 40 cm to the ground plane shall be folded back and forth in the center forming a bundle 30 cm to 40 cm long (see 6.3.1).

4—For emission measurements at or below 1 GHz, the table height shall be 80 cm. For emission measurements above 1 GHz, the table height shall be 1.5 m for measurements, except as otherwise specified (see 6.3.1 and 6.6.3.1).

**Diagram 2 Test arrangement for radiated emissions tested on Open Area Test Site (OATS)**  
 Below 1 GHz

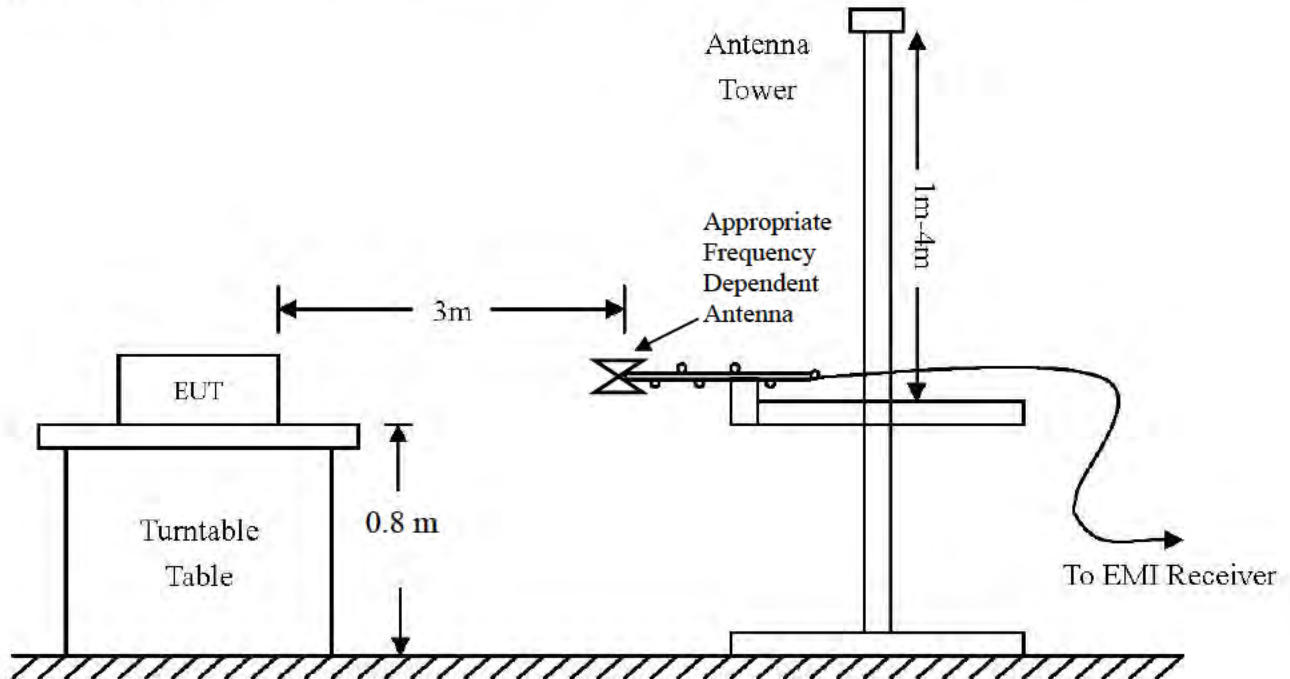

Above 1 GHz

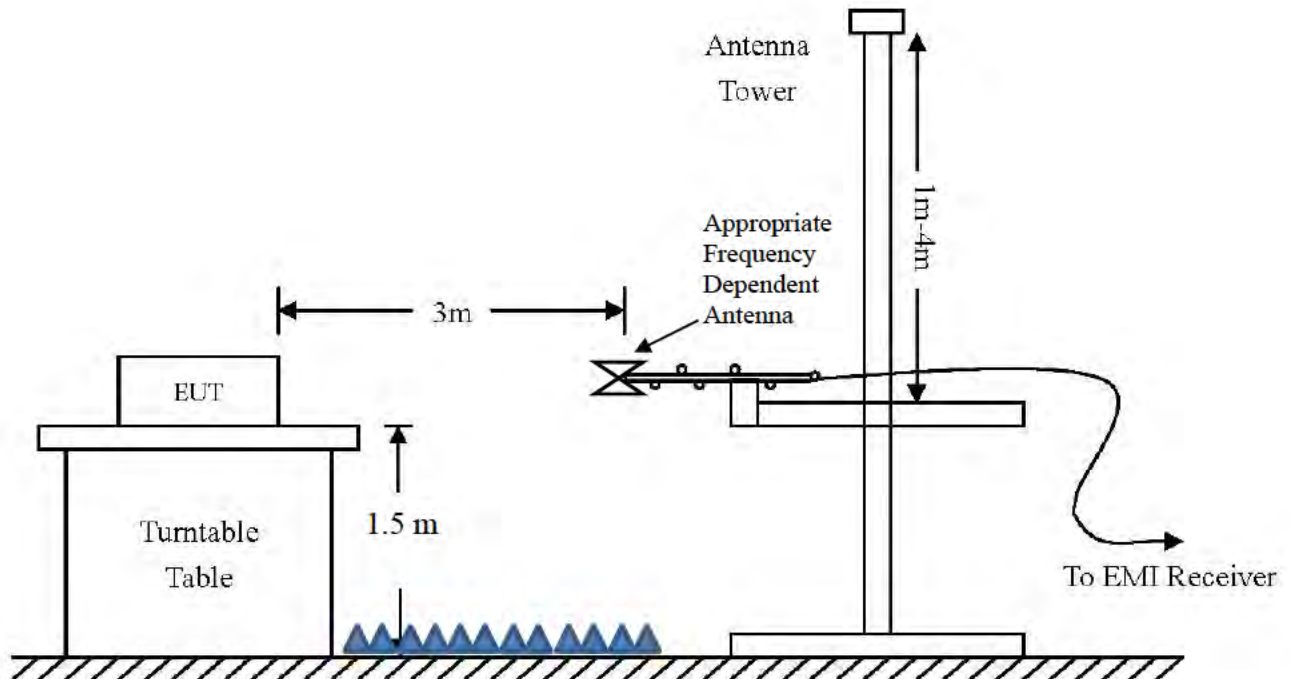

**Diagram 3 Test arrangement for Antenna Port Conducted emissions**

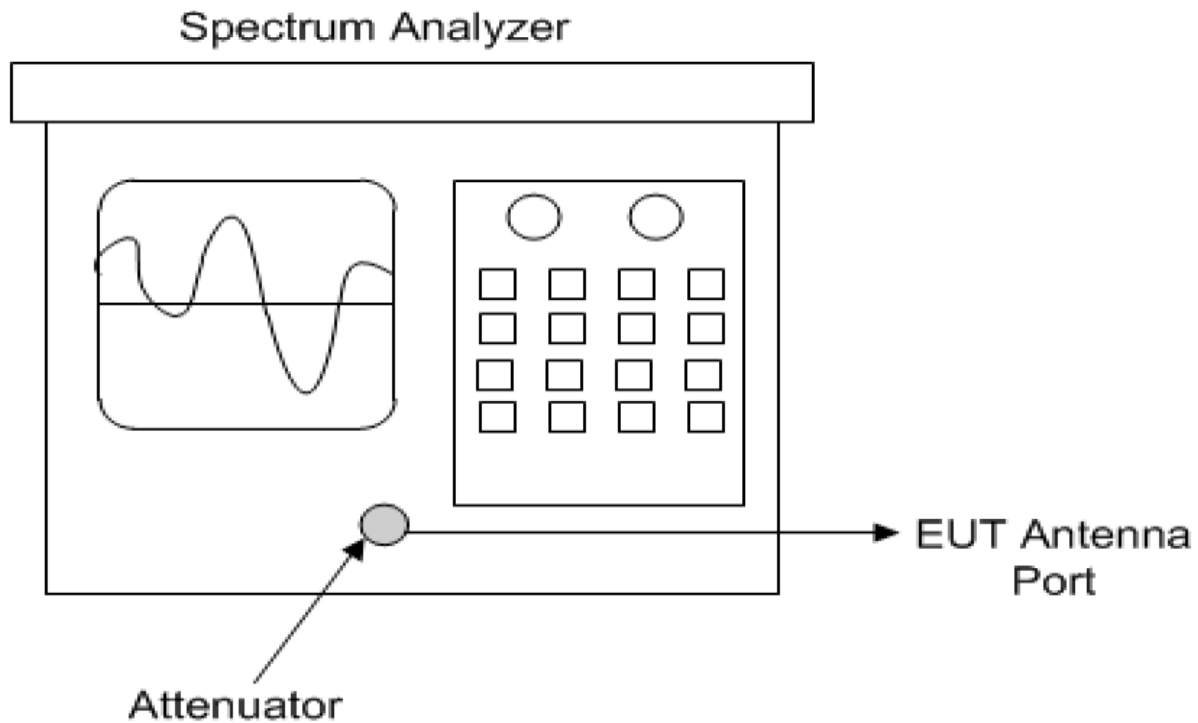

**Test Site Locations**

Conducted EMI AC line conducted emissions testing performed in a shielded screen room located at Rogers Labs, Inc., 4405 West 259<sup>th</sup> Terrace, Louisburg, KS

Antenna port Antenna port conducted emissions testing was performed in a shielded screen room located at Rogers Labs, Inc., 4405 West 259<sup>th</sup> Terrace, Louisburg, KS

Radiated EMI The radiated emissions tests were performed at the 3 meters, Open Area Test Site (OATS) located at Rogers Labs, Inc., 4405 West 259<sup>th</sup> Terrace, Louisburg, KS

Registered Site information: FCC Site: US5305, ISED: 3041A, CAB Identifier: US0096

NVLAP Accreditation Lab code 200087-0



## Units of Measurements

Conducted EMI            Data presented in dB $\mu$ V; dB referenced to one microvolt

Antenna port Conducted            Data is in dBm; dB referenced to one milliwatt

Radiated EMI            Data presented in dB $\mu$ V/m; dB referenced to one microvolt per meter

Note: Radiated limit may be expressed for measurement in dB $\mu$ V/m when the measurement is taken at a distance of 3 or 10 meters. Data taken for this report was taken at distance of 3 meters. Sample calculation demonstrates corrected field strength reading for Open Area Test Site using the measurement reading and correcting for receive antenna factor, cable losses, and amplifier gains.

Sample Calculation:

RFS = Radiated Field Strength, FSM = Field Strength Measured

A.F. = Receive antenna factor, Losses = attenuators/cable losses, Gain = amplification gains

$RFS (dB\mu V/m @ 3m) = FSM (dB\mu V) + A.F. (dB/m) + Losses (dB) - Gain (dB)$

## Environmental Conditions

Ambient Temperature            21.2° C

Relative Humidity            25 %

Atmospheric Pressure            1032.3 mb

## Statement of Modifications and Deviations

No modifications to the EUT were required for the equipment to demonstrate compliance with the 47 CFR Part 80E, Industry Canada RSS-238 Issue 1, and RSS-GEN Issue 5 emission requirements. There were no deviations to the specifications.

## TEST #1 RF Output Power

### Measurements Required

Measurements shall be made to establish the radio frequency power delivered by the transmitter into the standard output termination. The power output shall be monitored and recorded, and no adjustment shall be made to the transmitter after the test has begun, except as noted below:

If the power output is adjustable, measurements shall be made for the highest and lowest power levels.

### Test Arrangement Output Power

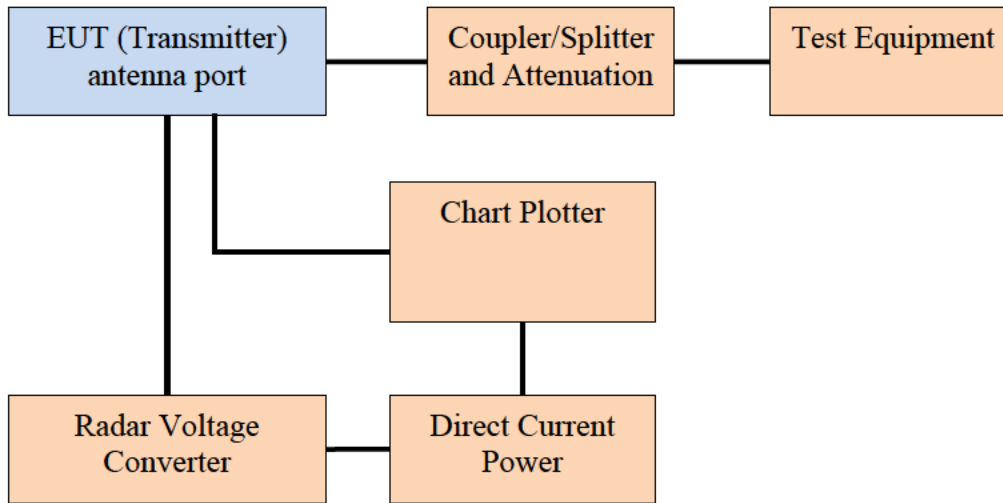

The radio frequency power output was measured at the antenna terminal by placing appropriate wave guide, power splitter and attenuation on the antenna port connector and observing the spectral emissions with the spectrum analyzer. The load, spectrum analyzer and attenuation provided an impedance of 50Ω to match the impedance of the standard antenna. A Rohde & Schwarz ESU40 Spectrum Analyzer and/or Power Meter/Sensor were used to measure the radio frequency power at the antenna port. Data was taken in dBm and converted to watts as shown in the following table. The testing procedures used conform to the procedures stated in the ANSI C63.26-2015 document. Data was taken per 47CFR Paragraph 2.1046(a) and applicable paragraphs of Part 80 and RSS-238. Average output power is calculated using measured peak power reduced by Duty-Cycle (DC). The DC is calculated using the Pulse Width (PW) and Pulse Repetition Frequency (PRF). Duty cycles

range from 0.032% to 0.099%, (details for each Nautical Mile (nm) range may be found in Operational Description exhibit provided with this filing).

Refer to Figure 1 showing plot of output power of the transmitter.

$P_{dBm}$  = power in dB above 1 milliwatt

Milliwatts =  $10^{(PdBm/10)}$

Watts = (Milliwatts) (0.001) (W/mW)

Milliwatts =  $10^{(74/10)}$

= 25,000,000.0 mW

= 25,000 Watts power

for 1/16 nm Pulse Width Pulse Repetition Frequency (PRF)

PW = 150 ns PRF = 2304 Hz

Duty-Cycle (DC) =  $(150E-9 \times 2304) \times 100\%$

DC = 0.035%

Average Power for 1/16 nm

Ave Power =  $25,000 \times 0.00035$

= 8.94 Watts

**Table 1 Radio Frequency Output Power**

Transmitter Range Setting (nm)	Power Output (dBm)	Peak Power Output (W)	Duty Cycle Correction	Average Power Output (dBm)	Average Power Output (W)
0.0625	74.0	25,000	0.035%	39.4	8.64
0.125	74.0	25,000	0.035%	39.4	8.64
0.25	74.0	25,000	0.035%	39.4	8.64
0.375	74.0	25,000	0.035%	39.4	8.64
0.5	74.0	25,000	0.035%	39.4	8.64
0.75	74.0	25,000	0.041%	40.2	10.37
1	74.0	25,000	0.046%	40.6	11.52
1.5	74.0	25,000	0.043%	40.3	10.66
2	74.0	25,000	0.047%	40.7	11.81
3	74.0	25,000	0.043%	40.3	10.66
4	74.0	25,000	0.048%	40.8	11.95
6	74.0	25,000	0.048%	40.8	11.95
8	74.0	25,000	0.048%	40.8	11.95
12	74.0	25,000	0.048%	40.8	11.95
18	74.0	25,000	0.048%	40.8	11.95
24	74.0	25,000	0.048%	40.8	11.95
36	74.0	25,000	0.048%	40.8	11.95
64	74.0	25,000	0.048%	40.8	11.95
72	74.0	25,000	0.048%	40.8	11.95
96	74.0	25,000	0.048%	40.8	11.95

The average power output calculations are available in Operational description exhibit supplied with this application. Data was taken per Paragraph 2.1046(a) and applicable parts of Part 80 and RSS-238. The equipment demonstrated compliance with specifications of Paragraph 2.1046(a) and applicable Parts of 80 and RSS-238. There were no modifications or deviations to the specifications.

Figure 1 Transmitter Output Power

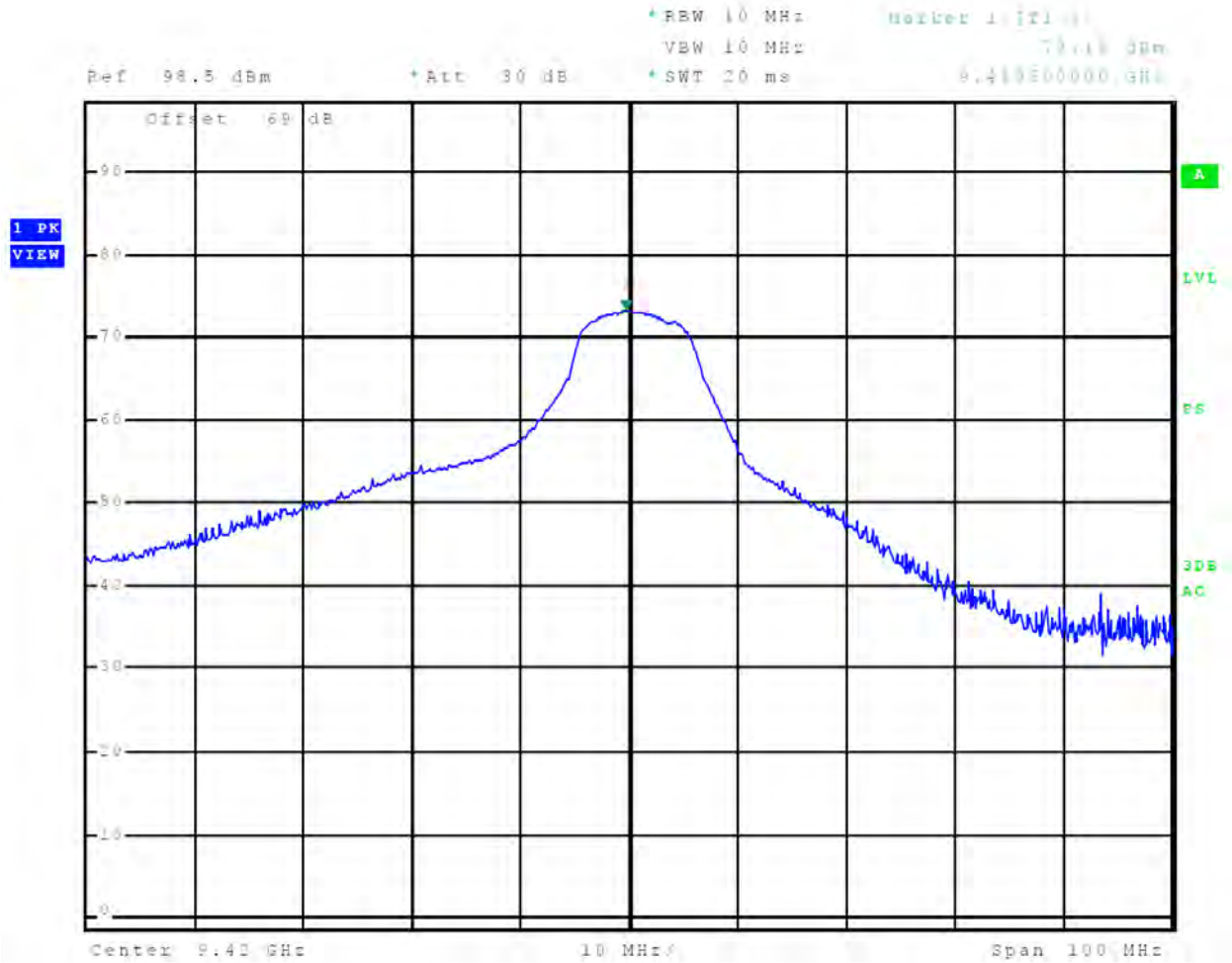



## TEST #2 Modulation Characteristics

### Measurements Required

A curve or equivalent data that shows that the equipment will meet the modulation requirements of the rules under which the equipment is to be licensed shall be submitted.

### Test Arrangement

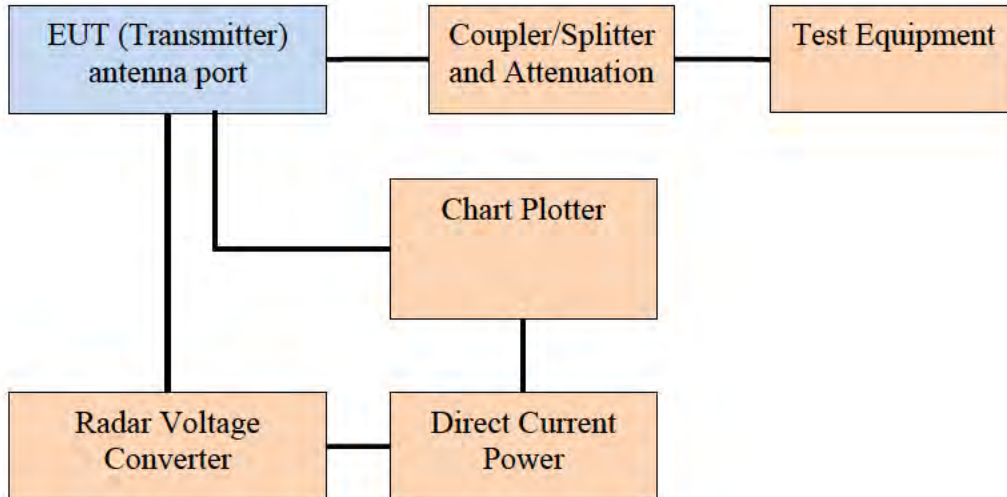

The transmitter operates as licensed transmitter equipment providing operation as marine mounted radar using pulsed Continuous Wave (CW) signal with no modulated information. Therefore, no Audio Frequency Response, Low Pass Filter Response, or modulation limiting is required or performed as these are not applicable to this equipment. The EUT demonstrates compliance with the specifications of Paragraphs 2.1046(a), 80 and RSS-238. There are no deviations to the specifications.

### TEST #3 Occupied Bandwidth

#### Measurements Required

The occupied bandwidth, which is the frequency bandwidth such that below its lower and above its upper frequency limits, the mean powers radiated are equal to 0.5 percent of the total mean power radiated by a given emission. The 40-dB down occupied Bandwidth is the frequency bandwidth which is 40 dB below the peak power. Refer to figures 2 through 41 displaying plots of the occupied bandwidth measurement.

#### Test Arrangement

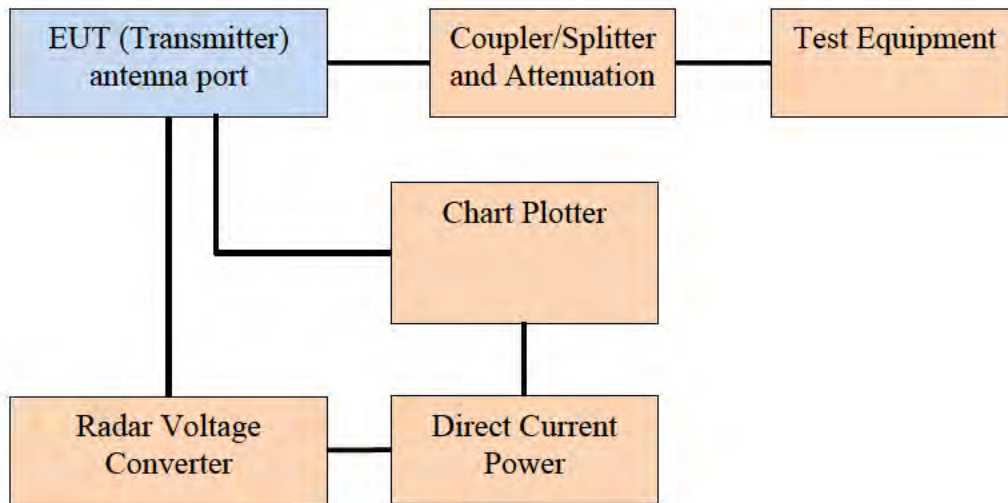

**Table 2 Occupied Bandwidth Results**

Setting (nm)	99% Occupied Bandwidth (kHz)	40-dB Occupied Bandwidth (kHz)
1/16	47,600	92,083
1/8	46,400	93,910
1/4	44,800	85,847
1/2	46,000	106,664
3/4	39,300	99,662
1	37,650	91,800
1.5	26,750	69,008
2	26,000	70,595
3	16,050	58,864
4	13,646	55,449
6	13,438	55,128
8	13,646	53,846
12	13,438	55,769
18	13,542	54,167
24	13,646	53,205
36	13,646	55,769
48	13,646	54,808
64	13,438	56,410
72	13,542	54,487
96	13,542	56,731

The EUT demonstrated compliance with the requirements of Paragraphs 2.1046(a), 80 and RSS-238. There are no deviations to the specifications.

Authorized Bandwidth = 200 MHz  
 Necessary Bandwidth = 47.6 MHz



**Figure 2 99% Occupied Bandwidth Plot, 1/16 nm**

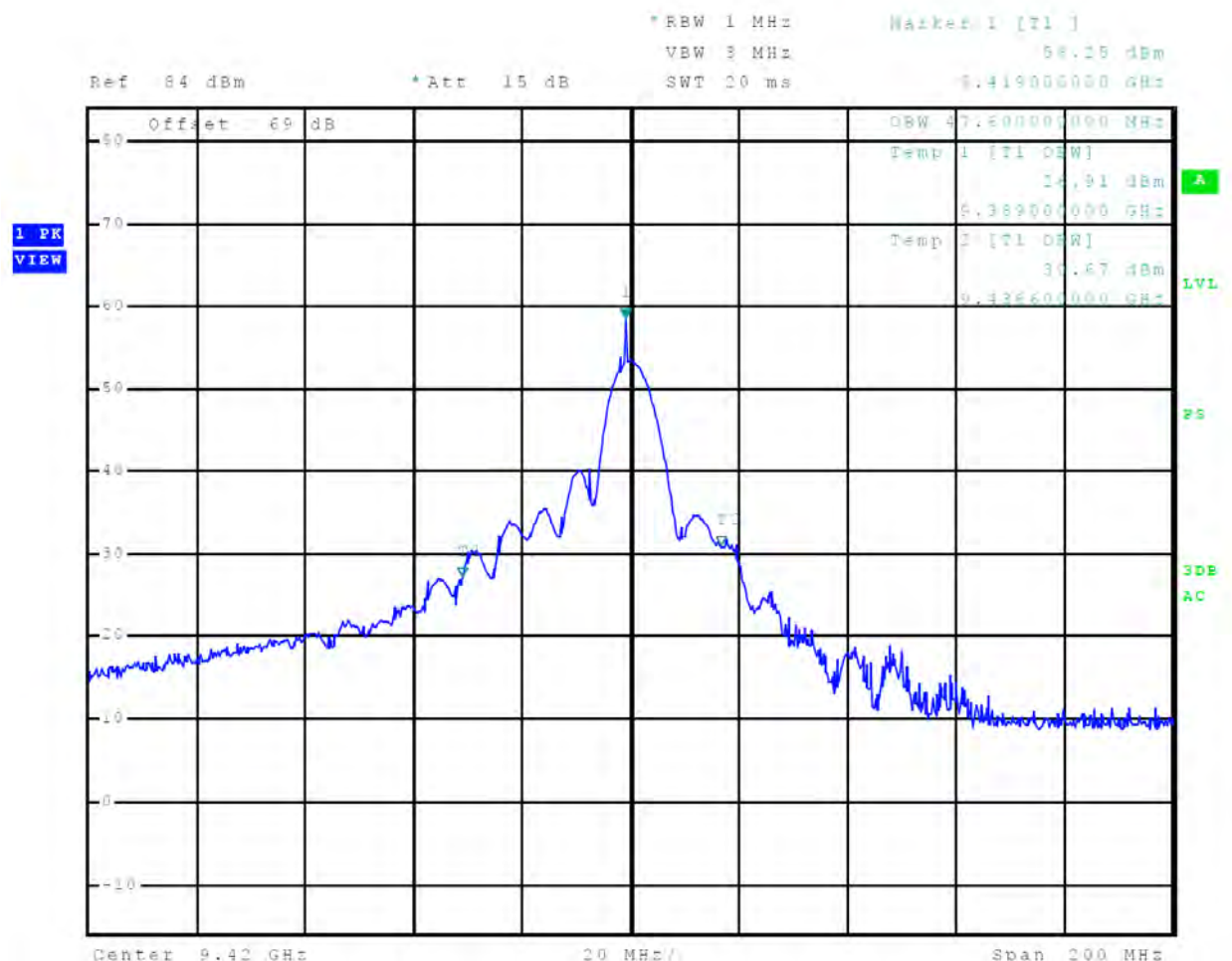

Figure 3 99% Occupied Bandwidth Plot, 1/8 nm

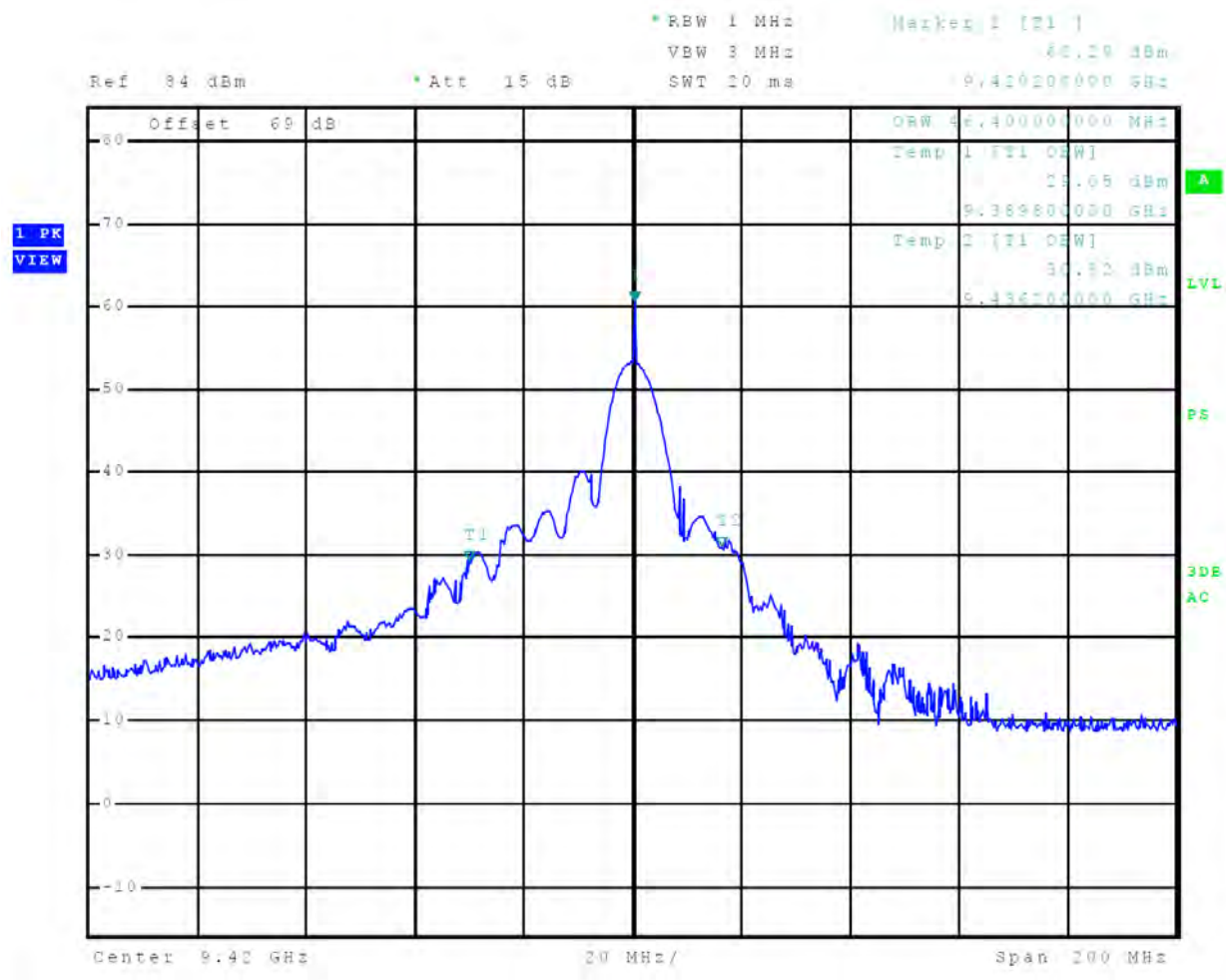

Figure 4 99% Occupied Bandwidth Plot, 1/4 nm

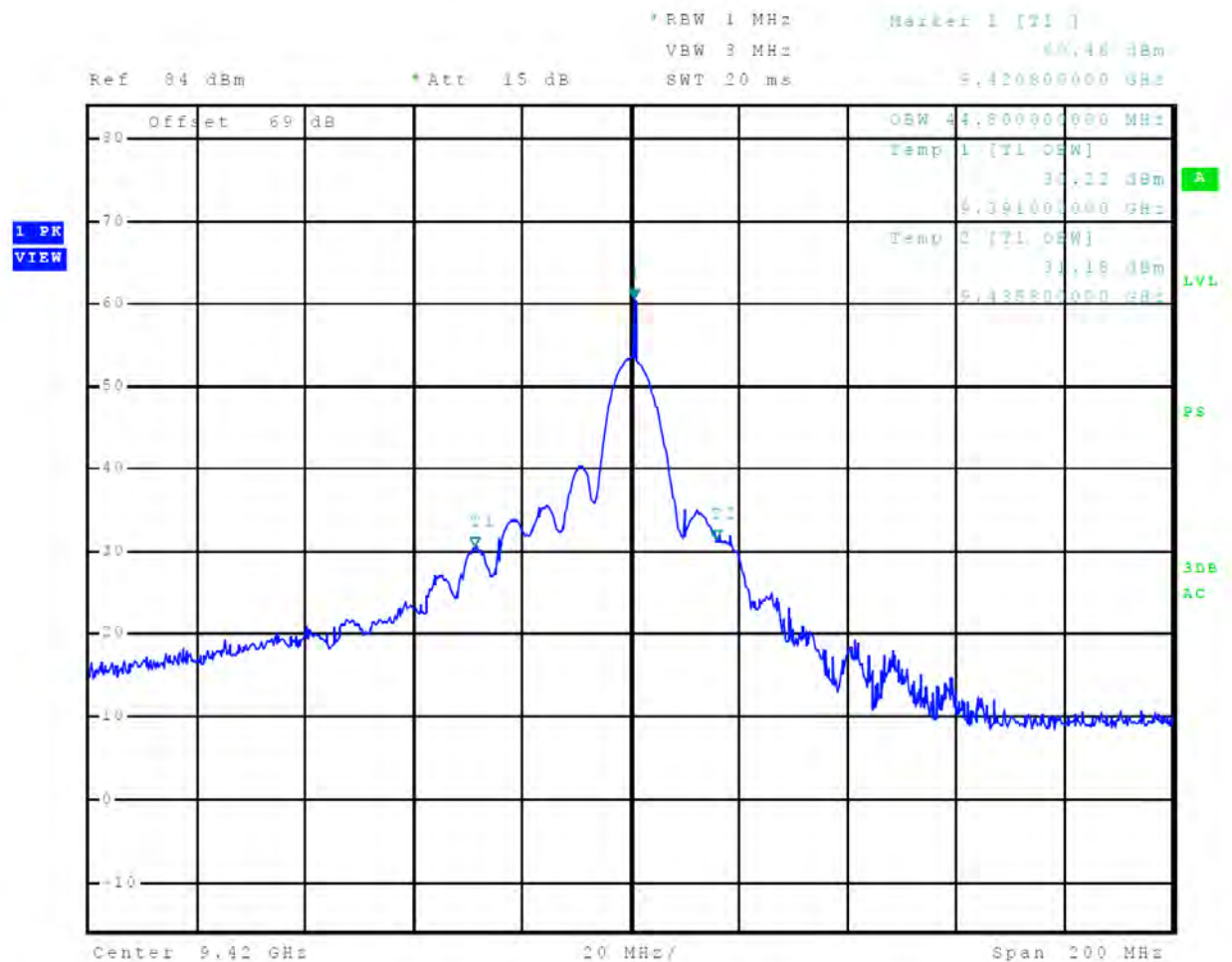

Figure 5 99% Occupied Bandwidth Plot, 1/2 nm

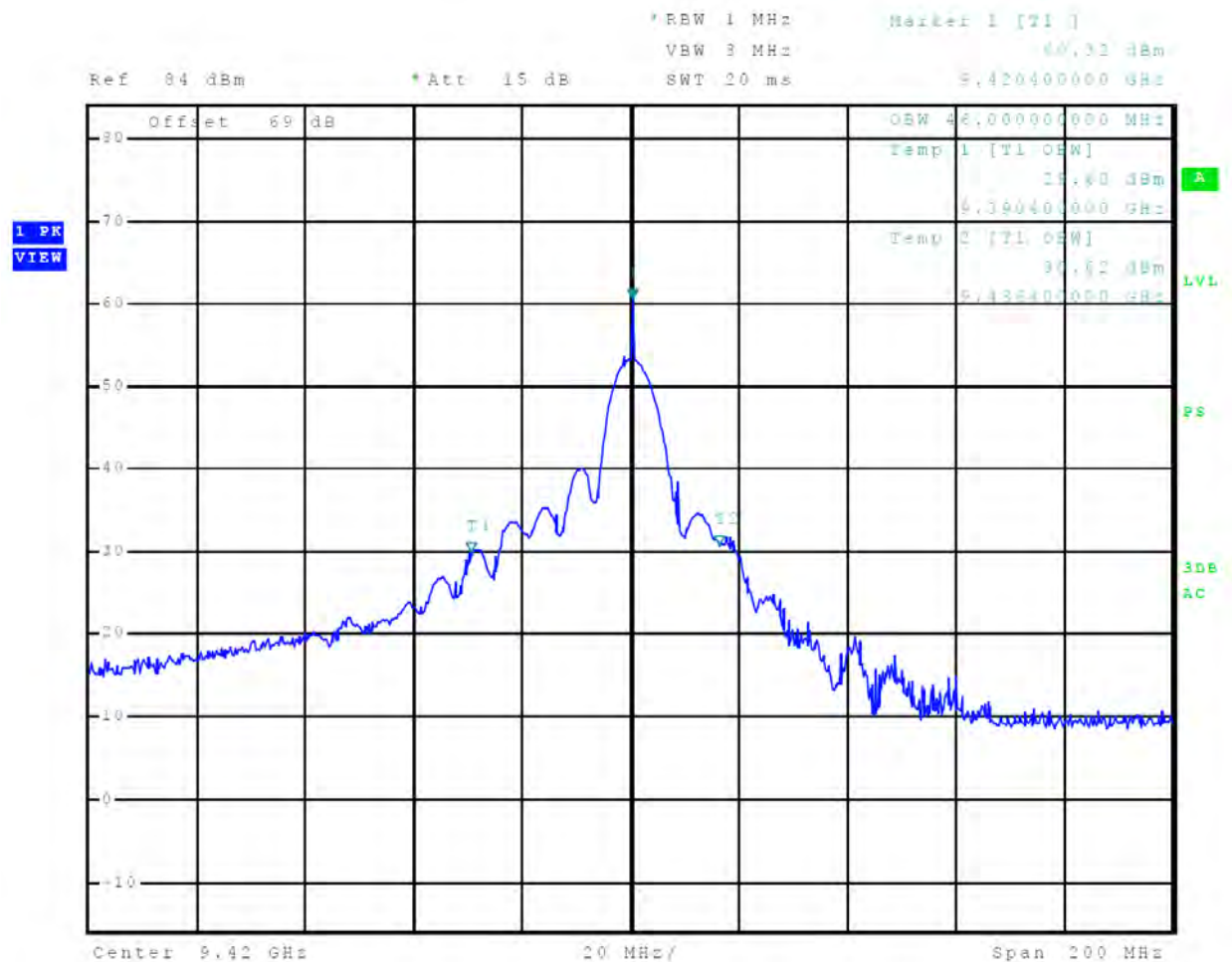

Figure 6 99% Occupied Bandwidth Plot, 3/4 nm

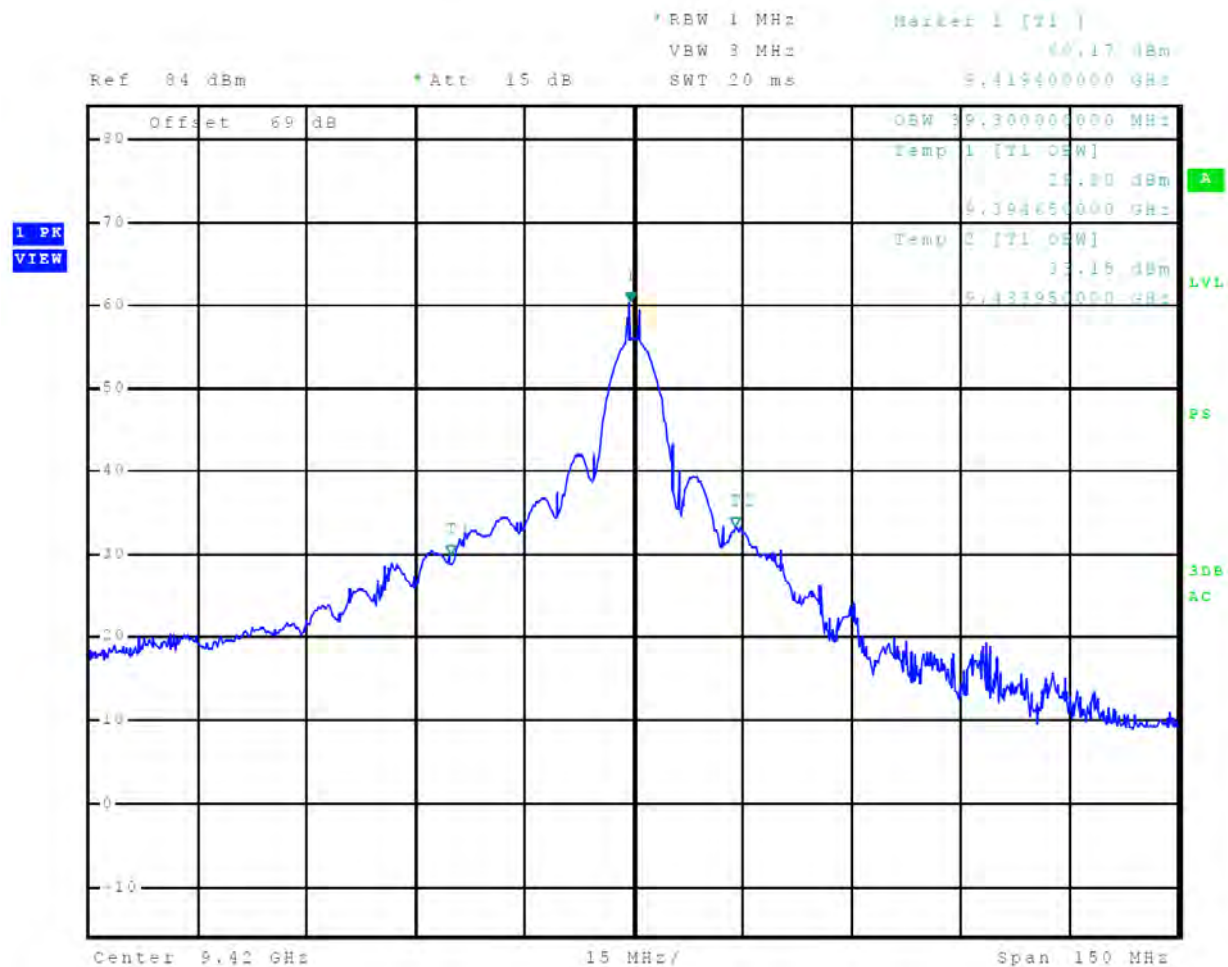

Figure 7 99% Occupied Bandwidth Plot, 1 nm

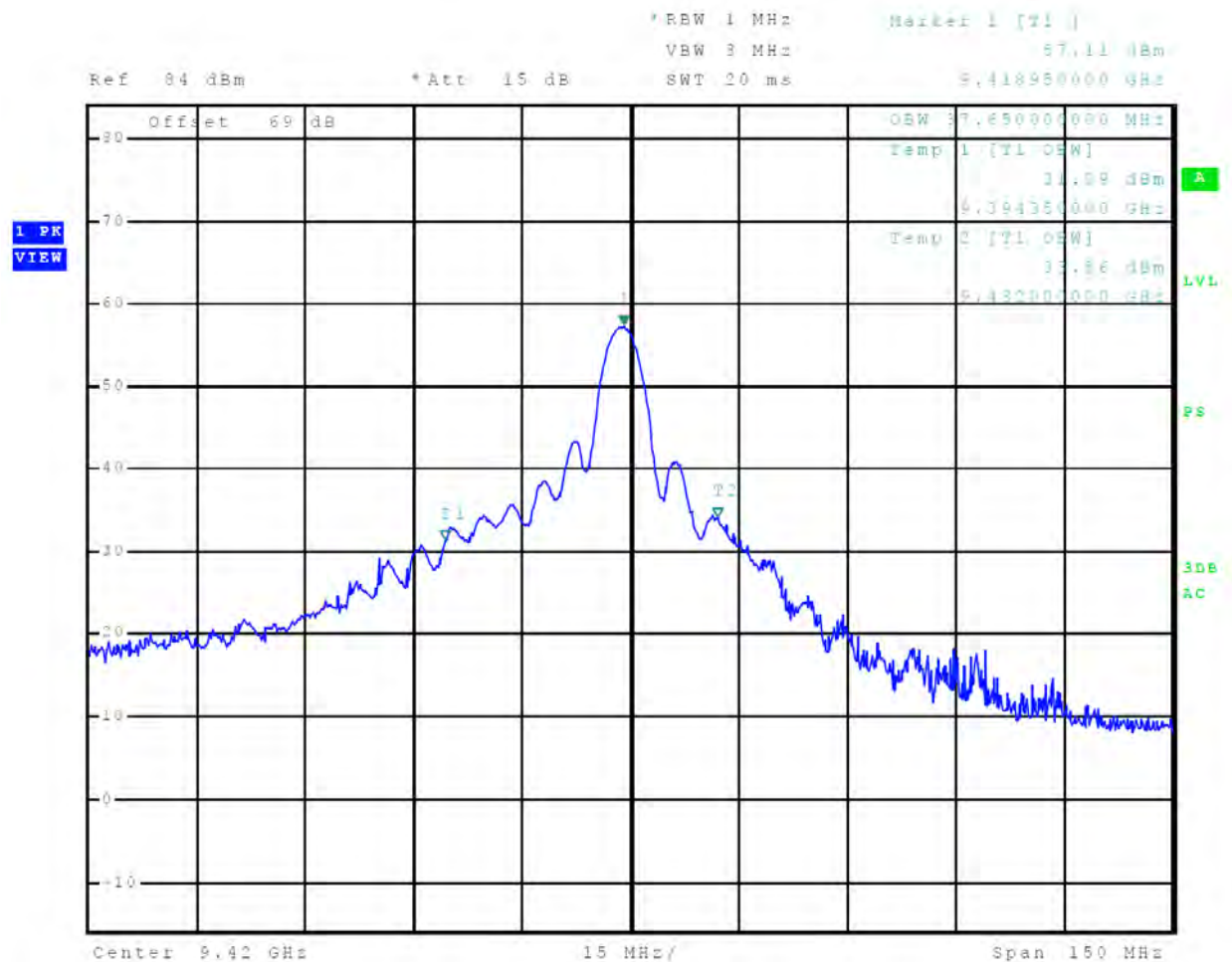



Figure 8 99% Occupied Bandwidth Plot, 1.5 nm

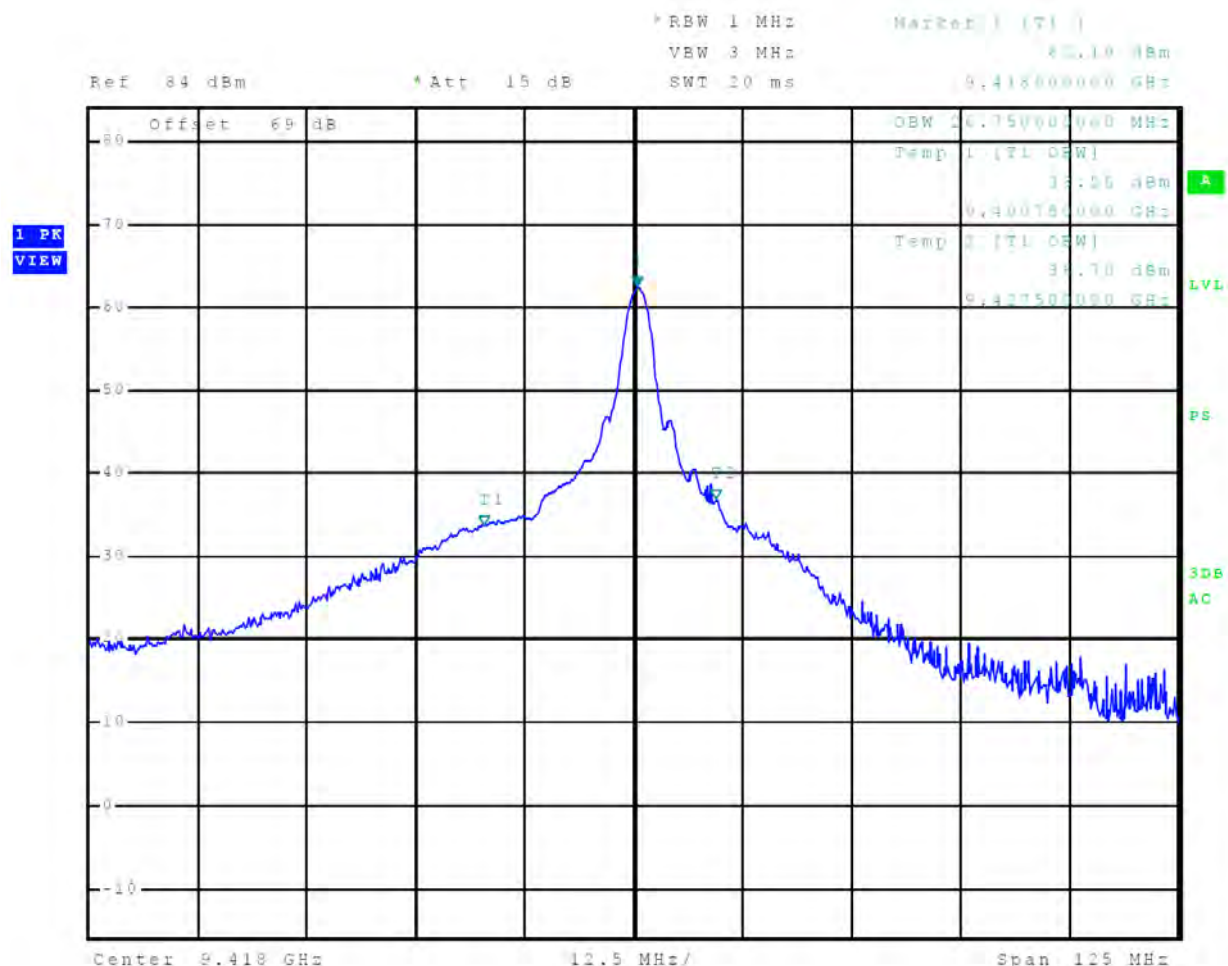

Figure 9 99% Occupied Bandwidth Plot, 2 nm

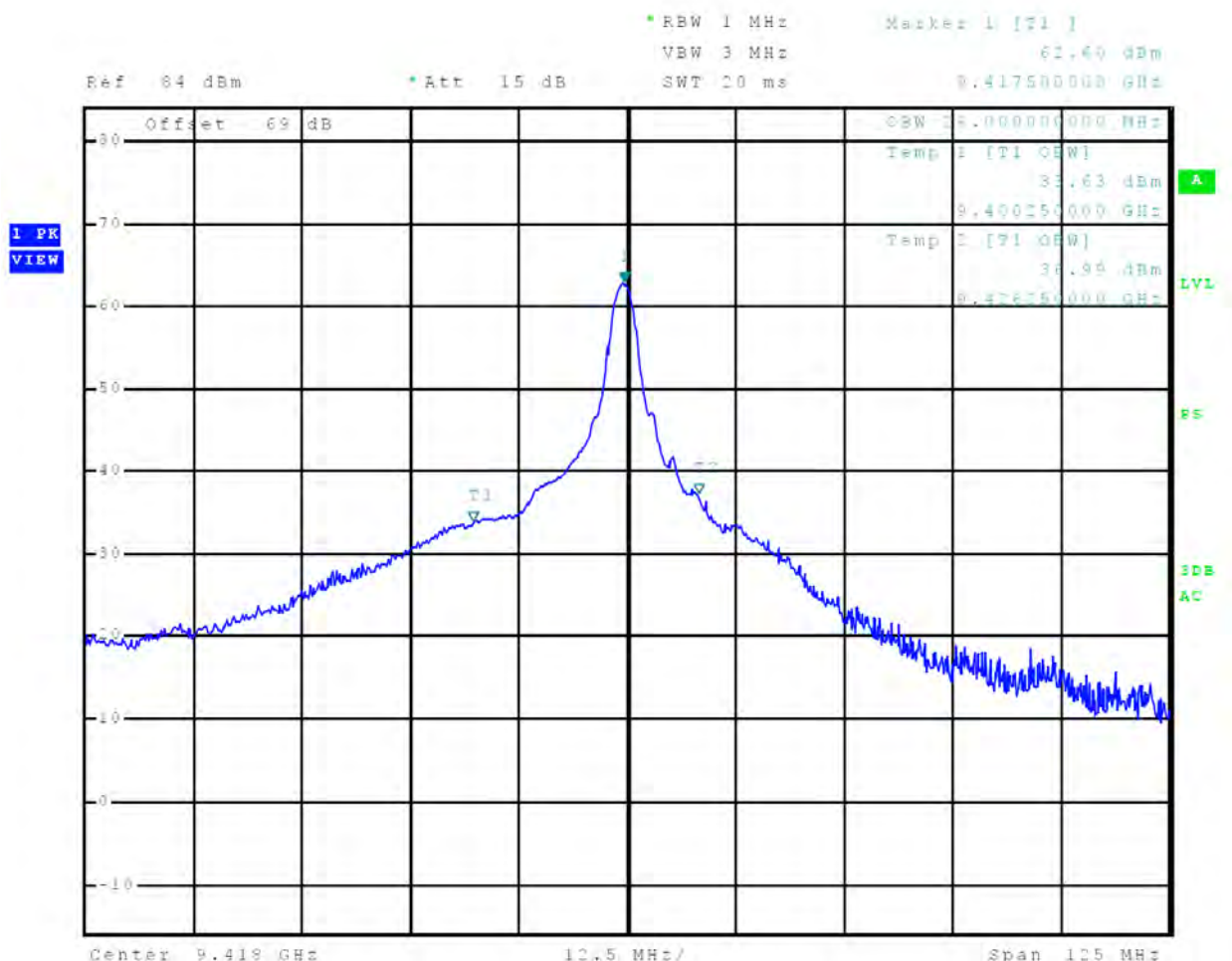



Figure 10 99% Occupied Bandwidth Plot, 3 nm

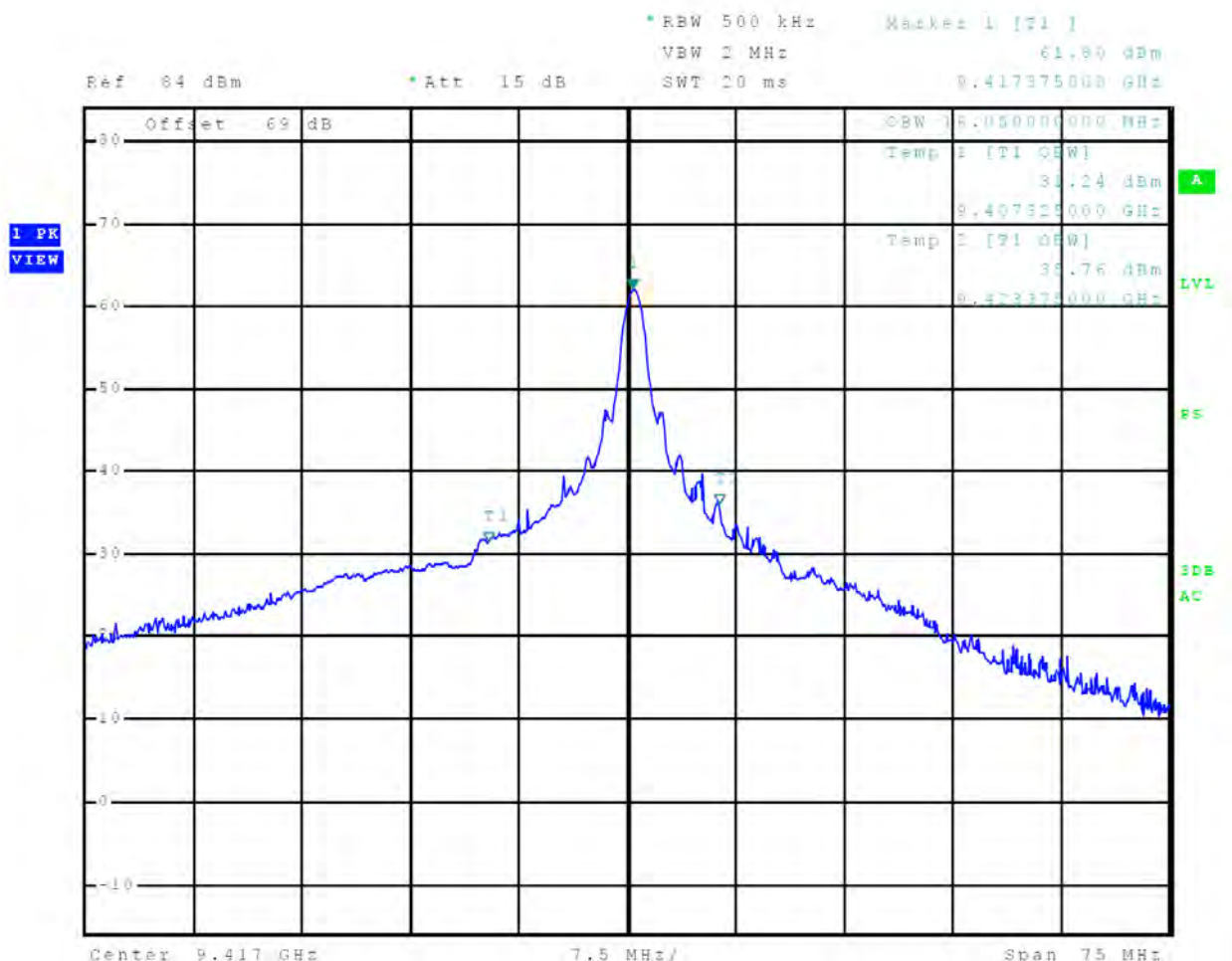

Figure 11 99% Occupied Bandwidth Plot, 4 nm

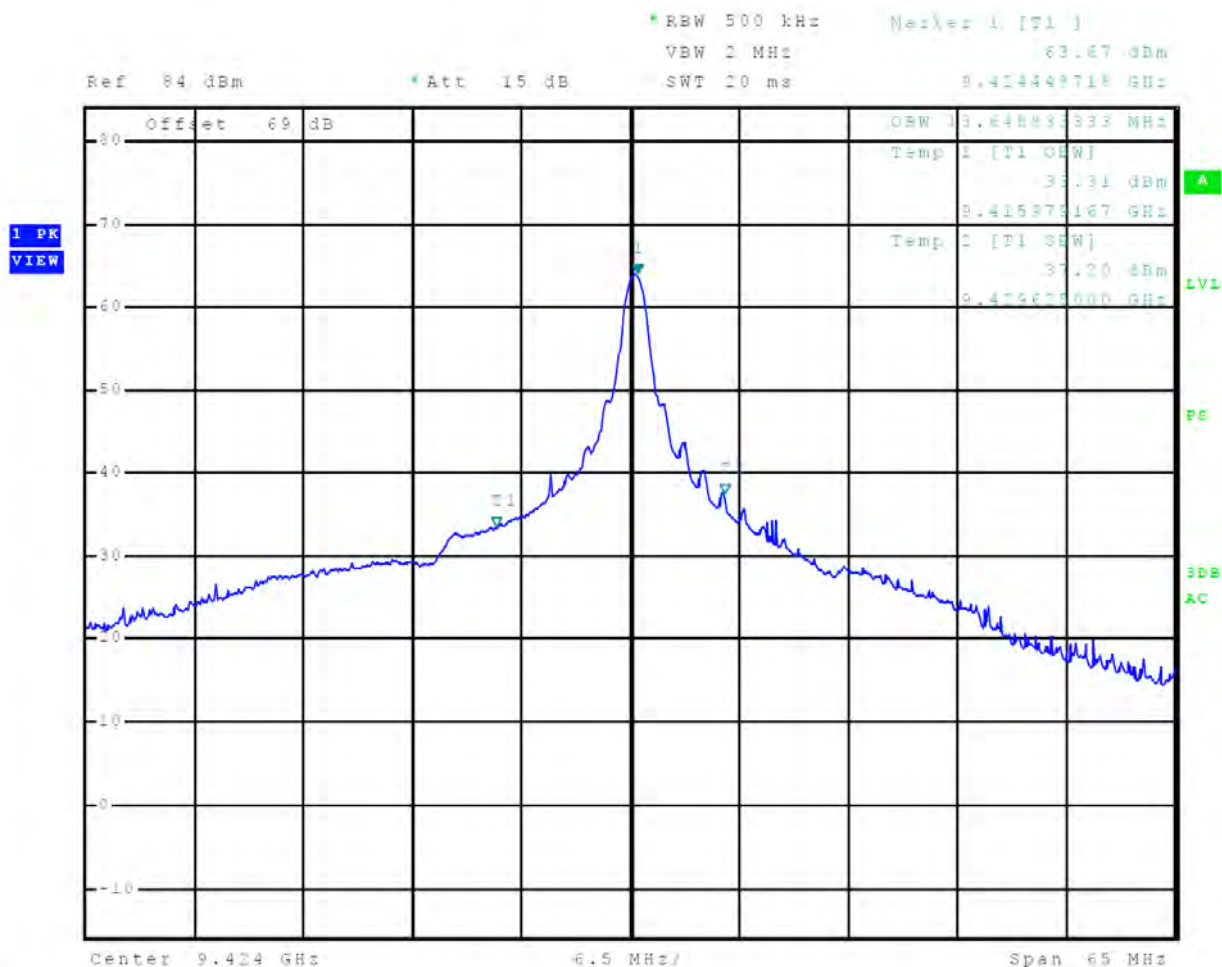

Figure 12 99% Occupied Bandwidth Plot, 6 nm

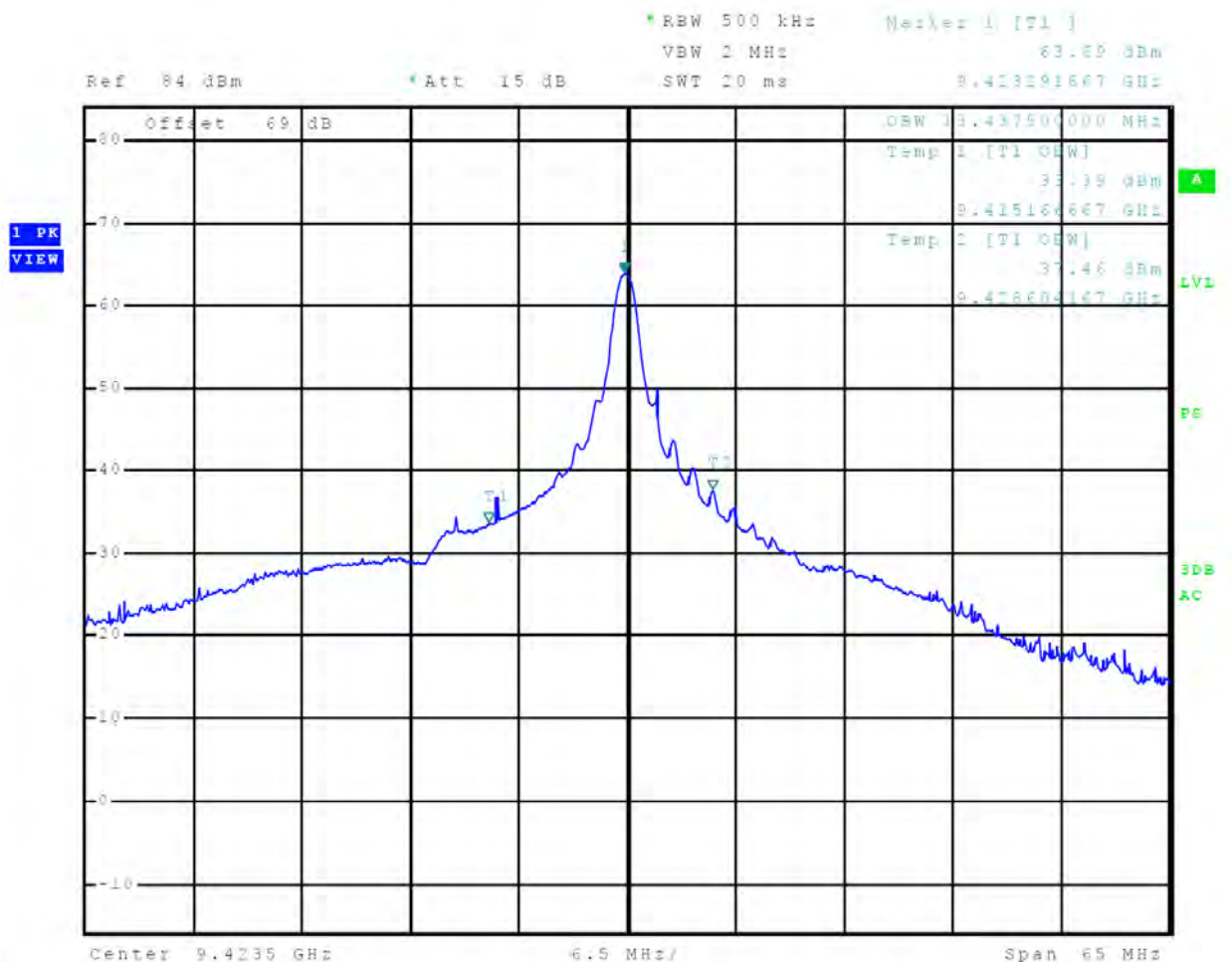

Figure 13 99% Occupied Bandwidth Plot, 8 nm

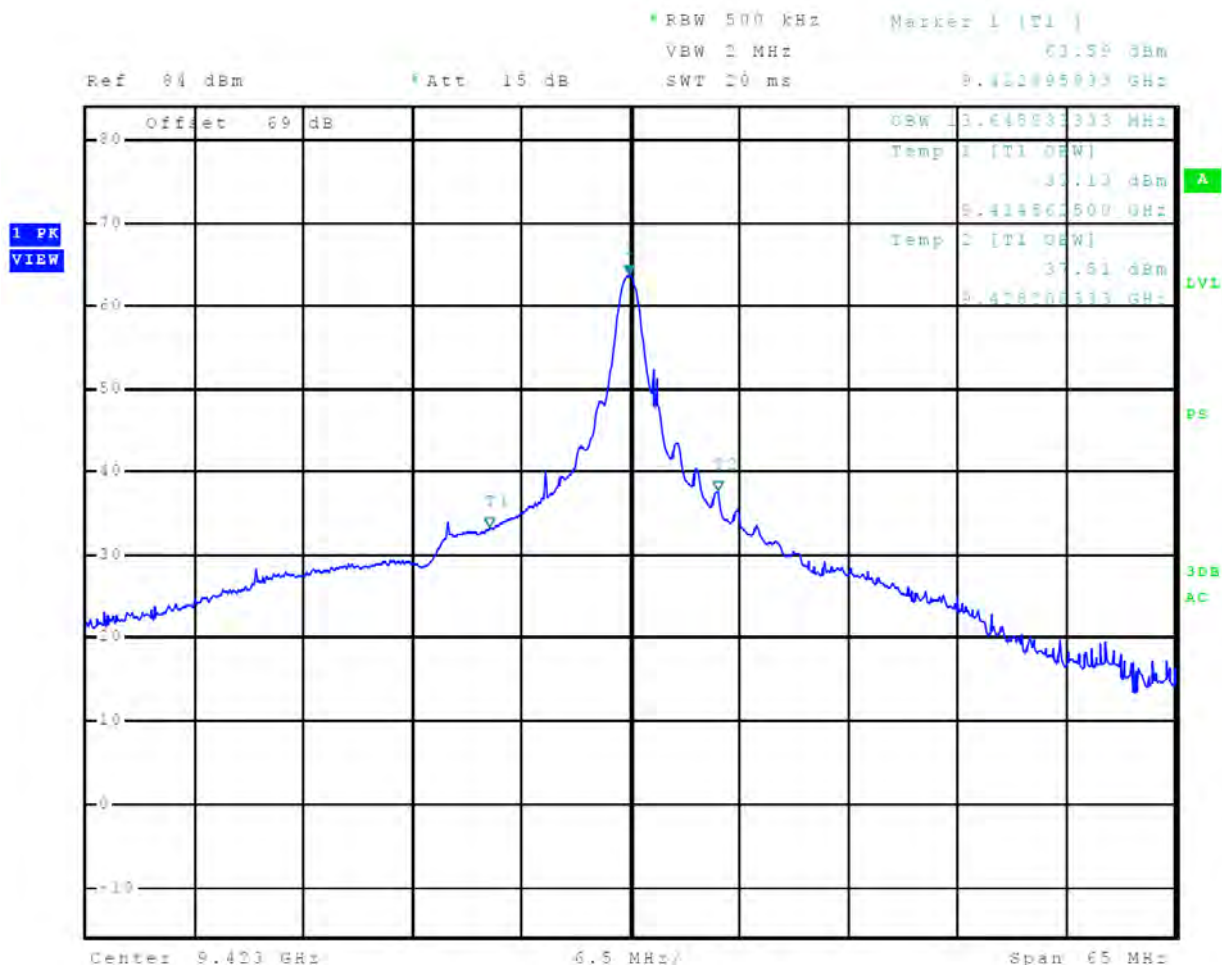

Figure 14 99% Occupied Bandwidth Plot, 12 nm

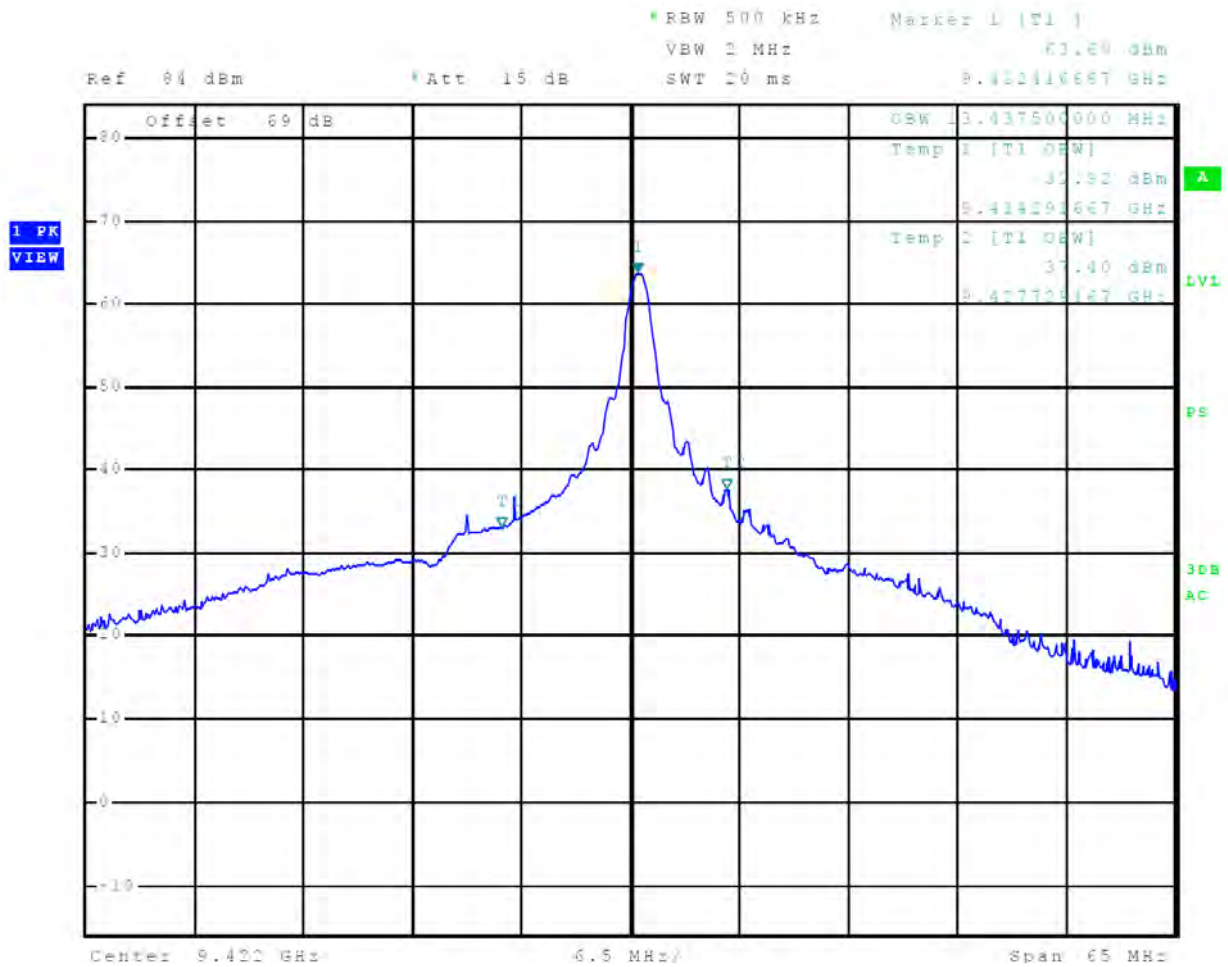

Figure 15 99% Occupied Bandwidth Plot, 18 nm

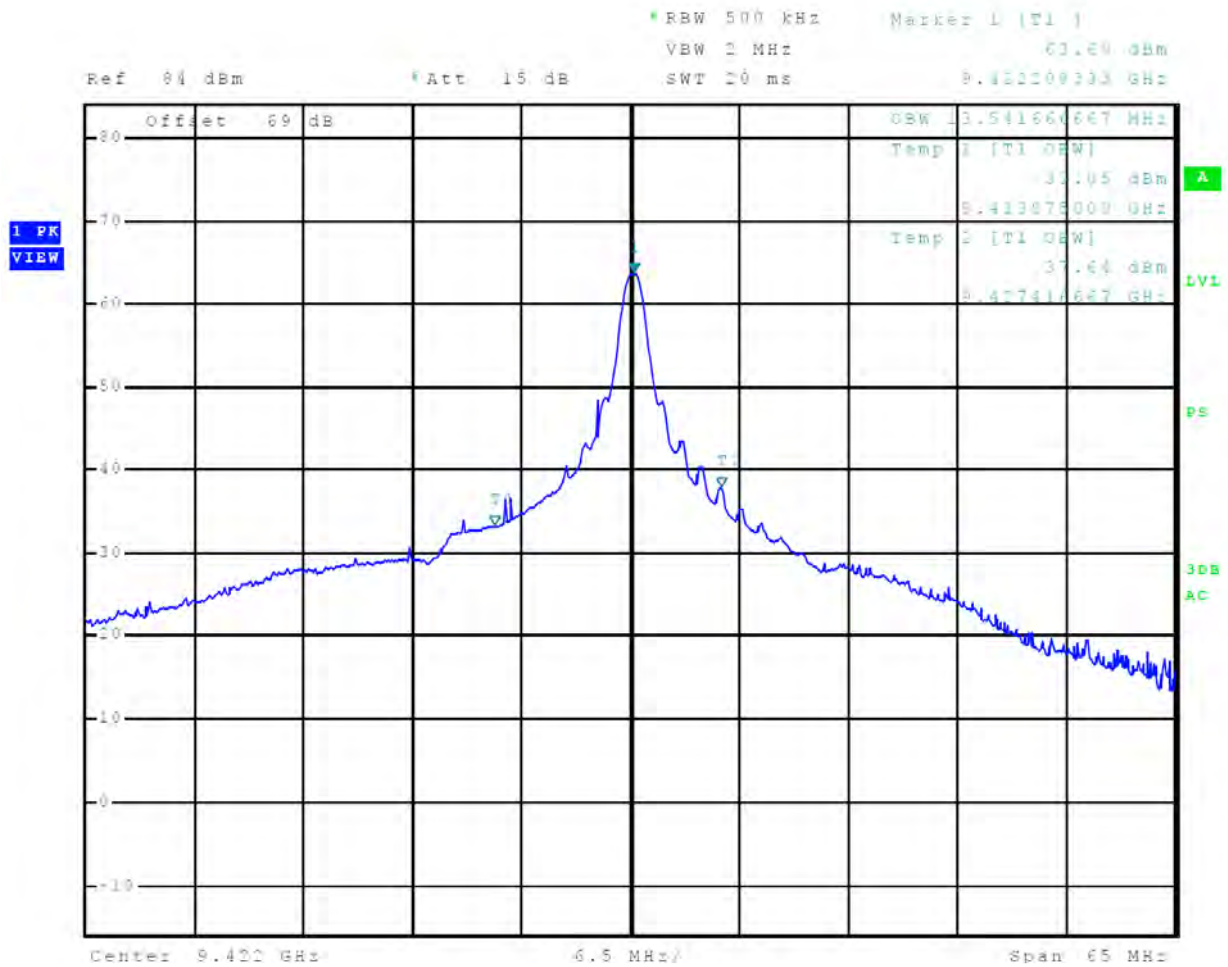



Figure 16 99% Occupied Bandwidth Plot, 24 nm

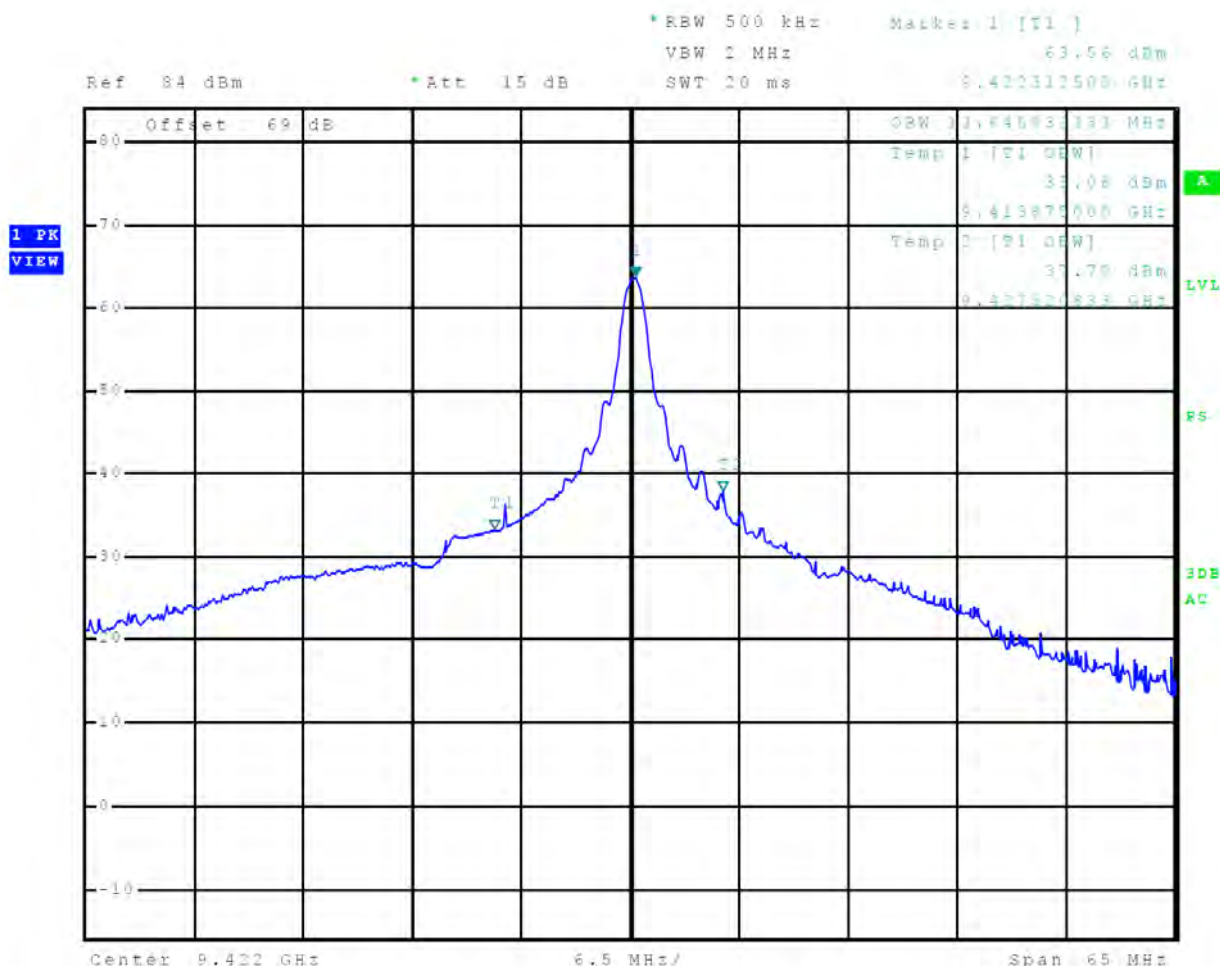

Figure 17 99% Occupied Bandwidth Plot, 36 nm

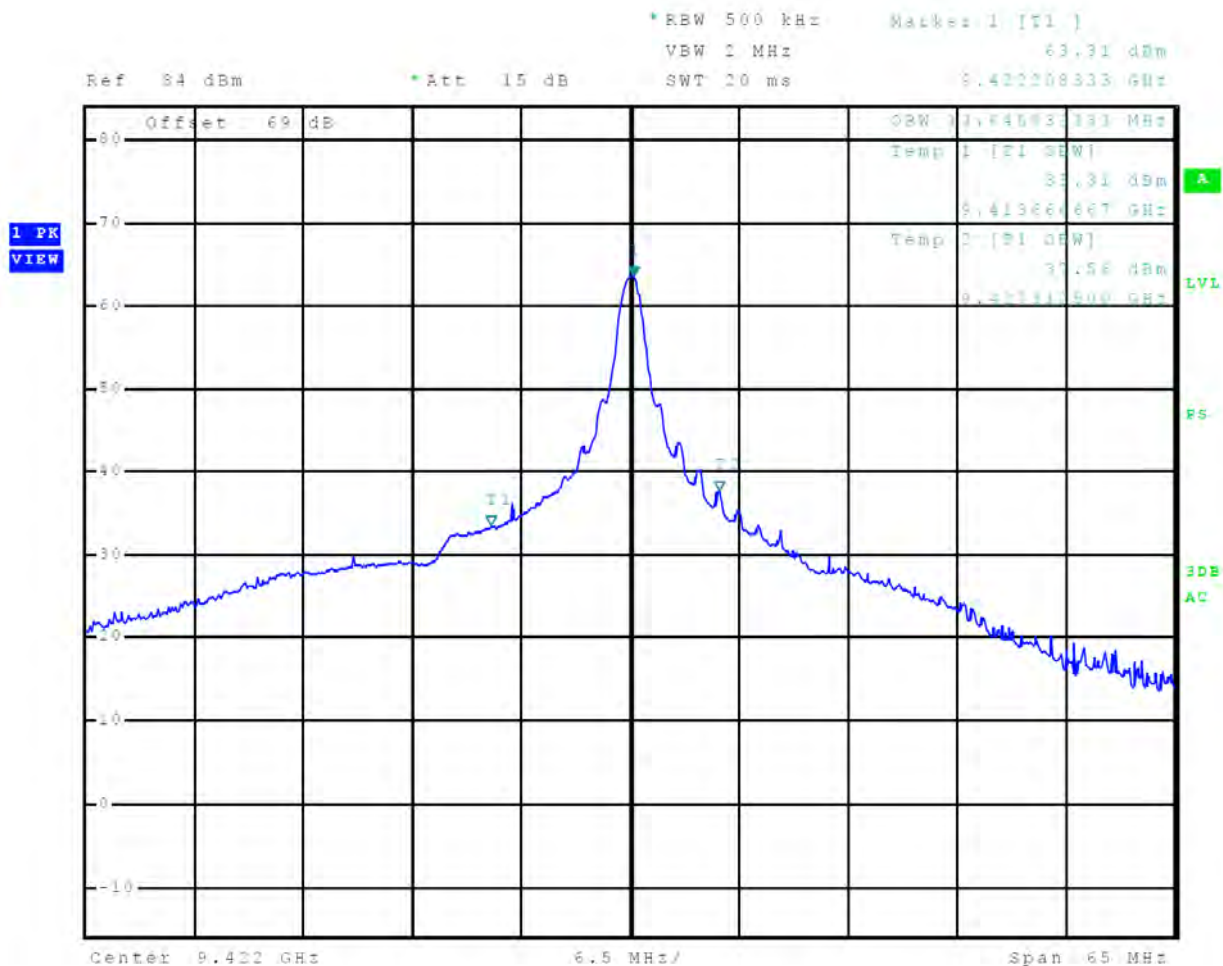



Figure 18 99% Occupied Bandwidth Plot, 48 nm

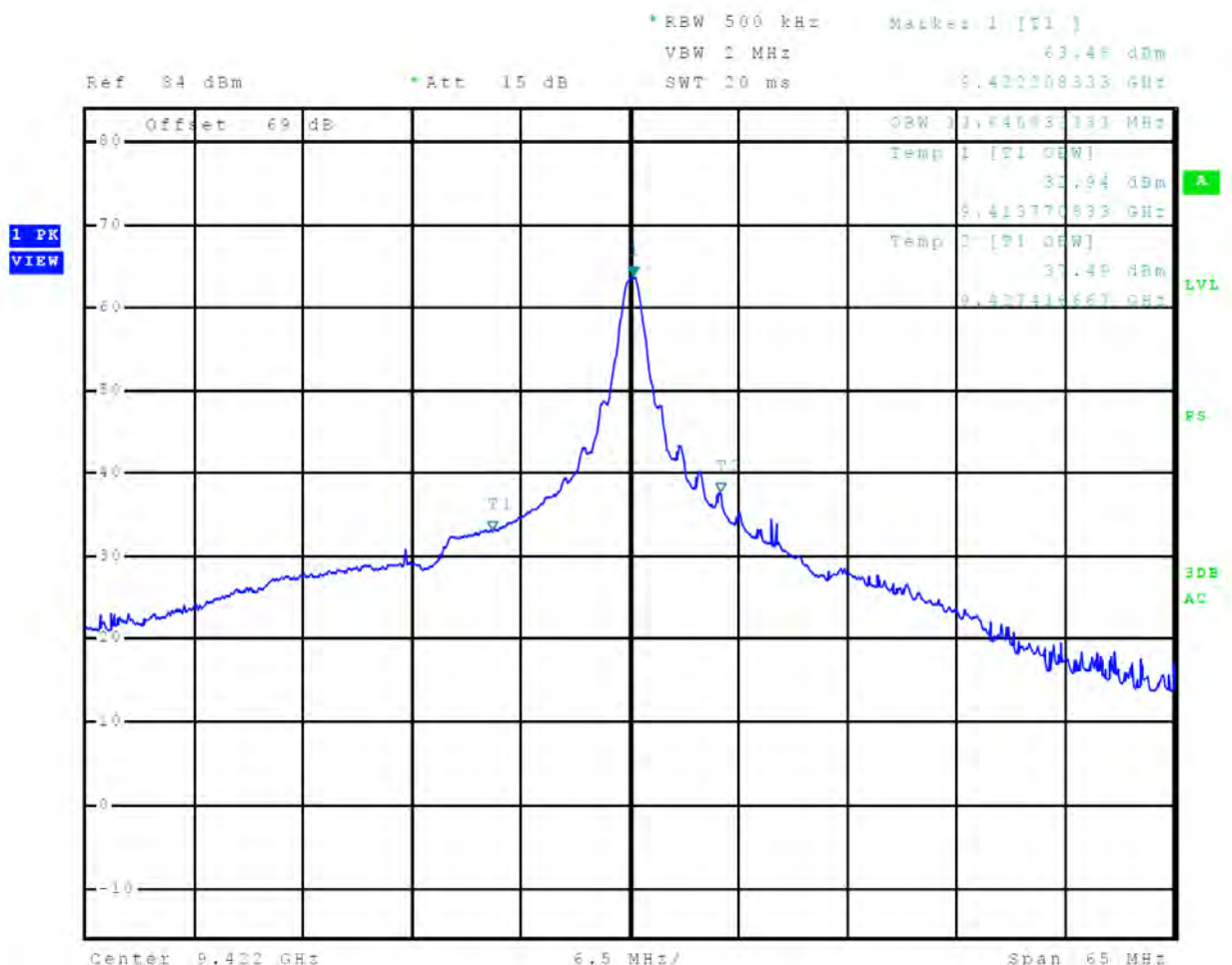

Figure 19 99% Occupied Bandwidth Plot, 64 nm

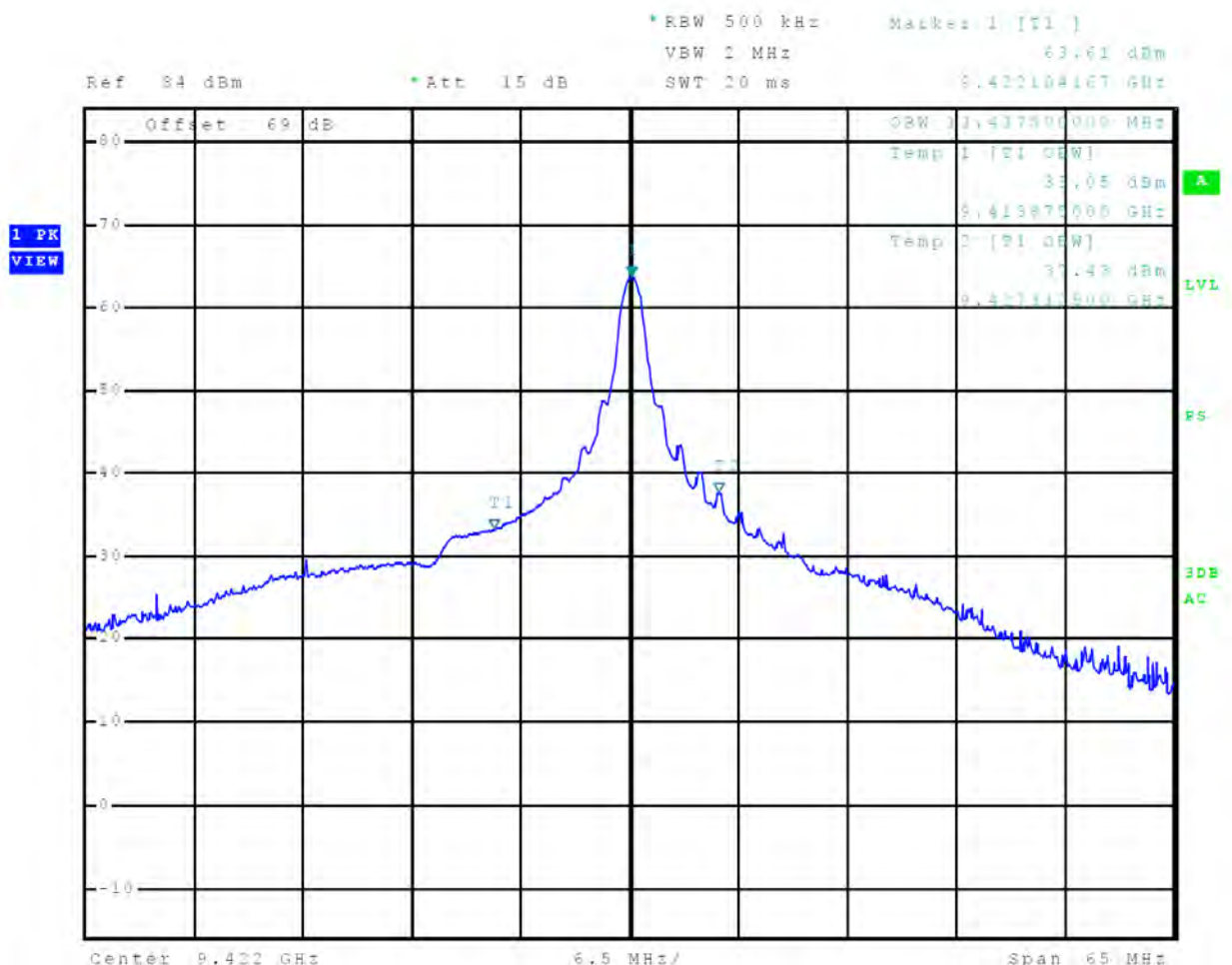

Figure 20 99% Occupied Bandwidth Plot, 72 nm

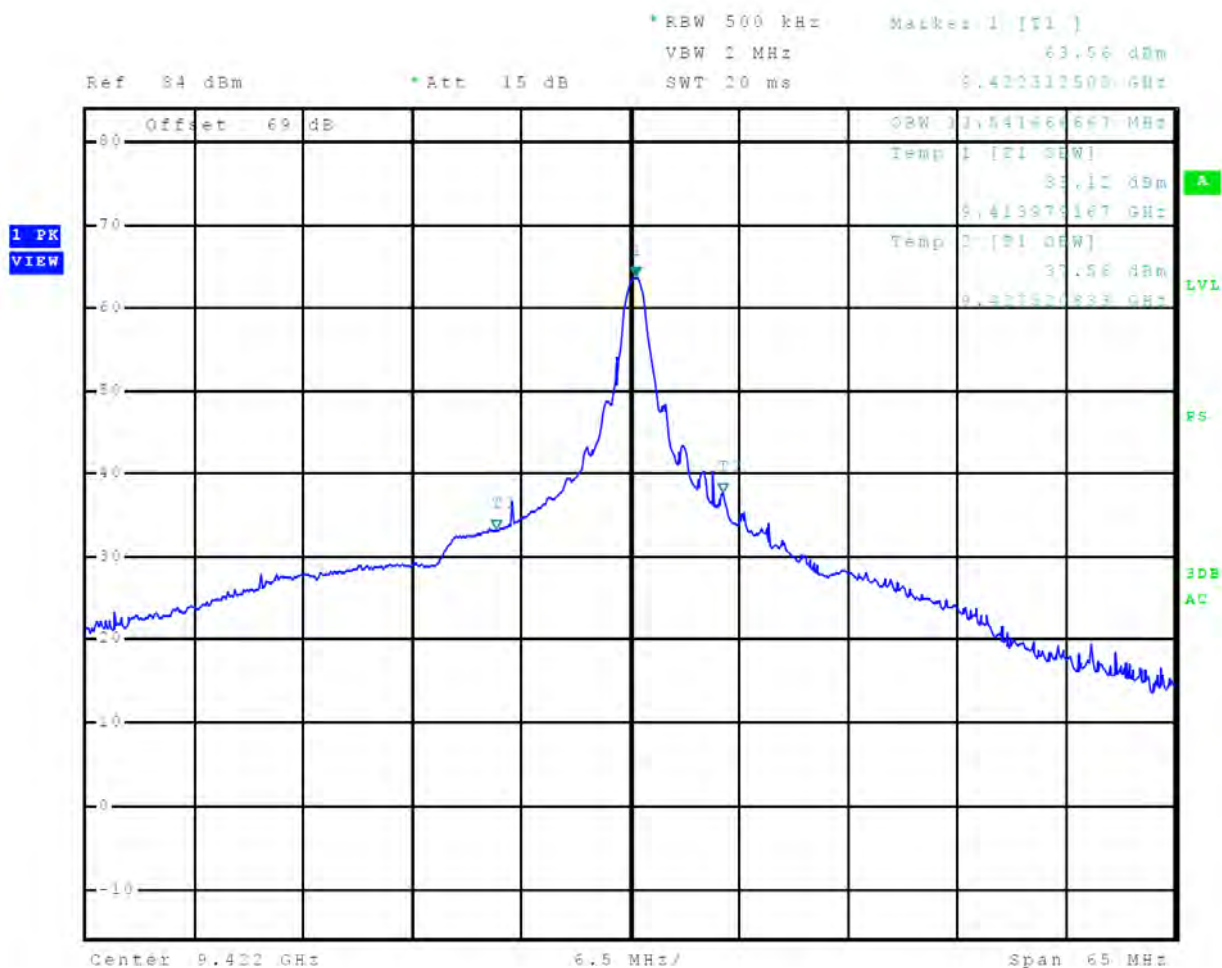

Figure 21 99% Occupied Bandwidth Plot, 96 nm

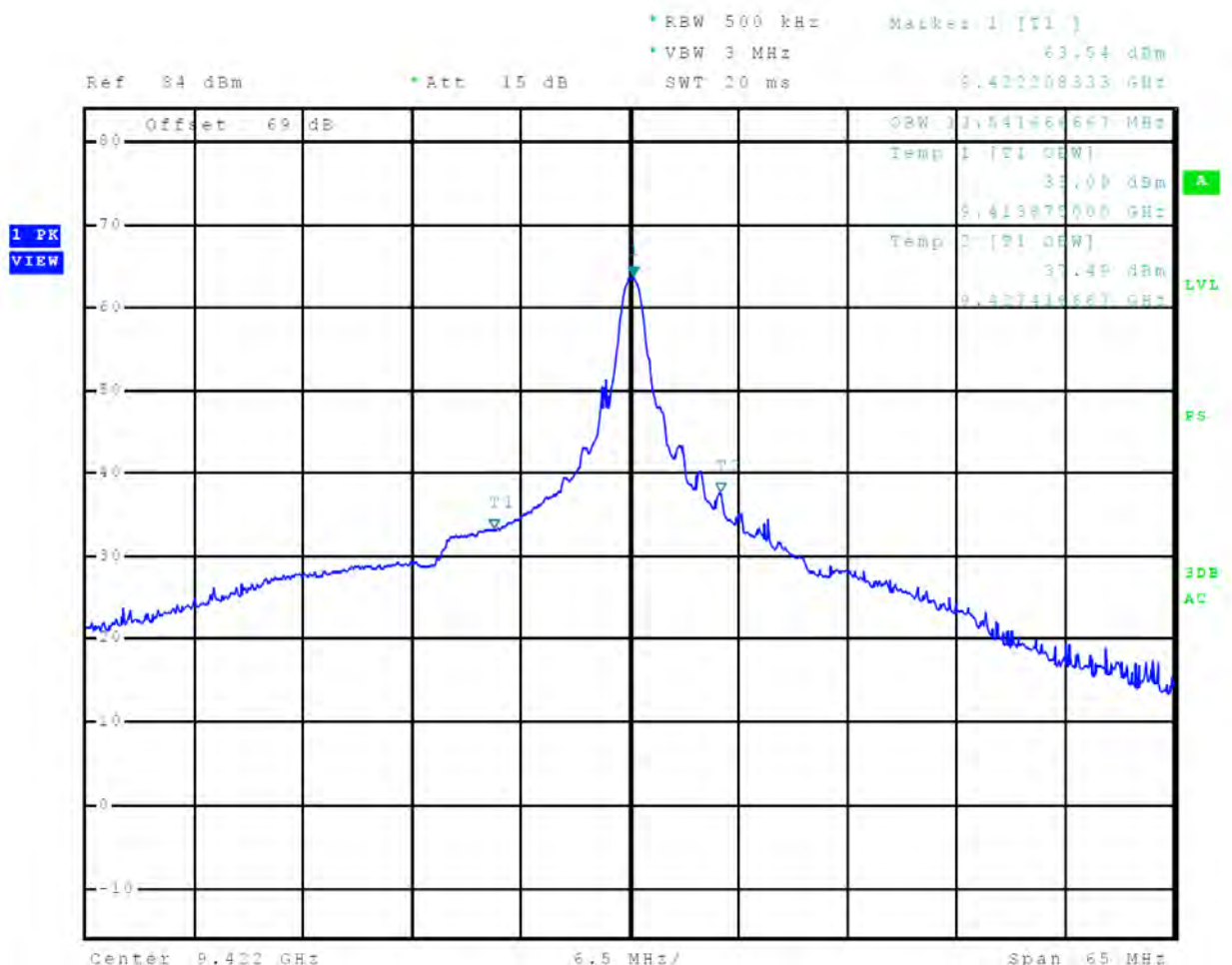

Figure 22 40-dB Occupied Bandwidth Plot, 1/16 nm

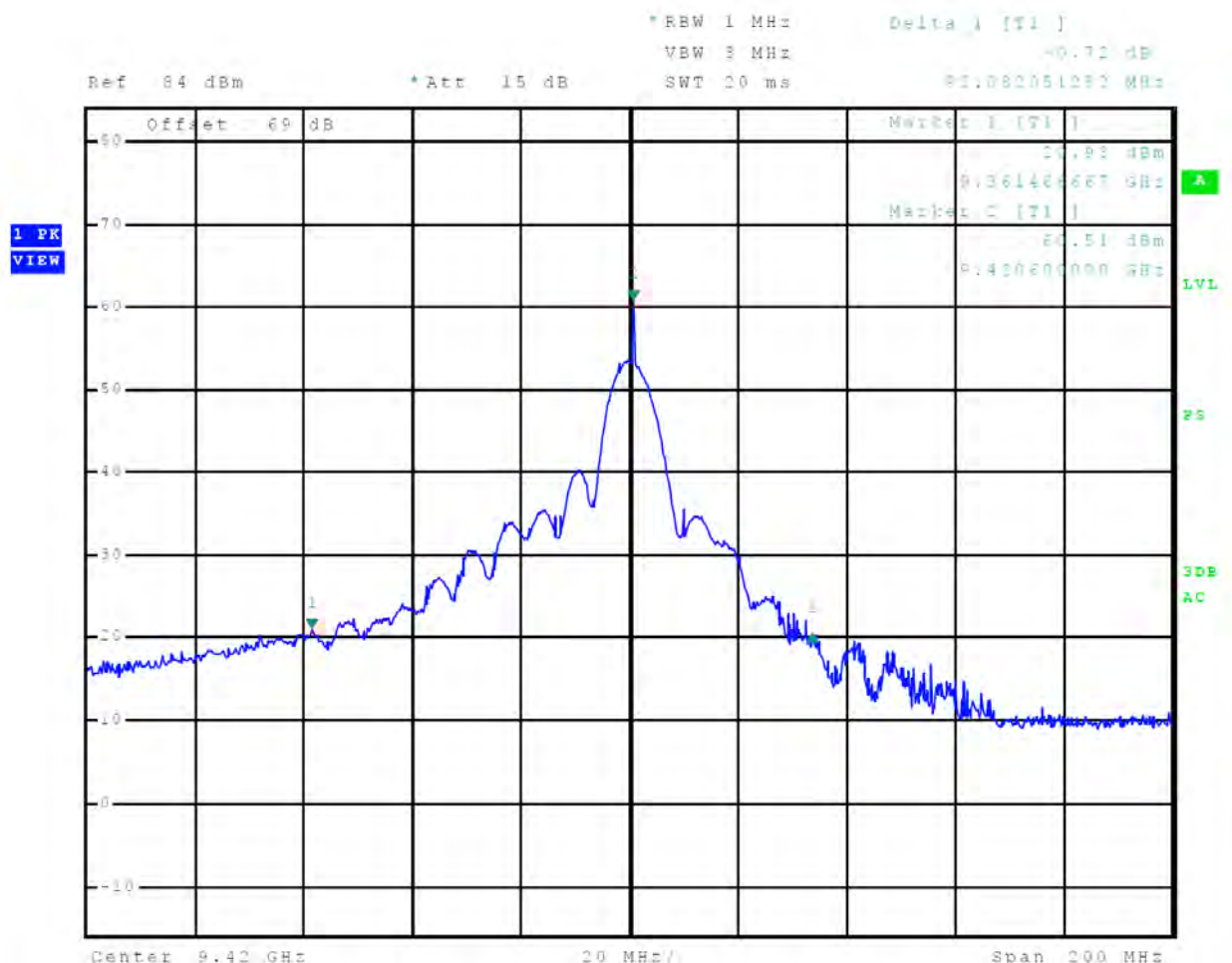

Figure 23 40-dB Occupied Bandwidth Plot, 1/8 nm

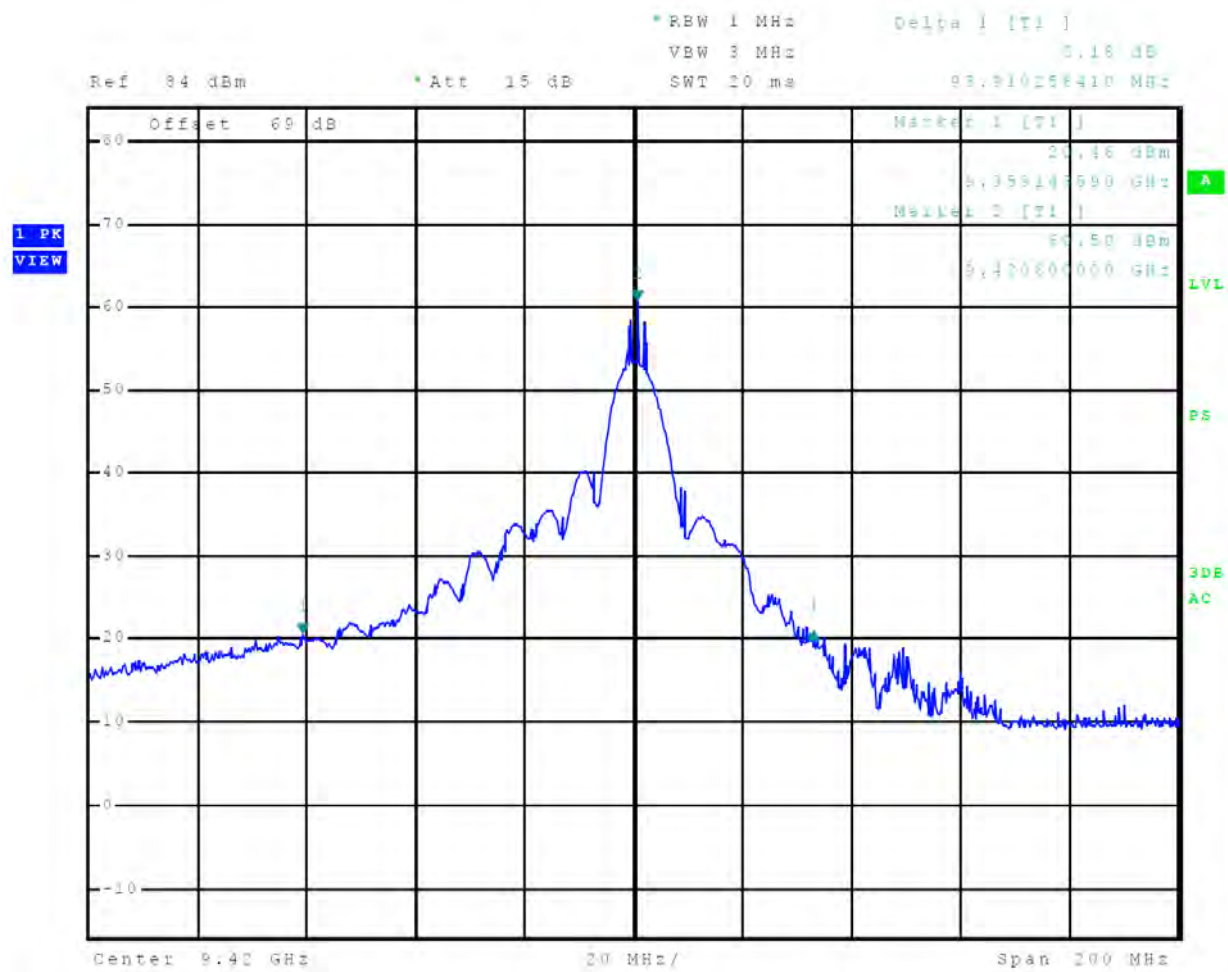



Figure 24 40-dB Occupied Bandwidth Plot, 1/4 nm

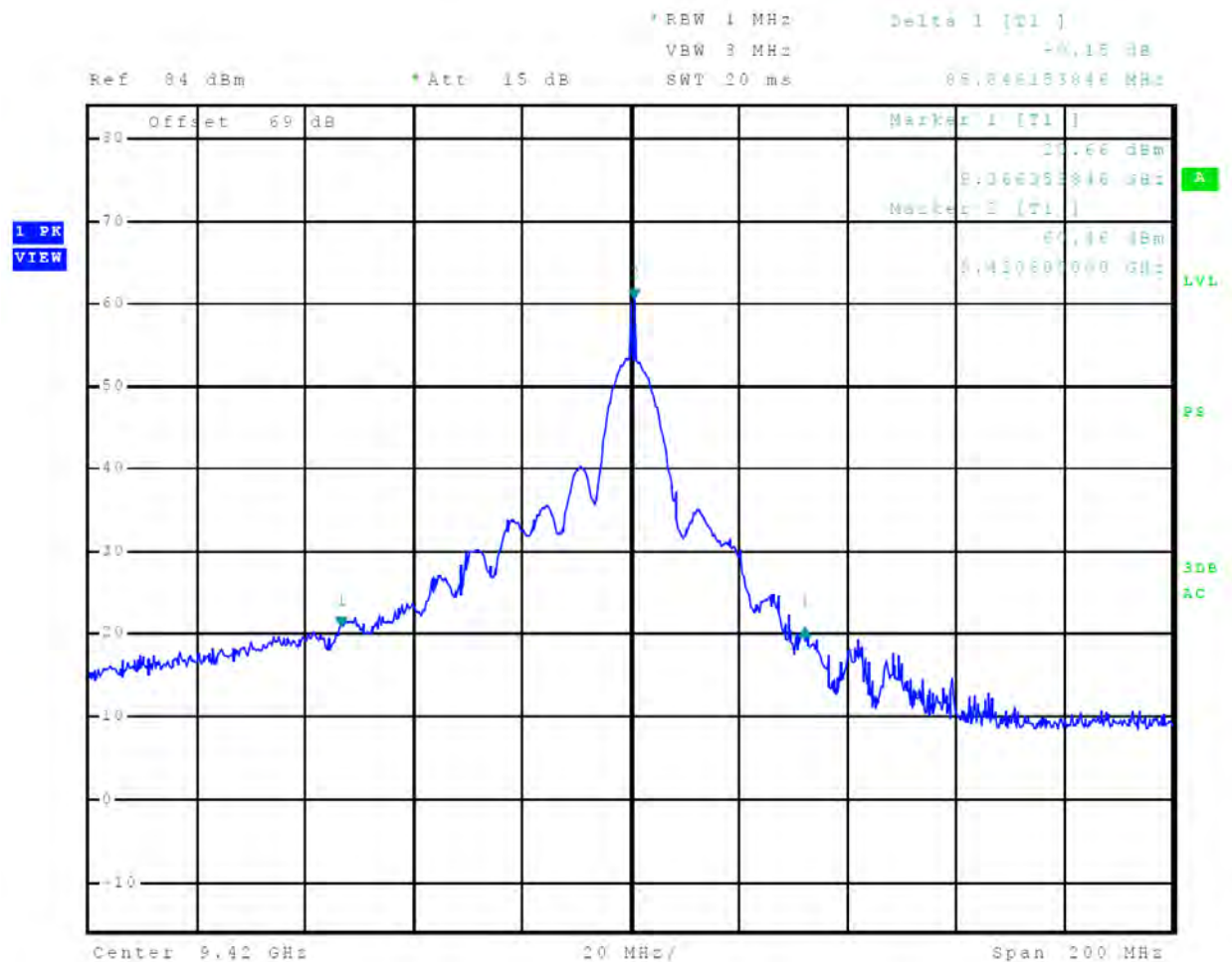

Figure 25 40-dB Occupied Bandwidth Plot, 1/2 nm

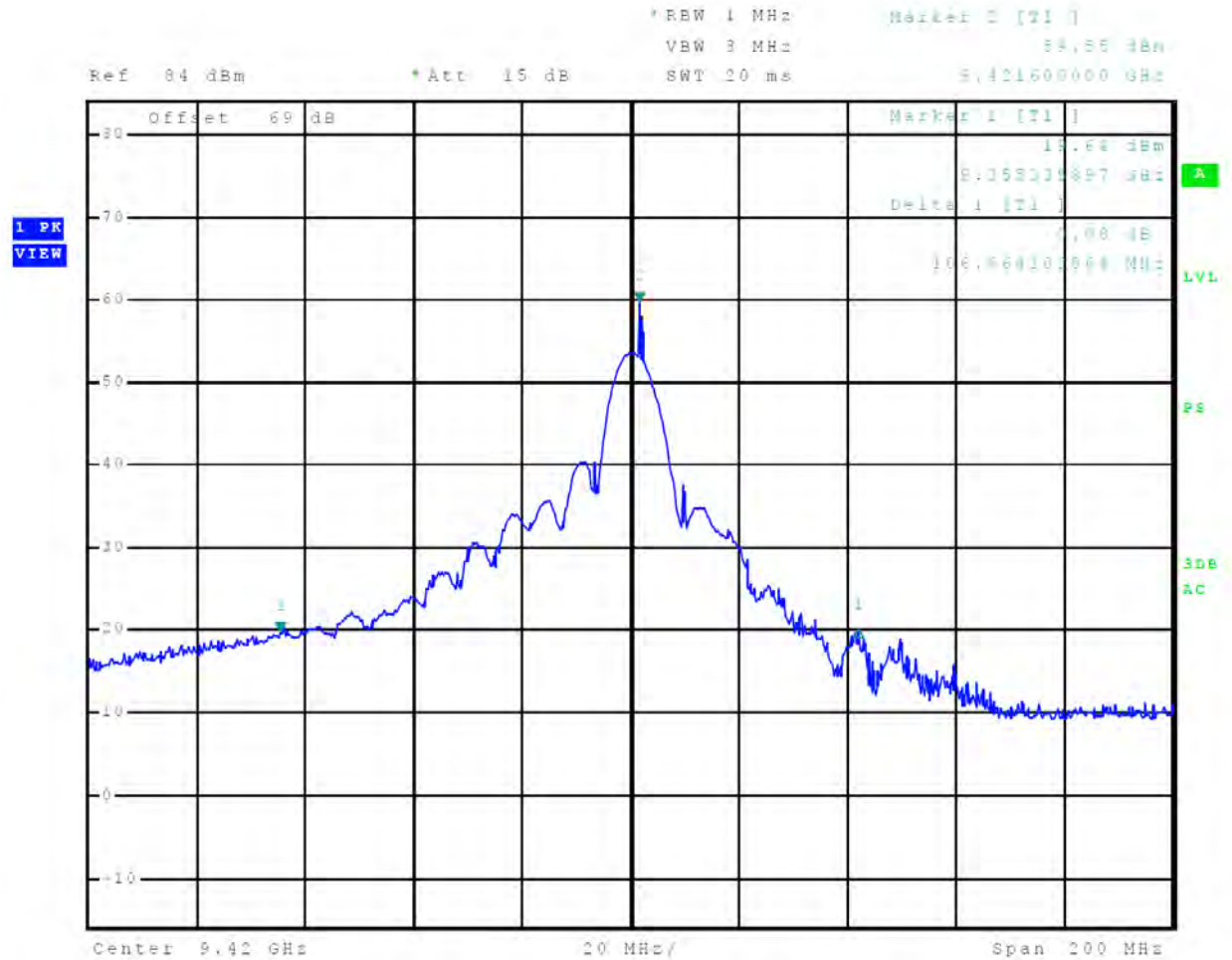



Figure 26 40-dB Occupied Bandwidth Plot, 3/4 nm

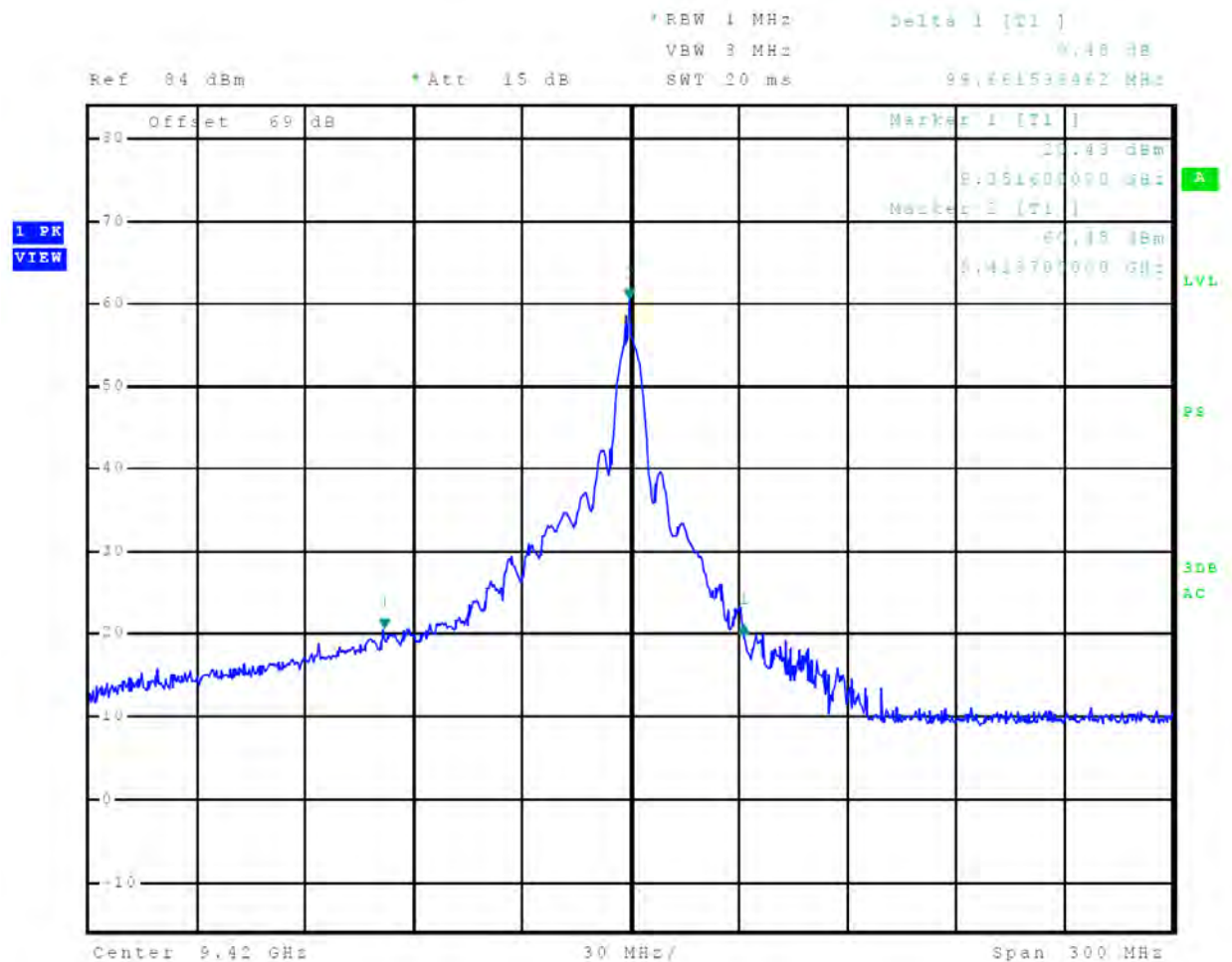

Figure 27 40-dB Occupied Bandwidth Plot, 1 nm

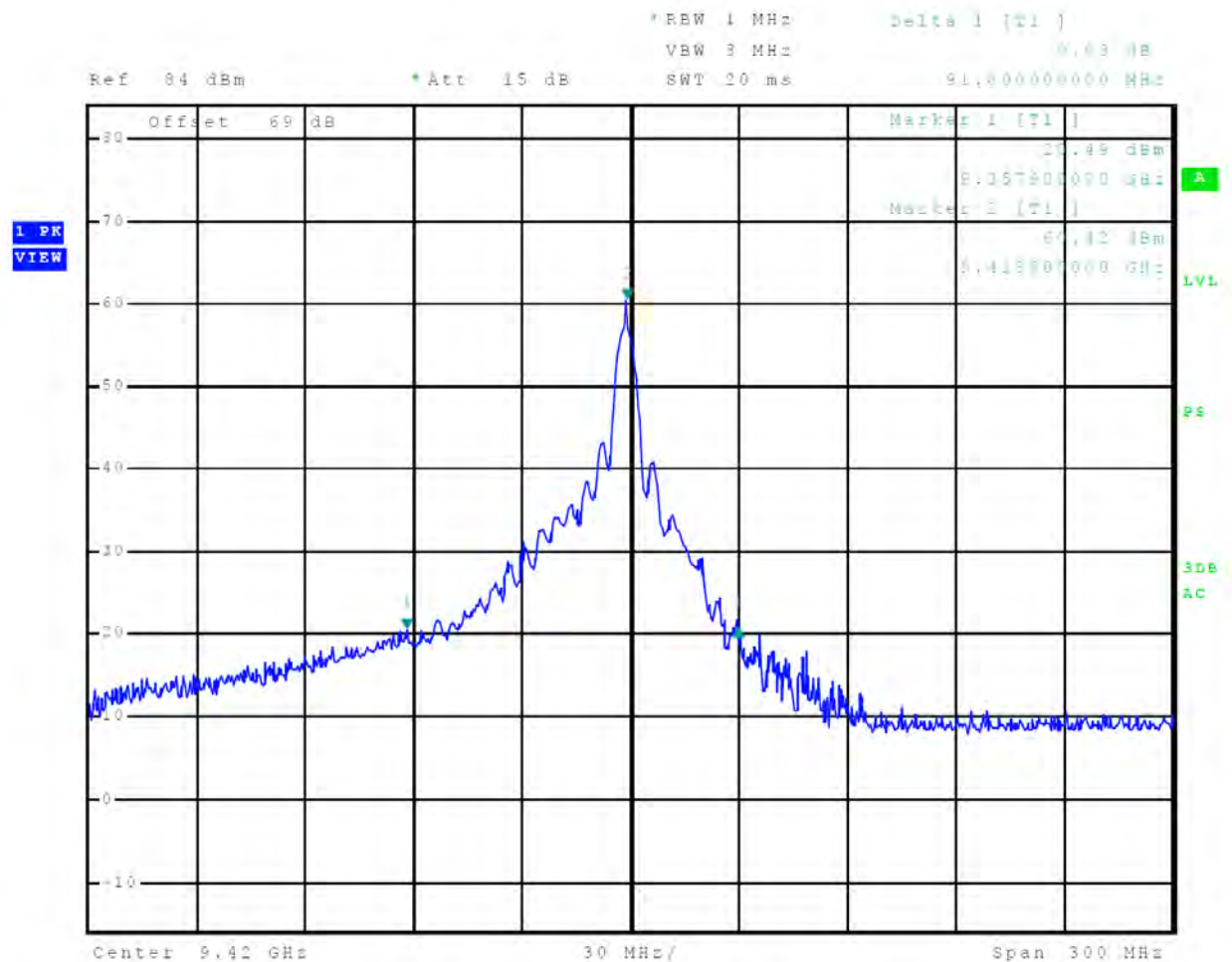

Figure 28 40-dB Occupied Bandwidth Plot, 1.5 nm

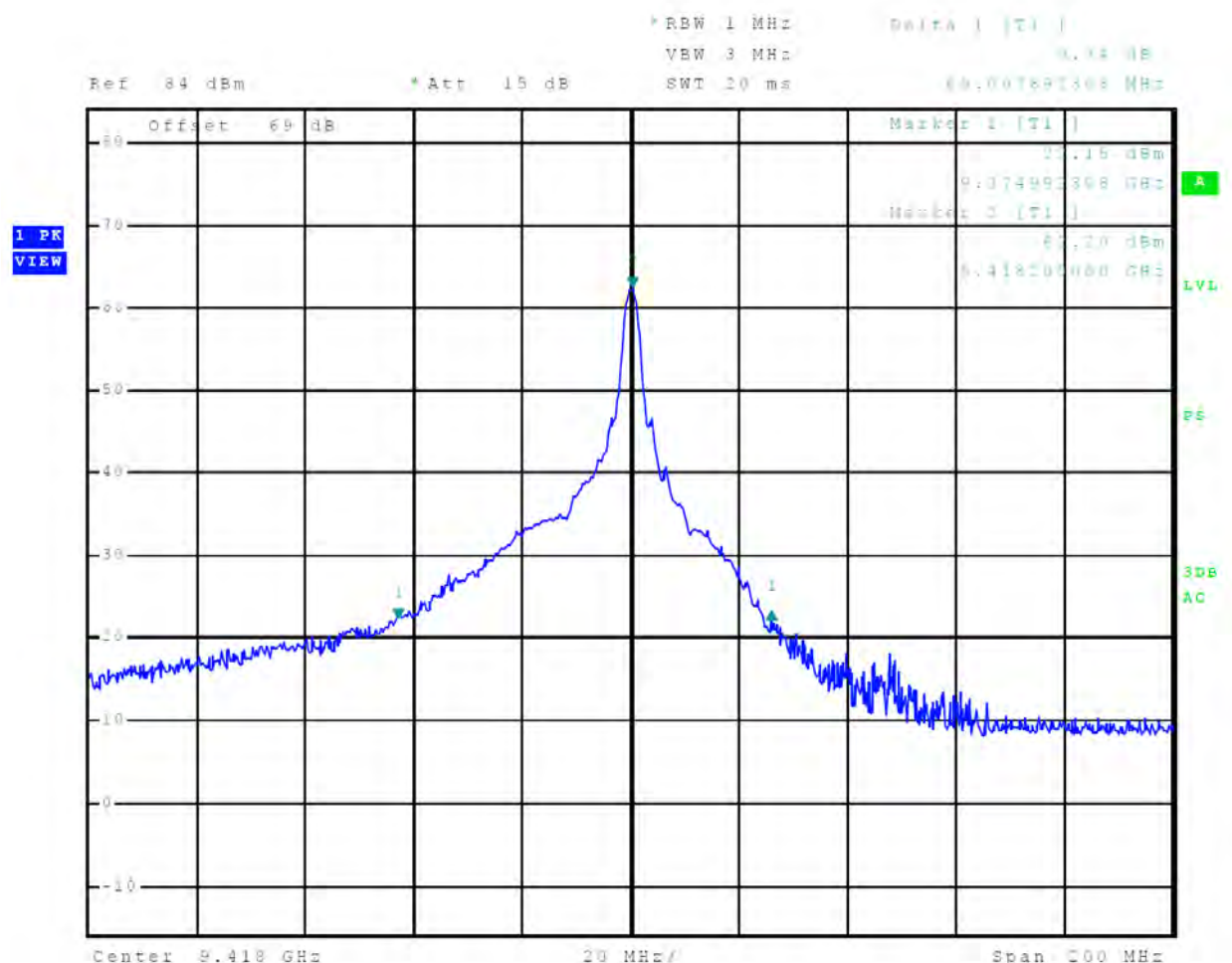

Figure 29 40-dB Occupied Bandwidth Plot, 2 nm

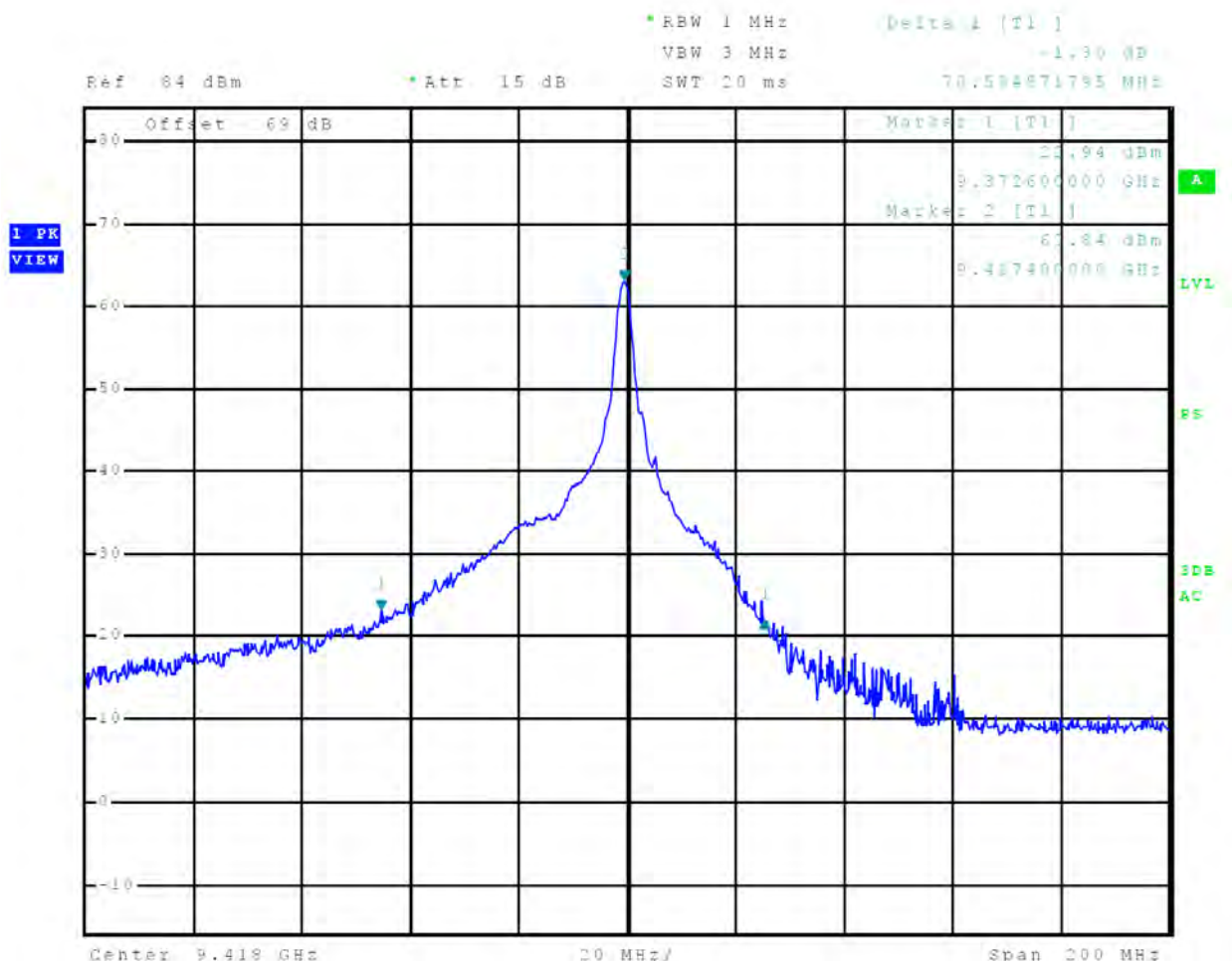

Figure 30 40-dB Occupied Bandwidth Plot, 3 nm

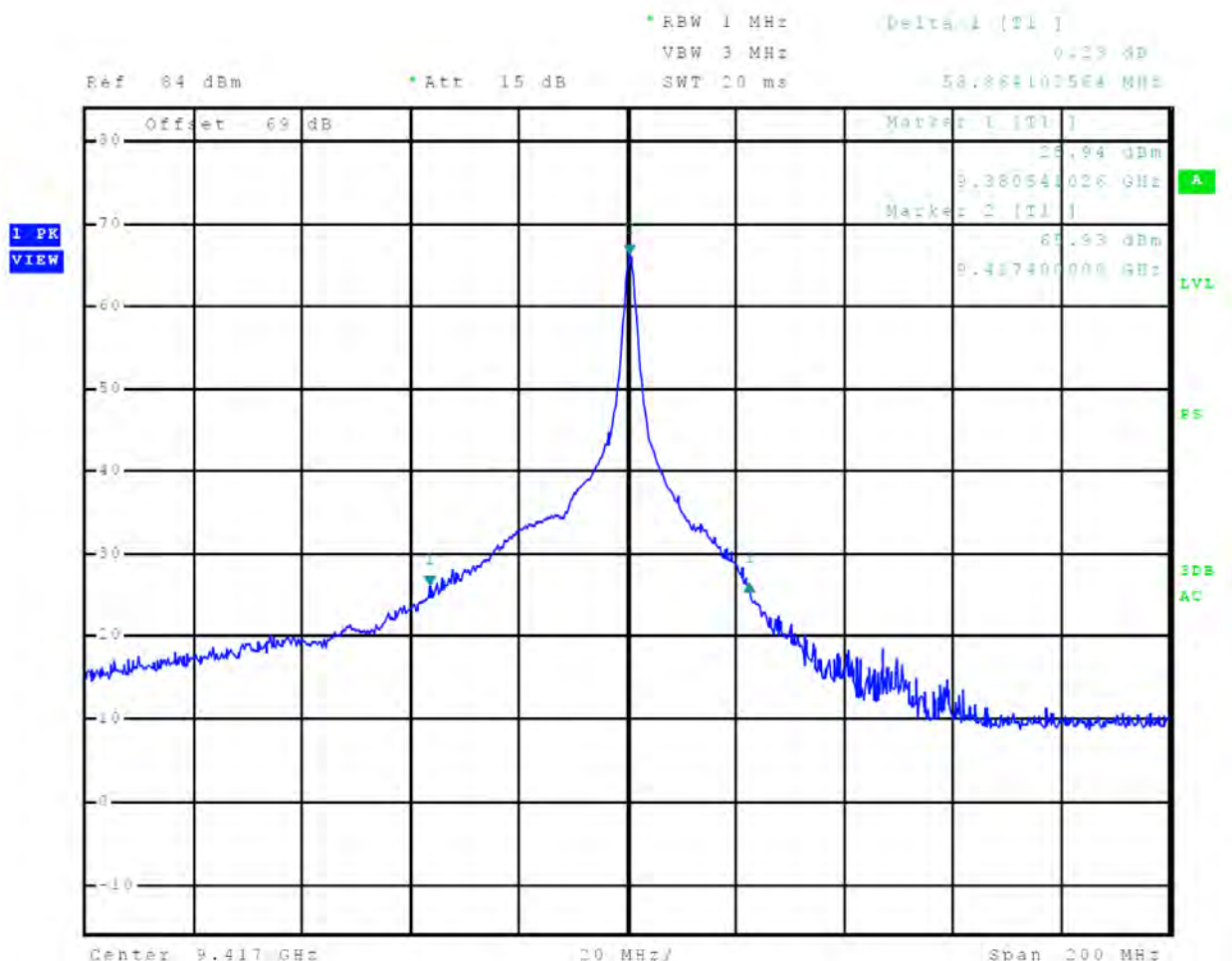

Figure 31 40-dB Occupied Bandwidth Plot, 4 nm

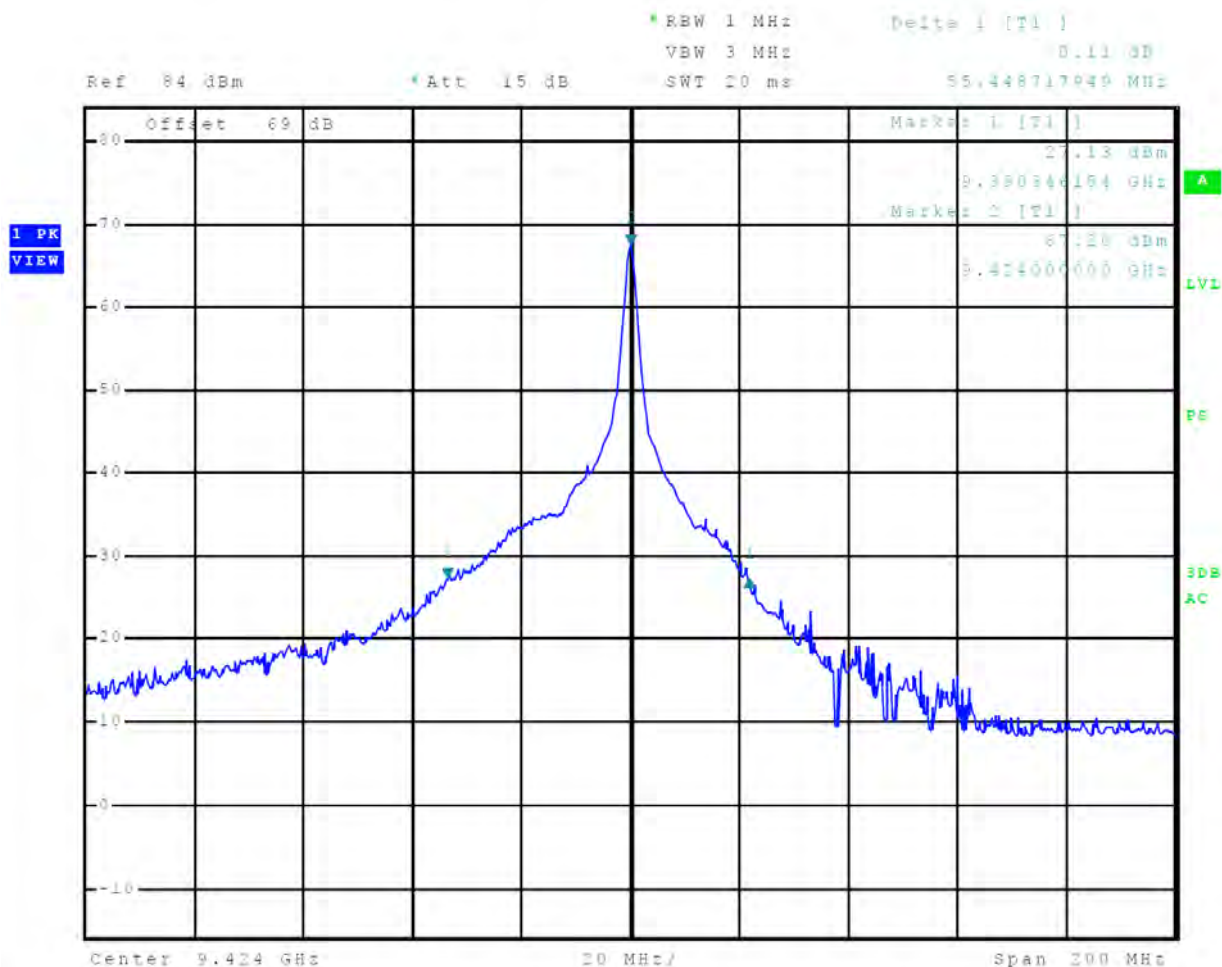



Figure 32 40-dB Occupied Bandwidth Plot, 6 nm

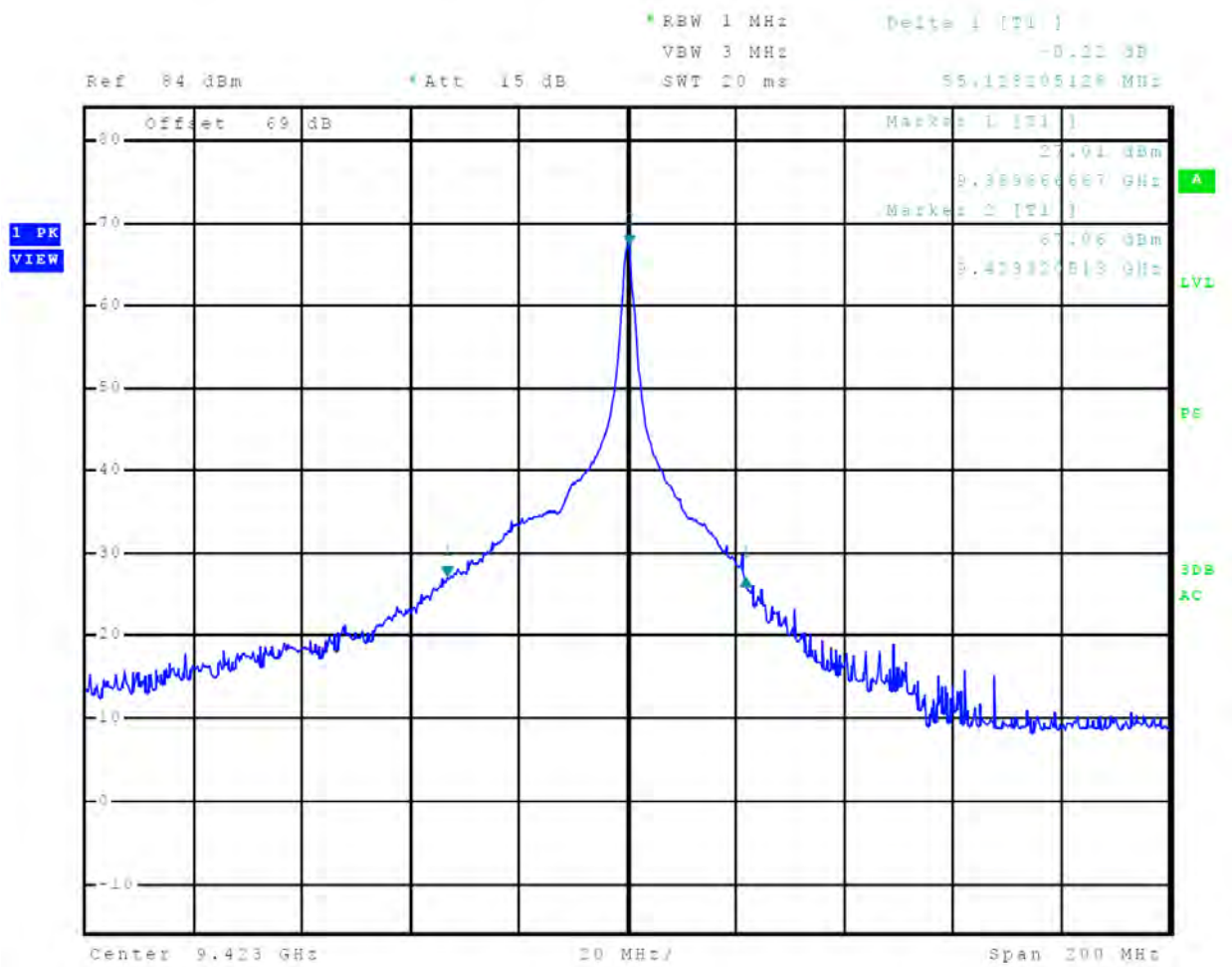

Figure 33 40-dB Occupied Bandwidth Plot, 8 nm

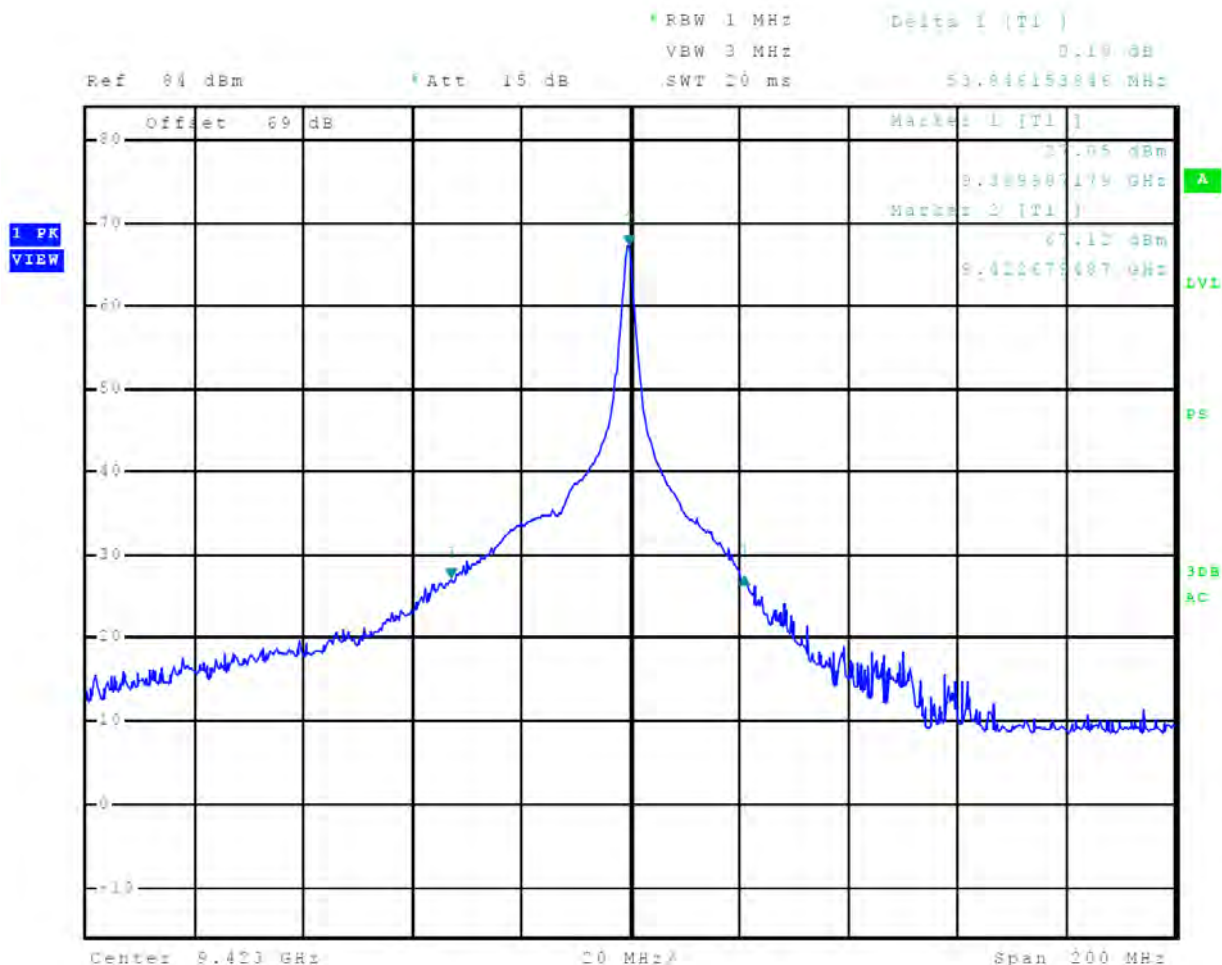

Figure 34 40-dB Occupied Bandwidth Plot, 12 nm

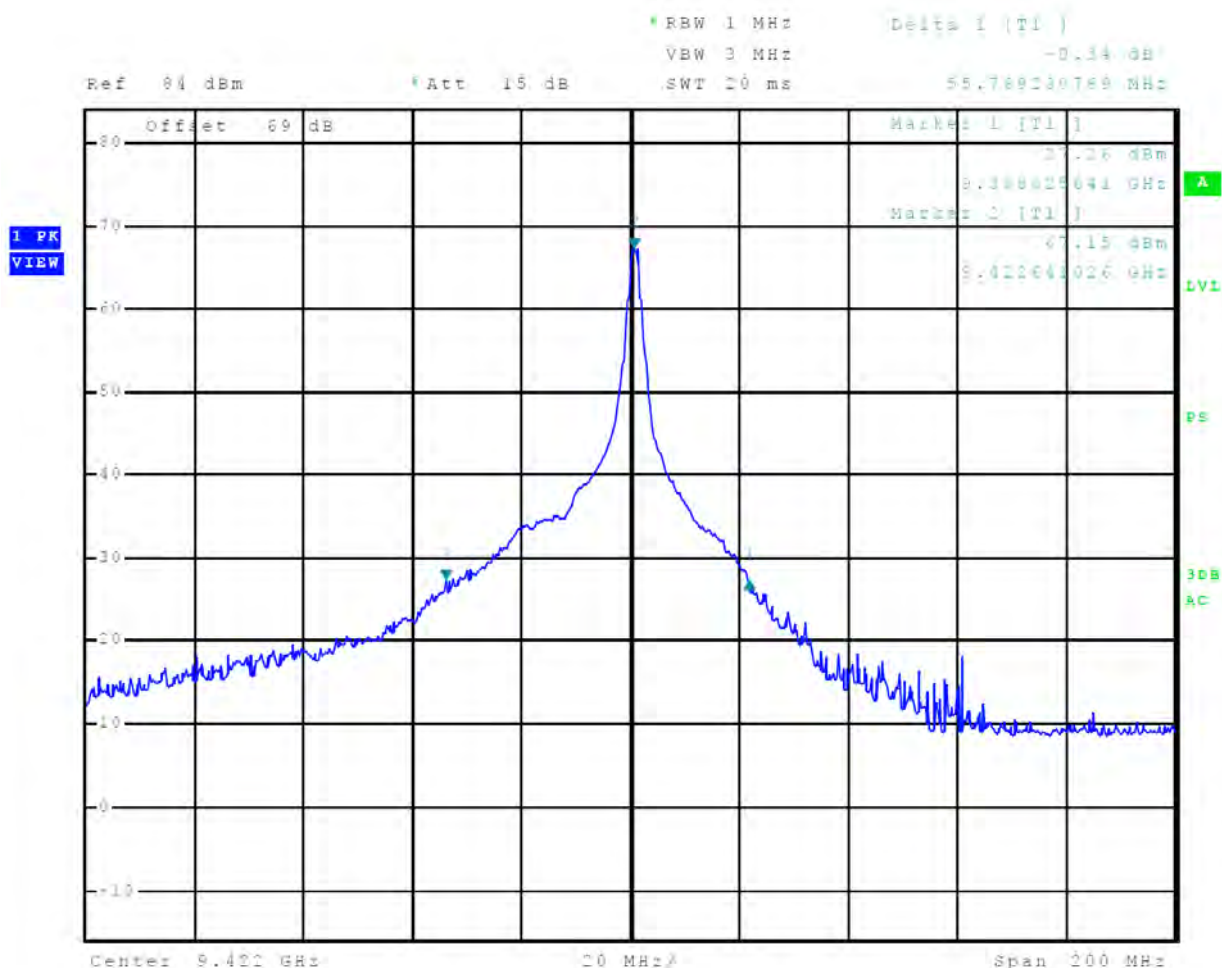

Figure 35 40-dB Occupied Bandwidth Plot, 18 nm

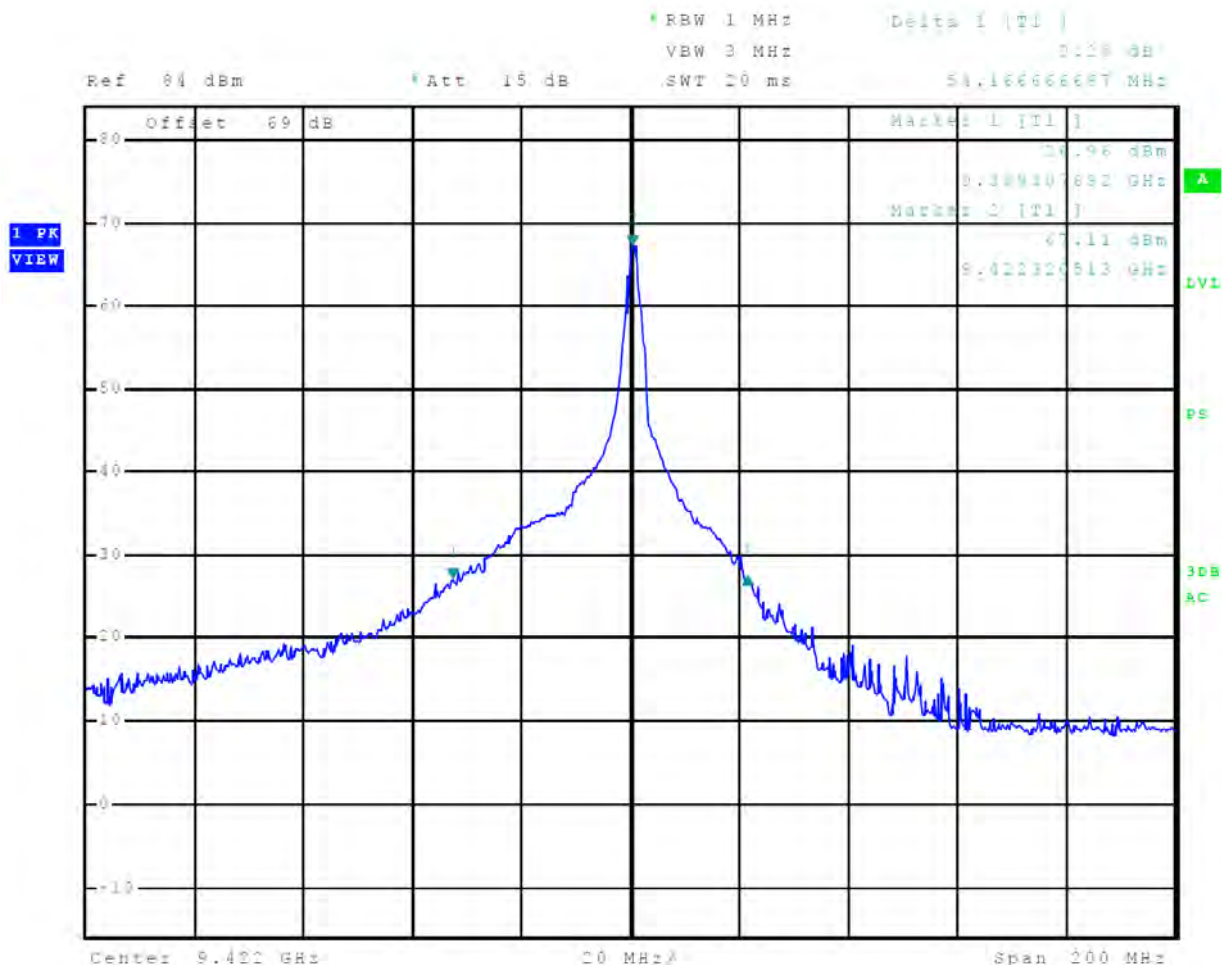

Figure 36 40-dB Occupied Bandwidth Plot, 24 nm

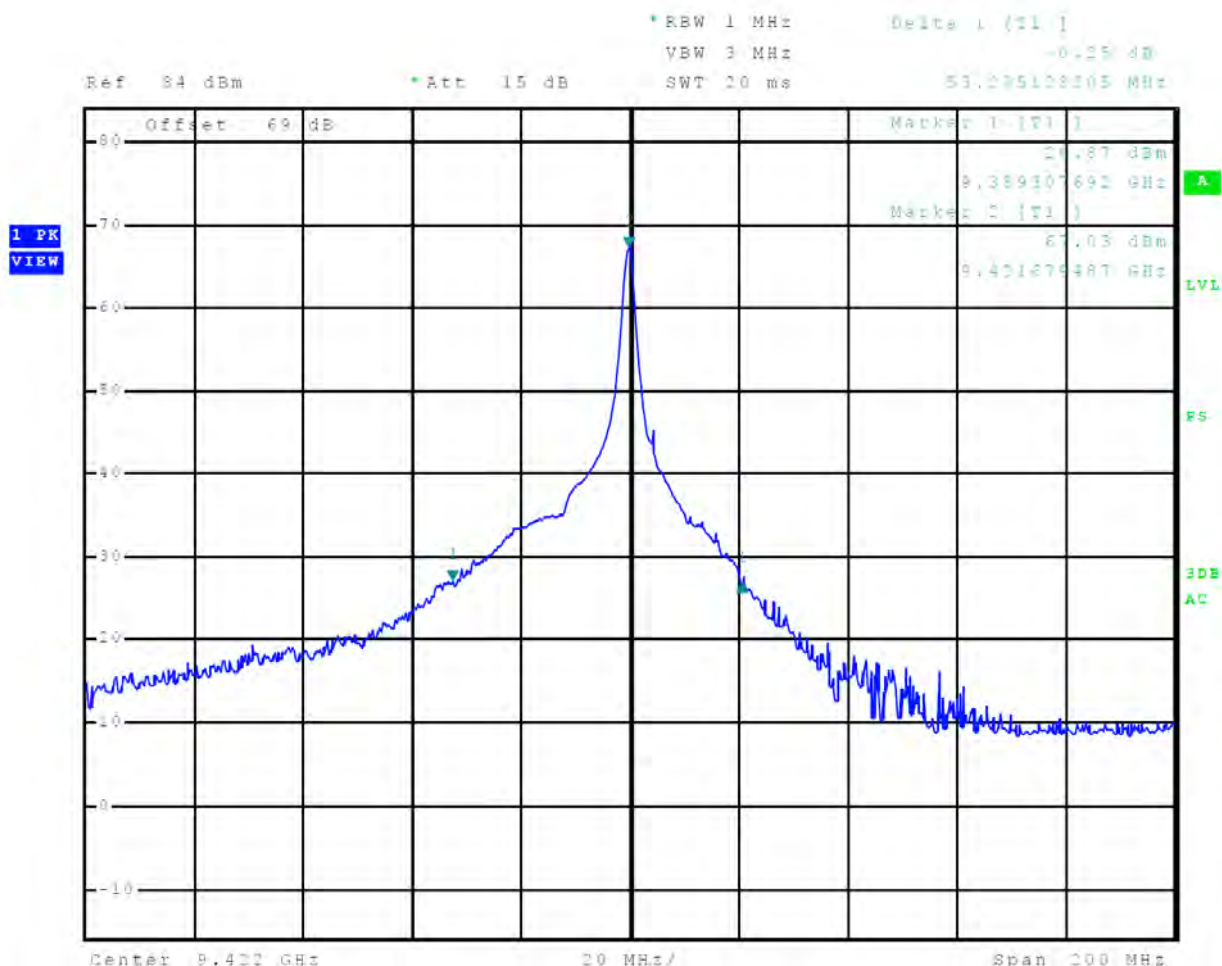

Figure 37 40-dB Occupied Bandwidth Plot, 36 nm

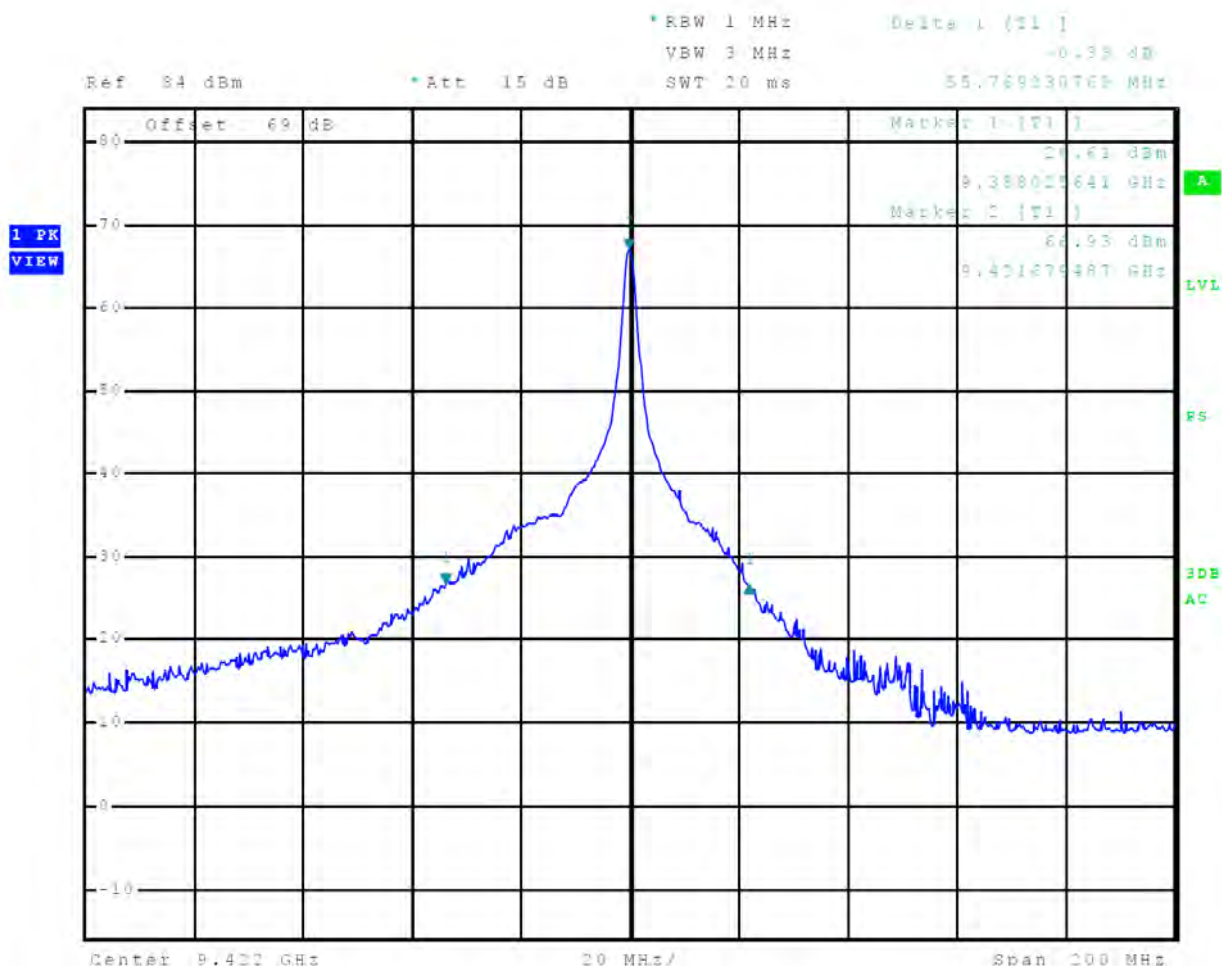



Figure 38 40-dB Occupied Bandwidth Plot, 48 nm

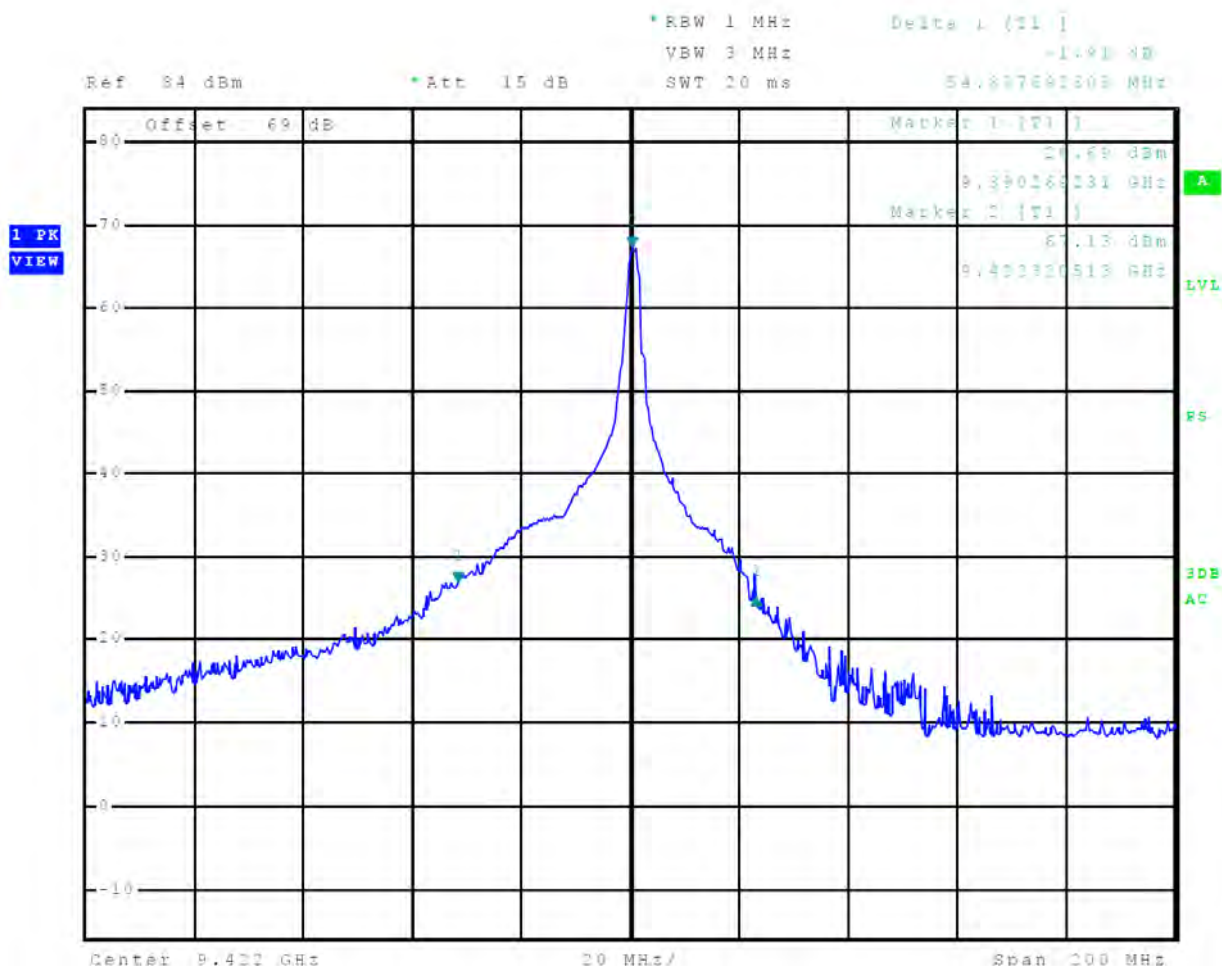

Figure 39 40-dB Occupied Bandwidth Plot, 64 nm

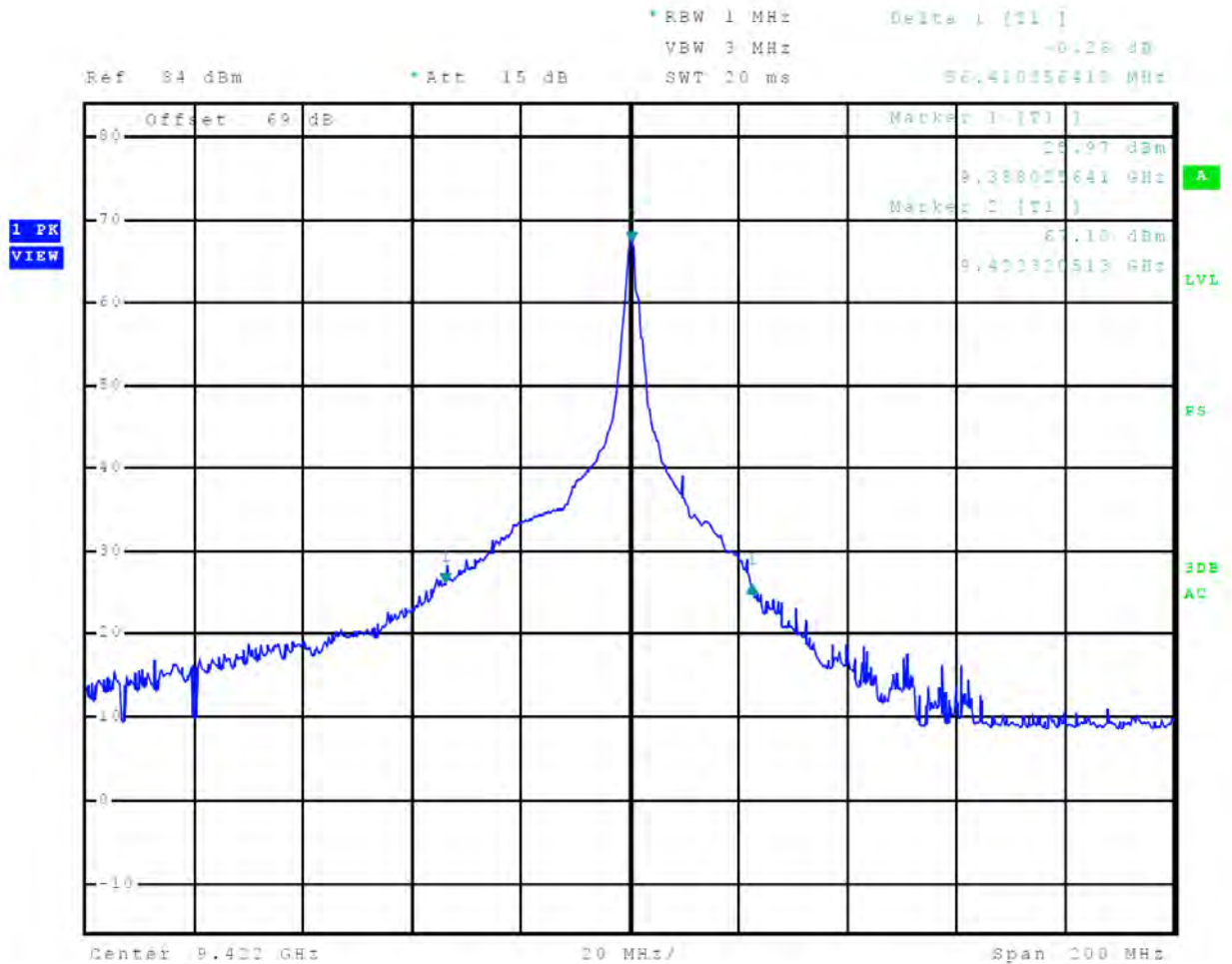

Figure 40 40-dB Occupied Bandwidth Plot, 72 nm

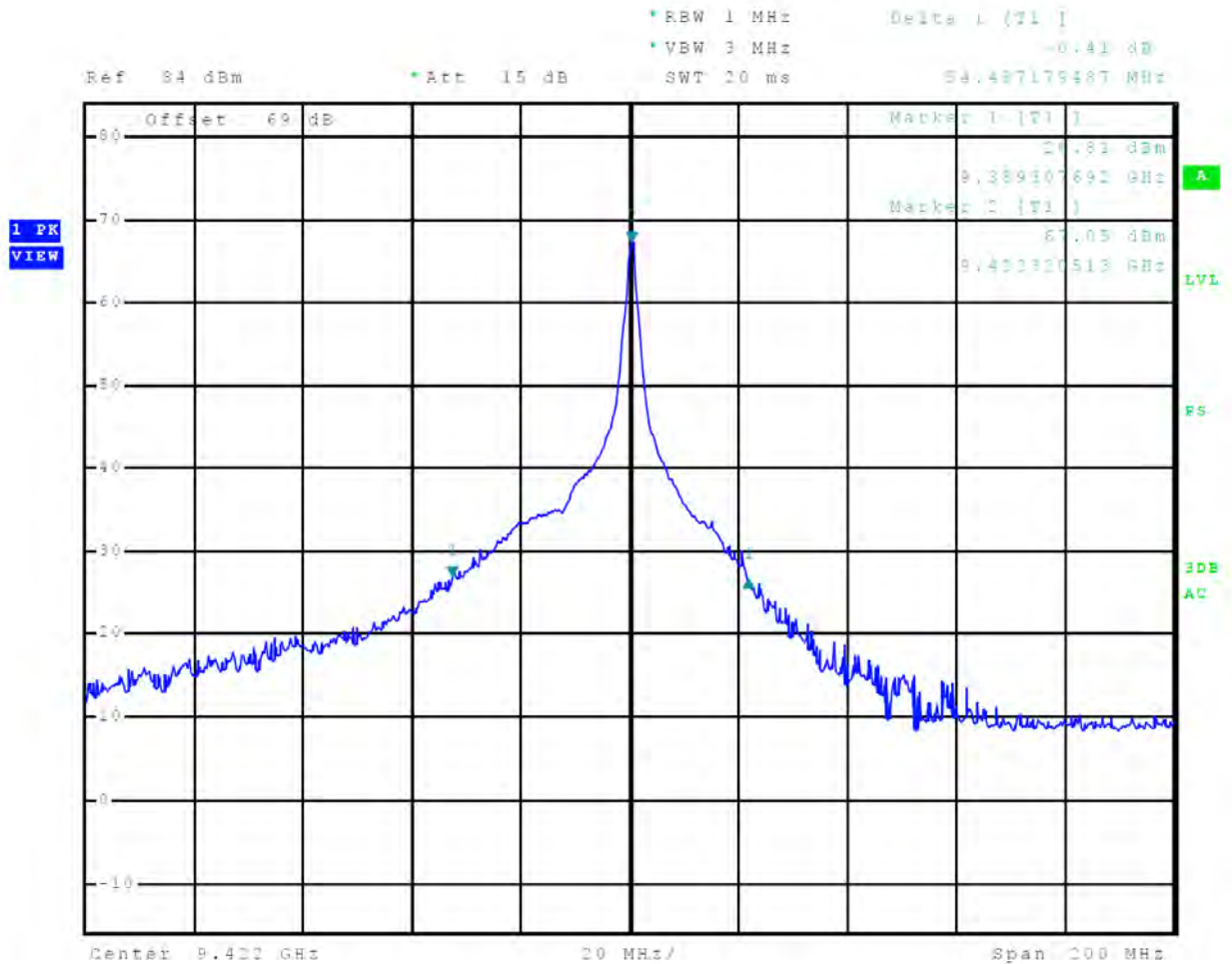
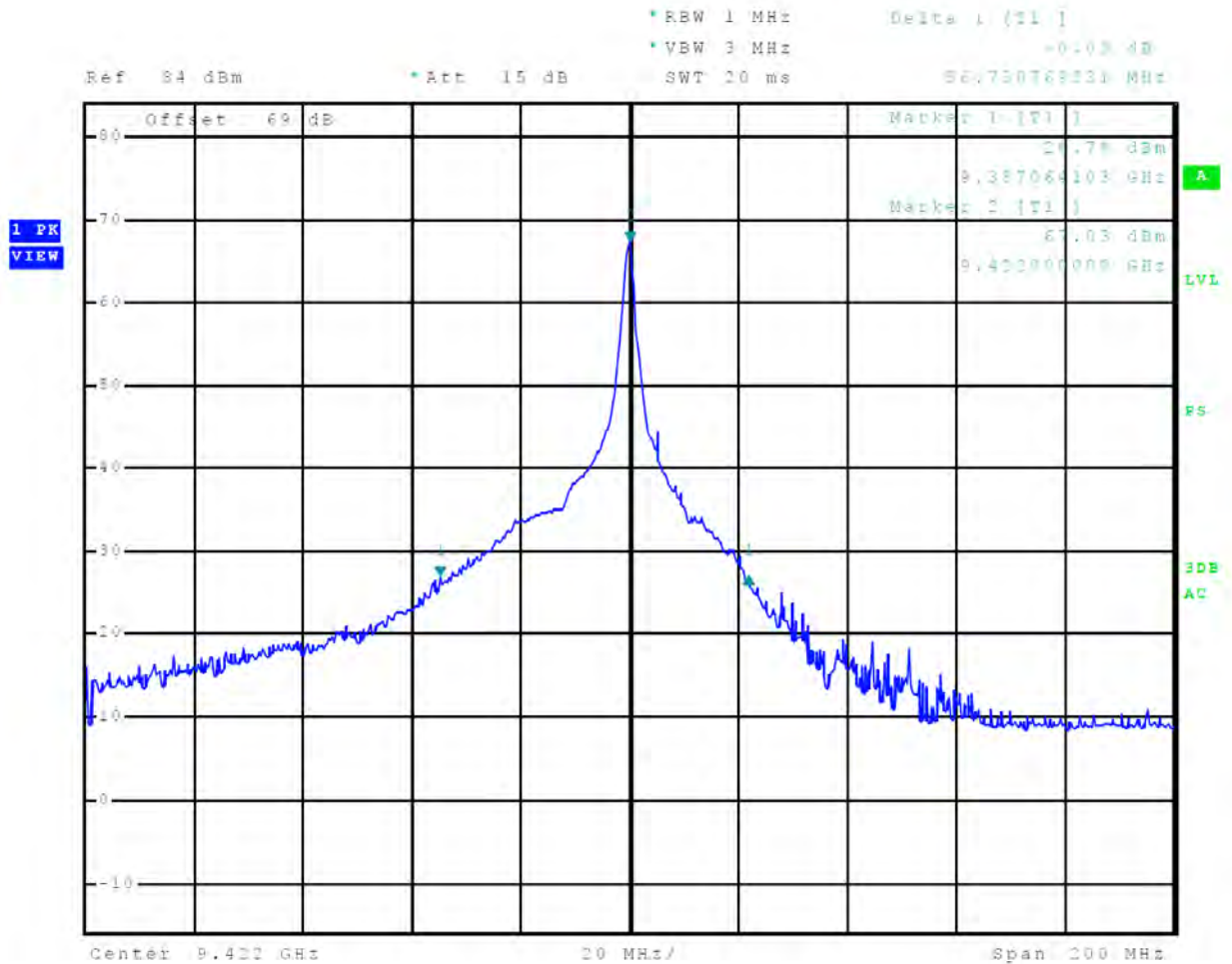

Figure 41 40-dB Occupied Bandwidth Plot, 96 nm





## TEST #4 Spurious Emissions at antenna terminal

### Measurements Required

The radio frequency voltage or power generated within the equipment and appearing on a spurious frequency shall be checked at the equipment output terminals when properly loaded with a suitable artificial antenna. To gain dynamic range in the test equipment, a high pass filter attenuated the fundamental frequency of operation was used to observe the harmonic emissions.

### Test Arrangement

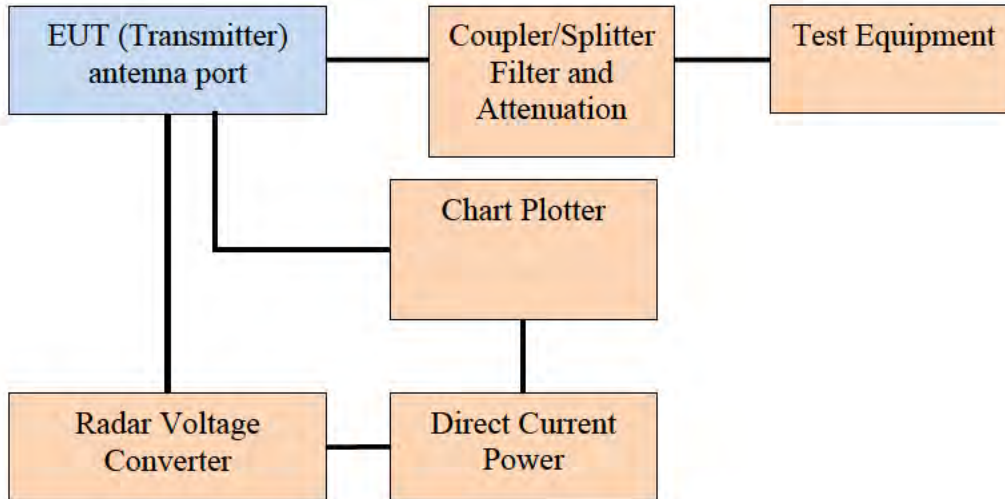

The radio frequency output was coupled to a Rohde & Schwarz ESU40 Spectrum Analyzer. The spectrum analyzer was used to observe the radio frequency spectrum with the transmitter operating in its normal modes. The frequency spectrum from 9 kHz to 40 GHz was observed. Data was taken per 47CFR 2.1051 and applicable paragraphs of Part 80 and RSS-238.

Limit: Spurious emissions must be attenuated below the peak output power by the at least  $43 + 10 \text{ Log}(P_{\text{mean}})$  dB.

12.0 -watt transmitter limit requires the out of band emissions must be suppressed by at least 53.8 dBc

$$\begin{aligned}
 \text{Attenuation} &= 43 + 10 \text{ Log}_{10}(P_w) \\
 &= 43 + 10 \text{ Log}_{10}(12.0) \\
 &= 53.8 \text{ dBc}
 \end{aligned}$$

**Table 3 Spurious Emissions Results**

Channel MHz,(nm)	Spurious Freq. (MHz)	Measured Level (dBm)	Level Below Carrier (dBc)
9411.5 (1/16)	18,823	-14.64	88.6
	28,235	-22.56	96.6
	37,646	-22.39	96.4
9411.5 (1/8)	18,823	-13.73	87.7
	28,235	-23.05	97.1
	37,646	-22.75	96.8
9411.5 (1/4)	18,823	-13.50	87.5
	28,235	-23.30	97.3
	37,646	-22.19	96.2
9411.5 (1/2)	18,823	-13.39	87.4
	28,235	-23.53	97.5
	37,646	-21.92	95.9
9411.5 (3/4)	18,823	-13.50	87.5
	28,235	-25.01	99.0
	37,646	-22.08	96.1
9411.5 (1)	18,823	-13.73	87.7
	28,235	-23.72	97.7
	37,646	-22.61	96.6
9411.5 (1.5)	18,823	-14.70	88.7
	28,235	-23.86	97.9
	37,646	-23.66	97.7



**Table 4 Spurious Emissions Results**

Channel MHz,(nm)	Spurious Freq. (MHz)	Measured Level (dBm)	Level Below Carrier (dBc)
9411.5 (2)	18,823	-13.68	87.7
	28,235	-23.64	97.6
	37,646	-22.17	96.2
9411.5 (3)	18,823	-13.97	88.0
	28,235	-23.15	97.2
	37,646	-21.91	95.9
9411.5 (4)	18,823	-16.04	90.0
	28,235	-23.24	97.2
	37,646	-22.64	96.6
9411.5 (6)	18,823	-14.48	88.5
	28,235	-23.71	97.7
	37,646	-22.14	96.1
9411.5 (8)	18,823	-16.60	90.6
	28,235	-24.68	98.7
	37,646	-23.51	97.5
9411.5 (12)	18,823	-19.11	93.1
	28,235	-24.01	98.0
	37,646	-20.99	95.0
9411.5 (18)	18,823	-15.07	89.1
	28,235	-24.37	98.4
	37,646	-22.54	96.5

**Table 5 Spurious Emissions Results**

Channel MHz,(nm)	Spurious Freq. (MHz)	Measured Level (dBm)	Level Below Carrier (dBc)
9411.5 (24)	18,823	-14.99	89.0
	28,235	-23.89	97.9
	37,646	-23.12	97.1
9411.5 (36)	18,823	-14.41	88.4
	28,235	-24.65	98.7
	37,646	-22.00	96.0
9411.5 (48)	18,823	-18.28	92.3
	28,235	-21.81	95.8
	37,646	-21.59	95.6
9411.5 (64)	18,823	-19.49	93.5
	28,235	-21.72	95.7
	37,646	-20.51	94.5
9411.5 (72)	18,823	-14.89	88.9
	28,235	-23.55	97.6
	37,646	-22.06	96.1

Data was taken per 2.1051 and applicable parts of 47CFR Part 80 and RSS-238. The EUT demonstrated compliance with the specifications of Paragraphs 47CFR 2.1051, 2.1057, Part 80 and RSS-238. There are no deviations to the specifications.

## TEST #5 Emission Limitations In-Band (Mask)

### Measurements Required

Transmitters used in the radio services governed by this part must comply with the emissions masks outlined in this section. Paragraph 80.211(f) specifies the out of band emission limitations for this equipment. The spurious emissions for the device were measured at the maximum output power condition.

80.211 (f)

(f) The mean power when using emissions other than those in [paragraphs \(a\)](#), [\(b\)](#), [\(c\)](#) and [\(d\)](#) of this section:

(1) On any frequency removed from the assigned frequency by more than 50 percent up to and including 100 percent of the authorized bandwidth: At least 25 dB;

(2) On any frequency removed from the assigned frequency by more than 100 percent up to and including 250 percent of the authorized bandwidth: At least 35 dB; and

(3) On any frequency removed from the assigned frequency by more than 250 percent of the authorized bandwidth: At least 43 plus  $10\log_{10}$  (mean power in watts) dB.

### Test Arrangement

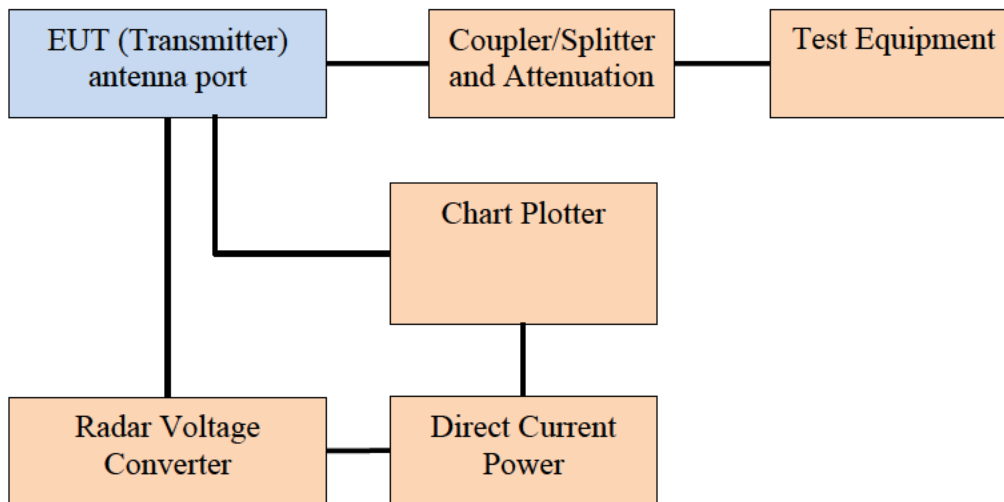

The radio frequency output was coupled to a Rohde &Schwarz ESU40 Spectrum Analyzer. The spectrum analyzer was used to observe the radio frequency spectrum with the transmitter operating through normal modes with maximum output power. The frequency spectrum at the band edges were

observed and plots produced. Refer to figures 42 through 61 for plots presenting compliance with emission mask requirements. Data was taken per 47CFR 2.1051 and applicable parts of Part 80 and RSS-238.

**Figure 42 Emissions Mask, 1/16 nm**

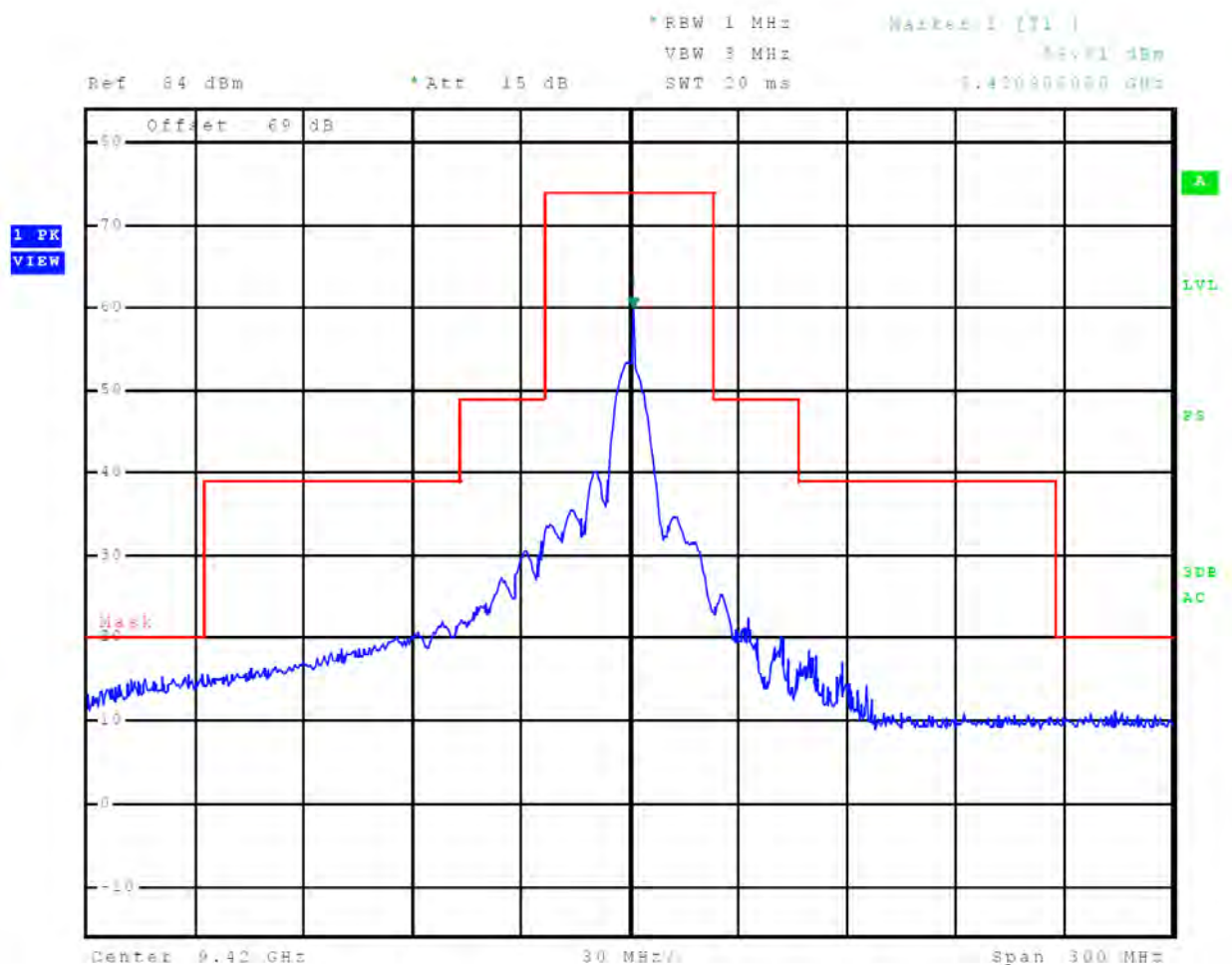



Figure 43 Emissions Mask, 1/8 nm

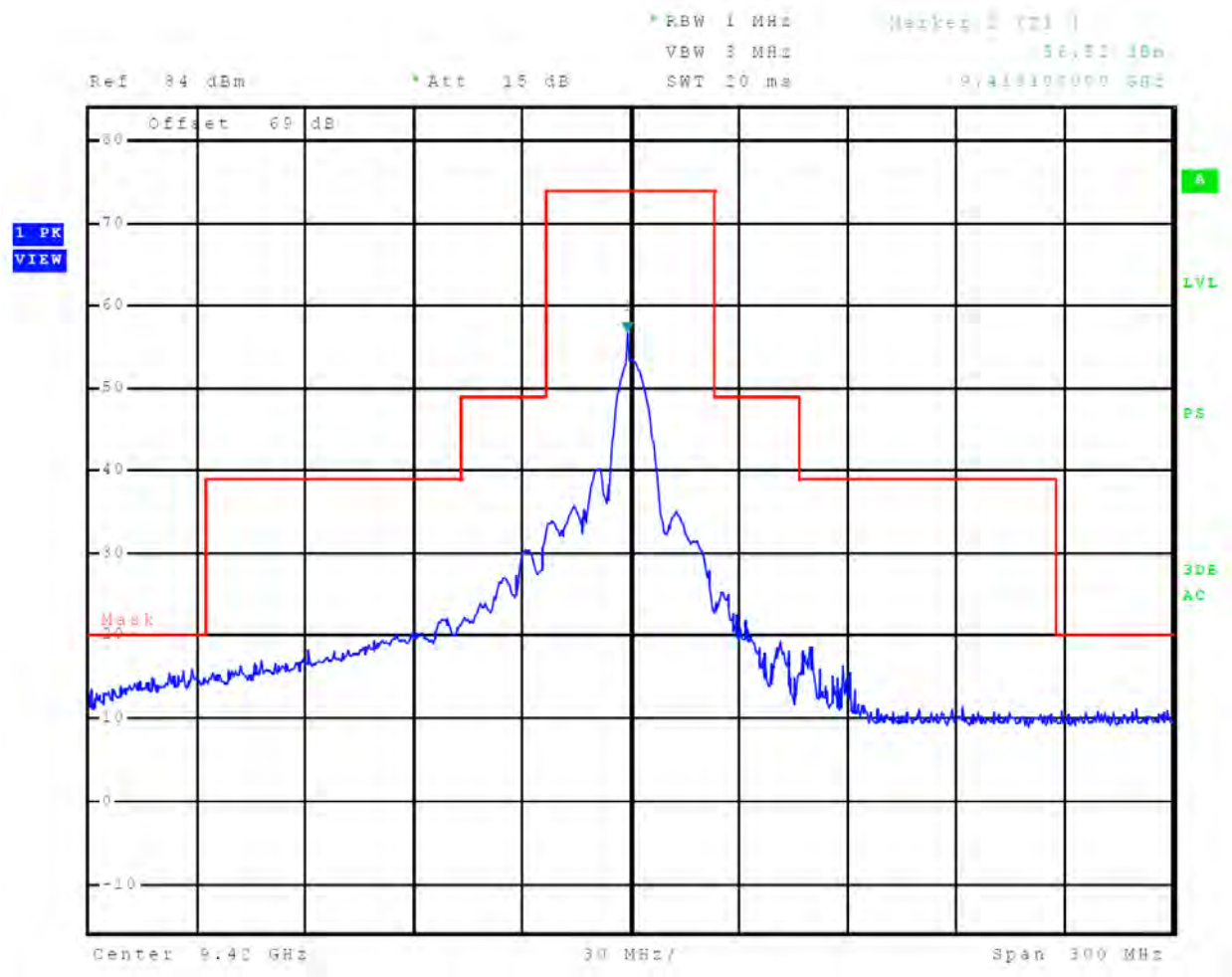

Figure 44 Emissions Mask, 1/4 nm

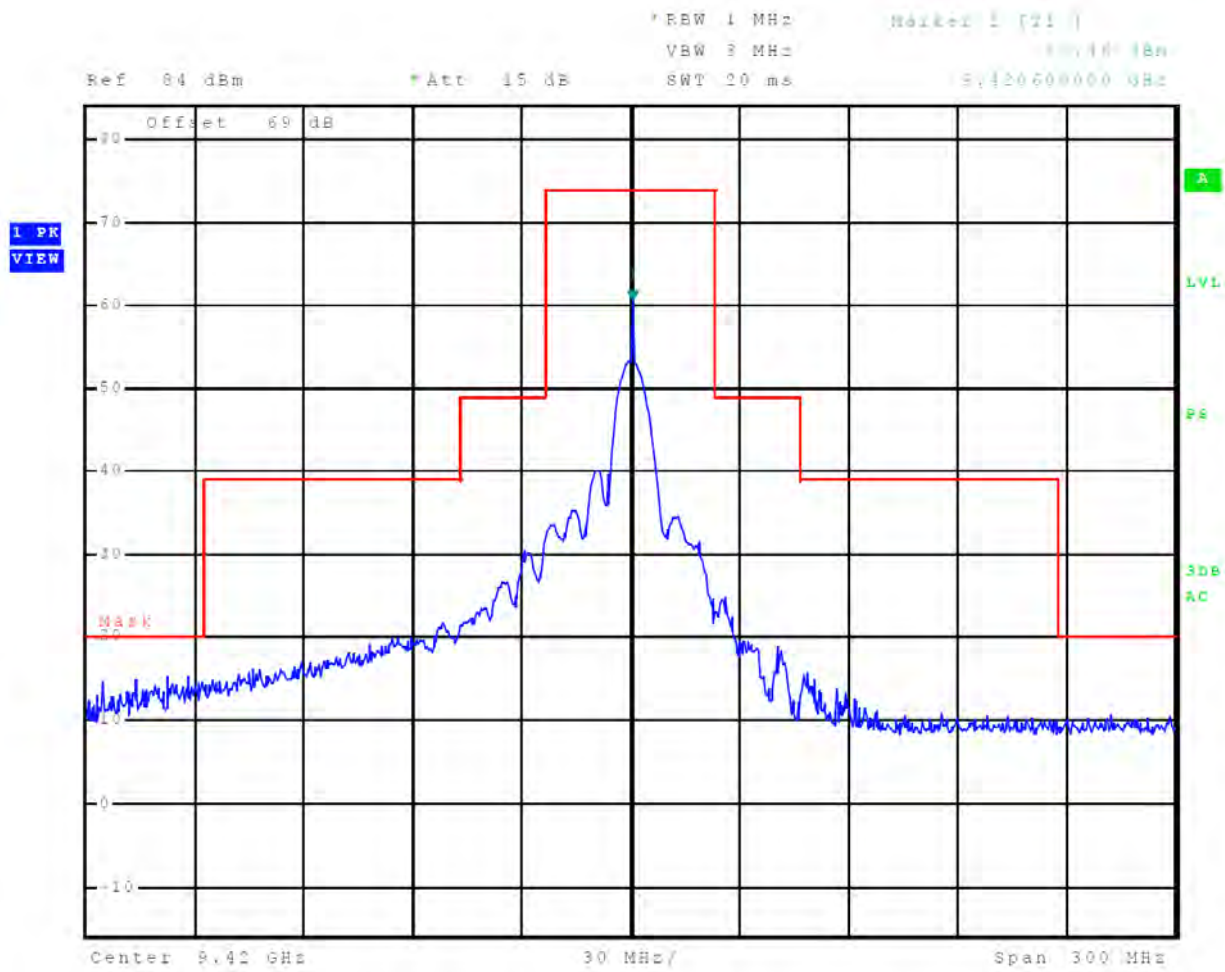



Figure 45 Emissions Mask, 1/2 nm

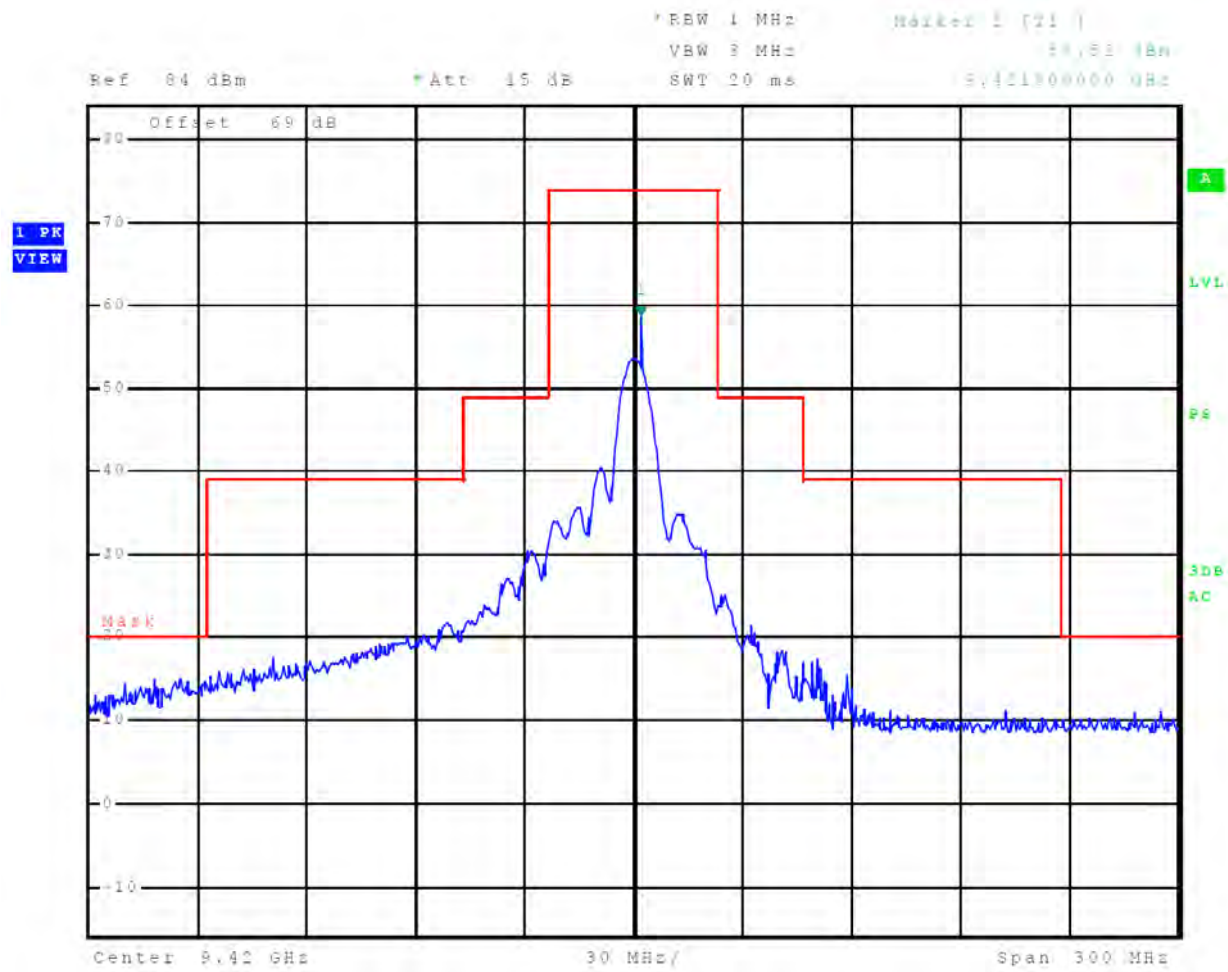

Figure 46 Emissions Mask, 3/4 nm

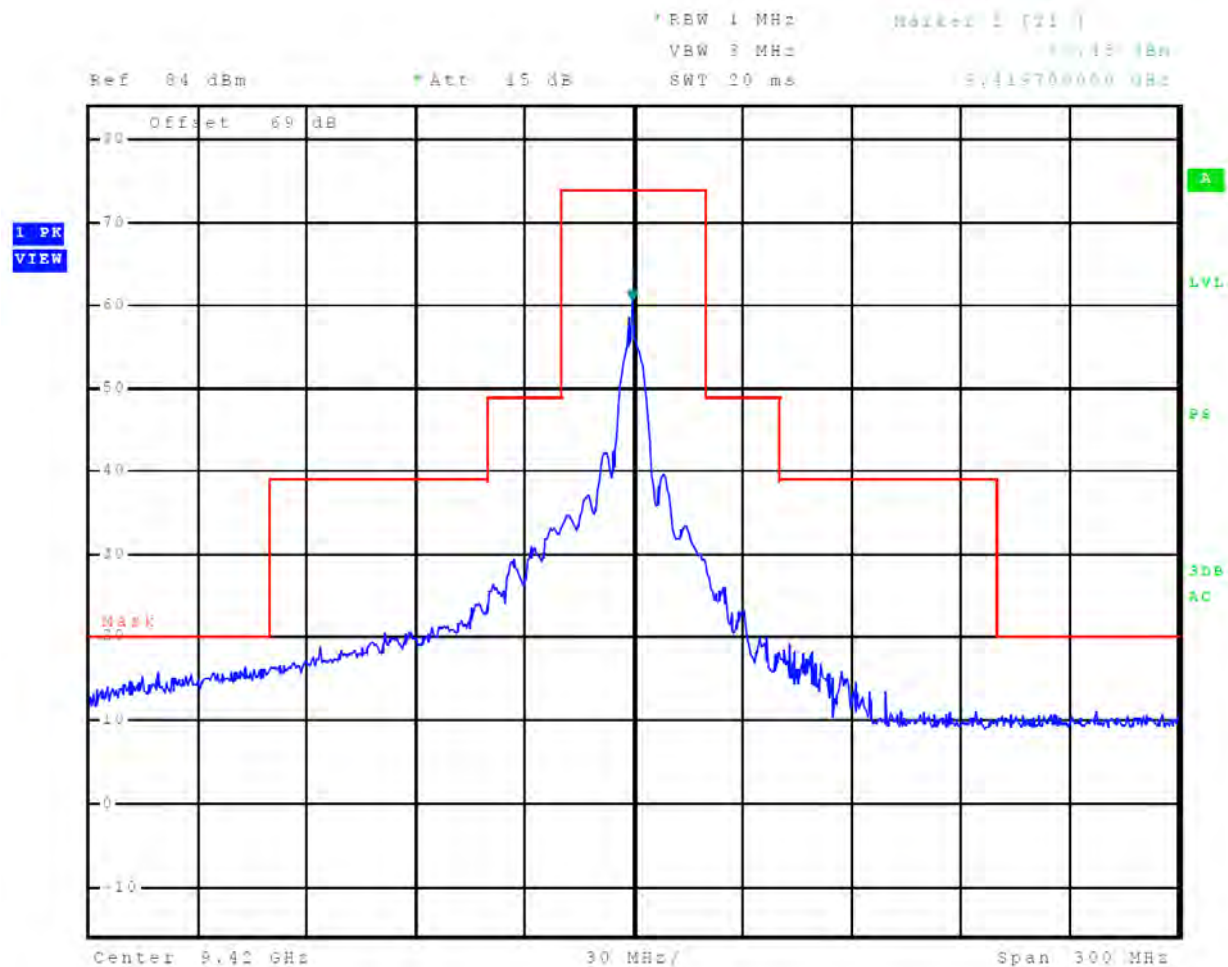

Figure 47 Emissions Mask, 1 nm

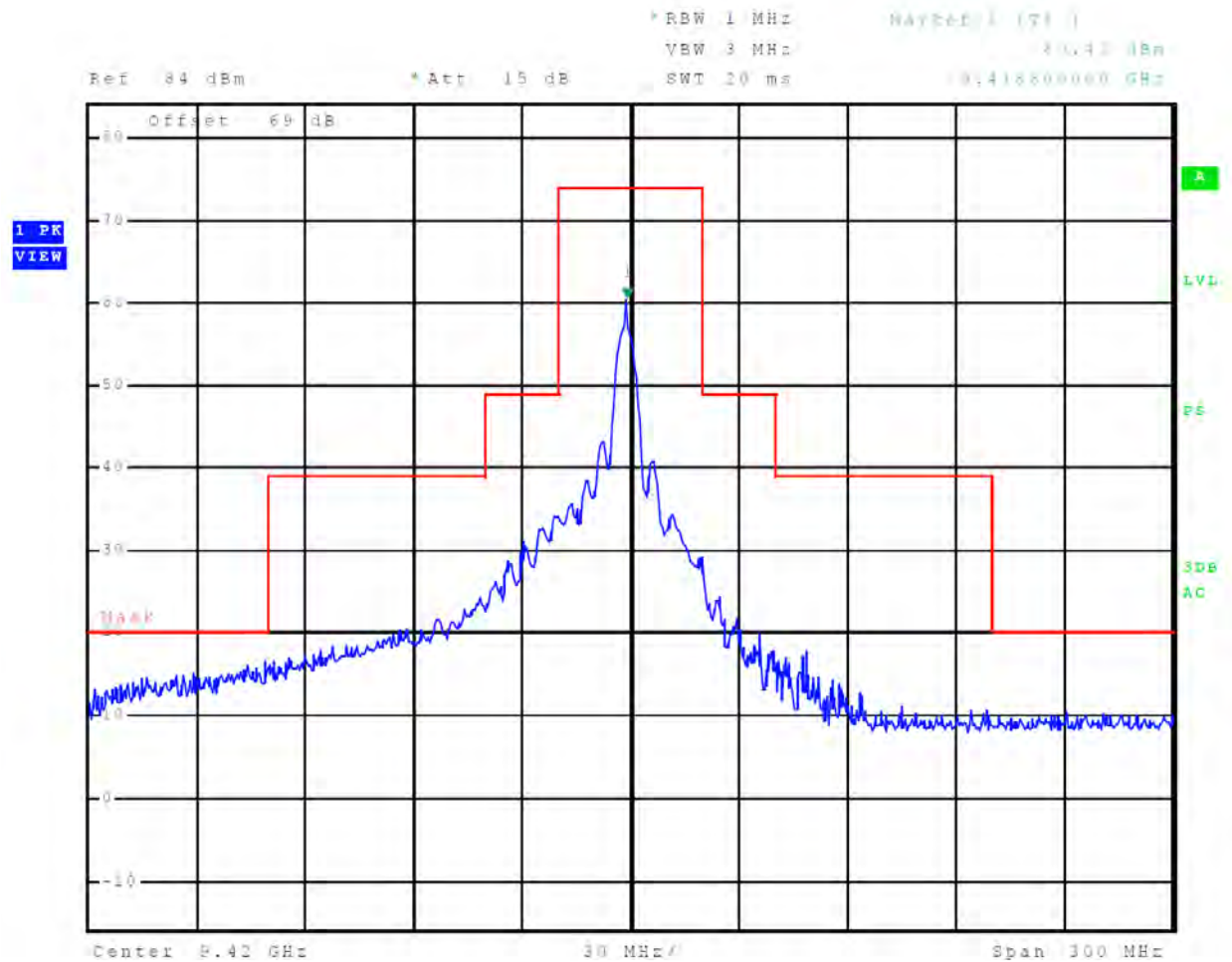

Figure 48 Emissions Mask, 1.5 nm

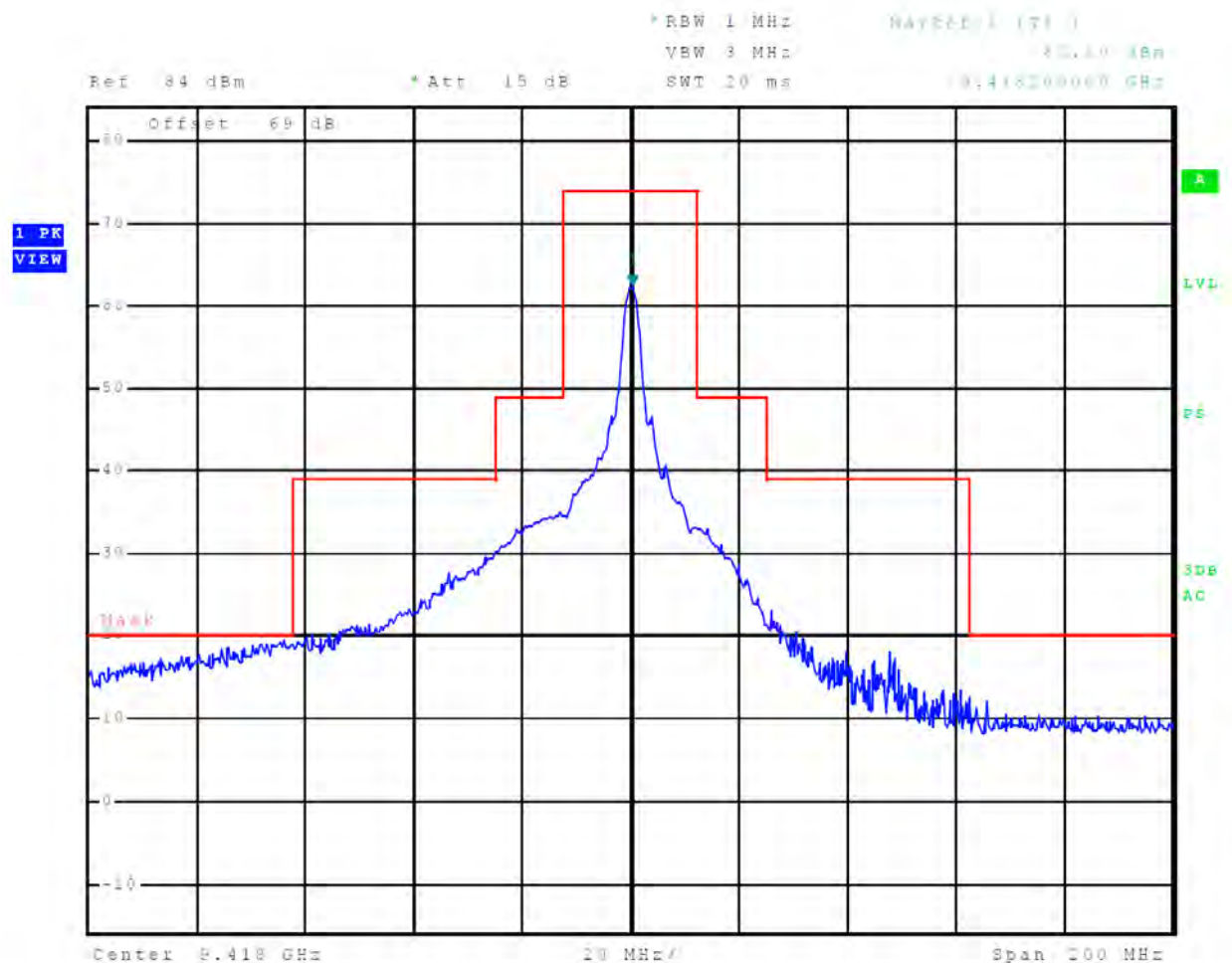

Figure 49 Emissions Mask, 2 nm

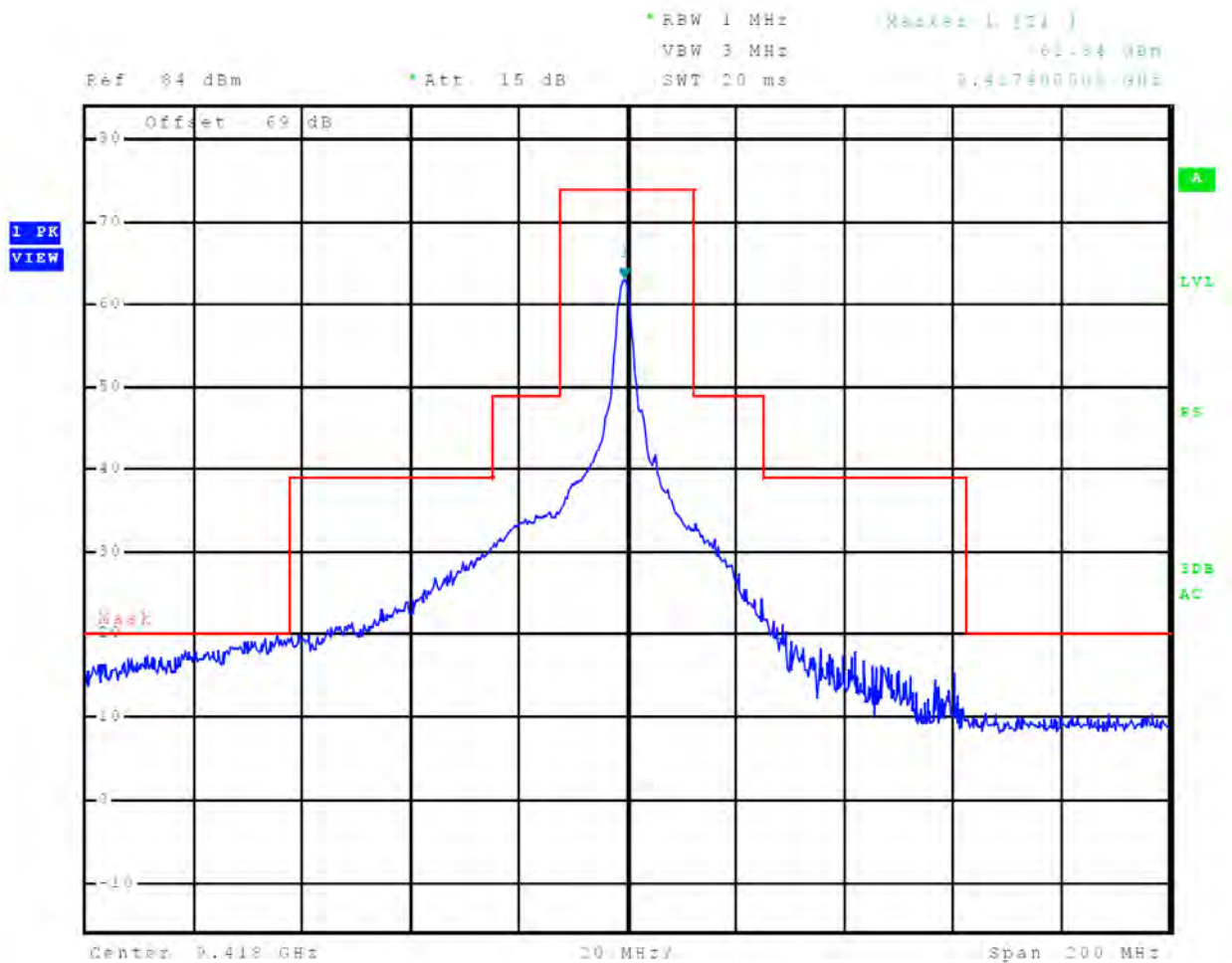

Figure 50 Emissions Mask, 3 nm

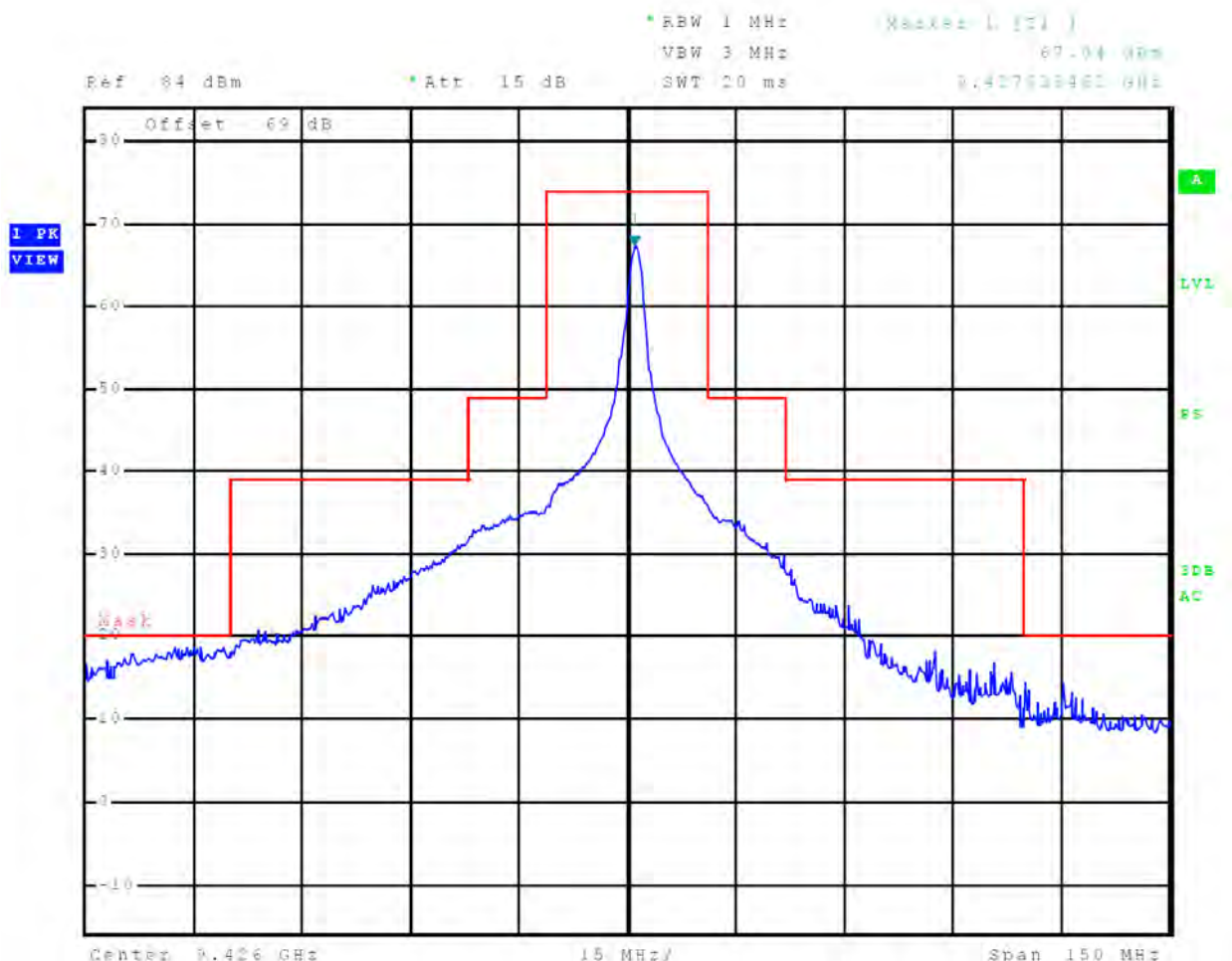



Figure 51 Emissions Mask, 4 nm

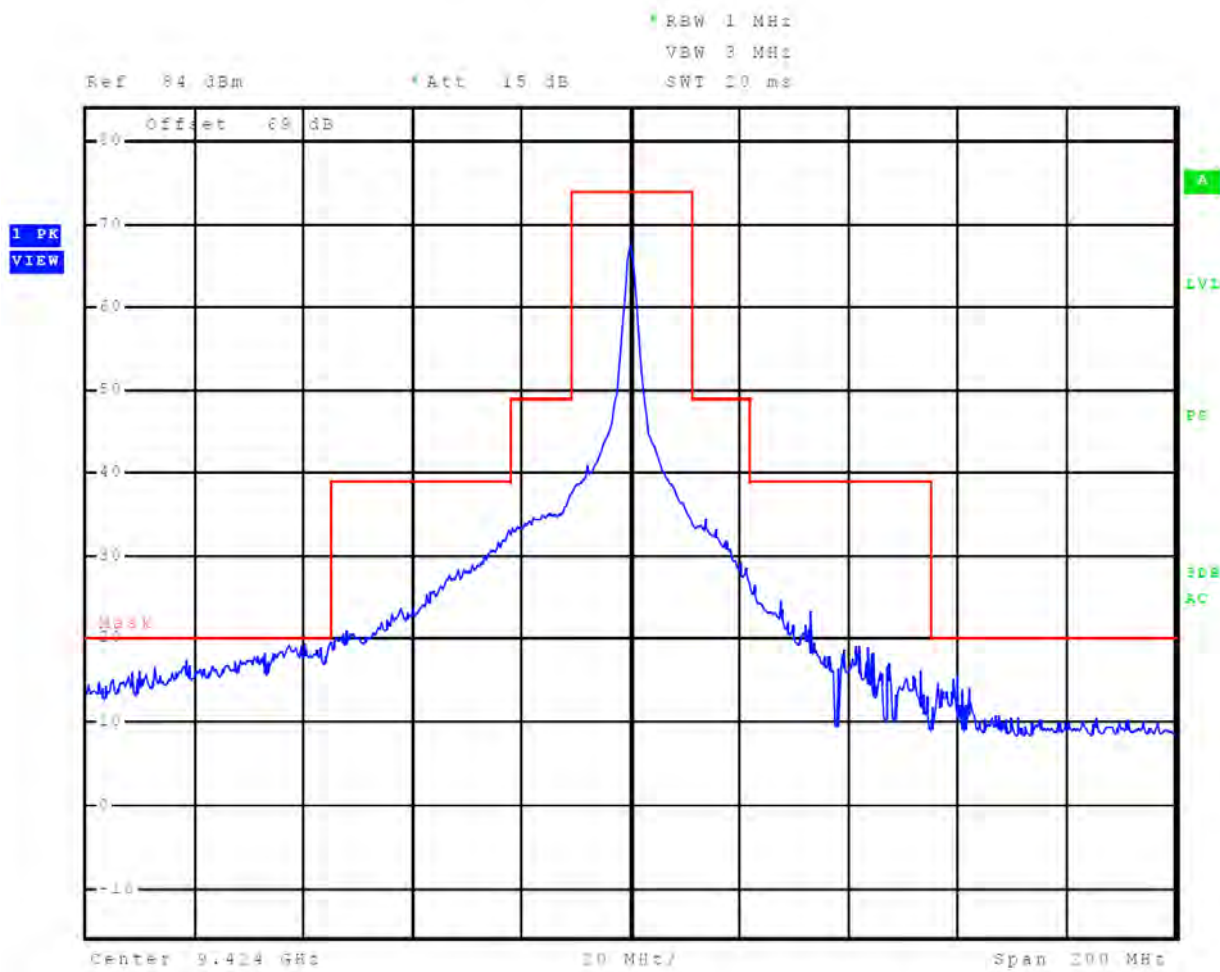

Figure 52 Emissions Mask, 6 nm

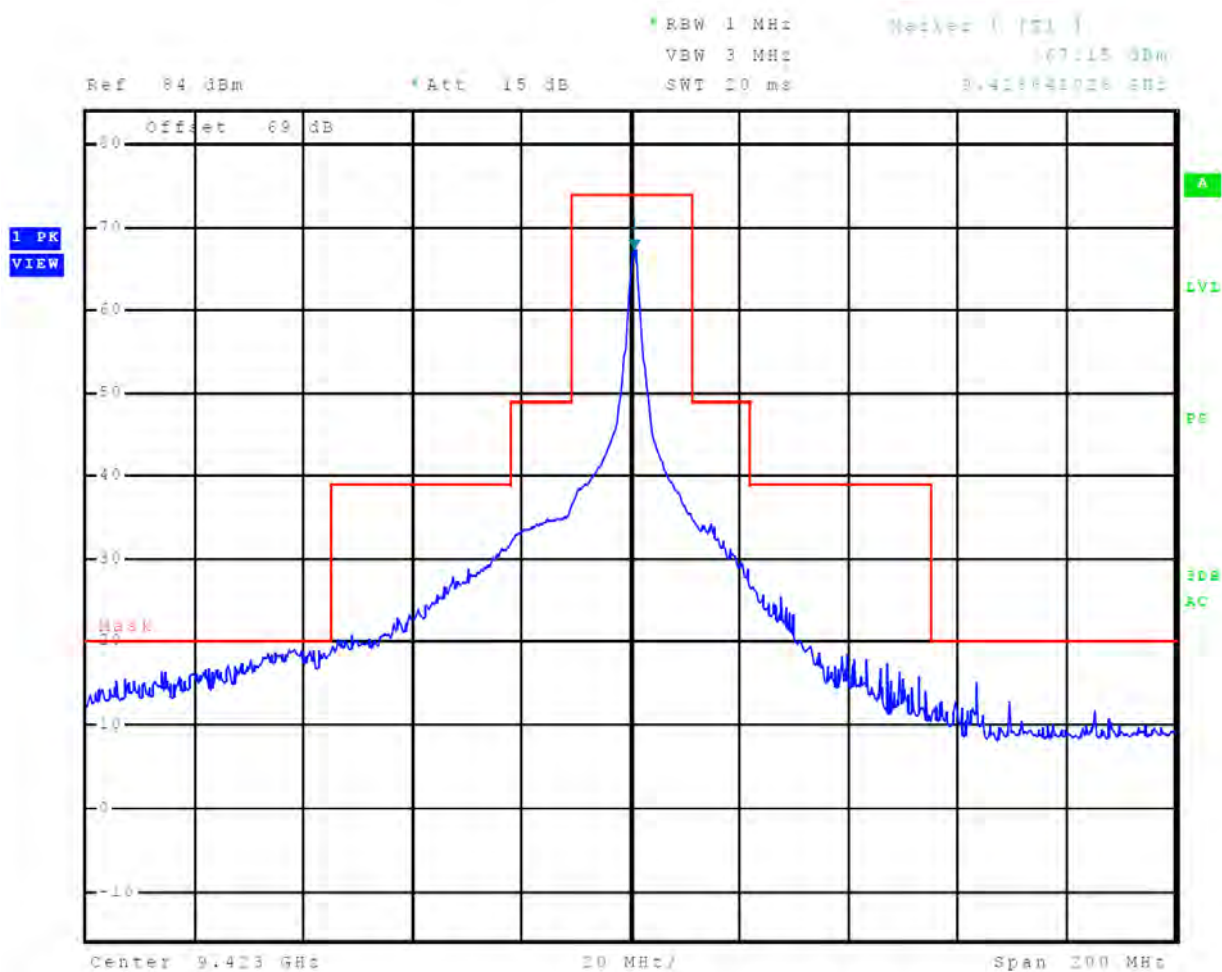

Figure 53 Emissions Mask, 8 nm

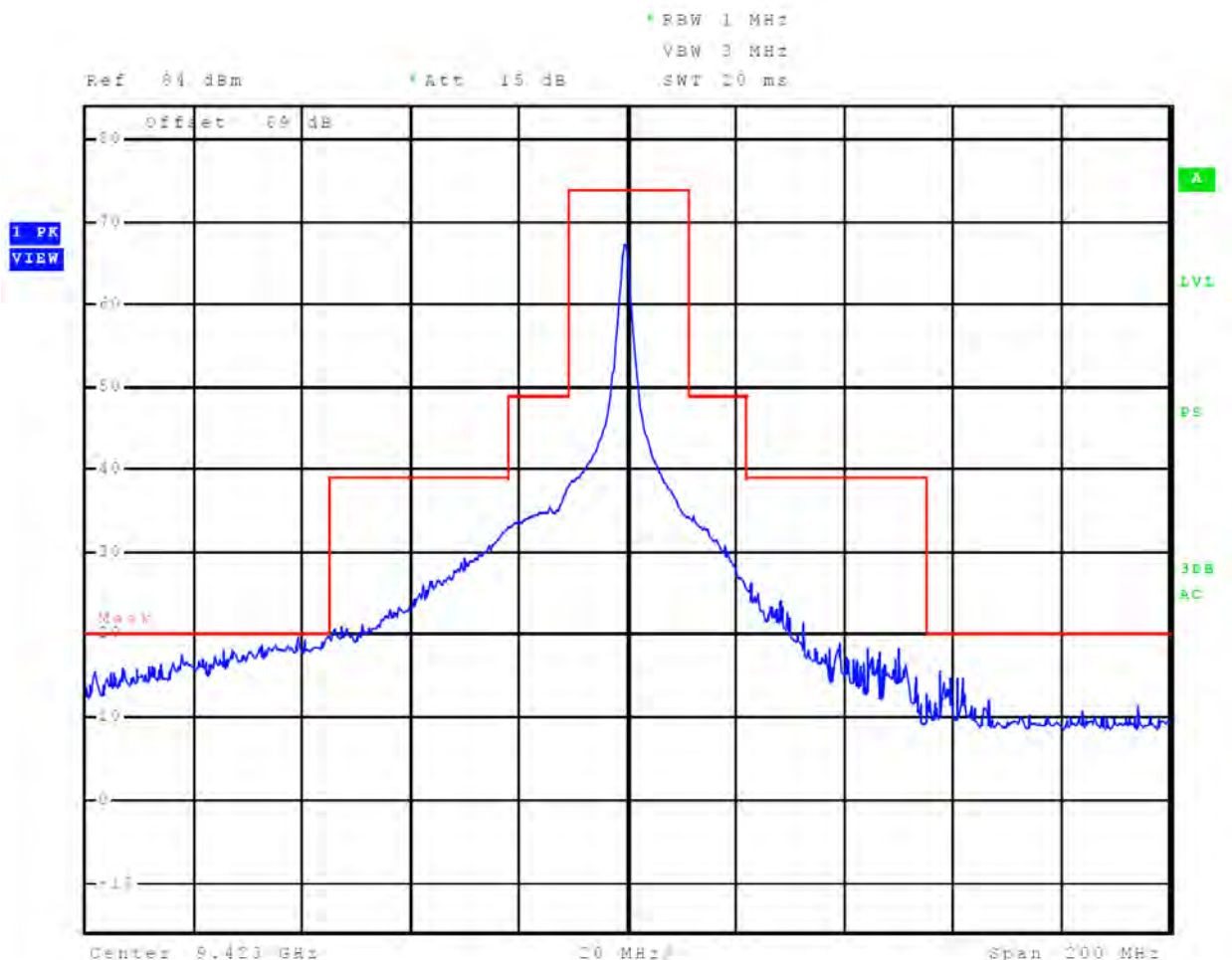

Figure 54 Emissions Mask, 12 nm

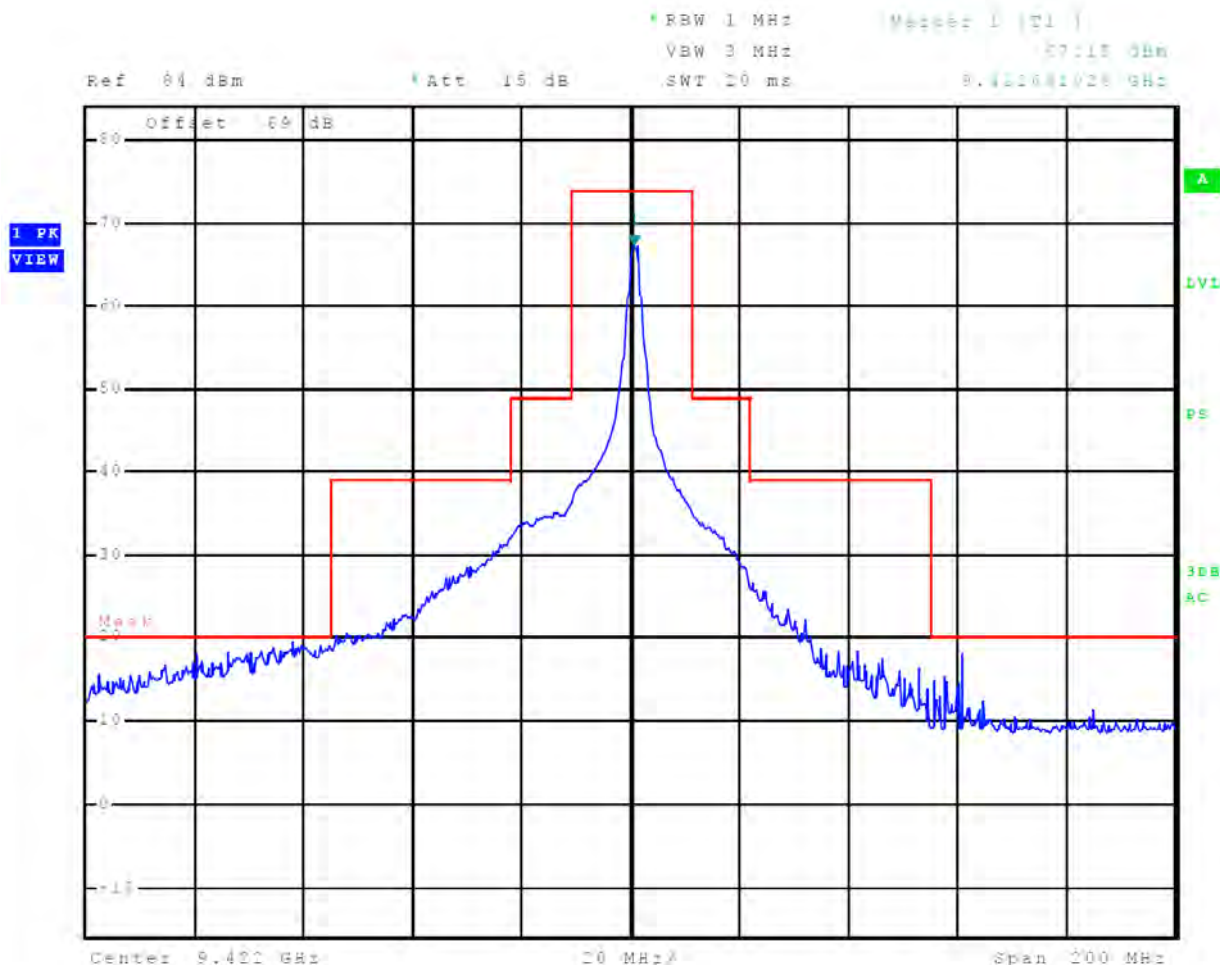

Figure 55 Emissions Mask, 18 nm

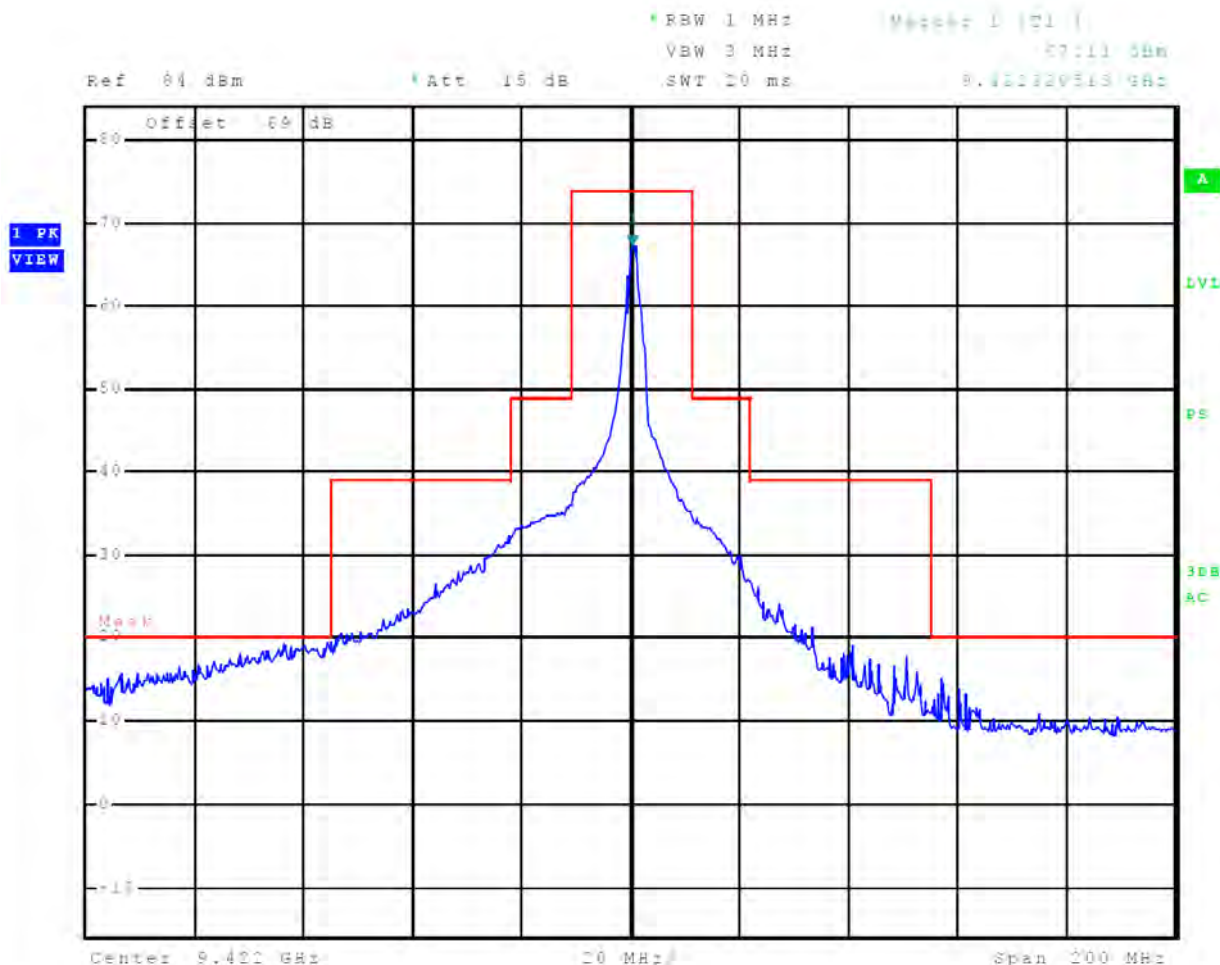

Figure 56 Emissions Mask, 24 nm

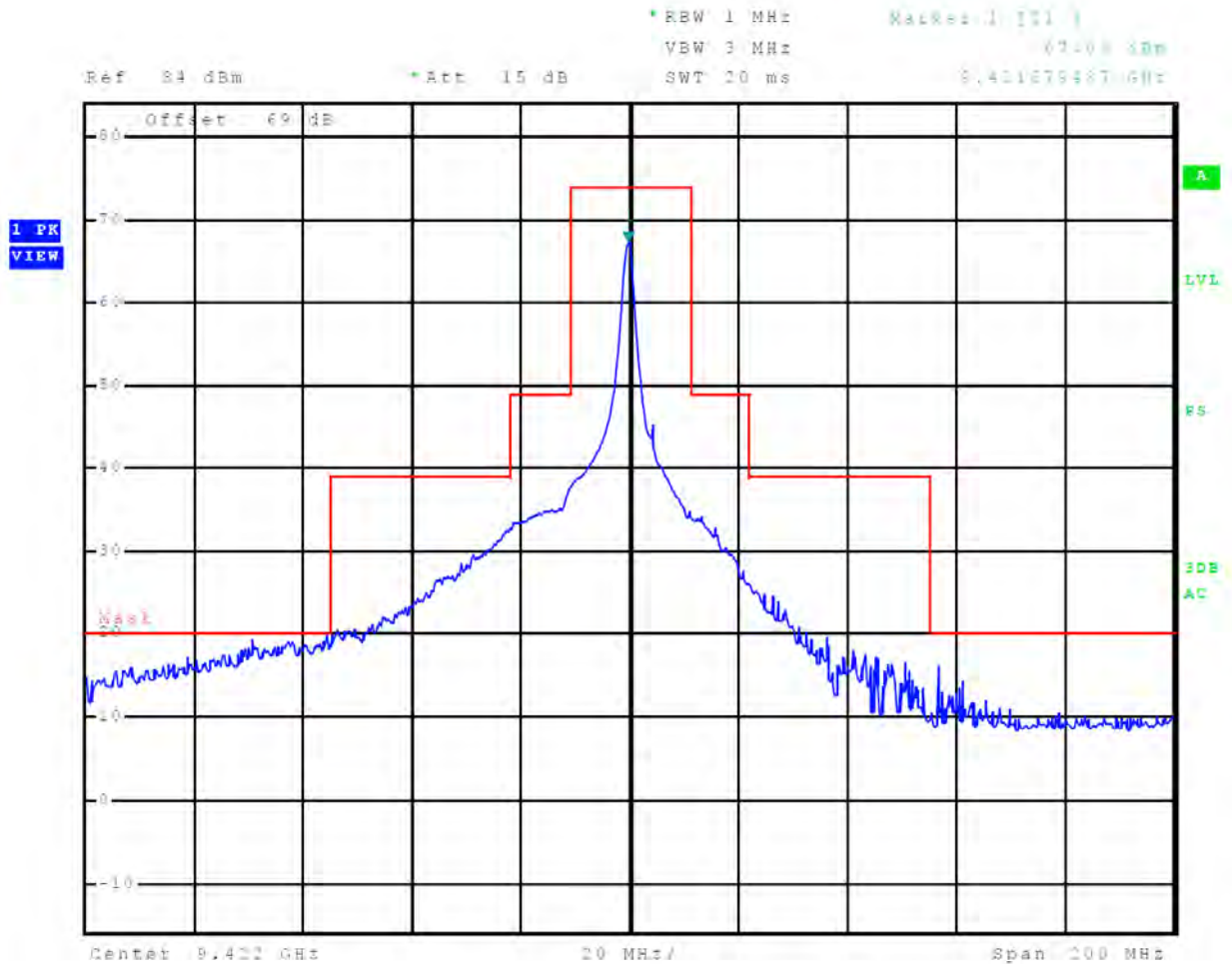



Figure 57 Emissions Mask, 36 nm

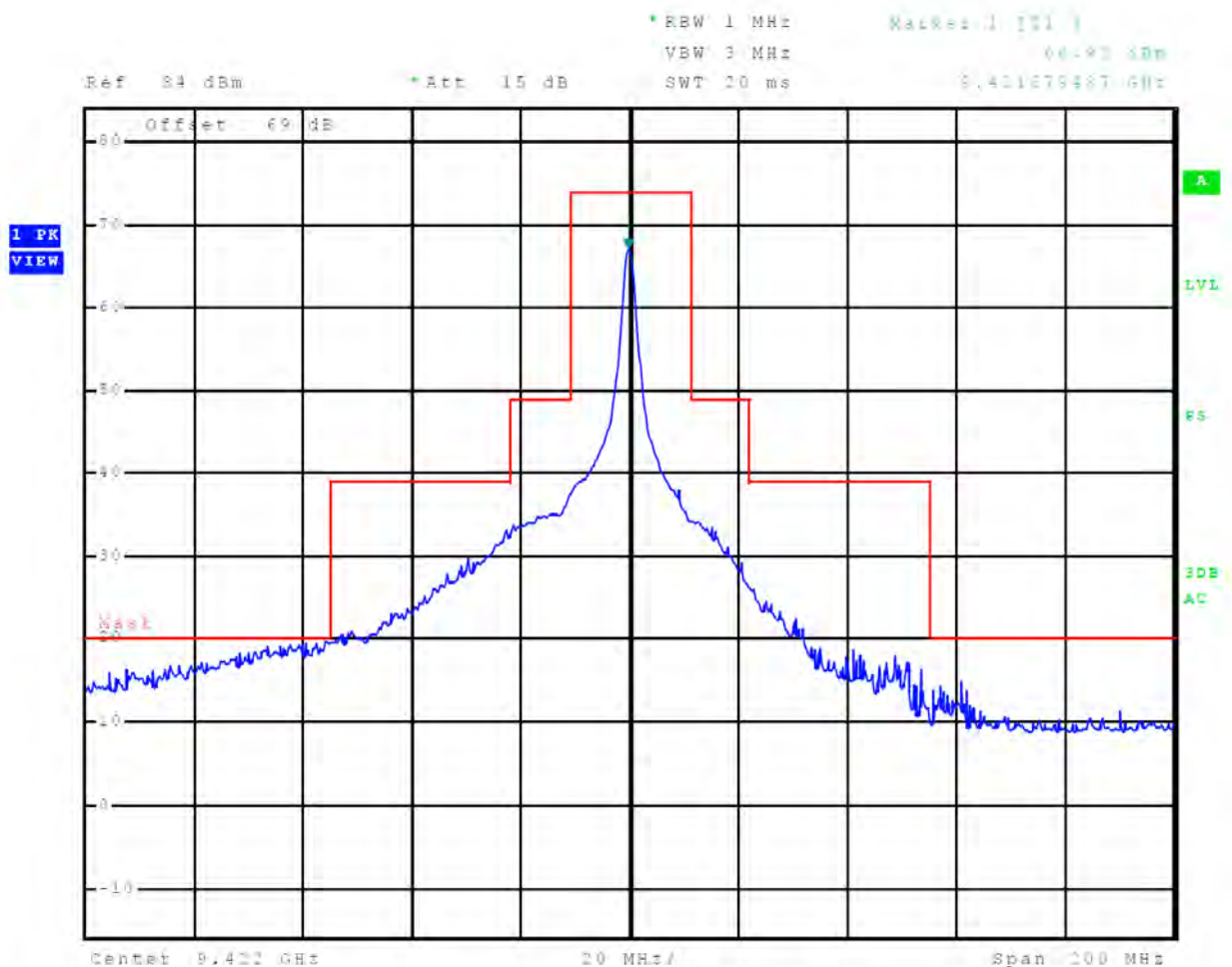

Figure 58 Emissions Mask, 48 nm

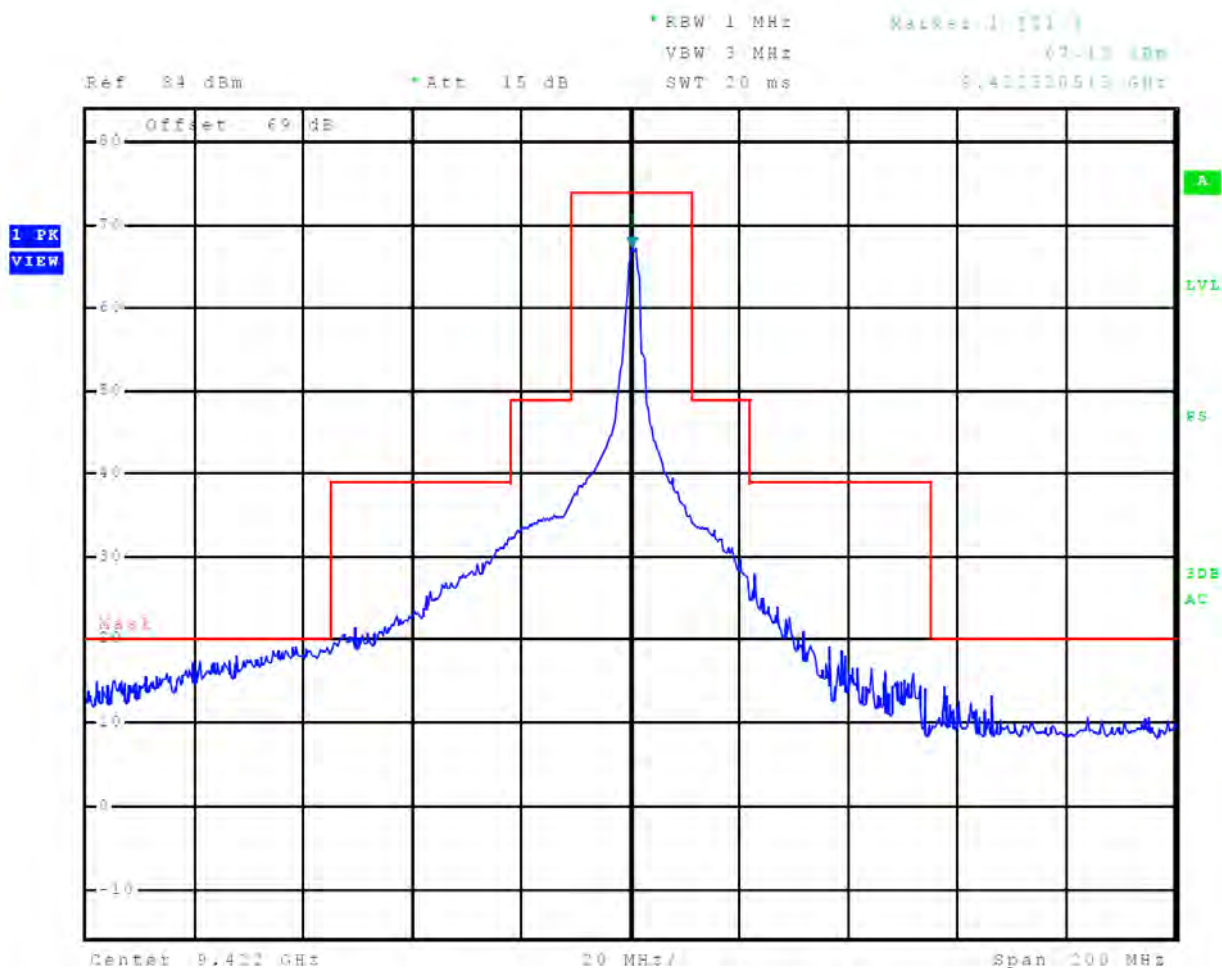

Figure 59 Emissions Mask, 64 nm

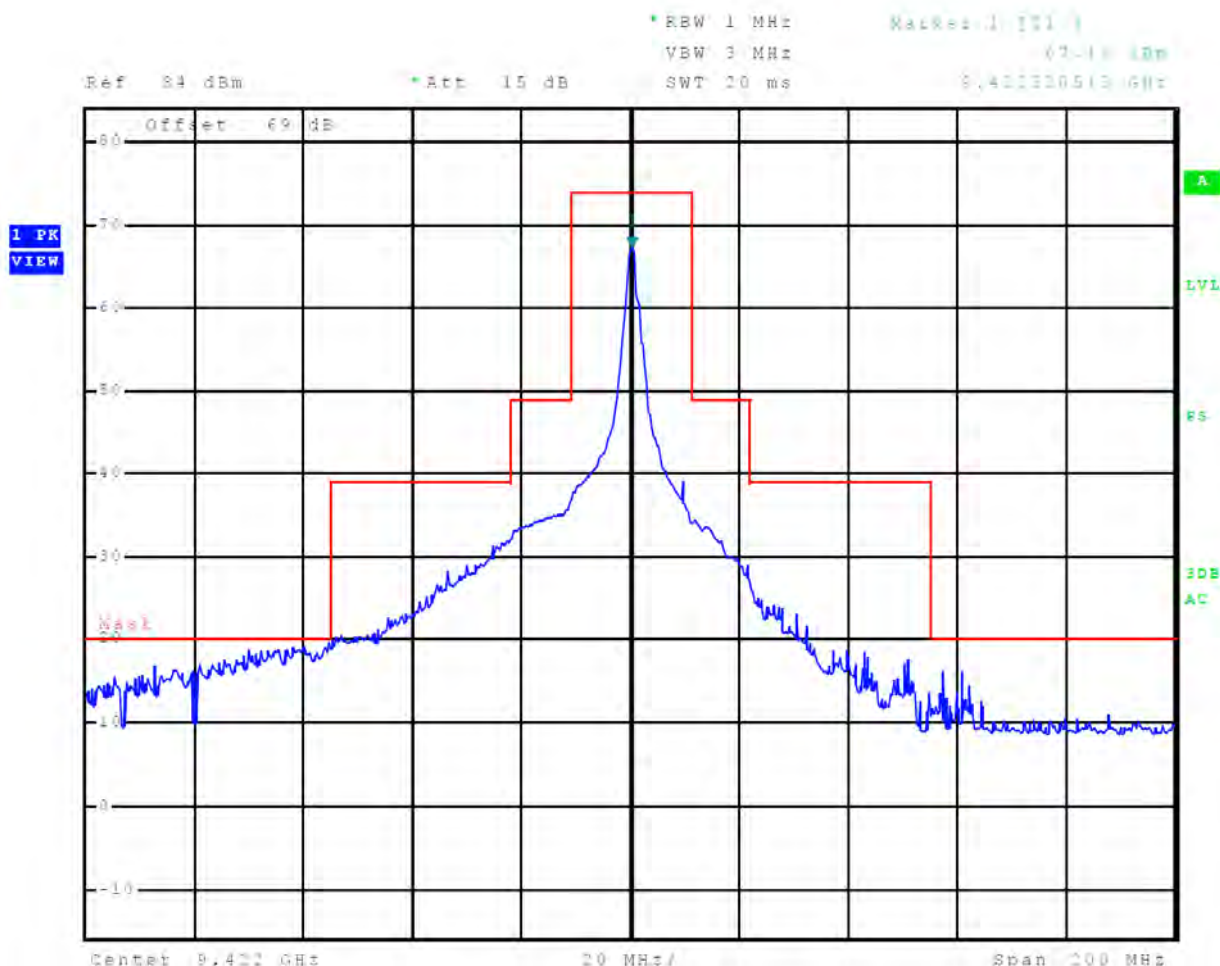

Figure 60 Emissions Mask, 72 nm

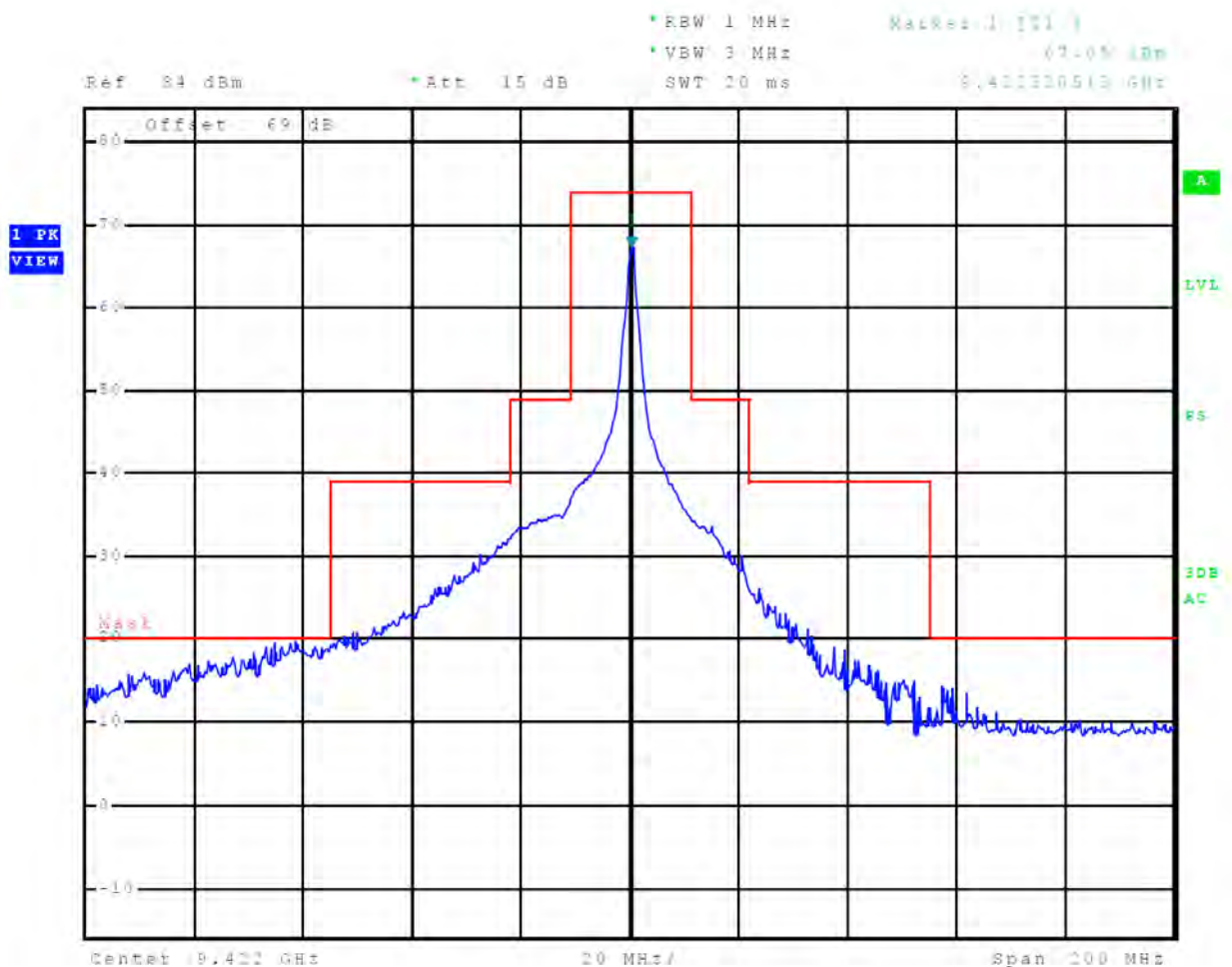
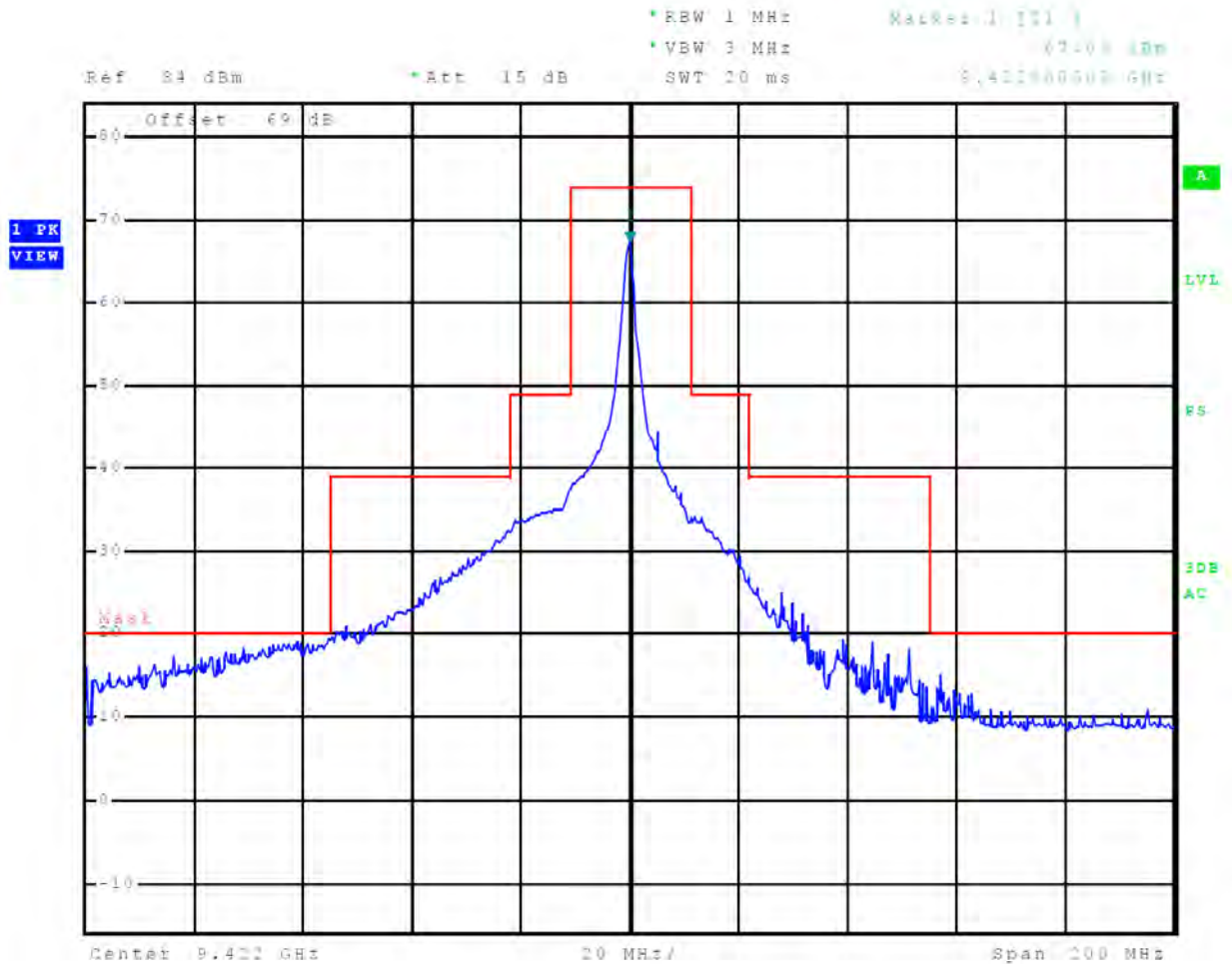

Figure 61 Emissions Mask, 96 nm





## TEST #6 Emission Limitations Out-of-Band

### Measurements Required

Transmitters used in the radio services governed by this part must comply with the emissions masks outlined in this section. Paragraph 80 and RSS-238 specify the out of band emission limitations for this equipment. The spurious emissions for the device were measured at the maximum output power condition.

### Test Arrangement

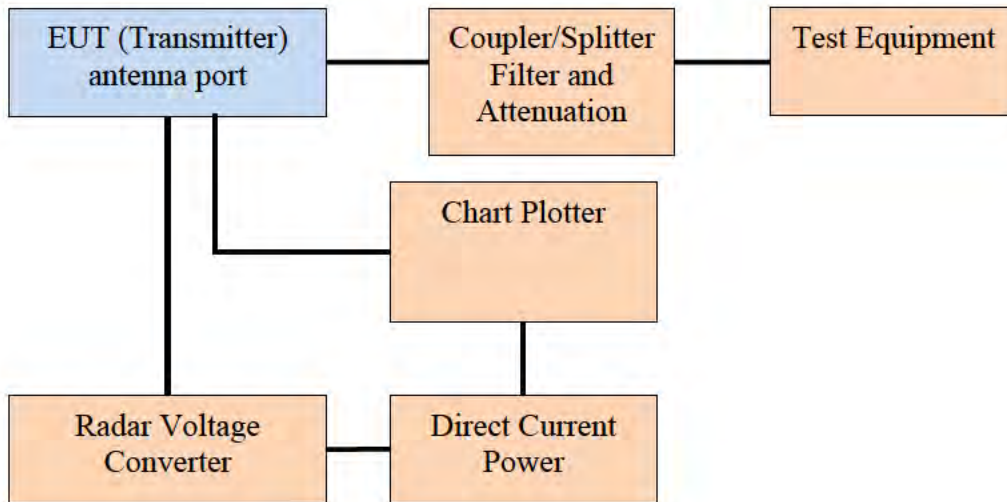

The radio frequency output was coupled to a Rohde &Schwarz ESU40 Spectrum Analyzer. The spectrum analyzer was used to observe the radio frequency spectrum with the transmitter operating through normal modes with maximum output power. The frequency spectrum at the band edges were observed and plots produced. Refer to figures 62 through 101 for plots presenting compliance with Out-of-Band emission requirements. Data was taken per 47CFR 2.1051, applicable parts of Part 80 and RSS-238.



Figure 62 Out-of-Band Emissions 1/16 nm

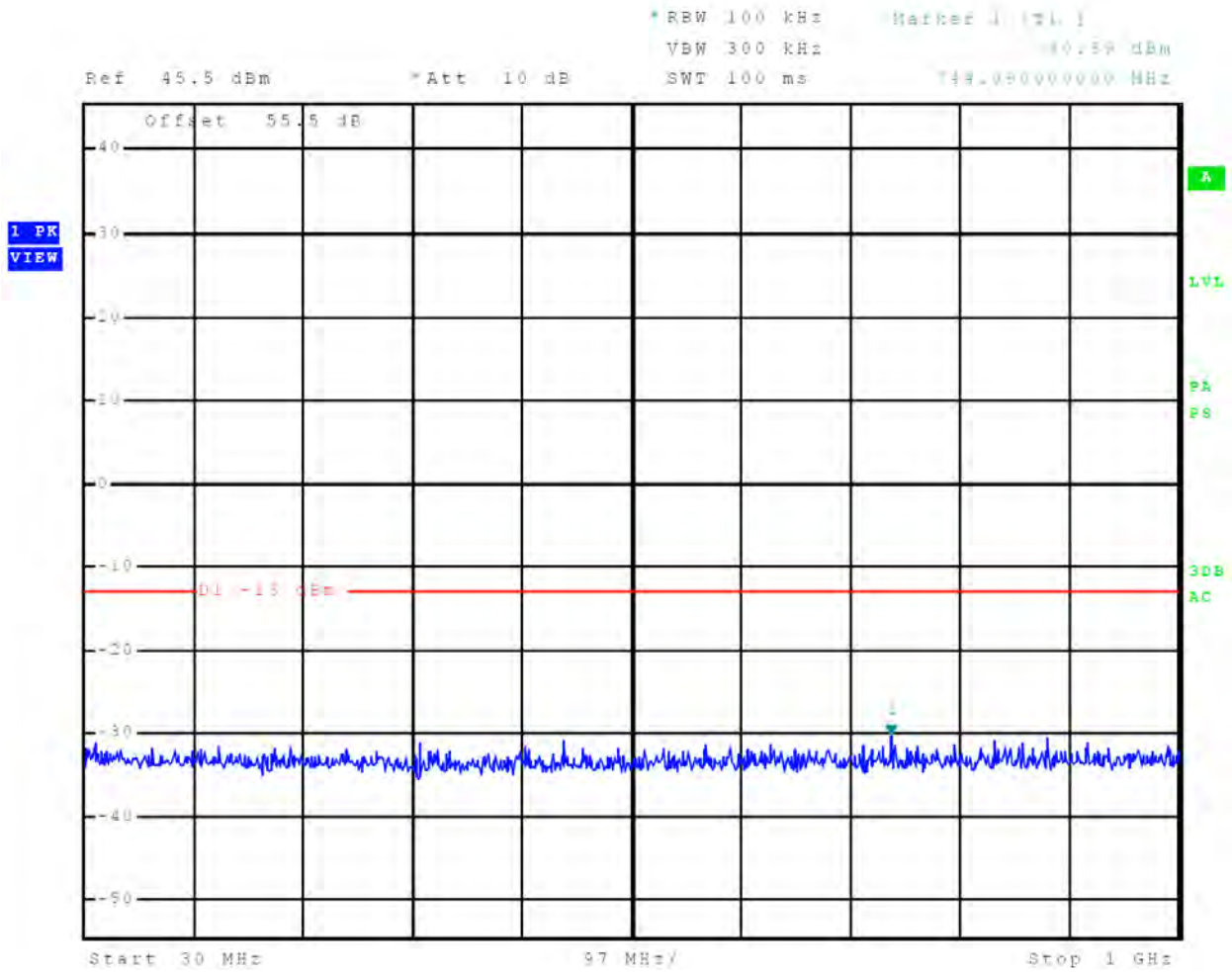

Figure 63 Out-of-Band Emissions 1/16 nm

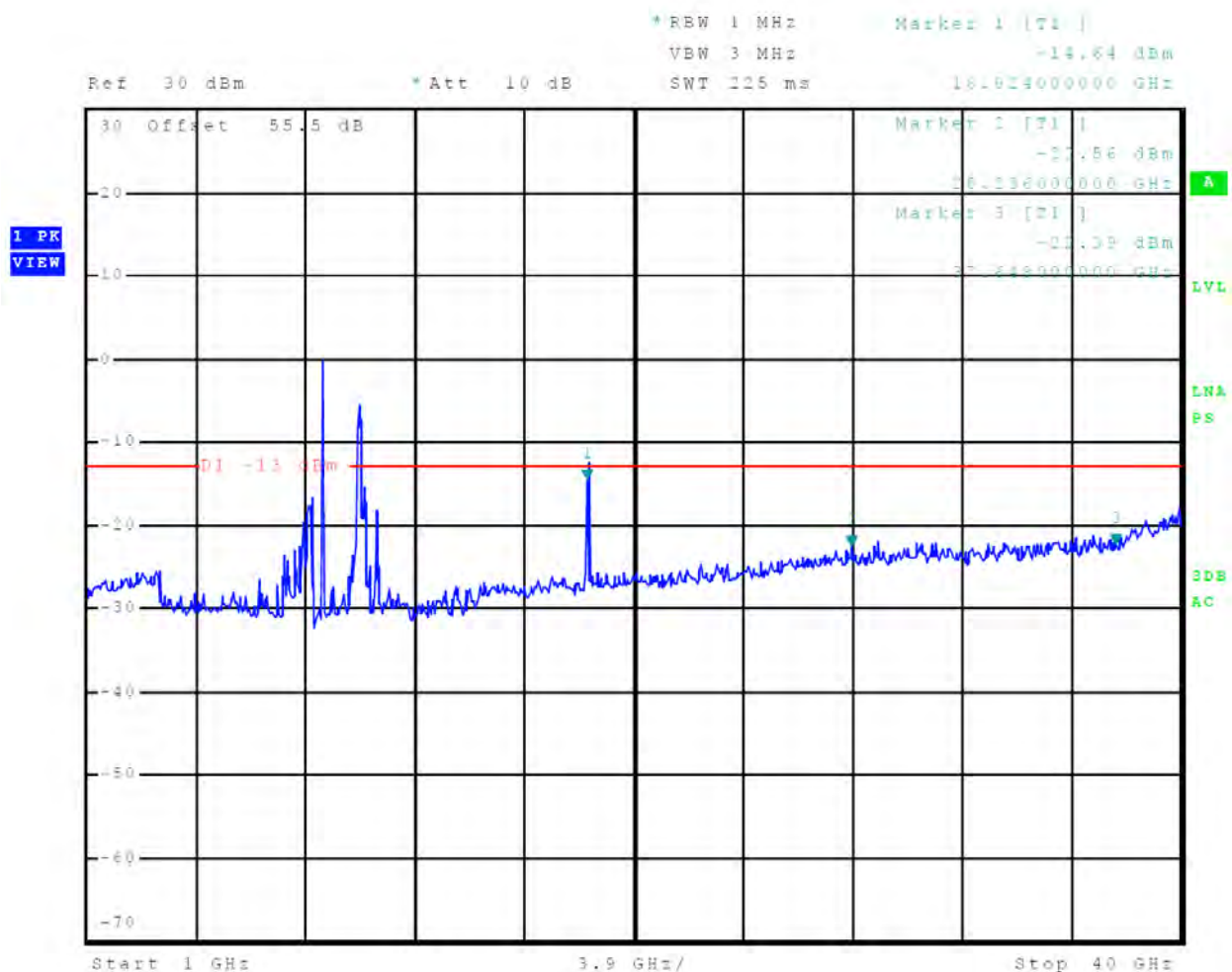

Figure 64 Out-of-Band Emissions 1/8 nm

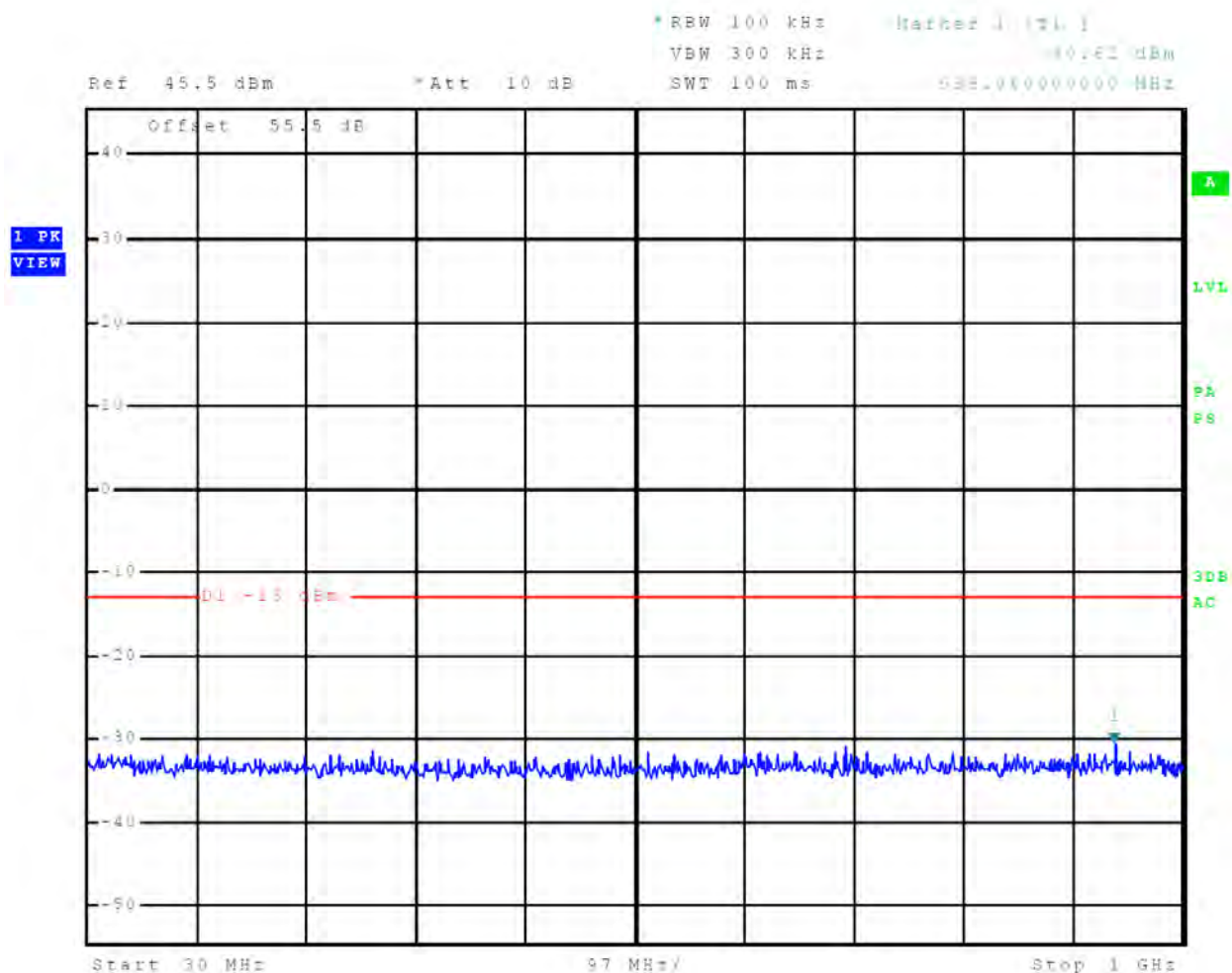

Figure 65 Out-of-Band Emissions 1/8 nm

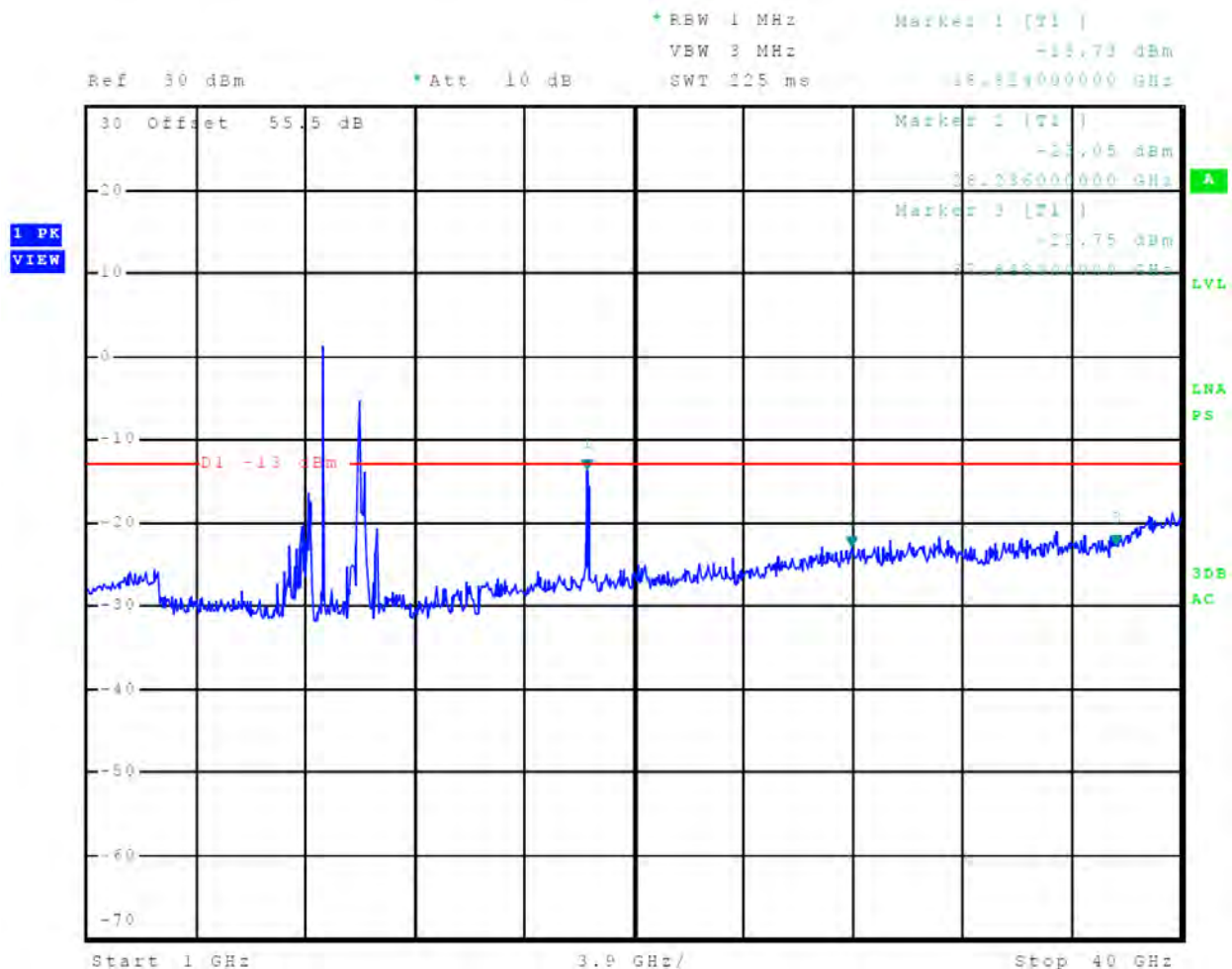

Figure 66 Out-of-Band Emissions 1/4 nm

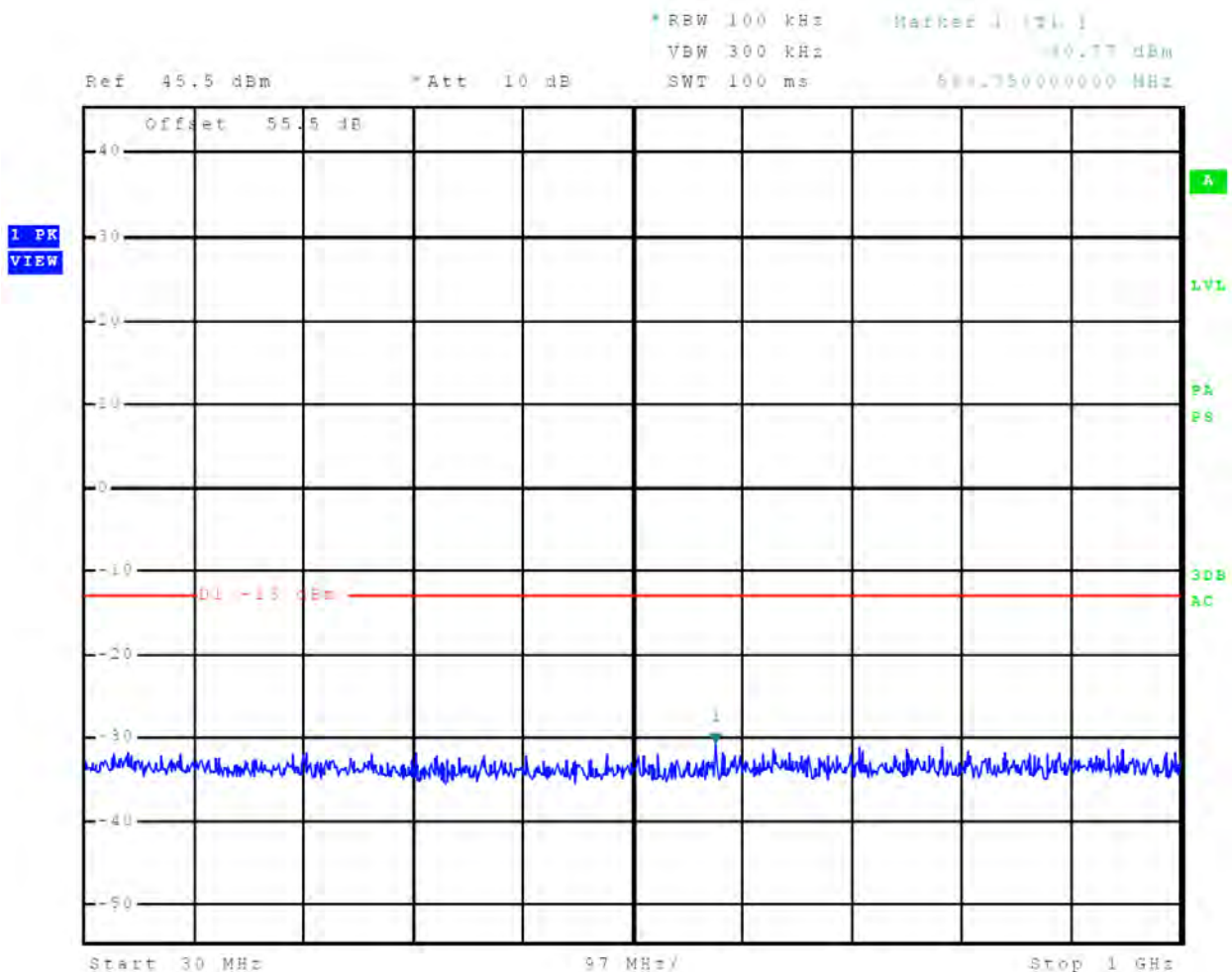

Figure 67 Out-of-Band Emissions 1/4 nm

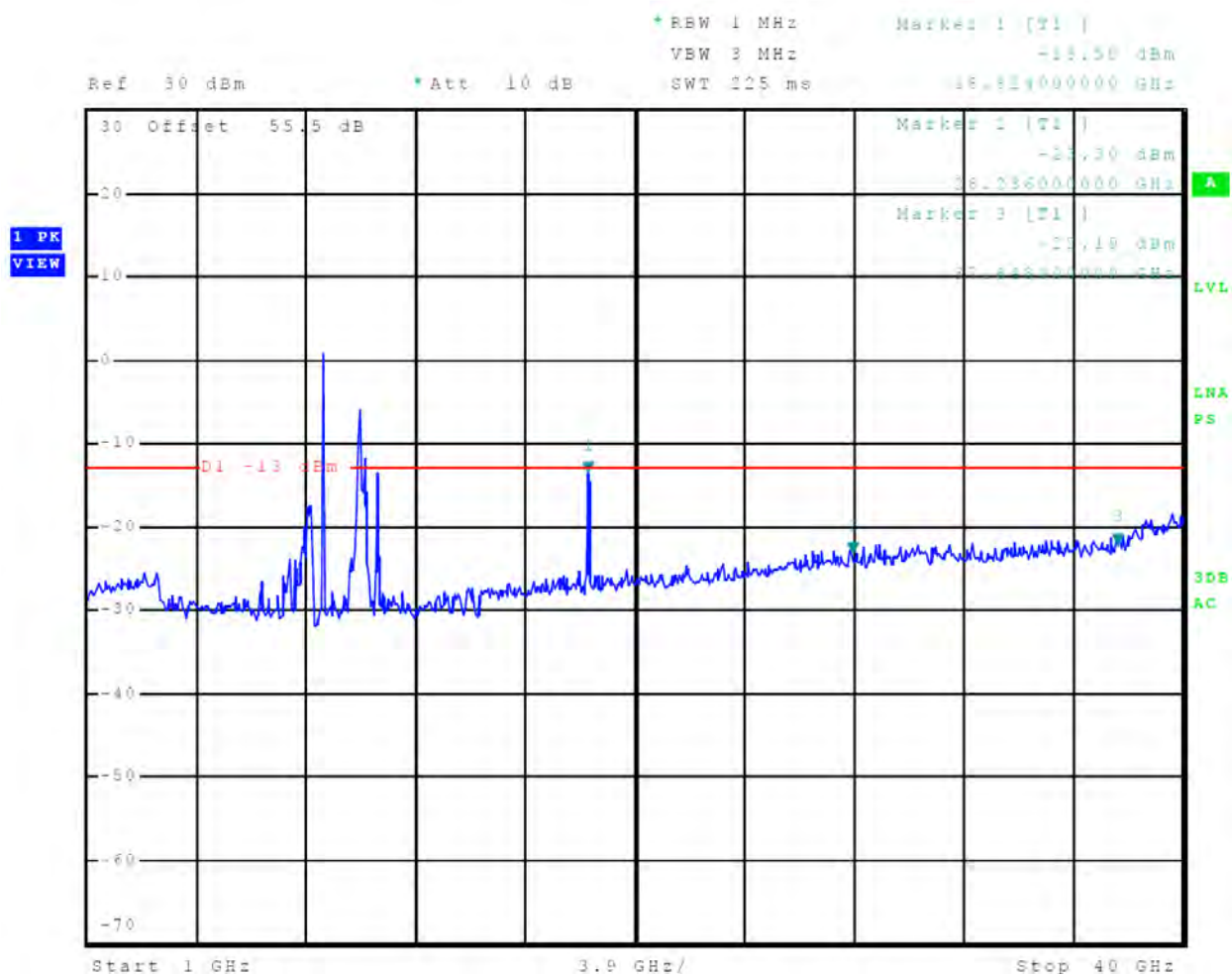



Figure 68 Out-of-Band Emissions 1/2 nm

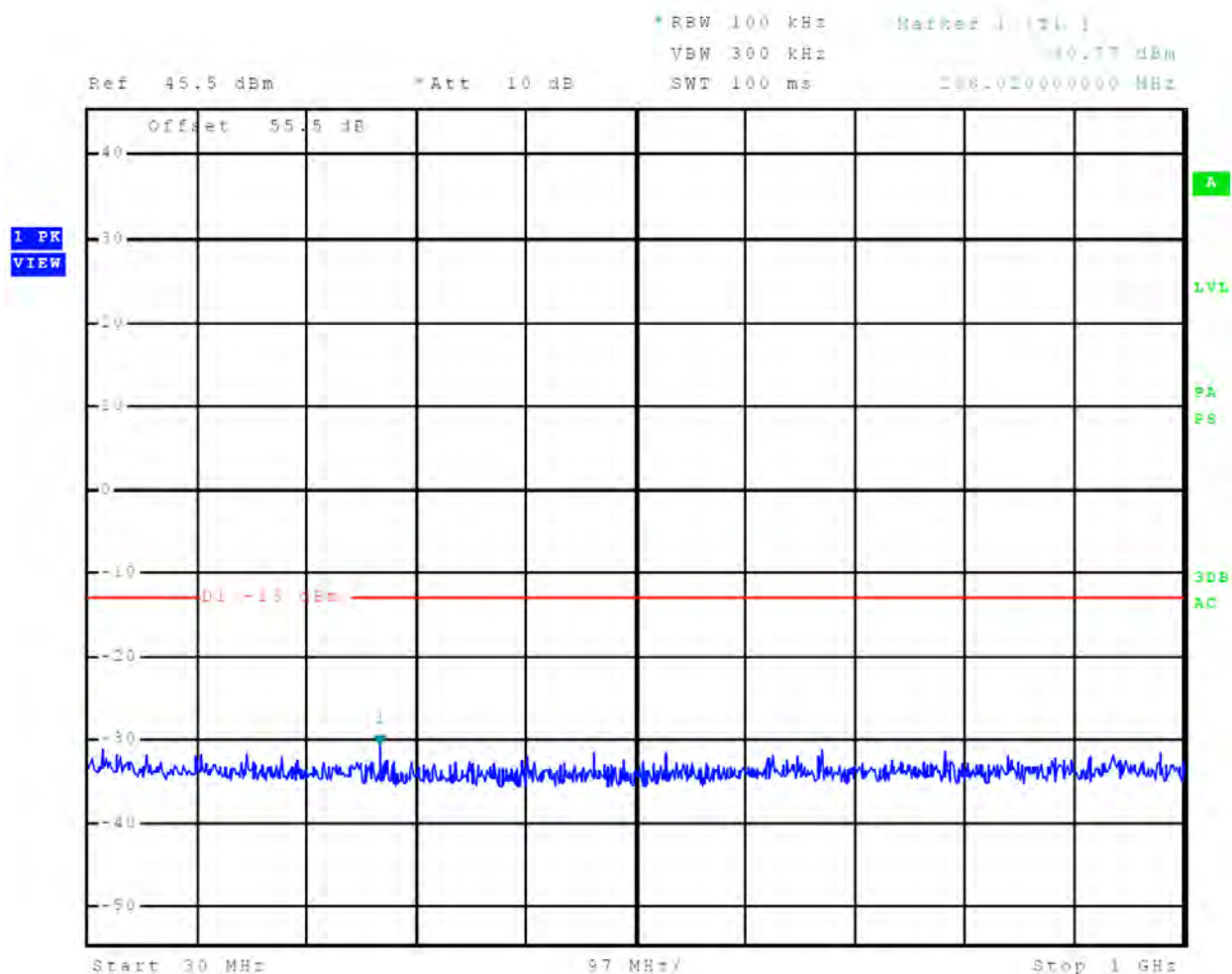

Figure 69 Out-of-Band Emissions 1/2 nm

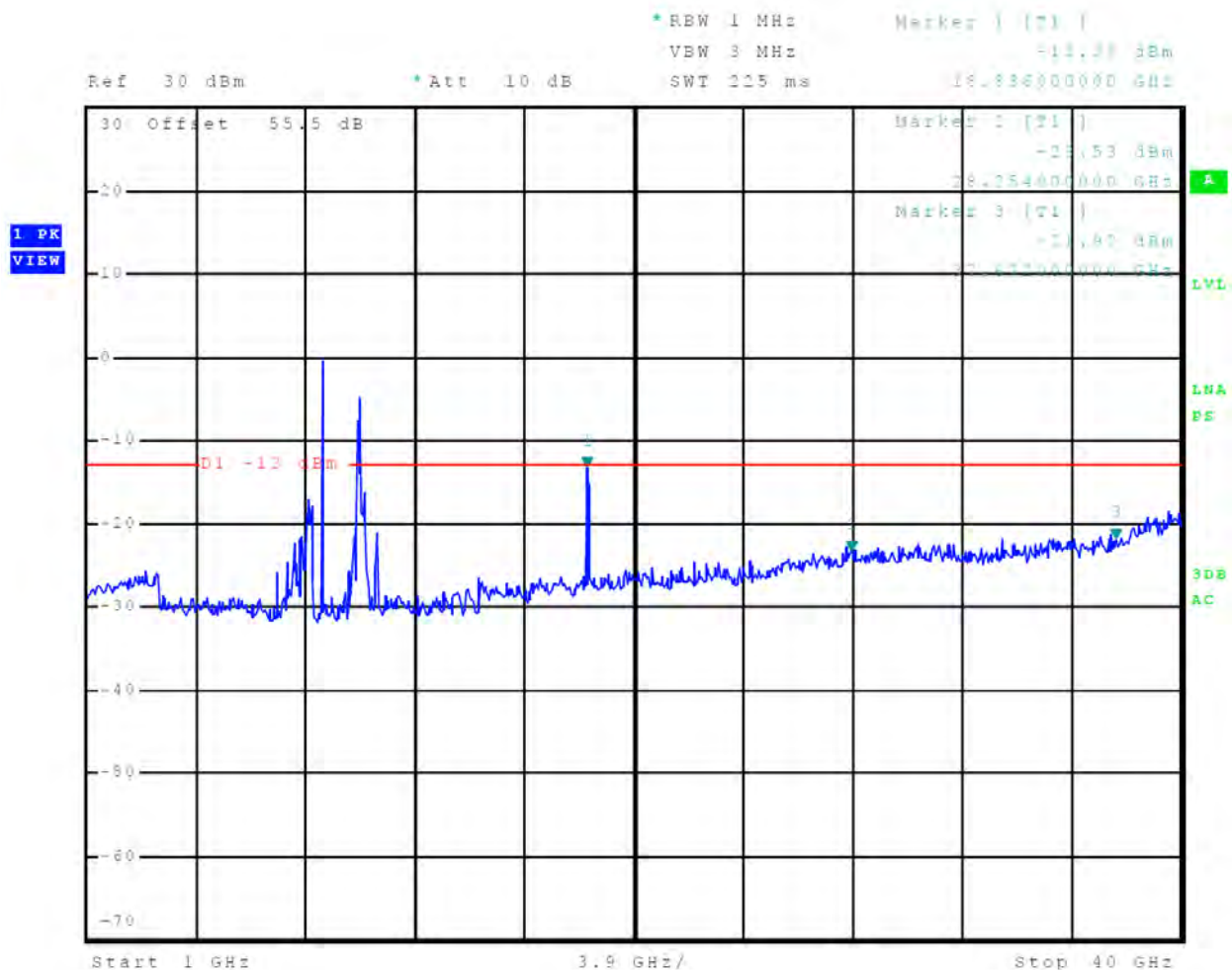

Figure 70 Out-of-Band Emissions 3/4 nm

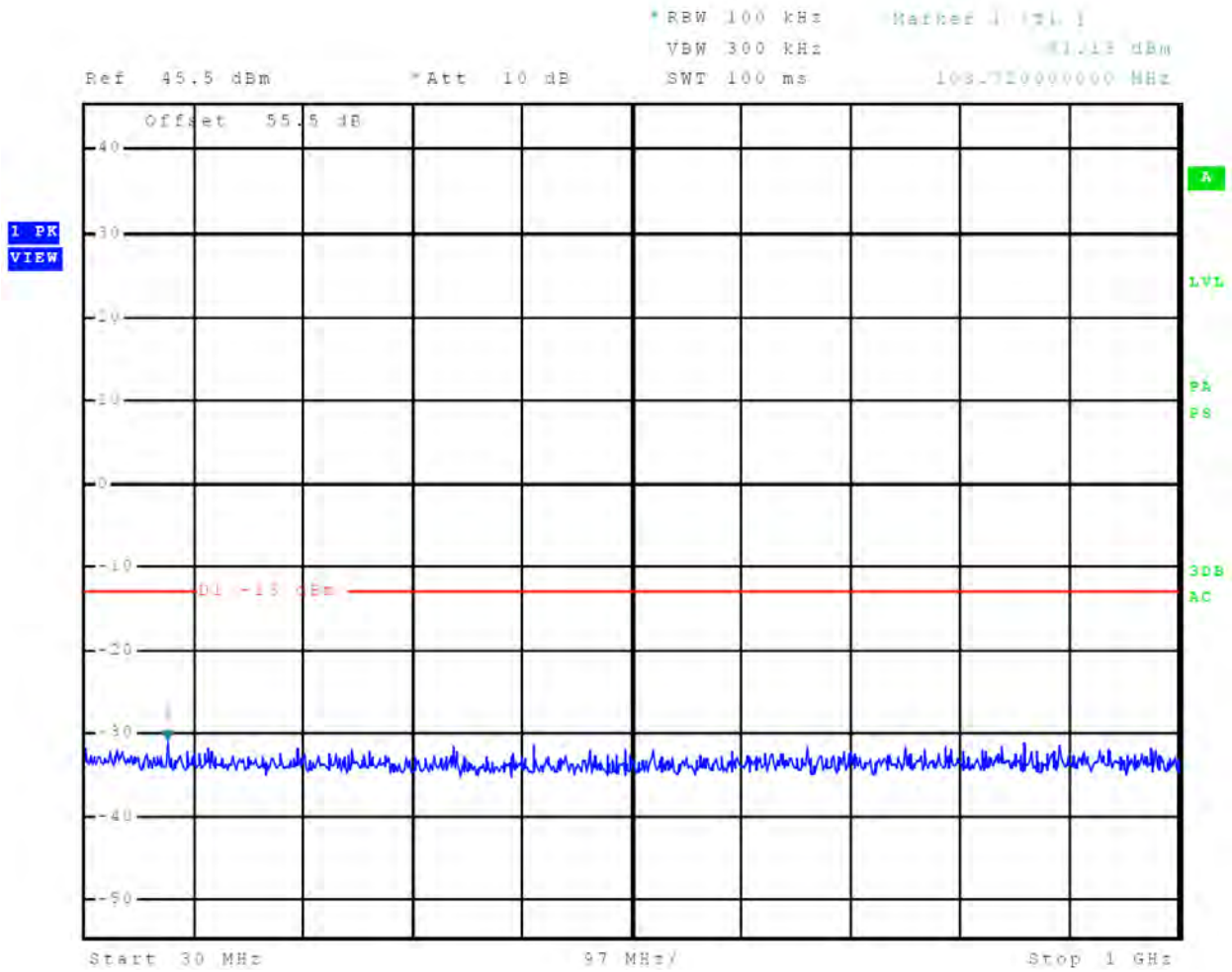

Figure 71 Out-of-Band Emissions 3/4 nm

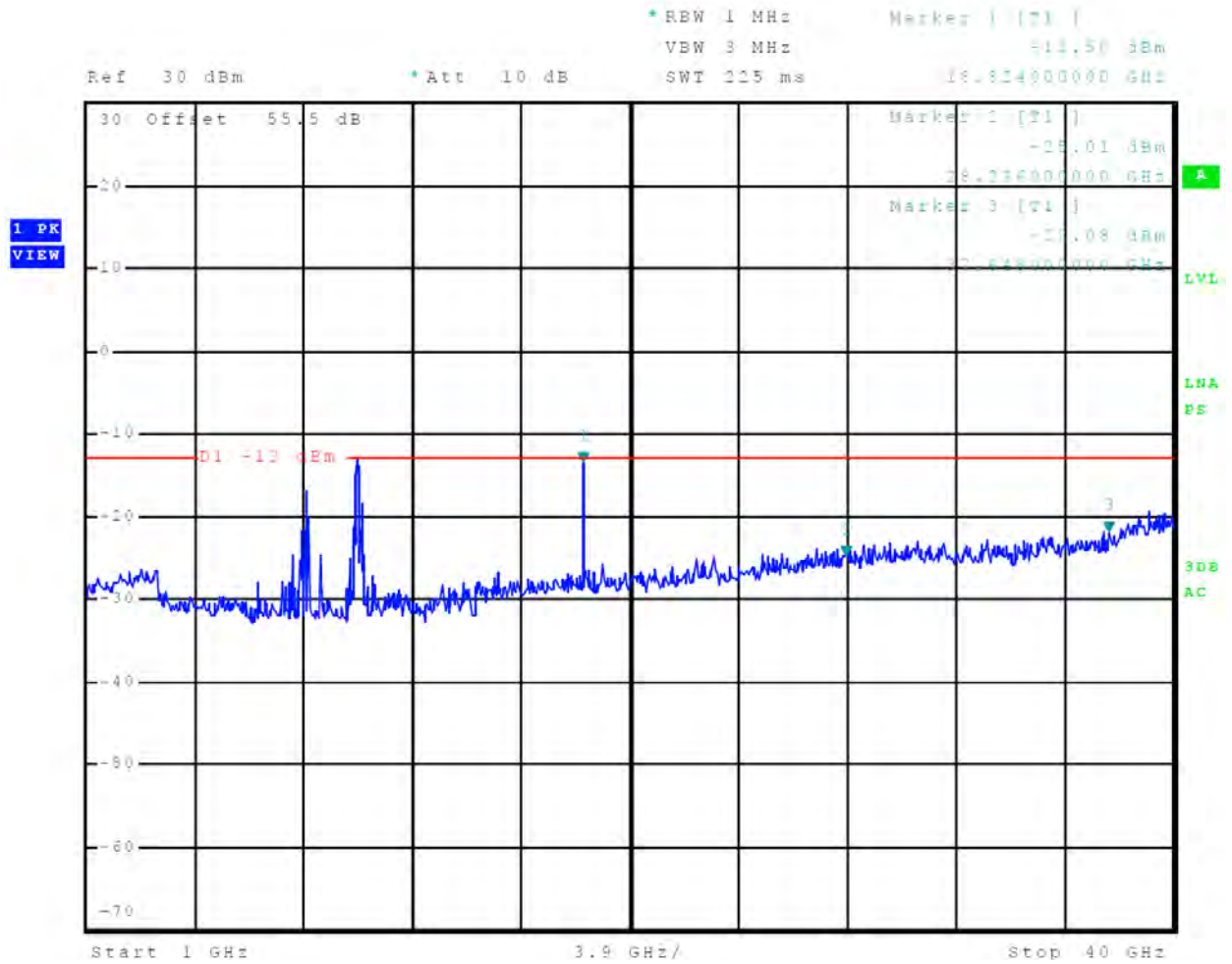

Figure 72 Out-of-Band Emissions 1 nm

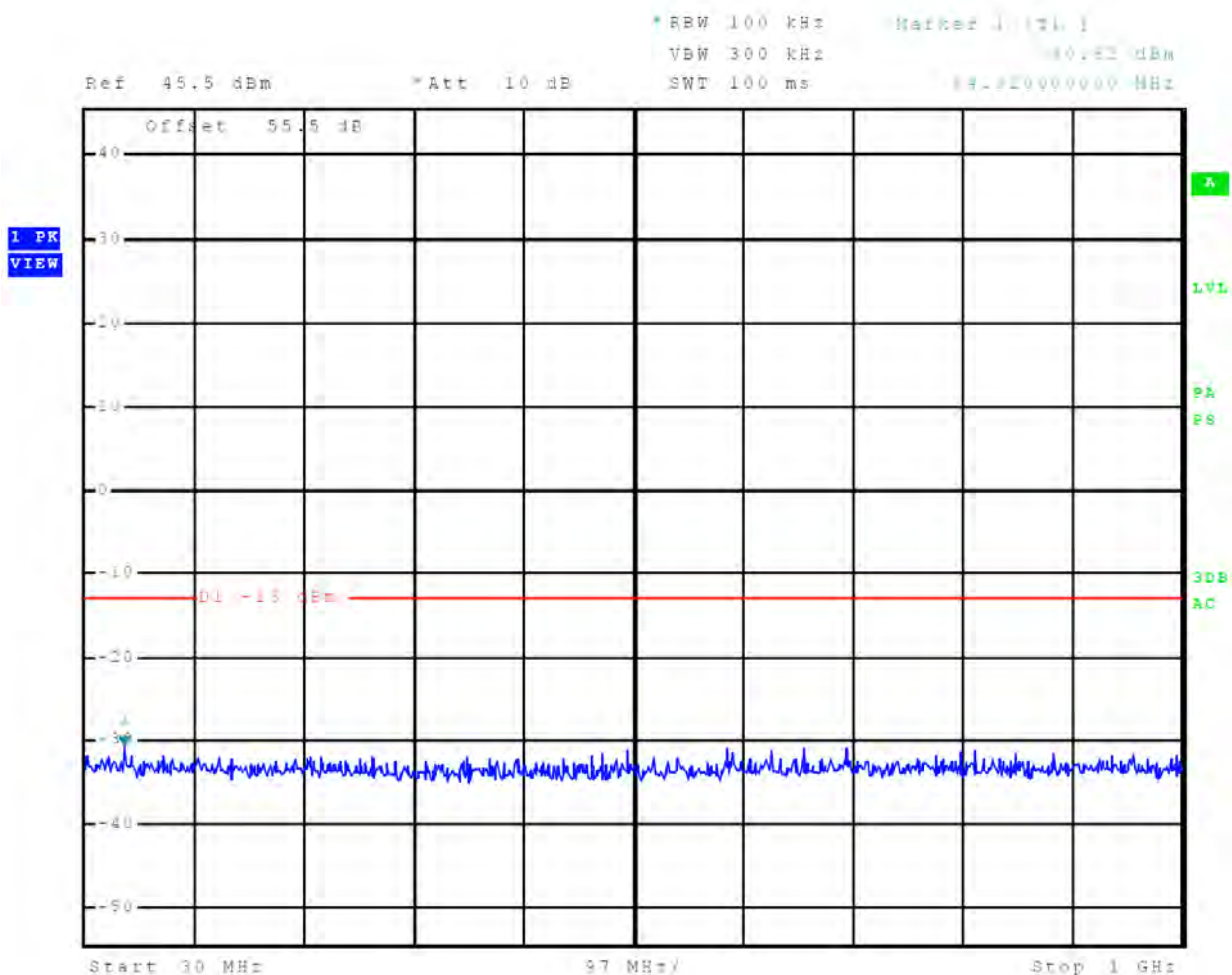

Figure 73 Out-of-Band Emissions 1 nm

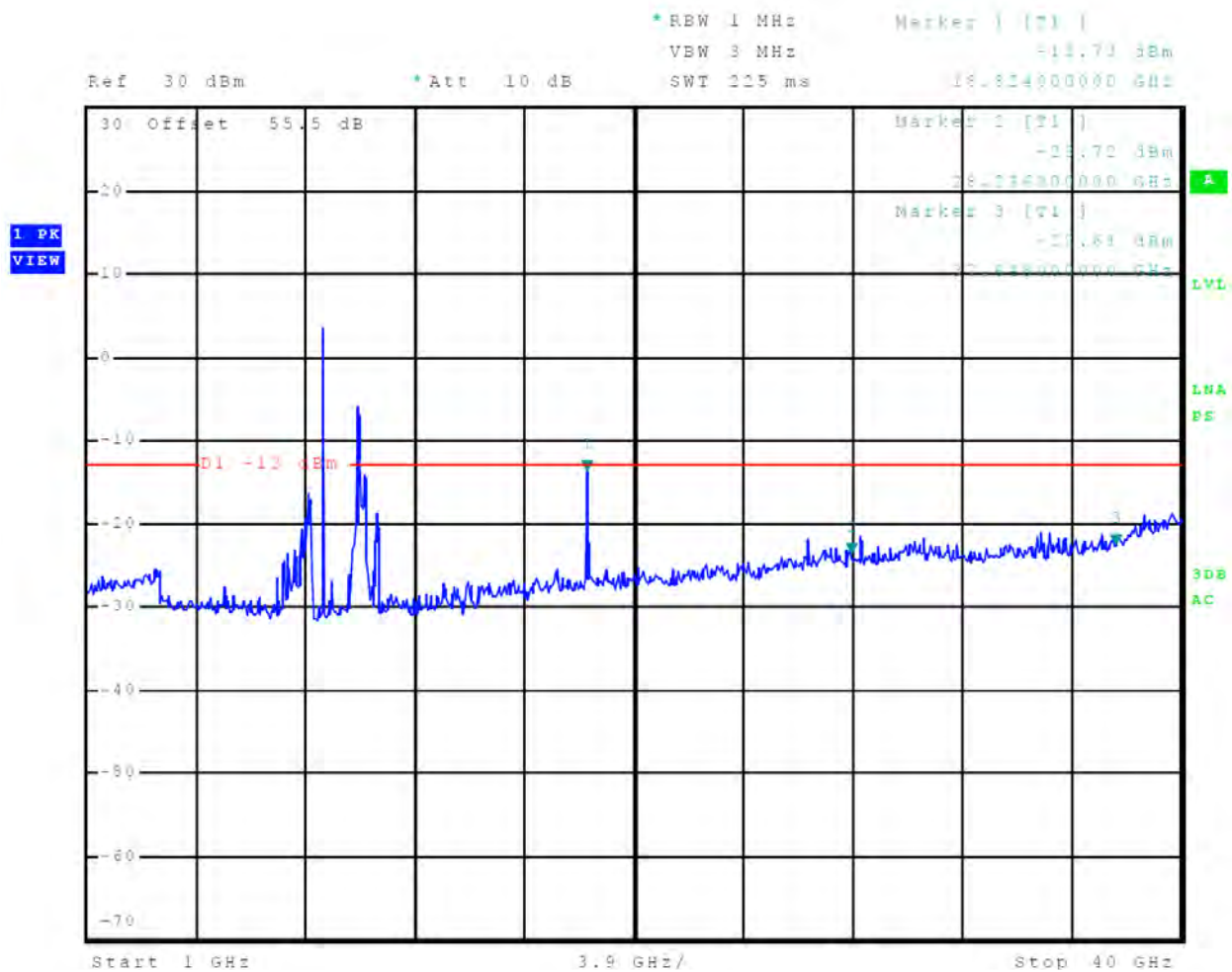



Figure 74 Out-of-Band Emissions 1.5 nm

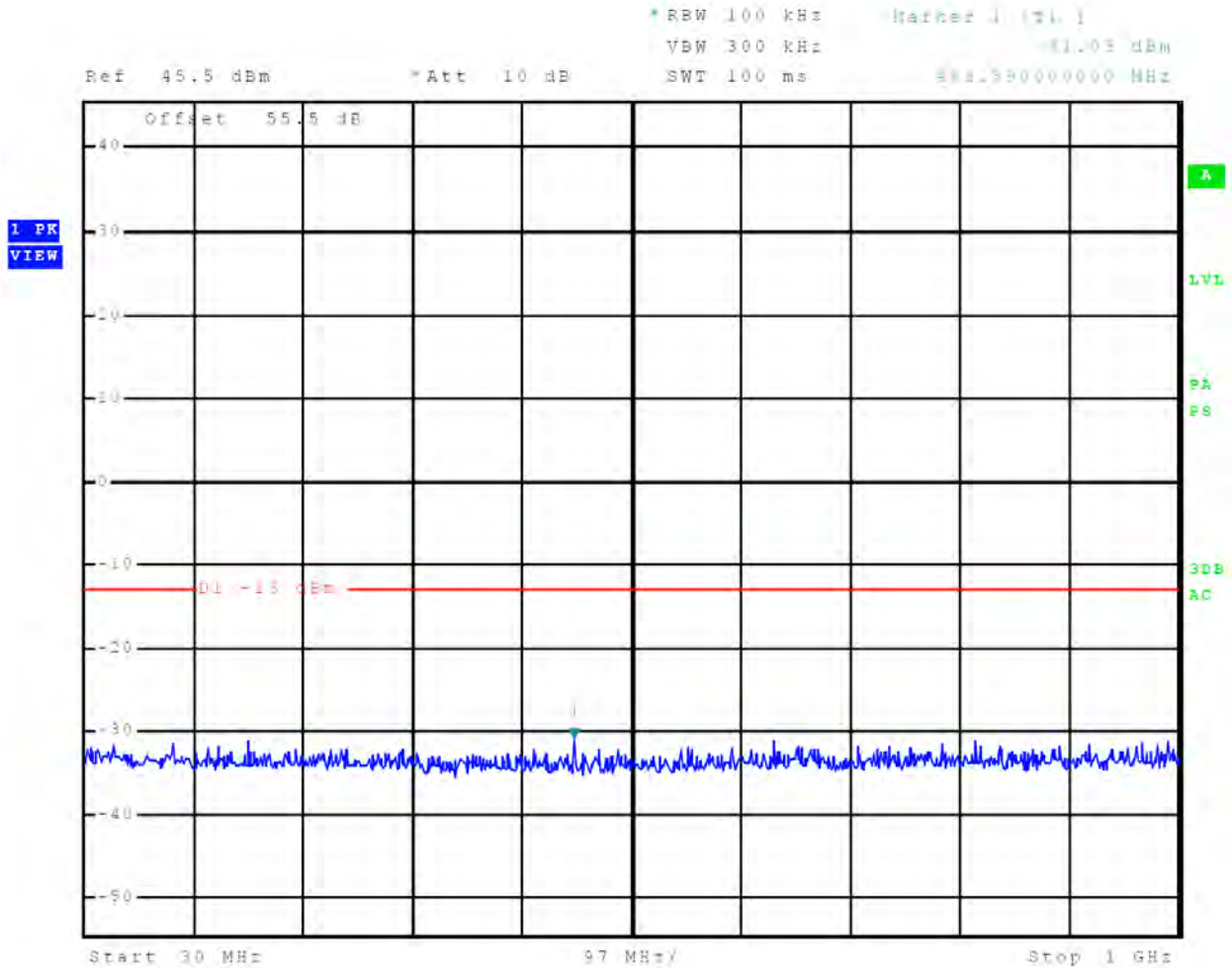

Figure 75 Out-of-Band Emissions 1.5 nm

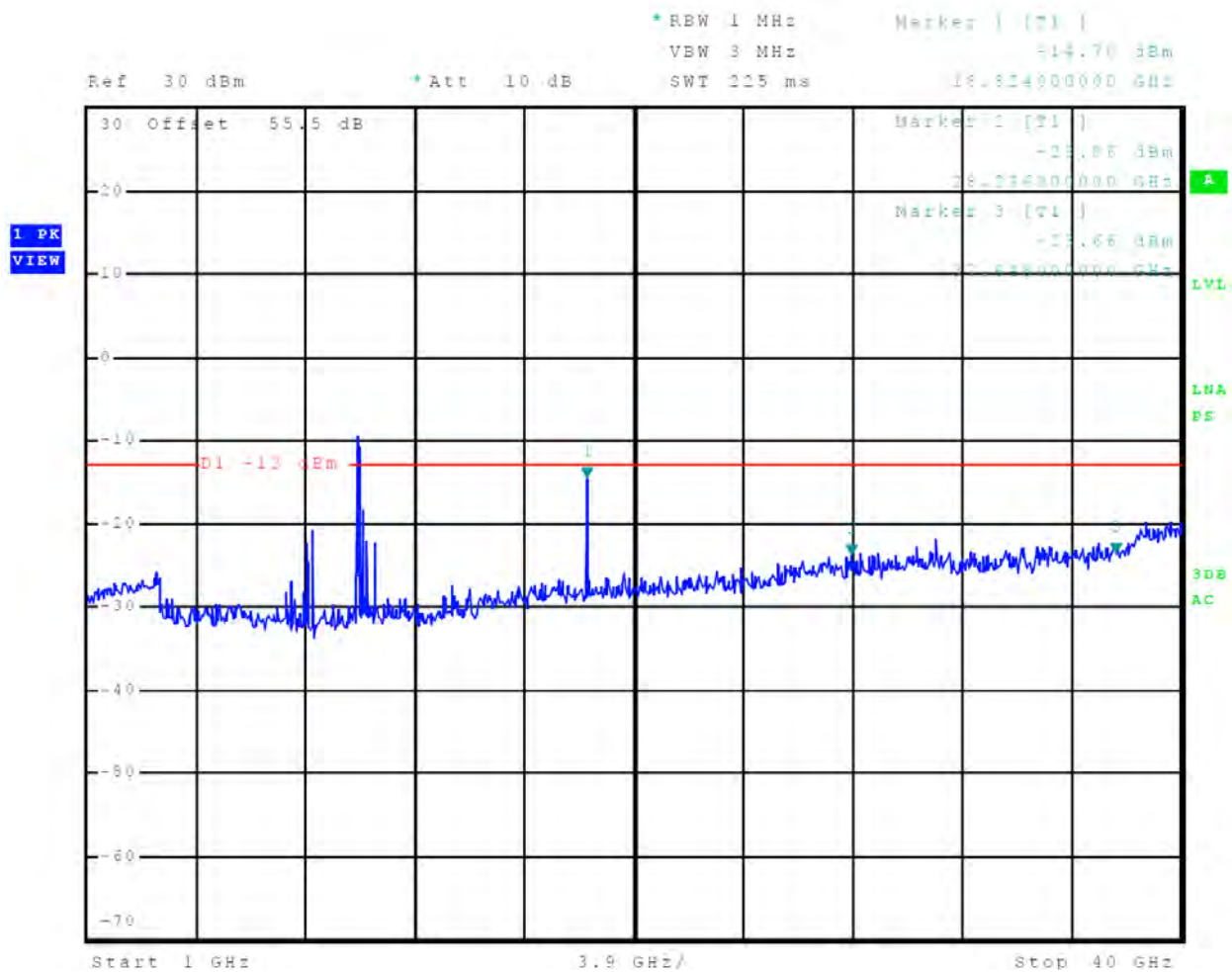

Figure 76 Out-of-Band Emissions 2 nm

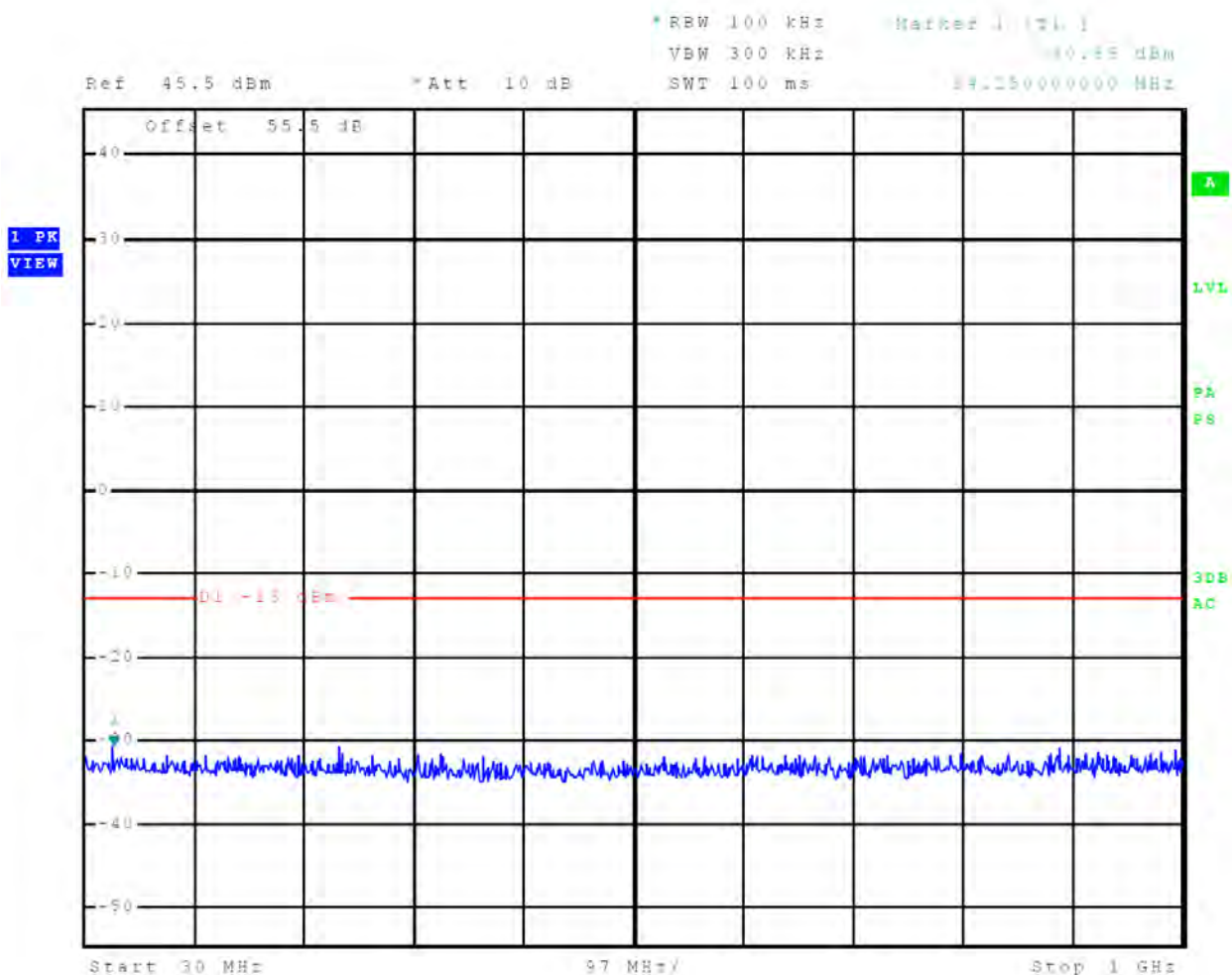

Figure 77 Out-of-Band Emissions 2 nm

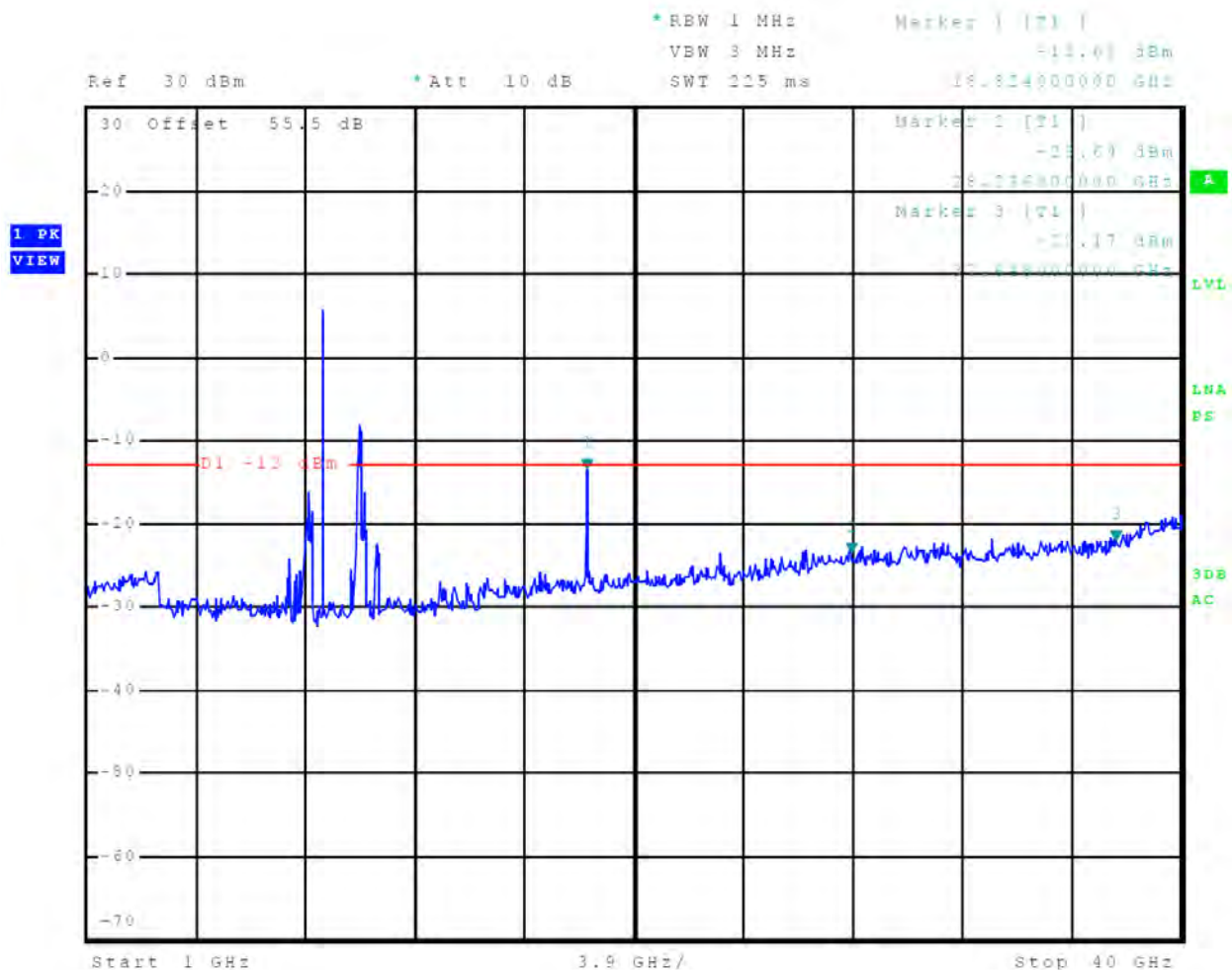

Figure 78 Out-of-Band Emissions 3 nm

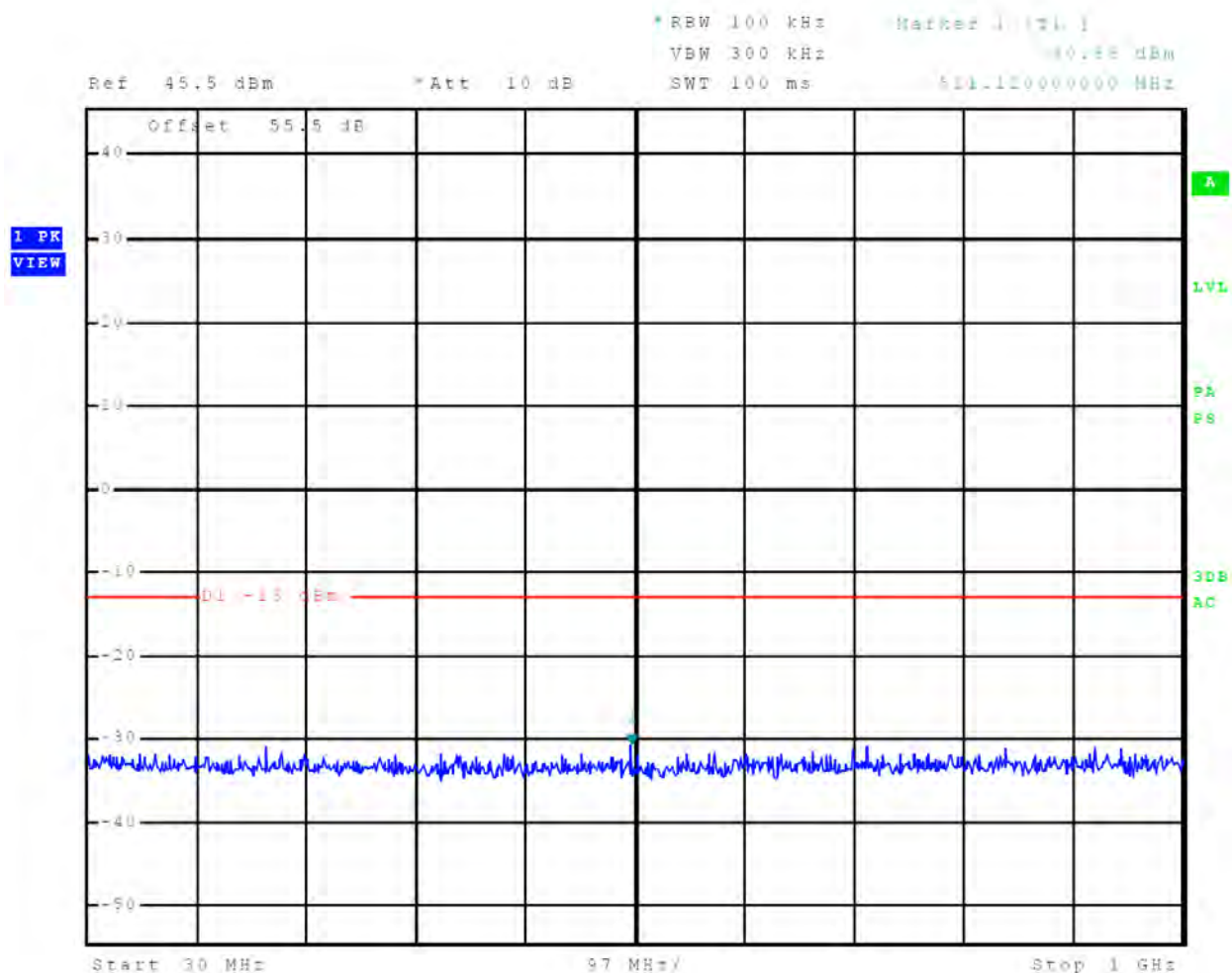

Figure 79 Out-of-Band Emissions 3 nm

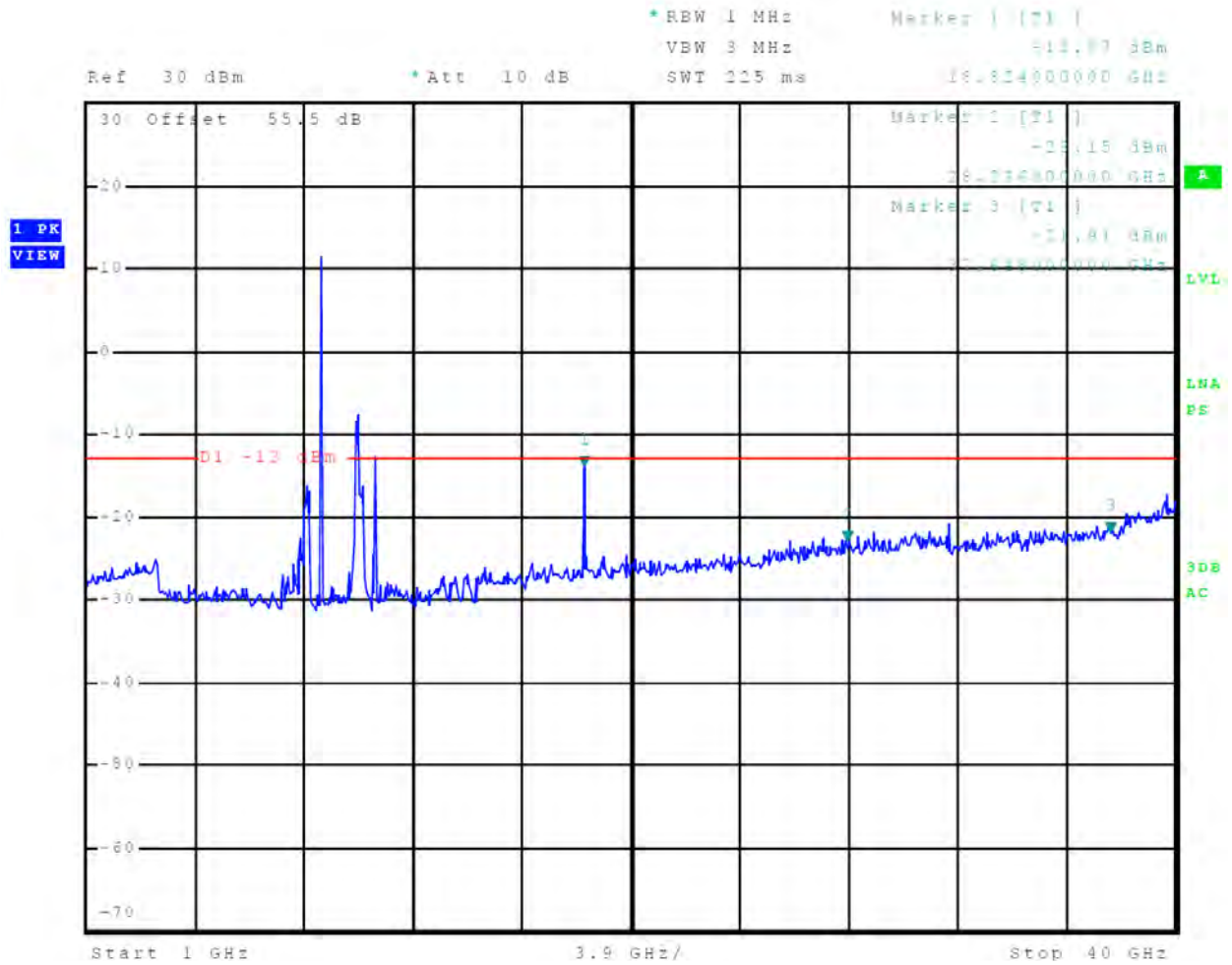





Figure 81 Out-of-Band Emissions 4 nm

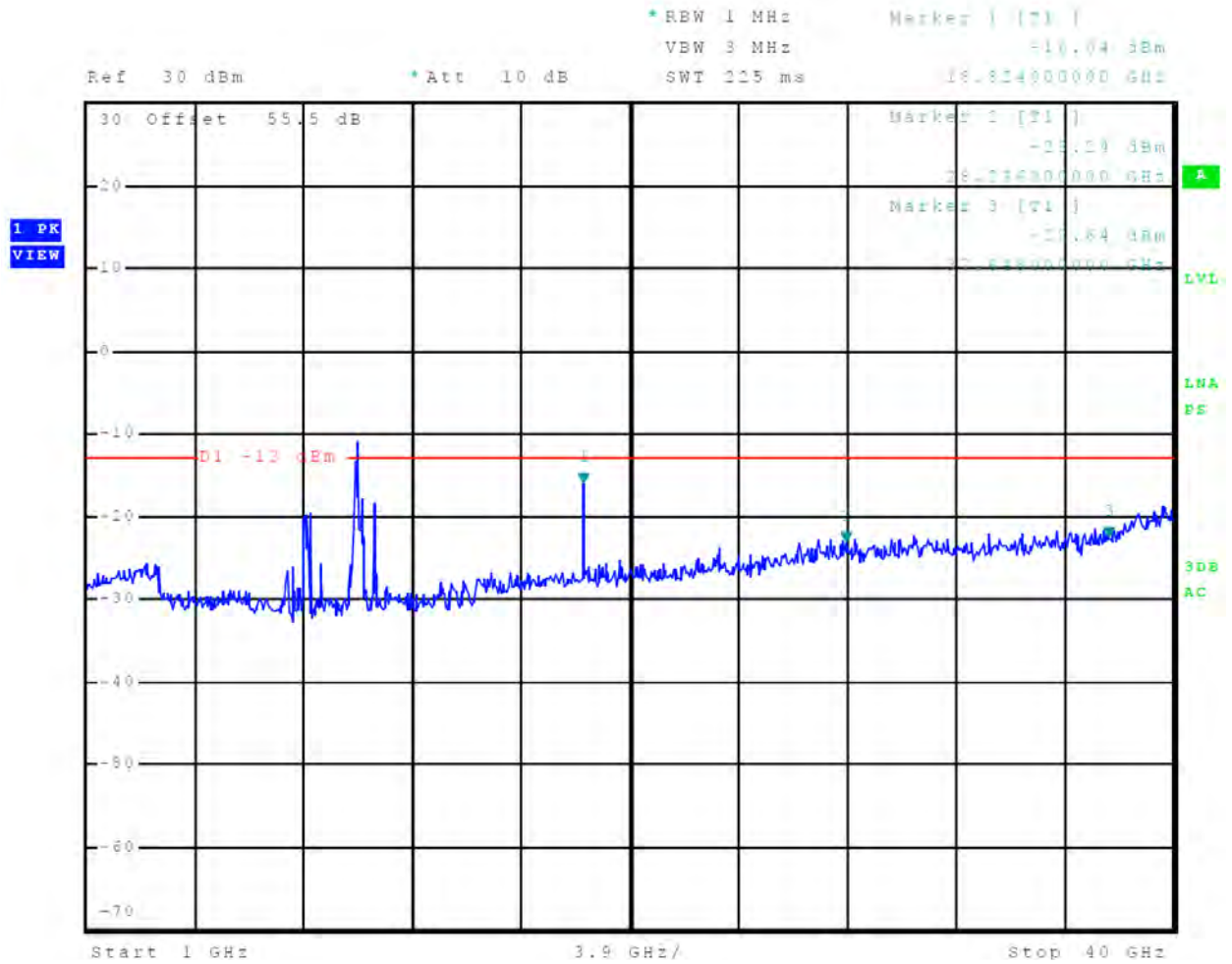

Figure 82 Out-of-Band Emissions 6 nm

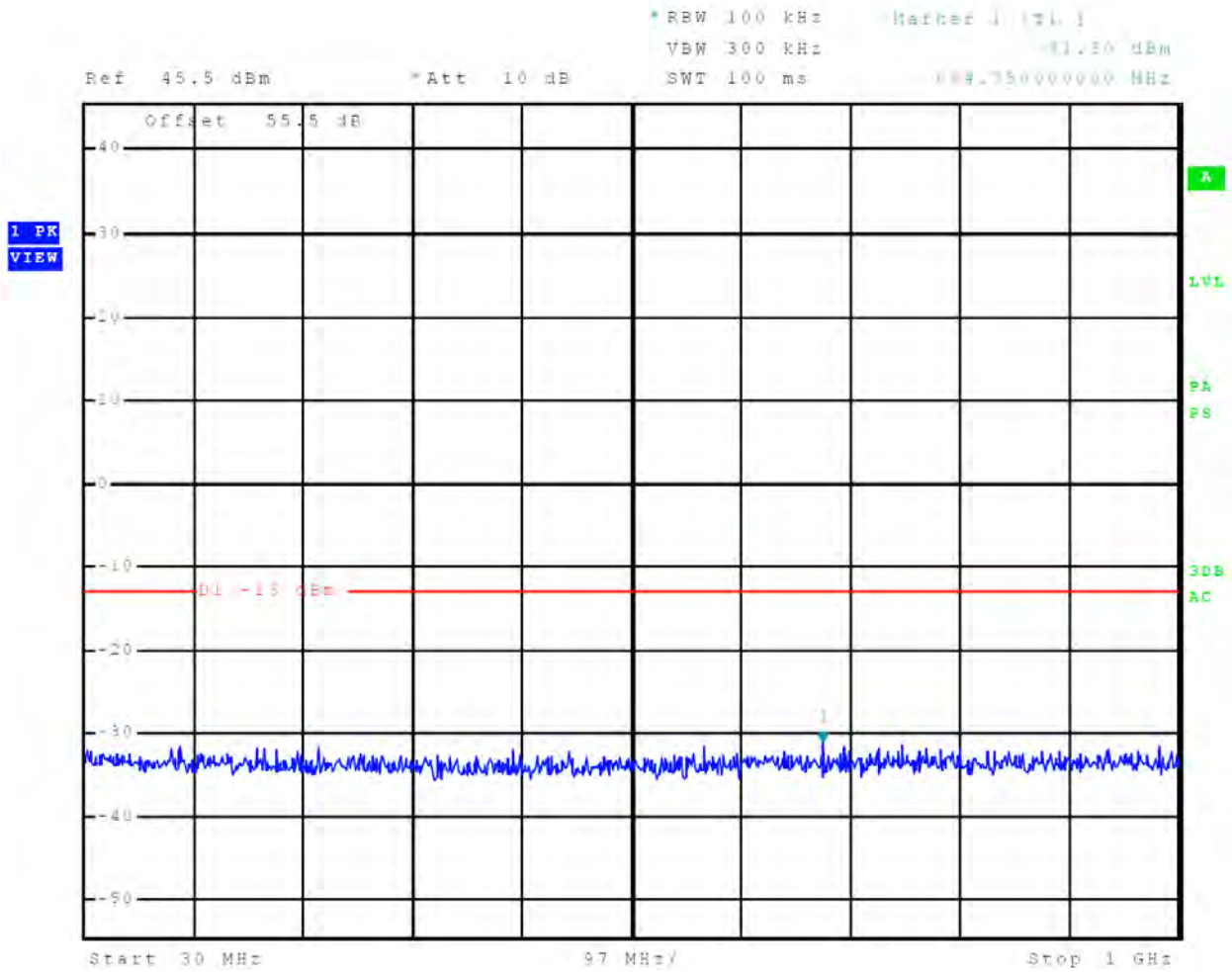

Figure 83 Out-of-Band Emissions 6 nm

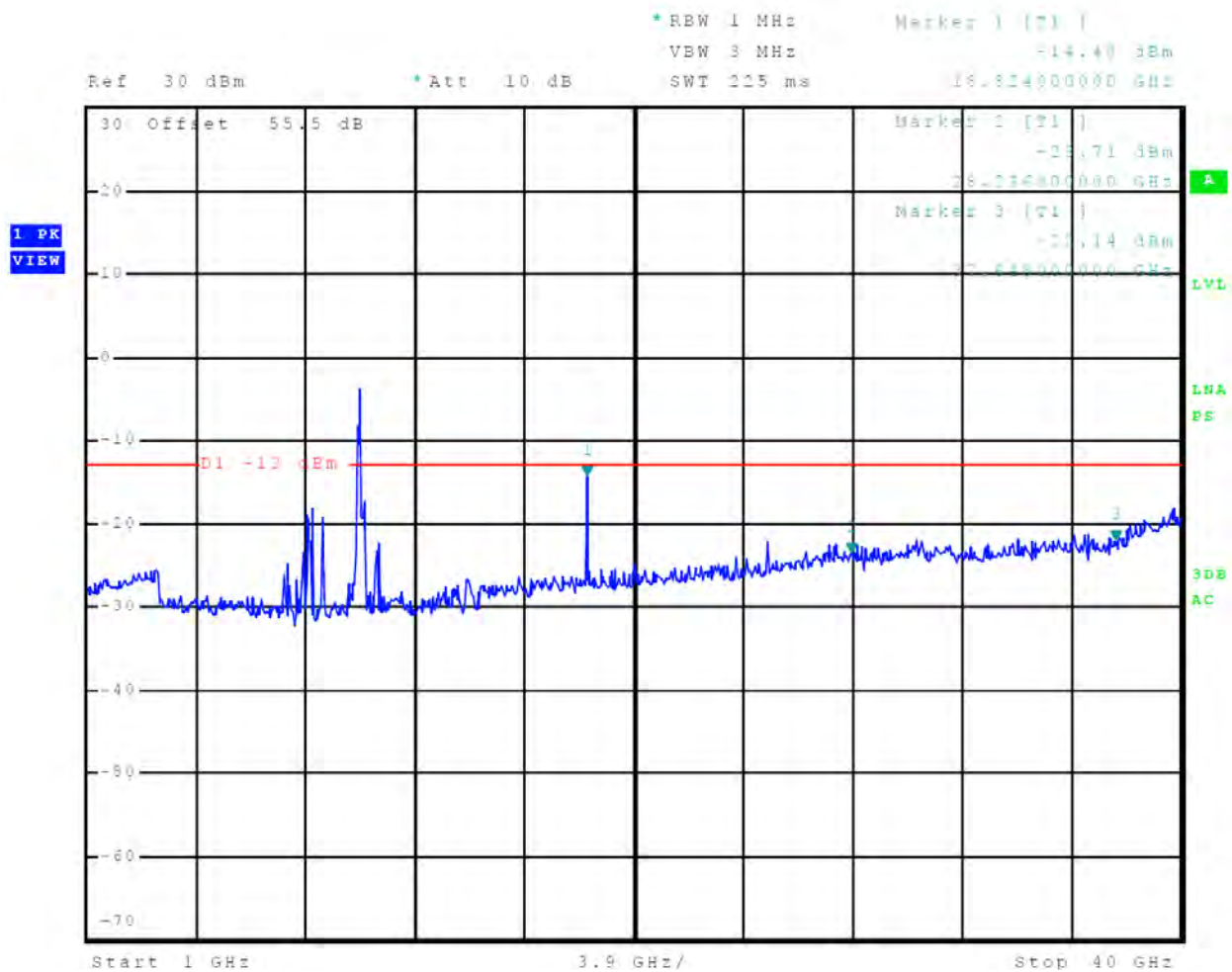

Figure 84 Out-of-Band Emissions 8 nm

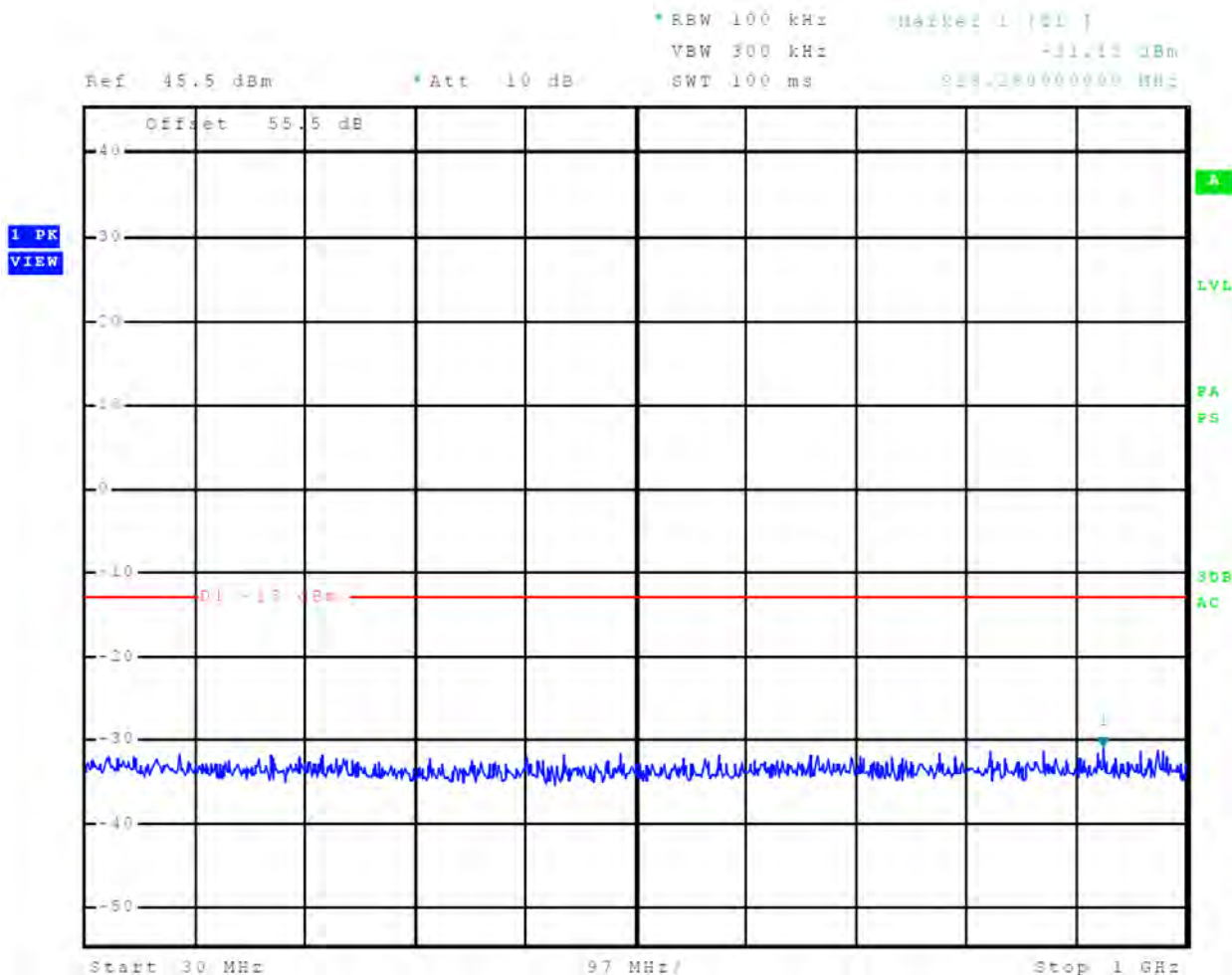

Figure 85 Out-of-Band Emissions 8 nm

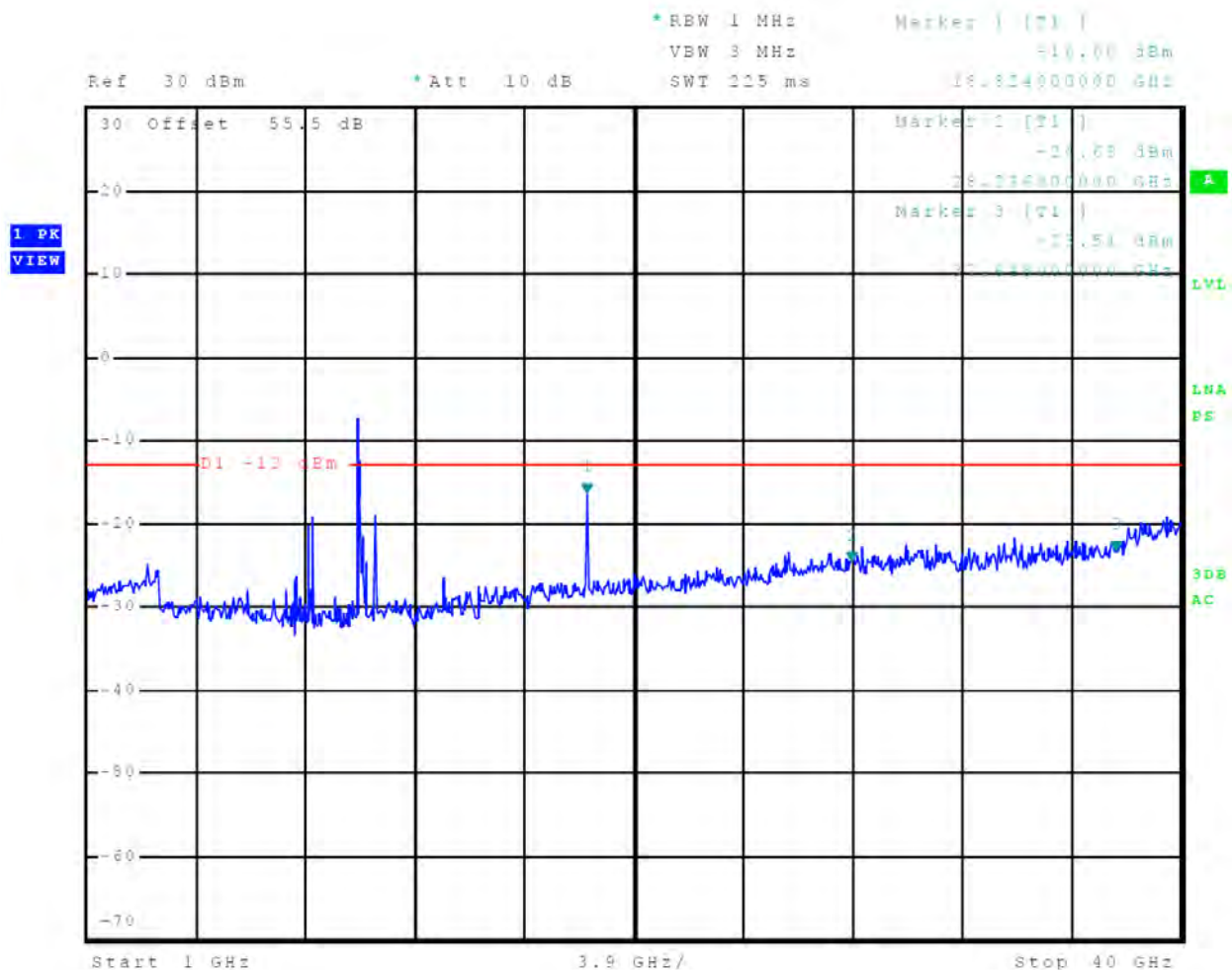



Figure 86 Out-of-Band Emissions 12 nm

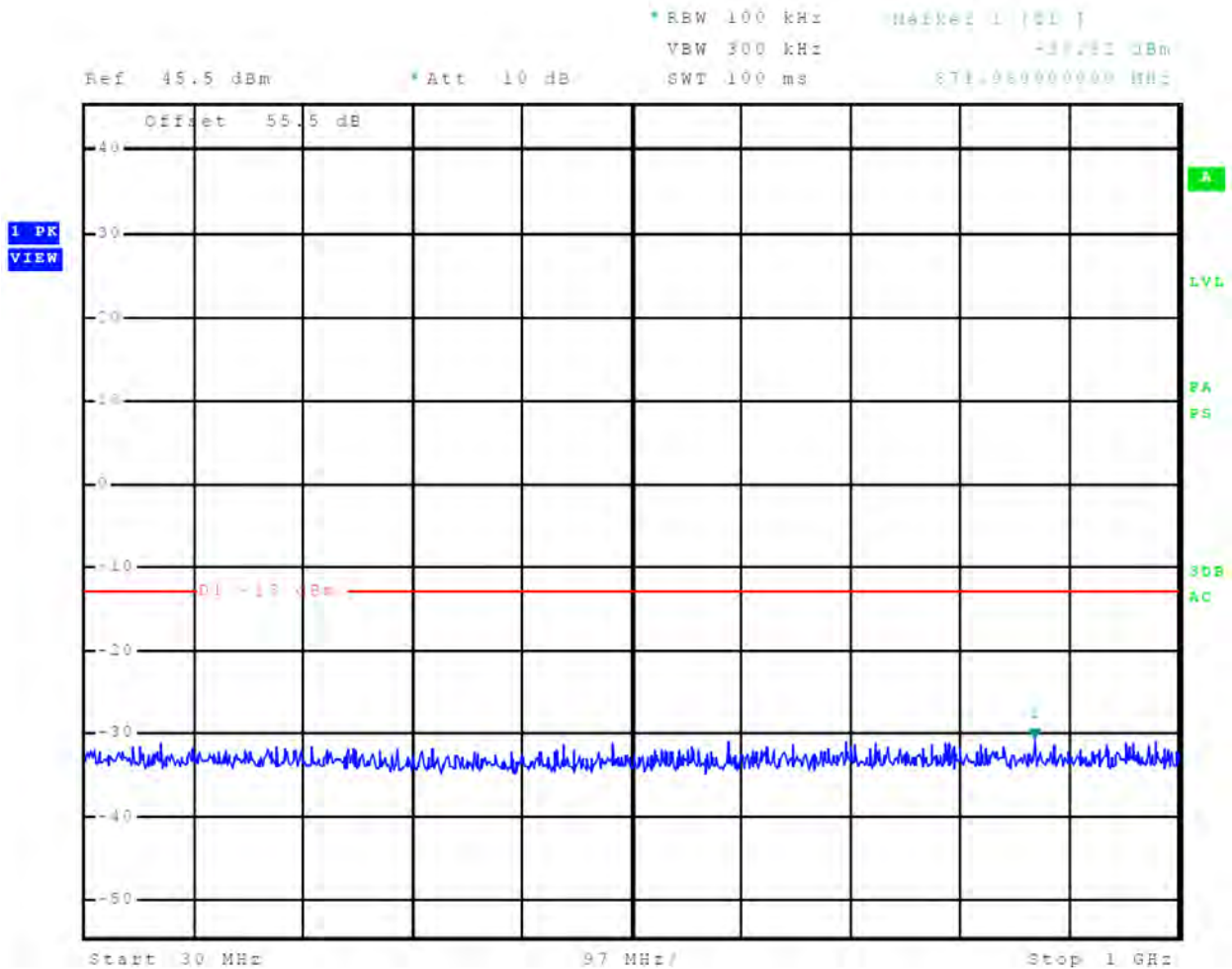

Figure 87 Out-of-Band Emissions 12 nm

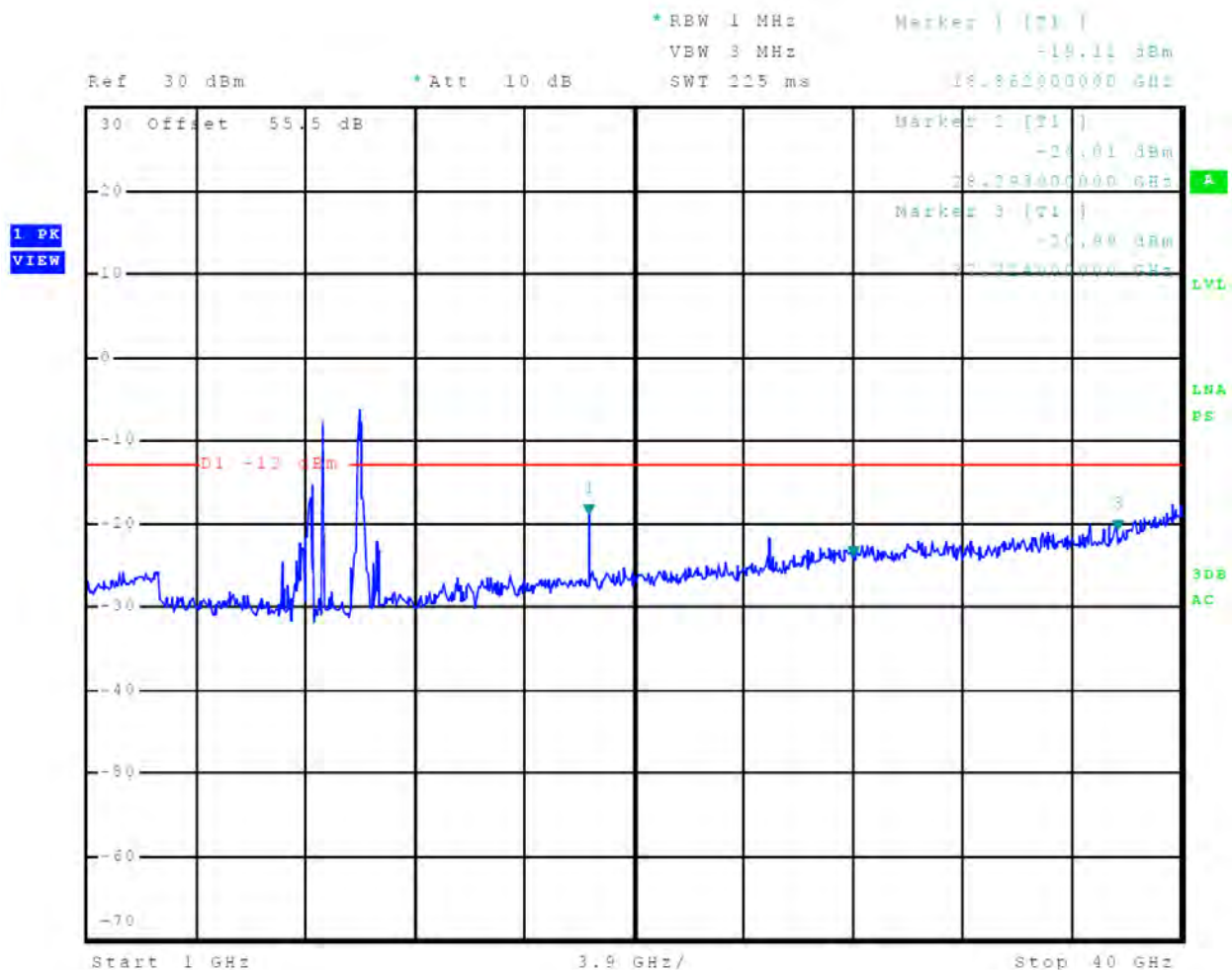

Figure 88 Out-of-Band Emissions 18 nm

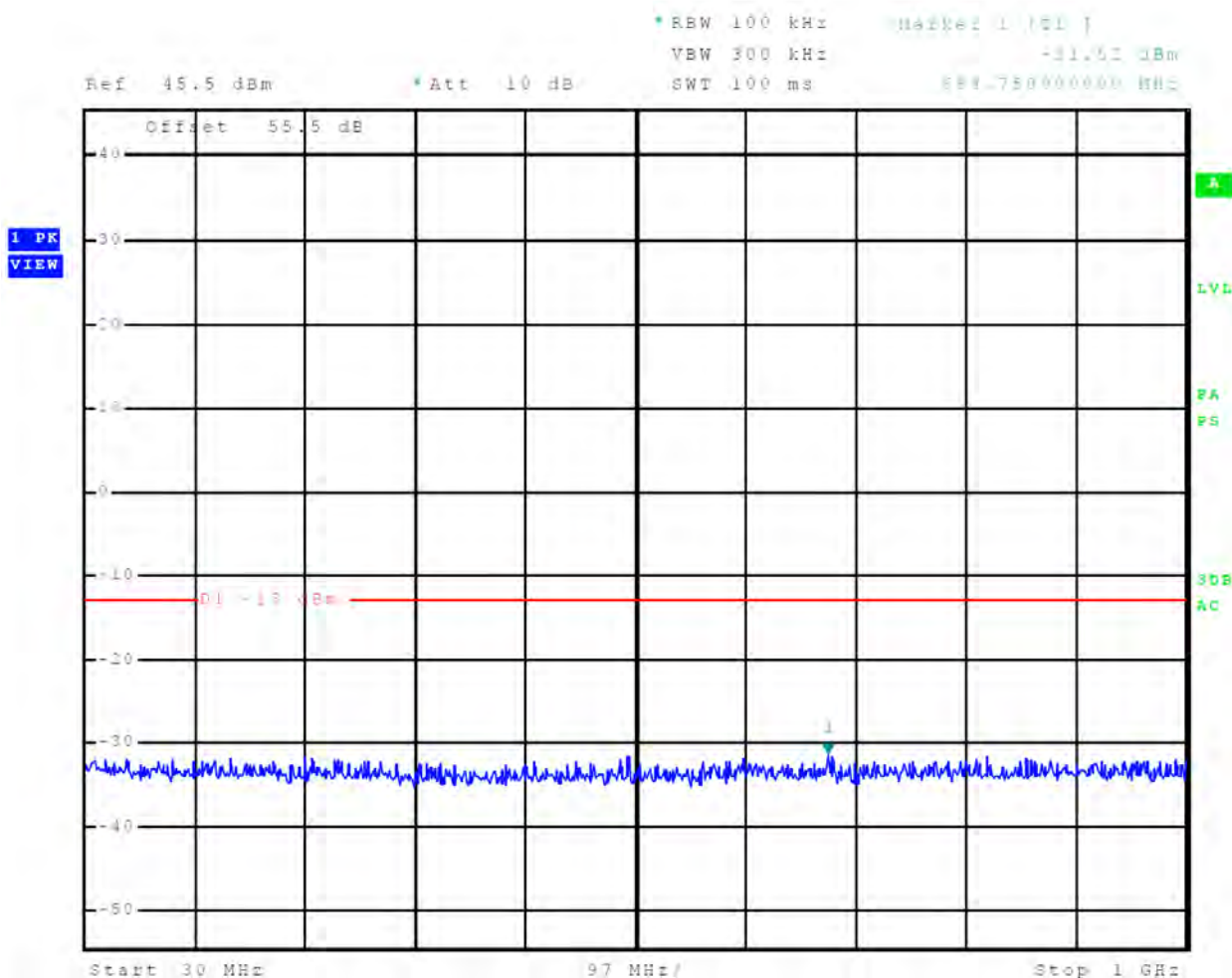

Figure 89 Out-of-Band Emissions 18 nm

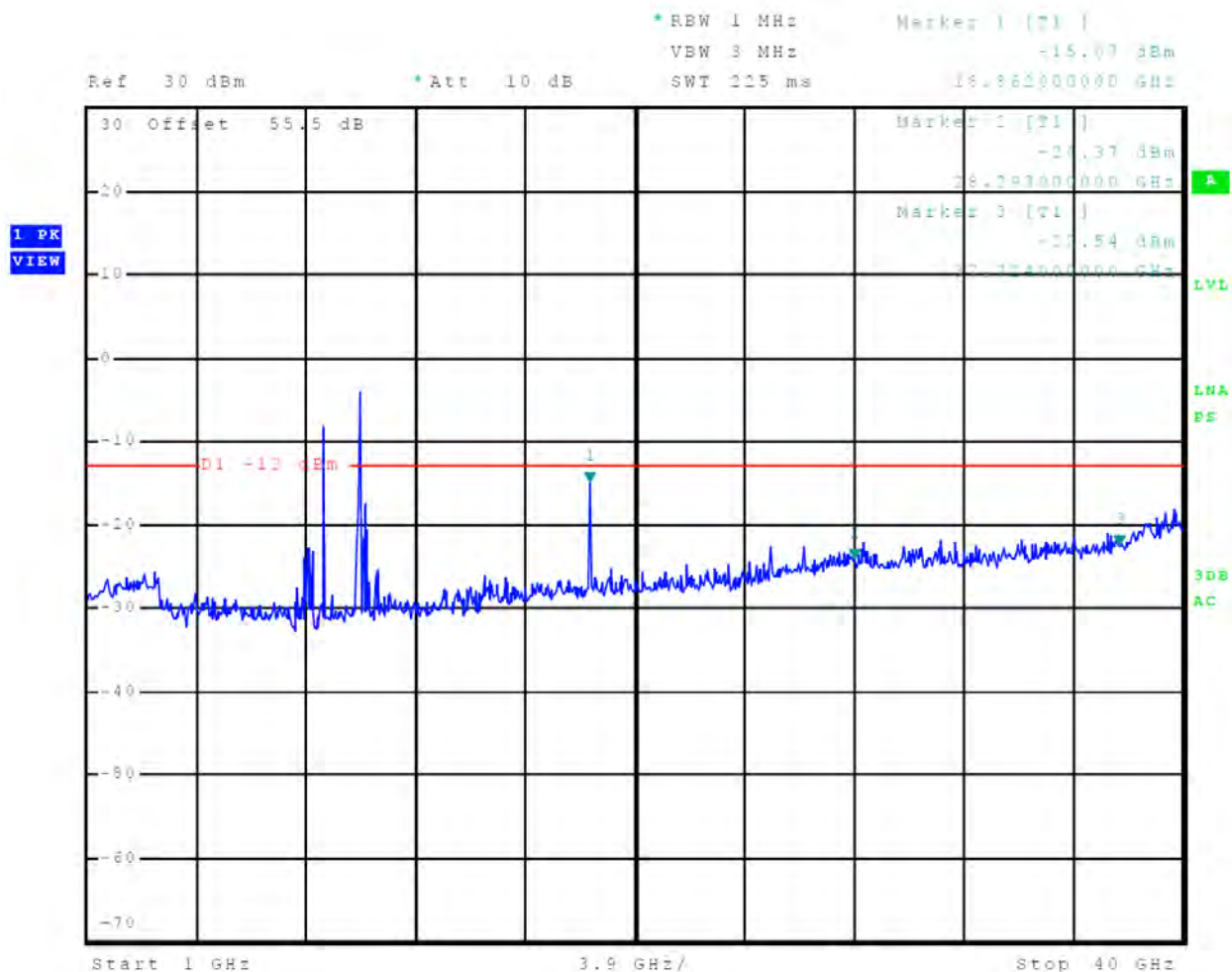

Figure 90 Out-of-Band Emissions 24 nm

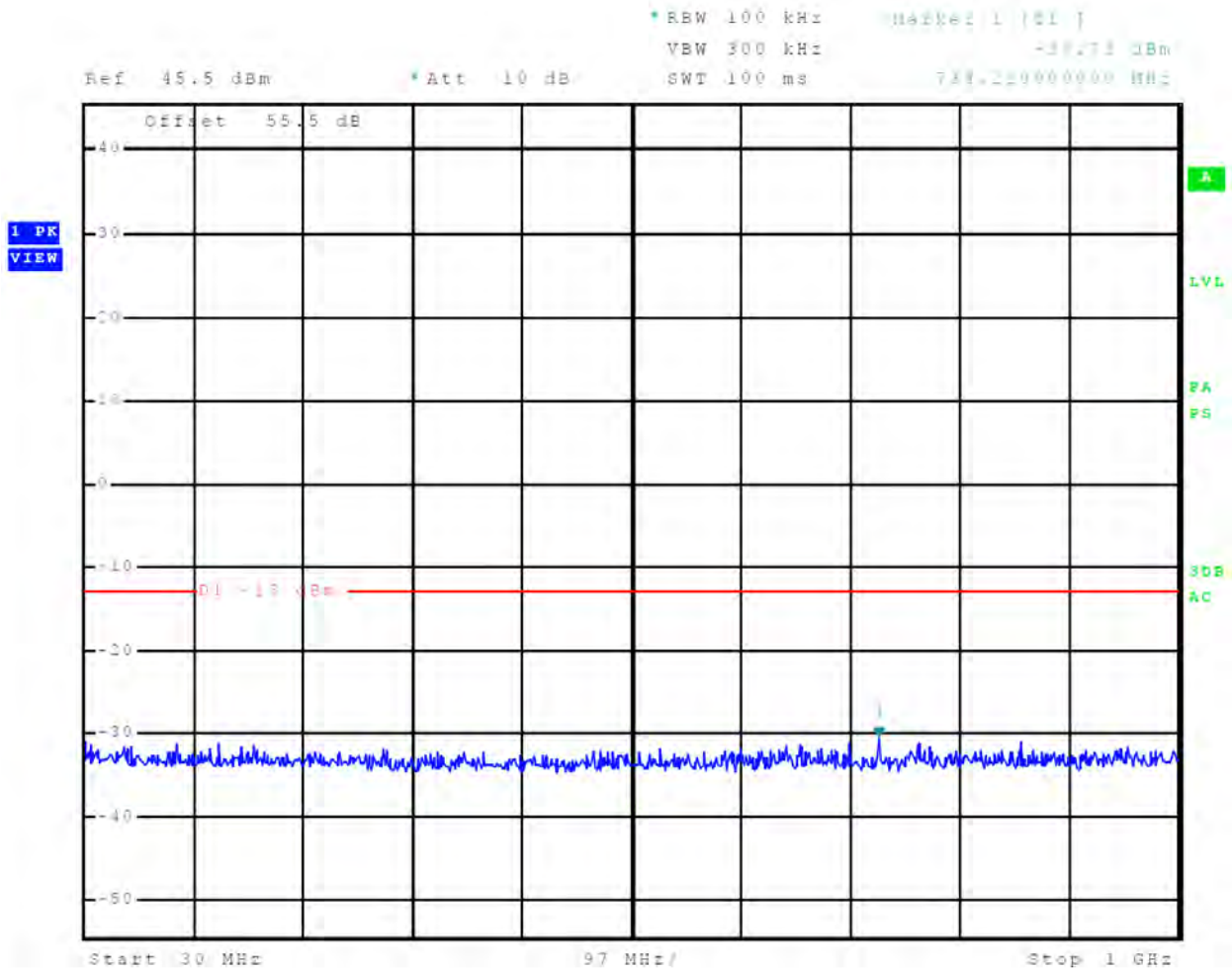

Figure 91 Out-of-Band Emissions 24 nm

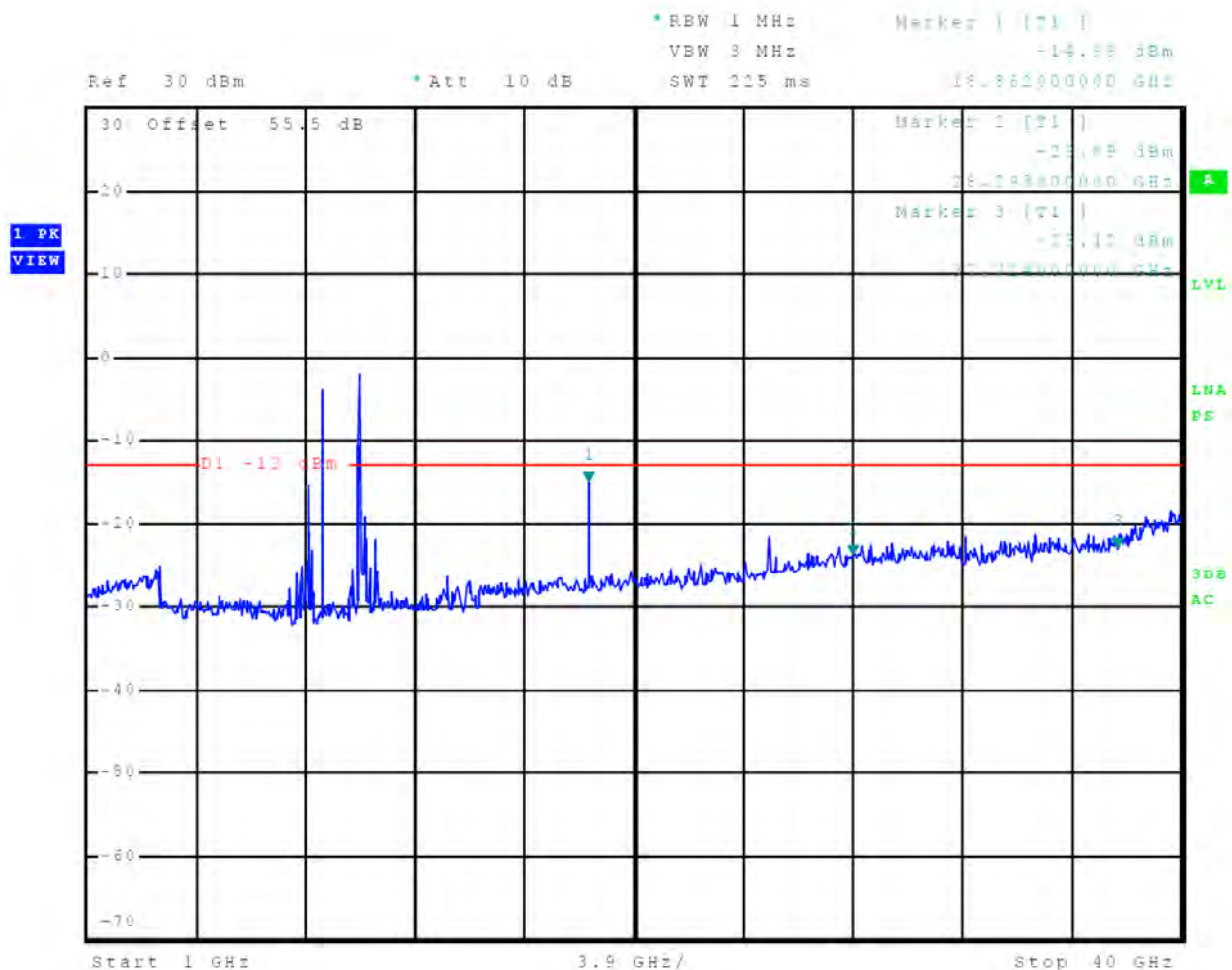



Figure 92 Out-of-Band Emissions 36 nm

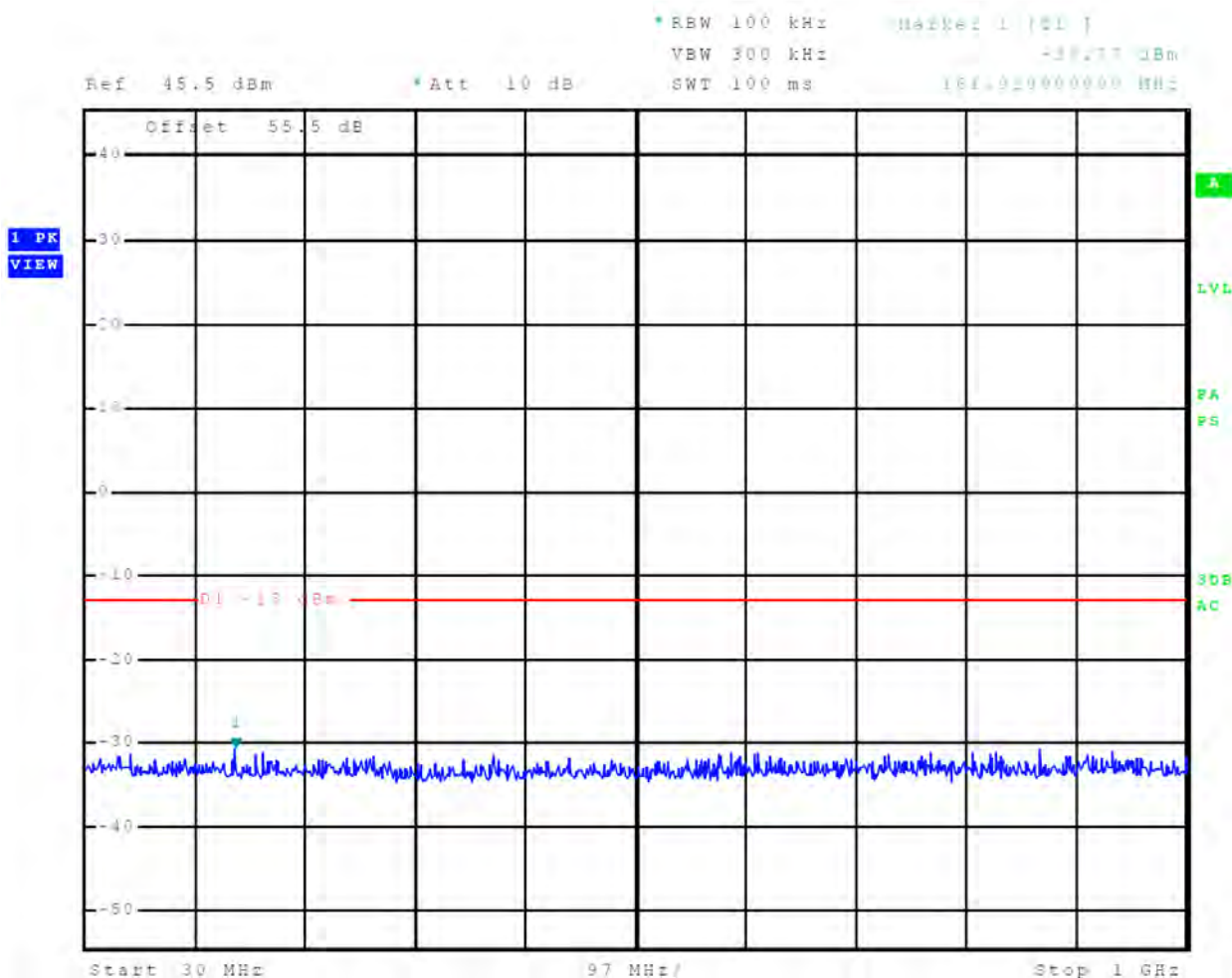

Figure 93 Out-of-Band Emissions 36 nm

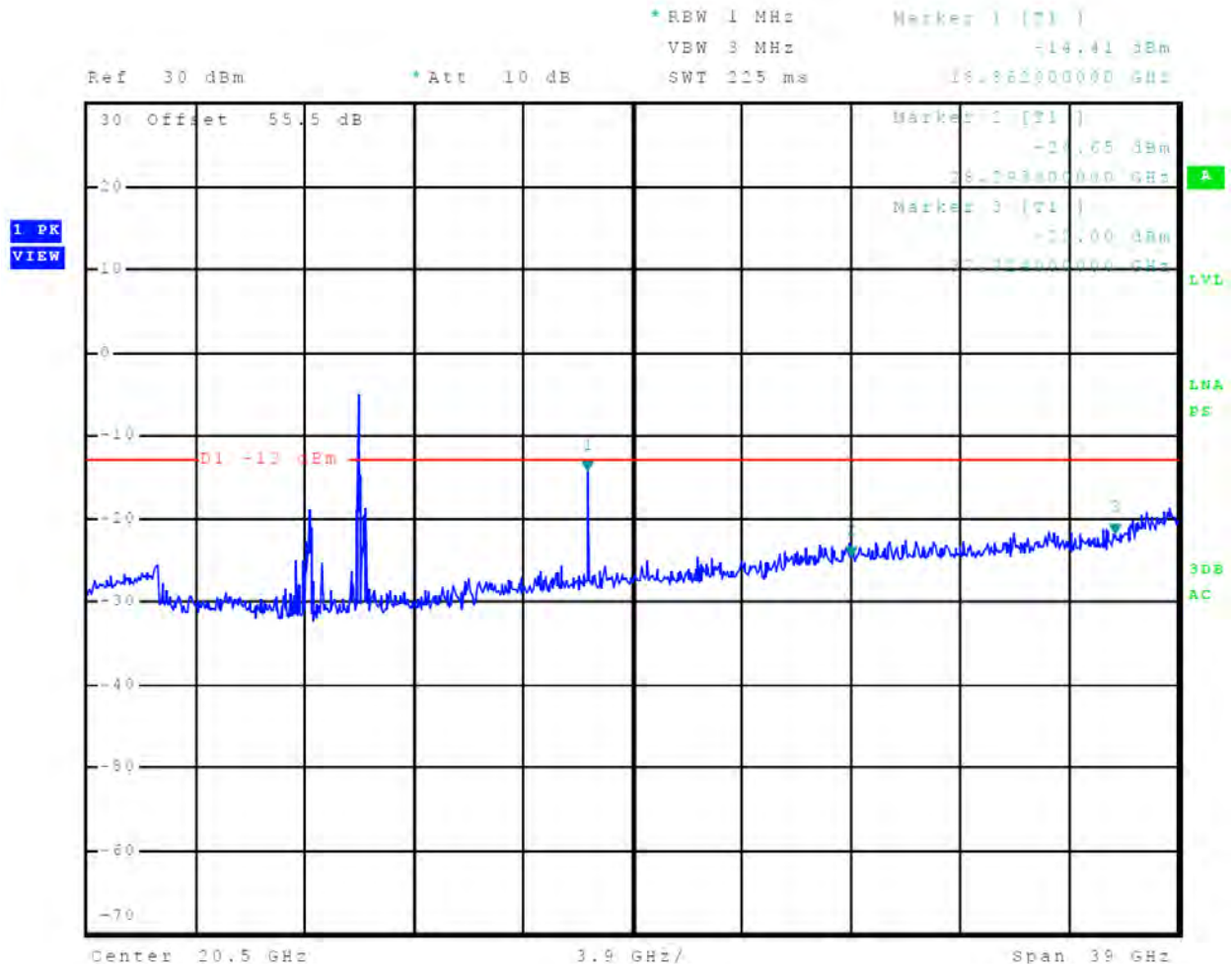

Figure 94 Out-of-Band Emissions 48 nm

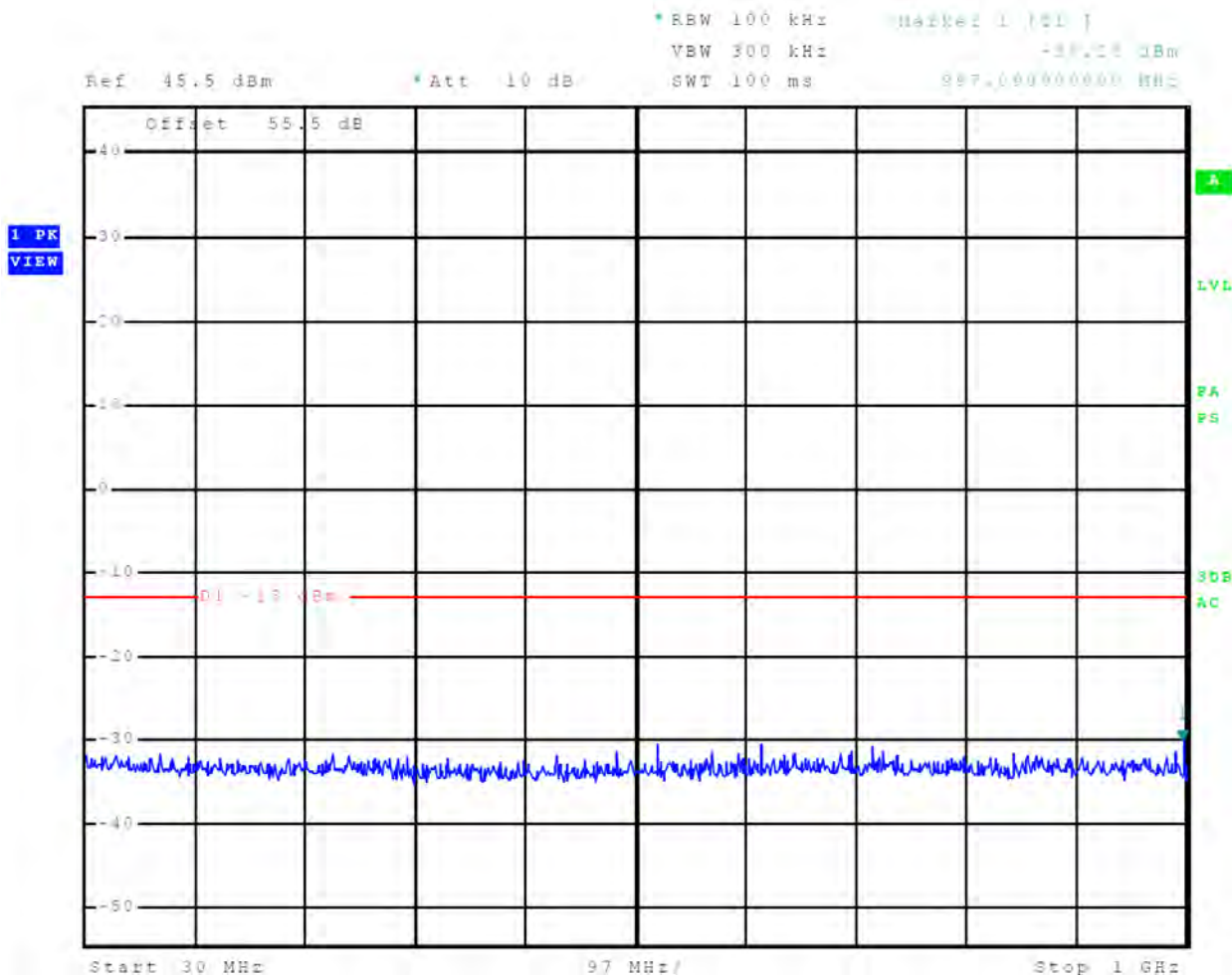

Figure 95 Out-of-Band Emissions 48 nm

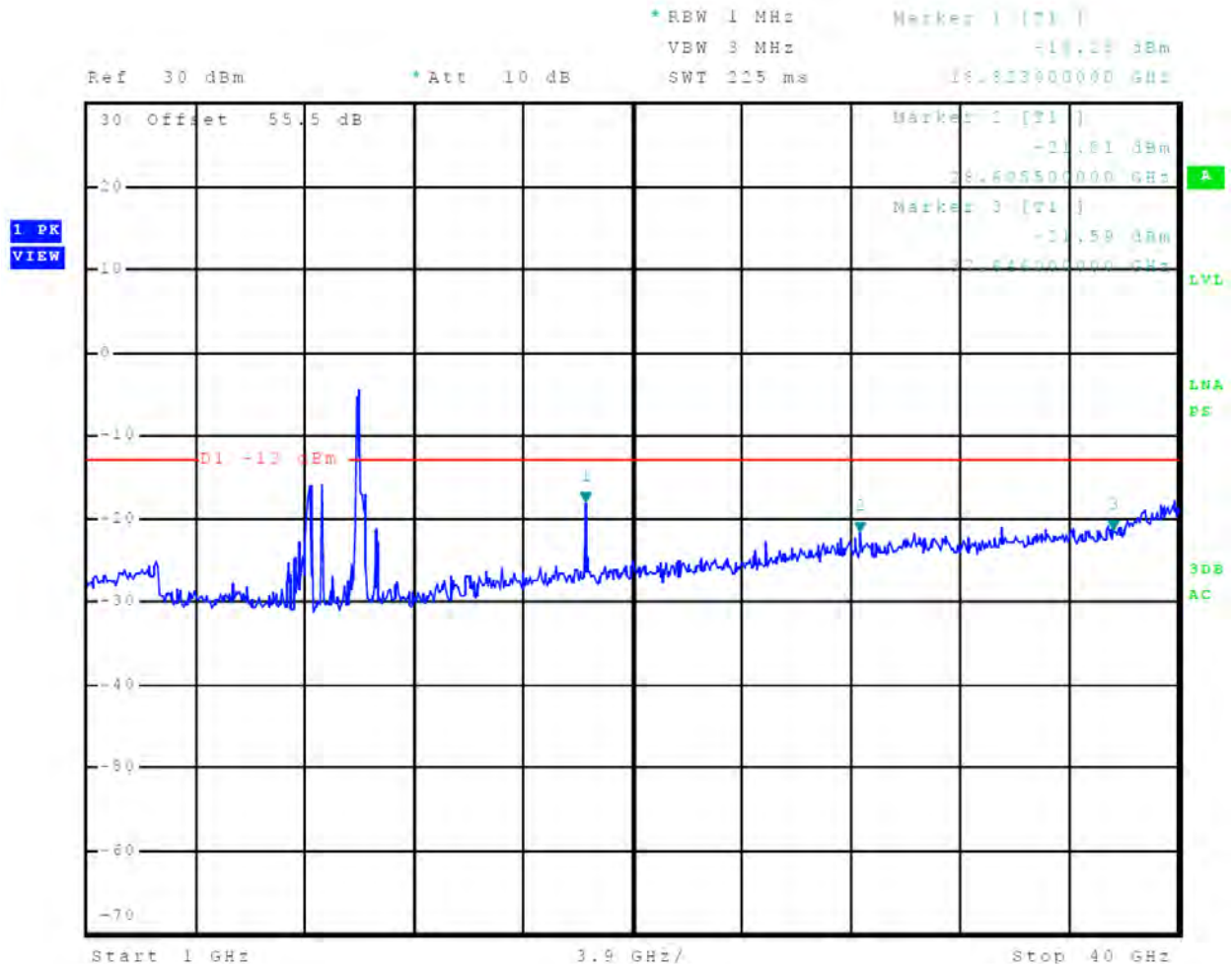

Figure 96 Out-of-Band Emissions 64 nm

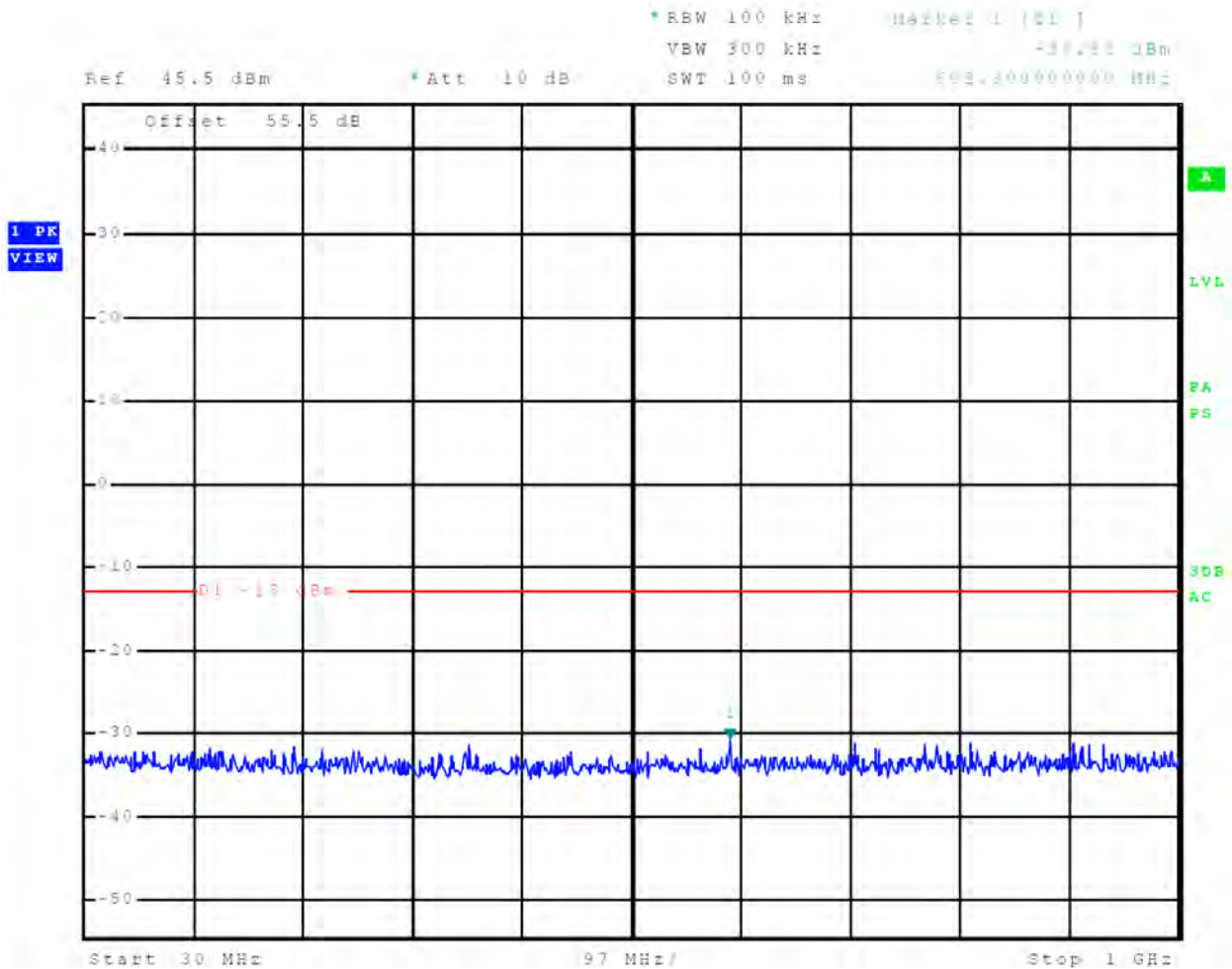

Figure 97 Out-of-Band Emissions 64 nm

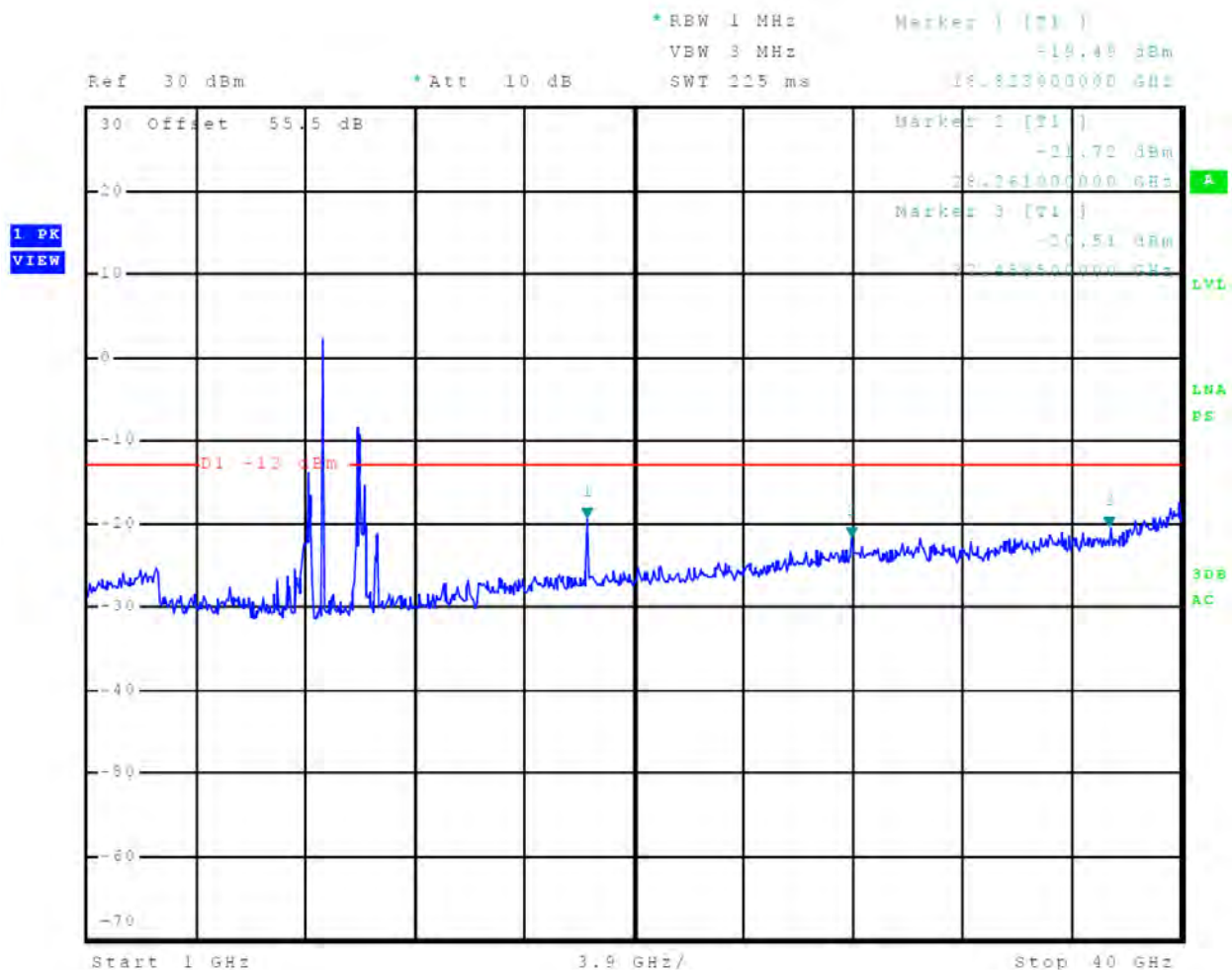



Figure 98 Out-of-Band Emissions 72 nm

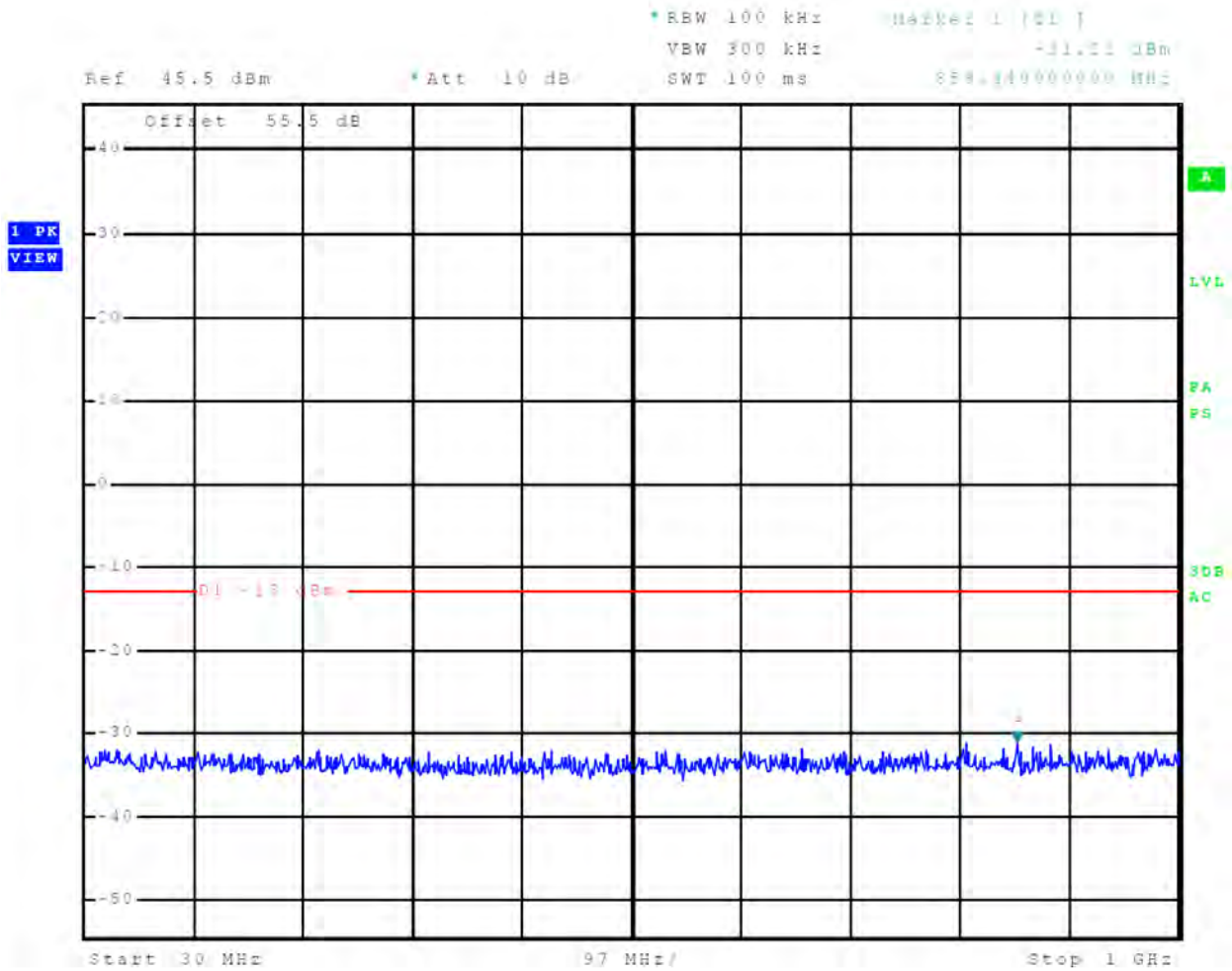

Figure 99 Out-of-Band Emissions 72 nm

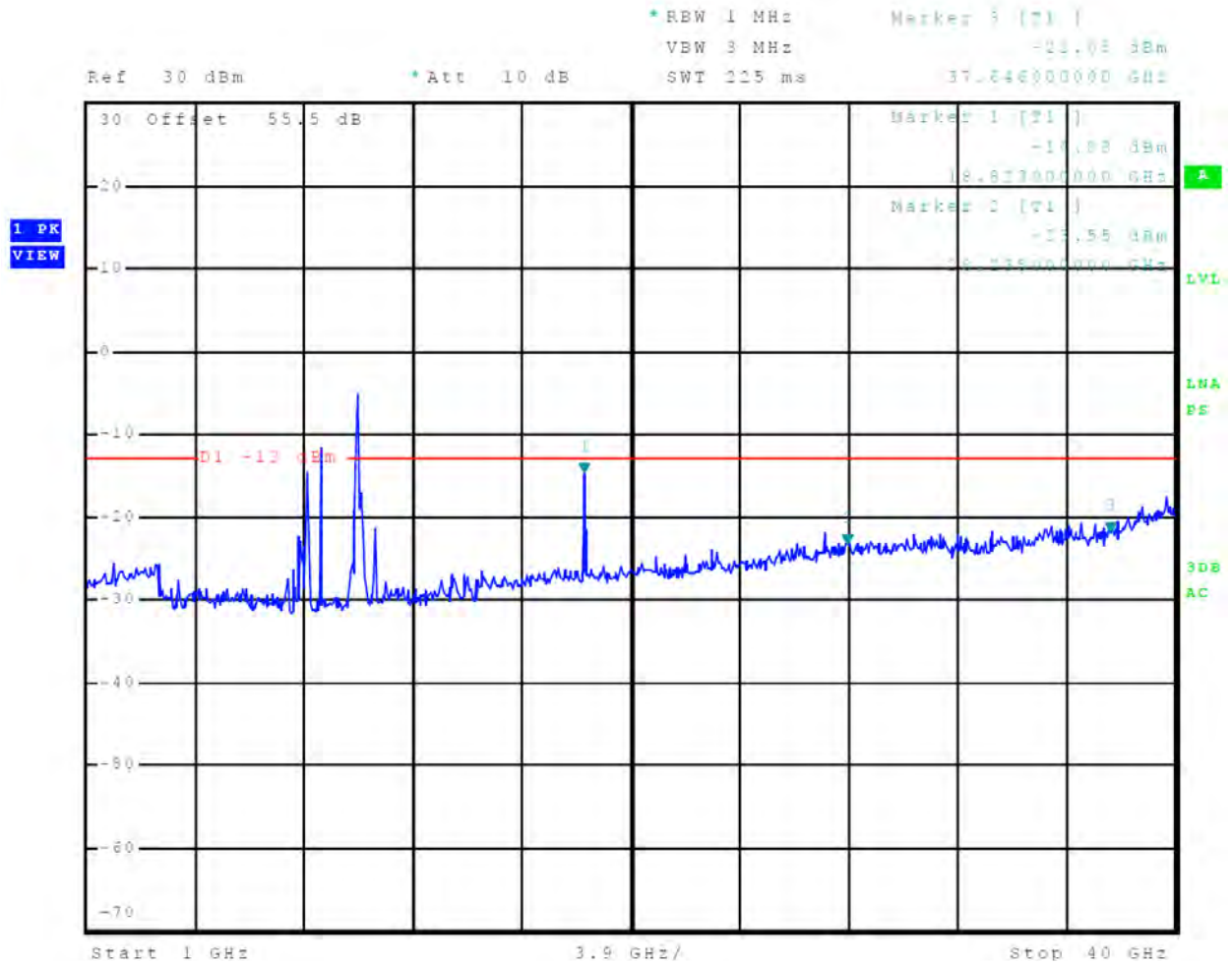

Figure 100 Out-of-Band Emissions 96 nm

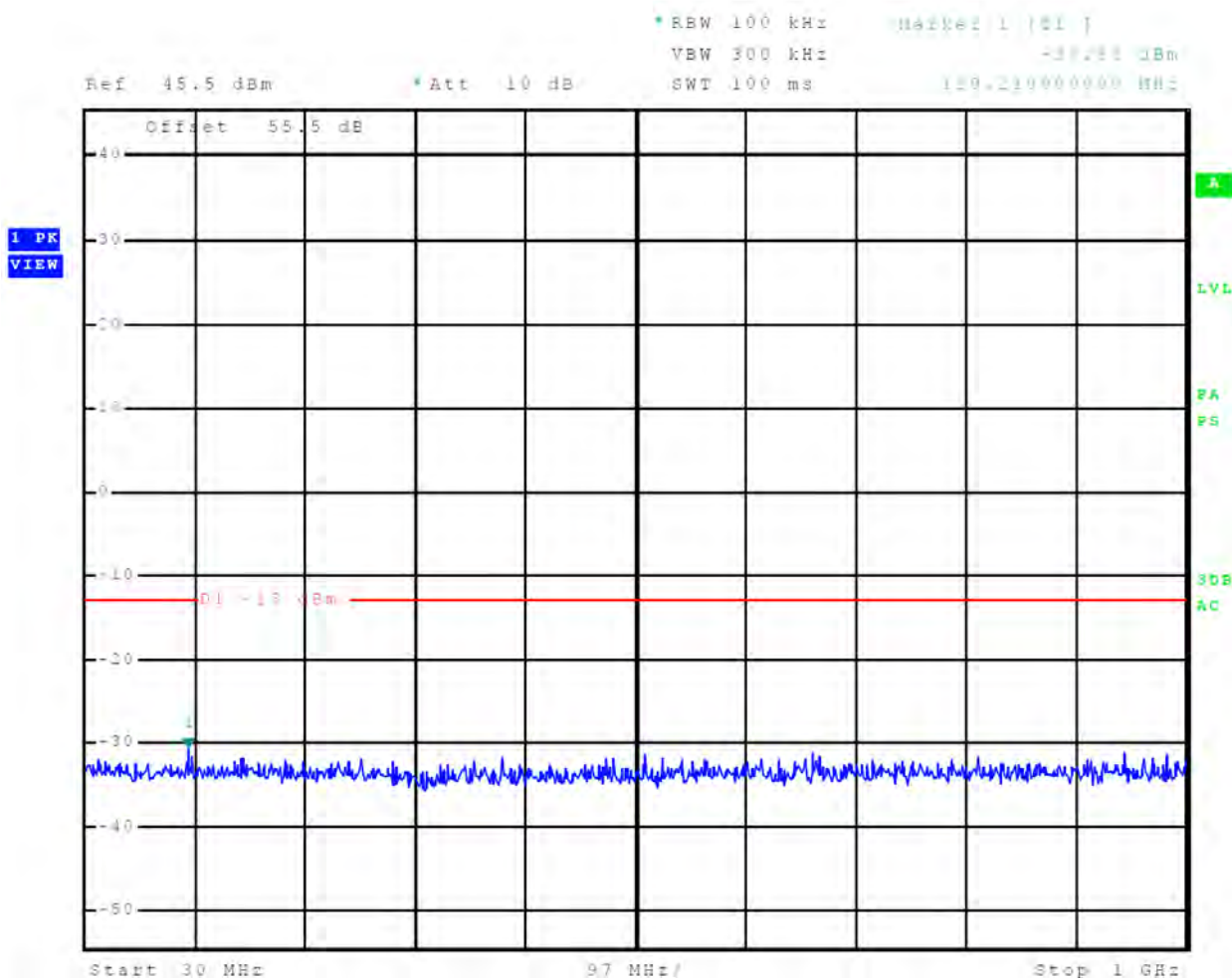
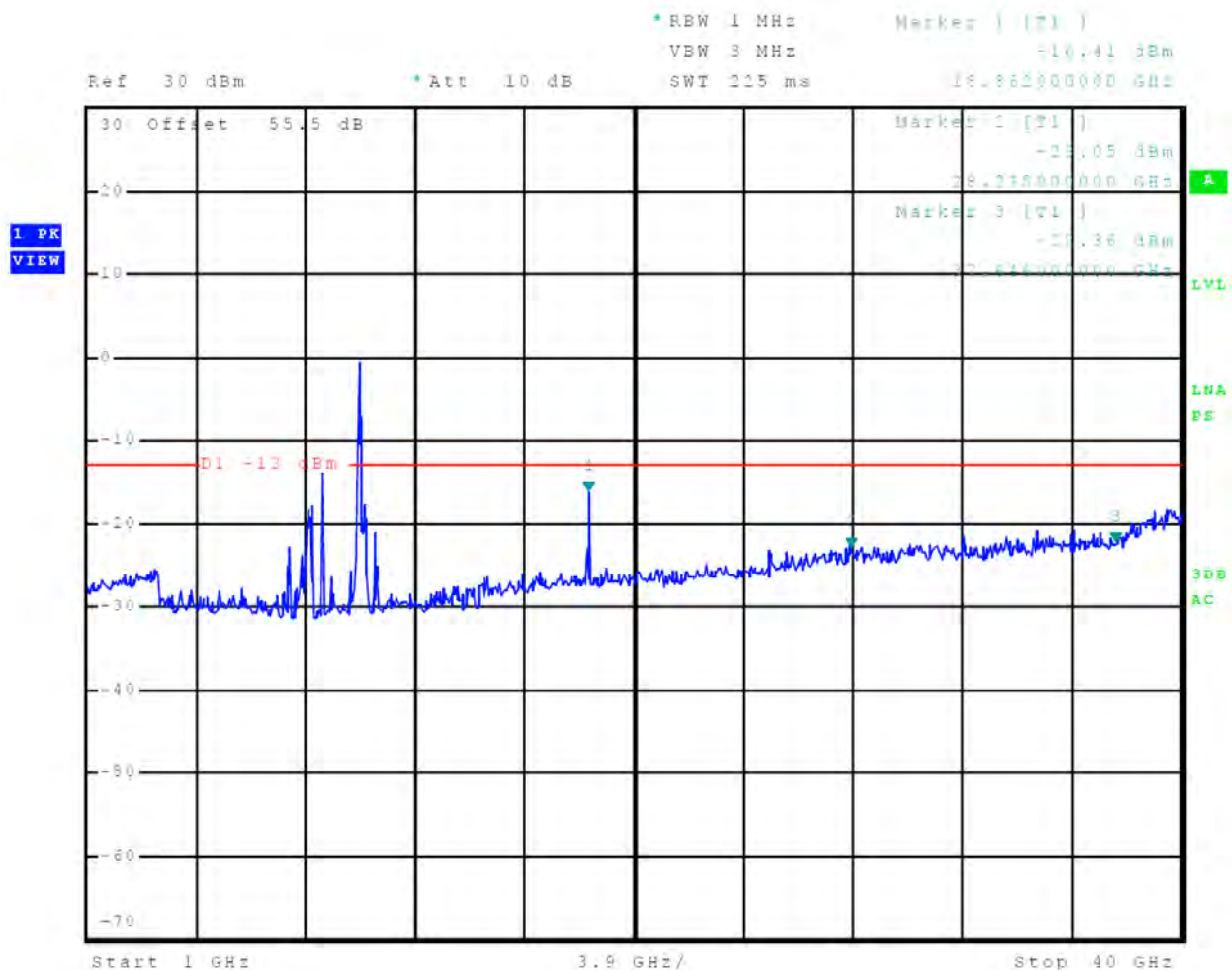

Figure 101 Out-of-Band Emissions 96 nm



## TEST #7 Field Strength of Spurious Radiated Emissions

### Measurements Required

Measurements shall be made to detect spurious emissions that may be radiated directly from the cabinet, control circuits, power leads, or intermediate circuit elements under normal conditions of installation and operation.

### Test Arrangement

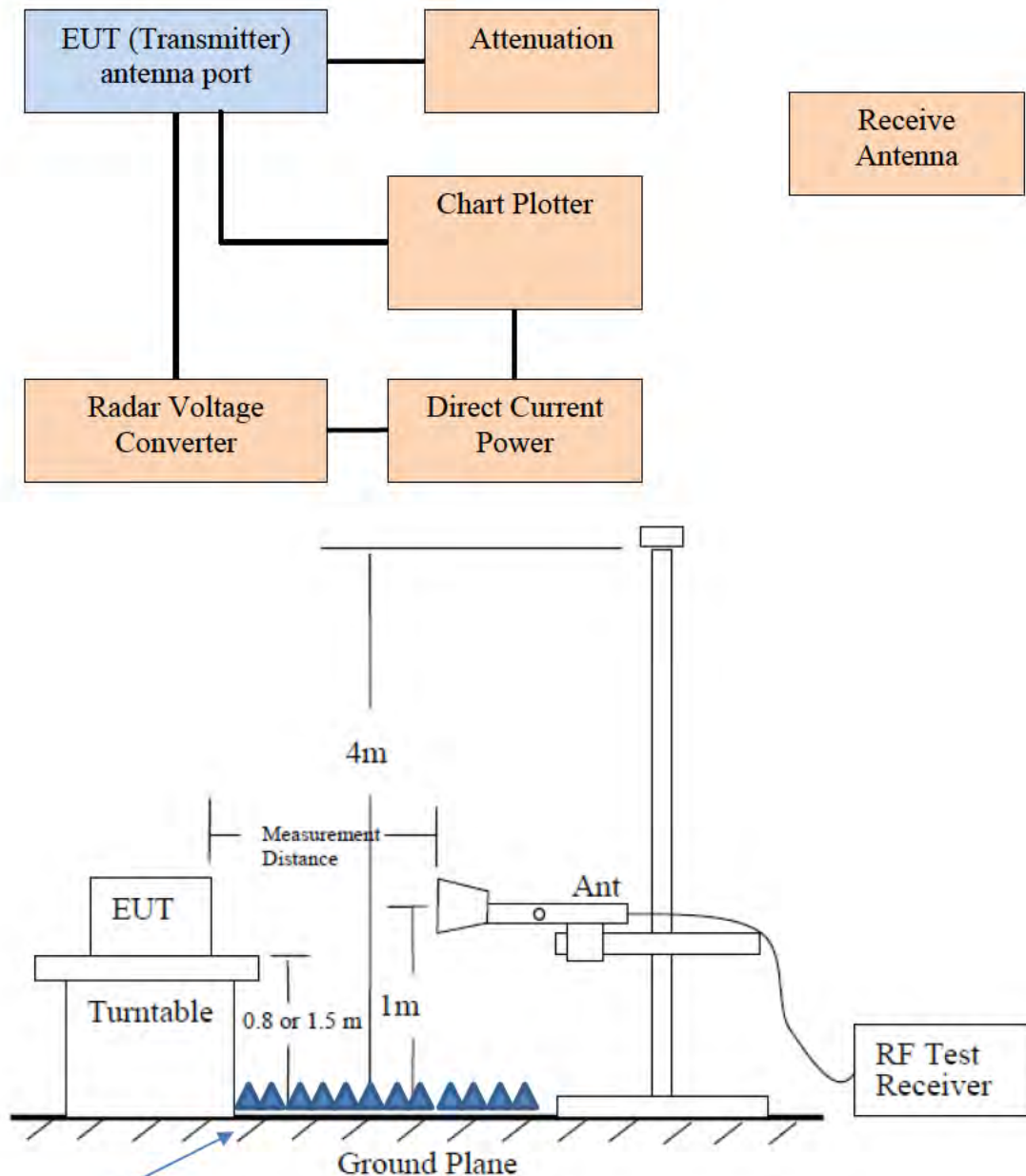

Figure 4—Test set-up for radiated spurious measurements

Foam if required

Preliminary radiated emissions investigation was made in a screen room to determine frequencies of emissions for investigation on the Open Area Test Site (OATS). The transmitter spurious emissions were measured on the OATS. The EUT was placed on a turntable elevated as required above the ground plane at a distance of 3 meters from the FSM antenna. The turntable was rotated though 360 degrees to locate the position registering the highest amplitude emission. The frequency spectrum was then searched for spurious emissions generated from the transmitter. Raising and lowering the FSM antenna and rotating the turntable to maximize the emission. Data was measured and recorded for the maximum amplitude of each spurious emission. A Loop antenna was used for measuring emissions from 0.009 to 30 MHz, Biconilog Antenna for 30 to 1000 MHz, Double-Ridge, and/or Pyramidal Horn Antennas above 1 GHz. Emissions were measured in dB $\mu$ V/m @ 3 meters. Limits from FCC Parts 2.1053, 80.211 (f) and test procedure from ANSI C63.26-2015.

The limits for the spurious radiated emissions are defined by the following equation.

Limit: Spurious emissions must be attenuated below the peak output power by the at least  $43 + 10 \text{ Log } (P_{\text{mean}})$  dB.

12.0 -watt transmitter limit requires the out of band emissions must be suppressed by at least 53.8 dBc

$$\begin{aligned} \text{Attenuation} &= 43 + 10 \text{ Log}_{10}(P_w) \\ &= 43 + 10 \text{ Log}_{10}(12.0) \\ &= 53.8 \text{ dBc} \end{aligned}$$

Data was taken per 2.1051, applicable parts of 47CFR 80, and RSS-238. The EUT demonstrated compliance with the specifications of Paragraphs 47CFR 2.1051, 2.1057 and 80 and RSS-238. There are no deviations to the specifications.



**Table 6 Field Strength of Spurious Radiated Emissions Results**

Frequency MHz	Amplitude of Emission (dBμV)		ERP (dBm)		Emission level below carrier (dBc)		Limit (dBc)
	Horizontal	Vertical	Horizontal	Vertical	Horizontal	Vertical	
200.4	30.5	29.2	-66.9	-68.2	140.9	142.2	53.8
201.3	30.5	29.2	-66.9	-68.2	140.9	142.2	53.8
210.3	35.7	31.9	-61.7	-65.5	135.7	139.5	53.8
216.0	31.4	34.8	-66.0	-62.6	140.0	136.6	53.8
218.2	31.3	34.8	-66.1	-62.6	140.1	136.6	53.8
246.5	35.9	33.8	-61.5	-63.6	135.5	137.6	53.8
256.5	38.7	35.8	-58.7	-61.6	132.7	135.6	53.8
258.3	37.4	37.8	-60.0	-59.6	134.0	133.6	53.8
302.1	37.9	41.6	-59.5	-55.8	133.5	129.8	53.8
353.5	37.6	38.1	-59.8	-59.3	133.8	133.3	53.8
403.4	42.9	38.6	-54.5	-58.8	128.5	132.8	53.8
439.1	42.2	40.6	-55.2	-56.8	129.2	130.8	53.8
504.0	42.6	40.2	-54.8	-57.2	128.8	131.2	53.8
510.9	42.6	40.2	-54.8	-57.2	128.8	131.2	53.8
18820.0	57.3	54.9	-37.93	-40.33	111.9	114.3	53.8
28230.0	56.8	56.6	-38.43	-38.63	112.4	112.6	53.8
37640.0	66.1	65.8	-29.13	-29.43	103.1	103.4	53.8

Other emissions present had amplitudes at least 20 dB below the limit. Peak and Quasi-Peak amplitude emissions are recorded above for frequency range of 30-1000 MHz. Peak and Average amplitude emissions are recorded above for frequency range above 1000 MHz.

## TEST #8 Frequency Stability

### Measurements Required

The frequency stability shall be measured with variations of ambient temperature from -30° to +50° centigrade. Measurements shall be made at the extremes of the temperature range and at intervals of not more than 10° centigrade through the range. A period sufficient to stabilize all of the components of the oscillator circuit at each temperature level shall be allowed prior to frequency measurement. In addition to temperature stability, the frequency stability shall be measured with variation of primary supply voltage as follows:

- (1) Vary primary supply voltage from 85 to 115 percent of the nominal value.
- (2) The supply voltage shall be measured at the input to the cable normally provided with the equipment, or at the power supply terminals if cables are not normally provided.

### Test Arrangement

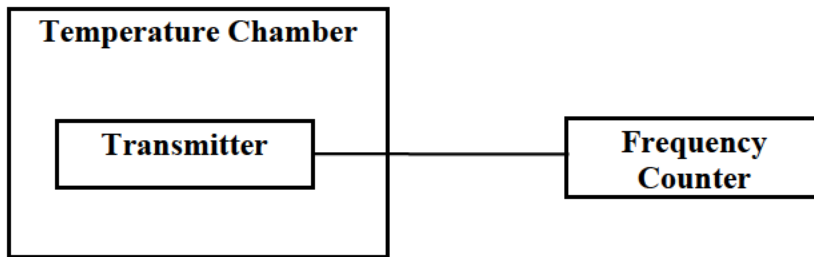

The measurement procedure outlined below shall be followed for frequency stability testing.

Step 1: The transmitter shall be installed in an environmental test chamber whose temperature is controllable. Provision shall be made to measure the frequency of the transmitter.

Step 2: With the transmitter inoperative (power switched “OFF”), the temperature of the test chamber shall be adjusted to +25°C. After a temperature stabilization period of one hour at +25°C, the transmitter shall be switched “ON” with standard test voltage applied.

Step 3: The carrier shall be keyed “ON”, and the transmitter shall be operated at full radio frequency power output at the duty cycle, for which it is rated, for duration of at least 5 minutes. The radio frequency carrier frequency shall be monitored, and measurements shall be recorded.

Step 4: The test procedures outlined in Steps 2 and 3, shall be repeated after stabilizing the transmitter at the environmental temperatures specified, -30°C to +50°C in 10-degree increments.

**Table 7 Frequency Stability vs. Temperature Results**

Frequency Stability Vs. Temperature									
Temperature °C	-30	-20	-10	0	+10	+20	+30	+40	+50
Change (MHz)	6.300	7.900	6.600	4.400	3.000	1.200	-0.300	-2.200	-4.100
PPM	669	839	701	467	318	127	-32	-234	-435
%	0.067	0.084	0.070	0.047	0.032	0.013	-0.003	-0.023	-0.044
results	Pass	Pass	Pass	Pass	Pass	Pass	Pass	Pass	Pass

**Table 8 Frequency Stability vs. Input Power Supply Voltage Results**

Frequency Stability Vs. Voltage Variation 14 volts nominal; Results in Hz change			
Voltage V <sub>dc</sub>	11.90	14.00	16.10
Change (Hz)	0	0	0
results	Pass	Pass	Pass

Limit for this device is defined in 47CFR 80.209(b) as

When pulse modulation is used in land and ship radar stations operating in the bands above 2.4 GHz the frequency at which maximum emission occurs must be within the authorized bandwidth and must not be closer than 1.5/T MHz to the upper and lower limits of the authorized bandwidth where “T” is the pulse duration in microseconds.

This equipment provides maximum pulse duration of 3630.72 microseconds. The frequency of operation remains within this constraint. This data indicates the unit will remain in the allowable frequency band during operation. Specifications of Paragraphs 2.1055, applicable paragraphs of part 80.209, and RSS-138 are met. There are no deviations to the specifications.

## Annex

- Annex A Measurement Uncertainty Calculations
- Annex B Test Equipment
- Annex C Rogers Qualifications
- Annex D Laboratory Certificate of Accreditation



## Annex A Measurement Uncertainty Calculations

The measurement uncertainty was calculated for all measurements listed in this test report according To CISPR 16-4. Result of measurement uncertainty calculations are recorded below. Component and process variability of production devices similar to those tested may result in additional deviations. The manufacturer has the sole responsibility of continued compliance.

Measurement	Expanded Measurement Uncertainty $U_{(lab)}$
3 Meter Horizontal 0.009-1000 MHz Measurements	4.16
3 Meter Vertical 0.009-1000 MHz Measurements	4.33
3 Meter Measurements 1-18 GHz	5.14
3 Meter Measurements 18-40 GHz	5.16
10 Meter Horizontal Measurements 0.009-1000 MHz	4.15
10 Meter Vertical Measurements 0.009-1000 MHz	4.32
AC Line Conducted	1.75
Antenna Port Conducted power	1.17
Frequency Stability	1.00E-11
Temperature	1.6°C
Humidity	3%

## Annex B Test Equipment

<input type="checkbox"/>	LISN	FCC	FCC-LISN-50-25-10(1PA) (160611)	.15-30MHz	3/29/2022	3/29/2023
<input type="checkbox"/>	LISN: Fischer Custom Communications Model: FCC-LISN-50-16-2-08				3/29/2022	3/29/2023
<input checked="" type="checkbox"/>	Cable	Huber & Suhner Inc.	Sucoflex102ea(L10M)(303073)	9kHz-40 GHz	10/11/2022	10/11/2023
<input type="checkbox"/>	Cable	Huber & Suhner Inc.	Sucoflex102ea(1.5M)(303069)	9kHz-40 GHz	10/11/2022	10/11/2023
<input checked="" type="checkbox"/>	Cable	Huber & Suhner Inc.	Sucoflex102ea(1.5M)(303070)	9kHz-40 GHz	10/11/2022	10/11/2023
<input checked="" type="checkbox"/>	Cable	Belden	RG-58 (L1-CAT3-11509)	9kHz-30 MHz	10/11/2022	10/11/2023
<input type="checkbox"/>	Cable	Belden	RG-58 (L2-CAT3-11509)	9kHz-30 MHz	10/11/2022	10/11/2023
<input checked="" type="checkbox"/>	Antenna	Com Power	AL-130 (121055)	.001-30 MHz	10/11/2022	10/11/2023
<input type="checkbox"/>	Antenna:	EMCO	6509	.001-30 MHz	10/14/2020	10/11/2023
<input type="checkbox"/>	Antenna	ARA	BCD-235-B (169)	20-350MHz	10/11/2022	10/11/2023
<input checked="" type="checkbox"/>	Antenna	Sunol	JB-6 (A100709)	30-1000 MHz	10/11/2022	10/11/2023
<input type="checkbox"/>	Antenna	ETS-Lindgren	3147 (40582)	200-1000MHz	10/11/2022	10/11/2024
<input checked="" type="checkbox"/>	Antenna	ETS-Lindgren	3117 (200389)	1-18 GHz	3/29/2022	3/29/2024
<input type="checkbox"/>	Antenna	Com Power	AH-118 (10110)	1-18 GHz	10/11/2022	10/11/2024
<input checked="" type="checkbox"/>	Antenna	Com Power	AH-840 (101046)	18-40 GHz	4/6/2021	4/6/2023
<input checked="" type="checkbox"/>	Analyzer	Rohde & Schwarz	ESU40 (100108)	20Hz-40GHz	3/9/2022	3/9/2023
<input checked="" type="checkbox"/>	Analyzer	Rohde & Schwarz	ESW44 (101534)	20Hz-44GHz	1/18/2022	1/18/2023
<input type="checkbox"/>	Analyzer	Rohde & Schwarz	FS-Z60, 90, 140, and 220	40GHz-220GHz	12/22/2017	12/22/2027
<input checked="" type="checkbox"/>	Amplifier	Com-Power	PA-010 (171003)	100Hz-30MHz	10/11/2022	10/11/2023
<input checked="" type="checkbox"/>	Amplifier	Com-Power	CPPA-102 (01254)	1-1000 MHz	10/11/2022	10/11/2023
<input checked="" type="checkbox"/>	Amplifier	Com-Power	PAM-118A (551014)	0.5-18 GHz	10/11/2022	10/11/2023
<input checked="" type="checkbox"/>	Amplifier	Com-Power	PAM-840A (461328)	18-40 GHz	10/11/2022	10/11/2023
<input checked="" type="checkbox"/>	Pwr Sensor	Rohde & Schwarz	NRP33T	0.05-33 GHz	8/31/2022	8/31/2023
<input checked="" type="checkbox"/>	Power Meter	Agilent	N1911A with N1921A	0.05-40 GHz	3/29/2022	3/29/2023
<input type="checkbox"/>	Generator	Rohde & Schwarz	SMB100A6 (100150)	20Hz-6 GHz	3/29/2022	3/29/2023
<input type="checkbox"/>	Generator	Rohde & Schwarz	SMBV100A6 (260771)	20Hz-6 GHz	3/29/2022	3/29/2023
<input type="checkbox"/>	RF Filter	Micro-Tronics	BRC50722 (009).9G notch	30-18000 MHz	4/6/2021	4/6/2023
<input type="checkbox"/>	RF Filter	Micro-Tronics	HPM50114 (017)1.5G HPF	30-18000 MHz	4/6/2021	4/6/2023
<input type="checkbox"/>	RF Filter	Micro-Tronics	HPM50117 (063) 3G HPF	30-18000 MHz	4/6/2021	4/6/2023
<input type="checkbox"/>	RF Filter	Micro-Tronics	HPM50105 (059) 6G HPF	30-18000 MHz	4/6/2021	4/6/2023
<input type="checkbox"/>	RF Filter	Micro-Tronics	BRM50702 (172) 2G notch	30-18000 MHz	4/6/2021	4/6/2023
<input type="checkbox"/>	RF Filter	Micro-Tronics	BRC50703 (G102) 5G notch	30-18000 MHz	4/6/2021	4/6/2023
<input type="checkbox"/>	RF Filter	Micro-Tronics	BRC50705 (024) 5G notch	30-18000 MHz	4/6/2021	4/6/2023
<input type="checkbox"/>	Attenuator	Fairview	SA6NFN100W-40 (1625)	30-18000 MHz	3/29/2022	3/29/2023
<input type="checkbox"/>	Attenuator	Mini-Circuits	VAT-3W2+ (1436)	30-6000 MHz	3/29/2022	3/29/2023
<input type="checkbox"/>	Attenuator	Mini-Circuits	VAT-3W2+ (1445)	30-6000 MHz	3/29/2022	3/29/2023
<input type="checkbox"/>	Attenuator	Mini-Circuits	VAT-3W2+ (1735)	30-6000 MHz	3/29/2022	3/29/2023
<input type="checkbox"/>	Attenuator	Mini-Circuits	VAT-6W2+ (1438)	30-6000 MHz	3/29/2022	3/29/2023
<input type="checkbox"/>	Attenuator	Mini-Circuits	VAT-6W2+ (1736)	30-6000 MHz	3/29/2022	3/29/2023
<input checked="" type="checkbox"/>	Weather station	Davis	6312 (A81120N075)		10/11/2022	10/11/2023

Rogers Labs, Inc.  
 4405 West 259<sup>th</sup> Terrace  
 Louisburg, KS 66053  
 Phone/Fax: (913) 837-3214  
 Revision 1

Garmin International, Inc.  
 Model: A04560  
 Test: 221201  
 Test to: 47CFR 80E, RSS-238, RSS-Gen  
 File: A04560 Garmin TstRpt 221201

SN: 3434382009  
 FCC ID: IPH-04560  
 IC: 1792A-04560  
 Date: January 18, 2023  
 Page 138 of 141



List of Test Equipment

Calibration Date (m/d/y) Due

<input type="checkbox"/>	Frequency Counter: Leader LDC-825 (8060153)	3/29/2022	3/29/2023
<input type="checkbox"/>	ISN: Com-Power Model ISN T-8	3/29/2022	3/29/2023
<input type="checkbox"/>	LISN Compliance Design FCC-LISN-2.Mod.cd,(126) .15-30MHz	10/11/2022	10/11/2024
<input type="checkbox"/>	LISN: Com-Power Model LI-220A	3/29/2022	3/29/2024
<input type="checkbox"/>	LISN: Com-Power Model LI-550C	10/11/2022	10/11/2024
<input type="checkbox"/>	Cable Huber & Suhner Inc. Sucoflex102ea(1.5M)(303072) 9kHz-40 GHz	10/11/2022	10/11/2023
<input type="checkbox"/>	Cable Huber & Suhner Inc. Sucoflex102ea(L1M)(281183) 9kHz-40 GHz	10/11/2022	10/11/2023
<input type="checkbox"/>	Cable Huber & Suhner Inc. Sucoflex102ea(L4M)(281184) 9kHz-40 GHz	10/11/2022	10/11/2023
<input type="checkbox"/>	Cable Huber & Suhner Inc. Sucoflex102ea(L10M)(317546)9kHz-40 GHz	10/11/2022	10/11/2023
<input type="checkbox"/>	Cable Time Microwave 4M-750HF290-750 (4M) 9kHz-24 GHz	10/11/2022	10/11/2023
<input type="checkbox"/>	RF Filter Micro-Tronics BRC17663 (001) 9.3-9.5 notch 30-1800 MHz	4/6/2021	4/6/2023
<input type="checkbox"/>	RF Filter Micro-Tronics BRC19565 (001) 9.2-9.6 notch 30-1800 MHz	10/14/2021	10/14/2023
<input type="checkbox"/>	Analyzer HP 8562A (3051A05950) 9kHz-125GHz	3/29/2022	3/29/2023
<input type="checkbox"/>	Wave Form Generator Keysight 33512B (MY57400128)	3/29/2022	3/29/2023
<input type="checkbox"/>	Antenna: Solar 9229-1 & 9230-1	2/22/2022	2/22/2023
<input type="checkbox"/>	CDN: Com-Power Model CDN325E	10/11/2022	10/11/2024
<input type="checkbox"/>	Oscilloscope Scope: Tektronix MDO 4104	2/22/2022	2/22/2023
<input type="checkbox"/>	EMC Transient Generator HVT TR 3000	2/22/2022	2/22/2023
<input type="checkbox"/>	AC Power Source (Ametech, California Instruments)	2/22/2022	2/22/2023
<input type="checkbox"/>	Field Intensity Meter: EFM-018	2/22/2022	2/22/2023
<input type="checkbox"/>	ESD Simulator: MZ-15	2/22/2022	2/22/2023
<input type="checkbox"/>	Injection Clamp Luthi Model EM101	not required	
<input type="checkbox"/>	R.F. Power Amp ACS 230-50W	not required	
<input type="checkbox"/>	R.F. Power Amp EIN Model: A301	not required	
<input type="checkbox"/>	R.F. Power Amp A.R. Model: 10W 1010M7	not required	
<input type="checkbox"/>	R.F. Power Amp A.R. Model: 50U1000	not required	
<input type="checkbox"/>	Temperature Chamber	not required	
<input checked="" type="checkbox"/>	Shielded Room	not required	

Rogers Labs, Inc.  
 4405 West 259<sup>th</sup> Terrace  
 Louisburg, KS 66053  
 Phone/Fax: (913) 837-3214  
 Revision 1

Garmin International, Inc.  
 Model: A04560  
 Test: 221201  
 Test to: 47CFR 80E, RSS-238, RSS-Gen  
 File: A04560 Garmin TstRpt 221201

SN: 3434382009  
 FCC ID: IPH-04560  
 IC: 1792A-04560  
 Date: January 18, 2023  
 Page 139 of 141

## **Annex C Rogers Qualifications**

***Scot D. Rogers, Engineer***

### **Rogers Labs, Inc.**

Mr. Rogers has approximately 36 years' experience in the field of electronics. Working experience includes six years working in the automated controls industry and 6 years working with the design, development and testing of radio communications and electronic equipment.

#### Positions Held:

Systems Engineer: A/C Controls Mfg. Co., Inc.

Electrical Engineer: Rogers Consulting Labs, Inc.

Electrical Engineer: Rogers Labs, Inc. Current

#### Educational Background:

Bachelor of Science Degree in Electrical Engineering from Kansas State University

Bachelor of Science Degree in Business Administration Kansas State University

Several Specialized Training courses and seminars pertaining to Microprocessors and Software programming