

FCC Test Report

FCC ID : IPH-04224
Equipment : Watch and Activity Monitor
Model No. : A04224
Brand Name : GARMIN
Applicant : Garmin International, Inc.
Address : 1200 E. 151st Street Olathe, KS 66062 United States
Standard : 47 CFR FCC Part 15.247
Received Date : Jul. 13, 2022
Tested Date : Jul. 15 ~ Jul. 26, 2022

We, International Certification Corporation, would like to declare that the tested sample has been evaluated and in compliance with the requirement of the above standards. The test results contained in this report refer exclusively to the product. It shall not be reproduced except in full without the written approval of our laboratory.

Reviewed by:

Approved by:



Along Chen / Assistant Manager



Gary Chang / Manager

Table of Contents

1	GENERAL DESCRIPTION	5
1.1	Information.....	5
1.2	Local Support Equipment List	7
1.3	Test Setup Chart	7
1.4	Test Equipment List and Calibration Data.....	8
1.5	Test Standards	9
1.6	Reference Guidance	9
1.7	Deviation from Test Standard and Measurement Procedure.....	9
1.8	Measurement Uncertainty	9
2	TEST CONFIGURATION.....	10
2.1	Testing Facility	10
2.2	The Worst Test Modes and Channel Details	10
3	TRANSMITTER TEST RESULTS	11
3.1	6dB and Occupied Bandwidth	11
3.2	Conducted Output Power	12
3.3	Power Spectral Density	13
3.4	Unwanted Emissions in Restricted Frequency Bands	14
3.5	Emissions in non-restricted Frequency Bands.....	16
3.6	AC Power Line Conducted Emissions	17
4	TEST LABORATORY INFORMATION	18

Appendix A. 6dB and Occupied Bandwidth

Appendix B. Conducted Output Power

Appendix C. Power Spectral Density

Appendix D. Unwanted Emissions into Restricted Frequency Bands

Appendix E. Emissions in Non-Restricted Frequency Bands

Appendix F. AC Power Line Conducted Emissions

Release Record

Report No.	Version	Description	Issued Date
FR270504AE	Rev. 01	Initial issue	Sep. 16, 2022

Summary of Test Results

FCC Rules	Test Items	Measured	Result
15.207	AC Power Line Conducted Emissions	[dBuV]: 0.788MHz 17.62 (Margin -28.38dB) - AV	Pass
15.247(d) 15.209	Unwanted Emissions	[dBuV/m at 3m]: 30.00MHz 35.40 (Margin -4.60dB) - PK	Pass
15.247(b)(3)	Conducted Output Power	Power [dBm]: 4.16	Pass
15.247(a)(2)	6dB Bandwidth	Meet the requirement of limit	Pass
15.247(e)	Power Spectral Density	Meet the requirement of limit	Pass
15.203	Antenna Requirement	Meet the requirement of limit	Pass

Declaration of Conformity:

The test results with all measurement uncertainty excluded are presented in accordance with the regulation limits or requirements declared by manufacturers.

Comments and Explanations:

The declared of product specification for EUT presented in the report are provided by the manufacturer, and the manufacturer takes all the responsibilities for the accuracy of product specification.

1 General Description

1.1 Information

1.1.1 Specification of the Equipment under Test (EUT)

RF General Information				
Frequency Range (MHz)	Bluetooth Mode	Ch. Freq. (MHz)	Channel Number	Data Rate
2400-2483.5	V5.0 LE	2402-2480	0-39 [40]	1 Mbps

Note: Bluetooth LE (Low energy) uses GFSK modulation.

1.1.2 Antenna Details

Ant. No.	Brand	Model	Type	Connector	Gain (dBi)
1	Garmin	117-01754-XX	LOOP	No	-2.23

1.1.3 Power Supply Type of Equipment under Test (EUT)

Power Supply Type	3.83Vdc from battery 5Vdc from host
--------------------------	--

1.1.4 Accessories

Accessories		
No.	Equipment	Description
1	Battery	Brand: Garmin Model: 361-00155-00 Power Rating: 3.83V, 87mAh
2	USB cable	Brand: Garmin Model: 320-00977-40 Line: 0.57m shielded without core

1.1.5 Channel List

Frequency band (MHz)				2400~2483.5			
Channel	Frequency (MHz)	Channel	Frequency (MHz)	Channel	Frequency (MHz)	Channel	Frequency (MHz)
37	2402	9	2422	18	2442	28	2462
0	2404	10	2424	19	2444	29	2464
1	2406	38	2426	20	2446	30	2466
2	2408	11	2428	21	2448	31	2468
3	2410	12	2430	22	2450	32	2470
4	2412	13	2432	23	2452	33	2472
5	2414	14	2434	24	2454	34	2474
6	2416	15	2436	25	2456	35	2476
7	2418	16	2438	26	2458	36	2478
8	2420	17	2440	27	2460	39	2480

1.1.6 Test Tool and Duty Cycle

Test Tool	BLE, Version:SW 52.07	
Modulation Mode	Duty Cycle Of Test Signal (%)	Duty Factor (dB)
BT-LE(1Mbps)	65.12%	1.86

1.1.7 Power Index of Test Tool

Modulation Mode	Test Frequency (MHz)		
	2402	2440	2480
BT-LE(1Mbps)	Default	Default	Default

1.2 Local Support Equipment List

Support Equipment List					
No.	Equipment	Brand	Model	FCC ID	Remarks
1	Adapter	philip	DLP6341C	---	---

1.3 Test Setup Chart

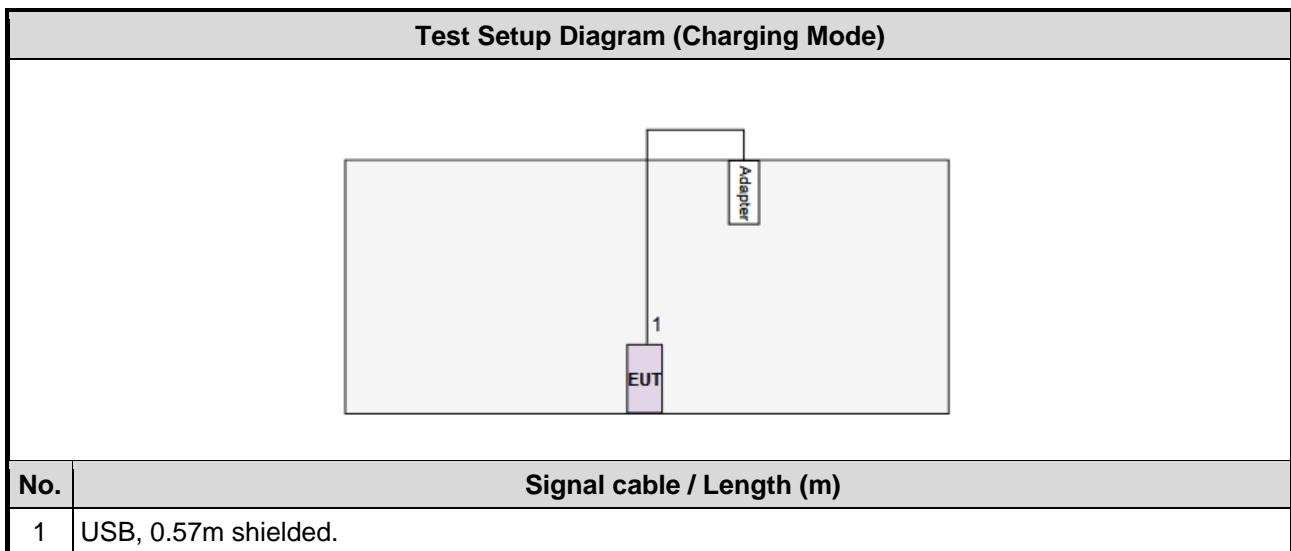
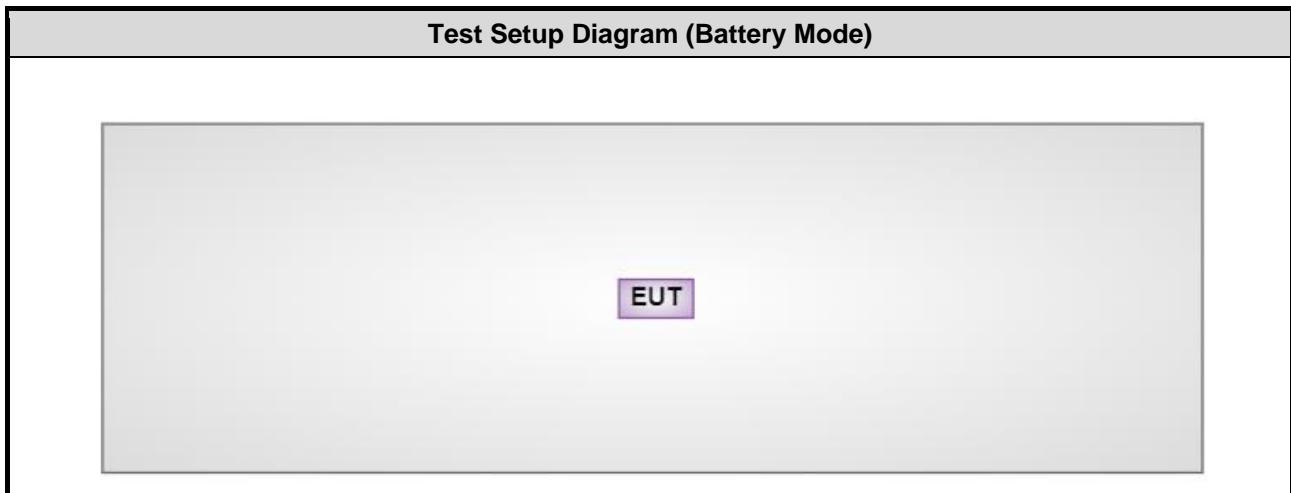

1.4 Test Equipment List and Calibration Data

Test Item	Conducted Emission				
Test Site	Conduction room 1 / (CO01-WS)				
Tested Date	Jul. 25, 2022				
Instrument	Brand	Model No.	Serial No.	Calibration Date	Calibration Until
Receiver	R&S	ESR3	101658	Feb. 16, 2022	Feb. 15, 2023
LISN	R&S	ENV216	101579	Apr. 21, 2022	Apr. 20, 2023
RF Cable-CON	Woken	CFD200-NL	CFD200-NL-001	Oct. 19, 2021	Oct. 18, 2022
Measurement Software	AUDIX	e3	6.120210k	NA	NA
Note: Calibration Interval of instruments listed above is one year.					

Test Item	Radiated Emission				
Test Site	966 chamber1 / (03CH01-WS)				
Tested Date	Jul. 15 ~ Jul. 25, 2022				
Instrument	Brand	Model No.	Serial No.	Calibration Date	Calibration Until
Receiver	R&S	ESR3	101657	Mar. 15, 2022	Mar. 14, 2023
Spectrum Analyzer	R&S	FSV40	101498	Nov. 29, 2021	Nov. 28, 2022
Loop Antenna	R&S	HFH2-Z2	100330	Nov. 08, 2021	Nov. 07, 2022
Bilog Antenna	SCHWARZBECK	VULB9168	VULB9168-685	Jun. 28, 2022	Jun. 27, 2023
Horn Antenna 1G-18G	SCHWARZBECK	BBHA 9120 D	BBHA 9120 D 1096	Dec. 03, 2021	Dec. 02, 2022
Horn Antenna 18G-40G	SCHWARZBECK	BBHA 9170	BBHA 9170517	Nov. 04, 2021	Nov. 03, 2022
Preamplifier	EMC	EMC02325	980225	Jun. 28, 2022	Jun. 27, 2023
Preamplifier	Agilent	83017A	MY39501308	Sep. 28, 2021	Sep. 27, 2022
Preamplifier	EMC	EMC184045B	980192	Jul. 08, 2022	Jul. 07, 2023
Loop Antenna Cable	KOAX KABEL	101354-BW	101354-BW	Oct. 05, 2021	Oct. 04, 2022
LF cable 3M	Woken	CFD400NL-LW	CFD400NL-001	Oct. 05, 2021	Oct. 04, 2022
LF cable 11M	EMC	EMCCFD400-NW-N W-11000	200801	Oct. 05, 2021	Oct. 04, 2022
LF cable 1M	EMC	EMCCFD400-NM-N M-1000	160502	Oct. 05, 2021	Oct. 04, 2022
RF Cable	EMC	EMC104-35M-35M- 8000	210920	Oct. 05, 2021	Oct. 04, 2022
RF Cable	HUBER+SUHNER	SUCOFLEX104	MY16019/4	Oct. 05, 2021	Oct. 04, 2022
Measurement Software	AUDIX	e3	6.120210g	NA	NA
Note: Calibration Interval of instruments listed above is one year.					

Test Item	RF Conducted				
Test Site	(TH01-WS)				
Tested Date	Jul. 26, 2022				
Instrument	Brand	Model No.	Serial No.	Calibration Date	Calibration Until
Spectrum Analyzer	R&S	FSV40	101910	Apr. 18, 2022	Apr. 17, 2023
Power Meter	Anritsu	ML2495A	1241002	Nov. 07, 2021	Nov. 06, 2022
Power Sensor	Anritsu	MA2411B	1207366	Nov. 07, 2021	Nov. 06, 2022
Measurement Software	Sporton	SENSE-15247_FS	V5.10.7.11	NA	NA
Note: Calibration Interval of instruments listed above is one year.					

1.5 Test Standards

47 CFR FCC Part 15.247
ANSI C63.10-2013

1.6 Reference Guidance

FCC KDB 558074 D01 15.247 Meas Guidance v05r02

1.7 Deviation from Test Standard and Measurement Procedure

None

1.8 Measurement Uncertainty

The measurement uncertainties given below are based on a 95% confidence level (based on a coverage factor ($k=2$)).

Measurement Uncertainty	
Parameters	Uncertainty
Bandwidth	± 34.130 Hz
Conducted power	± 0.808 dB
Power density	± 0.583 dB
Conducted emission	± 2.715 dB
AC conducted emission	± 2.92 dB
Unwanted Emission ≤ 1 GHz	± 3.41 dB
Unwanted Emission > 1 GHz	± 4.59 dB

2 Test Configuration

2.1 Testing Facility

Test Laboratory	International Certification Corporation
Test Site	CO01-WS, 03CH01-WS, TH01-WS
Address of Test Site	No.3-1, Lane 6, Wen San 3rd St., Kwei Shan Dist., Tao Yuan City 33381, Taiwan (R.O.C.)

- FCC Designation No.: TW2732
- FCC site registration No.: 181692
- ISED#: 10807A
- CAB identifier: TW2732

2.2 The Worst Test Modes and Channel Details

Test item	Mode	Test Frequency (MHz)	Test Configuration
AC Power Line Conducted Emissions	Charging	---	1
Unwanted Emissions ≤ 1GHz	BT-LE(1Mbps)	2480	2
	Charging	---	1
Unwanted Emissions > 1GHz	BT-LE(1Mbps)	2402, 2440, 2480	2
Conducted Output Power 6dB bandwidth Power spectral density	BT-LE(1Mbps)	2402, 2440, 2480	2

NOTE:

1. The EUT was pretested with 3 orientations placed on the table for the radiated emission measurement – X, Y, and Z-plane. The **Y-plane** results were found as the worst case and were shown in this report.
2. The EUT had been tested by following test configurations.
 - 1) Configuration 1: Charging mode
 - 2) Configuration 2: Battery mode

3 Transmitter Test Results

3.1 6dB and Occupied Bandwidth

3.1.1 Limit of 6dB Bandwidth

The minimum 6dB bandwidth shall be at least 500 kHz.

3.1.2 Test Procedures

6dB Bandwidth

1. Set resolution bandwidth (RBW) = 100 kHz, Video bandwidth = 300 kHz.
2. Detector = Peak, Trace mode = max hold.
3. Sweep = auto couple, Allow the trace to stabilize.
4. Measure the maximum width of the emission that is constrained by the frequencies associated with the two outermost amplitude points (upper and lower) that are attenuated by 6dB relative to the maximum level measured in the fundamental emission.

Occupied Bandwidth

1. Set resolution bandwidth (RBW) = 1% ~ 5 % of OBW, Video bandwidth = 3 x RBW
2. Detector = Sample, Trace mode = max hold.
3. Sweep = auto couple, Allow the trace to stabilize.
4. Use the OBW measurement function of spectrum analyzer to measure the occupied bandwidth.

3.1.3 Test Setup

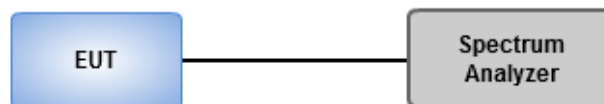

3.1.4 Test Results

Ambient Condition	23°C / 65%	Tested By	Roger Lu
--------------------------	------------	------------------	----------

Refer to Appendix A.

3.2 Conducted Output Power

3.2.1 Limit of Conducted Output Power

Conducted power shall not exceed 1Watt.

Antenna gain $\leq 6\text{dBi}$, no any corresponding reduction is in output power limit.

3.2.2 Test Procedures

A broadband RF power meter is used for output power measurement. The video bandwidth of power meter is greater than DTS bandwidth of EUT. If duty cycle of test signal is not 100 %, trigger and gating function of power meter will be enabled to capture transmission burst for measuring output power.

3.2.3 Test Setup

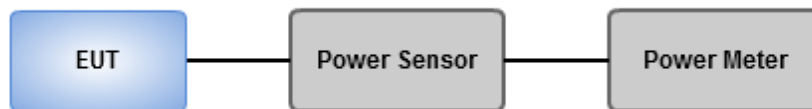

3.2.4 Test Results

Ambient Condition	23°C / 65%	Tested By	Roger Lu
--------------------------	------------	------------------	----------

Refer to Appendix B.

3.3 Power Spectral Density

3.3.1 Limit of Power Spectral Density

Power spectral density shall not be greater than 8 dBm in any 3 kHz band.

3.3.2 Test Procedures

1. Set the RBW = 3 kHz, VBW = 10 kHz.
2. Detector = Peak, Sweep time = auto couple.
3. Trace mode = max hold, allow trace to fully stabilize.
4. Use the peak marker function to determine the maximum amplitude level.

3.3.3 Test Setup

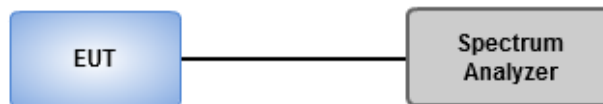

3.3.4 Test Results

Ambient Condition	23°C / 65%	Tested By	Roger Lu
--------------------------	------------	------------------	----------

Refer to Appendix C.

3.4 Unwanted Emissions in Restricted Frequency Bands

3.4.1 Limit of Unwanted Emissions in Restricted Frequency Bands

Restricted Band Emissions Limit			
Frequency Range (MHz)	Field Strength (uV/m)	Field Strength (dBuV/m)	Measure Distance (m)
0.009~0.490	2400/F(kHz)	48.5 - 13.8	300
0.490~1.705	24000/F(kHz)	33.8 - 23	30
1.705~30.0	30	29	30
30~88	100	40	3
88~216	150	43.5	3
216~960	200	46	3
Above 960	500	54	3

Note 1:
Quasi-Peak value is measured for frequency below 1GHz except for 9–90 kHz, 110–490 kHz frequency band. Peak and average value are measured for frequency above 1GHz. The limit on average radio frequency emission is as above table. The limit on peak radio frequency emissions is 20 dB above the maximum permitted average emission limit

Note 2:
Measurements may be performed at a distance other than what is specified provided. When performing measurements at a distance other than that specified, the results shall be extrapolated to the specified distance using an extrapolation factor as below, Frequency at or above 30 MHz: 20 dB/decade Frequency below 30 MHz: 40 dB/decade.

3.4.2 Test Procedures

1. Measurement is made at a semi-anechoic chamber that incorporates a turntable allowing a EUT rotation of 360°. A continuously-rotating, remotely-controlled turntable is installed at the test site to support the EUT and facilitate determination of the direction of maximum radiation for each EUT emission frequency. The EUT is placed at test table. For emissions testing at or below 1 GHz, the table height is 80 cm above the reference ground plane. For emission measurements above 1 GHz, the table height is 1.5 m
2. Measurement is made with the antenna positioned in both the horizontal and vertical planes of polarization. The measurement antenna is varied in height (1m ~ 4m) above the reference ground plane to obtain the maximum signal strength. Distance between EUT and antenna is 3 m.
3. This investigation is performed with the EUT rotated 360°, the antenna height scanned between 1 m and 4 m, and the antenna rotated to repeat the measurements for both the horizontal and vertical antenna polarizations.

Note:

1. 120kHz measurement bandwidth of test receiver and Quasi-peak detector is for radiated emission below 1GHz.
2. RBW=1MHz, VBW=3MHz and Peak detector is for peak measured value of radiated emission above 1GHz.
3. RBW=1MHz, VBW=1/T and Peak detector is for average measured value of radiated emission above 1GHz.

3.4.3 Test Setup

Radiated Emissions below 1 GHz

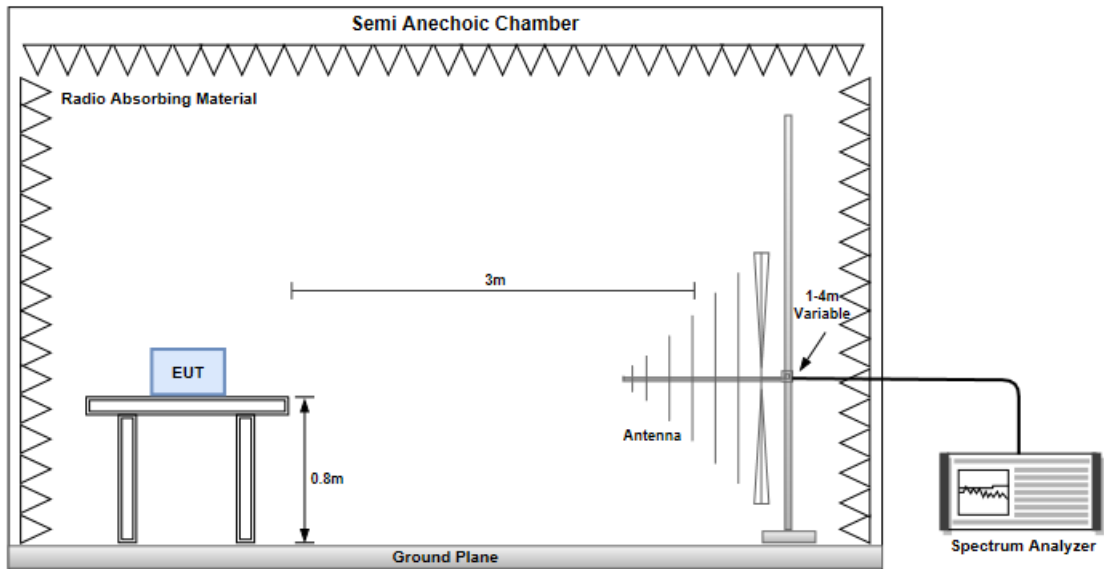

Radiated Emissions above 1 GHz

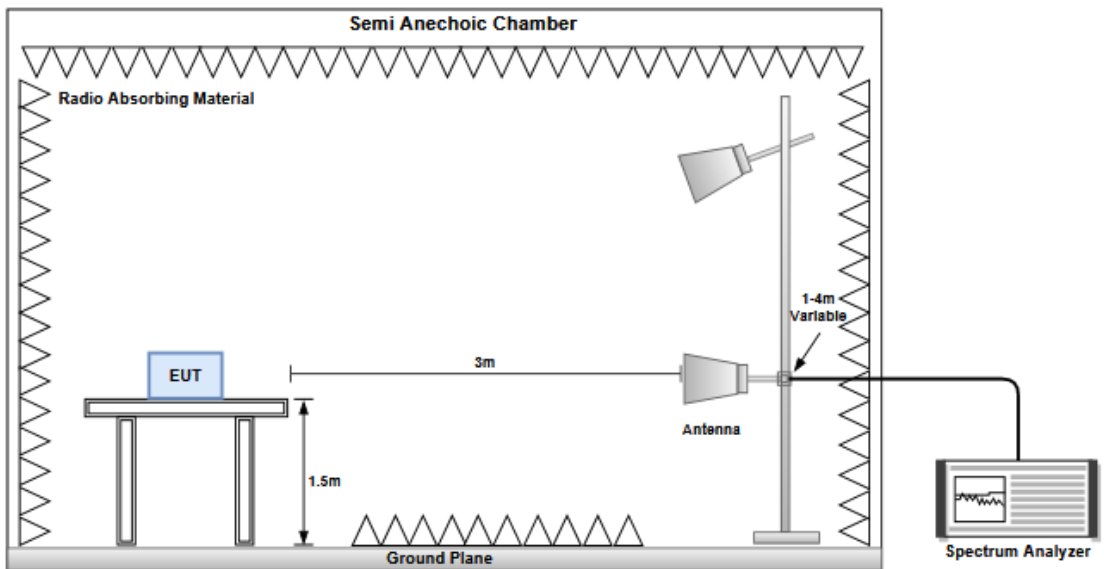

3.4.4 Test Results

Refer to Appendix D.

3.5 Emissions in non-restricted Frequency Bands

3.5.1 Emissions in non-restricted frequency bands limit

Peak power in any 100 kHz bandwidth outside of the authorized frequency band shall be attenuated by at least 20 dB relative to the maximum in-band peak PSD level in 100 kHz.

3.5.2 Test Procedures

Reference level measurement

1. Set RBW=100kHz, VBW = 300kHz , Detector = Peak, Sweep time = Auto
2. Trace = max hold , Allow Trace to fully stabilize
3. Use the peak marker function to determine the maximum PSD level

Emission level measurement

1. Set RBW=100kHz, VBW = 300kHz , Detector = Peak, Sweep time = Auto
2. Trace = max hold , Allow Trace to fully stabilize
3. Scan Frequency range is up to 25GHz
4. Use the peak marker function to determine the maximum amplitude level

3.5.3 Test Setup

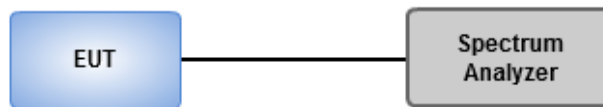

3.5.4 Test Results

Ambient Condition	23°C / 65%	Tested By	Roger Lu
--------------------------	------------	------------------	----------

Refer to Appendix E.

3.6 AC Power Line Conducted Emissions

3.6.1 Limit of AC Power Line Conducted Emissions

Conducted Emissions Limit		
Frequency Emission (MHz)	Quasi-Peak	Average
0.15-0.5	66 - 56 *	56 - 46 *
0.5-5	56	46
5-30	60	50

Note 1: * Decreases with the logarithm of the frequency.

3.6.2 Test Procedures

1. The device is placed on a test table, raised 80 cm above the reference ground plane. The vertical conducting plane is located 40 cm to the rear of the device.
2. The device is connected to line impedance stabilization network (LISN) and other accessories are connected to other LISN. Measured levels of AC power line conducted emission are across the 50 Ω LISN port.
3. AC conducted emission measurements is made over frequency range from 150 kHz to 30 MHz.
4. This measurement was performed with AC 120V/60Hz

3.6.3 Test Setup

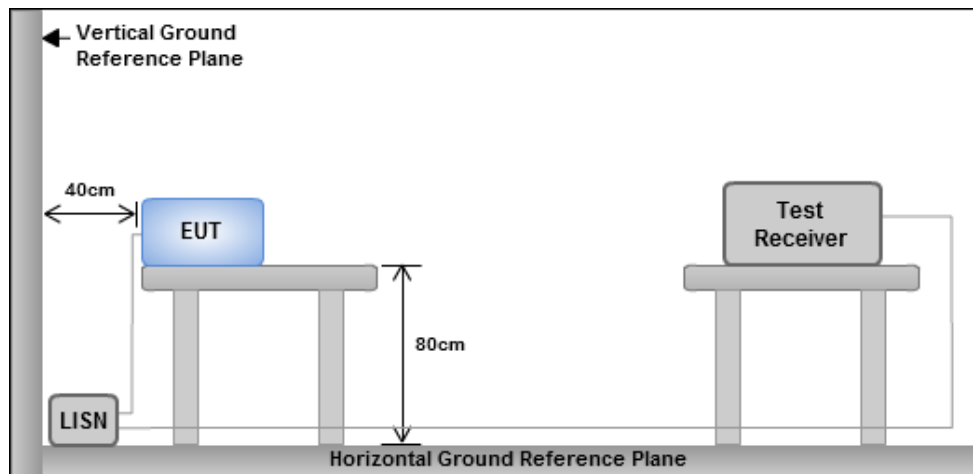

- Note: 1. Support units were connected to second LISN.
 2. Both of LISNs (AMN) are 80 cm from EUT and at least 80 cm from other units and other metal planes

3.6.4 Test Results

Refer to Appendix F.

4 Test laboratory information

Established in 2012, ICC provides foremost EMC & RF Testing and advisory consultation services by our skilled engineers and technicians. Our services employ a wide variety of advanced edge test equipment and one of the widest certification extents in the business.

International Certification Corporation (EMC and Wireless Communication Laboratory), it is our definitive objective is to institute long term, trust-based associations with our clients. The expectation we set up with our clients is based on outstanding service, practical expertise and devotion to a certified value structure. Our passion is to grant our clients with best EMC / RF services by oriented knowledgeable and accommodating staff.

Our Test sites are located at Linkou District and Kwei Shan District. Location map can be found on our website <http://www.icertifi.com.tw>.

Linkou

Tel: 886-2-2601-1640

No.30-2, Ding Fwu Tsuen, Lin Kou
District, New Taipei City, Taiwan
(R.O.C.)

Kwei Shan

Tel: 886-3-271-8666

No.3-1, Lane 6, Wen San 3rd
St., Kwei Shan Dist., Tao Yuan
City 33381, Taiwan (R.O.C.)
No.2-1, Lane 6, Wen San 3rd
St., Kwei Shan Dist., Tao Yuan
City 33381, Taiwan (R.O.C.)

Kwei Shan Site II

Tel: 886-3-271-8640

No.14-1, Lane 19, Wen San 3rd
St., Kwei Shan Dist., Tao Yuan
City 333, Taiwan (R.O.C.)

If you have any suggestion, please feel free to contact us as below information.

Tel: 886-3-271-8666

Fax: 886-3-318-0155

Email: ICC_Service@icertifi.com.tw

==END==



Summary

Mode	Max-N dB (Hz)	Max-OBW (Hz)	ITU-Code	Min-N dB (Hz)	Min-OBW (Hz)
2.4-2.4835GHz	-	-	-	-	-
BT-LE(1Mbps)	699.275k	1.038M	1M04F1D	677.536k	1.035M

Max-N dB = Maximum 6dB down bandwidth; Max-OBW = Maximum 99% occupied bandwidth;
Min-N dB = Minimum 6dB down bandwidth; Min-OBW = Minimum 99% occupied bandwidth

Result

Mode	Result	Limit (Hz)	Port 1-N dB (Hz)	Port 1-OBW (Hz)
BT-LE(1Mbps)	-	-	-	-
2402MHz	Pass	500k	699.275k	1.035M
2440MHz	Pass	500k	688.406k	1.038M
2480MHz	Pass	500k	677.536k	1.035M

Port X-N dB = Port X 6dB down bandwidth;
Port X-OBW = Port X 99% occupied bandwidth



BT-LE(1Mbps)

EBW-DTS

2402MHz

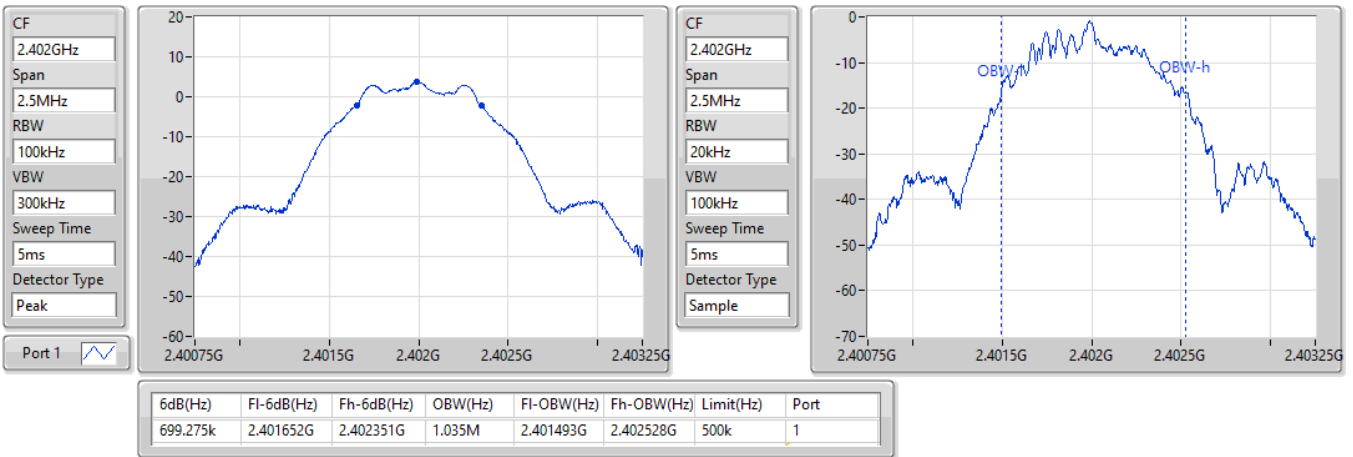

BT-LE(1Mbps)

EBW-DTS

2440MHz

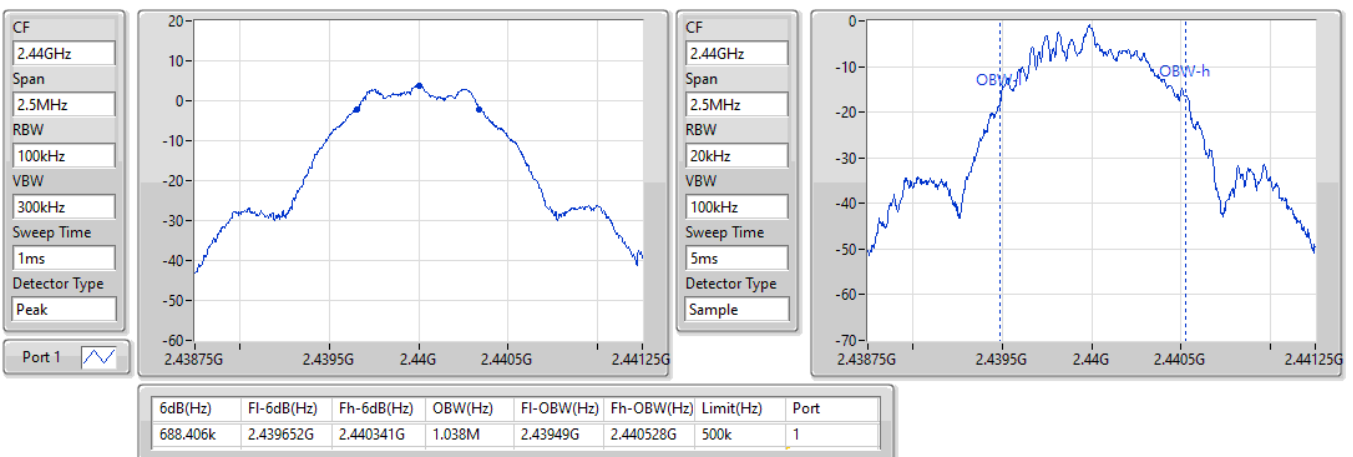

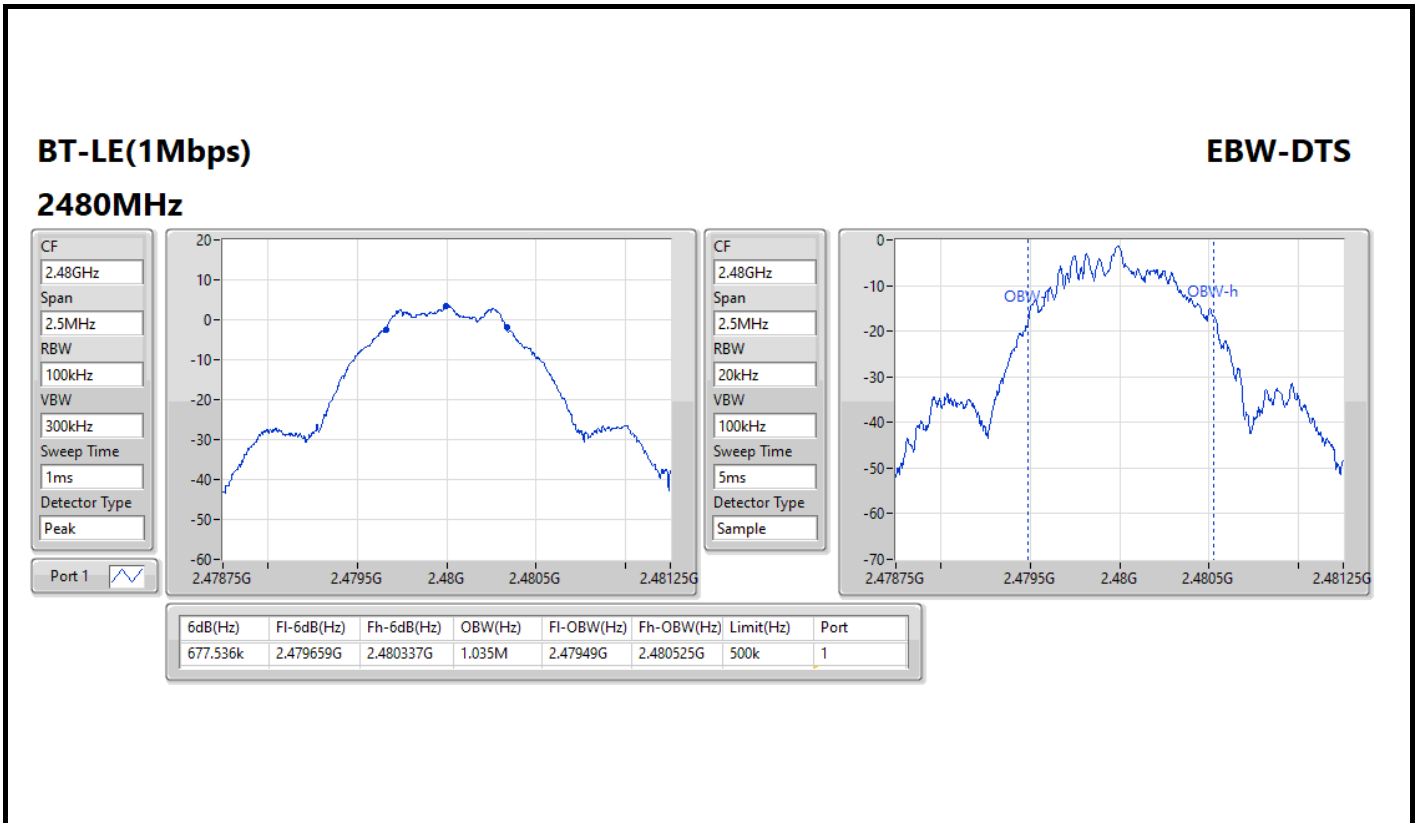



Summary

Mode	Power (dBm)	Power (W)
2.4-2.4835GHz	-	-
BT-LE(1Mbps)	4.16	0.00261

Result

Mode	Result	Antenna Gain (dBi)	Power (dBm)	Power Limit (dBm)
BT-LE(1Mbps)	-	-	-	-
2402MHz	Pass	-2.23	4.11	30.00
2440MHz	Pass	-2.23	4.13	30.00
2480MHz	Pass	-2.23	4.16	30.00



Summary

Mode	Power (dBm)	Power (W)
2.4-2.4835GHz	-	-
BT-LE(1Mbps)	4.06	0.00255

Result

Mode	Result	Antenna Gain (dBi)	Power (dBm)	Power Limit (dBm)
BT-LE(1Mbps)	-	-	-	-
2402MHz	Pass	-2.23	4.01	-
2440MHz	Pass	-2.23	4.03	-
2480MHz	Pass	-2.23	4.06	-

Note: Average power is for reference only.



Summary

Mode	PD (dBm/3kHz)
2.4-2.4835GHz	-
BT-LE(1Mbps)	-11.04

Result

Mode	Result	Antenna Gain (dBi)	Power Density (dBm/3kHz)	Power Density Limit (dBm/3kHz)
BT-LE(1Mbps)	-	-	-	-
2402MHz	Pass	-2.23	-11.04	8.00
2440MHz	Pass	-2.23	-11.16	8.00
2480MHz	Pass	-2.23	-11.39	8.00



BT-LE(1Mbps)

PSD

2402MHz

CF
2.402GHz
Span
1.5MHz
RBW
3kHz
VBW
10kHz
Sweep Time
16.7ms
Detector Type
Peak

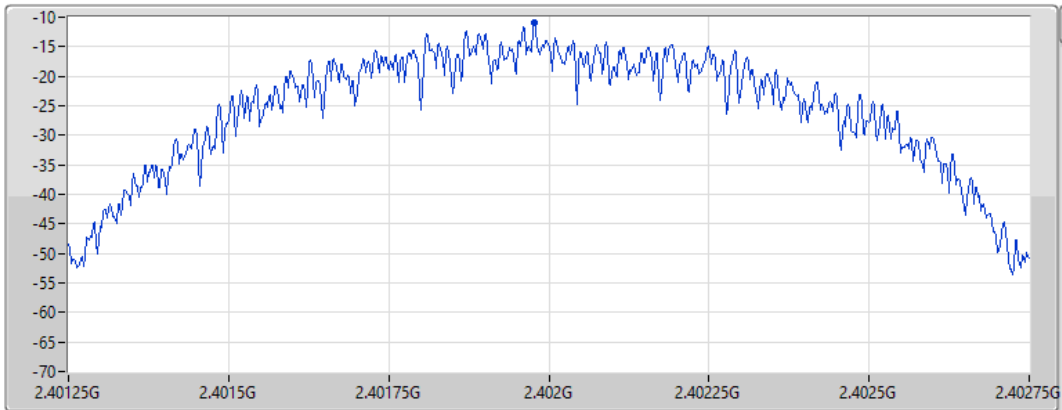

Port 1

Sum	PD	Port 1
(dBm/RBW)	(dBm/RBW)	(dBm/RBW)
-11.04	-11.04	-11.04

BT-LE(1Mbps)

PSD

2440MHz

CF
2.44GHz
Span
1.5MHz
RBW
3kHz
VBW
10kHz
Sweep Time
16.7ms
Detector Type
Peak

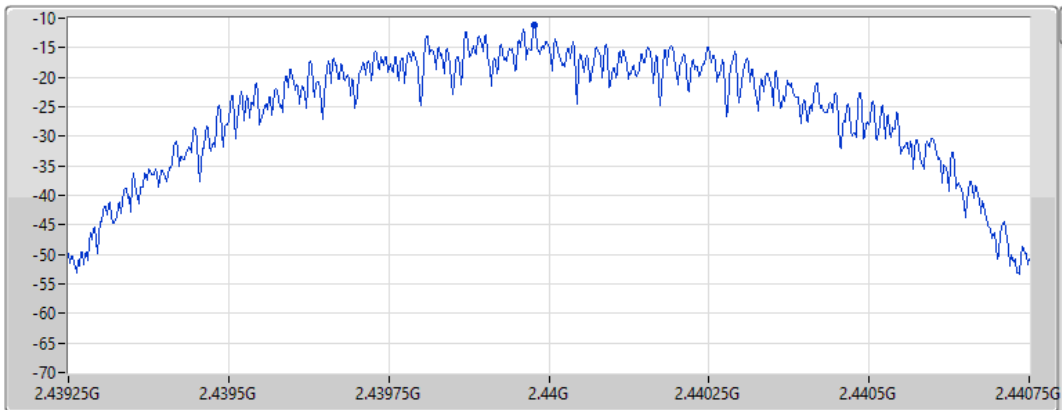

Port 1

Sum	PD	Port 1
(dBm/RBW)	(dBm/RBW)	(dBm/RBW)
-11.16	-11.16	-11.16



BT-LE(1Mbps)

PSD

2480MHz

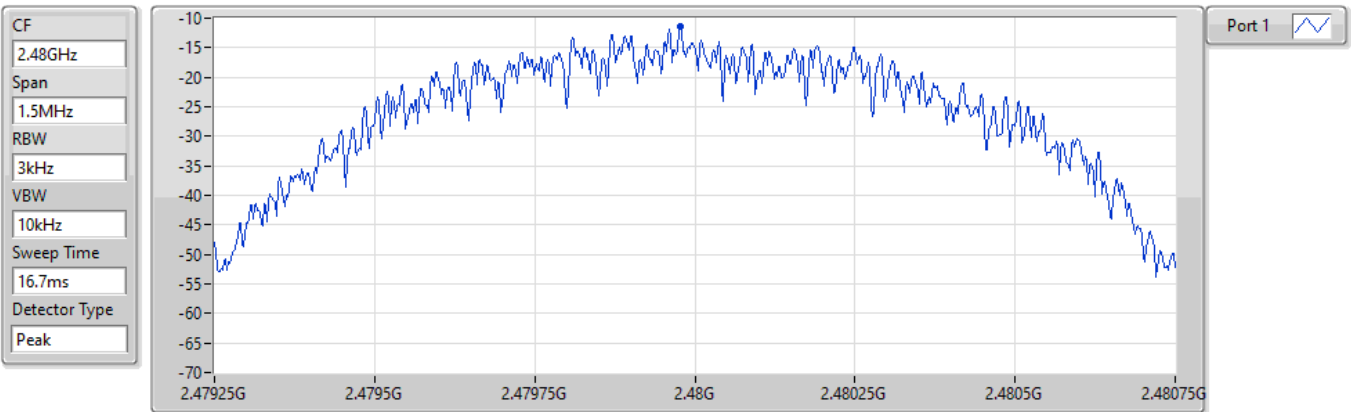

Sum	PD	Port 1
(dBm/RBW)	(dBm/RBW)	(dBm/RBW)
-11.39	-11.39	-11.39



Configuration 2: Battery mode

Unwanted Emissions (Below 1GHz)

Modulation	BT-LE (1Mbps)	Test Freq. (MHz)	2480
Polarization	Horizontal		

Test By :Brad Wu Temperature(°C):24 Humidity(%):65

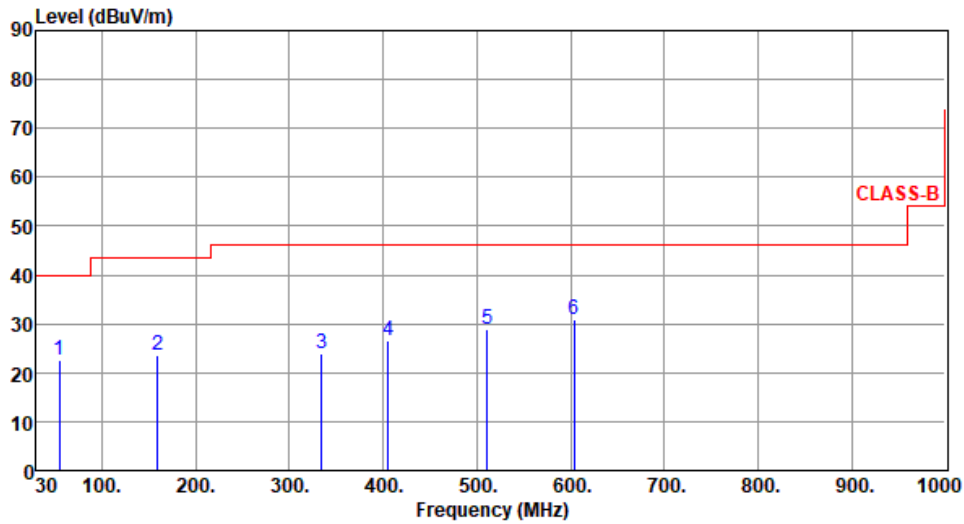

	Freq. MHz	Emission level dBuV/m	Limit dBuV/m	Margin dB	SA reading dBuV	Factor dB/m	Remark	ANT High cm	Turn Table deg
1	54.36	22.61	40.00	-17.39	31.39	-8.78	Peak	---	---
2	159.48	23.65	43.50	-19.85	32.42	-8.77	Peak	---	---
3	334.24	23.81	46.00	-22.19	31.34	-7.53	Peak	---	---
4	405.55	26.45	46.00	-19.55	32.24	-5.79	Peak	---	---
5	511.39	28.99	46.00	-17.01	32.30	-3.31	Peak	---	---
6	603.42	31.02	46.00	-14.98	32.24	-1.22	Peak	---	---

Note 1: Emission Level (dBuV/m) = SA Reading (dBuV) + Factor* (dB/m)

*Factor includes antenna factor , cable loss and amplifier gain

Note 2: Margin (dB) = Emission level (dBuV/m) – Limit (dBuV/m).

Note 3: All spurious emissions below 30MHz are more than 20 dB below the limit.



Modulation	BT-LE (1Mbps)	Test Freq. (MHz)	2480
Polarization	Vertical		

Test By :Brad Wu Temperature(°C):24 Humidity(%):65

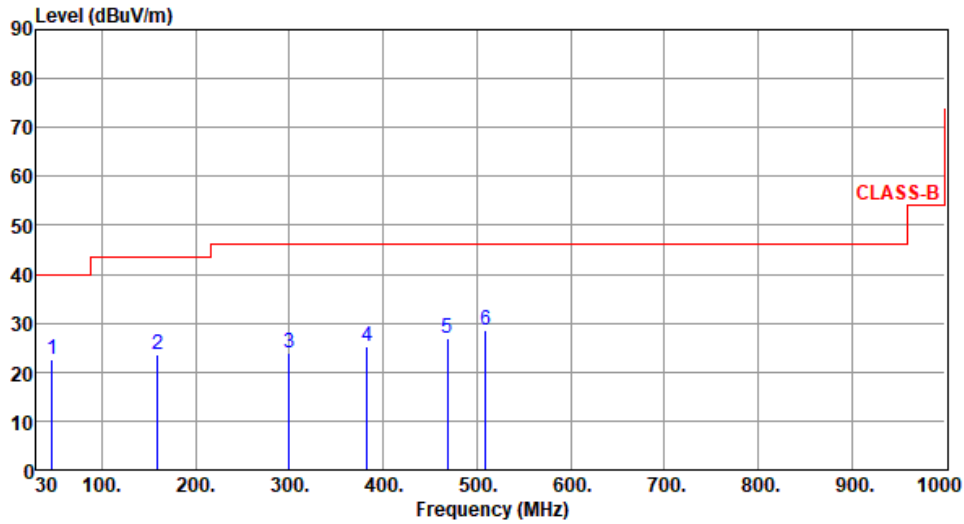

	Freq. MHz	Emission level dBuV/m	Limit dBuV/m	Margin dB	SA reading dBuV	Factor dB/m	Remark	ANT High cm	Turn Table deg
1	46.58	22.65	40.00	-17.35	31.41	-8.76	Peak	---	---
2	159.26	23.48	43.50	-20.02	32.23	-8.75	Peak	---	---
3	299.55	23.94	46.00	-22.06	32.49	-8.55	Peak	---	---
4	383.25	25.11	46.00	-20.89	31.45	-6.34	Peak	---	---
5	468.62	26.98	46.00	-19.02	31.06	-4.08	Peak	---	---
6	509.55	28.44	46.00	-17.56	31.80	-3.36	Peak	---	---

Note 1: Emission Level (dBuV/m) = SA Reading (dBuV) + Factor* (dB/m)

*Factor includes antenna factor , cable loss and amplifier gain

Note 2: Margin (dB) = Emission level (dBuV/m) – Limit (dBuV/m).

Note 3: All spurious emissions below 30MHz are more than 20 dB below the limit.



Unwanted Emissions (Above 1GHz)

Modulation	BT-LE (1Mbps)	Test Freq. (MHz)	2402
Polarization	Horizontal		

Test By :Brad Wu Temperature(°C):24 Humidity(%):65

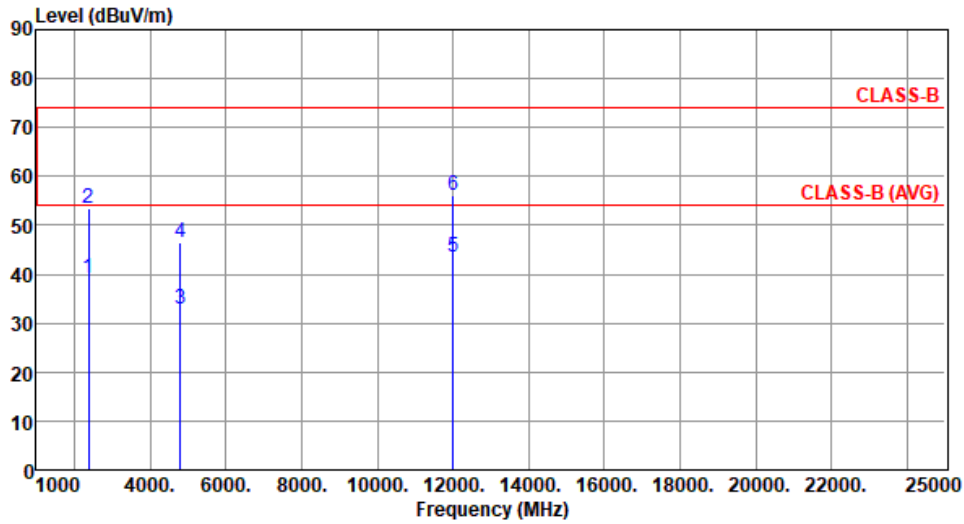

	Freq. MHz	Emission level dBuV/m	Limit dBuV/m	Margin dB	SA reading dBuV	Factor dB/m	Remark	ANT High cm	Turn Table deg
1	2390.00	39.18	54.00	-14.82	41.93	-2.75	Average	142	124
2	2390.00	53.62	74.00	-20.38	56.37	-2.75	Peak	142	124
3	4804.00	32.85	54.00	-21.15	28.72	4.13	Average	245	219
4	4804.00	46.39	74.00	-27.61	42.26	4.13	Peak	245	219
5	12010.00	43.41	54.00	-10.59	29.79	13.62	Average	100	41
6	12010.00	56.22	74.00	-17.78	42.60	13.62	Peak	100	41

Note 1: Emission Level (dBuV/m) = SA Reading (dBuV) + Factor* (dB/m)

*Factor includes antenna factor , cable loss and amplifier gain

Note 2: Margin (dB) = Emission level (dBuV/m) – Limit (dBuV/m).



Modulation	BT-LE (1Mbps)	Test Freq. (MHz)	2402
Polarization	Vertical		

Test By :Brad Wu Temperature(°C):24 Humidity(%):65

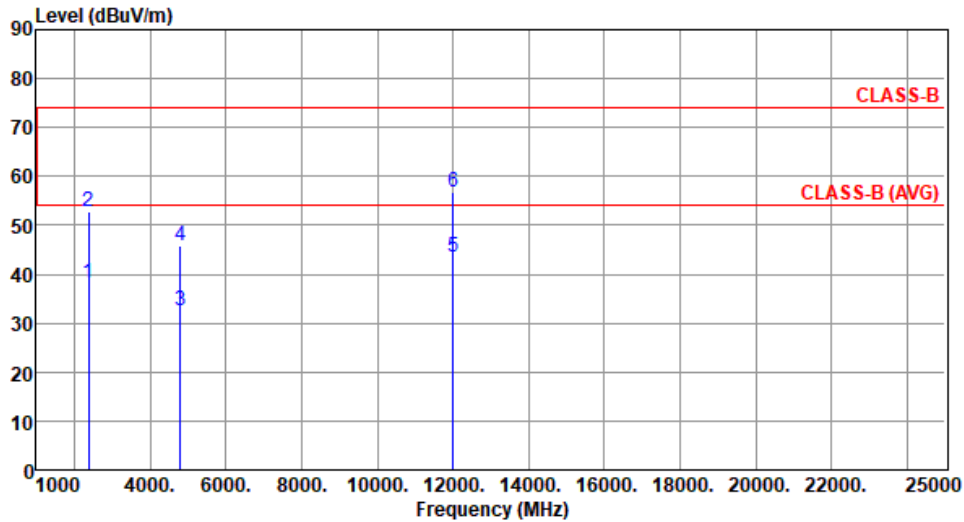

	Freq. MHz	Emission level dBUV/m	Limit dBUV/m	Margin dB	SA reading dBUV	Factor dB/m	Remark	ANT High cm	Turn Table deg
1	2390.00	38.32	54.00	-15.68	41.07	-2.75	Average	196	43
2	2390.00	52.90	74.00	-21.10	55.65	-2.75	Peak	196	43
3	4804.00	32.55	54.00	-21.45	28.42	4.13	Average	100	141
4	4804.00	45.94	74.00	-28.06	41.81	4.13	Peak	100	141
5	12010.00	43.38	54.00	-10.62	29.76	13.62	Average	100	22
6	12010.00	56.93	74.00	-17.07	43.31	13.62	Peak	100	22

Note 1: Emission Level (dBUV/m) = SA Reading (dBUV) + Factor* (dB/m)

*Factor includes antenna factor , cable loss and amplifier gain

Note 2: Margin (dB) = Emission level (dBUV/m) – Limit (dBUV/m).



Modulation	BT-LE (1Mbps)	Test Freq. (MHz)	2440
Polarization	Horizontal		

Test By :Brad Wu Temperature(°C):24 Humidity(%):65

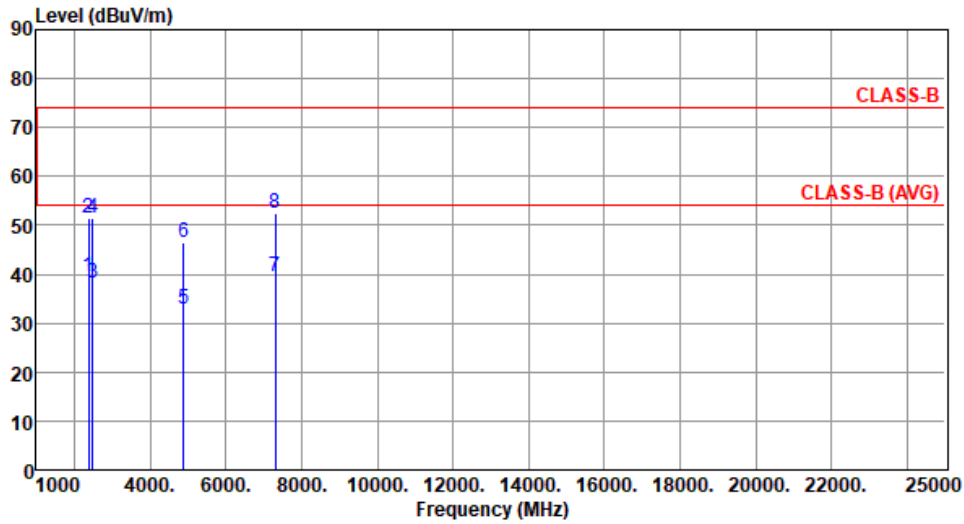

	Freq. MHz	Emission level dBuV/m	Limit dBuV/m	Margin dB	SA reading dBuV	Factor dB/m	Remark	ANT High cm	Turn Table deg
1	2390.00	39.45	54.00	-14.55	42.20	-2.75	Average	149	128
2	2390.00	51.37	74.00	-22.63	54.12	-2.75	Peak	149	128
3	2483.50	38.07	54.00	-15.93	40.77	-2.70	Average	149	128
4	2483.50	51.38	74.00	-22.62	54.08	-2.70	Peak	149	128
5	4880.00	32.96	54.00	-21.04	28.84	4.12	Average	241	218
6	4880.00	46.48	74.00	-27.52	42.36	4.12	Peak	241	218
7	7320.00	39.40	54.00	-14.60	30.12	9.28	Average	100	55
8	7320.00	52.43	74.00	-21.57	43.15	9.28	Peak	100	55

Note 1: Emission Level (dBuV/m) = SA Reading (dBuV) + Factor* (dB/m)

*Factor includes antenna factor , cable loss and amplifier gain

Note 2: Margin (dB) = Emission level (dBuV/m) – Limit (dBuV/m).



Modulation	BT-LE (1Mbps)	Test Freq. (MHz)	2440
Polarization	Vertical		

Test By :Brad Wu Temperature(°C):24 Humidity(%):65

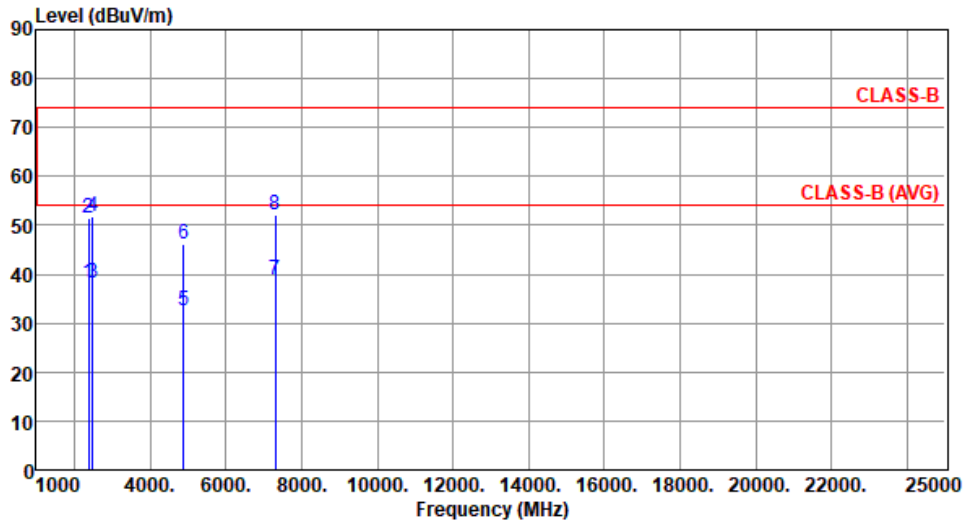

	Freq. MHz	Emission level dBuV/m	Limit dBuV/m	Margin dB	SA reading dBuV	Factor dB/m	Remark	ANT High cm	Turn Table deg
1	2390.00	38.24	54.00	-15.76	40.99	-2.75	Average	214	54
2	2390.00	51.39	74.00	-22.61	54.14	-2.75	Peak	214	54
3	2483.50	38.10	54.00	-15.90	40.80	-2.70	Average	214	54
4	2483.50	51.96	74.00	-22.04	54.66	-2.70	Peak	214	54
5	4880.00	32.62	54.00	-21.38	28.50	4.12	Average	100	135
6	4880.00	46.02	74.00	-27.98	41.90	4.12	Peak	100	135
7	7320.00	38.96	54.00	-15.04	29.68	9.28	Average	100	25
8	7320.00	52.09	74.00	-21.91	42.81	9.28	Peak	100	25

Note 1: Emission Level (dBuV/m) = SA Reading (dBuV) + Factor* (dB/m)

*Factor includes antenna factor , cable loss and amplifier gain

Note 2: Margin (dB) = Emission level (dBuV/m) – Limit (dBuV/m).



Modulation	BT-LE (1Mbps)	Test Freq. (MHz)	2480
Polarization	Horizontal		

Test By :Brad Wu Temperature(°C):24 Humidity(%):65

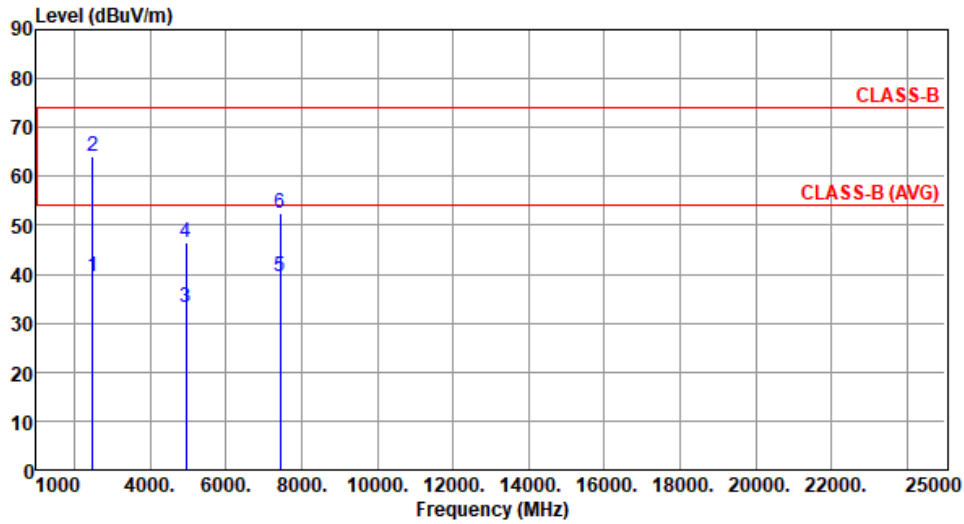

	Freq. MHz	Emission level dBuV/m	Limit dBuV/m	Margin dB	SA reading dBuV	Factor dB/m	Remark	ANT High cm	Turn Table deg
1	2483.50	39.47	54.00	-14.53	42.17	-2.70	Average	139	124
2	2483.50	64.13	74.00	-9.87	66.83	-2.70	Peak	139	124
3	4960.00	33.25	54.00	-20.75	29.22	4.03	Average	239	221
4	4960.00	46.58	74.00	-27.42	42.55	4.03	Peak	239	221
5	7440.00	39.56	54.00	-14.44	30.19	9.37	Average	100	62
6	7440.00	52.58	74.00	-21.42	43.21	9.37	Peak	100	62

Note 1: Emission Level (dBuV/m) = SA Reading (dBuV) + Factor* (dB/m)

*Factor includes antenna factor , cable loss and amplifier gain

Note 2: Margin (dB) = Emission level (dBuV/m) – Limit (dBuV/m).



Modulation	BT-LE (1Mbps)	Test Freq. (MHz)	2480
Polarization	Vertical		

Test By :Brad Wu Temperature(°C):24 Humidity(%):65

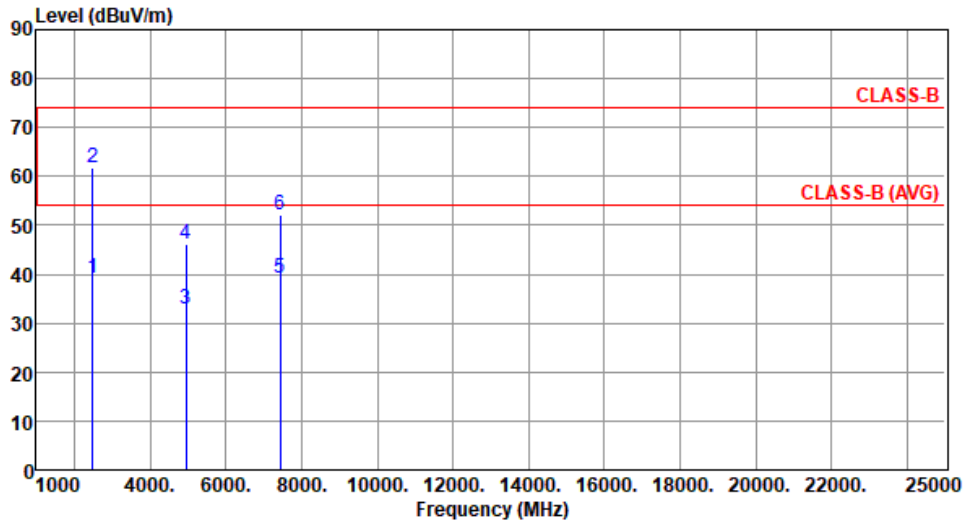

	Freq. MHz	Emission level dBuV/m	Limit dBuV/m	Margin dB	SA reading dBuV	Factor dB/m	Remark	ANT High cm	Turn Table deg
1	2483.50	39.35	54.00	-14.65	42.05	-2.70	Average	194	53
2	2483.50	61.81	74.00	-12.19	64.51	-2.70	Peak	194	53
3	4960.00	32.75	54.00	-21.25	28.72	4.03	Average	100	132
4	4960.00	46.14	74.00	-27.86	42.11	4.03	Peak	100	132
5	7440.00	39.11	54.00	-14.89	29.74	9.37	Average	100	34
6	7440.00	52.16	74.00	-21.84	42.79	9.37	Peak	100	34

Note 1: Emission Level (dBuV/m) = SA Reading (dBuV) + Factor* (dB/m)

*Factor includes antenna factor , cable loss and amplifier gain

Note 2: Margin (dB) = Emission level (dBuV/m) – Limit (dBuV/m).



Configuration 1: Charging mode

Unwanted Emissions (Below 1GHz)

Modulation	Charging	Test Freq. (MHz)	---
Polarization	Horizontal		

Test By :Akun Chung Temperature(°C):25 Humidity(%):63

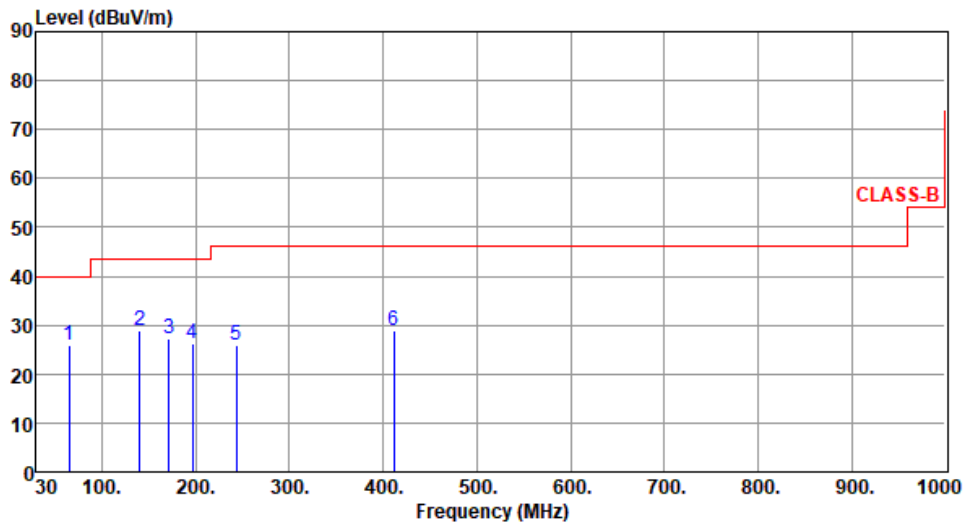

	Freq. MHz	Emission level dBuV/m	Limit dBuV/m	Margin dB	SA reading dBuV	Factor dB/m	Remark	ANT High cm	Turn Table deg
1	64.92	26.01	40.00	-13.99	36.34	-10.33	Peak	---	---
2	140.58	29.04	43.50	-14.46	38.63	-9.59	Peak	---	---
3	171.62	27.18	43.50	-16.32	36.72	-9.54	Peak	---	---
4	196.84	26.25	43.50	-17.25	38.36	-12.11	Peak	---	---
5	243.40	25.89	46.00	-20.11	36.24	-10.35	Peak	---	---
6	411.21	29.03	46.00	-16.97	34.70	-5.67	Peak	---	---

Note 1: Emission Level (dBuV/m) = SA Reading (dBuV) + Factor* (dB/m)

*Factor includes antenna factor , cable loss and amplifier gain

Note 2: Margin (dB) = Emission level (dBuV/m) – Limit (dBuV/m).

Note 3: All spurious emissions below 30MHz are more than 20 dB below the limit.



Modulation	Charging	Test Freq. (MHz)	---
Polarization	Vertical		

Test By :Akun Chung Temperature(°C):25 Humidity(%):63

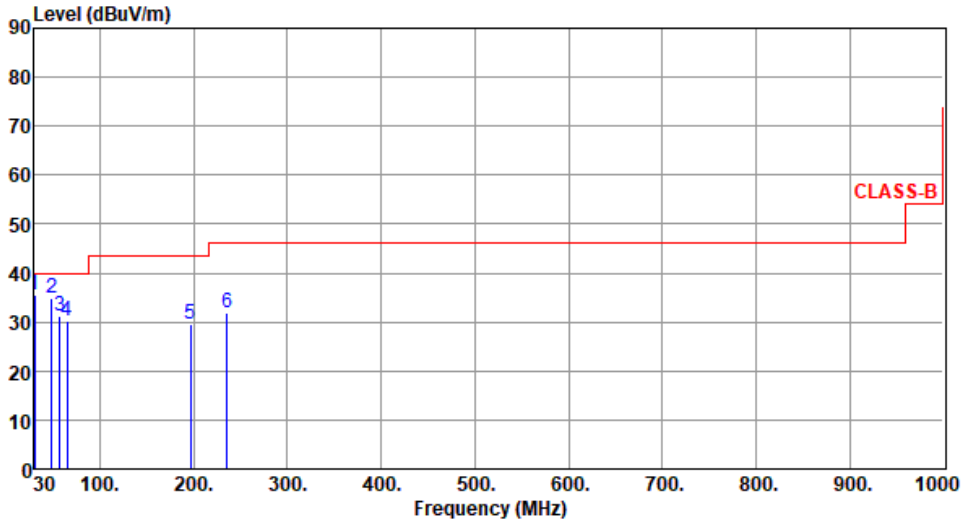

	Freq. MHz	Emission level dBuV/m	Limit dBuV/m	Margin dB	SA reading dBuV	Factor dB/m	Remark	ANT High cm	Turn Table deg
1	30.00	35.40	40.00	-4.60	45.56	-10.16	Peak	---	---
2	48.43	34.77	40.00	-5.23	43.35	-8.58	Peak	---	---
3	57.16	31.33	40.00	-8.67	40.35	-9.02	Peak	---	---
4	64.92	30.23	40.00	-9.77	40.56	-10.33	Peak	---	---
5	196.84	29.71	43.50	-13.79	41.82	-12.11	Peak	---	---
6	235.64	31.83	46.00	-14.17	42.71	-10.88	Peak	---	---

Note 1: Emission Level (dBuV/m) = SA Reading (dBuV) + Factor* (dB/m)

*Factor includes antenna factor , cable loss and amplifier gain

Note 2: Margin (dB) = Emission level (dBuV/m) – Limit (dBuV/m).

Note 3: All spurious emissions below 30MHz are more than 20 dB below the limit.

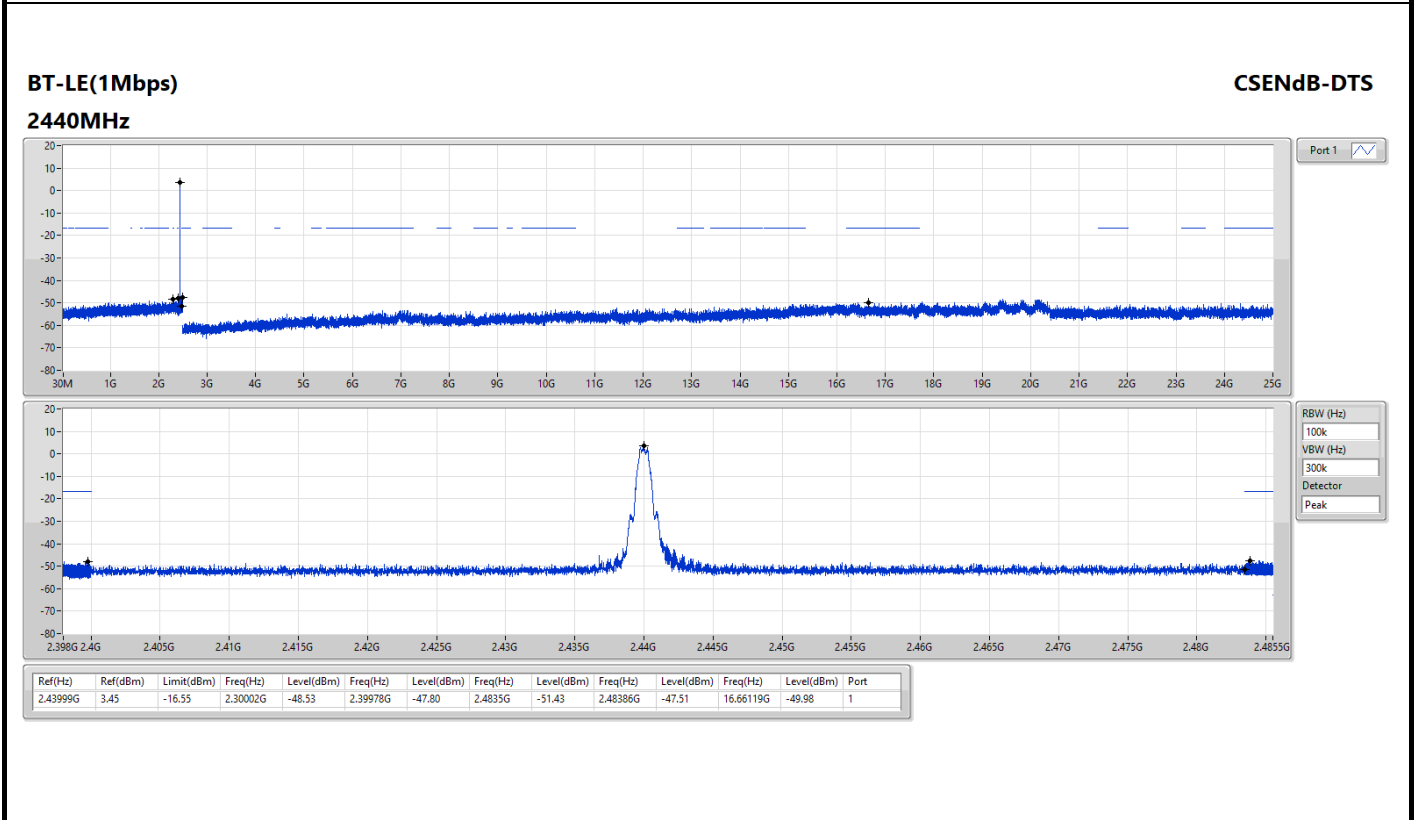
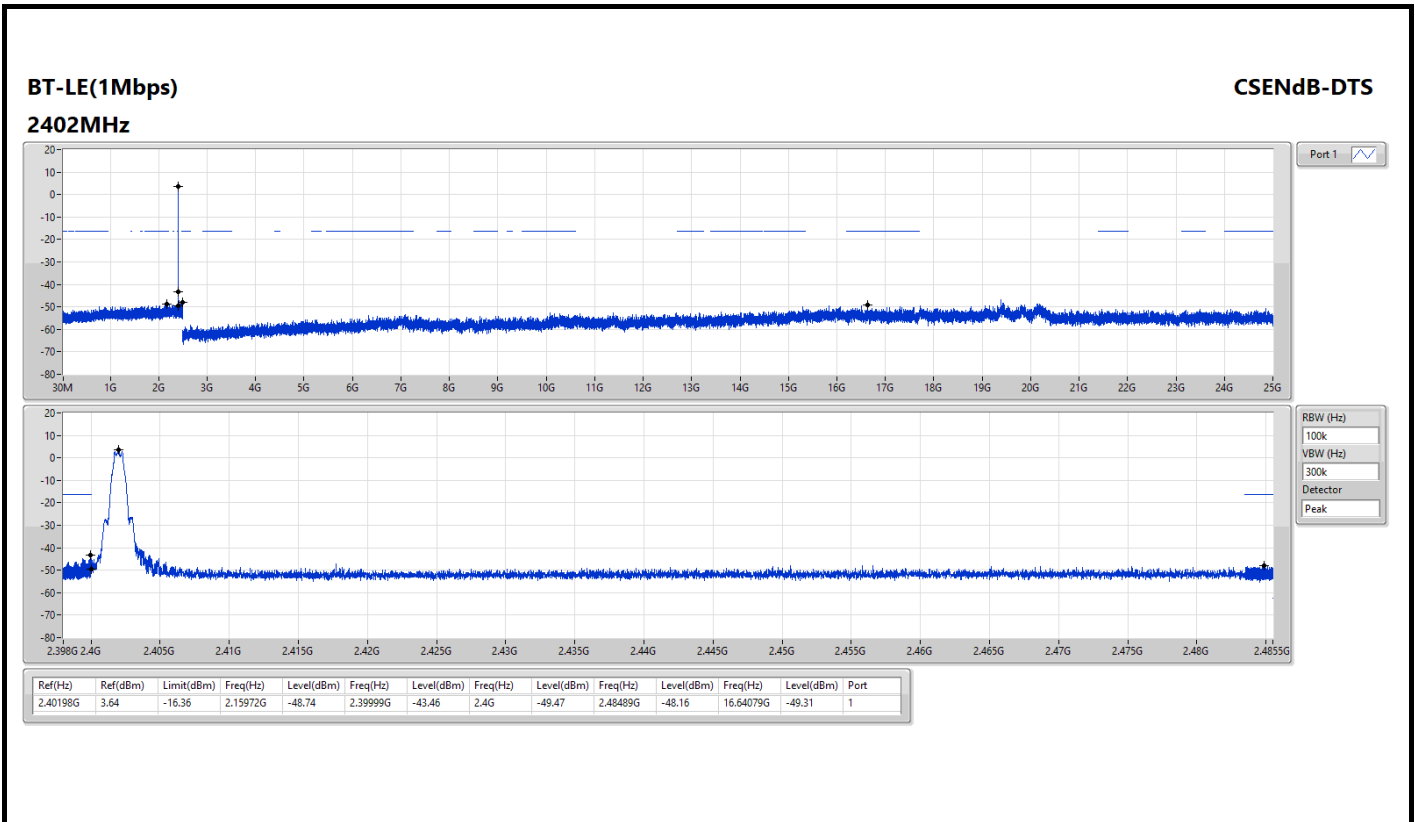

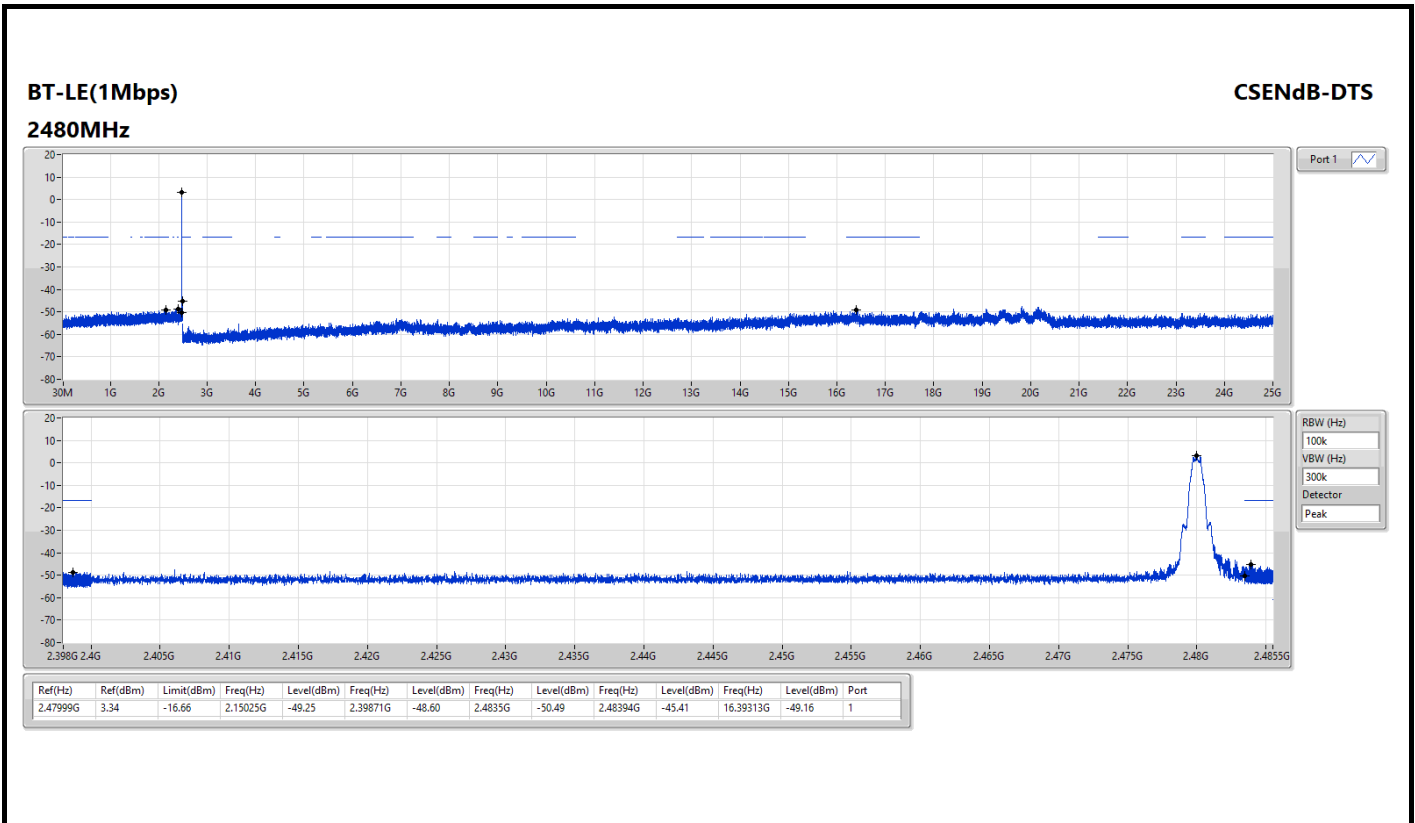



Modulation	Charging
Power Phase	Line

Test by : Joe Liao Temperature: 26°C Humidity: 62%

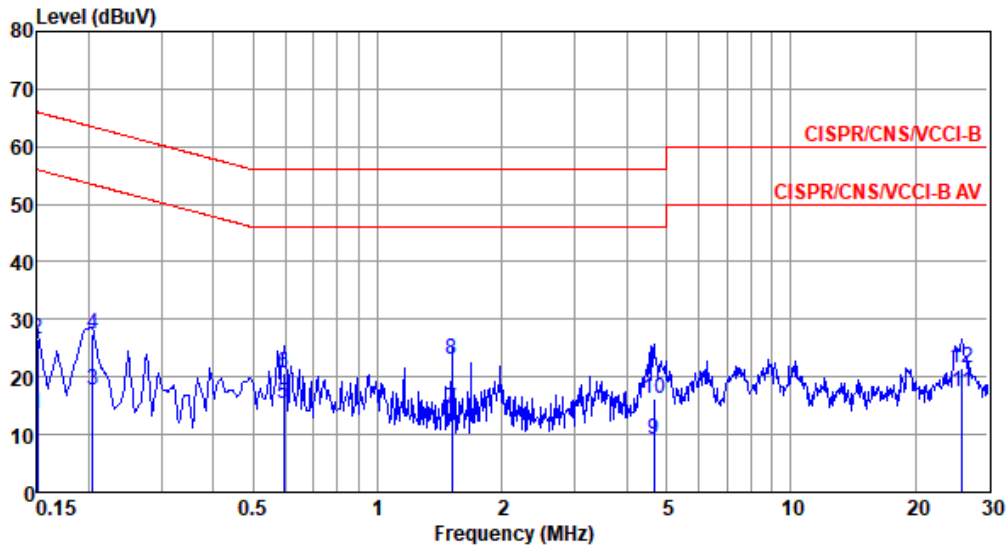

	Freq MHz	Level dBuV	Limit Line dBuV	Over Limit dB	Read Level dBuV	Factor dB	Cable loss dB	Aux dB	Remark
1	0.150	13.66	56.00	-42.34	3.70	9.68	0.08	0.20	Average
2	0.150	26.54	66.00	-39.46	16.58	9.68	0.08	0.20	QP
3	0.204	17.76	53.45	-35.69	7.78	9.68	0.08	0.22	Average
4	0.204	27.60	63.45	-35.85	17.62	9.68	0.08	0.22	QP
5*	0.592	15.49	46.00	-30.51	5.35	9.67	0.11	0.36	Average
6	0.592	20.65	56.00	-35.35	10.51	9.67	0.11	0.36	QP
7	1.511	14.60	46.00	-31.40	4.35	9.69	0.18	0.38	Average
8	1.511	22.96	56.00	-33.04	12.71	9.69	0.18	0.38	QP
9	4.672	9.12	46.00	-36.88	-1.26	9.71	0.25	0.42	Average
10	4.672	16.36	56.00	-39.64	5.98	9.71	0.25	0.42	QP
11	26.001	17.42	50.00	-32.58	6.30	9.69	0.71	0.72	Average
12	26.001	21.60	60.00	-38.40	10.48	9.69	0.71	0.72	QP

Note 1: Level (dBuV) = Read Level (dBuV) + LISN Factor (dB) + Cable Loss (dB) + Aux (dB).
 Note 2: Over Limit (dB) = Level (dBuV) - Limit Line (dBuV).



Modulation	Charging
Power Phase	Neutral

Test by : Joe Liao Temperature: 26°C Humidity: 62%

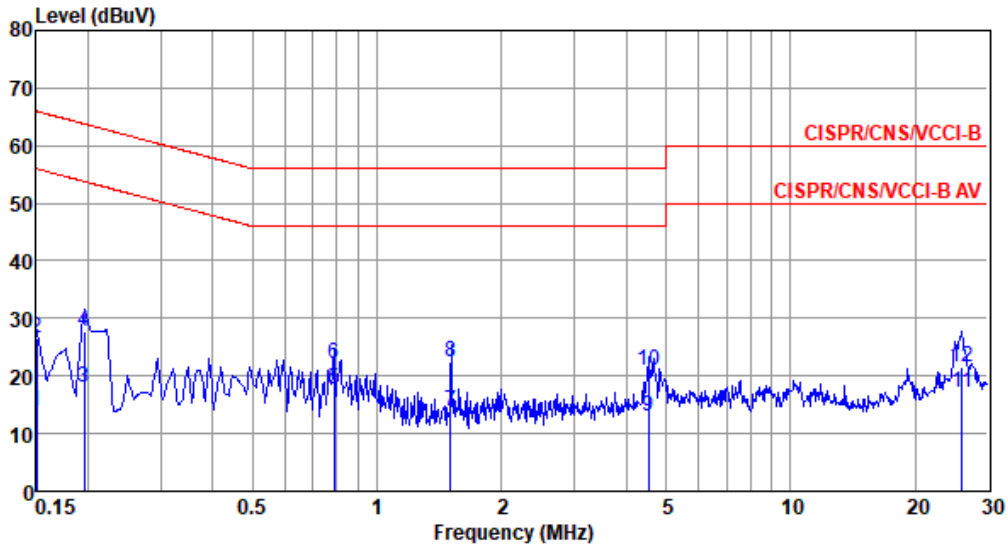

	Freq MHz	Level dBuV	Limit Line dBuV	Over Limit dB	Read Level dBuV	Factor dB	Cable loss dB	Aux dB	Remark
1	0.150	13.98	56.00	-42.02	4.13	9.61	0.08	0.16	Average
2	0.150	26.52	66.00	-39.48	16.67	9.61	0.08	0.16	QP
3	0.195	18.12	53.80	-35.68	8.25	9.61	0.08	0.18	Average
4	0.195	27.67	63.80	-36.13	17.80	9.61	0.08	0.18	QP
5*	0.788	17.62	46.00	-28.38	7.61	9.61	0.14	0.26	Average
6	0.788	22.15	56.00	-33.85	12.14	9.61	0.14	0.26	QP
7	1.508	13.76	46.00	-32.24	3.67	9.62	0.18	0.29	Average
8	1.508	22.41	56.00	-33.59	12.32	9.62	0.18	0.29	QP
9	4.525	13.12	46.00	-32.88	2.89	9.65	0.24	0.34	Average
10	4.525	20.85	56.00	-35.15	10.62	9.65	0.24	0.34	QP
11	26.001	17.16	50.00	-32.84	6.08	9.78	0.71	0.59	Average
12	26.001	21.53	60.00	-38.47	10.45	9.78	0.71	0.59	QP

Note 1: Level (dBuV) = Read Level (dBuV) + LISN Factor (dB) + Cable Loss (dB) + Aux (dB).
 Note 2: Over Limit (dB) = Level (dBuV) – Limit Line (dBuV).