

GARMIN®

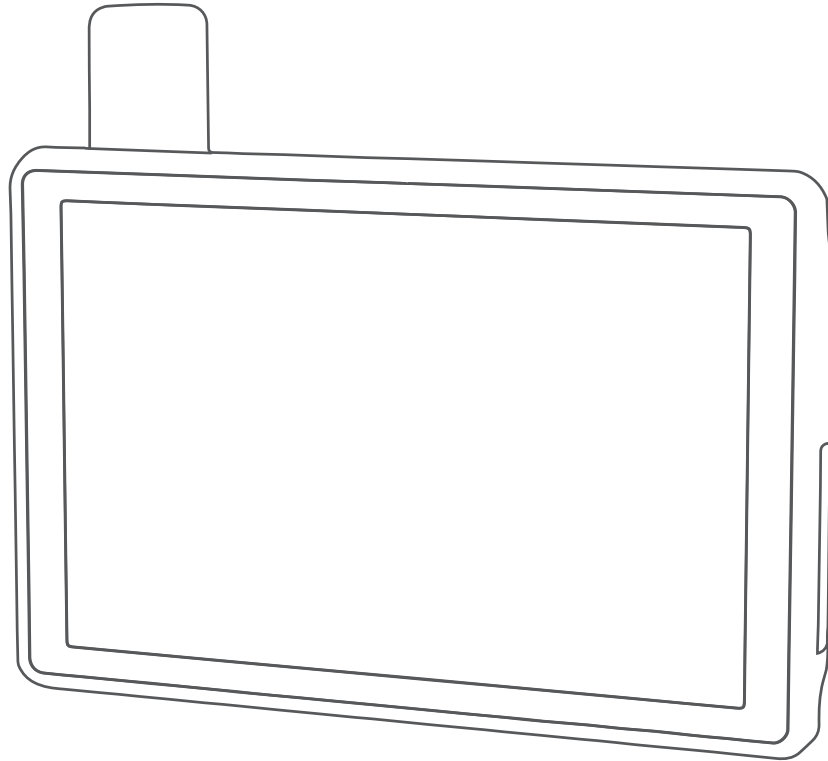

TREAD® - OVERLAND EDITION
TREAD XL - OVERLAND EDITION

Owner's Manual

© 2021 Garmin Ltd. or its subsidiaries

All rights reserved. Under the copyright laws, this manual may not be copied, in whole or in part, without the written consent of Garmin. Garmin reserves the right to change or improve its products and to make changes in the content of this manual without obligation to notify any person or organization of such changes or improvements. Go to www.garmin.com for current updates and supplemental information concerning the use of this product.

Garmin®, the Garmin logo, inReach®, TracBack®, and Tread® are trademarks of Garmin Ltd. or its subsidiaries, registered in the USA and other countries. BaseCamp™, Garmin Adventurous Routing™, Garmin Drive™, Garmin Explore™, Garmin Express™, Garmin PowerSwitch™, and myTrends™ are trademarks of Garmin Ltd. or its subsidiaries. These trademarks may not be used without the express permission of Garmin.

Android™ is a trademark of Google Inc. Apple® and Mac® are trademarks of Apple Inc., registered in the U.S. and other countries. The BLUETOOTH® word mark and logos are owned by the Bluetooth SIG, Inc., and any use of such name by Garmin is under license. iOverlander™ is a trademark of iOverlander. microSD® and the microSD logo are trademarks of SD-3C, LLC. Tripadvisor® is a registered trademark of Tripadvisor LLC. Windows® is a registered trademark of Microsoft Corporation in the United States and other countries. Wi-Fi® is a registered trademark of Wi-Fi Alliance. Other trademarks and trade names are those of their respective owners.

Table of Contents

Getting Started.....	1	Group Ride Settings.....	11
Device Overview.....	1	Radio.....	11
Mounting and Powering the Device in Your Vehicle.....	2	Selecting a Preset.....	12
Turning the Device On or Off.....	3	Selecting a Radio Channel.....	12
Acquiring GPS Signals.....	4	Adjusting the Squelch.....	12
Status Bar Icons.....	4	Adding a Custom Radio Preset.....	12
Using the Touchscreen.....	4	Selecting a Roger Tone.....	12
Using the On-Screen Buttons.....	4	Turning the Radio Off.....	12
Adjusting the Screen Brightness.....	5	Enabling Push-to-Talk with a Headset.....	12
Vehicle Profiles.....	5	Transmitting Your Voice.....	13
Adding a Vehicle Profile.....	5	Adjusting the Radio Volume.....	13
Choosing a Vehicle Profile.....	5	Radio Settings.....	13
Adding Propane Tanks.....	6	inReach® Features.....	13
Editing a Vehicle Profile.....	6	Messages.....	13
Off-Road Navigation Features.....	6	Sending a Preset inReach Message.....	13
Routes.....	6	Sending a Text Message.....	14
Adventure Roads and Trails.....	7	Replying to a Message.....	14
Straight Line Routes.....	7	Checking for Messages.....	14
Skipping the Next Stop on Your Route.....	8	Navigating to a Message Location..	14
Stopping the Route.....	8	Deleting a Message.....	14
Tracks.....	8	inReach Tracking.....	14
Recording Tracks.....	8	Starting Tracking.....	14
Navigating a Track.....	8	Stopping Tracking.....	14
Viewing Your Collections on the Map.....	8	Sharing Your MapShare Web Page..	15
Pitch and Roll.....	8	inReach Tracking Settings.....	15
Calibrating Pitch and Roll.....	9	SOS.....	15
Adjusting Warning Angles.....	9	Initiating an SOS Rescue.....	16
Enabling or Disabling Warning Angle Alerts.....	9	Canceling an SOS Rescue.....	16
Viewing the Altimeter, Barometer, and Compass.....	9	Syncing inReach Data.....	16
Calibrating the Compass.....	9	Contacts.....	16
Group Ride.....	9	Adding a Contact.....	17
Starting a Group Ride.....	10	Editing a Contact.....	17
Joining a Group Ride.....	10	Deleting a Contact.....	17
Rejoining a Recent Group Ride.....	10	Data Use and History.....	17
Adding Riders to a Group Ride.....	10	Viewing Plan and Usage Details.....	17
Broadcasting a Message.....	10	Using the Map.....	17
Broadcasting a Location.....	11	Map Tools.....	18
Viewing a Group Ride Notification...	11	Viewing a Map Tool.....	18
Exiting a Group Ride.....	11	Up Ahead.....	18
		Viewing Upcoming Locations.....	18
		Customizing the Up Ahead Categories.....	19
		Cities Ahead.....	19

Viewing Upcoming Cities and Exit Services.....	19	Viewing Weather Near a Different City.....	26
Trip Information.....	19	Viewing the Weather Radar.....	26
Viewing Trip Data from the Map.....	19	Viewing Weather Alerts.....	26
Resetting Trip Information.....	19	Checking Road Conditions.....	26
Viewing Upcoming Elevation Changes.....	20	Creating a Round-Trip Route.....	27
Viewing Upcoming Traffic.....	20	Garmin PowerSwitch™ App.....	28
Viewing Traffic on the Map.....	20	Activating a Power Switch.....	28
Searching for Traffic Incidents.....	20	Turning Off All Switches.....	28
Customizing the Map.....	20	Customizing a Button.....	29
Customizing the Map Layers.....	20	Assigning a Switch to a Control Input.....	29
Enabling Adventure Roads and Trails Map Layers.....	21	Adding a Custom Layout.....	29
Changing the Map Data Field.....	21	Routines.....	30
Changing the Map Buttons.....	21		
Changing the Map Perspective.....	21		
Dog Tracking.....	21	Live Services, Traffic, and Smartphone Features.....	31
Receiving Data From Your Handheld Device.....	21	Bluetooth Feature Status Icons.....	32
Tracking Your Dogs.....	21	Pairing with Your Smartphone.....	32
Dog Status Icons.....	22	Tips After Pairing the Devices.....	32
Viewing Your Dogs on the Map.....	22	Pairing Additional Bluetooth Devices.....	32
		Smart Notifications.....	32
		Receiving Notifications.....	33
		Viewing the List of Notifications.....	33
		Hands-Free Calling.....	34
		Placing a Call.....	34
		Using In-Call Options.....	34
		Saving a Phone Number as a Preset.....	34
		Enabling or Disabling Bluetooth Features.....	34
		Showing or Hiding App Notifications (Android™).....	34
		Showing or Hiding Notification Categories for Your Apple® Device.....	35
		Enabling or Disabling Bluetooth Features for Your Headset.....	35
		Disconnecting a Bluetooth Device.....	35
		Deleting a Paired Phone.....	35
Using the Apps.....	22	Street Navigation.....	35
Viewing the Owner's Manual on Your Device.....	22	Starting a Route.....	35
Music Player.....	23	Starting a Route by Using the Map... Your Route on the Map.....	36
Adding the Music Player Tool to the Map.....	23	Active Lane Guidance.....	37
BirdsEye Imagery.....	23		
Downloading BirdsEye Imagery.....	24		
Route Planner.....	24		
Planning a Route.....	24		
Editing and Reordering Locations in a Route.....	24		
Changing Routing Options for a Route.....	25		
Navigating to a Saved Route.....	25		
Editing and Saving Your Active Route.....	25		
TracBack®.....	25		
Following Your Recent Track.....	25		
Saving Your Recent Track as a Route.....	25		
Viewing the Weather Forecast.....	26		

Viewing Turns and Directions.....	37	Finding Adventure Points.....	45
Viewing the Entire Route on the Map.....	37	Tripadvisor.....	45
Changing Your Active Route.....	38	Finding Parking Near Your Current Location.....	46
Adding a Location to Your Route.....	38	Finding Parking Near a Specified Location.....	46
Shaping Your Route.....	38	Search Tools.....	46
Avoiding Delays, Tolls, and Areas.....	38	Finding an Address.....	46
Avoiding Traffic Delays on Your Route.....	38	Finding an Intersection.....	46
Avoiding Toll Roads.....	38	Finding a Location Using Coordinates.....	47
Avoiding Toll Stickers.....	39	Finding Fuel Stations and Prices.....	47
Avoiding Road Features.....	39	Viewing Recently Found Locations.....	47
Custom Avoidances.....	39	Clearing the List of Recently Found Locations.....	47
Arriving at Your Destination.....	40	Viewing Current Location Information.....	47
Changing the Route Calculation Mode.....	40	Finding Emergency Services and Fuel.....	47
Taking a Route Using Garmin Adventurous Routing™.....	40	Getting Directions to Your Current Location.....	47
Taking a Detour.....	40	Adding a Shortcut.....	48
Going Home.....	40	Removing a Shortcut.....	48
Editing Your Home Location.....	40	Saving Locations.....	48
Parking Near Your Destination.....	41	Saving a Location.....	48
Traffic.....	41	Saving a Waypoint on the Map.....	48
Receiving Traffic Data Using Your Smartphone.....	41	Saving Your Current Location.....	48
Viewing Traffic on the Map.....	41	Editing a Saved Location.....	49

Finding and Saving Locations..... 42

Finding a Location Using the Search Bar.....	42
Location Search Results.....	43
Changing the Search Area.....	43
Finding a Location by Category.....	43
Navigating to Points of Interest Within a Venue.....	44
Points of Interest.....	44
Viewing Your Garmin Explore Waypoints.....	44
Finding National Parks.....	44
Finding Campgrounds.....	44
Finding Ultimate Campgrounds Points of Interest.....	45
Finding RV Parks.....	45
Finding RV Services.....	45
Finding iOverlander™ Points of Interest.....	45
Finding Powersport Points of Interest.....	45

Driver Awareness Features and Alerts..... 50

Enabling or Disabling Driver Alerts.....	50
--	----

Settings..... 51

Navigation Settings.....	51
Map and Vehicle Settings.....	51
Enabling Maps.....	51
Connecting to a Wireless Network.....	51
Enabling Bluetooth Wireless Technology.....	51
Driver Assistance Settings.....	52
Traffic Settings.....	52
Display Settings.....	52
Adjusting Sound and Notification Volume.....	52

Setting the Text Language.....	52	Garmin PowerSwitch	
Date and Time Settings.....	52	Specifications.....	64
Device Settings.....	53	Troubleshooting.....	64
Enabling or Disabling Location		Data Management.....	65
Services.....	53	About Memory Cards.....	65
Device Information.....	53	Installing a Memory Card for Maps	
Viewing E-label Regulatory and		and Data.....	65
Compliance Information.....	53	Formatting the Memory Card.....	65
Tread - Overland Edition		Connecting the Device to Your	
Specifications.....	53	Computer.....	65
Charging the Device.....	53	Transferring GPX Files From Your	
Device Maintenance.....	53	Computer.....	65
Garmin Support Center.....	53	Transferring Data From Your	
Map and Software Updates.....	54	Computer.....	66
Updating Maps and Software Using a		Disconnecting the USB Cable.....	66
Wi-Fi Network.....	54	Adding BaseCamp™ Data to Garmin	
Product Updates.....	55	Explore.....	66
Device Care.....	57	Purchasing Additional Maps.....	67
Cleaning the Outer Casing.....	57	Index.....	68
Cleaning the Touchscreen.....	57		
Avoiding Theft.....	57		
Restarting the Device.....	57		
Removing the Device from the			
Mount.....	57		
Troubleshooting.....	57		
My device is not acquiring satellite			
signals.....	57		
My battery does not stay charged for			
very long.....	58		
My device does not connect to my			
phone.....	58		
My device does not appear as a			
removable drive on my computer.....	58		
Appendix.....	58		
Garmin PowerSwitch.....	58		
Mounting Considerations.....	58		
Mounting the Device.....	59		
Opening the Front Cover.....	60		
Connecting Accessories.....	61		
Connecting a Control Input.....	62		
Connecting the Device to Vehicle			
Power.....	63		
Pairing with a Garmin Navigation			
Device.....	64		

Getting Started

⚠ WARNING

See the *Important Safety and Product Information* guide in the product box for product warnings and other important information.

- Update the maps and software on your device ([Updating Maps and Software Using a Wi-Fi Network](#), page 54).
- Mount the device in your vehicle and connect it to power ([Mounting and Powering the Device in Your Vehicle](#), page 2).
- Adjust the volume ([Adjusting Sound and Notification Volume](#), page 52) and display brightness ([Adjusting the Screen Brightness](#), page 5).
- Set up a vehicle profile ([Adding a Vehicle Profile](#), page 5).
- Navigate to your destination ([Starting a Route](#), page 35).

Device Overview



①	Power button
②	Volume control
③	microSD® memory card slot
④	USB power and data port
⑤	Iridium® antenna
⑥	SOS button (under protective cover)

Mounting and Powering the Device in Your Vehicle

⚠ WARNING

This product contains a lithium-ion battery. To prevent the possibility of personal injury or product damage caused by battery exposure to extreme heat, store the device out of direct sunlight.

Both the device and its mount contain magnets. Under certain circumstances, magnets may cause interference with some internal medical devices and electronic devices, including pacemakers, insulin pumps, or hard drives in laptop computers. Keep the device away from medical devices and electronic devices.

Before you use your device on battery power, you should charge it.

- 1 Open the lever ①, press the suction cup to the windshield, and flip the lever back toward the windshield. The lever must be oriented toward the top of the windshield.

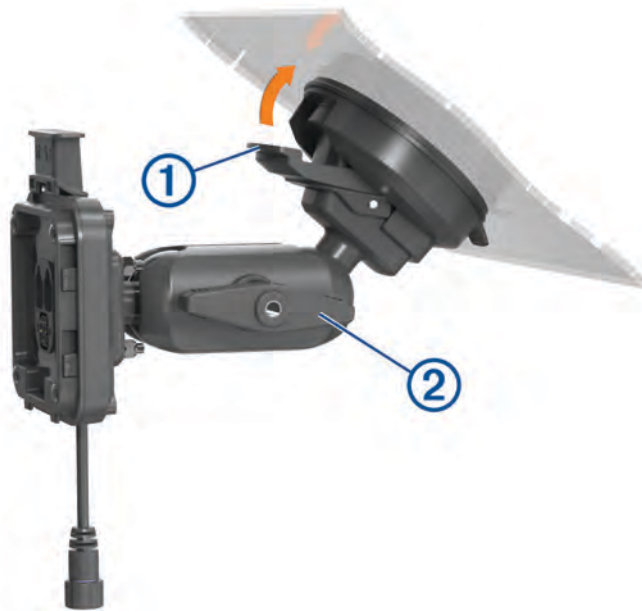

- 2 Tighten the knob ② slightly.
- 3 If necessary, adjust the mount for better viewing and operation.
- 4 Tighten the knob to secure the mount.
- 5 Connect the vehicle power cable ③ to the cable ④ on the mount.



- 6 Tighten the collar around the connected power cables.

- 7 Plug the other end of the vehicle power cable into a power outlet in your vehicle.
- 8 Place the device onto the magnetic mount.



- 9 Push down the lock ⑤ to secure the device to the mount.

Turning the Device On or Off



- To turn the device on, press the power key ①, or connect the device to power.



- To put the device in power saving mode, press the power key while the device is on. While in power saving mode, the screen is off and the device uses very little power, but it can wake instantly for use.
TIP: You can charge your device faster by putting it in power saving mode while charging the battery.
- To turn off the device completely, hold the power key until a prompt appears on the screen, and select **Power off**.







Acquiring GPS Signals

When you turn on your navigation device, the GPS receiver must collect satellite data and establish the current location. The time required to acquire satellite signals varies based on several factors, including how far you are from the location where you last used your navigation device, whether you have a clear view of the sky, and how long it has been since you last used your navigation device. The first time you turn on your navigation device, it may take several minutes to acquire satellite signals.

- 1 Turn on the device.
- 2 Verify  appears in the status bar, and enable location services if it does not ([Enabling or Disabling Location Services, page 53](#)).
- 3 If necessary, go to an open area with a clear view of the sky, away from tall buildings and trees.  appears at the top of the navigation map until the device determines your location.

Status Bar Icons

The status bar is located at the top of the main menu. The status bar icons display information about features on the device. You can select some icons to change settings or view additional information.







	Location services status. Indicates your location has been established.
	Bluetooth® technology status.
	Wi-Fi® signal strength.
	Active vehicle profile.
9:10	Current time.
	Battery charge level.
	Tread app connection status (Pairing with Your Smartphone, page 32).

Using the Touchscreen

- Tap the screen to select an item.
- Drag or swipe your finger across the screen to pan or scroll.
- Pinch two fingers together to zoom out.
- Spread two fingers apart to zoom in.

Using the On-Screen Buttons

On-screen buttons allow you to navigate the pages, menus, and menu options on your device.

- Select  to return to the previous menu screen.
- Hold  to quickly return to the main menu.
- Select  or  to scroll through lists or menus.
- Hold  or  to scroll faster.
- Select  to see a context-based menu of options for the current screen.

Adjusting the Screen Brightness

You can adjust the brightness manually, using either the notification panel or the settings menu.











- 1 Select an option:
 - Swipe down twice from the top of the screen to expand the quick settings in the notification panel.
 - Select  > **Device** > **Display** > **Brightness level**.
- 2 Use the slider bar to adjust the brightness.

Vehicle Profiles

WARNING



Entering your vehicle profile characteristics does not guarantee that your vehicle's characteristics will be accounted for in all route suggestions. Limitations may exist in map data for some route suggestions. Always defer to all posted road signs and conditions during vehicle operation. Failure to do so could lead to an accident involving personal injury or death.

Vehicle profiles allow you to choose different settings based on each vehicle you use with the device. The current vehicle profile is indicated by an icon in the status bar. If your vehicle profile includes a trailer, an icon of the trailer appears with the vehicle icon.

	RV or motor home profile
	Motorcycle profile
	ATV profile
	Side-by-side profile
	Full size profile
	Snowmobile profile
	Other profile
	Profile with trailer
	Profile with travel trailer
	Profile with boat trailer

Adding a Vehicle Profile

You can add a vehicle profile for each vehicle to be used with your device.

- 1 Select  > **Navigation** > **Vehicle Profile** > .
- 2 Select your current vehicle.
- 3 Follow the on-screen instructions to enter the vehicle characteristics.

Choosing a Vehicle Profile

- 1 Swipe down twice from the top of the screen.
- 2 Select the vehicle profile icon on the status bar.

Adding Propane Tanks







NOTE: This feature is not available on all product models.

When you add your propane tanks to your vehicle profile, the device avoids routing through areas with propane tank restrictions that may affect your route. The device also alerts you when you approach areas that require you to shut off your propane tanks.

- 1 From the vehicle profile, select  > **Add Tank**.
- 2 Enter the weight of the propane tank, and select **Save**.

Editing a Vehicle Profile

You can change basic vehicle profile information or add detailed information to a vehicle profile, such as maximum speed.

- 1 Select  > **Navigation** > **Vehicle Profile**.
- 2 Select the vehicle profile to edit.
- 3 Select an option:
 - To edit the vehicle profile information, select , and select a field to edit.
 - To rename the vehicle profile, select  >  > **Rename Profile**.
 - To delete the vehicle profile, select  >  > **Delete**.

Off-Road Navigation Features

Routes

A route is a path from your current location to one or more destinations.

- For off-road use, you can set the device to calculate point-to-point routes in a straight line ([Straight Line Routes, page 7](#)).
- The device calculates a recommended route to your destination based on the preferences you set, including the route calculation mode ([Changing the Route Calculation Mode, page 40](#)) and avoidances ([Avoiding Delays, Tolls, and Areas, page 38](#)).
- The device can automatically avoid roads that are not appropriate for the active vehicle profile.
- You can start navigating to your destination quickly using the recommended route, or you can select an alternate route ([Starting a Route, page 35](#)).
- If there are specific roads you need to use or avoid, you can customize the route ([Shaping Your Route, page 38](#)).
- You can add multiple destinations to a route ([Adding a Location to Your Route, page 38](#)).

Adventure Roads and Trails

⚠ WARNING

Entering your vehicle profile characteristics does not guarantee that your vehicle's characteristics will be accounted for in all route suggestions. Limitations may exist in map data for some route suggestions. Always defer to all posted road signs and conditions during vehicle operation. Failure to do so could lead to an accident involving personal injury or death.

This device can navigate off-highway roads and trails based on your vehicle profile. Trails ① are color coded based on accessibility. You can select  to set which adventure roads and trails appear on the map.

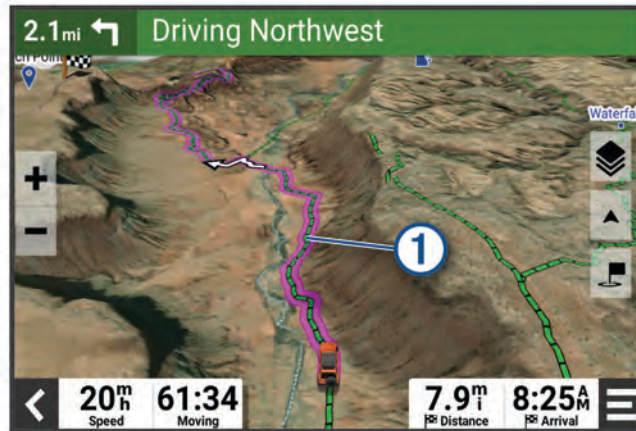

Straight Line Routes

For areas without defined roads or trails, the device guides you to your destination using a straight line route. You can set multiple waypoints to navigate a route through areas without roads.



- ① Distance to the destination.
- ② Route highlighted on the map.
- ③ Vehicle speed.
- ④ Map tools. Provides tools to show you more information about your route and surroundings.
- ⑤ Map layers. Allows you to change the map orientation and add topographic and BirdsEye imagery to your map view.

Skipping the Next Stop on Your Route

You can skip an upcoming location you previously added to your route.

From the map, select  > **Yes**.

Stopping the Route

From the map, select  > **Stop**.

Tracks

A track is a recording of your path. The track log contains information about the recorded path, including time, location, and elevation information.

Recording Tracks

Tracking records your path. When you start tracking, your device logs your location and updates the track line. If your device is paired with a Garmin Explore™ account, your device periodically synchronizes recorded tracks with the app.

- 1 From the main menu, swipe to the left and select **Track Recorder**.
- 2 Select **Start**.

Navigating a Track

You can navigate a saved track using the Garmin Explore app on your device.

- 1 Select  > **Adventure** > **Explore** > **Tracks**.
- 2 Select a track.
- 3 Select **Go!**.

Viewing Your Collections on the Map

Before you can view the Collections map layer, you must pair your device with the Tread app and sync your device with your Garmin Explore account.

You can view your Garmin Explore collections directly on the map. You must enable the collections map layer to use this feature.

NOTE: If you do not assign a collection category to your Garmin Explore data, it appears as an unorganized collection.

- 1 Select **View Map** >  > **Collections**.
- 2 Select one or more collection categories from the list.
- 3 Select **Save**.

Your collections appear as icons on the map.

Pitch and Roll

WARNING

The Pitch and Roll application is intended to show vehicle angles based on calibrated measurements only. You are responsible for calibrating the device. Changes to the position of the device after calibration may affect the accuracy of its measurements. Measured values are suggestions only based on your input into the device. Take readings often and carefully, and allow the readings to stabilize after significant changes in environmental conditions. Always allow a margin of safety for changing conditions and reading errors. Failure to account for your vehicle and your environment could cause an incident resulting in death or serious injury.

The device alerts you if your vehicle pitches or rolls at an angle that could affect the vehicle's stability.

Calibrating Pitch and Roll

You can set the angle of your vehicle to zero at any time.

- 1 Park your vehicle on a flat, level surface.
- 2 Adjust the position of your device in the mount so you can comfortably view the screen.
- 3 From the main menu, swipe to the left and select **Pitch and Roll > Calibrate**.

The values for pitch and roll reset to 0 degrees.

WARNING

To maintain the best accuracy, you must calibrate pitch and roll each time you reposition your device.

Adjusting Warning Angles

You can adjust the angles at which the device activates a pitch or roll alert. You are responsible for knowing and setting the correct pitch and roll angle for your vehicle.

- 1 From the main menu, swipe to the left and select **Pitch and Roll > ⋮ > Warning Angles**.
- 2 Swipe up or down to adjust the pitch or roll warning angles.
- 3 Select **Accept**.

Enabling or Disabling Warning Angle Alerts

- 1 From the main menu, swipe to the left and select **Pitch and Roll > ⋮**.
- 2 Select an option:
 - To enable or disable pitch and roll notifications, select **Pitch and Roll Notifications**.
 - To enable or disable audible alerts, select **Audible Alerts**.

Viewing the Altimeter, Barometer, and Compass

The device contains internal altimeter, barometer, and compass sensors with automatic calibration.

Select  > **Adventure > ABC**.

TIP: You can also select the Altimeter or Barometer widget to open the ABC app.

Calibrating the Compass

NOTICE

Calibrate the electronic compass outdoors. To improve heading accuracy, do not stand near metal objects or objects that influence magnetic fields, such as vehicles, electronic devices, buildings, or overhead power lines.

When your device is connected to the mount, it uses GPS data to determine your compass heading. When you remove the device from the mount, it uses a built-in compass to show your heading.

Each time you disconnect your device from the mount, the device prompts you to calibrate the compass.

If you experience irregular compass behavior, for example, after moving long distances or after extreme temperature changes, you can manually calibrate the compass to improve accuracy.

- 1 Disconnect the device from the mount and move away from objects that influence magnetic fields.
- 2 From the main menu, swipe to the left and select **Altimeter > ⋮ > Calibrate Compass**.
- 3 Follow the on-screen instructions.

Group Ride

The Group Ride app allows you to coordinate rides and communicate with nearby riders using preset text messages, live map locations, and voice communications.

NOTE: Before you can use the Group Ride app, you must install a Group Ride accessory. Go to garmin.com to purchase a Group Ride accessory.

Starting a Group Ride

You can create a group ride that allows you to choose the group radio channel, view and remove riders who join your group ride, and set the group ride name.

NOTE: For some product models, the Group Ride app is located in the apps menu.

- 1 From the main menu, select **Group Ride > Start a Group Ride**.
- 2 Enter your rider name, and select **Done**.
- 3 If necessary, select the radio channel, and select **Next**.
- 4 Enter the ride name, and select **Done**.
As riders join your group ride, their names appear on the list.
- 5 Select **Start**.
The group ride begins after all riders sync with the group ride.

Joining a Group Ride

You can join a nearby group ride that was created by another rider.

NOTE: For some product models, the Group Ride app is located in the apps menu.

- 1 From the main menu, select **Group Ride > Nearby Group Rides**.
- 2 Select a nearby group ride, and select **Join**.

Rejoining a Recent Group Ride

You can rejoin any of your ten most-recent group rides.

- 1 From the main menu, select **Group Ride > Recent Group Rides**.
- 2 Select a recent group ride, and select **Join**.

Adding Riders to a Group Ride

You can add riders to a group ride that is already in progress.

- 1 From the main menu, select **Group Ride**.
- 2 If necessary, select .
- 3 Select **Add**.
As new riders join the group ride, they appear on the list.
- 4 Select **Continue**.

Broadcasting a Message

WARNING

Do not read, send, or reply to any messages while driving. If you do so, you could become distracted by the display, which could lead to an accident causing personal injury or death.

You can broadcast a preset message to the members in your active group ride that are in range of the VHF radio.

- 1 From the main menu, select **Group Ride**.
- 2 If necessary, select .
- 3 Select **Broadcast to Group**.
- 4 Select a preset message, and select **Send**.

Broadcasting a Location

WARNING

While driving, do not interact with the display to broadcast your location. If you do so, you could become distracted by the display, which could lead to an accident causing serious personal injury or death.

You can broadcast a location to the members in your active group ride that are in range of the VHF radio.

- 1 From the main menu, select **Group Ride**.
- 2 If necessary, select .
- 3 Select **Broadcast to Group > Broadcast a Location**, and select a location.
- 4 Select **Share**.

Viewing a Group Ride Notification

WARNING

Do not read or reply to any notifications while driving. If you do so, you could become distracted by the display, which could lead to an accident causing serious personal injury or death.

From most pages, a notification appears when the device receives a broadcasted group ride location or message. You can also view group ride notifications in the Group Ride app.

NOTE: When you are viewing the map, new notifications appear in a map tool at the edge of the screen..

- 1 From the main menu, select **Group Ride > **, and select a notification.
- 2 Select **Go!** to navigate to a shared location.

Exiting a Group Ride

- 1 From the main menu, select **Group Ride**.
- 2 If necessary, select .
- 3 Select **Exit > Yes**.

Group Ride Settings

From the main menu, select **Group Ride > **.

Edit Rider Name: Allows you to set your name that displays during a group ride. This setting is not available during an active group ride.

Rider Map Labels: Sets the label to be displayed on each active rider on the map.

Show Tracks on Map: Shows the track that each group ride member takes on the map.

Auto Zoom to Group: Enables the map to automatically zoom to the active group ride.

Reset Default Settings: Allows you to reset all group ride settings to default values. This setting is not available during an active group ride.

Radio

NOTE: This feature is not available on all product models.

NOTE: Before you can use the Radio app, you must install a Group Ride accessory. Go to [garmin.com](https://www.garmin.com) to purchase a Group Ride accessory.

You can use the Radio app to create radio presets, select a radio channel, and select squelch codes. To use this feature, you must connect the device and the antenna to the Group Ride mount. The Tread - Overland Edition device configures radio settings automatically when you join or create a group ride.

Selecting a Preset

NOTE: For some product models, the Radio app is located in the apps menu.

- 1 From the main menu, select **Radio**.
- 2 Select an option:
 - To move through available presets, select ▲ or ▼.
 - To select a preset from the menu, select **Preset**.

Selecting a Radio Channel

- 1 From the main menu, select **Radio**.
- 2 Select an option:
 - To move to a different channel, select + or -.
 - To select a MURS channel from the menu, select **Channel**.

Adjusting the Squelch

You can adjust the squelch and change between CTCSS, DCS, and Open squelch modes to improve audio quality and avoid radio interference in your area.

- 1 From the main menu, select **Radio**.
- 2 Select an option:
 - To choose a squelch code within the current mode, select + or -.
 - To adjust the squelch mode, select **Open**.

Adding a Custom Radio Preset

- 1 Select **Radio** > **Preset** > (+).
- 2 Select + or - to select a channel and squelch code.
- 3 Select **Save**.

Selecting a Roger Tone

You can select the tone other devices play when you operate your radio.

- 1 Select **Radio** > 📞 > **Roger Tone**.
- 2 Select a roger tone.

The device plays the selected tone.
- 3 Select **Save**.

Turning the Radio Off

Select **Radio** > 🔌 > **Yes**.

Enabling Push-to-Talk with a Headset

You can enable push-to-talk controls for use with a compatible Bluetooth headset. This allows you to transmit your voice using the voice dial feature on your headset.

- 1 Select **Radio** > 📞 > **Push to Talk with Headset**.
- 2 If necessary, follow the on-screen instructions to pair your headset with the device.
- 3 Select **Push to Talk with Headset**.
- 4 Select ✓.

Transmitting Your Voice

Before you can transmit your voice, you must pair your Tread - Overland Edition device with a compatible Bluetooth headset or connect the fist microphone.

You can transmit your voice over the radio using the connected fist microphone or a compatible Bluetooth headset.

NOTE: For some product models, the Radio app is located in the apps menu.

Select an option:

- Hold the push-to-talk button on the side of the connected fist microphone.
- From the main menu, select **Radio > Push to Talk**.
- Use the voice dial feature on your connected Bluetooth headset (*Enabling Push-to-Talk with a Headset, page 12*).

TIP: You can press the pause or stop button to manually close the radio.

NOTE: You must enable the **Push to Talk with Headset** setting to use this feature (*Radio Settings, page 13*).

Adjusting the Radio Volume

- 1 Select **Radio > **.
- 2 Use the slider bars to adjust the volume.

Radio Settings

From the main menu, select **Radio > **.

Push to Talk with Headset: Enables you to transmit your voice using the push-to-talk button on your compatible headset.

Roger Tone: Sets the roger tone the device plays when you operate your radio.

Reset Default Settings: Resets all radio settings and presets to factory default values.

inReach® Features

WARNING

Messaging, tracking, and SOS functions require an active satellite subscription. Always test your device before you use it outdoors.

Ensure you have a clear view of the sky when using the messaging, tracking, and SOS functions, because these features require satellite access to operate properly.

NOTICE

Some jurisdictions regulate or prohibit the use of satellite communications devices. It is the responsibility of the user to know and follow all applicable laws in the jurisdictions where the device is intended to be used.

To get the most out of your device, you should activate it. Activating the device allows you to use inReach features, including messaging, SOS, tracking, and inReach Weather.

Messages

Your Tread - Overland Edition device sends and receives text messages using the Iridium satellite network. You can send messages to an SMS phone number, an email address, or another device that uses inReach technology. Each message you send includes your location details where allowed.

Sending a Preset inReach Message

Preset messages have predefined text and predetermined recipients. You must set up preset messages using the Garmin Explore website at explore.garmin.com.

- 1 Select **inReach > Presets**.
- 2 Select a preset message, and select **Send**.

Sending a Text Message

- 1 Select **inReach** > **Compose**.
- 2 Select **To:**, and add one or more contacts.
- 3 Select **Message:**, and enter a message.
- 4 Select **Send**.

Replying to a Message

- 1 Select **inReach**.
- 2 Select a conversation, and select **Reply**.
- 3 Select an option:
 - To start with a pre-written message, select a quick text message from the top of the screen.
NOTE: You can add and edit quick text messages on the Garmin Explore website.
 - To write a custom message, enter a message.
- 4 Select **Done**.

Checking for Messages

When you send a message, your device listens for replies for 10 minutes. The device also checks for new messages every hour. When you are using the inReach tracking feature, your device automatically checks for messages at your tracking interval.

NOTE: To receive messages, your device must have a clear view of the sky and be in view of a satellite when it checks for the messages.

You can force a check for messages by manually checking for messages, sending a message, or sending a track point. During a check, your device connects to satellites and receives messages waiting to be sent to your device.

Select **inReach** > **Check**.

Navigating to a Message Location

When you send or receive a message from another device with inReach technology, the message may include location information. For these messages, you can navigate to the location from which the message was sent.

- 1 Select **inReach**, and select a conversation.
- 2 Select a message with location information, and select **Go!**.

Deleting a Message

- 1 Select **inReach**.
- 2 Select a conversation.
- 3 Select **Delete** > **Yes**.

inReach Tracking

You can use the tracking feature on your Tread - Overland Edition device to record track points and transmit them over the Iridium satellite network at the specified send interval. Track points appear on the Garmin Explore website and the MapShare™ tracking page.

Starting Tracking

Select **inReach** > .

Stopping Tracking

Select **inReach** > .

NOTE: Stopping tracking also pauses your activity recording.

Sharing Your MapShare Web Page

You can enable MapShare at explore.garmin.com.

You can share a link to your MapShare webpage with other people. The system automatically adds text, including link information, to the end of your message.

- 1 Select **inReach** >  > **Send MapShare**.
- 2 Select **To:**, and add one or more contacts.
- 3 Select **Message:**, and enter a message.
- 4 Select **Send**.

inReach Tracking Settings

Select **inReach** > .

Tracking Sync: Sets the device to use the track recorder and inReach tracking simultaneously.

Auto Track: Sets the device to start tracking when you turn on the device.

Send Interval: Sets the frequency at which the device records a track point and transmits it over the satellite network when you are moving. If you are on a professional plan, you can specify the interval when you are stationary.

SOS

During an emergency, you can use your Tread - Overland Edition device to contact the Garmin® International Emergency Response Coordination Center (IERCC) to request help. Pressing the SOS button sends a message to the Garmin IERCC, and they notify the appropriate emergency responders of your situation. You can communicate with the Garmin IERCC during your emergency while you wait for help to arrive. You should only use the SOS function in a real emergency situation.

Initiating an SOS Rescue

⚠ CAUTION

While the device is in SOS mode, do not turn off or attempt to turn off the device. Doing so could prevent this feature from operating properly and could delay receipt of assistance in the event of an emergency.

- 1 Open the SOS door on the device ①.



- 2 Press the SOS button ②.
- 3 Wait for the SOS countdown.
The device sends a default message to the emergency response service with details about your location.
- 4 Reply to the confirmation message from the emergency response service.
Your reply lets the emergency response service know that you are capable of interacting with them during the rescue.
For the first 10 minutes of your rescue, an updated location is sent to the emergency response service every minute. To conserve battery power after the first 10 minutes, an updated location is sent every 10 minutes when moving, and every 30 minutes when stationary.

Canceling an SOS Rescue

If you no longer need assistance, you can cancel an SOS rescue after it is sent to the emergency response service.

Select **Cancel SOS**.

Your device transmits the cancellation request. When you receive a confirmation message from the emergency response service, the device returns to normal operation.

Syncing inReach Data

You can sync data from your explore.garmin.com account to your device using the Garmin Explore app. After you make edits to your data, such as plan changes, contacts, preset messages, or quick text messages, you must sync them to your device using the mobile app.

Open the Garmin Explore app.

Changes made to data such as collections, waypoints, routes, and tracks update automatically.

You can now sync your data to your Tread - Overland Edition device.

Contacts

You can add, delete, and edit contacts on the Tread - Overland Edition device.



Adding a Contact

- 1 Select **inReach** >  > **inReach Contacts** > **New Contact**.
- 2 Enter the new information.
- 3 Select **Save**.

Editing a Contact

- 1 Select **inReach** >  > **inReach Contacts**.
- 2 Select a contact.
- 3 Select an item to edit.
- 4 Enter the new information.
- 5 Select **Save**.

Deleting a Contact

- 1 Select **inReach** >  > **inReach Contacts**.
- 2 Select a contact.
- 3 Select  > **Yes**.

Data Use and History





You can view plan details and data use on the Tread - Overland Edition device.

Viewing Plan and Usage Details

Select **inReach** >  > **About This Device**.

Using the Map

You can use the map to navigate a route ([Your Route on the Map, page 36](#)) or to view a map of your surroundings when no route is active.

- 1 Select **View Map**.
- 2 Touch anywhere on the map.
- 3 Select an option:
 - Drag the map to pan left, right, up, or down.
 - To add or remove map layers such as topographic and BirdsEye imagery, select .
 - To zoom in or out, select  or .
 - To switch between North Up, 2-D, and 3-D views, select .
 - To open the route planner, select  ([Route Planner, page 24](#)).
 - To start a route, select a location on the map, and select **Go!** ([Starting a Route by Using the Map, page 36](#)).

Map Tools

Map tools provide quick access to information and device functions while you view the map. When you activate a map tool, it appears in a panel at the edge of the map.

Stop: Stops navigation of the active route.

Edit Route: Allows you to take a detour or skip locations in your route ([Changing Your Active Route, page 38](#)).

Mute: Mutes the device audio.

Cities Ahead: Shows upcoming cities and services along your active route or along a highway ([Cities Ahead, page 19](#)).

Up Ahead: Shows upcoming locations along the route or the road on which you are traveling ([Up Ahead, page 18](#)).

Elevation: Displays elevation changes ahead.

Traffic: Displays traffic conditions along your route or in your area ([Viewing Upcoming Traffic, page 20](#)). This feature is not available in all areas or for all device models.

Trip Data: Displays customizable trip data, such as speed or mileage ([Viewing Trip Data from the Map, page 19](#)).

Track Recorder: Displays the track data for your active route.

Turns: Displays a list of upcoming turns in your route ([Viewing Turns and Directions, page 37](#)).

Phone: Displays a list of recent phone calls from your connected phone, and displays in-call options while a phone call is active ([Using In-Call Options, page 34](#)).

Weather: Displays weather conditions for your area.

Music Player: Displays media controls and media information.

Smart Notifications: Displays recent smart notifications from your connected phone.



Pitch and Roll: Displays the current angle of your vehicle ([Pitch and Roll, page 8](#)).

Group Ride: Displays the distance and direction of the members in your group ride ([Group Ride, page 9](#)).

Environmental Zones: Shows upcoming environmental zones that apply to your vehicle.

inReach: Allows you to view and send inReach messages, and start inReach tracking ([inReach® Features, page 13](#)).

Viewing a Map Tool

- 1 From the map, select .
- 2 Select a map tool.
The map tool appears in a panel at the edge of the map.
- 3 When you are done using the map tool, select .

Up Ahead

The Up Ahead tool provides information about upcoming locations along your route or the road on which you are traveling. You can view upcoming points of interest by category, such as restaurants, fuel stations, or rest areas.



You can customize the categories that show in the Up Ahead tool.

Viewing Upcoming Locations

- 1 From the map, select  > **Up Ahead**.
While you are traveling, the map tool shows the next location along your road or route.
- 2 Select an option:
 - If the map tool shows categories, select a category to view a list of nearby locations in that category.
 - If the map tool shows upcoming locations, select a location to view location details or start a route to the location.

Customizing the Up Ahead Categories

You can change the location categories that appear in the Up Ahead tool.

- 1 From the map, select  > **Up Ahead**.
- 2 Select a category.
- 3 Select .
- 4 Select an option:
 - To move a category up or down in the list, select and drag the arrow next to the category name.
 - To change a category, select the category.
 - To create a custom category, select a category, select **Custom Search**, and enter the name of a business or category.
- 5 Select **Save**.

Cities Ahead

While you are traveling on a highway or navigating a route that includes a highway, the Cities Ahead tool provides information about upcoming cities along the highway. For each city, the map tool shows the distance to the highway exit and the services available, similar to the information on highway road signs.

Viewing Upcoming Cities and Exit Services

- 1 From the map, select  > **Cities Ahead**.

While you are traveling along a highway or an active route, the map tool shows information about upcoming cities and exits.
- 2 Select a city.

The device shows a list of points of interest located at the selected city exit, such as fuel stations, lodging, or restaurants.
- 3 Select a location, and select **Go!** to start navigating.

Trip Information

Viewing Trip Data from the Map

From the map, select  > **Trip Data**.

Customizing the Trip Data Fields

- 1 From the map, select  > **Trip Data**.
- 2 Select a trip data field.
- 3 Select an option.



The new trip data field appears in the trip data map tool.

Resetting Trip Information

- 1 From the map, select **Speed**.
- 2 Select a trip information data field.
- 3 Select  > **Reset Field(s)**.
- 4 Select an option:
 - When not navigating a route, select **Select All** to reset every data field except the speedometer, on the first page.
 - Select **Reset Overall Data** to reset Trip A and total data.
 - Select **Reset Max. Speed** to reset the maximum speed.
 - Select **Reset Trip B** to reset the odometer.

Viewing Upcoming Elevation Changes

You can view upcoming elevation changes along your route. This can help you avoid or plan for steep uphill or downhill grades.

- 1 From the map, select  > **Elevation**.
- 2 Select the chart to expand it to the full screen.
The device displays your current elevation, and a chart of elevation over distance.
- 3 Select an option:
 - Select  or  to change the distance range of the chart.
 - Select the arrows to scroll the chart.

Viewing Upcoming Traffic

NOTICE

Garmin is not responsible for the accuracy or timeliness of the traffic information.

Before you can use this feature, your device must be receiving traffic data ([Traffic, page 41](#)).

You can view traffic incidents coming up along your route or along the road on which you are traveling.



- 1 While navigating a route, select  > **Traffic**.
The nearest upcoming traffic incident appears in a panel on the right side of the map.
- 2 Select the traffic incident to view additional details.

Viewing Traffic on the Map

The traffic map shows color-coded traffic flow and delays on nearby roads.

- 1 From the main menu, select  > **Navigation** > **Traffic**.
- 2 If necessary, select  > **Legend** to view the legend for the traffic map.

Searching for Traffic Incidents

- 1 From the main menu, select  > **Navigation** > **Traffic**.
- 2 Select  > **Incidents**.
- 3 Select an item in the list.
- 4 If there is more than one incident, use the arrows to view additional incidents.

Customizing the Map

Customizing the Map Layers

You can customize which data appear on the map, such as icons for points of interest and road conditions.

- 1 Select  > **Map Display** > **Map Layers**.
- 2 Select the layers to include on the map, and select **Save**.

Viewing the Public Lands Map Key

Public lands are color-coded on the map to show who owns a specific plot of land. For example, you can see if a plot of land is privately owned or if it is part of a national park. You must enable the public lands map layer to use this feature ([Customizing the Map Layers, page 20](#)).

You can view the legend for these colors on the device.

Select  > **Map Display** > **Map Layers** >  > **Public Lands**.

Enabling Adventure Roads and Trails Map Layers

You can enable or disable map layers that display accessible or inaccessible roads for different types of motor vehicles.

- 1 Select  > **Map Display** > **Map Layers** >  > **Adventure Roads & Trails**.
- 2 Select a road or trail type.

Changing the Map Data Field

- 1 From the map, select a data field.
NOTE: You cannot customize Speed.
- 2 Select a type of data to display.

Changing the Map Buttons

- 1 From the map, hold a map button.
- 2 Select an option:
 - To replace a map button, select a map button, and select a map button to display.
 - To remove a map button, select .
- 3 Select **Save**.

Changing the Map Perspective

- 1 Select  > **Map Display** > **Driving Map View**.
- 2 Select an option:
 - Select **Track Up** to display the map in two dimensions (2-D), with your direction of travel at the top.
 - Select **North Up** to display the map in 2-D with north at the top.
 - Select **3-D** to display the map in three dimensions.
 - Select **Auto Zoom to Group** to automatically adjust the zoom level so all riders in a group ride are visible on the map.
- 3 Select **Save**.

Dog Tracking

The dog tracking features allow you to see information transmitted from your compatible Garmin handheld dog device on your Tread - Overland Edition device. You can navigate to your dogs, view their current status and location, and observe the distance they have traveled.

Receiving Data From Your Handheld Device

Before you can receive data, you must enable broadcasting on your handheld dog device. See the owner's manual for your handheld dog device for more information.

Place your handheld dog device within 3 m (10 ft) of your Tread - Overland Edition device.

TIP: Your Tread - Overland Edition device receives data from one compatible handheld dog device at a time. Stay more than 3 m (10 ft) away from other handheld dog devices or disable broadcasting on handheld dog devices from which you do not want to receive data.









The devices connect and synchronize automatically.

Tracking Your Dogs

- 1 Select  > **Adventure** > **Dog Tracker**.
The dogs connected to your handheld dog device appear on the screen.
- 2 Select a dog.
The dog's location and track log appear on the map.
- 3 Select **Go!** to navigate to your dog.

Dog Status Icons

Icons indicate the status and location of your dogs.

	Sitting
	Running
	On point
	Treed
	Unknown*
	Collar battery low
	Collar connection lost
	Collar GPS reception lost

*The unknown status icon indicates the collar has not acquired a satellite signal and the handheld device cannot determine the location of the dog.

Viewing Your Dogs on the Map

- 1 While viewing the map, select anywhere on the map.
- 2 Select .

The device zooms to show all of your dogs on the screen.

Using the Apps

Viewing the Owner's Manual on Your Device

You can view the complete owner's manual on the device screen in many languages.

- 1 Select  > **Tools** > **Owner's Manual**.

The owner's manual appears in the same language as the software text.

- 2 Select  to search the owner's manual (optional).

Music Player

The media player allows your device to control the media currently playing from a media app on your paired phone. You can open the media player at any time by selecting  > **Tools** > **Music** from the main menu.

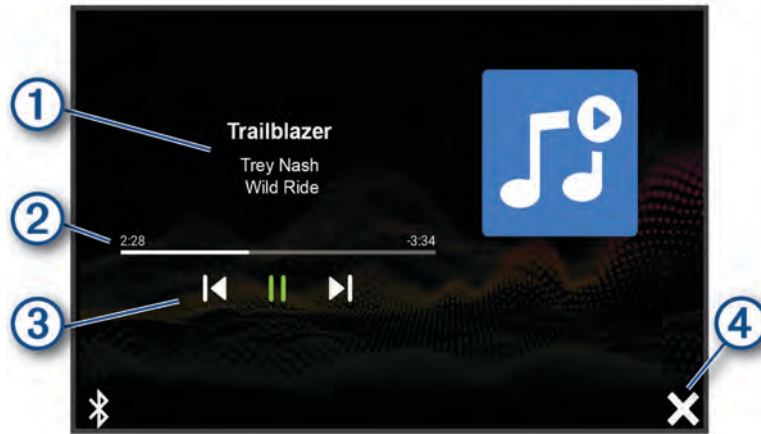

① Information about the currently playing media, such as title, artist, album, station, or channel.

② Progress through the current media item.

③ Playback controls. The controls change based on the service providing the media.

④ Select to hide or shrink the media player.

Adding the Music Player Tool to the Map

The music player map tool enables you to control the music player from your map.

1 Open the map.

2 Select  > **Music Player**.



The music player controls appear on the map.

BirdsEye Imagery

BirdsEye imagery provides downloadable, high-resolution map imagery, including detailed satellite imagery and raster-based topographical maps. You can download BirdsEye Satellite Imagery directly to your device when it is connected to a Wi-Fi network.

Downloading BirdsEye Imagery

Before you can download BirdsEye imagery directly to your device, you must connect to a wireless network ([Connecting to a Wireless Network, page 51](#)).

- 1 Select  > **Adventure** > **BirdsEye Direct**.
- 2 Select .
- 3 Select an option:
 - To download BirdsEye imagery files for a specific location or area, select **Location**, and select a category.
NOTE: The location defaults to your current location.
 - To select an image quality option, select **Detail**.
 - To define the size of the area to be shown in the downloaded imagery files, select **Size**, and enter a distance from the selected location.
 - To select where to save the downloaded imagery, select **Save To**.
- 4 Select **Download**.
- 5 Enter a name for the downloaded imagery and select **Done**.



Route Planner

You can use the route planner to create and save a route, which you can navigate later. This can be useful for planning a delivery route, a vacation, or a road trip. You can edit a saved route to further customize it, including reordering locations, adding suggested attractions, and adding shaping points.





You can also use the route planner to edit and save your active route.

Planning a Route

A route can include many locations, and it must include at least a starting location and one destination. The starting location is the location from which you plan to start your route. If you start navigating the route from a different location, the device gives you the option to route to your starting location first. For a round trip, the starting location and final destination can be the same.

- 1 Select **Route Planner** > **Create Route**.
- 2 If necessary, select a calculation mode.
NOTE: The Faster Time mode is selected by default.
- 3 Select an option to choose a location for your starting point:
 - Select a location on the map.
 - Select , and search for a location ([Finding a Location Using the Search Bar, page 42](#)).
- 4 Repeat step 3 to add more locations.
NOTE: The last location you add is the destination.
- 5 After you have added all the necessary locations, select .

Editing and Reordering Locations in a Route

- 1 Select **Route Planner**.
- 2 Select a saved route.
- 3 Select **List**.
- 4 Select a location.
- 5 Select an option:
 - To change the location, select , and enter a new location.
 - To move the location up or down, select , and drag the location to a new position in the route.
 - To add a new location after the selected location, select .
 - To remove the location, select .

Changing Routing Options for a Route

You can customize how the device calculates your route.

- 1 Select **Route Planner**.
- 2 Select a saved route.
- 3 Select .
- 4 Select an option:
 - To add shaping points to your route, select **Shaping**, and select at least one location.
 - To change the calculation mode for the route, touch a route segment, and select a calculation mode.

Navigating to a Saved Route

- 1 Select **Route Planner**.
- 2 Select a saved route.
- 3 Select **Go!**.
- 4 Select the first location to navigate to, and select **OK**.

The device calculates a route from your current location to the selected location, and then it guides you to the remaining route destinations in order.

Editing and Saving Your Active Route

If a route is active, you can use the route planner to edit and save it.

- 1 Select **Route Planner > My Active Route**.
- 2 Edit your route using any of the route planner features.

The route recalculates each time you make a change.
- 3 Select **Save** to save your route, which you can navigate again later (optional).

TracBack

Following Your Recent Track

The TracBack feature records the most recent segment of your movement. You can retrace your recent track back to a previous location.

- 1 Select  > **Adventure > TracBack**.

Your recent track appears on the map.
- 2 Select **Go!**.

Saving Your Recent Track as a Route

You can save your recent track as a route, which you can navigate later using the route planner ([Navigating to a Saved Route, page 25](#)).

- 1 Select **TracBack**.

Your recent track appears on the map.
- 2 Select  > **Save as Trip**.
- 3 Enter a name, and select **Done**.

Viewing the Weather Forecast

NOTICE

Garmin is not responsible for the accuracy or timeliness of the weather data.

Before you can use this feature, your device must be receiving weather data. You can connect your device to the Tread app to receive weather data ([Pairing with Your Smartphone, page 32](#)).

NOTE: Weather forecasts are not available in all areas.

- 1 Select  > **Navigation** > **Weather**.

The device shows the current weather conditions and a forecast for the next several days.

- 2 Select a day.

The detailed forecast for that day appears.

Viewing Weather Near a Different City

- 1 Select  > **Navigation** > **Weather** > **Current Location**.

- 2 Select an option:

- To view weather for a favorite city, select a city in the list.
- To add a favorite city, select **Add City**, and enter a city name.

Viewing the Weather Radar

Before you can use this feature, your device must be connected to a supported phone running the Tread app ([Pairing with Your Smartphone, page 32](#)).

- 1 Select  > **Navigation** > **Weather Radar**.

- 2 Select  to animate the radar map.

Viewing Weather Alerts

Before you can use this feature, your device must be connected to a supported phone running the Tread app ([Pairing with Your Smartphone, page 32](#)).

NOTE: This feature is not available in all areas.

While you are traveling with your device, weather alerts may appear on the map. You can also view a map of weather alerts near your current location or near a selected city.

- 1 Select  > **Navigation** > **Weather**.

- 2 If necessary, select a city.

- 3 Select  > **Weather Alerts**.

Checking Road Conditions

Before you can use this feature, your device must be connected to a supported phone running the Tread app ([Pairing with Your Smartphone, page 32](#)).

You can view weather-related road conditions for the roads in your area, on your route, or in another city.



- 1 Select  > **Navigation** > **Weather**.

- 2 If necessary, select a city.

- 3 Select  > **Road Conditions**.



Creating a Round-Trip Route

The device can create a round-trip route using a specified starting location and a distance, duration, or destination.

- 1 From the main menu, select  > **Navigation** > **Round Trip**.
- 2 Select **Start Location**.
- 3 Select a location, and select **Select**.
- 4 Select **Trip Attributes**.
- 5 Select an option:
 - Select **Choose a Distance** to plan your route by distance.
 - Select **Choose a Duration** to plan your route based on time.
 - Select **Choose a Destination** to plan your route based on a specified location.
- 6 Select **Next**.
- 7 Enter a distance, duration, or destination.
- 8 Select an option:
 - If you entered a distance or duration, select **Done**.
 - If you selected a destination, select **Select**.
- 9 Select **Add a Direction**.
- 10 Select a direction, and select **Next**.
- 11 Select **Road Type**.
- 12 Select a road type, and select **Save**.
- 13 Select **Calculate**.
- 14 Select one or more options:
 - Select  to view elevation statistics along your route.
 - Select  to shape your route.
 - Use the slider to increase or decrease the level of adventure on your route.
- 15 Select a route, and select **Go!**.

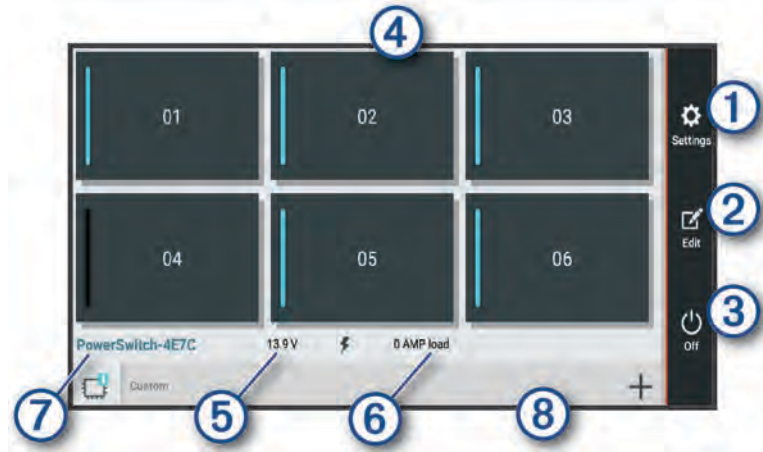
Garmin PowerSwitch™ App



① 	Opens the app settings menu
② 	Enters editing mode to customize the app layout and functions
③ 	Turns off all outputs
④ Power buttons	Activates each connected output
⑤	Displays input voltage
⑥	Displays the total amperage of the selected Garmin PowerSwitch device
⑦	Displays the device name
⑧	Displays Garmin PowerSwitch device tabs and custom layout tabs

Activating a Power Switch



Before you can use the Garmin PowerSwitch app to activate a switch, you must install your Garmin PowerSwitch device in your vehicle and pair it with the Garmin PowerSwitch app.

From the Garmin PowerSwitch app, select a power button to turn a switch on or off.

Turning Off All Switches

Select .

Customizing a Button

- 1 From the Garmin PowerSwitch app screen, select .
The app enters editing mode.
- 2 Select  on the button you want to customize.
- 3 Select an option:
 - To change the name of the button, select the **Button Label** field, and enter a name.
 - To add an icon to the button, select the **Icon** field, and select an icon.
 - To change the button color, select a color.
 - To change the button mode, select a button mode.
 - To adjust the intensity of the switch, use the slider.
 - To set the button to activate with a control input, select a control input.
- 4 Select .
- 5 Select **Done**.

Assigning a Switch to a Control Input



Before you can use control input functions, you must connect a control input to your Garmin PowerSwitch device ([Connecting a Control Input, page 62](#)).

You can assign one or more switches to turn on when the Garmin PowerSwitch device receives a signal from a control input.



- 1 Select .
- 2 Select your Garmin PowerSwitch device.
- 3 Select a control input.
- 4 Select one or more switches.

Adding a Custom Layout



You can add a custom layout tab to the Garmin PowerSwitch app. Buttons added to a custom layout can control multiple switches at the same time.

- 1 From the Garmin PowerSwitch app, select .
The device enters editing mode.
- 2 Select .



Adding a Button to a Custom Layout

- 1 From the Garmin PowerSwitch app, select a custom layout tab.
- 2 Select .
The app enters editing mode.
- 3 Select **Add Button**.
- 4 On the new button, select .
- 5 Select an option:
 - To change the name of the button, select the **Button Label** field, and enter a name.
 - To add an icon to the button, select the **Icon** field, and select an icon.
 - To change the button color, select a color.
- 6 Select **Add Action**.
- 7 If necessary, select a Garmin PowerSwitch device and a switch.
- 8 Select an action:
 - To set the button to turn the switch on or off with each press, select **Toggle**.
 - To set the button to turn on the switch, select **Turn On**.
 - To set the button to turn off the switch, select **Turn Off**.
- 9 Select a button mode:
 - To set the button to activate with one touch, select **Normal**.
 - To set the button to activate only while touching the button, select **Momentary**.
 - To set the button to turn on and off repeatedly, select **Strobe**, and select time intervals.
- 10 If applicable, use the slider to set the brightness of lights.
- 11 Select .
- 12 If necessary, select **Add Action** to add additional actions for the button.
You can add one action for every switch on the Garmin PowerSwitch device.

Arranging Buttons In a Custom Layout

- 1 From the Garmin PowerSwitch app, select a custom layout tab.
- 2 Select .
The app enters editing mode.
- 3 On the button you want to move, hold  and drag the button to a new location.

Deleting a Custom Layout or Button

- 1 From the Garmin PowerSwitch app, select a custom layout tab.
- 2 Select .
The app enters editing mode.
- 3 Select an option:
 - To delete a button, select  on the button you want to delete.
 - To delete a layout tab, select  on the layout tab.



Routines

Routines automate your Garmin PowerSwitch device. When you define a routine on your compatible Garmin navigation device, it turns switches on or off automatically when the conditions of the routine are met. For example, you can set a routine to turn on a switch at specific time each day or when your vehicle reaches a specific speed. Routines are available only when using a compatible Garmin navigation device.



Adding a Routine

- 1 From the Garmin PowerSwitch app, select  > **Routines**.
- 2 If necessary, select **Add Routine**.
- 3 Select **When**.
- 4 Select a trigger:
 - To set a switch to trigger when your vehicle reaches a specific speed, select **Speed** > **Next**, and follow the on-screen instructions to enter speed thresholds.
 - To set a switch to trigger at a specific time each day, select **Time** > **Next**, and enter a time.
 - To set a switch to trigger at sunrise, select **Sunrise**.
 - To set a switch to trigger at sunset, select **Sunset**.
- 5 Select **Add Action**.
- 6 Select a device, a switch, an action, and a button mode.
- 7 If necessary, use the slider to adjust the dimmer.
- 8 Select **Save**.

Editing a Routine

- 1 From the Garmin PowerSwitch app, select  > **Routines**.
- 2 Select  on the routine you want to edit.
- 3 Select an option:
 - To change the trigger for the routine, select **When**, and select a trigger.
 - To change an action, select  on the action you want to change, and update the action.
 - To add an action to the routine, select **Add Action**, and enter information about the action.
- 4 Select **Save**.

Deleting a Routine

- 1 From the Garmin PowerSwitch app, select  > **Routines**.
- 2 Select  on the routine you want to delete.

Live Services, Traffic, and Smartphone Features

WARNING

Do not read or reply to any messages or notifications while driving. If you do so, you could become distracted by the display, which could lead to an accident causing personal injury or death.

NOTICE

Garmin is not responsible for the accuracy or timeliness of the traffic information.

The Tread app allows your device to receive smart notifications and live information, such as live traffic data and weather information.

Live traffic data: Sends live traffic data to your device, such as traffic incidents and delays, construction zones, and road closings ([Traffic, page 41](#)).

Weather information: Sends real-time weather forecasts, road conditions, and weather radar to your device ([Viewing the Weather Forecast, page 26](#)).

Smart Notifications: Displays phone notifications and messages on your device. This feature is not available for all languages.

Hands-Free calling: Allows you to place and receive phone calls through the device using your connected Bluetooth headset.

Send locations to device: Allows you to send locations from your smartphone to your navigation device.

Bluetooth Feature Status Icons

Status icons appear in the Bluetooth settings next to each paired device.

Select  > **Bluetooth**.

- A gray icon indicates the feature is disabled or disconnected for that device.
- A colored icon indicates the feature is connected and active for that device.

	Hands-free calling
	Smart notifications
	Tread features and services

Pairing with Your Smartphone

You can pair your Tread - Overland Edition device with your smartphone and the Tread app to enable additional features and access live information ([Live Services, Traffic, and Smartphone Features, page 31](#)).

- 1 From the app store on your smartphone, install the Tread app.
- 2 Turn on your Tread - Overland Edition device, and place the device and your smartphone within 3 m (10 ft.) of each other.
- 3 On your phone, open the Tread app.
- 4 Follow the on-screen instructions to sign in to a Garmin account and complete the pairing and setup process.

The main app dashboard appears. After the devices are paired, they connect automatically when they are turned on and within range.

Tips After Pairing the Devices

- After the initial pairing, the two devices can connect automatically each time you turn them on.
- When you turn on the device, it tries to connect to the last phone to which it was connected.
- You might need to set your phone to connect to the device automatically when the device is turned on.
- You should verify the Bluetooth features you want to use are enabled ([Enabling or Disabling Bluetooth Features, page 34](#)).

Pairing Additional Bluetooth Devices

- 1 Place your headset or phone and your Bluetooth device within 33 ft. (10 m) of each other.
- 2 On your device, enable Bluetooth wireless technology.
- 3 On your headset or phone, enable Bluetooth wireless technology and ensure it is visible to other Bluetooth devices.
- 4 On your device, select  > **Wireless Networks** > **Bluetooth** > **Pair new device**.
A list of nearby Bluetooth devices appears.
- 5 Select your headset or phone from the list.
- 6 If necessary, select **Pair**.

Smart Notifications

While your device is connected to the Tread app, you can view notifications from your smartphone on your Tread - Overland Edition device, such as text messages, incoming calls, and calendar appointments.

Receiving Notifications

WARNING

Do not read or reply to notifications while driving. If you do so, you could become distracted by the display, which could lead to an accident causing serious personal injury or death.

Before you can use this feature, your device must be connected to a supported phone running the Tread app ([Pairing with Your Smartphone, page 32](#)).

From most pages, a popup appears when the device receives a notification from your smartphone. If the device is moving, you must verify you are a passenger and not the driver before you can view notifications.

NOTE: If you are viewing the map, notifications appear in a map tool.

- To ignore a notification, select **OK**.
The popup closes, but the notification remains active on your phone.
- To view a notification, select **View**.
- To listen to the notification, select **View > Play**.
The device reads the notification using text-to-speech technology. This feature is not available for all languages.
- To perform additional actions, such as dismissing the notification from your phone, select **View**, and select an option.

NOTE: Additional actions are available for only some notification types and must be supported by the app generating the notification.

Receiving Notifications while Viewing the Map

WARNING

Do not read or reply to notifications while driving. If you do so, you could become distracted by the display, which could lead to an accident causing serious personal injury or death.

Before you can use this feature, your device must be connected to a supported phone running the Tread app ([Pairing with Your Smartphone, page 32](#)).

When you are viewing the map, new notifications appear in a map tool at the edge of the screen. If the device is moving, you must verify you are a passenger and not the driver before you can view notifications.

- To ignore a notification, select **X**, or wait for popup to expire.
The popup closes, but the notification remains active on your phone.
- To view a notification, select the notification text.
- To listen to the notification, select **Play Message**.
The device reads the notification using text-to-speech technology. This feature is not available for all languages.

Viewing the List of Notifications

You can view a list of all active notifications.

- 1 Select  > **Navigation > Smart Notifications**.

The list of notifications appears. Unread notifications appear black, and previously read notifications appear gray.

- 2 Select an option:

- To view a notification, select the notification description.
- To listen to a notification, select .





The device reads the notification using text-to-speech technology. This feature is not available for all languages.

Hands-Free Calling

NOTE: While most phones and headsets are supported and can be used, a particular phone or headset cannot be guaranteed to be compatible. All features may not be available for your phone.

Using Bluetooth wireless technology, your device can connect to your compatible mobile phone and wireless headset or helmet to become a hands-free device. To check compatibility, go to www.garmin.com/bluetooth.

Placing a Call

- 1 Select  > **Tools** > **Phone**.
- 2 Select an option:
 - To dial a number, select  enter the phone number, and select .
 - To view numbers of recent, missed, or recently dialed or received calls, select , select a log, and select a number to dial it.
 - To call a contact from your phone book, select , and select a contact.

Using In-Call Options

In-call options appear when you answer a call. Some options may not be compatible with your phone.

TIP: If you close the in-call options page, you can open it again by selecting  from any screen.



- To set up a conference call, select **Add Call**.
- To transfer audio to your phone, select **Call in Progress on Navigator**.

TIP: You can use this feature if you want to disconnect the Bluetooth connection and remain on the call, or if you need privacy.
- To use the dial pad, select **Keypad**.

TIP: You can use this feature to use automated systems, such as voice mail.
- To mute the microphone, select **Mute**.
- To hang up, select **End Call**.

Saving a Phone Number as a Preset

You can save up to three contacts as presets on the dial pad. This allows you to quickly call your home phone number, family members, or frequently called contacts.

- 1 Select  > **Tools** > **Phone**.
- 2 If necessary, select .
- 3 Select a preset number, such as **Preset 1**.
- 4 Select **OK**, then select a contact.

Enabling or Disabling Bluetooth Features

You can enable or disable Bluetooth features such as phone calls, media audio, and live services for your paired smartphone.

- 1 Select  > **Wireless Networks** > **Bluetooth**.
- 2 Select your phone name.
- 3 Select a feature to enable or disable it.

Showing or Hiding App Notifications (Android™)



You can use the Tread app to customize which types of smartphone notifications appear on your Tread - Overland Edition device.

- 1 On your phone, open the Tread app.
- 2 Select  > **Smart Notifications**.

A list of smartphone app categories appears.
- 3 Select a category to enable or disable notifications for that type of app.



Showing or Hiding Notification Categories for Your Apple® Device

If you are connected to an Apple device, you can filter the notifications shown on your Tread - Overland Edition device by showing or hiding categories.

- 1 Select  > **Tools** > **Smart Notifications** > .
- 2 Select the check box next to each notification to show.

Enabling or Disabling Bluetooth Features for Your Headset

By default, all compatible Bluetooth features are enabled when you pair your headset. You can enable or disable certain features.

- 1 Select  > **Wireless Networks** > **Bluetooth**.
- 2 Select the headset name, and select .
- 3 Select an option:
 - To disconnect the headset, select **Disconnect**.
 - To disable audio from phone calls, select **Phone calls**.
 - To disable audio from streaming media, select **Media Audio**.

Disconnecting a Bluetooth Device

You can temporarily disconnect a Bluetooth device without deleting it from the paired devices list. The Bluetooth device can connect to your Tread device automatically in the future.

- 1 Select  > **Wireless Networks** > **Bluetooth**.
- 2 Select the device to disconnect.
- 3 Select **Disconnect**.



Deleting a Paired Phone

You can delete a paired phone to prevent it from automatically connecting to your device in the future.

- 1 Select  > **Wireless Networks** > **Bluetooth**.
- 2 Select the phone, and select **Forget**.

Street Navigation

Starting a Route

- 1 Select **Where To**, and search for a location.
- 2 Select a location.
- 3 Select an option:
 - To start navigating using the recommended route, select **Go!**.
 - To choose an alternate route, select , and select a route.
Alternate routes appear to the right of the map.
 - To edit the course of the route, select  > **Edit Route**, and add shaping points to the route ([Shaping Your Route](#), page 38).

The device calculates a route to the location and guides you using voice prompts and information on the map ([Your Route on the Map](#), page 36). A preview of the major roads in your route appears at the edge of the map for several seconds.

If you need to stop at additional destinations, you can add the locations to your route ([Adding a Location to Your Route](#), page 38).

Starting a Route by Using the Map

You can start a route by selecting a location from the map.

- 1 Select **View Map**.
- 2 Drag and zoom the map to display the area to search.
- 3 Select a location on the map.
- 4 Select **Go!**.

Your Route on the Map

As you travel, the device guides you to your destination using voice prompts and information on the map. Instructions for your next turn or exit, or other actions appear across the top of the map.



①	Next action in the route. Indicates the next turn, exit, or other action and the lane in which you should travel, if available.
②	Distance to the next action.
③	Name of the street or exit associated with the next action.
④	Route highlighted on the map.
⑤	Next action in the route. Arrows on the map indicate the location of upcoming actions.
⑥	Vehicle speed.
⑦	Name of the road on which you are traveling.
⑧	Estimated arrival time. TIP: You can touch this field to change the information it shows.
⑨	Map tools. Provides tools to show you more information about your route and surroundings.
⑩	Map layers. Allows you to change the map orientation and add topographic and BirdsEye imagery to your map view.

Active Lane Guidance

As you approach some turns, exits, or interchanges in your route, a detailed simulation of the road appears beside the map, if available. A colored line ① indicates the proper lane for the turn.

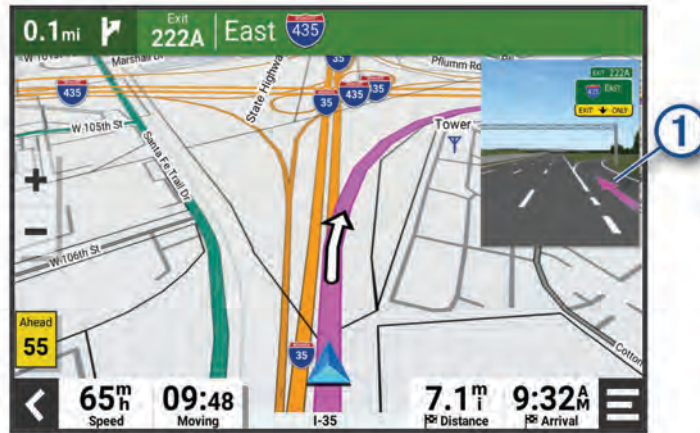

Viewing Turns and Directions

While navigating a route, you can view upcoming turns, lane changes, or other directions for your route.

1 From the map, select an option:

- To view upcoming turns and directions as you navigate, select **☰ > Turns**.
The map tool displays the next several turns or directions beside the map. The list updates automatically as you navigate the route.
- To view the complete list of turns and directions for the entire route, select the text bar at the top of the map.

2 Select a turn or direction (optional).

Detailed information appears. An image of the junction may appear for junctions on major roadways, if available.

Viewing the Entire Route on the Map

1 While navigating a route, select anywhere on the map.

2 Select **☰**.

Changing Your Active Route

Adding a Location to Your Route

Before you can add a location to your route, you must be navigating a route ([Starting a Route, page 35](#)).

You can add locations to the middle or end of your route. For example, you can add a fuel station as the next destination in your route.

TIP: To create complex routes with multiple destinations or scheduled stops, you can use the route planner to plan, schedule, and save a route ([Planning a Route, page 24](#)).

- 1 From the map, select  > **Where To**.
- 2 Search for a location.
- 3 Select a location.
- 4 Select **Go!**.
- 5 Select an option:
 - To add the location as the next destination in your route, select **Add as Next Stop**.
 - To add the location to the end of your route, select **Add as Last Stop**.
 - To add the location and edit the order of destinations in your route, select **Add to Active Route**.

The device re-calculates the route to include the added location and guides you to the destinations in order.

Shaping Your Route

Before you can shape your route, you must start a route ([Starting a Route, page 35](#)).

You can manually shape your route to change its course. This allows you to direct the route to use a certain road or go through a certain area without adding a destination to the route.

- 1 Touch anywhere on the map.
- 2 Select **Shape Route**.

TIP: You can select  to zoom in on the map and select a more precise location.

The device enters route shaping mode and recalculates the route to travel through the selected location.
- 3 Select **Go!**.
- 4 If necessary, select an option:
 - To add more shaping points to the route, select additional locations on the map.
 - To remove a shaping point, select the shaping point and select **Remove**.

Avoiding Delays, Tolls, and Areas

Avoiding Traffic Delays on Your Route

Before you can avoid traffic delays, you must be receiving traffic information.

By default, the device optimizes your route to avoid traffic delays automatically. If you have disabled this option in the traffic settings ([Traffic Settings, page 52](#)), you can view and avoid traffic delays manually.

- 1 While navigating a route, select  > **Traffic**.
- 2 Select **Alternate Route**, if available.
- 3 Select **Go!**.

Avoiding Toll Roads

Your device can avoid routing you through areas that require tolls, such as toll roads, toll bridges, or congestion areas. The device may still include a toll area in your route if no other reasonable routes are available.

- 1 Select  > **Navigation** > **Avoidances** > **Toll Roads**.
- 2 Select **Save**.

Avoiding Toll Stickers

If the map data on your device contains detailed toll sticker information, you can avoid or allow roads that require toll stickers for each country.

NOTE: This feature is not available in all areas.

- 1 Select  > **Navigation** > **Tolls and Fees** > **Toll Stickers**.
- 2 Select a country.
- 3 Select an option:
 - To be asked each time before routing through an area that requires toll stickers, select **Always Ask**.
 - To always avoid roads that require toll stickers, select **Avoid**.
 - To always allow roads that require toll stickers, select **Allow**.

Avoiding Road Features

- 1 Select  > **Navigation** > **Avoidances**.
- 2 Select the road features to avoid on your routes, and select **Save**.

Custom Avoidances

Custom avoidances allow you to select specific areas or sections of road to avoid. When the device calculates a route, it avoids these areas and roads unless no other reasonable route is available.

Avoiding a Road



- 1 Select  > **Navigation** > **Custom Avoidances**.
- 2 If necessary, select **Add Avoidance**.
- 3 Select **Add Avoid Road**.
- 4 Select the starting point of the section of road to avoid, and select **Next**.
- 5 Select the ending point of the road section, and select **Next**.
- 6 Select **Done**.

Avoiding an Area



- 1 Select  > **Navigation** > **Custom Avoidances**.
- 2 If necessary, select **Add Avoidance**.
- 3 Select **Add Avoid Area**.
- 4 Select the upper-left corner of the area to avoid, and select **Next**.
- 5 Select the lower-right corner of the area to avoid, and select **Next**.
The selected area is shaded on the map.
- 6 Select **Done**.

Disabling a Custom Avoidance

You can disable a custom avoidance without deleting it.



- 1 Select  > **Navigation** > **Custom Avoidances**.
- 2 Select an avoidance.
- 3 Select  > **Disable**.

Deleting Custom Avoidances

- 1 Select  > **Navigation** > **Custom Avoidances** > .
- 2 Select an option:
 - To delete all custom avoidances, select **Select All** > **Delete**.
 - To delete one custom avoidance, select the avoidance, and select **Delete**.

Arriving at Your Destination

When you approach your destination, the device provides information to help you complete your route.

-  indicates the location of your destination on the map, and a voice prompt announces you are approaching your destination.
- When you approach some destinations, the device automatically suggests parking areas. You can select **More** to view a full list of suggested parking areas (*Parking Near Your Destination*, page 41).
- When you stop at your destination, the device automatically ends the route. If the device does not detect your arrival automatically, you can select  > **Stop** to end your route.

Changing the Route Calculation Mode

- 1 Select  > **Navigation** > **Calculation Mode**.
- 2 Select an option:
 - Select **Faster Time** to calculate routes on streets that are faster to drive but can be longer in distance.
 - Select **Off Road** to calculate off-road, point-to-point routes in a straight line.
 - Select **Shorter Distance** to calculate routes on streets that are shorter in distance but can take more time to drive.

Taking a Route Using Garmin Adventurous Routing™

Your device can calculate adventurous routes that prefer curvy roads, hills, and fewer highways. This feature can provide a more enjoyable ride, but it may increase the time or distance to your destination. The Garmin Adventurous Routing feature is not compatible with off-road trails.

NOTE: This feature is not available on all device models or for all map regions.

- 1 Select **Where To** > **Categories**.
- 2 If necessary, select a subcategory.
- 3 Select a location.
- 4 Select .
- 5 Use the slider to increase or decrease the level of adventure of your route.
- 6 Select **Go!**

Taking a Detour

You can take a detour for a specified distance along your route or detour around specific roads. This is useful if you encounter construction zones, closed roads, or poor road conditions.

- 1 From the map, select  > **Edit Route**.
- 2 Select an option:
 - To detour your route for a specific distance, select **Detour by Distance**.
 - To detour around a specific road on the route, select **Detour by Road**.

Going Home

The first time you start a route home, the device prompts you to enter your home location.

- 1 Select **Where To** > **Go Home**.
- 2 If necessary, enter your home location.

Editing Your Home Location

- 1 Select **Where To** >  > **Set Home Location**.
- 2 Enter your home location.

Parking Near Your Destination

Your device can help you find a parking spot near your destination. When you approach some destinations, the device automatically prompts you to search for parking.

1 Select an option:

- When the device prompts you, select **Yes** to search for nearby parking.
- If the device does not prompt you, select **Where To > Categories > Parking**, and select  **> My Destination**.

2 Select a parking location, and select **Go! > Add as Next Stop**.

The device guides you to the parking area.

Traffic

NOTICE

Garmin is not responsible for the accuracy or timeliness of the traffic information.

Your device can provide information about traffic on the road ahead or on your route. You can set your device to avoid traffic when calculating routes, and to find a new route to your destination if a large traffic delay occurs on your active route ([Traffic Settings, page 52](#)). The traffic map allows you to browse the map for traffic delays in your area.

To provide traffic information, your device must be receiving traffic data.

- All product models can receive subscription-free traffic data using the Tread app.

Traffic data is not available in all areas. For information about traffic coverage areas, go to garmin.com/traffic.

Receiving Traffic Data Using Your Smartphone

Your device can receive subscription-free traffic data while connected to a smartphone running the Tread app.

1 Connect your device to the Tread app ([Pairing with Your Smartphone, page 32](#)).

2 On your Tread - Overland Edition device, select  **> Traffic**, and verify the **Traffic** option is selected.

Viewing Traffic on the Map

The traffic map shows color-coded traffic flow and delays on nearby roads.

1 From the main menu, select  **> Navigation > Traffic**.

2 If necessary, select  **> Legend** to view the legend for the traffic map.

Searching for Traffic Incidents

1 From the main menu, select  **> Navigation > Traffic**.

2 Select  **> Incidents**.

3 Select an item in the list.

4 If there is more than one incident, use the arrows to view additional incidents.

Finding and Saving Locations

The maps loaded in your device contain locations, such as restaurants, hotels, auto services, and detailed street information. The Where To menu helps you find your destination by providing several methods to browse, search, and save this information.

From the main menu, select **Where To**.

- To quickly search all locations on your device, select **Search** (*Finding a Location Using the Search Bar, page 42*).
- To find an address, select **Address**.
- To browse or search pre-loaded points of interest by category, select **Categories** (*Finding a Location by Category, page 43*).
- To search near a different city or area, select  next to the current search area (*Changing the Search Area, page 43*).
- To view and edit your saved locations, select **Waypoints** (*Saving Locations, page 48*).
- To view locations you have recently selected from the search results, select **Recent** (*Viewing Recently Found Locations, page 47*).
- To search for RV parks and campgrounds, select **Ultimate Public Campgrounds** (*Finding Ultimate Campgrounds Points of Interest, page 45*).
- To browse and search Tripadvisor® traveler ratings, select **Tripadvisor** (*Finding Tripadvisor Points of Interest, page 46*).
- To find national parks and explore park maps, select **National Parks** (*Finding National Parks, page 44*).
- To navigate to specific geographic coordinates, select **Coordinates** (*Finding a Location Using Coordinates, page 47*).

Finding a Location Using the Search Bar

You can use the search bar to search for locations by entering a category, brand name, address, or city name.

- 1 Select **Where To**.
- 2 Select **Search** in the search bar.
- 3 Enter all or part of the search term.
Suggested search terms appear below the search bar.
- 4 Select an option:
 - To search for a type of business, enter a category name (for example, "movie theaters").
 - To search for a business name, enter all or part of the name.
 - To search for an address near you, enter the house number and street name.
 - To search for an address in another city, enter the house number, street name, city, and state.
 - To search for a city, enter the city and state.
 - To search for coordinates, enter latitude and longitude coordinates.
- 5 Select an option:
 - To search using a suggested search term, select the term.
 - To search using the text you entered, select **Q**.
- 6 If necessary, select a location.

Location Search Results

The location search results appear in a list, with the nearest location at the top. Each numbered location also appears on the map. You can scroll down to view more results.

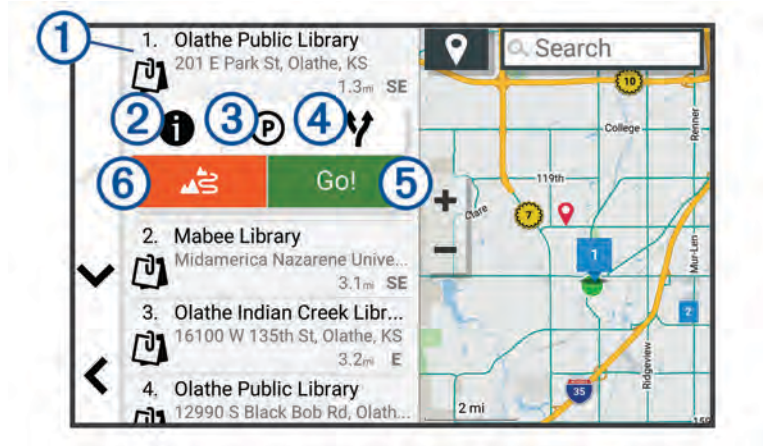

①	Select a location to view the option menu.
② ⓘ	Select to view detailed information about the location.
③ Ⓟ	Select to find parking areas near the location.
④ ↗	Select to view alternate routes to the location.
⑤ Go!	Select to start navigating to the location using the recommended route.
⑥ ⚓	Select to start navigating using Garmin Adventurous Routing.

Changing the Search Area

By default, the device searches near your current location. You can also search other areas, such as near your destination, near another city, or along your active route.

- 1 Select **Where To**.
- 2 Select 📍.
- 3 Select an option.

Finding a Location by Category

- 1 Select **Where To**.
- 2 Select a category, or select **Categories**.
- 3 If necessary, select a subcategory.
- 4 Select a location.

Navigating to Points of Interest Within a Venue

NOTE: This feature may not be available in all areas or for all product models.

You can create a route to a point of interest (POI) within a larger venue, such as a store in a shopping mall or a specific terminal in an airport.

- 1 Select **Where To > Search**.
- 2 Enter the name of the venue, and select .
- 3 Select the venue.
A list of categories for POIs within the venue appears.
- 4 Select a category, select a location, and select **Go!**.

The device creates a route to the parking area or venue entrance closest to the POI. When you arrive at the destination, a checkered flag indicates the recommended parking area. A labeled point indicates the location of the POI within the venue.

Points of Interest

A point of interest is a place that you may find useful or interesting. Points of interest are organized by category and can include popular travel destinations such as gas stations, restaurants, hotels, and entertainment venues.

Viewing Your Garmin Explore Waypoints

- 1 Select  > **Adventure > Explore**.
- 2 Select a data type.
- 3 Select an item to view the details.

Synchronizing Garmin Explore Account Data

Before you can synchronize account data, you must connect to the Tread app and enable Garmin Explore.

You can synchronize data, such as tracks, with your Garmin Explore account. This can be helpful to keep your data available on each of your compatible devices. Your device periodically synchronizes data with your account automatically. You can also synchronize data manually at any time.

- 1 Select  > **Adventure > Explore**.
- 2 Select .

Finding National Parks

Device models that include maps for North America or the United States also include detailed information for national parks in the United States. You can navigate to a national park or to a location within a national park.

- 1 Select **Where To > National Parks**.
A list of national parks appears, with the nearest park at the top.
- 2 Select **Search**, and enter all or part of the park name to narrow the results (optional).
- 3 Select a national park.
A list of categories for locations of features and amenities within the park appears below the park name.
- 4 Select an option:
 - To start navigating to the park, select **Go!**.
 - To view more park information or explore the park features and amenities, select .
 - To quickly find a location within the park, select a category from the list below the park name, and select a location.

Finding Campgrounds

Select **Where To > Ultimate Public Campgrounds**.

Finding Ultimate Campgrounds Points of Interest

NOTE: This feature is not available in all areas.

Your device includes Ultimate Campgrounds points of interest, which allow you to find public campgrounds near your location.

- 1 Select **Where To** > **Ultimate Public Campgrounds**.
- 2 If necessary, select **Search Filters**, select one or more search filters, and select **Search**.
- 3 Select a location.

Finding RV Parks

NOTE: This feature is not available in all areas.

Select **Where To** > **PlanRV Parks**.

Finding RV Services

NOTE: This feature is not available in all areas.

You can find nearby locations that offer repair, towing, and other services for RVs.

Select **Where To** > **PlanRV Services**.

Finding iOverlander™ Points of Interest

NOTICE

You are responsible for understanding and complying with any applicable regulations associated with campsites and points of interest.

Your device includes iOverlander points of interest, which allow you to find points of interest useful for overlanding, such as camp sites, repair services, and lodging.

- 1 Select **Where To** > **iOverlander**.
- 2 Select a category.
- 3 Select a location.

Finding Powersport Points of Interest

Your device includes powersport points of interest, which allow you to find points of interest useful for powersports, such as vehicle dealers and shops.

- 1 Select **Where To** > **Motorcycle Shop**.
- 2 Select a location.

Finding Adventure Points

Your device includes adventure points of interest, which allow you to find outdoor points of interest such as campsites, hiking trails, OHV trails, fishing locations, and water activities.

- 1 Select **Where To** > **Adventure Points**.
- 2 If necessary, select **Search Filters**, select one or more search filters, and select **Save**.
- 3 Select a location.

Tripadvisor

Your device includes Tripadvisor traveler ratings. Tripadvisor ratings appear automatically in the search results list for restaurants, hotels, and attractions. You can also search for nearby Tripadvisor points of interest and sort by distance or popularity.

Finding Tripadvisor Points of Interest

- 1 Select **Where To > Tripadvisor**.
- 2 Select a category.
- 3 If necessary, select a subcategory.
A list of nearby Tripadvisor points of interest for the category appears.
- 4 Select **Sort Results** to filter the displayed points of interest by distance or popularity (optional).
- 5 Select  and enter a search term (optional).

Finding Parking Near Your Current Location

- 1 Select **Where To > Categories > Parking**.
- 2 Select a parking location.
- 3 Select **Go!**.

Finding Parking Near a Specified Location

- 1 Select **Where To**.
- 2 Search for a location.
- 3 From the location search results, select a location.
- 4 Select .
- A list of parking areas near the selected location appears.
- 5 Select a parking location.
- 6 Select **Go!**.

Search Tools

Search tools allow you to search for specific types of locations by responding to on-screen prompts.

Finding an Address

NOTE: The order of the steps may change depending on the map data loaded on your device.

- 1 Select **Where To**.
- 2 If necessary, select  to search near a different city or area.
- 3 Select **Address**.
- 4 Follow the on-screen instructions to enter address information.
- 5 Select the address.

Finding an Intersection

You can search for an intersection or junction between two streets, highways, or other roads.

- 1 Select **Where To > Intersections**.
- 2 Follow the on-screen instructions to enter street information.
- 3 Select the intersection.

Finding a Location Using Coordinates

You can find a location using latitude and longitude coordinates.

- 1 Select **Where To** > **Coordinates**.
- 2 If necessary, select , and change the coordinate format or datum.
- 3 Select **Coordinates**.
- 4 Enter the latitude and longitude coordinates, and select **Done**.
- 5 Select an option:
 - To save the coordinates as a location, select **Save**.
 - To start a route to the coordinates, select **Go!**.

Finding Fuel Stations and Prices

Before you can use this feature, your device must be connected to a supported phone running the Tread app ([Pairing with Your Smartphone, page 32](#)).

You can find nearby fuel stations and compare fuel prices.

- 1 Select **Where To** > **Fuel Prices**.
- 2 If necessary, select  > **Fuel Type**, select a fuel type, and select **Save**.
- 3 Select a fuel station.

Viewing Recently Found Locations

Your device stores a history of the last 50 locations you have found.

Select **Where To** > **Recent**.

Clearing the List of Recently Found Locations

Select **Where To** > **Recent** >  > **Clear** > **Yes**.

Viewing Current Location Information

You can use the Where Am I? page to view information about your current location. This feature is helpful if you need to tell emergency personnel your location.

From the map, select the vehicle.

Finding Emergency Services and Fuel

You can use the Where Am I? page to find the nearest hospitals, police stations, and fuel stations.

- 1 From the map, select the vehicle.
- 2 Select **Hospitals**, **Police Stations**, **Fuel**, or **Roadside Assist..**
NOTE: Some service categories are not available in all areas.
A list of locations for the selected service appears, with the nearest locations at the top.
- 3 Select a location.
- 4 Select an option:
 - To navigate to the location, select **Go!**.
 - To view the phone number and other location details, select .

Getting Directions to Your Current Location

If you need to tell another person how to get to your current location, your device can give you a list of directions.

- 1 From the map, select the vehicle.
- 2 Select  > **Directions to Me**.
- 3 Select a starting location.
- 4 Select **Select**.

Adding a Shortcut

You can add shortcuts to the Where To? menu. A shortcut can point to a location, a category, or a search tool. The Where To? menu can contain up to 36 shortcut icons.

- 1 Select **Where To** > **Add Shortcut**.
- 2 Select an item.

Removing a Shortcut

- 1 Select **Where To** >  > **Remove Shortcut(s)**.
- 2 Select a shortcut to remove.
- 3 Select the shortcut again to confirm.
- 4 Select **Done**.

Saving Locations

Saving a Location

- 1 Search for a location ([Finding a Location by Category, page 43](#)).
- 2 From the search results, select a location.
- 3 Select  > **Save**.
- 4 If necessary, enter a name, and select **Done**.
- 5 Select **Save**.



Saving a Waypoint on the Map

- 1 Select **View Map**.
- 2 Drag and zoom the map to display the area to search.
- 3 Select an option:
 - Select a location marker.
 - Select a point, such as a street, intersection, or address location.
- 4 Select .
- 5 Enter a name, and select **Save**.

Saving Your Current Location

- 1 From the map, select the vehicle icon.
- 2 Select **Save**.
- 3 Enter a name, and select **Done**.



Editing a Saved Location

- 1 Select **Where To > Waypoints**.
- 2 If necessary, select a category.
- 3 Select a location.
- 4 Select .
- 5 Select  > **Edit**.
- 6 Select an option:
 - Select **Name**.
 - Select **Phone Number**.
 - Select **Categories** to assign categories to the saved location.
 - Select **Map Symbol** to change the symbol used to mark the saved location on a map.
- 7 Edit the information.
- 8 Select **Done**.

Assigning Categories to a Saved Location

You can add custom categories to organize your saved locations.

NOTE: Categories appear in the saved locations menu after you have saved at least 12 locations.

- 1 Select **Where To > Waypoints**.
- 2 Select a location.
- 3 Select .
- 4 Select  > **Edit > Categories**.
- 5 Enter one or more category names, separated by commas.
- 6 If necessary, select a suggested category.
- 7 Select **Done**.

Deleting a Saved Location

NOTE: Deleted locations cannot be recovered.

- 1 Select **Where To > Waypoints**.
- 2 Select  > **Delete**.
- 3 Select the box next to the saved locations to delete, and select **Delete**.

Driver Awareness Features and Alerts

CAUTION

The driver alerts and speed limit features are for information only and do not replace your responsibility to abide by all posted speed limit signs and to use safe driving judgment at all times. Garmin is not responsible for any traffic fines or citations you receive for failing to follow all applicable traffic laws and signs.

Your device provides features that can help encourage safer driving and increase efficiency, even when you are driving in a familiar area. The device plays an audible tone or message and displays information for each alert. You can enable or disable the audible tone for some types of driver alerts. Not all alerts are available in all areas.

Schools: The device plays a tone and displays the speed limit (if available) for an upcoming school or school zone.

Speed limit exceeded: The device plays a tone and displays a red border on the speed limit icon when you exceed the posted speed limit for the current road.

Speed limit reduced: The device plays a tone and displays the upcoming speed limit so you can be prepared to adjust your speed.

Railroad crossing: The device plays a tone to indicate an upcoming railroad crossing.

Animal crossing: The device plays a tone to indicate an upcoming animal crossing area.

Bends: The device plays a tone to indicate a bend in the road.

Slower traffic: The device plays a tone to indicate slower traffic when you approach slower traffic at a higher speed. Your device must be receiving traffic information to use this feature ([Traffic, page 41](#)).

Construction zone: The device plays a tone and displays a message when you approach a construction zone.

Lane closure: The device plays a tone and displays a message when you approach a lane closure.

Break planning: The device plays a tone and suggests upcoming rest stops after you have been driving for a long time.

Risk of grounding: The device plays a tone and displays a message when you approach a road where your vehicle could become grounded.

Lateral wind: The device plays a tone and displays a message when you approach a road where there is risk of lateral wind.

Narrow road: The device plays a tone and displays a message when you approach a road that may be too narrow for your vehicle.

Steep hill: The device plays a tone and displays a message when you approach a steep hill.

State and country borders: The device plays a tone and displays a message when you approach the border of a state or country.

Shut off propane: The device plays a tone and displays a message when you approach an area where propane should be turned off.

Enabling or Disabling Driver Alerts

You can enable or disable several types of driver alerts.

- 1 Select  > **Driver Assistance** > **Driver Alerts**.
- 2 Select or clear the check box next to each alert.

Settings

Navigation Settings

Select  > **Navigation**.

Calculation Mode: Sets the route calculation method.

Off-Route Recalculation: Sets recalculation preferences when navigating away from an active route.

Avoidances: Sets road features to avoid on a route.

Custom Avoidances: Allows you to avoid specific roads or areas.

Environmental Zones: Sets the avoidance preferences for areas with environmental or emissions restrictions that may apply to your vehicle.

Restricted Mode: Disables all functions that require significant operator attention.

Voice Language: Sets the language for navigation voice prompts.

Travel History: Allows the device to store a record of the places you go. This allows you to view the trip log, use the Trip History feature, and use myTrends™ suggested routes.

Clear Travel History: Allows you to clear all travel history from the device.

Map and Vehicle Settings

Select  > **Map Display**.

Map Vehicle Icon: Sets the vehicle icon that represents your position on the map.

Driving Map View: Sets the perspective on the map.

Map Detail: Sets the level of detail on the map. More detail may cause the map to draw slower.

Map Theme: Changes the color of the map data.

Map Layers: Sets the data that appears on the map page (*Customizing the Map Layers, page 20*).

Adventure Roads & Trails: Sets the trails visible on the map. Trails are organized by vehicle accessibility.

Auto Zoom: Automatically selects the zoom level for optimal use of your map. When disabled, you must zoom in or out manually.

Skip Next Stop Confirmation: Sets a confirmation message to appear when skipping a location on your route.

Units: Sets the units of measure.

myMaps: Sets which installed maps the device uses.

Enabling Maps

You can enable map products installed on your device.

TIP: To purchase additional map products, go to garmin.com/maps.

1 Select  > **Map Display** > **myMaps**.

2 Select a map.

Connecting to a Wireless Network

1 Select  > **Wireless Networks** > **Wi-Fi**.

2 If necessary, select the toggle switch to turn on wireless network technology.

3 Select a wireless network.

4 If necessary, enter the encryption key.

The device connects to the wireless network. The device remembers the network information and connects automatically when you return to this location in the future.

Enabling Bluetooth Wireless Technology

Select  > **Wireless Networks** > **Bluetooth**.

Driver Assistance Settings

Select  > **Driver Assistance**.

Driver Alerts: Enables an audible alert for each type of driver alert (*Driver Awareness Features and Alerts*, page 50).

Proximity Alerts: Alerts you when you approach speed cameras or red light cameras.

Route Preview: Shows a preview of the major roads in your route when you start navigation.

Break Planning: Reminds you to take a break and shows upcoming services after you drive for an extended time. You can enable or disable break reminders and upcoming service suggestions.

Traffic Settings

From the main menu, select  > **Traffic**.

Traffic: Enables the traffic feature.

Current Provider: Sets the traffic provider to use for traffic data. The Auto option selects the best available traffic data automatically.

Subscriptions: Lists the current traffic subscriptions.

Optimize Route: Enables the device to use optimized alternate routes automatically or upon request (*Avoiding Traffic Delays on Your Route*, page 38).

Display Settings

Select  > **Device** > **Display**.

Brightness level: Sets the display brightness level on your device.

Dark theme: Enables or disables the dark color theme.

Wallpaper: Sets the wallpaper background on your device.

Screen timeout: Allows you to set the amount of idle time before your device turns off the display while using battery power.

Font size: Increases or decreases the font size on your device.

Adjusting Sound and Notification Volume

- 1 Select  > **Device** > **Sound & Notification**.
- 2 Use the slider bars to adjust the sound and notification volume.

Setting the Text Language

You can select the language for text in the device software.

- 1 Select  > **Personal** > **Language & Input** > **Languages**.
- 2 Select a language.

Date and Time Settings

Select  > **System** > **Date & Time**.

Use network-provided time: Automatically sets the time zone based on information from the connected network.

Use network-provided time zone: Sets the time zone on your device when Use network-provided time is disabled.

Use 24-hour format: Enables or disables the 24-hour time format.

Device Settings

Select  > **About Device**.

Legal Information: Allows you to view the end-user license agreement (EULA) and software license information.

Regulatory Information: Displays e-label regulatory and compliance information.

Garmin Device Information: Displays hardware and software version information.

Enabling or Disabling Location Services

The location services feature must be enabled for your device to find your location, calculate routes, and provide navigational assistance. You can disable location services to plan a route when GPS signals are not available. When location services are disabled, the device enables a GPS simulator to calculate and simulate routes.

TIP: Disabling location services can help save battery power.

- 1 Select  > **Personal** > **Location**.
- 2 Select the toggle switch to enable or disable location services.

Device Information

Viewing E-label Regulatory and Compliance Information

- 1 From the settings menu, swipe to the bottom of the menu.
- 2 Select **About Device** > **Regulatory Information**.

Tread - Overland Edition Specifications

Water resistance	IEC 60529 IP67 ¹
Operating temperature range	From 0° to 55°C (from 32° to 131°F)
Charging temperature range	From 0° to 45°C (from 32° to 113°F)
Power input (vehicle power cable or external power)	From 12 to 30 Vdc
Battery type	Lithium-ion battery
Battery voltage range	From 3.5 to 4.1 V

Charging the Device

NOTE: This Class III product shall be powered by an LPS power supply.

You can charge the battery in the device using any of these methods.

- Install the device in the mount, and connect the mount to vehicle power.
- Connect the device to an optional power adapter accessory, such as a wall power adapter.

You can purchase an approved Garmin AC-DC adapter suitable for home or office use from a Garmin dealer or www.garmin.com. The device may charge slowly when connected to a third-party adapter.

Device Maintenance

Garmin Support Center

Go to support.garmin.com for help and information, such as product manuals, frequently asked questions, videos, and customer support.

¹ The device is protected against the ingress of dust and withstands incidental exposure to water of up to 1 m for up to 30 min.

Map and Software Updates

For the best navigation experience, you should keep the maps and software on your device up to date.

Map updates provide the newest available changes to roads and locations in the maps used by your device. Keeping maps up to date helps your device find recently added locations and calculate more accurate routes. Map updates are large and may take several hours to complete.

Software updates provide changes and improvements to the device features and operation. Software updates are small and take a few minutes to complete.

You can update your device using two methods.

- You can connect the device to a Wi-Fi network to update directly on the device (recommended). This option allows you to update your device conveniently without connecting it to a computer.
- You can connect the device to a computer and update it using the Garmin Express™ application (garmin.com/express).

Updating Maps and Software Using a Wi-Fi Network

NOTICE

Map and software updates may require the device to download large files. Regular data limits or charges from your internet service provider apply. Contact your internet service provider for more information about data limits or charges.

You can update the maps and software by connecting your device to a Wi-Fi network that provides access to the internet. This allows you to keep your device up to date without connecting it to a computer.

- 1 Using the included USB cable, connect the device to external power.

NOTE: A USB power adapter is not included. Go to the product page on garmin.com to purchase a power adapter accessory.

- 2 Connect the device to a Wi-Fi network ([Connecting to a Wireless Network, page 51](#)).

While connected to a Wi-Fi network, the device checks for available updates automatically and displays a notification when an update is available.

- 3 Select an option:

- When an update notification appears, swipe down from the top of the screen, and select **An update is available..**
- To manually check for updates, select  > **Tools** > **System Updates**.

The device displays available map and software updates. When an update is available, **Update Available** appears below Map or Software.

- 4 Select an option:

- To install all available updates, select **Download**.
- To install only map updates, select **Map**.
- To install only software updates, select **Software**.

- 5 If necessary, read the license agreements, and select **Accept All** to accept the agreements.

NOTE: If you do not agree with the license terms, you can select **Reject**. This stops the update process. You cannot install updates until you accept the license agreements.

- 6 Keep the device connected to external power and within range of the Wi-Fi network until the update process is complete.

TIP: If a map update is interrupted or canceled before it completes, your device may be missing map data. To repair missing map data, you must update the maps again.

Product Updates

On your computer, install Garmin Express (www.garmin.com/express).

This provides easy access to these services for Garmin devices:

- Software updates
- Map updates
- Product registration

Updating Maps and Software with Garmin Express

You can use the Garmin Express application to download and install the latest map and software updates for your device.

- 1 If you do not have the Garmin Express application installed on your computer, go to garmin.com/express and follow the on-screen instructions to install it.
- 2 Open the  Garmin Express application.
- 3 Connect your device to your computer using a USB cable.

The small end of the cable connects to the USB port  on your Tread - Overland Edition device, and the large end connects to an available USB port on your computer.



- 4 When your Tread - Overland Edition device prompts you to enter file transfer mode, select **Yes**.
- 5 In the Garmin Express application, click **Add a Device**.
The Garmin Express application searches for your device and displays the device name and serial number.
- 6 Click **Add Device**, and follow the on-screen instructions to add your device to the Garmin Express application.
When setup is complete, the Garmin Express application displays the updates available for your device.

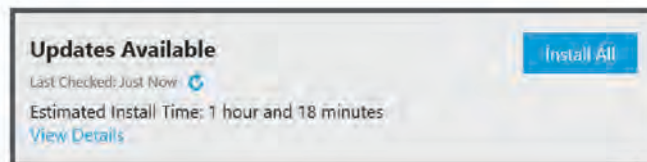

- 7 Select an option:

- To install all available updates, click **Install All**.
- To install a specific update, click **View Details**, and click **Install** next to the update you want.

The Garmin Express application downloads and installs the updates onto your device. Map updates are very large, and this process may take a long time on slower internet connections.

NOTE: If a map update is too large for the internal storage of the device, the software may prompt you to install a microSD card in your device to add storage space (*Installing a Memory Card for Maps and Data*, page 65).

- 8 Follow the on-screen instructions during the update process to finish installing updates.
For example, during the update process, the Garmin Express application may instruct you to disconnect and reconnect your device.

Device Care

NOTICE

Avoid dropping your device.

Do not store the device where prolonged exposure to extreme temperatures can occur, because it can cause permanent damage.

Never use a hard or sharp object to operate the touchscreen, or damage may result.

Cleaning the Outer Casing

NOTICE

Avoid chemical cleaners and solvents that can damage plastic components.

- 1 Clean the outer casing of the device (not the touchscreen) using a cloth dampened with a mild detergent solution.
- 2 Wipe the device dry.

Cleaning the Touchscreen

- 1 Use a soft, clean, lint-free cloth.
- 2 If necessary, lightly dampen the cloth with water.
- 3 If using a dampened cloth, turn off the device and disconnect the device from power.
- 4 Gently wipe the screen with the cloth.

Avoiding Theft

- Remove the device and mount from sight when not in use.
- Remove the residue left on the windshield by the suction cup.
- Do not keep your unit in the glove compartment.
- Register your device using the Garmin Express software (garmin.com/express).

Restarting the Device

You can restart your device if it stops functioning.

Hold the power key for 12 seconds.

Removing the Device from the Mount

- 1 Pull up the release tab on the mount.
- 2 Grip the device by the top and bottom.
- 3 Pull the bottom edge of the device toward you until it releases from the magnet.
Pulling the device straight toward you may cause the mount to release from the suction cup.

Troubleshooting

My device is not acquiring satellite signals

- Verify the location services feature is enabled (*Enabling or Disabling Location Services*, page 53).
- Take your device out of parking garages and away from tall buildings and trees.
- Remain stationary for several minutes.

My battery does not stay charged for very long

- Decrease the screen brightness (*Display Settings, page 52*).
- Shorten the display timeout (*Display Settings, page 52*).
- Decrease the volume (*Adjusting Sound and Notification Volume, page 52*).
- Turn off the wi-fi radio when it is not in use (*Connecting to a Wireless Network, page 51*).
- Put the device in power saving mode when not in use (*Turning the Device On or Off, page 3*).
- Keep your device away from extreme temperatures.
- Do not leave your device in direct sunlight.

My device does not connect to my phone

- Select  > **Wireless Networks** > **Bluetooth**.
The Bluetooth option must be enabled.
- Enable Bluetooth wireless technology on your phone and bring your phone within 10 m (33 ft.) of the device.
- Verify your phone is compatible.
Go to www.garmin.com/bluetooth for more information.
- Complete the pairing process again.
To repeat the pairing process, you must unpair your phone and device (*Disconnecting a Bluetooth Device, page 35*), and complete the pairing process (*Pairing with Your Smartphone, page 32*).

My device does not appear as a removable drive on my computer

On most computers, the device connects using Media Transfer Protocol (MTP). In MTP mode, the device appears as a portable device and not as a removable drive.

Appendix

Garmin PowerSwitch

WARNING

Garmin strongly recommends having an experienced installer with the proper knowledge of electrical systems install the device. Incorrectly wiring the power cable can result in damage to the vehicle or the battery and can cause bodily injury.

You can use a connected Garmin PowerSwitch device to control lights, fans, and more from your Tread - Overland Edition device.

Mounting Considerations

- The device must be mounted close to the battery and within the range of the supplied power cable.
- The mounting surface must be strong enough to support the weight of the device.
- The location must allow room for the routing and connection of all cables.

Mounting the Device

Before you can mount the device, you must select a mounting location and purchase the appropriate hardware for your mounting surface.

NOTICE

Avoid wires, gauges, air bags, air bag covers, HVAC, and other items when drilling pilot holes and attaching the mount to the vehicle. Garmin is not responsible for any damages or consequences arising from the installation.

- 1 Place the mount on the selected location.



- 2 Using the mount as a template, mark the two screw locations ①.
- 3 Drill pilot holes (optional).
For some types of mounting material, drilling pilot holes is necessary. Do not drill through the mount.
- 4 Securely fasten the mount to the surface using the appropriate hardware for your mounting surface.

Opening the Front Cover

You must open the front cover to make electrical connections.

- 1 Lift the front cover latch ① and rotate it counter-clockwise.



- 2 Pull the front cover off of the device.



Connecting Accessories

NOTICE

Do not use the device to control or power a winch. Failure to follow this notice could cause damage to your vehicle or your device.

Do not connect a power source to an accessory output terminal. Failure to follow this notice could cause damage to your vehicle or your device.

Accessory requirements:

- Verify the amperage rating of each accessory before wiring it to the Garmin PowerSwitch device. The device supports accessories up to 30 A for each channel and a maximum of 100 A for the entire system.
- Use 10 AWG (6 mm²) wires for accessories that use 20 to 30 A.
- Use 12 AWG (4 mm²) wires for accessories that use 10 to 20 A.
- Use 14 AWG (2.5 mm²) wires for accessories that use less than 10 A.
- Use the appropriate size terminals for all accessory connections.
- Crimp all terminal connectors securely.

- 1 Connect the positive wire from the accessory ① to one of the accessory terminals ② on the Garmin PowerSwitch device.

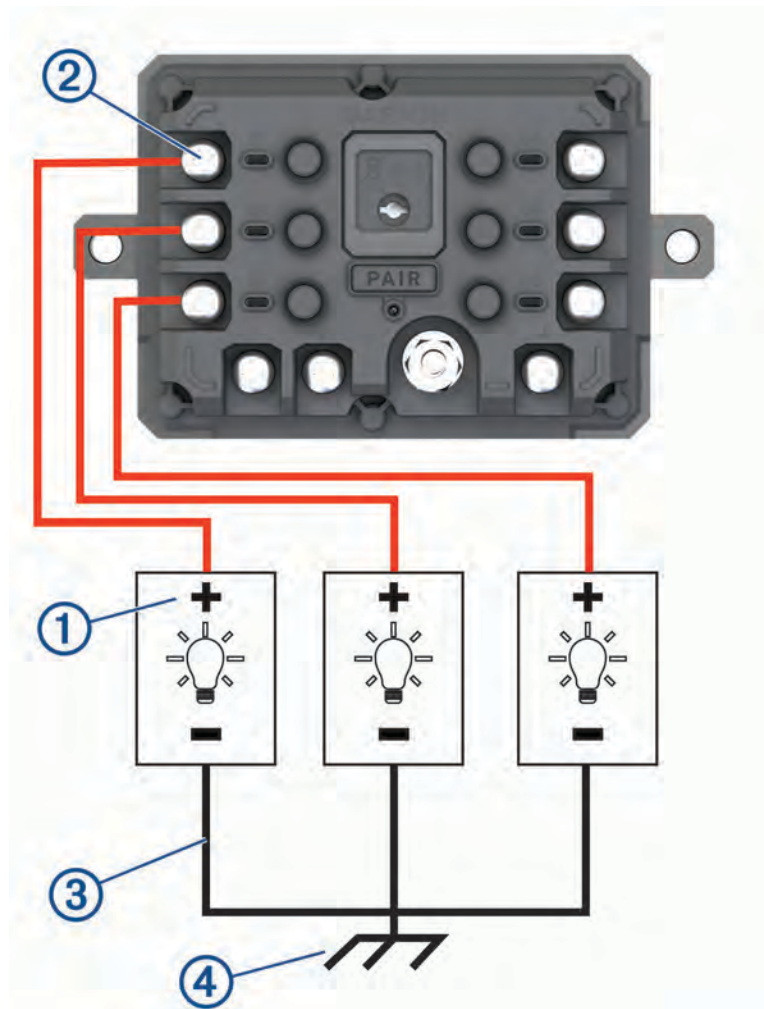

- 2 Connect the negative or ground wire ③ to an unpainted ground stud ④ on the vehicle frame, to a ground distribution block, or directly to the negative terminal on the battery.

NOTICE

Do not connect the accessory ground wires to the ground terminal (GND) on the Garmin PowerSwitch device. Failure to heed this notice could result in personal or property damage, or negatively impact device functionality.

- 3 Verify that all electrical connections are tight and will not come loose during use.

Connecting a Control Input

You can connect to the control terminals to enable the Garmin PowerSwitch device to turn on customizable outputs. For example, you can connect your vehicle ignition switch to a control input terminal to turn on accessories automatically each time you start your vehicle. The control terminals detect a signal from 3.3 V to 18 V. You can configure output functions with the Garmin PowerSwitch app.

Connect the control wire from the control source in your vehicle to one of the two control terminals on the Garmin PowerSwitch device.

Connecting the Device to Vehicle Power

Before you can connect the device to vehicle power, you must remove the warning tag from the +12V terminal on the device.

You should always confirm all electrical connections are secure and will not come loose while operating the device.

- 1 Connect the large ring end of the included ground wire ① to the negative terminal on the vehicle battery.

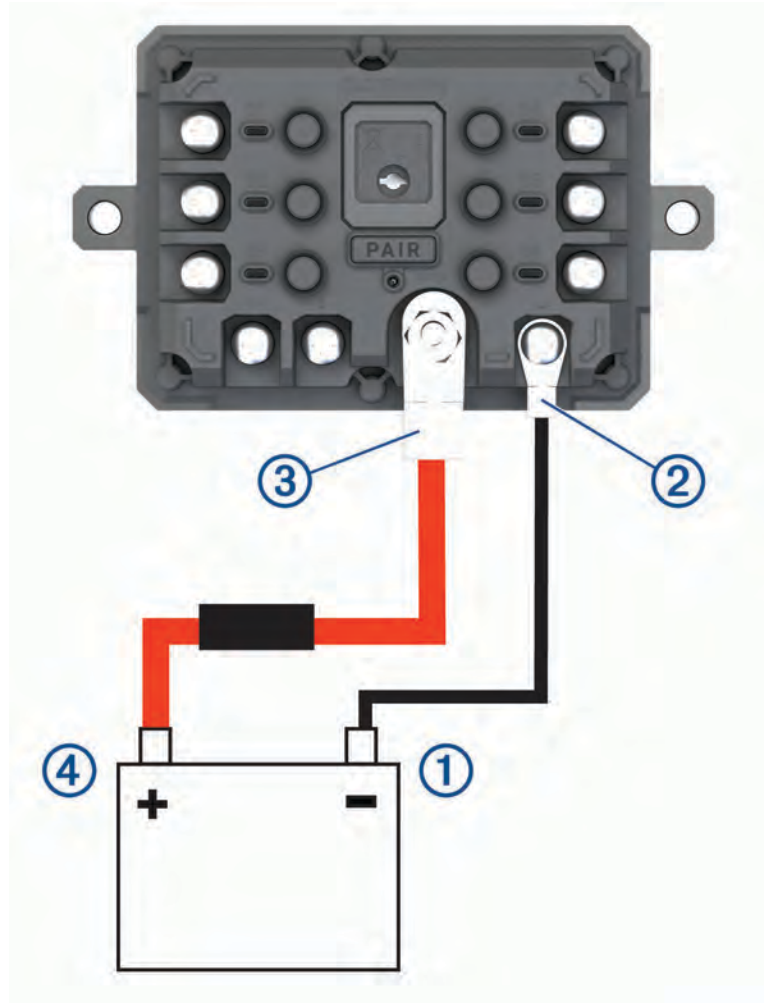

- 2 Connect the small ring end of the ground wire to the **GND** terminal ② on the device.
- 3 Connect the small ring end of the included 12V cable to the **+12V** terminal ③ on the device.
- 4 Tighten the $\frac{3}{8}$ in. nut on the +12V terminal to a maximum torque specification of 4.52 N-m (40 lbf-in.). You should confirm the nut cannot be loosened by hand.

NOTICE

Do not overtighten the +12V terminal to prevent damage to the terminal.

- 5 Connect the large ring end of the 12V cable ④ to the positive terminal on the vehicle battery.

Pairing with a Garmin Navigation Device

You can pair your Garmin PowerSwitch device with a compatible Garmin navigation device.

- 1 Turn on power to your Garmin PowerSwitch device, and place your compatible Garmin navigation device within 1 m (3.3 ft.) of it.
- 2 On your compatible navigation device, open the Garmin PowerSwitch app.
- 3 Follow the on-screen instructions to complete the pairing and setup process.

The main app dashboard appears. After the devices are paired, they connect automatically when they are turned on and within range.

Garmin PowerSwitch Specifications

Dimensions (D x W x H)	75 x 125 x 32 mm (2.95 x 4.92 x 1.26 in.)
Operating temperature range	From -25° to 85°C (from -13° to 185°F)
Wireless frequency	2.4 GHz @ 10 dBm
Power input	From 12 to 16 V using the included vehicle power cable.
Maximum accessory output	30 A
Maximum system output	100 A
Current draw with all outputs off	3 mA
Water rating	IEC 60529 IPX7 ¹

Troubleshooting

My Garmin PowerSwitch will not stay connected

- Verify the Garmin PowerSwitch device is receiving power.
- Verify that Bluetooth technology is enabled on your paired navigation device or smartphone.
- Move the navigation device or smartphone closer to your Garmin PowerSwitch device.
- Verify that your vehicle's battery is supplying at least 12 V of power.

The Garmin PowerSwitch device turns off all outputs automatically to preserve your vehicle's battery if it is receiving less than 11 V of power (*My accessories are not receiving power, page 64*).

My accessories are not receiving power

- Verify the Garmin PowerSwitch device is receiving power from the vehicle battery.
- Verify that your vehicle's battery is supplying at least 12 V of power.
The Garmin PowerSwitch device turns off all outputs automatically to preserve your vehicle's battery if it is receiving less than 11 V of power. Outputs turn back on when the device detects more than 12 V of power.
- Verify that all electrical connections are secure and will not come loose while operating the vehicle.
- Verify that each connected accessory draws less than 30 A.
If an accessory draws more than 30 A, the device turns off that output automatically.
- Verify that the total system load is less than 100 A.
If the device detects a system load of more than 100 A, it turns off all outputs automatically.
- Inspect all electrical connections for an electrical short circuit.

¹ The device withstands incidental exposure to water of up to 1 m for up to 30 min. For more information, go to www.garmin.com/waterrating.

Data Management

The device has a memory card slot for additional data storage.

NOTE: The device is compatible with Windows® 7 and newer, and Mac® OS 10.7 and newer. Apple computers may require additional third-party software to read and write files.

About Memory Cards

You can purchase memory cards from an electronics supplier, or purchase pre-loaded Garmin mapping software (www.garmin.com). Memory cards can be used to store files such as maps and POIs.

Installing a Memory Card for Maps and Data

You can install a memory card to increase the storage space for maps and other data on your device. You can purchase memory cards from an electronics supplier. The device supports microSD memory cards from 4 to 256 GB. Memory cards must use the FAT32 file system format. Memory cards greater than 32 GB must be formatted using the device ([Formatting the Memory Card, page 65](#)).



- 1 Locate the map and data memory card slot on your device ([Device Overview, page 1](#)).
- 2 Insert a memory card into the slot.
- 3 Press it in until it clicks.

Formatting the Memory Card

The device requires a memory card formatted using the FAT32 file system. You can use the device to format your card using this file system.

You must format a brand new memory card if it is not formatted using the FAT32 file system.

NOTE: Formatting the memory card deletes all data on the card.

- 1 Select  > **Device** > **Storage & USB**.
- 2 Select your memory card.
- 3 Select  > **Storage settings** > **Format** > **FORMAT SD CARD**.
- 4 Select **Done**.

Connecting the Device to Your Computer

You can connect the device to your computer using a USB cable.

- 1 Plug the small end of the USB cable into the port on the device.
- 2 Plug the larger end of the USB cable into a port on your computer.
- 3 When your Tread - Overland Edition device prompts you to enter file transfer mode, select **Yes**.

Depending on your computer operating system, the device appears as either a portable device, a removable drive, or a removable volume.

Transferring GPX Files From Your Computer

Apple computers may require additional third-party software, such as Android File Transfer, to read and write files on this device.

If you have already created routes that you want to use on your device, you can transfer GPX files directly from your computer.

- 1 Connect the device to your computer ([Connecting the Device to Your Computer, page 65](#)).
The device appears as a portable device.
- 2 On your computer, open the file browser.
- 3 Select a GPX file.
- 4 Select **Edit** > **Copy**.
- 5 Browse to the GPX folder on the device.
- 6 Select **Edit** > **Paste**.

Transferring Data From Your Computer

- 1 Connect the device to your computer ([Connecting the Device to Your Computer, page 65](#)).
Depending on your computer operating system, the device appears as either a portable device, a removable drive, or a removable volume.
- 2 On your computer, open the file browser.
- 3 Select a file.
- 4 Select **Edit > Copy**.
- 5 Browse to a folder on the device.
NOTE: For a removable drive or volume, you should not place files in the Garmin folder.
- 6 Select **Edit > Paste**.

Disconnecting the USB Cable

If your device is connected to your computer as a removable drive or volume, you must safely disconnect your device from your computer to avoid data loss. If your device is connected to your Windows computer as a portable device, it is not necessary to safely disconnect the device.

- 1 Complete an action:
 - For Windows computers, select the **Safely Remove Hardware** icon in the system tray, and select your device.
 - For Apple computers, select the device, and select **File > Eject**.
- 2 Disconnect the cable from your computer.

Adding BaseCamp™ Data to Garmin Explore

You can export your BaseCamp data files and import them to Garmin Explore for use with your Tread - Overland Edition device.

- 1 Export your data from BaseCamp:
 - If you are using an Apple computer, see [Exporting Data from BaseCamp with an Apple Computer, page 66](#).
 - If you are using a PC, see [Exporting Data from BaseCamp with a PC, page 66](#).
- 2 Import your BaseCamp data to the Garmin Explore website ([Importing Data to Garmin Explore, page 67](#)).
- 3 Synchronize your Garmin Explore data with your Tread - Overland Edition device ([Synchronizing Garmin Explore Account Data, page 44](#)).

Exporting Data from BaseCamp with a PC

- 1 Select an option:
 - To export all BaseCamp data stored on your computer, select **My Collection**, and select **File > Export > Export 'My Collection'**.
 - To export one or more items or a list, select one or more items or a list, and select **File > Export > Export Selection**.
- 2 Enter a name, select a location for the exported file, select the file format, and select **Save**.

Exporting Data from BaseCamp with an Apple Computer

- 1 Select an option:
 - To export all BaseCamp data stored on your computer, select **My Collection**, and select **File > Export 'My Collection'**.
 - To export one or more items or a list, select one or more items or a list, and select **File > Export Selected User Data**.
- 2 Enter a name.
- 3 Select a location for the exported file.
- 4 Select the file format.
- 5 Select **Export**.

Importing Data to Garmin Explore

- 1 Go to explore.garmin.com and log in to your account.
- 2 Select the **Map** tab.
- 3 Select .
- 4 Follow the on-screen instructions.

Purchasing Additional Maps

- 1 Go to your device product page at garmin.com.
- 2 Click the **Maps** tab.
- 3 Follow the on-screen instructions.

Index

Symbols

2-D map view **21**
3-D map view **21**

A

accessories **58**
active lane guidance **37**
addresses, finding **46**
alarm volume **52**
alerts **8, 9, 50**
 audio **52**
 proximity points **52**
altimeter **9**
app overview **28**
audio, proximity points **52**
avoidances
 area **39**
 deleting **39**
 disabling **39**
 road **39**
 road features **39**
 tolls **38, 39**

B

barometer **9**
battery
 charging **2, 53**
 maximizing **58**
 problems **58**
Bluetooth technology **31, 32, 34, 35, 58**
 disconnecting a device **35**
 enabling **51**
 pairing a phone **32**
brightness **5**

C

calibrating, compass **9**
calls **34**
camper, profiles **6**
changing the search area **43**
charging the device **2, 53**
cleaning the device **57**
cleaning the touchscreen **57**
compass **9**
computer, connecting **58, 65**
contact **16**
control input **29**
coordinates **47**
current location **47**

D

data **17, 66**
deleting, paired Bluetooth device **35**
destinations, arriving **40, 41**
detours **40**
device care **57**
directions **37**
disconnecting, Bluetooth device **35**
display settings **52**
dog, tracking **21, 22**
driver alerts **50**
driving directions **37**

E

editing, saved trips **25**
elevation profile **20**
emergency services **47**
EULAs **53**
exit services **19**

F

files
 exporting **66, 67**
 transferring **65, 66**

finding locations. **42–46** See *also* locations
 addresses **46**
 categories **43**
 cities **19**
 coordinates **47**
 intersections **46**
finding services **45**
fuel
 prices **47**
 stations **47**

G

Garmin Connect **31**
Garmin Explore **44**
Garmin Express, updating software **55, 56**
going home **40**
GPS **4**
 simulator **53**
group ride **9–11**

H

hands-free phone calls **32, 34**
headset **35**
 pairing **32**
history **17**
home
 editing location **40**
 going **40**

I

icons **22**
 status bar **4**
ID number **53**
inReach **13–15, 17**
intersections, finding **46**

L

language **52**
latitude and longitude **47**
location **46**
location services **53**
locations **46**
 current **47, 48**
 recently found **47**
 saving **48**
 searching for **42, 46**
 simulated **53**

M

map layers **8**
 customizing **20**
map view
 2-D **21**
 3-D **21**
maps **17, 19, 21, 23, 36, 48, 51**
 BirdsEye imagery **24**
 data field **7, 19, 21, 36**
 detail level **51**
 layers **20**
 purchasing **67**
 symbols **7, 36**
 theme **51**
 tools **18**
 updating **54–56**
 viewing routes **7, 22, 36, 37**
MapShare **15**
media player **23**
media volume **52**
memory card **1, 65**
 formatting **65**
 installing **65**
message **13, 14**
messages **13**
microSD card **1, 65**
mounting the device **59–63**
 automobile **2**
 removing from mount **57**

suction cup **2**
music, playing **23**

N

national parks **44**
navigation **7, 36, 40, 44**
 settings **51**
next turn **36**
notification volume **52**
notifications **32–35**

O

on-screen buttons **4**
owner's manual **22**

P

pairing **21, 32, 64**
 disconnecting **35**
 headset **32**
 phone **32, 58**
parking **41, 43, 46**
phone
 disconnecting **35**
 pairing **32, 58**
phone calls **34**
 answering **34**
 dialing **34**
 muting **34**
pitch and roll **8, 9**
 calibrating **9**
playing, music **23**
points of interest (POI) **44–46, 66**
power cables **53**
 vehicle **2, 61–63**
power key **1, 3**
power switch **28**
 customizing **29–31**
product support **22**
profiles **5**
 camper **6**

R

radio communication **11–13**
recently found locations **47**
resetting
 device **57**
 trip data **19**
road conditions, weather **26**
routes **6, 8, 27, 44**
 adding a point **38**
 adventurous routing **21, 40**
 calculating **40**
 calculation mode **25, 40**
 creating **24, 25**
 editing **24, 25**
 shaping **38**
 starting **35, 36, 43**
 stopping **8**
 viewing on the map **7, 36, 37**

S

satellite signals, acquiring **4, 53**
saved locations **25**
 categories **49**
 deleting **49**
 editing **49**
 saving, current location **48**
screen, brightness **5**
search bar **42**
settings **51–53**
shaping a route **38**
shortcuts
 adding **48**
 deleting **48**
simulated locations **53**
sleep mode **3**

- smartphone features **32, 34**
 - connecting **32**
- software
 - updating **54–56**
 - version **53, 57**
- SOS **13, 15**
 - canceling **16**
 - sending **16**
- sound **52**
- specifications **53, 64**

T

- theft, avoiding **57**
- time settings **52**
- tolls, avoiding **38**
- tools, maps **18**
- touchscreen **4**
- TracBack **25**
- tracking **13, 14**
- tracks **8, 14, 15**
- traffic **20, 41, 52**
 - alternate route **38**
 - incidents **20, 41**
 - map **20, 41**
 - searching for delays **20, 41**
- transportation modes **5**
- travel history **53**
- trip information **19**
 - resetting **19**
- Tripadvisor **45, 46**
- troubleshooting **57, 58, 64**
- turn list **37**

U

- unit ID **53**
- up ahead **18, 19**
 - customizing **19**
- updating
 - maps **54, 56**
 - software **54, 56**
- USB, disconnecting **66**

V

- vehicle power cable **2, 63**
- vehicle profile **5**
 - camper **6**
- volume **52**
- VOX **13**

W

- warning angle **9**
- waypoints **44**
- weather **26**
 - radar **26**
 - road conditions **26**
- Where Am I? **47, 48**
- Wi-Fi, connecting **51**
- Wi-Fi **54**

